

LOANED TO
UNIVERSITY OF CALIFORNIA
DEPARTMENT OF MECHANICAL AND ELECTRICAL ENGINEERING

FROM PRIVATE LIBRARY OF

C. L. CORY

1930

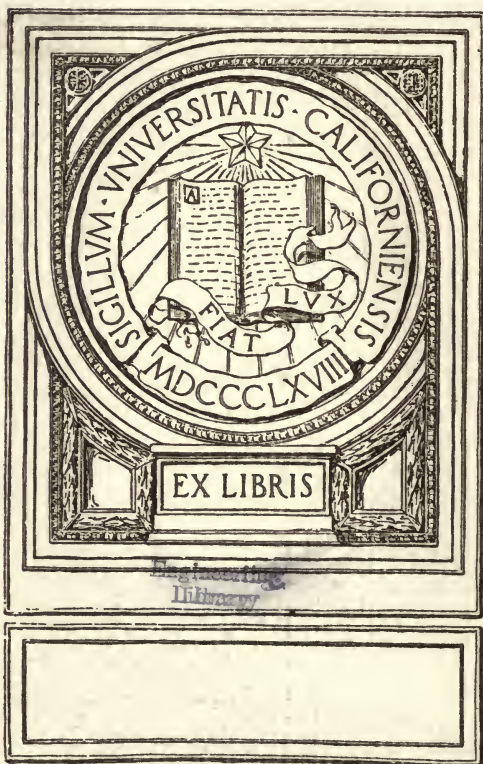

Prof. C. L. Cory.

- Compliments of the Authors

ELECTRIC MOTORS

THEIR ACTION, CONTROL AND APPLICATION

BY

FRANCIS B. CROCKER, E.M., PH.D.

PROFESSOR OF ELECTRICAL ENGINEERING, COLUMBIA UNIVERSITY,
PAST PRES. A. I. E. E., MEM. BRITISH INST. OF E. E.

AND

MORTON ARENDT, E.E.

ASSISTANT PROFESSOR OF ELECTRICAL ENGINEERING, COLUMBIA
UNIVERSITY, MEM. A. I. E. E.



NEW YORK

D. VAN NOSTRAND COMPANY

23 MURRAY AND 27 WARREN STREETS

1910

112071
C8
Engineering
Library

Engineering
Library

COPYRIGHT, 1910, BY
D. VAN NOSTRAND COMPANY

Stanhope Press
F. H. GILSON COMPANY
BOSTON, U.S.A.

PREFACE.

THE design and construction of electrical apparatus are covered fairly well by existing literature, the books on such subjects being very numerous, and many of them are comprehensive and authoritative. On the other hand, the *operation* of electrical machinery has received comparatively little attention. This latter fact appears to be anomalous when we consider that there are undoubtedly several hundred users for every designer or constructor of such apparatus, because each builder supplies a large number of customers. Hence the authors have endeavored to supply information that may be useful to those who operate or are interested in the operation of electric motors. Included among these are electrical engineers who install or run electric power plants, managers of manufacturing or other establishments in which electric devices are employed, as well as students and others who desire to acquaint themselves with the working of various kinds of electric motors and their application to useful purposes.

The subject is necessarily technical because it involves not only the mechanical factors speed and torque but also the electrical quantities voltage, current and flux. Moreover, any or all of these five quantities may, in fact usually do, vary and are affected by other quantities or conditions. Hence the problems must be analyzed and solved with thoroughness to obtain results of real value and cannot be properly treated in a popular manner. Nevertheless care has been taken to introduce and explain each step or result as clearly as possible, and to illustrate each case, when feasible, by a specific numerical example based upon standard commercial motors.

The general method herein adopted is an outgrowth of the course of lectures on electric motors and their applications given in Columbia University. It is based upon the consideration of counter e.m.f. and its relation to impressed e.m.f. as the important criterion of motor action. This point of view is, of course, not original, but it is claimed that the conception is more explicitly and

widely applied than heretofore. Furthermore, this idea brings together the motor and generator so that they may be regarded as identical except for slight differences easily seen, and our knowledge concerning one is applicable to the other. The plan of treatment also links voltage with speed, and current with torque, since in general they are respectively proportional. Thus we consider one pair of quantities at a time instead of four. The synchronous a.c. motor differs so radically from the d.c. type that the treatment must be modified, but even in this case a similar standpoint is adopted as closely as possible.

Throughout the book references are given to United States and foreign patents as well as articles and books in which may be found further descriptions of the various machines and methods considered. Those portions of the A. I. E. E. Standardization Rules relating to electric motors have been extracted verbatim and put together as Appendix A.

The authors gratefully acknowledge their indebtedness to Messrs. J. H. Morecroft, A. G. Popcke, L. W. Rosenthal, A. H. Timmerman, E. H. Waring and G. B. Werner for valuable information and to F. L. Mason for assistance in proof reading. They also take this opportunity to thank the Crocker-Wheeler, Electro-Dynamic, General Electric, Wagner and Westinghouse Companies for illustrations and data of apparatus manufactured by them and discussed in this book.

January 5, 1910.

TABLE OF CONTENTS

	PAGE
CHAPTER I	
INTRODUCTION.....	I
CHAPTER II	
TYPES OF MOTORS AND ADVANTAGES OF ELECTRIC DRIVE.....	4
CHAPTER III	
ACTION OF SHUNT MOTORS.....	10
CHAPTER IV	
SHUNT-MOTOR STARTING BOXES.....	33
CHAPTER V	
SHUNT-MOTOR SPEED CONTROL BY VARIATION OF ARMATURE VOLTAGE.....	38
CHAPTER VI	
SPEED CONTROL OF SHUNT MOTORS BY VARIATION OF FIELD CURRENT.....	46
CHAPTER VII	
SPEED CONTROL OF MOTORS BY VARIATION OF FIELD RELUCTANCE.....	67
CHAPTER VIII	
MULTIPLE-VOLTAGE SYSTEMS OF MOTOR SPEED CONTROL.....	74
CHAPTER IX	
DIRECT-CURRENT SERIES MOTORS.....	94
CHAPTER X	
CONTROL OF DIRECT-CURRENT SERIES MOTORS.....	109
CHAPTER XI	
COMPOUND-WOUND MOTORS.....	118

TABLE OF CONTENTS

CHAPTER XII	
ALTERNATING-CURRENT MOTORS — INTRODUCTION	PAGE 123
CHAPTER XIII	
SYNCHRONOUS ALTERNATING-CURRENT MOTORS	131
CHAPTER XIV	
POLYPHASE INDUCTION MOTORS	165
CHAPTER XV	
STARTING OF POLYPHASE INDUCTION MOTORS	194
CHAPTER XVI	
SPEED CONTROL OF POLYPHASE INDUCTION MOTORS	204
CHAPTER XVII	
SINGLE-PHASE INDUCTION MOTORS	213
CHAPTER XVIII	
COMMUTATING ALTERNATING-CURRENT MOTORS	238
CHAPTER XIX	
SERVICE CONDITIONS AND APPLICATIONS OF ELECTRIC MOTORS	265
APPENDIX A	
STANDARDIZATION RULES, ELECTRIC MOTORS	273
INDEX	287

Electric Motors, their Action and Control.

CHAPTER I.

INTRODUCTION.

An electric motor is a machine which converts electrical power into mechanical power. In function, therefore, it is the exact converse of the dynamo-electric generator. On the other hand, identically the same machine may be and often is employed to perform either function, which fact is known as the *reversibility of the dynamo-electric machine*. In the earlier periods of their development, however, the two machines were usually regarded as quite different in character and were constructed on wholly different lines.

Strange to say, the motor historically precedes either the magneto- or dynamo-electric generator. Barlow's wheel of 1823, the first electric motor, was similar in construction to Faraday's disc of 1831, which was the original magneto-electric generator. The Jacobi electric motor of 1838 was large enough to propel a boat carrying fourteen passengers at three miles per hour, and Page in 1851 constructed a car driven by a 16-horsepower electric motor at nineteen miles per hour. These as well as other electric motors of those times were far more powerful and were regarded as more practical or more promising than the contemporaneous magneto-electric generators. The Pacinotti ring of 1861, the prototype of modern armatures, was primarily intended to be used in a motor, although the inventor suggested that it could also be employed to generate electric currents.

All of these early electric motors depended upon primary batteries for their supply of electrical energy, and it was found that the

cost of operation was excessive for any considerable power, especially with the low-efficiency motors and crude forms of battery then available. The result was that the motor had to wait while the generator was being developed to commercial success, which cannot be said to have really begun before 1880. Even then the electrical energy produced was used entirely for arc and incandescent lighting. In fact, it was not until about 1887 that central stations with their systems of distribution had become sufficiently large and well regulated so that the use of electric motors was encouraged or even permitted except in a few isolated cases.

The electric light having been practically introduced and more or less generally established, inventors, manufacturers, also those who produced electrical energy, turned some attention to electric power, which, from about 1888, has been a prominent part of electrical engineering, including railway as well as stationary motors. The former type, also the induction and synchronous alternating-current motors, began to be commercially introduced about that time or soon after. Since this comparatively recent epoch the progress of electric power in all its branches has been at an extraordinarily rapid rate and with most far-reaching results, unequaled by any other art or industry in anything like the same period of time.

Relation between Generator and Motor. — Either a dynamo-electric generator or a motor may be regarded as made up of a certain number of centimeters of wire located in a magnetic field of given density in lines per square centimeter. The former machine will generate e.m.f. when the wire *moves*; the latter machine exerts torque if *current* flows in the wire, that being the essential distinction between the two. We may have, for example, a generator (separately excited) producing full e.m.f. with no current in its armature and we may have a motor exerting full torque with its armature prevented from turning, but we cannot have a generator without motion or a motor without armature current. In practical operation, however, the generator has current flowing in the wire so that torque, *opposed* to driving force, is also exerted; and in the motor e.m.f., *counter* to energizing current, is set up by the motion of the wire. Hence *either machine while working develops both e.m.f. and torque*, the only difference between them under these conditions being the fact that this e.m.f. is positive with respect to current in the generator and negative in the motor, while torque is negative with

respect to motion in the generator and positive in the motor. It follows therefore that electrical power is positive in the generator and mechanical power is negative, whereas electrical power is negative in the motor and mechanical power positive. In fact the exact function of these machines is expressed in the above statement, which means that they convert mechanical power into electrical power and *vice versa*. These distinctions in function or action do not, however, involve any necessary difference in the construction of generators and motors. As already stated, identically the same machine is equally operative for either purpose because the dynamo-electric machine is *perfectly reversible*. In practice, motors and generators are made somewhat differently, but merely with respect to details of form or connections, so that they will be more convenient for the special uses to which they are applied. As a matter of fact motors differ among themselves, railway and stationary types, for example, fully as much as they differ from generators.

While these differences in *construction* are for the most part mere matters of adaptability, the *operation* of generators is radically unlike the operation of motors. The former are almost universally driven at *constant speed* by steam engines, gas engines, turbines or other sources of mechanical power. Of course in practice the speed varies somewhat, but this is very undesirable and avoided as much as possible by the most careful design as well as adjustment of governors. The few cases in which the speed variation is large, as, for example, the driving of a generator from the axle of a railway car, involve serious mechanical as well as electrical difficulties, special and often complicated auxiliary apparatus being employed.

On the other hand, the speed of electric motors is very commonly variable or adjustable, the range in many cases being from zero to a maximum in either direction, as in railway or elevator service, and ratios of three or four to one or higher are common in factories, machine shops, etc. The means and methods used to accomplish such speed variation constitute an important branch of engineering, and it is the particular purpose of this book to discuss this subject of motor control. In those applications for which constant speed is desired, the motors may depart somewhat from this condition owing to their own action, which matter will also be given special attention, because it is often of practical importance to reduce or allow for these undesired changes of speed.

CHAPTER II.

TYPES OF DIRECT-CURRENT MOTORS AND ADVANTAGES OF ELECTRIC DRIVE.

MANY kinds of electric motors are in use, each having its characteristics of design and operation. In general electric motors are divided into those of the direct-current and alternating-current groups, which in turn may be subdivided into particular types. Alternating-current motors will be discussed later. For the present attention is confined to direct-current motors, the types of which are as follows:

DIRECT-CURRENT MOTORS.

<i>Type</i>	<i>Operative Characteristics.</i>
Shunt-wound motors.....	Starting torque obtainable in actual practice is 50 to 100 per cent greater than rated running torque, and fairly constant speed over wide load ranges.
Series-wound motors.....	Most powerful starting torque of any electric motor, speed varying greatly (inversely) with load changes.
Compound-wound motors...	Compromise between shunt and series types.
Differentially wound motors.	Starting torque limited, for which reason these motors are rarely if ever used practically. They are nevertheless interesting scientifically because their speed can be made almost absolutely constant for load changes within rated capacity.

No attempt is made herein to describe the design or construction of electric motors except special features relating to speed control. The general subject of motor structure, mechanical and electrical, is treated in a number of standard works as listed at the end of this chapter, and a reasonable knowledge of such matters is assumed. For example, the various parts of motors, their names, forms and relation, are supposed to be understood.

The sole function of electric motors is to drive some other machine or device, but, as the number of such applications is practically infinite, their field of utility becomes almost universal. Some of the prominent uses include the driving of cars, pumps, fans, machine

tools, looms, printing presses, hoisting apparatus, grinding and polishing machines, etc., etc. Before taking up the discussion of motor action and control it will be well to consider the advantages thereby secured.

ADVANTAGES OF ELECTRIC DRIVE.

1. *Saving in Power.* — This is generally the first point to be considered, but it is by no means the most important, as the cost of power in manufacturing is rarely more than 1 to 3 per cent of the cost of the finished product, the expenditure for labor alone being usually many times greater. It is a fact, however, that, due to the absence of belting and shafting losses, which are usually 40 to 60 per cent of the total power required to drive the various machines, the saving is considerable. Furthermore, the complete cutting off of electric current whenever an individually operated machine is stopped, compared to the large practically constant loss with belting and shafting, is much in favor of the former method. In factories and similar industrial establishments the *load factor* or average power is only 20 to 60 per cent of the maximum or total amount required when all machines are working at full load. The losses with electric drive correspond to the usual or average conditions, while belting and shafting losses vary somewhat with load, but nearly correspond to possible or total capacity of the plant. This advantage is more or less offset by the losses involved in the double conversion of energy from mechanical to electrical and back to mechanical form, but in most cases and in the long run the former method does effect a real saving in power consumption. This is practically the case when the machines to be driven are scattered; on the other hand, if they are very compactly placed, with minimum distances between them, the saving in power by electric drive might be little or nothing, but some or all of the other advantages now to be stated would be secured.

2. *Larger Prime Movers.* — There is a practical limit to the power that can be transmitted by belting from a single unit. On the other hand an engine or turbine may be directly connected to an electric generator producing 10,000 horsepower or more, the whole of which can be readily transmitted and subdivided, also combined with the output of other generators. Thus the power of the individual prime mover can be increased to almost any extent provided it is

utilized electrically. Enormous pumps or air compressors are almost the only machines except electric generators that are adapted to be driven by engines of 5,000 horsepower or more. For thousands of other power applications, the size of prime movers, including steam and gas engines as well as steam and hydraulic turbines, is practically limited to units of moderate size if dependent upon mechanical transmission and distribution by belting or gearing. Of course these statements do not apply to steam vessels, in which many thousands horsepower are often applied to a single propeller, this being a case of direct connection. They do apply, however, to electric-railway service, for which one very large engine in a power house may replace many steam locomotives. The advantages of large units compared with small ones include saving in first cost, floor space, fuel and attendance.

3. *Cost of Buildings.* — Heavy overhead shafting is not required for the electric drive, hence the buildings may be made lighter and cheaper in construction, as they do not have to carry the large extra weight. Moreover it is not necessary, as with long lines of shafting, to take special precautions in order to avoid any settling which would throw them out of alignment and cause serious friction losses, vibration, etc.

4. *Cost of Equipment.* — The relative expense of equipping a factory with electric motors or with belting and shafting is not usually much if any greater for the former, even if we do not consider the lower cost of the lighter building construction.

5. *Arrangement of Machinery.* — The use of electric motors enables the various machines to be placed in almost any desired position. It is not necessary that they should be parallel or placed in rows, or at any particular angle or distance with respect to each other; whereas for belting and shafting the machinery must be arranged in a very particular manner, and very often it has to be located where the light is poor, or accessibility and other important features must be sacrificed. A great advantage due to the flexibility of the electrically driven machines is the use of portable equipments which are easily made up and operated, so that the tool is frequently brought to the work, as, for example, when a portable drill is brought to a heavy casting or to a large number of castings, or when a vertical slotter is applied to the outside of a large casting at the same time that the interior is being bored.

6. *Clear Head Room.* — The elimination of overhead belting and shafting by the use of motors gives a clear head room, which enables overhead cranes to be used freely; a fact which results in great saving of time and labor in the bringing of the work to the tools or removing finished pieces. The clear head room also gives better illumination and ventilation. In fact the saving in cost of proper illumination may be very considerable because general instead of local lighting may be obtained, whether natural or artificial. Comparing plate A, which shows the appearance of a silk-weaving shed operated by belting and shafting, and plate B, an illustration of the same mill in which the looms are operated electrically, the great advantages regarding head room and illumination are apparent.

7. *Cleanliness.* — The dripping of oil from overhead bearings and shafting is a constant source of annoyance, and the dirt thrown out from belting is an even worse enemy to cleanliness. The agitation of dust by belting and shafting keeps it in constant circulation, so that it penetrates everywhere and everything. This is an especially important matter in printing and textile work.

8. *Health of Employees.* — On account of the better ventilation and illumination, and reduction of dust and dirt, it is shown by actual experience that the general health of those who work with electrically driven machinery is improved. In the Government printing office at Washington, it was found that the sick list was decreased as much as 40 per cent after the electric drive was introduced.

9. *Convenience for Detached Buildings.* — The electrical method enables power to be supplied easily and economically to detached buildings or sections, which is not possible with belt or steam transmission; therefore, the buildings, like the machinery within them, can be located for general convenience, and not with special regard to supplying them with power. This subdivision of an industrial establishment into a series of detached buildings is an almost absolute safeguard against total destruction by fire; and is thus a practical guarantee of continuous earning capacity. If electric power were not employed, it would be necessary to have very extended belting and shafting connections, involving great losses and extra heavy wall construction, or a number of small power plants with

a larger force of men and considerably less economical in operation than one central power house.

10. *Freedom for Growth.* — For similar reasons, with electric drive it is a simple matter to extend a building, or add another in any direction, whereas shafting must be installed originally large enough to allow for extension; or else it must be replaced later; in which case the operation of the existing line shafts would be interfered with.

11. *Reliability.* — Shut-downs or delays are less frequent and less serious, because an accident in an electrically driven plant usually has a local effect only, simply interrupting the service of one or a few machines, while with belting and shafting the breaking or slipping off of a belt, or the failure of a friction clutch, may require the shutting-down of a whole plant or a large section thereof. Furthermore the time required for repair is usually less with electric power. In a large establishment a delay of even a few minutes represents a considerable item in wages, and in addition the interruption of the work is demoralizing. It might be argued that the central power plant may break down; this is, however, just as likely to happen with one form of power transmission as with another. In case of damage by fire or flood, the machinery can be moved, rearranged, reconnected and started again much more promptly with electric driving than with belting and shafting.

12. *Speed Control.* — The variation of speed that is possible with the electric drive, and the convenience as well as the wide ranges of control, are great advantages which in many cases are sufficient in themselves to dictate the adoption of electric motors. The operator can drive the machine to its limit of capacity, and can, on the other hand, instantly relieve it of strain. With mechanical drive the methods of speed control are more limited and require more time to operate than with electric motors. The shifting of the belt on a cone pulley, or the throwing in and out of different sets of gears, takes more effort than the simple turning of a controller handle, which can be placed in a much more convenient position than is usually possible with the mechanical device. The result is that the operator makes more frequent use of the former in order to gain even slightly in the efficiency or rapidity of his work. For example, the cutting speed in the case of the electric drive can be kept absolutely constant or at maximum value, whereas mechanical drive cannot

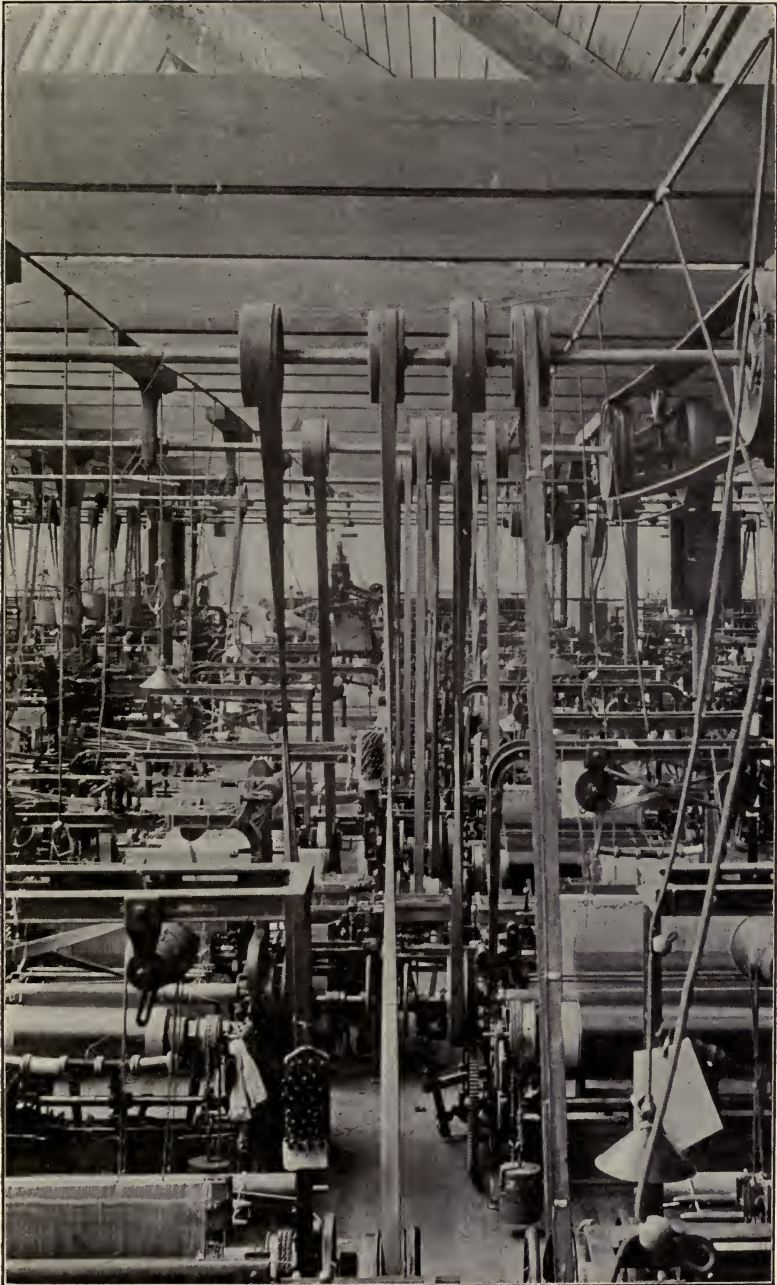

PLATE A. — SILK-WEAVING SHED WITH BELT DRIVE.

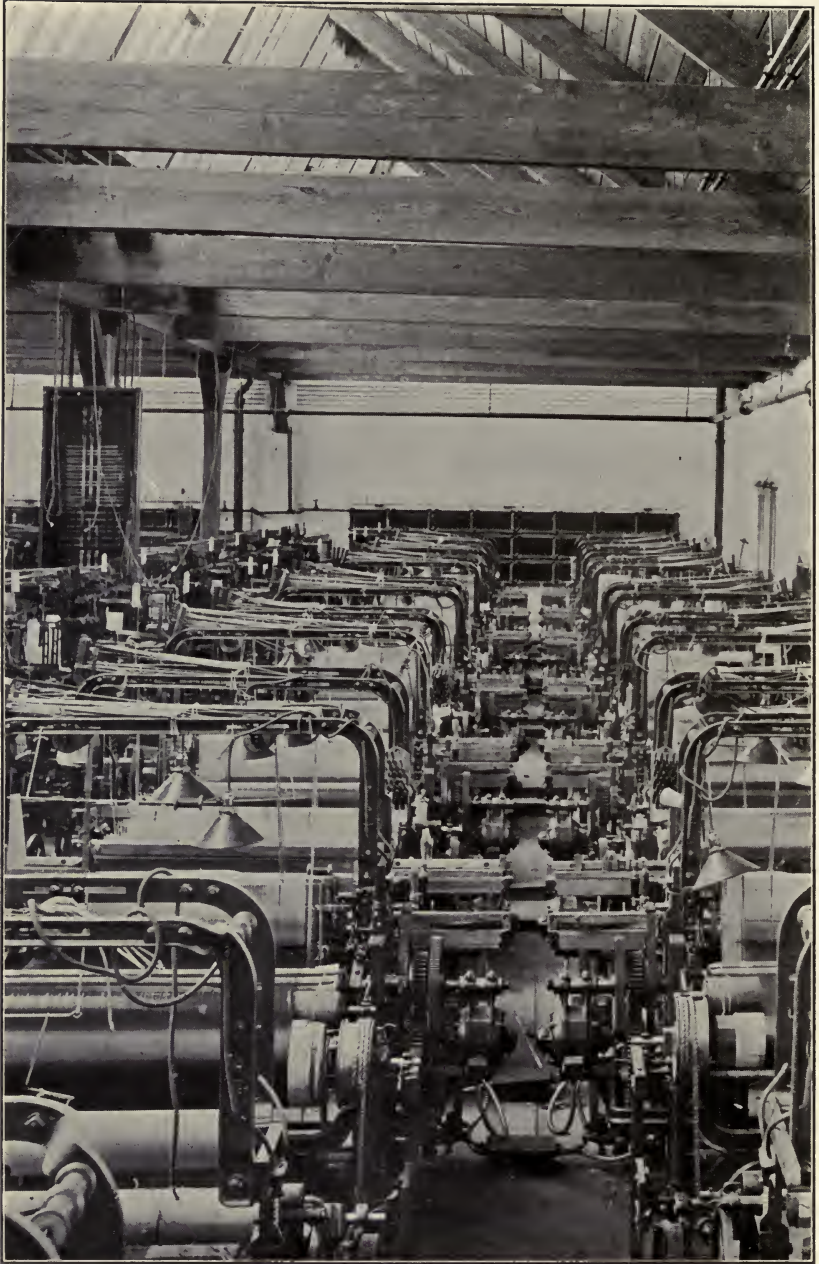

PLATE B. — SILK-WEAVING SHED WITH MOTOR DRIVE.

be adjusted as quickly or as closely, the steps of speed variation being much greater. The saving in time thus obtained is considerable and correspondingly reduces the shop cost of the article. It is the particular purpose of this book to discuss the matter of electric-motor speed control.

13. *Increased Output.* — Owing to its many advantages, but especially on account of clear head room for crane service and convenient speed control, it is found that the output of manufacturing establishments is in most cases materially increased or the running expenses decreased by the introduction of electric drive. An added output of 20 or 30 per cent is often obtained from the same plant, which in itself is sufficient to make the difference between profit and loss in carrying on a manufacturing business.

14. *Overtime work*, also work on holidays or during strikes, may be carried on conveniently and economically with a portion of the machinery or even with a single tool, because a small engine and generator may be run to supply the electric power. On the other hand, the main engine and the whole or a large part of the shafting and belting would have to be operated in order to supply the power by the ordinary mechanical transmission.

15. *Noise.* — Rumbling of line shafts and slapping of belts are entirely done away with when electric drive is adopted.

BIBLIOGRAPHY, ELECTRIC MACHINE DESIGN.

- DIE GLEICHSTROMMASCHINE, Vols. I. and II. E. Arnold. 1908.
 DIE WECHSELSTROMTECHNIK, Vols. I-V. E. ARNOLD. 1904-1908.
 DYNAMO-ELECTRIC MACHINERY, Vols. I and II. S. P. Thompson. 1904.
 ELECTRIC MACHINE DESIGN. Parshall and Hobart. 1906.
 ELECTRIC MOTORS. H. M. Hobart. 1904.
 ELECTRICAL MACHINE DESIGN, Vols. I and II. J. W. Esterline. 1906.
 ELEKTRISCHE GLEICHSTROMMASCHINEN. J. Fischer-Hinnen. 1904.
 THE DYNAMO. Hawkins and Wallis. 1903.
 THE INDUCTION MOTOR. H. B. De La Tour. 1903.
 THE INDUCTION MOTOR. B. A. Behrend. 1901.

CHAPTER III.

ACTION OF DIRECT-CURRENT SHUNT MOTORS.

LET us now study the action of shunt-wound motors under various conditions of load, temperature, speed, etc. It is well to consider first what occurs due to the conditions existing or changing within the machine itself, by its own action, after which the effect of external or purposely introduced factors will be explained. To make the results as significant as possible, standard shunt-wound machines have been selected as examples. Three typical sizes are considered and compared, *i.e.*, 1, 10 and 110 horsepower. The exact data concerning these machines and calculations based thereon are given in Table 1 of the present chapter. It is to be remembered that the average size of motors is less than that of generators, several of the former being usually fed by one of the latter. Hence these sizes represent small, medium and fairly large machines. It is also a fact that the 110-horsepower size is sufficiently large, so that still larger motors will correspond closely. For example, the efficiencies of the three sizes are about 81, 86 and 93 per cent, respectively, above which last figure the efficiency would increase only 1 or 2 per cent. Therefore the characteristic differences are found below 110 horsepower, and these machines may be taken to represent commercial practice with respect to shunt motors.

A few simple tests determine the fundamental facts from which the action of these machines under almost any reasonable conditions may be readily calculated. Most of the tests are well known, but they are included here as a desirable part of the definition of these fundamental quantities, to avoid any uncertainty in regard to them.

It is assumed that the *construction* of shunt motors is already understood by the reader, the present book being confined to *action and control* of this and other types. The literature of dynamo-electric generators and motors is extensive in regard to their theory, design and construction, there being many works in which these matters are fully covered but their operation has not been given the attention that it deserves.

1. The Voltage V , for which the motor is designed and at which it normally operates, is assumed to remain constant, being applied to the terminals of the armature and field circuits, which in the shunt type are in parallel (Fig. 1). If V is not constant it should be maintained so (for experimental investigation) by inserting a rheostat

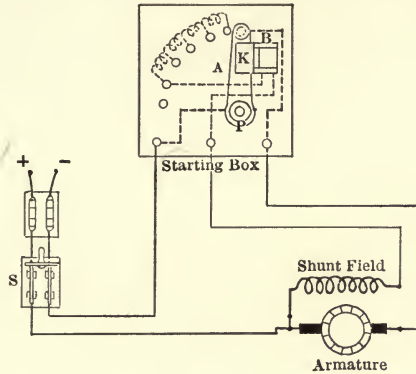

FIG. 1. — SHUNT-MOTOR CONNECTIONS.

which can be adjusted to correct any variations. This voltage should be that marked on the manufacturer's name plate and is generally known as the *rated* voltage. It may be found later that some other voltage is preferable in order to obtain a different speed or other result, in which case a new series of tests should be made at the modified voltage.

2. The Total Current I taken by the motor at rated load is also marked on the name plate. This may be found later to differ from the current at which the rated horsepower is developed, or it may cause heating in excess of the limit specified in (4). In either case another series of observations should be taken with the corrected current. For the present, however, it will be assumed that the rated voltage V and the rated current I are both correctly given on the maker's name plate. In the shunt-wound motor the total current I is the sum of the armature current I_a and shunt-field current I_{sh} .

3. The Room Temperature t is taken at 25 degrees C. in standardizing electrical apparatus.* If it differs from 25 degrees C. allowance should be made.

4. The Temperature Rise θ° permissible in the armature or field

* Standardization Rules, Amer. Inst. Elec. Eng., 1907.

is 50 degrees C. as measured by increase in resistance of these respective windings. This gives a working temperature of $t + \theta = 75$ degrees C. = T , at which the machine is said to be "hot" in contradistinction to "cold" at the room temperature t . To determine whether the temperature rise θ is within the limit of 50 degrees C., the motor is supplied with the rated voltage V and operated with sufficient load to draw the rated armature current I_a until a constant temperature T is reached, requiring from 6 to 18 hours, depending upon the size, speed and ventilation of the machine.* The resistance of the field and armature circuits is measured before, during and after the run, as explained in (5) and (6). This resistance at 25 degrees C. is $R_0 + (.0042 R_0 \times 25) = 1.105 R_0$, and at 75 degrees C. it is $R_0 + (.0042 R_0 \times 75) = 1.315 R_0$, in which R_0 is the value at 0 degree C.

Hence the resistance at working temperature or "hot resistance" is as 1.315 : 1.105 :: 1.19 : 1, or 19 per cent greater than the "cold resistance." If the increase in resistance is found to be more than 19 per cent, the standard safety limit has been passed, but if found to be less than 19 per cent, so much the better, not only for safety, but also for constancy of speed, as shown later (see page 26).

The capability of a motor to carry current and develop power depends upon temperature of the air and other variable conditions. Hence the rating of motors and other electrical apparatus is somewhat arbitrary, but it is based upon the long experience and consensus of opinion of those who make and use them. The A. I. E. E. Standardization Rules are followed herein and are given so far as they relate to motors in Appendix A.

5. *The Field Current I_{sh}* in the shunt motor is determined by connecting the field terminals directly to the supply circuit, the voltage of which is V . This should be measured when the machine is "hot," that is, after the run specified in (4) to obtain working conditions. The field current should also be determined with the machine "cold," before the run, because speed variations are caused by the temperature changes, as explained later (Chap. III, p. 26). Furthermore, with both values known, the increase in resistance and the temperature rise may be easily calculated. The shunt-field resistance "hot" $R_{sh} = V \div I_{sh}$ and the corresponding values cold are

* Standardization Rules, Amer. Inst. Elec. Eng., 1907.

$R'_{sh} = V \div I'_{sh}$, from which $R_{sh} \div R'_{sh} = I'_{sh} \div I_{sh}$. With temperatures of 75 degrees and 25 degrees C., respectively, it was shown in (4) that $R_{t+\theta} \div R'_t = 1.19$, hence $I'_{sh} = 1.19 I_{sh}$. In any case, however, the temperature rise in degrees C. is:

$$\theta = (238.1 + t_1) \left(\frac{R_2}{R_1} - 1 \right), \quad (1)$$

in which t_1 and R_1 are the initial temperature and resistance, while R_2 is the final resistance.

6. *The Armature Resistance* R_a , including resistance of brushes and brush leads, but not brush *contacts*, is also measured "hot." Potential difference or voltage "drop" due to the brush *contacts*, which depends upon the current density, should be measured at the rated current value and deducted from the total drop in the armature circuit, to get the true resistance of that circuit, or that quantity which, multiplied by the current, gives the IR drop. The nature and value of drop due to brush *contacts* is discussed later in the present chapter. The armature, before it has time to cool off after the run specified in (4), is supplied with its rated current I_a , but is not allowed to rotate, under which condition suitable resistance must be inserted in series to compensate for the absence of counter e.m.f. The total drop V' in volts across the armature terminals is then measured, also the drop D_b due to the brush *contacts*, and we have $R_a = (V' - D_b) \div I_a$. The armature circuit resistance "cold," if entirely of copper, is then $R'_a = R_a \div 1.19 = .84 R_a$, assuming "cold" and "hot" temperatures of 25 degrees and 75 degrees C., respectively. As a rule, however, the total resistance of the armature circuit includes that of the carbon brushes, which latter has a negative temperature coefficient, so that the resultant increase between 25 degrees and 75 degrees C. is about 15 per cent, or $R'_a = R_a \div 1.15 = .87 R_a$. This *variation* in armature resistance is not very important, however, as it will be shown later that it has little effect upon the efficiency, regulation, etc., of the machine. Not only does this statement apply to shunt motors, but it is true generally of the various types of electric motors and generators, as affected by *variations* in armature resistance due to any reasonable temperature changes. This statement should be understood exactly as made and should not be taken to mean that armature resistance is insignificant in its effect.

COUNTER E.M.F. OF SHUNT AND OTHER MOTORS.

Before proceeding with the various problems to be considered in connection with electric motors, it is desirable first to study their counter electromotive force, as it plays an exceedingly important part in the action of such machines.

The counter e.m.f. of a motor armature is the e.m.f. that it would develop as a generator when operated at the same speed with the same field flux. Hence the following well-known expression for the e.m.f. of a d. c. generator is equally applicable to both cases.

Let Φ = flux entering or leaving the armature per pole,

n = total number of inductors on the armature,

N = revolutions per minute,

p = number of pairs of poles,

b = number of circuits in parallel in the armature winding,

$$\text{then } e = \text{c.e.m.f. of motor armature} = \frac{\Phi n N 2 p}{60 \times 10^8 \times b} \quad (2)$$

By inspection of equation (2) it can readily be seen that with Φ , n , p and b maintained constant, the c.e.m.f. varies directly with N the number of r.p.m., and conversely we may state that the speed of a motor varies as the c.e.m.f., other factors being constant. This is a very important fact in studying the action and speed control of electric motors, especially shunt motors, because the above-mentioned quantities remain practically constant or do not change greatly in this type, unless purposely varied. In series or compound-wound motors the field flux usually varies considerably with the current and torque. In fact in a lightly loaded series motor it increases almost directly with the current. Even in the case of these machines their counter e.m.f. is used in Chapter XI as the criterion in determining their speed variation and control. This fundamental and general significance of the counter e.m.f. of electric motors is the basis of the method of treatment set forth in the present book. The counter e.m.f. of shunt and series motors or other direct-current types can be determined in several ways which will now be explained.

1. *Experimental Method of Determining the C.E.M.F.* — The armature shaft may be fitted with a heavy flywheel, so that the stored energy in the revolving parts is great. The motor is then

operated without load, but at rated speed (*i.e.*, that corresponding to rated load) by introducing resistance in its armature circuit in order to reduce slightly the voltage applied to it, while the field is excited with the proper line voltage V . When the rated speed is attained, the armature circuit is suddenly opened, and the fly-wheel effect will cause the armature to maintain almost constant speed for a short time, during which the c.e.m.f. can be measured by a voltmeter connected to the armature terminals, since it then becomes the e.m.f. of the machine acting as a generator.

2. *Determination of E.M.F. from Torque of a Motor or Generator.*

—The shunt field circuit is connected to the supply conductors to allow rated field current I_{sh} to pass through it. The armature is also connected to the supply, sufficient external resistance being inserted so that only the rated load current I_a flows through its winding. This develops a torque, but the armature is not allowed to rotate, a metallic or wooden bar being clamped to the pulley or shaft of the machine. By means of known weights or a spring balance we measure in pounds the pull plus the friction of bearings and brushes, also the pull minus friction, add these together and divide by two. The result multiplied by the length of brake arm in feet may be called the *true torque* (T_t) because it is the full amount developed by the interaction of the magnetic field and armature current. Of course the weight of the arm or lever should also be eliminated. The pull plus friction is easily found by forcing the armature to turn slightly *against* its tendency to rotate, the pull minus friction being measured by yielding slightly to the motor's torque.

Then at any speed N in r.p.m., the gross power developed would necessarily be $2 \pi T_t N$ foot-pounds per minute, which divided by 33,000 is the total mechanical horsepower evolved in the armature and corresponds to the indicated horsepower of a steam engine. This must equal the electrical horsepower supplied to the armature; hence

$$\frac{2 \pi T_t N}{33,000} = \frac{E I_a}{746}, \text{ or } E = \frac{2 \pi T_t N 746}{33,000 I_a} = \frac{T_t N}{7.03 I_a}, \quad (3)$$

where E is the motor c.e.m.f. or generated voltage at any speed N .

The true torque or turning effort of a motor depends upon the armature current, the number of armature inductors and the flux

through the armature. It is independent of the speed, being equal to $T_t = KI_a\Phi$, where K is a constant, depending upon the number of poles, effective conductors, etc. This gross or true torque includes not only the effective torque developed by a motor at its pulley when running, but also the torque required to overcome friction, windage and core losses. In the case of a generator, the total torque is that necessary to revolve the armature and overcome friction, etc. Hence effective motor torque + (friction + windage + core loss torque) = true torque = generator torque - (friction + windage + core loss torque). In the case of belt-driven machinery, the effective torque is equal to the difference in tension on the two sides of the belt multiplied by the radius of the pulley in feet plus one-third belt thickness.

It might be thought proper to multiply the electrical power in equation (3) by the efficiency of the motor in order to equate it with mechanical power. We should remember, however, that field current is not considered, core loss and windage are absent when the armature does not rotate and friction is eliminated by the described method of measuring the true torque. Hence we are dealing here with ideal conditions, the usual practical losses being eliminated.

3. *Calculation of C.E.M.F.*—The use of Equation (2) to calculate c.e.m.f. has already been explained. The quantities involved in that equation are determined by the designer of a motor or generator, but all of them are not usually known to, or readily ascertainable by, the user of the machine. Hence the following method is given because it employs data easily obtained by the simple tests already indicated under the head of "*The Armature Resistance*" on page 13. These tests can readily be made after the machine is in practical service.

In the armature circuit of any direct-current motor the applied voltage, V , overcomes three factors, namely, resistance drop, brush-contact drop and the c.e.m.f.; hence, $V = I_aR_a + D_b + \text{c.e.m.f.}$, or, rearranging, $\text{c.e.m.f.} = V - (I_aR_a + D_b)$. (4)

Brush-contact drop or fall of potential which occurs at the contacts of brushes and commutator being small has often been wholly ignored in tests and calculations concerning dynamo-electric machinery. Nevertheless, it is a measurable quantity producing an appreciable effect upon the speed of a d. c. motor as well as upon the external voltage of a d. c. generator. As its value does not

ordinarily exceed 1 volt for each contact, it is common practice simply to assume 2 volts for both brush contacts of a d. c. machine. This assumption is open to two criticisms: first, the fact that even the maximum brush drop may not be and usually is not quite as much as 2 volts, and second, in any case it varies somewhat with the current, so that it is certainly less than this amount at light loads.

If brush drop increased directly with current it could be included in the armature resistance, giving a total value which multiplied by the current would be the total armature drop. This would be most convenient for both tests and calculations, but unfortunately does not accord with the physical facts. Brush drop appears to be the combination of a fall of potential which is fairly constant and a true resistance drop IR directly proportional to the current. Probably the approximately constant fall of potential is in the nature of a c.e.m.f., the phenomenon being analogous to that of the arc. In fact, such a contact, especially in the case of a carbon brush, may properly be regarded as an incipient arc. This is true even under favorable conditions, and with a poor contact due to dirt, vibration, roughness of commutator, etc., the arc becomes actual and apparent.

The curve in Fig. 2 is based upon the results of actual tests made with a number of brushes similar to those employed in the three sizes of motor specified above. The voltage is the *total* value, including the potential difference or drop at *both* positive and negative *carbon* brushes: It increases with the current density, being practically a rectilinear function, as Fig. 2 shows, but is not directly proportional thereto, since the drop is 1 volt at 1 ampere per square centimeter and 2 volts at 6 amperes per square centimeter, these being the ordinary limits for small as well as large machines at rated load. The current densities for larger motors, also generators, are usually higher than for small machines, but are not adopted as desirable, being practically necessary because in large machines many amperes must be carried, with a reasonable number and size of brushes, upon a commutator of moderate dimensions. For ordinary calculations not requiring very accurate results, the loss of potential at brush contacts may be included with that due to armature resistance. This assumes that the former is a simple resistance effect like the latter, which, as already stated, is not the physical fact, but the percentage of error thus involved is usually small. Accord-

ing to this assumption the total lost voltage in the armature circuit is $I_a (R_a + R_c)$, in which I_a is armature current, R_a armature resistance and R_c is a resistance equivalent to brush contacts. Taking these quantities at their rated values for the typical 10-horsepower shunt motor in Table I on page 20, we have $37 (.28 + R_c) = 10.4 + 1.4$, from which $R_c = 1.4 \div 37 = .038$ ohm. If now this resistance be multiplied by the current in the armature when it runs

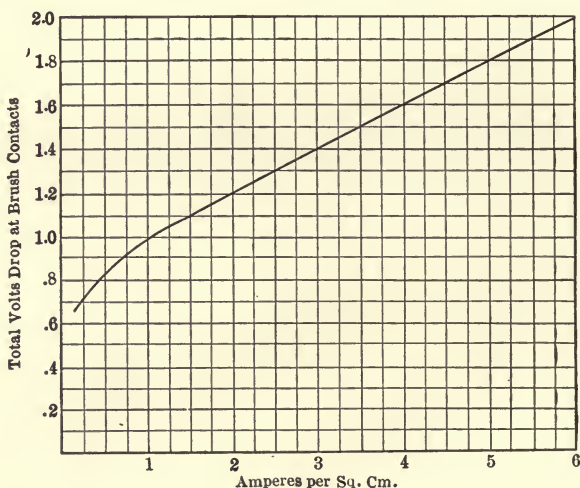

FIG. 2. — TOTAL VOLTAGE DROP AT BOTH CONTACTS FOR CARBON BRUSHES.

free, the brush drop thus calculated is only $2.3 \times .038 = .09$ volt. The actual brush drop found by test is .84 volt when the armature runs free, hence the calculated result is $.84 - .09 = .75$ volt less than the experimental. This difference, which would be about the same for other normal motors, is only $\frac{.75}{230}$, or $\frac{1}{3}$ of 1 per cent of the rated

terminal voltage, and would introduce a corresponding error in calculations of speed, etc. Ordinarily this error would be insignificant, especially as it disappears as rated speed is approached. On the other hand, the percentage of error is twice as great for 115-volt motors, and in the case of speed control by armature rheostat or multiple voltage it would be too large to be neglected except for rough calculations. For example, the true speed of a motor running at

one-eighth of rated speed would be about $\frac{8 \times .75}{230}$, or 2.6 per cent

less than that calculated by using the assumed brush-contact resistance of .038 ohm.

This error can be almost entirely eliminated, however, by assuming that the voltage lost at brush contacts is made up of a constant c.e.m.f. independent of current, combined with a true resistance drop; that is,

$$D_b = b + I_a R_b. \quad (5)$$

Referring to Fig. 2, it is seen that the experimentally determined drop at brush contacts is represented by a straight line for all current densities between 1 and 6 amperes per square centimeter. Below 1 ampere per square centimeter the line curves downward, but if the straight position were prolonged backward it would intersect the vertical axis at .8 volt. If the straight line thus completed be adopted as the basis of calculations, we have the simple numerical relationship that there is an initial loss of potential due to brush contacts of .8 volt at zero current and there is an increase of .2 volt for each ampere per square centimeter. For example, the drop at 3 amperes per square centimeter is $.8 + (3 \times .2) = 1.4$ volts and so on. This assumption introduces no error whatever for currents above 1 ampere per square centimeter, and below that value the error is insignificant because the current never falls to zero, being a minimum of .19 ampere per square centimeter at no load. At this limit the distance between straight and curved lines represents only .1 volt, which would be negligible in all practical cases.

Substituting the above explained values in (5) we have for the typical 10-horsepower motor,

$$1.4 = .8 + 37 R_b,$$

from which

$$R_b = (1.4 - .8) \div 37 = .016.$$

The general equation of the motor thus becomes

$$V = e + b + I_a (R_a + R_b). \quad (6)$$

This form expresses the same facts as equation (4) but has the great advantage that the empirical quantity D_b is eliminated, a rational quantity $I_a R_b$ being substituted. The value of R_b like that of b is constant for a given motor and does not vary much for motors of normal design, hence the drop in volts due to any value of ar-

mature current is completely represented by $b + I_a (R_a + R_b)$, in which I_a is the only variable.

Shunt-Motor Problems. — The following data of three standard sizes of shunt motors are given, so that the various features of these machines may be studied and the efficiency, effect of temperature, speed regulation, etc., may be calculated. These results are obtained by actual tests of the completed motors. The precise significance and in most cases the method of determining these data are stated in the preceding chapter, but in general the table speaks for itself and the figures given are found by simple measurements using voltmeter, ammeter and speed counter. It is also possible to assume or predetermine such data and use them as a basis for calculations similar to those which follow.

TABLE I.—TEST DATA OF TYPICAL SHUNT MOTORS.

	1-H.P. Machine.	10-H.P. Machine.	110-H.P. Machine.
Rated Voltage, V	230 volts	230 volts	230 volts
Rated Current, I	4 amps.	38 amps.	384 amps.
Arm. Current at Rated Load, I_a	3.85 amps.	37 amps.	380.7 amps.
Shunt Field Current, I_{sh} ..	.15 amp.	1 amp.	3.3 amps.
Arm. Resist. "Hot," R_a ...	3.1 ohms.	.28 ohm.	.0104 ohm.
Arm. Resist. "Cold," R'_a ..	2 ohms	.244 ohm	.009 ohm.
Field Resistance Hot, R_{sh}	1506 ohms.	230 ohms.	70.2 ohms.
No-load armature current, I'_a4 amp.	2.3 amps.	14.2 amps.
Speed at rated load.....	1250 r.p.m.	825 r.p.m.	585 r.p.m.
Speed at no load.....	1310 r.p.m.	865 r.p.m.	595 r.p.m.
Brush Contact Area, A_b ..	3 sq. cm.	12 sq. cm.	72 sq. cm.
Current Density of Brushes at rated load, S_b	1.28	3.08	5.3
Current Density of Brushes at no load, S'_b126	.19	.20
Drop due to brush contacts at rated load, D_b ..	1.05 volts	1.4 volts	1.86 volts
Drop due to brush contacts at no load, D'_b83 volt	.84 volt	.84 volt

In the above table the potential difference or voltage drop due to the brush contacts has been taken from the curve in Fig. 2.

Calculation of Speed of Shunt Motor Running Free (1-Horsepower Machine). — It was shown that the speed of a motor is directly proportional to the c.e.m.f. at any instant, other quantities such as field

current and flux being constant, hence the ratio between rated load speed and no-load speed (*i.e.*, free) is

$$\text{r.p.m.} : \text{r.p.m.} :: \text{c.e.m.f.} : \text{c.e.m.f.} \quad (7)$$

From equation (4) $\text{c.e.m.f.} = V - (I_a R_a + D_b)$, in which we substitute the values of V , $I_a R_a$ and D_b as given in the data sheet and obtain $\text{c.e.m.f.} = 230 - (3.85 \times 3.08 + 1.05) = 217.1$ volts at rated load, and $\text{c.e.m.f.} = V - (I'_a R'_a + D'_b) = 230 - [(.4 \times 2.7) + .83] = 228.10$ volts at no load. Substituting these values of c.e.m.f. and the rated motor speed in equation (7), we have $1250 : \text{r.p.m.} :: 217.1 : 228.1$. Therefore $\text{r.p.m.}_f = 1314$ r.p.m., which is within .3 per cent of the test value (Table I) given as 1310 r.p.m. for the speed at no load.

Speed Running Free (10-Horsepower Motor).—Rated load c.e.m.f. $= V - (I_a R_a + D_b) = 230 - (37 \times .28 + 1.4) = 218.2$ volts. No-load c.e.m.f. $= V - (I'_a R'_a + D'_b) = 230 - (2.3 \times .244 + .84) = 228.6$ volts. The rated speed is 825 r.p.m., and by substituting in equation (7) we have $825 : \text{r.p.m.}_f :: 218.2 : 228.6$; whence $\text{r.p.m.}_f = 863$, which is within .3 per cent of the test value of 865 r.p.m., for the no-load speed.

Speed Running Free (110-Horsepower Motor).—Rated load c.e.m.f. $= V - (I_a R_a + D_b) = 230 - (380.7 \times .0103 + 1.86) = 224.2$ volts. No-load c.e.m.f. $= V - (I'_a R'_a + D'_b) = 230 - (14.20 \times .09 + .84) = 229$ volts, and from equation (7), $585 : \text{r.p.m.}_f :: 224.2 : 229$ or $\text{r.p.m.}_f = 597$ r.p.m., being within .3 per cent of the test value of the no-load speed given in Table I as 595 r.p.m.

These calculations assume armature flux to be same at no load as at rated load, which is not usually the case because of armature reaction, as explained later in the present chapter. The close agreement between calculated and experimentally determined speeds is therefore partly accidental. The effect of armature reaction in reducing flux and increasing speed depends upon the position of the brushes but would usually be appreciable and in some cases actually causes the no-load speed to be *less* than that at rated load. Nevertheless a rise in speed *tends* to occur, due to diminished drop in armature resistance and brush contacts when the load torque and armature current are reduced. This *tendency* is correctly represented by the values calculated in the three examples above. In fact the speed will actually vary in accordance with the numerical

results obtained unless some other condition, for example that of armature reaction or of temperature, is also changed. It is better, however, to study and determine each influence separately and then combine them to ascertain their resultant effect. Such is the method of treatment adopted herein.

It is obvious that any change whatever of armature current, whether from rated load to no load or otherwise, has a tendency to cause speed variation, the amount of which may be calculated by a similar use of equations (4) and (7), substituting the proper values for speed, current, etc.

The above calculations of speed running free assume that armature is "cold" (25 degrees C.). If the load were suddenly thrown off a motor which had been operating with full rated armature current for several hours, the armature would not cool immediately and its resistance would remain at practically rated value. In the case of the 10-h.p. machine, for example, the c.e.m.f. would then be $230 - (2.3 \times .28 + .84) = 228.5$ instead of 228.6 volts, but the corresponding diminution of speed would be less than $\frac{1}{20}$ of 1 per cent, which is inappreciable. If, on the other hand, rated load be suddenly applied to a "cold" motor, the speed will not diminish as much as if the armature were "hot" (75 degrees C.). In this case the c.e.m.f. will be $230 - (37 \times .244 + 1.4) = 219.6$ instead of 218.2 volts. Hence the speed will be .6 per cent higher, or 830 instead of 825 r.p.m., but this difference is practically insignificant. The effect of temperature upon speed is discussed further on p. 26.

EFFICIENCY OF ELECTRIC MOTORS.

Determination of Efficiency of Motor at Rated Speed and Load. — The Standardization Rules of the American Institute of Electrical Engineers (paragraph 313) state: "All electrical apparatus should be provided with a name-plate giving the manufacturer's name, the voltage and the current in amperes for which it is designed. Where practicable, the kw-capacity, character of current, speed, frequency, type designation, and serial number should also be stated." From the data thus given the approximate or "name-plate efficiency" of a motor can be determined as follows:

From Name-plate of 1-Horsepower Motor.

Input at rated load = $230 \times 4 = 920$ watts. Output at rated load = 1 h.p. = 746 watts.

Hence efficiency being the ratio between input and output, the name-plate efficiency of the 1-h.p. motor = $746 \div 920 = 81$ per cent.

Calculation of Efficiency, Using Test Values (Table I). — In determining the efficiency of a motor we take the motor input at rated load and then calculate the stray-power and other losses, using the values found by actual test and given in Table I. The difference between input and the total losses gives the output, hence the ratio of input minus losses to input gives the motor efficiency.

The stray-power losses of the 1-h.p. motor running free (*i.e.*, at 1310 r.p.m.) are equal to the armature input at no load minus the armature no-load copper and brush losses; that is, the no-load stray power losses = $VI'_a - (I'^2_a R'_a + I'_a D'_b) = 230 \times .4 - (.4 \times 2.68 + .4 \times .83) = 91.2$ watts.

The remaining losses at rated load are:

Loss in Field Copper	$I_{sh}V = .15 \times 230 = 34.5$	Watts
Loss in Armature Copper	$I_a^2 R_a = 3.85^2 \times 3.08 = 45.64$	Watts
Loss in Brush Contacts	$I_a D_b = 3.85 \times 1.05 = 4.04$	Watts
	<hr/>	
		84.18 Watts.

If to this we add the no-load stray power of 91.2 watts, the total loss is $84.18 + 91.2$ or 175.4 watts. The motor output is equal to the input minus losses. The input by test (Table I) is 230 volts and 4 amperes, that is, 920 watts; hence the output is $920 - 175.4 = 744.6$ watts, and the efficiency by definition equals $\frac{744.6}{920}$ or 81.0 per

cent; so that in this case the efficiency by calculation is exactly equal to that by name-plate determination. Ordinarily (as shown by the 10 and 110 h.p. examples which follow) there is a slight difference because the former is based upon purely electrical data while the latter depends upon a brake or other test of actual mechanical power developed.

The assumption that the stray power at no load is the same as at rated load is not absolutely correct, since it will be lower at rated speed, which is from 2 to 5 per cent less than with the motor running free, but the error introduced by this assumption is practically negligible, as will be proven in the following case of the 10-h.p. motor.

Determination of Efficiency of 10-Horsepower Motor.

$$\begin{aligned} \text{Name-plate efficiency} &= \frac{\text{Output from name-plate}}{\text{Input from name-plate}} = \frac{10 \times 746}{230 \times 38} \\ &= \frac{7460}{8740} = 85.3 \text{ per cent.} \end{aligned}$$

The calculation of efficiency of the 10-h.p. motor is similar to the foregoing example of the 1-horsepower machine, but the stray-power losses will be corrected for speed.

The stray-power losses of 10-h.p. motor running free (*i.e.*, at 865 r.p.m.) equal the no-load armature input (230 volts and 2.3 amperes) minus the no-load armature copper and brush losses; that is:

Stray power at no load = $230 \times 2.3 - (2.3^2 \times .244 + 2.3 \times .84)$
 = 526 watts. At *rated load* the motor is running at a slightly lower speed of 825 r.p.m., hence the stray power will be less because the eddy current constituent varies as the square of the speed, and the several losses due to hysteresis, windage and friction may be assumed to vary directly as the speed. In ordinary machines of this size the stray-power losses are usually divided as follows: 50 per cent due to windage and friction, 25 per cent due to hysteresis and 25 per cent due to eddy currents. Hence, 75 per cent of the stray-power losses vary as the speed, and 25 per cent vary as the square of the speed. The stray power corrected for change in speed from 865 to 825 r.p.m. or $4\frac{1}{2}$ per cent will be $(.955 \times .75 \times 526) + (.955^2 \times .25 \times 526) = 495$ watts. If the stray power had been assumed to have the same value at no-load speed as at rated-load speed, the error introduced would therefore be $526 - 495 = 31$ watts, or about .4 per cent of 8740 watts, the rated input. This difference is so small that it may generally be neglected in practical problems. Furthermore there is in most cases a rise in stray-power losses as the load increases. These are called "load losses," being partly due to larger mechanical forces and therefore friction, also to augmented hysteresis and eddy currents because of altered distribution of flux which is crowded into certain portions of the armature. The assumption of the higher figure for stray power would tend to cover load losses which are difficult to determine.

The losses at rated load in addition to stray power are as follows:

Loss in Field Copper	$I_{sh}V = 1 \times 230 = 230.$	Watts
Loss in Armature Copper	$I_a^2 R_a = 37^2 \times .28 = 383.3$	Watts
Loss in Brush Contacts	$I_a D_b = 37 \times 1.4 = 51.8$	Watts
	665.1	Watts

This amount, added to the corrected stray-power value gives a total loss of $495 + 665 = 1160$ watts. Hence the output is equal to the input ($230 \times 38 = 8740$ watts) minus this loss, that is, $8740 - 1160 = 7580$ watts.

The efficiency is, therefore, $7580 \div 8740 = 86.8$ per cent. A comparison of calculated output (7580 watts) and rated output ($10 \times 746 = 7460$) shows that the former is 136 watts greater; so that the manufacturer is on the safe side when the motor is rated to give 10 horsepower, and this is as it should be, overrating of machinery being bad practice. In other words 10.18 h.p. are actually developed at rated input.

Effect of Armature Resistance upon Speed of Shunt Motors. —

The principal and instantaneous cause of shunt motor speed variation with changing loads is the varying armature current and consequent varying armature drop ($= I_a R_a$); hence the reason for making the resistance of the armature (R_a) as low as possible. This cause of speed change is shown by a consideration of the typical 10-h.p. motor. Assume its armature to be "hot" (75 degrees C.) and let us determine the speed change due to variations of armature current alone. From Table I we have the following test values: $R_a = .28$ ohm, brush drop at no-load .84 volts, at rated load 1.4 volts, and speed at rated load 825 r.p.m., with armature current I_a of 37 amperes and terminal voltage V of 230.

According to equation (4) the c.e.m.f. at rated load with armature "hot" but running free is $230 - (.28 \times 2.3 + .84) = 228.5$ volts. Hence from equation (7), taking the c.e.m.f. at rated load from page 21, we have r.p.m. (free) $= \frac{228.5}{218.2} \times 825 = 864$; that is,

the speed changes from 825 to 864, amounting to 39 r.p.m., or $4\frac{1}{2}$ per cent. Thus there is a speed rise of $4\frac{1}{2}$ per cent solely on account of diminished armature drop (including brush contacts) when the rated load is removed from this 10-h.p. motor. The effect is the same as if the voltage supplied to the armature were raised

about $4\frac{1}{2}$ per cent. In fact the available voltage is actually increased to that extent. This calculation does not take into account the effect of armature reaction which tends to counteract more or less the speed variation determined above, as shown a little later.

Effect of Temperature Changes upon Speed of Shunt Motors. — *Heating of armature* affects the speed only to a slight extent, and may be practically neglected, as already shown on page 22. For example, in the case of the 10-h.p. motor, the "cold" armature resistance is .244 ohm; the "hot" armature resistance with a temperature change from 25 degrees to 75 degrees C. (*i.e.*, 50 degrees C. rise being permissible) is 15 per cent greater (see p. 13) or .28 ohm. The speed alteration at rated load due to this heating is determined as follows:

C.e.m.f. with armature "cold" at rated load = $230 - (37 \times .244 + 1.4) = 219.6$ volts, the c.e.m.f. with armature "hot" and at rated load being 218.2 volts. Hence the speed at rated load and with armature "cold" is $219.6 \div 218.2 \times 825 = 830$ r.p.m. instead of 825 r.p.m. when the armature is "hot," an increase of .6 per cent, which is not material in most practical cases, as the change due to varying load may be 4 or 5 per cent as shown above.

As already noted on page 22, the load may be and often is suddenly thrown off a motor when its armature is "hot," and conversely rated load is often applied to a "cold" armature. In each case it is merely a question of fact how warm the armature may be. But the variation in resistance is only 15 per cent and produces little practical effect upon speed, as shown above.

Change of Speed due to Heating of Field Circuit. — The allowable temperature rise in the field winding is 50 degrees C., causing a 19 per cent increase in the resistance, as shown on page 12. Since the rated resistance is the working or "hot" value, being 230 ohms for the shunt field of the typical 10-h.p. machine, it follows that this resistance at ordinary temperature (assumed to be 25 degrees C.), herein called "cold" resistance, is

$$\frac{R_{sh}}{1.19} = \frac{230}{1.19} = 193.3 \text{ ohms.}$$

$$\text{Current in field (hot)} \quad I_{sh} = \frac{R_{sh}}{V} = \frac{230}{230} = 1 \text{ ampere.}$$

$$\text{Current in field (cold)} \quad I'_{sh} \frac{V}{R'_{sh}} = \frac{230}{193.3} = 1.19 \text{ amperes.}$$

Hence the current in the coils cold is 19 per cent greater than when the latter are hot; and from magnetization curves of standard types of shunt motors a rise of 19 per cent in field m.m.f. causes an increase of about 4 or 5 per cent in the flux, or the field is this amount stronger "cold" than "hot." With the other conditions (e , b , n and p) constant, the speed (N) will vary inversely with the flux (ϕ), as shown in the following transposed form of equation (2):

$$e = \frac{\Phi n N 2p}{10^8 \times 60 \times b} \quad \text{or} \quad N = \frac{e \times 10^8 \times 60 \times b}{\Phi n 2p} .$$

With the flux 4 to 5 per cent stronger when the field winding is cold than with it hot, the speed is 4 to 5 per cent lower. This variation of speed with heating of the field winding is an objectionable characteristic of the ordinary shunt motor for work requiring *almost perfectly constant speed*, such as weaving. It can be overcome by employing a field so highly saturated that a moderate change in field current produces only slight flux variation; or a field winding composed of wire having a zero temperature coefficient would secure a like result. Both methods are costly, especially the latter, because the only available materials are alloys whose resistivity would be much higher than that of copper, demanding correspondingly greater cross section of wire. On the other hand, it may happen that the former plan employing a field approaching saturation is desirable for other reasons, such as improved commutation, so that the total advantage warrants the expenditure for additional ampere-turns in the field coils.

It was explained under the preceding heading relating to heating of armature that rated load may be put upon a "cold" or a "hot" motor or may be thrown off either. In the field winding the full current flows whether the machine is loaded or not, so that the temperature of the former simply increases with the *time* of operation until maximum is reached.

Hence the heating of shunt-field coils and the percentage of speed rise occasioned by it are practically the same whether the motor is running free or loaded. The same is approximately true of armature heating by eddy currents and hysteresis in its core. On the other hand, heating due to armature resistance increases as the square of the current ($I_a^2 R_a$) and is therefore very small at light loads. At rated load it is about equal to the core heating in ordinary

machines, in which case the temperature rise in the armature would be about one-half as great running free as at rated torque. It has already been shown (page 26) that speed change due to armature heating is small, the r.p.m. being .6 per cent higher when the armature is "cold" (25 degrees C.) than when "hot" (75 degrees C.). Hence the speed would be .3 per cent greater when the armature *begins* to run free (*i.e.*, cold) than when it has been running unloaded for several hours.

Effect of Voltage Variation upon Speed of Shunt Motors. — The speed changes of shunt motors due to their own action have been discussed in all cases on the assumption that the voltage supplied to them was constant. Such constancy is the desirable condition to be maintained or approximated as closely as practicable. Nevertheless, appreciable variations of voltage do occur even on the best regulated circuits, and may often become very considerable, that is, 5 per cent or more, whether from central station or isolated plant. Fortunately the shunt motor is not very sensitive to these variations, the percentage of speed change being usually less than that of the voltage change. In actual practice the former is usually from .6 to .8 of the latter; that is, a 5 per cent rise or fall in voltage will cause the speed to rise or fall 3 to 4 per cent. In this respect the shunt motor is far less susceptible than the incandescent lamp, the ordinary carbon filament type changing its candle-power about 6 per cent when the voltage is altered only 1 per cent.

A shunt motor in which the magnetic circuit is considerably below saturation runs at nearly constant speed even if the voltage varies widely. This is because the flux Φ varies directly with the voltage V , which in turn is very closely proportional to e , the c.e.m.f. in the expression r.p.m. =
$$\frac{e \times 60 \times 10^8 \times b}{\Phi n z p}$$
 derived from equation (2),

so that any change in the latter is cancelled by a corresponding change in the former, r.p.m. remaining constant. On the other hand, with a magnetic circuit completely saturated and therefore constant, the speed would vary directly with e which is nearly proportional to the supply voltage V in the normal shunt motor with an armature circuit of very low resistance.

In almost all practical cases the magnetic circuit is partially saturated, and in order to determine the percentage of speed changes that will be produced by a certain percentage of voltage change V ,

it is necessary either to arrive at the result empirically by actual test or to calculate it from the magnetization curve of the machine, which is more or less individual for each design.

It is convenient for this calculation to employ what is known as the *percentage of saturation*. This quantity according to the A. I. E. E. Standardization Rules (F. IV, par. 58) "may be determined from the saturation curve of generated voltage as ordinates, against excitation as abscissas, by drawing a tangent to the curve at the ordinate corresponding to the assigned excitation, and extending the tangent to intercept the axis of ordinates drawn through the origin. The ratio of the intercept on this axis to the ordinate at the assigned excitation, when expressed in percentage, is the percentage

of saturation." It may also be found from the relation $p = 1 - \frac{1}{f}$,

in which p is the percentage of saturation and f is the saturation factor, which is defined by the same Rules (par. 57) as "the ratio of a small percentage of increase in field excitation to the corresponding percentage increase in voltage thereby produced." It is not necessary, therefore, to determine the complete saturation curve of the machine. It is sufficient to ascertain the percentage rise or fall in the voltage developed by the machine running as a generator on open circuit at any constant speed when the shunt field is excited first by normal voltage V and then by the voltage $V \pm v$, in which v is the percentage of variation of V in any particular case. For example, if the saturation curve or the test just mentioned shows that the voltage generated by a machine rises 2 per cent when the voltage V exciting the shunt field is increased 5 per cent, then its saturation factor $f = 5 \div 2 = 2.5$ and its percentage of saturation

$p = 1 - \frac{1}{f} = 1 - \frac{1}{2.5} = 60$ per cent. Ordinarily these quantities

are referred to the rated or normal value of V , but may be based upon any other selected value. This percentage of saturation represents the extent to which the magnetization approaches saturation. If the armature core were wholly saturated this percentage would be 100, while it is practically zero for moderate flux densities. *This same percentage of saturation represents the ratio between speed variation of a shunt motor and change of voltage V supplied to its terminals.* In the above example, therefore, the speed would rise $.60 \times 5 = 3$ per cent when the voltage increased 5 per cent, the percentage of

saturation being 60. At 100 per cent or complete saturation the speed rises or falls exactly the same percentage as the voltage. On the other hand, at zero saturation or with low flux densities practically proportional to the excitation, the speed would be constant.

In this discussion it is assumed that the resistance of the shunt-field circuit is constant, in which case the field current varies directly with the voltage V . This would be approximately true for a change of a few per cent in the value of V , which is all that usually occurs in practice. Of course any increase in V does tend to raise the temperature and therefore the resistance of the field winding, so that the shunt-field current would not increase or decrease quite as rapidly as the voltage V . This fact makes the percentage of speed variation *slightly greater* than that stated above. This effect is similar to that due to the gradual heating of the field which occurs even when V is constant, as already explained on page 26.

The definitions of *percentage of saturation* and *saturation factor* quoted above from the A. I. E. E. Standardization Rules refer either to one *point* on the saturation curve at which a tangent is drawn or to "a small percentage of increase in field excitation." This limitation is imposed because a point of tangency or a very short distance on a curve may be regarded as a straight line. The voltage variations occurring in practice may be so small that this assumption is correct, but often they amount to 5 or 10 per cent or even more, and cases might arise in which the voltage may be accidentally or purposely varied 50 or 75 per cent. For the purposes of our problem, which relates to the effect of such variations upon the speed of shunt motors, it is sufficient to consider only the range of variation, the form of the curve between the limiting points being of no consequence. Hence the machine is driven as a generator at any constant speed, and d the difference in voltage developed is measured with field excited by voltages V and $V \pm v$ respectively. It is not necessary in this case to limit v to the "small percentage" stated in the definition. If d and v are expressed as percentages of the initial values, then $v \div d = f$, the saturation factor; which signifies simply the fact that in order to raise the voltage generated by a certain percentage it is necessary to augment the magnetizing current a greater percentage. For example, a saturation factor of 3, which is an ordinary value, means that a 4 per cent rise in generated voltage demands a $3 \times 4 = 12$ per cent increase in magnetizing current or

exciting voltage which are assumed to be proportional to each other in a shunt machine, because temperature and resulting resistance changes are gradual even when they occur. In making the test to determine d for a given value of v , only a voltmeter is connected to the armature; hence the driving power required is small, and the speed may have any reasonable value, provided it is constant.

The above method of calculating the speed of a shunt motor at various values of terminal voltage V was applied in the case of a 10-horsepower 115-volt General Electric shunt motor. The results thus obtained are given in Table II and are compared in Table III with the measured speeds noted during a speed-load test, at the same values of V as employed in the calculations. A portion of the magnetization curve of the motor was carefully determined, and from this the following relations required for the calculations were determined. V represents the voltage applied to the motor field winding; I_{sh} the shunt-field current = $V \div R_{sh}$; e.m.f. represents the open-circuit voltage obtained when the motor was operated as a generator at the specified speed, and is naturally proportional to the field flux Φ developed by the corresponding value of I_{sh} . The per cent saturation at rated excitation with 115 volts was determined directly from the magnetization curve.

TABLE II.—TESTS TO DETERMINE PERCENTAGE OF SATURATION OF A 10-H.P. SHUNT MOTOR.

Terminal Voltage, V .	Shunt Field Current, I_{sh} .	E.m.f. at 970 r.p.m. $\propto \Phi$.	A , Change in I_{sh} .	B , Change in e.m.f. or Φ .	$1 - \frac{B}{A}$, per cent Saturation.
105 Volts.	1.5 Amps.	109 Volts.	-8.5%	-3.6%	57.5
110	1.57	111.2	-4.3	-1.7	60.0
115*	1.64	113.1	0	0	63.0
120	1.71	114.8	+4.3	+1.5	65.0
125	1.78	116.4	+8.5	+2.9	66.0

* Rated voltage and field current.

The formula employed to calculate the various speeds of the motor at different values of V is in its simplest form as follows:

$$r.p.m. \text{ at } V = r.p.m. \text{ at rated } V \{ 1 + (A - B) \}, \quad (8)$$

wherein A and B must be given their proper signs.

TABLE III.—MEASURED AND CALCULATED SPEEDS OF A 10-H.P. SHUNT MOTOR WITH LINE VOLTAGE (V) VARIED.

V.	105 Volts.		110 Volts.		115 V.	120 Volts.		125 Volts.	
I_{eh}	1.5 Amps.		1.57 Amps.		1.64 Amps.	1.71 Amps.		1.77 Amps.	
I_a	R.p.m.		R.p.m.		R.p.m.	R.p.m.		R.p.m.	
Amps.	Test.	Calc.	Test.	Calc.	Test.*	Test.	Calc.	Test.	Calc.
10	906	920	938	946	970	992	996	1010	1024
20	894	910	926	934	958	976	984	996	1012
40	880	892	912	916	940	956	966	986	992
60	866	878	900	902	926	938	952	976	978
75	852	864	886	888	912	926	937	962	964

* Rated voltage and field current.

The agreement between measured and calculated speeds is remarkably close; such differences as do exist are so small that they come within ordinary errors of observation.

CHAPTER IV.

SHUNT-MOTOR STARTING BOXES.

IN starting shunt and compound-wound motors, no trouble is likely to occur in connecting the shunt-field coils to the circuit because their resistance is high. The difficulty is with the armature, its resistance being very low in order to obtain high efficiency and good speed regulation, as already shown. If a low-resistance winding

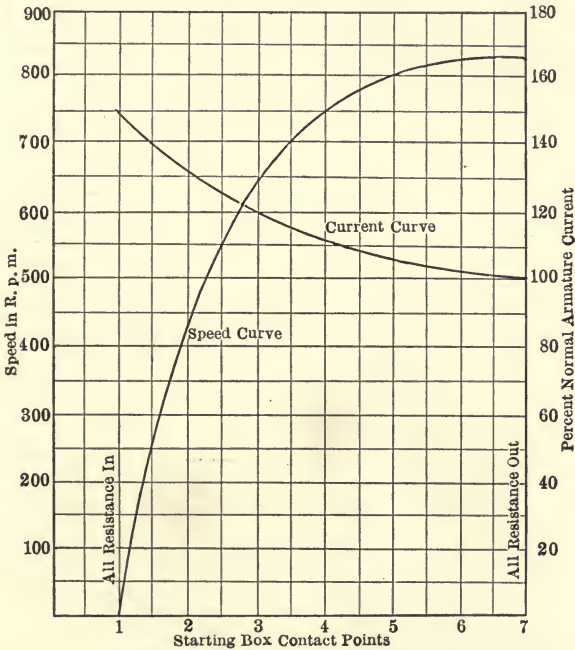

FIG. 3. — STARTING SPEED AND CURRENT CURVES.

be directly connected across the line terminals, the current would be so excessive that it would tend to injure or destroy it. When standing still an armature generates no c.e.m.f., so that the entire voltage of the supply circuit would have to be consumed by the fall of potential in the armature resistance and brush contacts ($I_a R_a + D_b$).

Theoretically the armature current would rise in the typical 10-horsepower motor to a value $C_a = (V - D_b) \div R_a = (230 - 1.4) \div .28 = 816$ amperes compared with rated current of only 37 amperes. This equation is obtained from equation (4) by making c.e.m.f. equal to zero. Practically the current would not reach such an extreme value, because the fuses or circuit-breaker would act to prevent it; but a very excessive armature current would flow at least momentarily with injurious electrical as well as mechanical effects.

To prevent injury and at the same time to obtain gradual acceleration, an adjustable rheostat, commonly called a "starting box," is inserted in series with the armature, the resistance of which is gradually reduced as the speed increases. As a rule, starting boxes, unless otherwise specified, are designed to allow the motor to draw an initial current about 50 per cent greater than the normal value, so that the machine may develop ample torque to start under load. The following example indicates the method of determining the various values of the resistance required in the starting box. Assume that the 10-horsepower motor, the data of which have been given, is to be started from rest under load, that the current and "speeding up" curves desired are those shown in Fig. 3. The current curve gives the current values desired at the various positions of the contact arm of the starting box, seven in all, decreasing gradually from 50 per cent above normal at start to rated current at rated speed. The speeds at the corresponding points are obtained from the speed curve in Fig. 3, and are tabulated as follows:

SPEEDS IN STARTING 10-H.P. MOTOR UNDER LOAD.

Position of Contact Arm.	Armature Current Per Cent of Rated Value.	Armature Amperes.	Speed in R.p.m.
1 All resistance in.....	150	55.5	0
2.....	133	49.3	450
3.....	120	44.5	640
4.....	112	41.7	750
5.....	106	39.5	800
6.....	102	37.75	820
7 All resistance out.....	100	37.00	825

The motor speeds at the various contact points being assumed as above, the c.e.m.f. corresponding to these speeds can be readily determined by substituting them in equation (7), p. 21. Knowing

the c.e.m.f. and taking the corresponding values of armature drop, also the brush contact drop from the curve in Fig. 2, the voltage drop ($I_a R_x$) in the external resistance R_x can be calculated from the following equation giving the relation between action and reaction in the armature circuit of a direct-current shunt motor:

$$V = \text{c.e.m.f.} + I_a R_a + D_b + I_a R_x. \quad (9)$$

TABLE IV.—DERIVATION OF STARTING-BOX RESISTANCES.

Line Volts, V.	C.e.m.f. = $\frac{\text{r.p.m.}_a}{\text{r.p.m.}_r} \text{c.e.m.f.}_r$ Volts.	Armature Drop. $I_a R_a$. Volts.	Brush Drop, D_b . Volts.	External Drop, $I_a R_x$. Volts.	External Resist., R_x . Ohms.	Box Point.
230	$\frac{0}{825}$ 218.2 = 0	55.5 × .28 = 15.6	1.71	212.7	3.83	1
230	$\frac{450}{825}$ 218.2 = 119.0	49.3 × .28 = 13.8	1.60	95.6	1.94	2
230	$\frac{640}{825}$ 218.2 = 169.0	44.5 × .28 = 12.2	1.50	47.3	1.06	3
230	$\frac{750}{825}$ 218.2 = 198.5	41.7 × .28 = 11.7	1.45	18.35	.44	4
230	$\frac{800}{825}$ 218.2 = 212.0	39.5 × .28 = 11.1	1.43	5.50	.14	5
230	$\frac{820}{825}$ 218.2 = 217.0	37.75 × .28 = 10.6	1.41	1.00	.027	9
230	$\frac{825}{825}$ 218.2 = 218.2	37. × .281 = 10.4	1.40	.0	.0	7

Motor starting boxes are not designed with large radiating surfaces, because the box is supposed to be in use only for very short periods (15 to 30 seconds at one time). The chief precaution is to have the resistance units of such current-carrying capacity that they do not become injured by a momentary overload current of 50 per cent above the rated value. Practically the box should be designed to act a certain number of times per hour (every 4 minutes) without injury. If the contact arm of the starting box is moved too rapidly over the contact points, the armature current would be excessive and injury might result, hence the starting period of 15 to 30 seconds as stated.*

* Standardization Rules A. I. E. E., Division II, Section H, Rule 302.

In case a motor is to be started without load, the starting resistances calculated before would not bring up the speed gradually, because the initial $I'_a R_x$ drop would be only 3.83×2.3 or 8.8 volts, so that the c.e.m.f. with total box resistance in circuit and no-load current is $230 - 8.8 + 1.4 = 219.8$ volts, and the corresponding motor speed would be $(219.8 \div 218.2) 825 = 832$ r.p.m. Hence the motor would almost instantly run at a speed greater than at rated load. For this reason, to start a motor without load it is sometimes the practice, especially in Europe, to use a special box, the resistance of which is much higher than in the preceding design. For instance, if it were desired to have the "speeding up" curve at no load of the same shape and corresponding values as that in Fig. 3, the required external resistance would be far higher than those in Table IV. For example, the armature current running free is only 2.3 amperes, which with the armature "cold" (25 degrees C.) would produce an armature drop of $2.3 \times .24 = .55$ volt. This added to the no-load brush drop of .80 volt makes a total drop of only 1.35 volts, so that the drop in the starting box would have to be $230 - 1.4 = 228.6$ volts. Therefore the required starting resistance $R_x = 228.6 \div 2.3 = 99.4$ ohms in order that the armature should stand still and carry only 2.3 amperes. If a starting box having any such high resistance were employed to start a motor under load (for example at rated torque), the armature current would be far less than the rated value until next to the last contact point was passed, when the armature would suddenly jump to rated speed, a change much too sudden and likely to injure the motor or the machine driven by it. For this reason, and to have the starting box adapted to all load conditions, the American practice is to use a box designed to start the motor under load. Thus, while the speed may rise rather suddenly without load, no injury will result, because the initial (*i.e.*, total) resistance is sufficient to limit the armature current to a reasonable value and the speed does not rise more than about 3 per cent above rated value. Rapid acceleration without load is not objectionable, provided neither current nor speed is excessive. On the other hand, the motor is fully protected when started under load, the armature current having sufficient strength to bring the armature gradually up to speed.

Starting-Box Connections.—Care should be taken with regard to the disconnection of shunt motors from the source of supply in

order that the field circuit shall not be broken suddenly when the motor is shut down. Failure to take this precaution not only causes arcing at the switch blades, but might break down the insulation of the field coils, owing to the high voltage induced by sudden cessation of current in such an extremely inductive winding. The motor can be disconnected sparklessly and without danger to the field insulation by opening the supply switch at *S*, leaving the field connected across the armature, Fig. 1. The machine then slows down gradually and, acting as a generator, sends a decreasing current, in the original direction, through the field winding, so that a sudden inductive discharge is avoided.

To avoid the possibility of closing the supply switch with the starting resistance cut out, the National Board of Fire Underwriters specify that "Motor-starting rheostats must be so designed that the contact arm cannot be left on intermediate segments, and must be provided with an automatic device which will interrupt the supply circuit before the motor speed falls to less than one-third of its normal value."* This protective feature consists in replacing the starting resistance in the armature circuit, upon opening of the supply switch, and is automatically accomplished by an auxiliary device in the starting box. This comprises a small electro-magnet *B*, excited by the supply voltage, so placed as to hold the contact arm, through a keeper *K* placed upon it, in the "on" position as long as the circuit is closed. After the supply circuit is broken the contact arm is returned to the "off" position by means of a spring at *P*, but this does not occur until the speed of the motor has been considerably reduced. The winding of the electro-magnet *B* may be placed in series with the shunt field or directly across the line, the latter connection being preferable with adjustable-speed motors.

* Rule 60, section *f*, National Electric Code, 1907.

STARTERS AND REGULATORS. R. Krause. London, 1904.

RHEOSTAT CONTROL. A. C. Button. *Gen. Elect. Review*, Schenectady, Vol. XII, 1909, pp. 365, 423.

CHAPTER V.

SHUNT-MOTOR SPEED CONTROL BY VARIATION OF ARMATURE RESISTANCE.

THE service conditions under which electric motors operate often require *adjustable* speeds which are under the control of the operator. This adjustment may be accomplished in various ways, and the particular method to employ depends upon the character of work, range of speed required, cost of electrical energy as well as cost of motor and equipment. There are two general conditions of speed control; the first calling for *adjustable speeds at constant torque* (if desired), the second being satisfied by *adjustable speed with variable torque*. The first of these conditions is fulfilled by *variation of the applied armature voltage*, and the second by *change of field flux*.

1. Armature Rheostat Control. The first method which naturally suggests itself is the variation of armature voltage by means of resistance in series with it. The current-carrying capacity of this regulating resistance must naturally be greater than that of the ordinary starting box, since it may be in circuit for long periods. The accepted design is such that it will not heat up to more than 100 degrees C. on continuous service with rated load current. The large current capacity may be obtained by making up the resistance units in plate form, or some other arrangement by which large radiating surface is obtained. Consideration of equation 9,

$$V = \text{c.e.m.f.} + I_a R_a + D_b + I_a R_x, \quad (9)$$

shows that with increase of voltage drop in the rheostat the c.e.m.f. must decrease, and, as already shown, when c.e.m.f. is reduced the speed diminishes in the same ratio, hence the control of a motor by rheostat in its armature circuit is a method of speed regulation which can only *decrease* the speed of the machine.

Speed-control Rheostat.—For the sake of simplicity in the following problems, the stray-power losses will be assumed to be the

same at no load and full load—in fact, as already shown, the change affects the efficiency by only a very small amount. Assume that it is required to design a resistance box to be employed as a speed controller for the 10-h.p. motor, and this control is to give a speed variation in four steps from one-quarter to rated speed, at rated torque and for continuous service at any of the four speeds. Since rated torque is to be developed, the motor armature should be considered as operating “hot,” hence its resistance R_a is .28 ohm and the speeds desired are 206, 412, 619, and 825 r.p.m., respectively, the last being the rated speed. Tabulating the conditions of torque and speed desired and recollecting that $I_a R_x = V - (c.e.m.f. + I_a R_a + D_b)$ we obtain the following results:

TABLE V.—DERIVATION OF CONTROLLER-BOX RESISTANCES.

Speed Desired, r.p.m.	A c.e.m.f. = r p.m. 218.2 r p.m. $\frac{V}{\omega}$ Volts	B Armature Drop $I_a R_a$ $37 \times .28$ Volts.	N Brush Drop D_b Volts.	External Drop = $230 - (A + B + N)$ = $I_a R_x$ Volts.	External Resist. R_x Ohms.
$\frac{1}{4}$ = 206	54.55	10.4	1.4	163.6	4.4
$\frac{1}{2}$ = 412	109.10	10.4	1.4	109.1	2.95
$\frac{3}{4}$ = 619	163.60	10.4	1.4	55.6	1.48
rated = 825	218.20	10.4	1.4	0.0	0.

The same results are obtained very simply as follows: The c.e.m.f. at rated speed and torque being 218.2 volts (= $230 - 11.8$), the armature would stand still if sufficient resistance were put in series with it to produce a drop of this amount, that is, $I_a R_x = 218.2$ volts. The rated current I_a is 37 amperes, therefore the required resistance $R_x = 218.2 \div 37 = 5.9$ ohms. Since this external resistance gives zero speed with rated torque exerted, three-quarters of 5.9, or 4.4, ohms give one-quarter speed, also $5.9 \div 2 = 2.95$ ohms give one-half speed, $5.9 \div 4 = 1.48$ ohms give three-quarters speed and so on. With armature current raised to $1.25 I_a$, corresponding to standard overload capacity, the necessary resistance in each case is only .8 as great. In this way the resistance needed for any speed from zero to rated value and for any armature current can readily be determined.

Knowing the value in ohms of the various resistances required in the controller, it is still necessary to determine the size of box that will contain the needed radiating surface. The temperature rise usually permitted in speed-regulating rheostats is 100 degrees C., and with temperature limit known, the surface of the resistance units (A) can be calculated, because the heat energy emitted must equal that produced; that is,

$$.24 I_a^2 R_x = Aht, \tag{10}$$

in which I_a is the rated current, R_x the total resistance of the rheostat, h the emissivity of the resistance metal (*i.e.*, gram-calories emitted per square centimeter per degree C.), and t the difference between room and rheostat temperatures in degrees C. The total controller resistance R_x as given in preceding table is 4.4 ohms, the current I_a is 37 amperes, the emissivity h of nickelin (the resistance metal assumed) is .000506 and the difference in temperature t is 100 degrees C. Substituting these values in equation (10) we have

$$A = \frac{.24 \times 37^2 \times 4.4}{.000506 \times 100} \text{ or } 28,600 \text{ sq. cm.}$$

That is, the nickelin wire employed must have an emitting surface of 28,600 sq. cm. in order that it will not increase in temperature more than 100 degrees C. at rated load. Knowing the resistance required and the radiating surface, the length of the resistance wire can readily be calculated if the cross section be decided upon. Assuming a circular wire, the following formulas of resistance and length apply: Surface area = $2 \pi lr$ and $R_r = \frac{\rho l}{\pi r^2}$, where area = 28,600 sq. cm., l the length in centimeters, r the radius in centimeters, R_r the total rheostat resistance (4.4 ohms) and ρ the specific resistance of nickelin (*i.e.*, .00005 ohm per centimeter cube). Substituting these values in the above equations we have

$$28,600 = 2 \pi lr \text{ or } l = \frac{28,600}{2 \pi r}; \text{ and } 4.4 = .00005 \frac{l}{\pi r^2} \text{ or } l = \frac{4.4 \pi r^2}{.00005}.$$

Equating these values of l and solving for r , we obtain $r = .253$ cm.; from which $l = 18,000$ cm. That is, the nickelin wire required would have a diameter of .506 cm. (No. 4 B. & S. gauge) and a length of 180 meters. The total resistance is divided into three

sections of 1.47 ohms each to give three-quarters, one-half and one-quarter speed respectively when the sections are successively introduced into the circuit.

A simple method of constructing this box is to employ resistance units in the form of helices. A helix 4 cm. diameter requires π 4 or 12.5 cm. of wire per turn, or 1 meter of wire would make eight turns. These turns should be about .5 cm. apart, which is equal to the diameter of the wire, so that eight turns require 8 cm. height. The total length of resistance wire being 180 meters, each section is 60 meters long and is composed of 60×8 or 480 turns. Hence each section if made up in one helix would be 480 cm. high. In order that a section should not be too long, it may be divided into 12 units, each 40 cm. high. For the complete box 36 units are required, each 40 cm. high and 4 cm. in diameter. These coils should be placed so as to have 1 cm. space between them for ventilation and to avoid short-circuiting; hence the box would be 6×5 or 30 cm. wide and of the same thickness. The inside dimensions of the finished box would accordingly be $40 \times 30 \times 30$ cm., containing 180 meters of nickelin resistance wire No. 4 gauge.

Discussion of Speed Control by Armature Rheostat. — The efficiency of such a combination for obtaining motor speed control at the various r.p.m. selected is determined as follows: The stray-power losses affect the efficiency at the various speeds so slightly that for this calculation we assume them as constant at their value for rated torque and speed; correction can, however, be made, as shown later.

A motor operating at a constant torque will have an output directly proportional to its r.p.m.; hence, we have the following tabulated results for the typical 10-horsepower machine the actual output of which is 7550 watts.

TABLE VI.—EFFICIENCY OF SPEED CONTROL BY ARMATURE RHEOSTAT AT RATED TORQUE.

Total Watts Input.	R.p.m.	Watts Output.	Efficiency Per Cent.
$220 \times 37 + 230 \times 1 = 8740$	825	7550	86.5
$220 \times 37 + 230 \times 1 = 8740$	619	5662	64.8
$220 \times 37 + 230 \times 1 = 8740$	412	1887.5	43.2
$220 \times 37 + 230 \times 1 = 8740$	206	3775	21.6

If we plot these efficiency values as ordinates and the speeds as abscissas, we have a straight line, as in Fig. 4. Hence it is sufficient to calculate one value and draw a line through this point and the origin. A study of this method of speed control brings out the following objections:

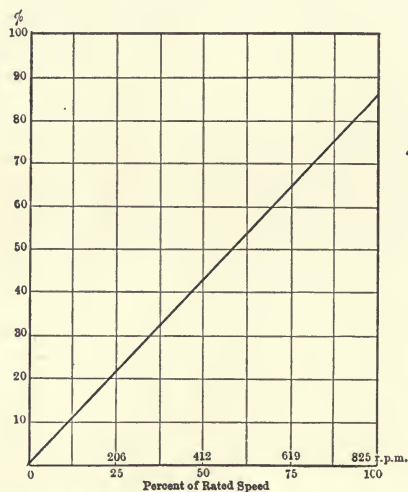

FIG. 4. — EFFICIENCY CURVE OF 10-HORSEPOWER MOTOR WITH ARMATURE RHEOSTAT CONTROL

Objections to Armature Rheostat Control.

(a) *Bulk of Rheostat.* — This may not be very objectionable if only a few motors are so controlled, but for a number, the extra space becomes a factor, and in many cases it is difficult to find sufficient room near the motor.

(b) *Inefficiency of the System.* — The same amount of power is supplied at all speeds, but at low speeds only a small part of it is converted into useful work, the balance being wasted as heat. Thus, with the 10-horsepower motor the useful work at one-quarter speed is only 21.4 per cent of the total input, as shown in table above.

(c) *Poor Speed Regulation with Varying Loads.* — Since the impressed voltage at the armature terminals is equal to the line voltage minus the resistance drop in the regulator ($V_t = V - I_a R_x$), any change in the current drawn by the motor produces a change in the terminal voltage, the c.e.m.f., and, therefore, the speed. The changes in speed likely to occur with load changes may be very great, and are best brought out by specific examples. Consider

the 10-h.p. motor with the controller box just designed for it, and assume that the motor is driving a lathe at rated torque (37 amperes) and at one-half speed. That is, the motor is running at 412 r.p.m. and a full cut is being made; suddenly, however, the machinist so changes the depth of cut that the torque falls to one-quarter of the rated value — that is, $I_a = 9.25$ amperes — and the simultaneous increase in speed accompanying this will be very considerable. Its value can be determined as follows:

The total resistance drop in the armature circuit is at this reduced current equal to $I_a (R_a + R_x) + D_b = 9.25 (.28 + 2.9) + 1 = 30.4$ volts, so that the c.e.m.f. = $230 - 30.4 = 199.6$ volts. Hence the speed = $\frac{199.6}{218.2} \times 825 = 755$ r.p.m., that is, it rises suddenly from 412 to 755 r.p.m. when the torque is decreased from rated value to one-quarter thereof. In most practical cases it is desirable that no material variation in speed should occur with change of torque, so that this increase, amounting to 83 per cent $\left(\frac{755}{412} = 1.83\right)$, would usually be very objectionable.

The speed change for any torque variation at any rheostat setting can be similarly calculated and the results of such calculation have been embodied in the speed-regulation curves of Fig. 5. The speed of the motor at any fraction of rated torque with any position of the controller arm can be obtained from these curves and the speed change due to any variation of torque thus readily determined. For example, the typical 10-horsepower motor, when operated at rated torque with 3 ohms external resistance in its armature circuit, would have a speed of about 412 r.p.m. or half the rated value, according to Fig. 5. If its load be so changed that the required torque falls to one-half of the previously assumed value, the regulation curve indicates that the speed rises to 635 r.p.m., an increase of 54 per cent. From the preceding examples it becomes obvious that the speed regulation of a motor with armature rheostat is very poor; in fact the changes in speed which occur with considerable variations in torque are so excessive as to be very objectionable and may actually endanger the tool and its work. This difficulty of poor speed regulation with variation of torque may be avoided by employing some of the field-weakening or multiple-voltage methods to be considered later. With these methods, even when the torque

varies from zero to rated value, the speed change is small, being from 2 to 8 per cent, depending upon the particular method employed.

In the foregoing calculations, the error introduced by assuming the stray-power losses as constant at all speeds is small, as shown in the following paragraph:

Consider, for example, the one-quarter speed condition for which the error introduced by variation of stray-power losses due to speed change would be a maximum. With speed at one-quarter of rated value, and at rated torque, the motor output would be equal to 1887.0 watts. The various resistance losses would be the same as at

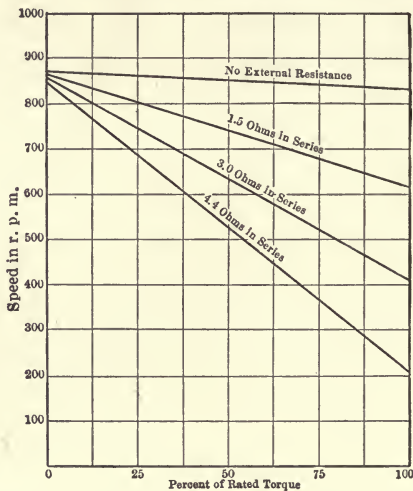

FIG. 5. — SPEED CURVES OF 10-H.P. MOTOR, WITH DIFFERENT ARMATURE RHEOSTAT RESISTANCES.

rated load, or 675.0 watts. The total stray-power loss is made up of eddy current, hysteresis, friction and windage losses, the first of which varies as the square of the speed, while the others vary directly with speed. In motors of about 10-h.p. capacity the various losses are approximately in the following proportion:

Eddy-current loss, one-quarter of total stray-power loss.

Hysteresis loss, one-quarter of total stray-power loss.

Friction and windage, one-half of total stray-power loss.

The sum of these losses, or the total stray power, has already been found to be 526 watts (p. 24). Hence the eddy-current loss at normal speed is 131.5 watts, and at one-quarter speed is $131.5 \div 4^{-2} = 8.2$ watts. The hysteresis loss at normal speed is 131.5 , and at

one-quarter speed is $131.5 \div 4 = 32.8$ watts. The friction and windage loss at normal speed is 263 watts, and at one-quarter speed is $263 \div 4 = 65.6$ watts.

Adding these values, the corrected stray-power losses for one-quarter speed are 107 watts. The total motor losses at this speed are, therefore, $675 + 107 = 782$ watts. The motor input is 8740 watts; motor loss, 782 watts, and motor output is 1887 watts; hence, the loss in the rheostat is $8740 - (1887 + 782) = 6071$ watts; thus $R_x = 6071 \div 37^2 = 4.45$ ohms, or only .05 more than that obtained by calculation with stray-power losses assumed constant. Hence the error introduced by this assumption is negligible.

2. **Speed Control by Brush Shifting.** — Speed variation by means of brush shifting is not desirable, as it increases armature reaction and tends to produce sparking.

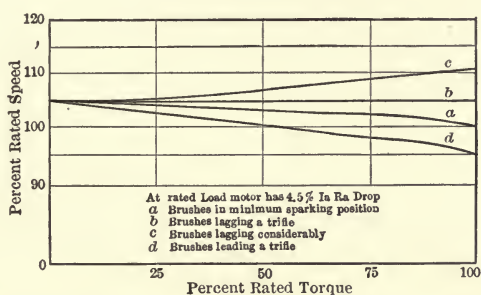

FIG. 6.—RELATION BETWEEN BRUSH POSITION AND SPEED OF SHUNT MOTOR.

Curves are given in Fig. 6 showing how the speed can be controlled by brush shifting, but the range is small. It is interesting to note in connection with this figure that armature reaction in a motor due to a considerable negative lead of the brushes (that is, moved backwards, opposite to direction of rotation) can be made to maintain a constant or rising speed. This is not a feasible method, however, because in the operation of direct-current motors it is practically necessary to set the brushes in the position of *minimum sparking*, since sparking is the most troublesome feature of these machines. In the case of interpolar or commutating pole motors a lag of even $\frac{1}{8}$ to $\frac{1}{32}$ inch in brush position causes a pronounced rise in speed as the load is increased, with the probable production of visible sparking (p. 64).

CHAPTER VI.

SPEED CONTROL OF SHUNT MOTORS BY VARIATION OF FIELD CURRENT.

IN the preceding chapter, the speed regulation of a motor by means of an adjustable resistance in the armature circuit was considered, and the objections to its use pointed out. This chapter is devoted to the discussion of a second method of speed adjustment not open to the same objections.

The equation $e = \frac{\Phi n N 2 p}{60 \times 10^8 \times b}$ shows that if e , the counter e.m.f., is kept constant, and Φ varied, the speed N varies inversely as the flux Φ because the other quantities do not change unless purposely made to do so by altered construction or arrangement of parts. This relation, therefore, indicates a method of speed variation. Shunt motors are usually designed to have such high flux density in both field and armature that it is not practicable to increase it materially. Hence this method is confined to and commonly called field weakening.

In the case of ordinary shunt motors, the range of speed variation by means of field weakening is small. For instance, take the 10-horsepower motor previously considered and weaken its field by the introduction of extra resistance into its field circuit to produce 30 per cent increase in speed. Since the flux must be varied inversely as the speed, it must be weakened in the proportion 130 : 100 or 100 : 76.9, that is, 23.1 per cent, while to produce this change the field ampere-turns must be reduced by about 50 per cent. To develop rated torque with this diminished field strength the armature current must be increased 30 per cent, and the ratio between back ampere-turns and field armature-turns, instead of having its normal value of about .10, is raised to $\frac{.13}{.5} = .26$, because the former is 30 per cent greater and the latter is reduced to one-half. This latter ratio is excessive. The corresponding increase in cross ampere-turns, acting collectively with the increased back ampere-turns, causes excessive

sparkling. Hence a 30 per cent increase of speed with an ordinary standard shunt motor cannot be obtained without objectionable sparking.

Another difficulty arises from the fact that the increase of armature current necessary to maintain constant torque augments the $I_a^2 R_a$ loss, which in the 10-horsepower motor armature rises from $37^2 \times .28$ to $48^2 \times .28$, an increase of 262 watts or 68 per cent, producing too much heat for the armature insulation to stand for any considerable time.

Adjustable speed motors of the flux-variation type are *not constant-torque machines, but constant-horsepower or output motors; i.e.*, the torque falls as the speed increases in inverse ratio, or $T \times \text{r.p.m.} = \text{a constant}$. In fact, unless the ratio of back ampere-turns to field ampere-turns is less than 10 per cent at minimum speed, an increase in speed of even 30 per cent with constant output is not practicable with the ordinary shunt motor because it demands a 50 per cent reduction in field m.m.f., as shown above.

It is evident that a shunt motor, to have any considerable range of speed variation (*i.e.*, increase of more than 20 or 30 per cent) by field weakening, requires some modification in design, because the field must be more powerful with respect to the armature than in the case of standard single-speed motors. Some special motors of this kind allow of speed variations of three or four to one, with constant-horsepower output, but not at rated torque. These increased speed ranges are obtained as follows:

(a) *Magnetic Circuit of Very Soft Steel.*—The magnetic properties of the material are such that even with high flux densities the bend of the curve is not reached, so that the change in field ampere-turns to produce a large change in flux is not excessive; *i.e.*, the rate of change of flux and m.m.f. is almost in direct proportion. With these machines the field frame is also large, the total flux being very great, while the armature winding consists of *fewer* turns per section and a *larger* number of sections, so that the self-induction per section is low. Thus, under normal or even exceptional conditions the ratio of field to back ampere-turns is kept within 10 per cent. However, a machine having a field of sufficient strength to prevent sparking at high speeds must have a frame considerably larger than necessary for a single-speed machine of equal power and the commutator must have a greater number of bars. In general, when considering

this simple type of variable-speed motor, it can be stated that the percentage of speed increase of which a normally loaded motor is capable by means of field weakening is a measure of its overload capacity with full field strength. In other words, *a given range of speed variation demands a motor having a certain increased capacity*, or special features of design. The following practical examples illustrate this point:

Relative Sizes of Frames with Speed Ratio of 1 : 2:

3-horsepower frame for a 2-horsepower motor.

15-horsepower frame for a 10-horsepower motor.

Relative Sizes of Frames with Speed Ratio of 1 : 3:

3-horsepower frame for a $1\frac{1}{2}$ -horsepower motor.

10-horsepower frame for a 5-horsepower motor.

20-horsepower frame for a 10-horsepower motor.

(b) *With the magnetic circuit specially designed so that the flux density is always great at the pole tips*, the field distortion due to armature reaction is lessened and a sufficient flux is maintained in the commutation zone, giving sparkless operation within reasonable speed and load limits.

Greater ranges of speed adjustment than a three to one ratio are frequently required, for example, five or even six to one; in such cases the preceding types are not economically available. With the (a) and (b) types it is difficult or costly to maintain the commutation fringe when the main field excitation is reduced sufficiently to obtain a speed range greater than four to one; thus some new feature in design to maintain the commutation flux becomes necessary. This feature, somewhat differently obtained, is present in two types of motors.

(c) Historically the first of these is the Thompson-Ryan design of *compensated* motor, manufactured by the Ridgway Dynamo and Engine Works. This compensated form employs what is equivalent to a stationary armature built up in the polar faces, and traversed by the armature current or a portion thereof, which develops a m.m.f. opposed to the armature m.m.f., thus *eliminating or even reversing armature reaction*. It has been found, however, by M. E. Thompson that this compensating winding, by itself, is not sufficient to prevent sparking at the brushes, so he introduced commutating lugs, excited by special turns immediately around them as well as by the compensating winding, which establish a flux for reversal over

the coils undergoing commutation.* This motor thus possesses the *two features of compensation and commutation*, which are independent of the strength of the main field, and sparkless operation over wide speed changes is theoretically possible.

(d) The second of these special forms is one wherein *armature reaction and distortional effects are not overcome*, but their presence is depended upon to obtain good speed regulation. The sparkless condition of operation is secured by the use of "interpoles" or auxiliary field poles, placed directly over the zone of commutation, the m.m.f. of these poles being opposed to that of the armature, and, as they are energized by coils carrying the armature current, their m.m.f. increases with and is designed to be superior to that of the armature. Thus the flux for reversal is locally maintained independently of the main field, and varies automatically, as required, with the result that sparkless commutation may be obtained.† The difference between types *c* and *d* is that the former embodies general magnetic compensation as well as local commutation flux, whereas the latter depends upon local flux for commutation alone, with no attempt to neutralize armature reaction as a whole.

Machines of Class (a) are built by many manufacturers, and while a number are in use they are larger than standard constant-speed motors, as already shown. An example of this class (*a*) is found in a 5-h.p. Bullock shunt motor, the data of which are as follows:

Rated capacity, 5-h.p.

Rated pressure, 220 volts.

Speed, 350 to 1050 r.p.m.

Armature current at rated load, 22.2 to 24.6 amperes (depending upon the speed).

Field current, 1.3 to .23 amperes.

No-load armature current, 2.1 to 3.6 amperes (depending upon field strength and speed).

Armature resistance, hot, 1.12 ohms.

Field resistance, hot, 195 ohms.

Weight of motor complete, 1100 lb.

Tests were conducted upon this motor with the results shown in the following series of curves:

* U. S. Patent No. 591,024, October 5, 1897.

† U. S. Patent No. 775,310, November 22, 1904.

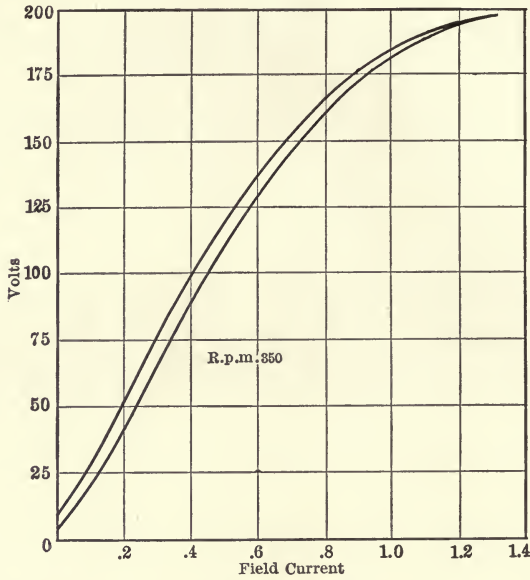

FIG. 7. — MAGNETIZATION CURVE OF 5-H.P. BULLOCK 3 : 1 ADJUSTABLE-SPEED SHUNT MOTOR.

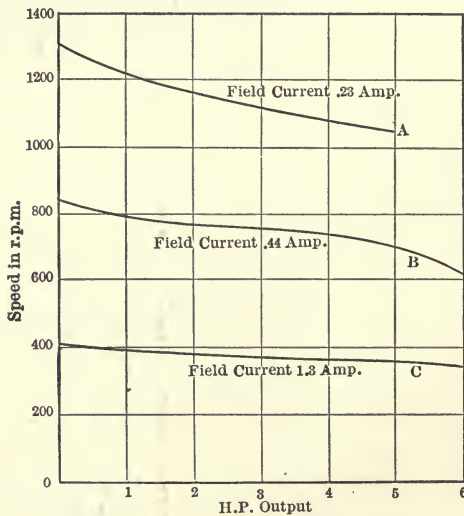

FIG. 8. — SPEED-LOAD CURVES OF 5-H.P. BULLOCK MOTOR.

The magnetization curve (Fig. 7) of this motor shows no special feature, other than that the flux density is kept below the bend of the curve. A study of the speed-load curves (Fig. 8) shows that the speed regulation under load changes is reasonably good at the lower speeds. At the highest speed (curve A) the load was not carried beyond 5 horsepower, the rated value, the reason being that at this point the tendency to spark at the brushes becomes pronounced and the speed regulation not as good as in the preceding speed-load curves. The larger falling off in speed in this case was due to the greater sparking and voltage drop at the brush and commutator contacts. The currents, running free, rise with increase of speed, owing to greater core and friction losses.

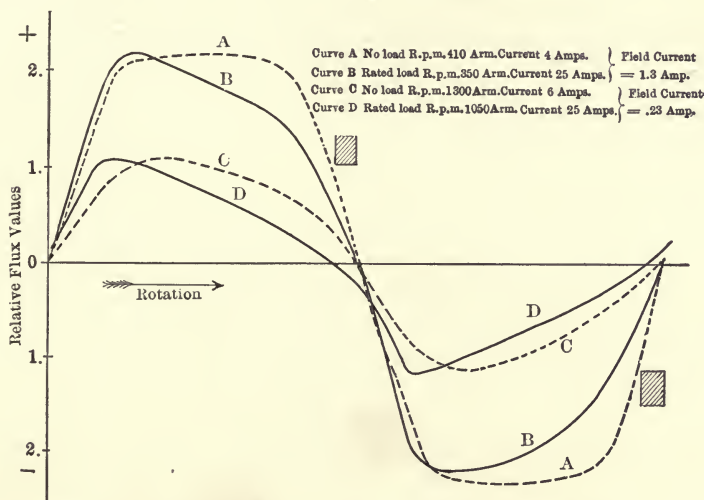

FIG. 9. — FLUX DISTRIBUTION OF 5-H.P. BULLOCK MOTOR.

An examination of the flux-distribution diagram (Fig. 9) of this motor shows firstly how much the field flux is reduced in value to obtain the highest speed, and, secondly, how the armature distortional effects have forced the field magnetism to the left, the crossing-point or zero flux value being no longer under the brush, which naturally causes the sparking noted above.

The efficiency curves (Fig. 10) of this 5-horsepower motor bring out the fact that, at corresponding loads, the efficiency of the machine is less the higher the speed. This is to be expected because frictional

losses increase more rapidly than the iron losses fall off, the same being true generally of all adjustable-speed motors unless provided with ball or roller bearings.

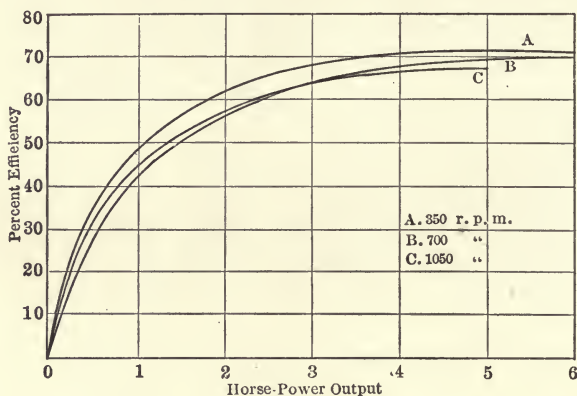

FIG. 10. — EFFICIENCY CURVES OF 5-H.P. BULLOCK MOTOR AT SPEEDS OF 350, 700 AND 1050 R.P.M.

Machines of Class (b) were formerly manufactured by the Magneto Electric Company, and called Storey Motors, after the designer. These motors are of interest because they show how the concentration and holding of the flux at the pole tips can be obtained by simply hollowing the field cores, as represented in Fig. 11.

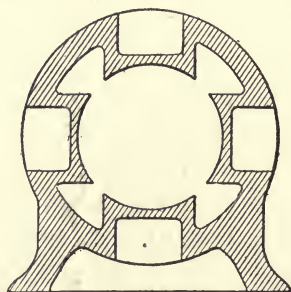

FIG. 11. — FIELD FRAME CONSTRUCTION OF STOREY MOTOR.

The frame of the motor is of soft steel and the flux density high, but not reaching the bend of the magnetization curve, as Fig. 12 shows; and the cores are relatively short.

The data of a 3-h.p., 3 : 1 adjustable-speed Storey motor examined by the authors is as follows:

Rated pressure, 115 volts.

Armature current at rated load, 25 to 28 amperes, increasing with the speed.

Field current, .5 min., 1.7 max.

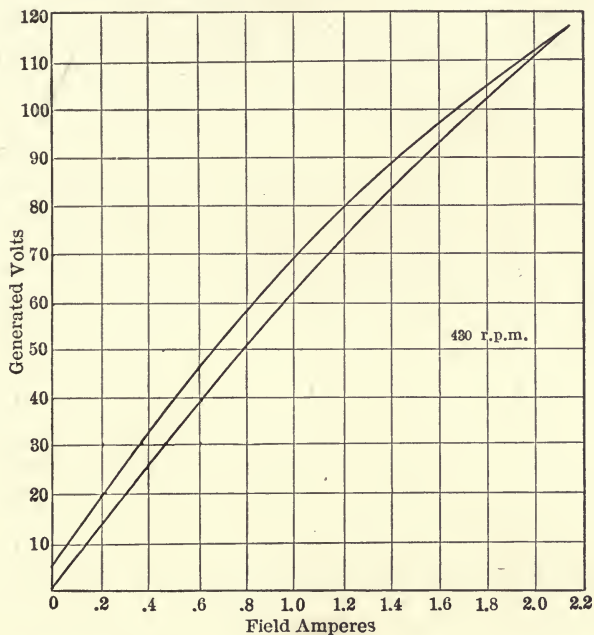

FIG. 12. — MAGNETIZATION CURVE OF 3-H.P. STOREY 3 : 1 ADJUSTABLE-SPEED SHUNT MOTOR.

No-load armature current, 1.1 to 4 amperes, increasing with the speed.

Armature resistance, .31 ohm.

Field resistance, 67.5 ohms.

Speed, 430 to 1290 r.p.m.

Weight, 800 pounds.

The flux-distribution curves of this motor (Fig. 13) show a very uniform flux under the pole pieces at minimum speeds, also that the flux reversal line remains fixed independently of the load, thus maintaining a flux for commutation, which, however, is notably decreased in width as the main field is weakened, causing the ultimate develop-

ment of sparking as well as poorer speed regulation. This latter fact is also brought out by a study of the speed-load curves of this motor in Fig. 14.

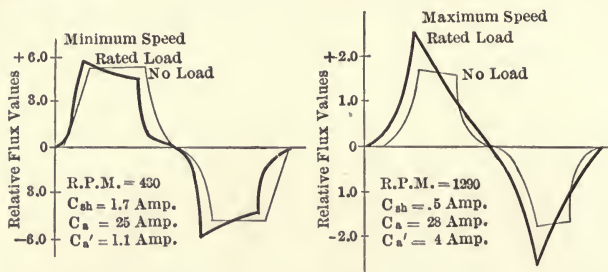

FIG. 13.—FLUX-DISTRIBUTION CURVES OF 3-H.P. STOREY SHUNT MOTOR.

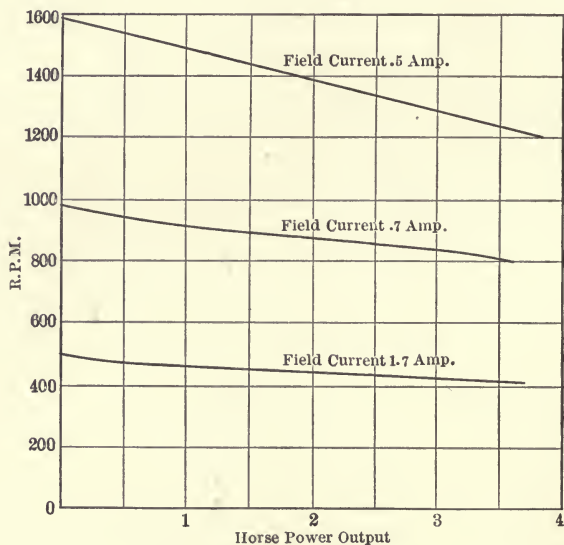

FIG. 14. — SPEED-LOAD CURVES OF 3-H.P. STOREY SHUNT MOTOR.

For example, the drop in speed from no load to rated load with the weakest field is 29 per cent, whereas the decrease in speed over the corresponding load range at the strongest field is only 16 per cent; thus the falling off in speed with weakest field excitation is 13 per cent greater. Only a small part of this is due to the greater $I_a R_a$ drop ($28 \times .31 = 8.7$ instead of $25 \times .31 = 7.8$); hence the extra falling off in speed occurring at weakest field must be primarily due to poorer contact and sparking at the brushes.

The efficiency curves of this Storey motor (Fig. 15) show that the second speed (860 r.p.m.) is probably the best for average service; while the highest-speed curve indicates large stray-power losses.

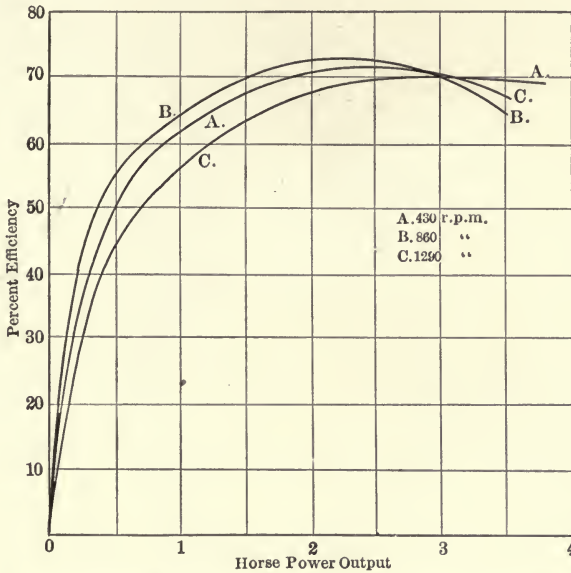

FIG. 15. — EFFICIENCY CURVES OF 3-H.P. STOREY SHUNT MOTOR.

It should be noted in the case of these preceding types of adjustable-speed shunt motors (*a* and *b*) that the speed in all cases falls off considerably as the load comes on, the greatest percentage of reduction occurring with the weakest field, and, in all cases, the drop in speed is either equal to or greater than that caused by $I_a R_a$ drop. Moreover, as the brushes of these machines are set back from the geometrical neutral zone, they cannot run equally well in both directions of rotation, without brush shifting.

The adjustable-speed motors (type S) of the Northern Electric Manufacturing Company represent a construction similar in principle to that of the above-described Storey motors and belong therefore to the same class (*b*). Their pole pieces are split in the direction of the flux, forming a field frame of clover-leaf form. This frame, built up of laminations, is similar to the construction shown in Fig. 17, but without the commutation lugs.

Class (c). — The earlier form of Thompson-Ryan motor diagrammatically illustrated in Fig. 16 was originally brought out for

constant speed, but the demand for an adjustable-speed motor of wide range led to its adoption for this latter service as well. A machine of this type, however, is very expensive to build or to repair,

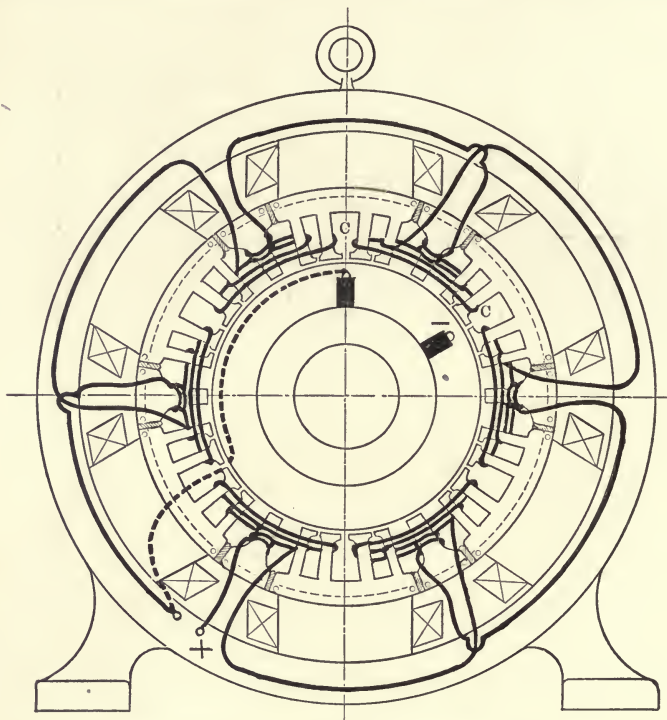

FIG. 16. — ORIGINAL FORM OF THOMPSON-RYAN MOTOR.

and therefore for the small sizes commonly employed to drive machine tools the modified design shown diagrammatically in Fig. 17 was developed in the spring of 1904. This modified type retains the compensating winding and commutation lugs of the earlier patented design, but discards the inner polar ring with its inherent cost, connecting the commutation lugs directly to the field yoke and placing the *compensating* winding in slots formed in the main polar faces.

The function of the compensation coils *C, C* (Fig. 16), in series with the armature winding, is primarily to prevent the distortion of the field flux and thus eliminate brush shifting under load; this, however, was not found effective to prevent sparking,* therefore the com-

* Transactions A. I. E. E., March 20, 1895, Vol. XII.

mutation lug was introduced to provide the necessary flux for reversal directly at the armature coils undergoing commutation; thus *general compensation* and *local commutation* phenomena are combined.

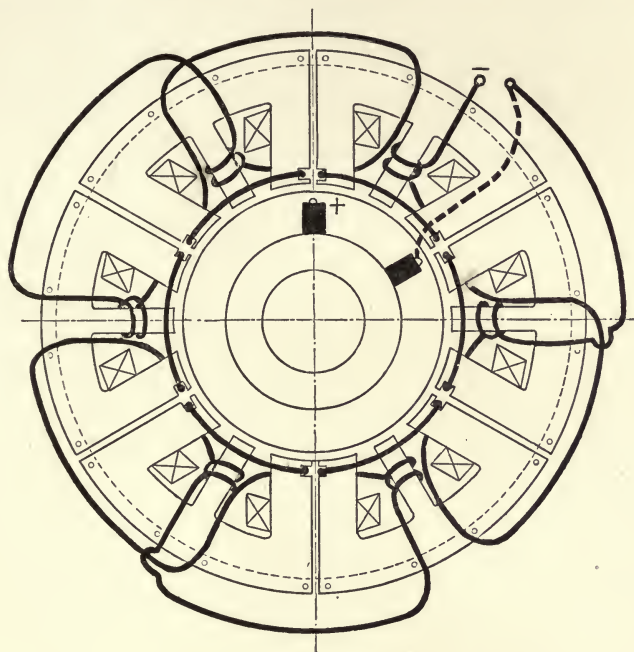

FIG. 17. — MODIFIED FIELD FRAME OF THOMPSON-RYAN ADJUSTABLE-SPEED MOTOR.

The data of a 3-h.p. Thompson-Ryan motor of the modified type tested by the authors are as follows:

Line voltage, 250 volts.

Armature current at rated load, 11.4 to 12.2 amperes, rising with the speed.

Field current, .28 to 1.15 amperes, increasing as speed falls.

No-load armature current, 1.0 to 2.2 amperes, rising with the speed.

Armature resistance, 2.1 ohms. Compensating and commutating coils' resistance, 1.17 ohms.

Field resistance, 200 ohms.

Speed, 350 to 1400 r.p.m., depending upon field strength. Weight complete, 650 pounds.

The flux-distribution curves in Fig. 18 show that the armature reaction is *reversed* as load comes on, the leading corner being weakened and the trailing one strengthened, which is just the converse of the action occurring in other motors. As a result of this action, the leading corner is weakened more than the trailing corner is strength-

ened, and the net effect is a diminution of the field strength under load increase, with corresponding improvement in speed regulation.

The reversal of armature reaction can readily be carried so far as to produce hunting and racing with large increase of load, especially

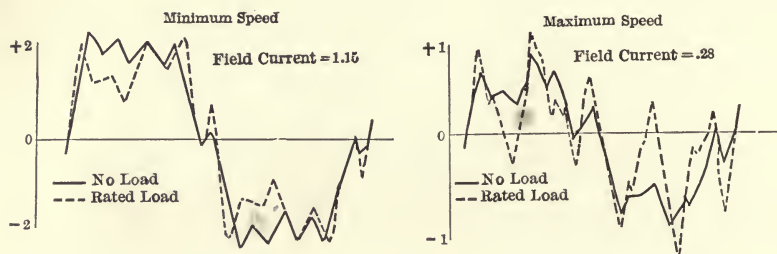

FIG. 18. — FLUX-DISTRIBUTION CURVES OF THOMPSON-RYAN 3-H.P. MOTOR.

at the higher speeds. This scheme for obtaining very constant speed regulation is not, however, economically developed, since the weight of copper used in the compensating winding is approximately twice that used in the armature winding, which naturally means greater $I_a R_c$ drop, $I_a^2 R_c$ losses and heating.

Interesting features of this design are the extremely small air gap and the very high average potential difference of over 20 volts existing between adjacent commutator bars. In fact this voltage is undoubtedly much more than in some cases, because, when the motor is operating at the higher speeds, the points of very high flux density can be approximately located by the lines of scintillation on the commutator, due to incipient sparking between neighboring bars.

The speed-load curves of this motor (Fig. 19) represent both clock- and counter-clock-wise rotation and show just the reverse of the characteristic regulation of the ordinary simple field-frame shunt motors (types *a* and *b*), in that the speed decrease under load is more pronounced at the low than at the higher speeds. This improvement in regulation is due to the field distortion and reduction caused by the action of the balancing windings. For example, at minimum speed the drop in speed from no load to rated load is 14.5 per cent, which is substantially that which occurs through $I_a R_a$ drop. At the highest rate of rotation (field current = .28 amps.) the decrease in speed from no load to rated load is only 7.1 per cent, whereas it

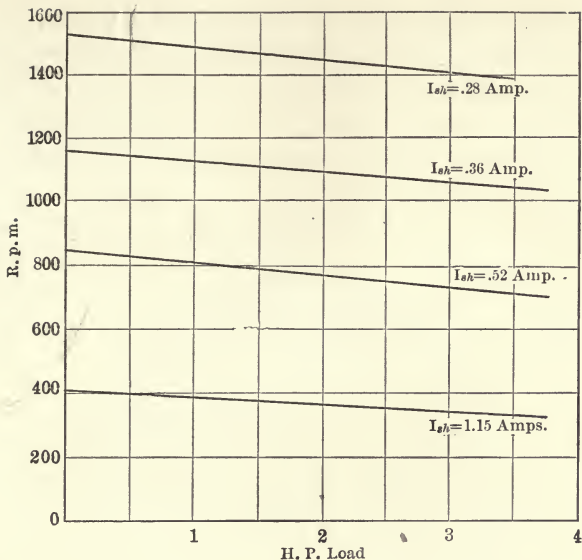

FIG. 19. — SPEED-LOAD CURVES OF 3-H.P. THOMPSON-RYAN MOTOR.

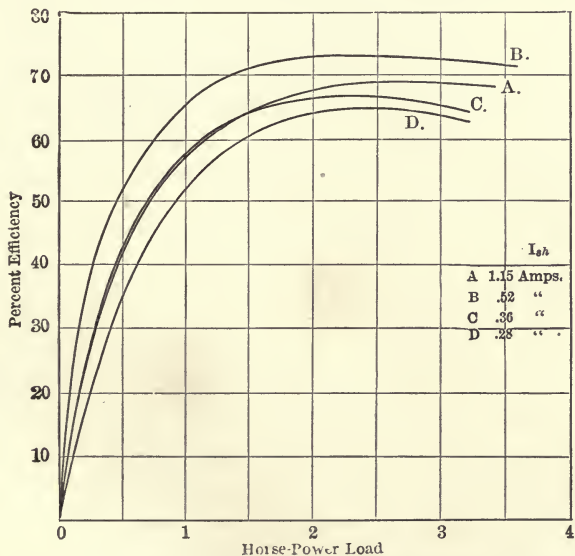

FIG. 20. — EFFICIENCY CURVE OF 3-H.P. THOMPSON-RYAN MOTOR.

would be 15 per cent due to $I_a R_a$ drop; so that speed regulation is improved 8 per cent by the effect of the balancing winding.

The flux-distribution curves shown in Fig. 18 indicate not only very markedly the reversal of armature reaction, but also the net

decrease of main-field strength occurring at the highest speed. The falling off of flux to zero and even reversal, under the middle of the main poles, is caused by the fact that the laminated construction employed has the main poles split from the pole face back through the yoke. This construction is necessary so that the removal of the various field coils for repair is feasible.

The efficiency curves of this motor in Fig. 20 indicate nothing unexpected, because it is obvious from the construction that copper losses are great, and the flux-distribution curves show that the core losses are also large, on account of the crowding and numerous reversals of flux.

This type of motor is extremely sensitive to change of brush position, a barely perceptible movement forward or backward producing quite different speed characteristics, so that the machine runs faster in the clockwise direction of rotation or more slowly in the opposite direction, acting in the one instance like a differential motor and in the other like a heavily over-compounded motor. The ordinary wear of the brushes during use or the formation of even invisible sparks under the brushes, which is not unlikely to occur, alters the speed regulation considerably and frequently leads to more pronounced and objectionable sparking.

Class (d).—*Interpole** or commutation-pole motors (Fig. 21) constitute what is herein designated as Class (d) of adjustable-speed motors. In such machines auxiliary poles are introduced between the main-field poles. These interpoles are excited by coils connected in series with the armature, so that full or proportional part of the armature current flows through them. This type differs from Class (c) in that the compensation winding is discarded and armature reaction is therefore not eliminated or reversed, a *local commutation flux* alone being depended upon for sparkless operation throughout the range of speed. In fact, with this type armature reaction is actually exaggerated because the flux from the interpole strengthens the leading-pole corner and weakens the trailing-pole corner just as the armature m.m.f. does. This exaggeration of field distortion does no harm, but, on the contrary, it improves the speed regulation of the machine. The interpolar flux for reversal is independent of the main field; being, however, directly dependent upon the armature

* U. S. Patent No. 775,310, November 22, 1904.

current, it increases therewith and thus maintains the necessary commutating field.

The connections of this type of motor are diagrammatically indicated in Fig. 22, N, S, N, S being the main poles, and n, s, n, s the interpoles. Each interpole is of the same polarity as that of



FIG. 21. — INTERPOLAR MOTOR — FRONT BEARING REMOVED.

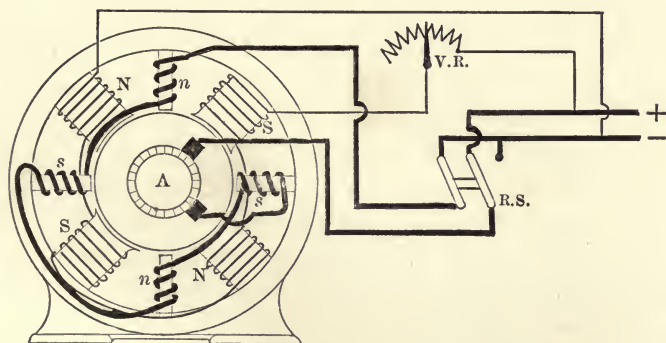

FIG. 22. — CONNECTIONS OF INTERPOLAR MOTOR.

the main pole immediately *back* of it, depending upon the direction of rotation; hence the illustration shows polarities for clockwise rotation. As represented, the interpoles are small with respect to the main-field poles, the arc of armature periphery subtended by

the former being about one-sixth that embraced by the latter. As already stated, the interpoles are provided with magnetizing coils connected in series with the armature and are placed midway between the main poles, directly over the armature coils undergoing commutation. The commutator brushes are consequently so set that they short-circuit coils in the geometrical neutral position. With this setting of brushes the motor will operate with substantially the same speed characteristics in either direction of rotation.

Data of a 5-h.p., 6 to 1 variable-speed interpolar motor manufactured by the Electro-Dynamic Company, and tested by the authors, are as follows:

Rated voltage, 240.

Armature current at 5-h.p. output, 22.2 to 24 amperes, increasing with speed.

Armature current running free, .7 to 1.7 amperes, increasing with speed. Field current, adjusted between 1.27 and .16 amperes to obtain speeds from 210 to 1260 r.p.m. at 5-h.p. output.

Resistance of armature winding, .9 ohm at 75 degrees C.

Resistance of interpole winding, .2 ohm at 75 degrees C.

Resistance of shunt-field winding, 176 ohms at 75 degrees C.

Speed 205 to 1260 r.p.m. at 5-h.p. output, increasing with weaker field.

Weight, 1200 pounds.

The magnetization curve of this motor (Fig. 23) shows that, for the minimum speed, the flux density is carried well up above the bend; this is also quite apparent from the fact that a speed ratio of 1 : 6 is obtained with field currents at 8 : 1.

The speed-load curves of this motor (Fig. 24) indicate excellent speed regulation, with an actual increase of speed under load at the weakest field value. The regulating influence of armature and interpole reaction upon the main magnetic field and speed is brought out by the following examples:

The no-load speed with field current of 1.27 amperes is 222 r.p.m. The speed diminution caused by IR drop is 22 r.p.m.; nevertheless, at rated load with field current of 1.27 amperes, the speed is 205 r.p.m.; hence the effect of armature and interpole reaction is to hold up the speed 5 r.p.m. compared with what it would otherwise be. At a speed of 740 r.p.m. the armature reaction exactly com-

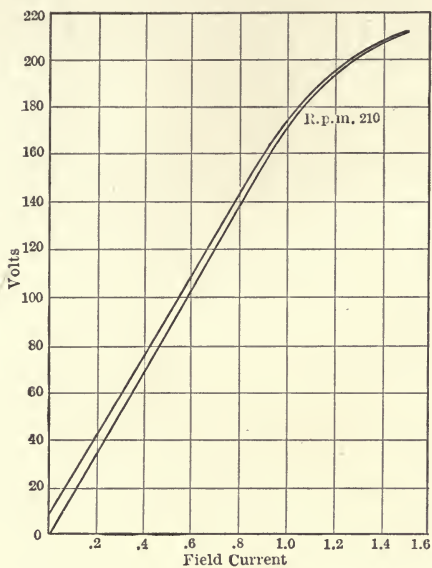

FIG. 23. — MAGNETIZATION CURVE OF 5-H.P. INTERPOLAR SHUNT MOTOR.

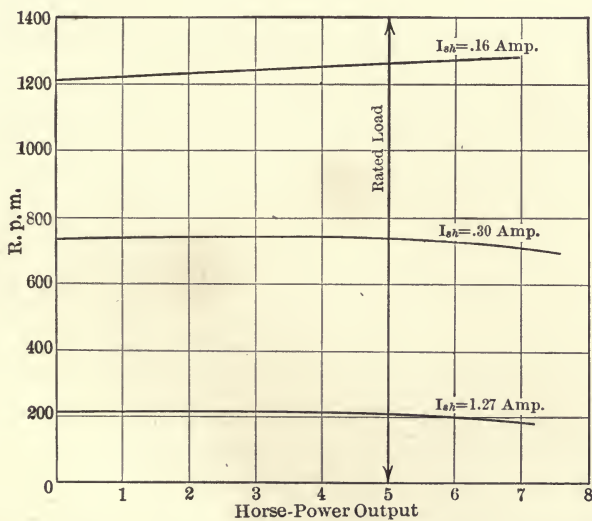

FIG. 24. — SPEED-LOAD CURVES OF 5-H.P. INTERPOLAR SHUNT MOTOR, SPEED RANGE 6 : 1.

pensates for IR drop and the motor speed remains constant up to the rated output of 5 horsepower. With field current of .16 amperes the motor speed rises from 1209 to 1260 r.p.m. when output increases from zero to 5 horsepower. Apparently it should fall from 1209 to 1084 r.p.m., which is the ratio between the c.e.m.f.'s (*i.e.*, 238.1 : 213.6), but the reaction on the main field by the interpoles and armature weakens the same sufficiently to raise the speed 176 r.p.m.

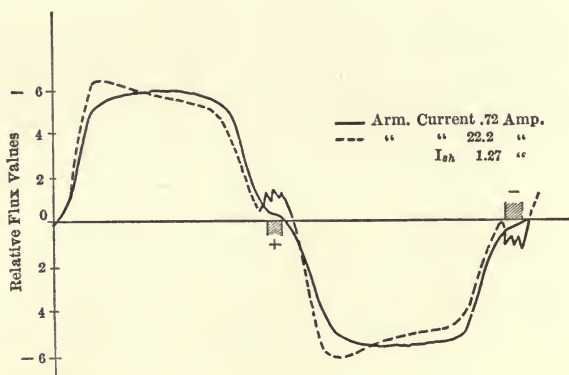

FIG. 25A. — FLUX DISTRIBUTION OF 5-H.P. ADJUSTABLE-SPEED INTERPOLAR SHUNT MOTOR, FIELD CURRENT 1.27 AMPS.; SPEED AT RATED LOAD 210 R.P.M.

It is thus evident that with this type of machine the speed regulation is the reverse of that obtained with adjustable-speed motors having the ordinary forms of field magnet (Classes *a* and *b*).

The interpolar type of motor can be readily reversed in direction of rotation even while under load, on account of the great self-induction of the interpole and armature circuit and the production of the proper value of commutation flux.

The flux-distribution curves in Fig. 25A indicate that at strong field excitation the interpoles do not produce a very great effect. The same fact was also shown in the speed-load examples on page 62. With small field flux, however (Fig. 25B), the interpole m.m.f. and armature reaction produce a marked weakening and distortion of the main field, which phenomena are also apparent from the speed-load curves (Fig. 24).

If the brushes be displaced from the geometrical neutral position, the motor speed is considerably changed. For example, with the brushes shifted backward (opposite to rotation direction), the speed

will rise under load, because then the interpolar flux develops in the armature an e.m.f. which decreases that produced by the main-field poles. If the brushes are advanced in the direction of rota-

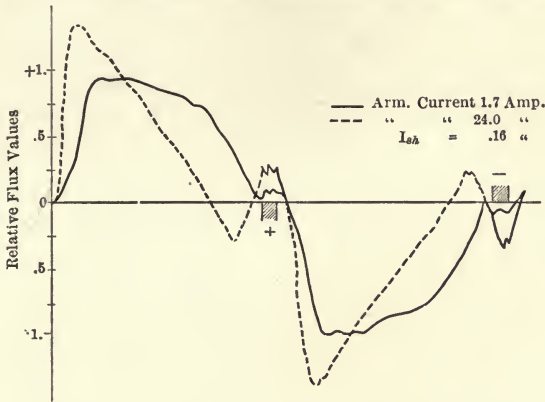

FIG. 25B. — FLUX DISTRIBUTION OF 5-H.P. ADJUSTABLE-SPEED INTERPOLAR MOTOR, FIELD CURRENT .16 AMP.; SPEED AT RATED LOAD 1260 R.P.M.

tion the speed will fall under load, as in the case of a cumulative compound motor, because the interpolar flux generates an e.m.f. in the same direction as that due to the main poles. In consequence of this, the proper position for the brushes is obtained when

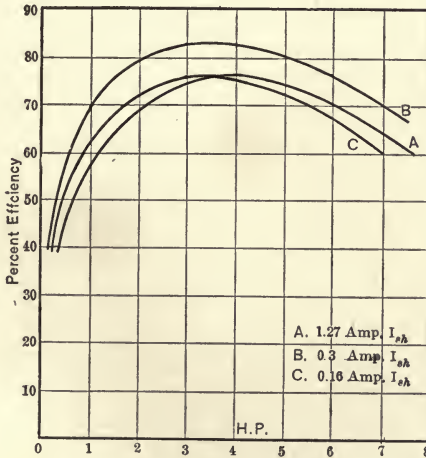

FIG. 26.—EFFICIENCY CURVES OF A 6-H.P. ADJUSTABLE-SPEED "INTERPOLE" MOTOR.

the r.p.m. are the same in both directions for given load and field strength, and motors of this type should not be removed from the factory test table until such adjustment is secured.

The efficiency curves of this motor (Fig. 26) indicate high values for light loads, which is due to the use of ball bearings. The rapid falling off in efficiency after rated load is reached is to be expected, on account of the additional I^2R losses caused by the interpole windings. The best running speed of this motor is apparently at a field strength of about .3 ampere, because at this value the general efficiency of the motor is considerably greater than at lower or higher speeds.

Dunn Method. — Another type of motor, the speed of which is adjustable by varying field flux, was invented by Mr. Gano S. Dunn.* The armature is supplied with constant current and the field winding separately excited from a constant-potential circuit through a rheostat. The armature current being constant, the torque varies directly with field flux. By means of the field rheostat this flux may be regulated from a very low value up to full strength with corresponding increase of torque. This large range of control is obtained by regulating the field current, which is small, the heavy armature current being kept constant by an automatically regulated generator, as in constant-current arc lighting. The advantage is similar to that secured by the "field-weakening" method already described, but gives any torque or speed from zero to full value, while the latter is practically limited (unless special designs are employed) to a certain ratio of speeds, usually 2 or 3 to 1. This method possesses an additional advantage over field-weakening control in having maximum field strength with maximum speed and torque. In these respects it would be adapted to adjustable-speed work in machine shops. On the other hand, the necessity for constant-current as well as constant-potential supply, and the high voltage required to give any considerable power, are serious objections to this system. It is hardly practicable to operate motors below 20 horsepower with more than 100 amperes, at which current it would require about 1000 volts to supply 100 horsepower on one circuit — a dangerous voltage in a shop. To multiply circuits is objectionable because each would demand its separate constant-current generator. Furthermore, the latter has not been developed commercially above 10 amperes. For these reasons, the field-weakening and multiple-voltage methods are preferred for machine shop or similar service.

* U. S. Patents No. 549,061, October 29, 1895, and No. 591,345, October 5, 1897.

CHAPTER VII.

SPEED CONTROL OF MOTORS BY VARIATION OF FIELD RELUCTANCE.

THE preceding chapter dealt with the problem of shunt-motor speed adjustment by variation of the field-exciting current; this chapter is descriptive of those motors whose speed regulation depends upon the *variation of the reluctance of the magnetic circuit*.

This method of control is based upon the fundamental fact that $\text{flux} = \frac{\text{magnetomotive force}}{\text{reluctance}}$. Thus, if the m.m.f. be maintained

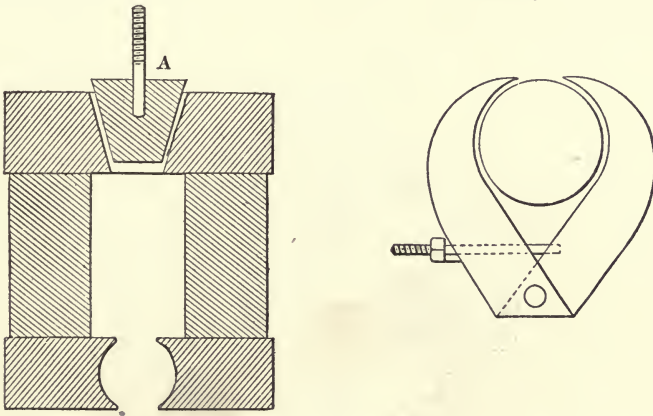

FIGS. 27 AND 28. — METHODS OF VARYING RELUCTANCE OF THE MAGNETIC CIRCUIT.

constant and the reluctance be varied, the field flux is changed in the inverse manner, and from the relation $\text{r.p.m.} = \frac{e 10^8 60 b}{\Phi n 2 p}$ it is evident that the speed varies inversely as the field flux (Φ) or in the same ratio as the change in the reluctance. Among the earlier methods tried were those of T. A. Edison and the Diehl Company.

The Edison Variable Reluctance Methods of Control. — The reluctance of the magnetic circuit in the machine was varied, as

shown in Fig. 27, by decreasing the amount of metal in the yoke of the field magnet, the wedge-shaped piece, *A*, being raised, thus decreasing the total flux. The range of speed adjustment is limited, however, as excessive sparking develops when the field is weakened because there is no feature of design to prevent flux distortion. This method was primarily intended for voltage regulation in connection with generators, and is of historical rather than commercial importance.

The Diehl Method of Control. — In this type of machine flux reduction was obtained by a lengthening of the air-gap. The field magnet was hinged so that the pole pieces could be moved away from the armature as indicated in Fig. 28. This construction was not very successful and was, like the preceding, originally intended as a means for regulating the voltage of generators.

Two modern methods of speed control by variation of reluctance are those of the Stow Electric Company and the Lincoln Manufacturing Company.

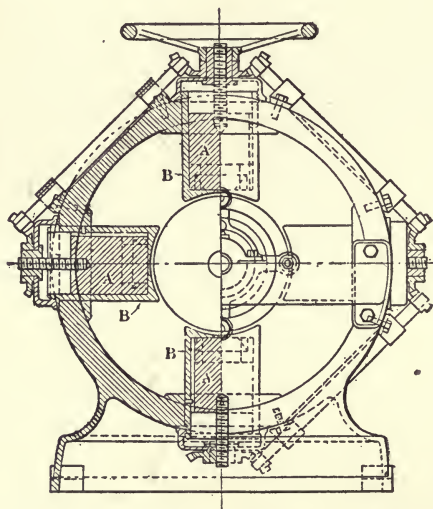

FIG. 29. — STOW ADJUSTABLE-SPEED MOTOR.

The Stow Adjustable-speed Motor. — The speed increase of this machine also depends upon the removal of iron from its magnetic circuit, the pole cores being made hollow and provided with iron or steel plungers, the position of which is made adjustable through worm gears and pinions operated by the large hand-wheel, at the top,

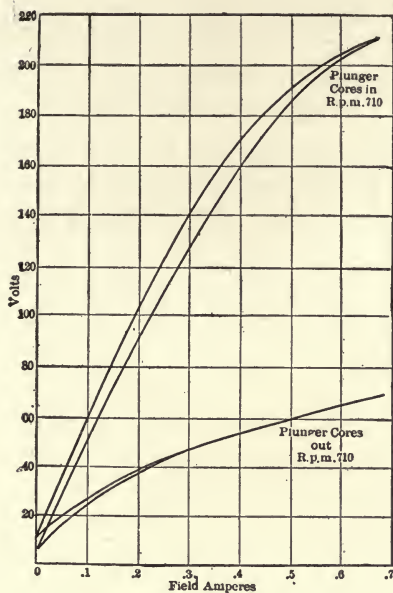

FIG. 30. — MAGNETIZATION CURVES OF 4-H.P. STOW MOTOR.

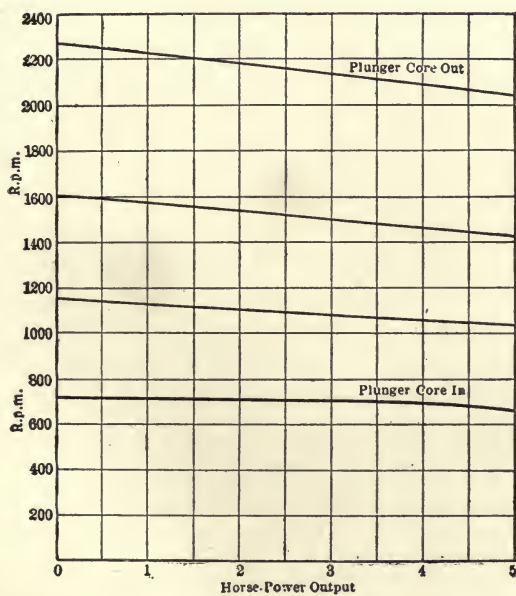

FIG. 31. — SPEED-LOAD CURVES OF 4-H.P. STOW MOTOR.

as represented in Fig. 29.* When the plungers are withdrawn, the total flux decreases because of the lengthening and reduction of area of the effective air-gap, also the decrease of effective metal in the field cores. The flux being now along the polar edges (in varying degree according to the position of the plungers), the field for commutation is maintained relatively strong, and sparking thereby prevented. The concentration of flux at the polar edges is well shown by the flux-distribution curves (Fig. 33) of this machine. On the other hand these curves also show that armature reaction forces the commutation fringe back, at the higher speeds and loads; consequently, to maintain sparkless commutation at the 3 to 1 range of speed, the brushes must be given a lag. This requires the brushes to be shifted if the direction of rotation is reversed, or if the speed range is greater than 3 to 1. It is a fact, however, that since metal is removed the effect of armature reaction for a given current is reduced because the reluctance of the path of the armature flux is increased. The data of a 3 to 1 adjustable-speed 4-h.p. motor of this Stow type are as follows:

Rated pressure, 220 volts.

Armature current at rated output of 4 h.p., 16.75 to 17.0 amperes, increasing with speed.

Field current constant at .64 ampere.

No-load armature current, 1.3 to 2.2 amperes, increasing with speed.

Field resistance, "hot," 344 ohms.

Speed, 725 r.p.m. min. to 2175 r.p.m. max.

Weight, 800 pounds.

The operation of this machine under various loads and speeds is shown in the curves, Figs. 30, 31, 32, and 33, which represent, respectively, magnetization, speed-load relations, efficiency, and flux distribution. A study of the speed-load curves indicates that the speed regulation at the higher rates of rotation is not as good as that with the stronger fields. This is due to the fact that invisible sparking at the brushes and poorer brush contact increase the $I_a R_a$ drop, just as in the types (a) and (b) adjustable-speed motors which are controlled by variation of field current. The most efficient operating speed of this motor is at the second plunger adjustment, which gives 1090 r.p.m.

* U. S. Patents Nos. 666,315 and 672,419, January and April, 1901.

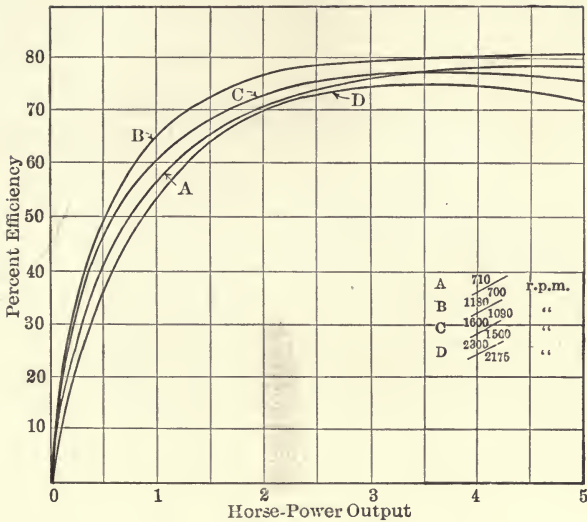

FIG. 32. — EFFICIENCY CURVES OF 4-H.P. STOW MOTOR.

A 710 r.p.m. at rated load.
 B 1090 r.p.m. at rated load.
 C 1490 r.p.m. at rated load.
 D 2130 r.p.m. at rated load.

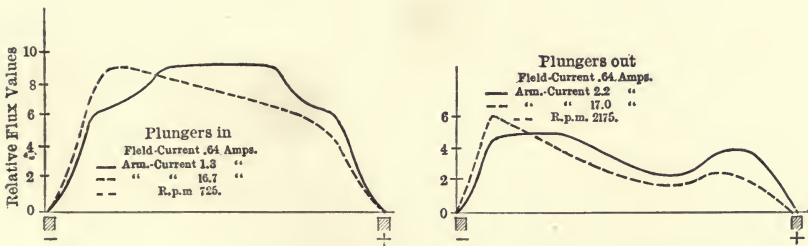

FIG. 33. — FLUX DISTRIBUTION CURVES OF 4-H.P. STOW MOTOR.

The Lincoln Adjustable-speed Motor. — The variation in reluctance of the magnetic circuit of this type* is obtained both by lengthening the air-gap and by decreasing its effective area. The armature is formed as a truncated cone with corresponding polar

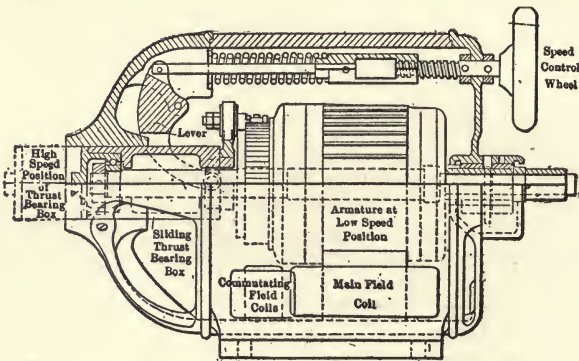

FIG. 34. — LINCOLN ADJUSTABLE-SPEED MOTOR.

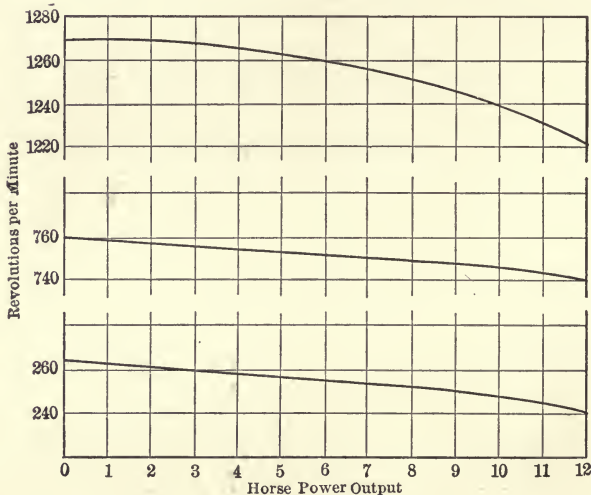

FIG. 35. — SPEED-LOAD CURVES OF 10-H.P. LINCOLN MOTOR.

surfaces as represented in Fig. 34. The armature is movable in the direction of its axis, so that movement one way increases the length of the air-gap, thus decreasing the flux and raising the motor speed. The fact that the effective length of the armature inductors

* U. S. Patent No. 829,974, September, 1906.

within the magnetic field is decreased by this shifting of the armature also increases the motor speed.

The characteristic working curves of such a machine of 10 horse-power and 5 to 1 speed range are given in Figs. 35 and 36, being those of speed-load and efficiency at various loads, respectively. The principal objections to this construction are the extra space required for the armature and the large force required to move it.

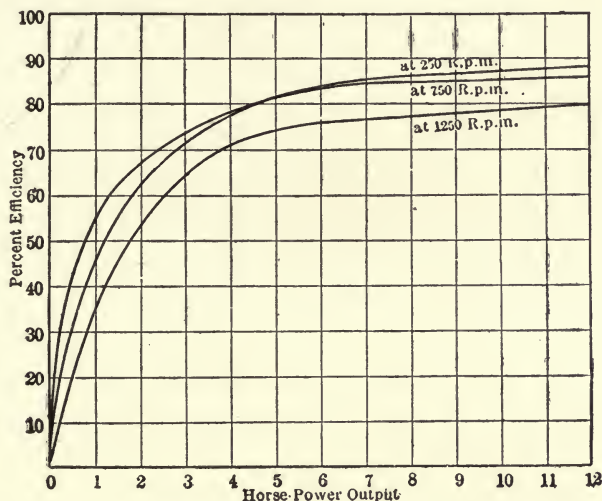

FIG. 36. — EFFICIENCY CURVES OF 10-H.P. LINCOLN MOTOR

The flux-distribution curves of the motors are similar to those of ordinary single-speed machines, the flux distortion at high speeds being limited on account of the increase of the air-gap lengths. However, to ensure sparkless operation at the high speeds, interpoles in series with the armature are employed in the more recent designs. It is to be noted that in this machine, as with types (c) and (d) motors having field-rheostat control, the speed regulation is better with weak than with the stronger magnetic fields, the variation in r.p.m. being 2.3 and 6 per cent respectively.

CHAPTER VIII.

MULTIPLE-VOLTAGE CONTROL OF MOTOR SPEED.

THE immediately preceding chapters were devoted to a consideration of the "field-weakening" methods of motor-speed adjustment. This chapter and the one that follows set forth the remaining methods of adjusting the speed of direct-current shunt motors. These differ from the foregoing in that they depend upon alteration of impressed voltage, and are therefore called *adjustable* or *multi-voltage* systems in contradistinction to the constant- or single-voltage systems already described. In other words, the speed adjustment is due to changes *external* to instead of *internal* with respect to the motor. These methods also differ from the preceding in the fact that they can produce a *constant torque* over the entire speed range (with the single exception noted below) in place of a *constant output* in horsepower. The general classification of these adjustable-voltage methods is as follows:

1. Armature rheostat — already described.
2. Multiple-voltage (multiple-wire) systems.
3. Motor-generator systems.
4. Boost and retard systems.
5. Teaser systems.
6. Double-armature motors.
7. Variation of number of poles in motor.

In the last two of the above cases, Nos. 6 and 7, the motor as a whole is supplied with constant voltage. Nevertheless the voltage available for each armature is varied in case 6, and the grouping of the armature conductors is altered in case 7 so as to change the c.e.m.f. developed; hence these two rather peculiar cases may be included in a general way under adjustable-voltage control. They also resemble the other five cases in the fact that field current and flux are usually maintained constant. The double-armature motors of case 6 do not exert constant torque, as in the other six cases, but produce constant output in horsepower like the field-weakening types already explained. It is also to be noted

that cases 2, 6 and 7 in the above list apply to *multi-speed* motors as defined by the A. I. E. E. Standardization Rules (Section E, paragraph 48, page 7) rather than to *adjustable-speed* machines, which latter include all those heretofore described.

In the discussion of the relation between speed and c.e.m.f. it was shown that, if other conditions remain constant, the speed varies directly as the c.e.m.f. If we now examine the equation $V = \text{c.e.m.f.} + (I_a R_a + D_b)$ it is evident if $I_a R_a$ and D_b are small with respect to the c.e.m.f. (as must be the case with an efficient motor) that increase in V will produce, at constant torque, a nearly proportional increase in c.e.m.f., that is, a variation of impressed e.m.f. produces a corresponding change in speed. This is the principle of the adjustable-voltage or multi-voltage systems of control.

Three-wire Multiple-voltage Systems. — The simplest multiple-voltage system is the ordinary three-wire circuit, with say 115 volts between either outer and the neutral conductor, and 230 volts between the outer conductors as represented in Fig. 37. Thus a 230-volt shunt motor connected so that its field winding is supplied with 230 volts and its armature with 115 volts develops a certain

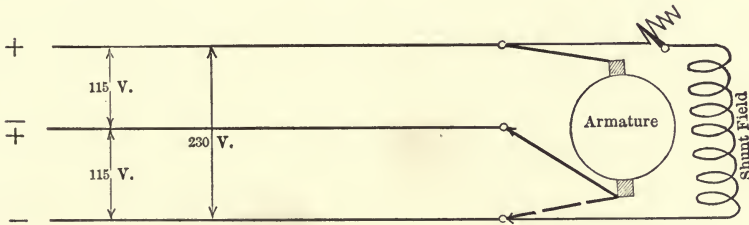

FIG. 37. — SIMPLE THREE-WIRE MULTIPLE-VOLTAGE SYSTEM.

speed. If the armature terminals are then connected to the 230-volt supply, the speed will be approximately twice as great. The two principal running points are nearly one-half and full speed, while those intermediate may be obtained by the introduction of armature rheostat or "field-weakening" control. Let us consider the 10-h.p. motor, the data of which were given on page 20. This machine has an armature resistance, hot, of .28 ohm; a brush drop of 1.4 volts and an armature current of 37 amperes at rated load.

Then $I_a R_a + D_b = .28 \times 37 + 1.4 = 11.8$ volts. With $V = 115$, the c.e.m.f. is $115 - 11.8 = 103.2$. With $V = 230$, the c.e.m.f. is $230 - 11.8 = 218.2$. Hence the speed ratio at these voltages is as $103.2 : 218.2$, or nearly a 1 to 2 speed change ($1 : 2.11$).

The objection to this method is that while three wires are necessary, only two running speeds are obtained. An additional speed can be secured from an unsymmetrical three-wire system, in which one of the sides has a voltage of x and the other side a voltage of $2x$; but even then only three running speeds corresponding to $x : 2x : 3x$ could be obtained with three wires. To gain a much wider speed range with only one-third greater number of wires, the four-wire systems were developed, and these will now be explained.

Ward Leonard Multiple-voltage Control of Speed. — The first of these four-wire methods, historically, is that of H. Ward Leonard,* who employed three generators of 62, 125 and 250 volts, respectively, and grouped them in series in the order named, as represented in Fig. 38. These voltages were supplied to the various motors by a four-wire system of distribution, connected to the three generators in the manner shown.

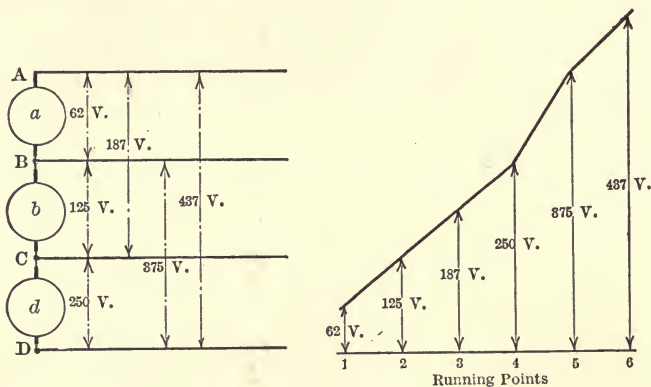

FIG. 38. — WARD LEONARD MULTIPLE-VOLTAGE SYSTEM.

The shunt-field windings of all the motors were supplied with a constant voltage, either the total amount obtained by connection with the outside wires A and D, or a smaller value, as, for example, that existing between the wires C and D. The armature terminals may be connected as desired to any two of the conductors A, B, C

* U. S. Patent No. 478,344, July, 1892.

and *D*; thus if applied to *A* and *B*, 62 volts would be obtained; across *B* and *C*, 125 volts; across *A* and *C*, 167 volts; across *C* and *D*, 250 volts; across *B* and *D*, 375 volts; and across *A* and *D*, 437 volts. Taking the speed at the highest voltage as the full or rated value, the various running points would give speeds of approximately $\frac{1}{7}$, $\frac{2}{7}$, $\frac{3}{7}$, $\frac{4}{7}$, $\frac{6}{7}$, and $\frac{7}{7}$, a sudden jump in the voltage increment occurring at the fifth point. The $\frac{5}{7}$ speed value, or that corresponding to 312 volts, could not be obtained, because to get this voltage *AB* would have to be added directly to voltage *CD*, which would short-circuit the voltage *BC*.

Crocker-Wheeler System. — The next four-wire multiple-voltage system developed was that of the Crocker-Wheeler Company, employing voltages of 40, 120 and 80 in the order given. (Fig. 39.) By connecting the field terminals across the 240-volt lines (*AD*) and shifting the armature terminals from *AB* to *CD*, to *BC*, to

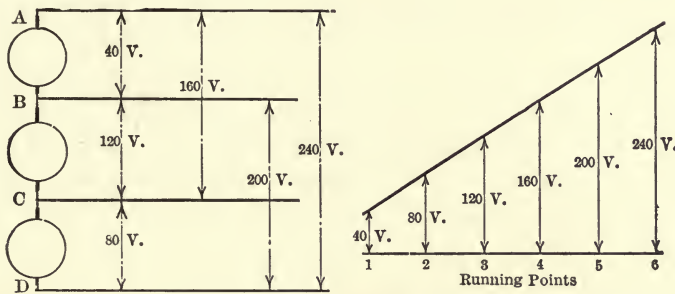

FIG. 39. — CROCKER-WHEELER MULTIPLE-VOLTAGE SYSTEM.

AC, to *BD*, and finally to *AD*, six voltages and speeds are obtained as follows:

<i>AB</i> gives	40 volts	<i>AC</i> gives	160 volts
<i>CD</i> "	80 "	<i>BD</i> "	200 "
<i>BC</i> "	120 "	<i>AD</i> "	240 "

These voltages correspond approximately to $\frac{1}{6}$, $\frac{2}{6}$, $\frac{3}{6}$, $\frac{4}{6}$, $\frac{5}{6}$ and $\frac{6}{6}$ of the rated speed. Thus, with this system, the speeds increase in a straight line, or in an *arithmetical progression*, there being no jumps, but a uniform rise throughout. The actual speeds are from 106 to 862 r.p.m., giving a range of a little more than 1 to 8, as shown in the table of "Speeds and Efficiencies" on page 79.

Bullock Multiple-voltage System.— A third multiple-voltage method is that of the Bullock Company, Fig. 40, employing voltages which increase in *geometrical progression*; that is, the voltages are in the following ratio: $a : ar : ar^2 : ar^3 : ar^4 : ar^5$. As these values must all be obtained in practice from a single system consisting of only four conductors, it is necessary that $ar^3 = a + ar$, that $ar^4 = ar + ar^2$ and that $ar^5 = ar^2 + ar^3 = a + ar + ar^2$.

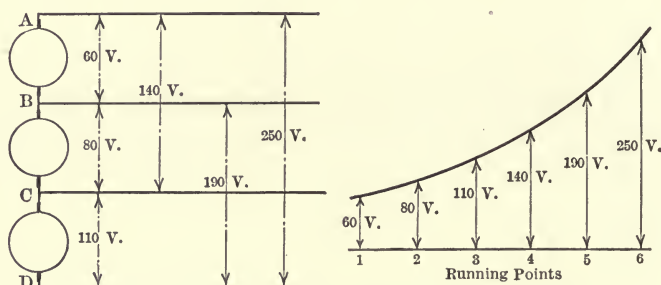

FIG. 40. — BULLOCK MULTIPLE-VOLTAGE SYSTEM.

The only factor r which satisfies these conditions is 1.3247; that is, each voltage is $32\frac{1}{2}$ per cent, or about one-third, higher than the preceding. The commercial system according to this plan employs 60, 80 and 110 volts in the order named. These are round numbers that are practically convenient, but are only approximately in the ratio stated, the theoretically correct values being 60, 79.5 and 105.3 volts. The armature voltages and speeds obtained by connecting the armature terminals of the typical 10-horsepower motor to the various conductors are given in the following table. The speed is proportional to c.e.m.f.; that is, r.p.m. = (c.e.m.f. \div 218.2) \times 825, the two latter being *rated* values.

TABLE VII. — SPEED CONTROL OF 10-H.P. MOTOR BY BULLOCK MULTIPLE-VOLTAGE METHOD.

Terminal Volts.	$I_a R_a + D_b$.	C.E.M.F.	Speed in R.P.M.
60	11.8	48.2	182
80	11.8	68.2	258
110	11.8	98.2	374
140	11.8	128.2	485
190	11.8	178.2	673
250	11.8	238.2	900

The Crocker-Wheeler method gives a speed range which is about 1 to 8, as stated above, while the Bullock arrangement gives a speed range of exactly 1 to 5, the total number of controller steps being the same for both. The range of voltage is 40 to 240 in the former and 50 to 250 in the latter. Hence the former starts at a lower speed of 106 r.p.m. instead of 182 r.p.m., and finally reaches about same maximum of 862 compared with 900 r.p.m.

Multiple-voltage systems may be worked at *any* reasonable maximum; they differ only in the *ratio of voltages*. It is desirable, however, to have *standard values for at least the maximum voltage and one of the sub-voltages*, in order that standard motors, lamps, etc., may be fed from the lines.

The efficiency of multiple-voltage speed control is much higher than that of the armature rheostat method for same torque and speed range. Let us consider the typical 10-h.p. motor, the data of which were given in the table on p. 20, and determine its efficiency at rated torque and the various speeds obtained by the Crocker-Wheeler multiple-voltage system.

The various speeds at rated torque corresponding to impressed voltages of 40, 80, 120, 160, 200 and 240, respectively, are determined as in the case of the Bullock system above. The input in watts in each case is found by multiplying the voltage input by the rated armature current ($I_a = 37$ amperes) and adding 230 watts, which is the normal field input of this typical 10-h.p. motor.

TABLE VIII.—SPEEDS AND EFFICIENCIES OF 10-H. P. MOTOR WITH CROCKER-WHEELER MULTIPLE-VOLTAGE CONTROL.

Voltage Input.	Input. Watts.	$(I_a R_a + D_0)$ Volts.	C.e.m.f. Volts.	R.p.m.	Output	Efficiency at Rated Torque.
					$7570 \times \text{r.p.m.} \div 825$ Watts.	
40	1710	11.8	28.2	106.	971	56.6%
80	3190	11.8	68.2	258.	2370	74.2
120	4670	11.8	108.2	409.	3750	80.1
160	6150	11.8	148.2	560.	5150	83.5
200	7630	11.8	188.2	711.	6530	85.6
240	9110	11.8	228.2	862.	7920	86.7

Comparing the efficiency curve (Fig. 41) of the multiple-voltage method of speed control with that of the armature rheostat method

at rated torque, Fig. 4, the much higher *average efficiency* of the former method is very marked. An even greater advantage of this method over the rheostatic control is its *far better speed regulation* under variable loads. The curves in Fig. 42 and values in the following table show this superiority very clearly. The r.p.m. at rated torque are from table above, and r.p.m. at no load are 39 r.p.m.

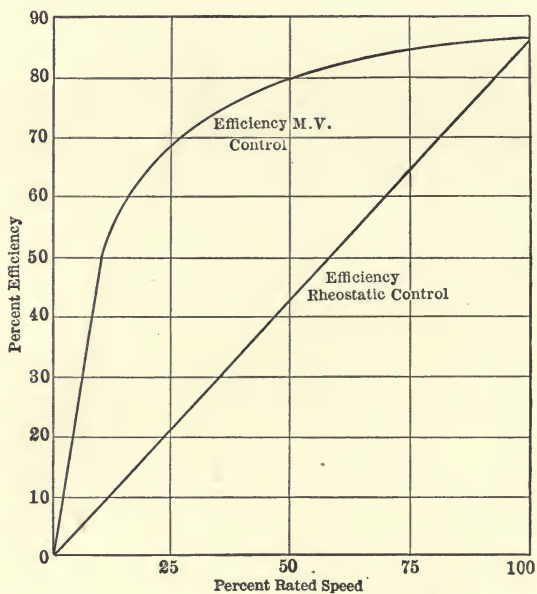

FIG. 41. — COMPARATIVE EFFICIENCIES OF RHEOSTATIC AND MULTIPLE-VOLTAGE SYSTEMS.

higher in each case for multiple voltage, because armature current is reduced from 37 to 2.3 amperes, which decreases armature drop $34.7 \times .28 = 9.7$ volts, and brush drop is .84 instead of 1.4 volts. The c.e.m.f. must rise therefore $9.7 + .6 = 10.3$ volts, producing a speed increase of $10.3 \div 218.2 \times 825 = 39$ r.p.m. The r.p.m. at no load for armature rheostat control are found as follows: The terminal pressure to give 106 r.p.m. at rated torque is 40 volts; hence $240 - 40 = 200$ volts must be consumed in rheostat, the resistance of which is $200 \div 37 = 5.4$ ohms. At no load c.e.m.f. $= 240 - 23 (.28 + 5.4) - .84 = 226.1$ volts. This corresponds to $226.1 \div 218.2 \times 285 = 854$ r.p.m. as given in Table IX.

TABLE IX.—SPEED REGULATION, 10-H. P. MOTOR.

Multi-Voltage Control, $V_{\max} = 240$ volts.			Rheostatic Control, $V_{\max} = 240$ volts.		
R.p.m. Rated Torque.	R.p.m. No Load.	Per Ct. Speed Change.	R.p.m. Rated Torque.	R.p.m. No Load.	Per Ct. Speed Change.
Curve A 106	145	13.7	Curve <i>a</i> 106	854	705
Curve B 258	296	11.5	Curve <i>b</i> 258	865	235
Curve C 409	447	9.2	Curve <i>c</i> 409	875	114
Curve D 560	599	7.0	Curve <i>d</i> 560	883	48.4
Curve E 711	750	5.2	Curve <i>e</i> 711	892	25.2
Curve F 862	900	4.6	Curve <i>f</i> 862	900	4.6

A direct and really fair comparison of efficiency between the field-control methods and the multiple-voltage control is impossible, since the motor with full rated field and armature currents runs at *minimum speed* and at or near its *maximum efficiency* in the former case

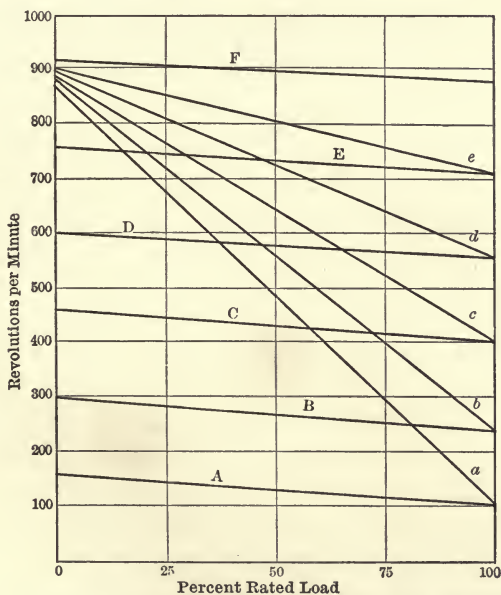

FIG. 42.—SPEED REGULATION OF RHEOSTATIC AND MULTIPLE-VOLTAGE SYSTEMS.

contrasted with *maximum speed and efficiency* in the latter case. The former attains the higher speeds by *field weakening*, while the latter obtains the *lower speeds* by *decreased voltage applied to the armature*. Furthermore, the first gives a *constant output* in horse-

power, the torque varying inversely with the speed; whereas the second can give full torque at all speeds, so that the horsepower output obtainable varies directly with the speed. Hence the two methods call for different types of motors and cannot properly be considered on the same basis.

A multiple-voltage system can be supplied by three generators of 40, 80 and 120 volts respectively, each large enough to carry its corresponding fraction of the maximum load. This does not, however, necessarily equal the combined watt capacity of the motors, as it is improbable that all machines will be simultaneously operating at full output. In fact the actual working load is not likely to exceed 30 to 50 per cent of the possible load. Instead of using the above combination of three generators, one generator of total voltage and load capacity and a three-unit balancing set (Fig. 43) of 40, 80 and

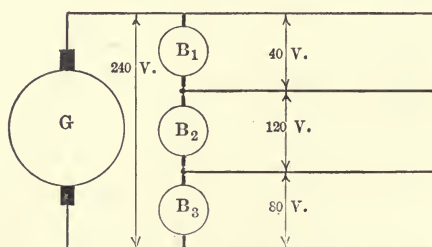

FIG. 43. — MULTIPLE-VOLTAGE SYSTEM WITH BALANCERS.

120 volts can be and usually is employed. These balancers, it has been found by experience, need have a total capacity of only 5 to 10 per cent of the total load in ordinary cases. If, however, there is one extremely large motor, while the rest of the plant consists only of small motors, the balancer set should have a capacity equal to that of this large motor. The balancer arrangement is the one usually adopted, as it is advantageous in the following respects:

- (a) Lower cost of prime movers, only one instead of either three engines or a system of line shafts, belts, etc.
- (b) Lower cost of generator, a large one in place of three smaller ones of same aggregate power.
- (c) Lower cost of foundations.
- (d) Less steam piping.
- (e) Cheaper switchboard and electrical connections.

The motors controlled by multiple voltage are ordinary standard

machines, which is an important practical advantage. They are so connected that the field is permanently across the 240-volt lines whenever the motor is in operation, and the six running speeds are obtained by shifting the armature terminals from sub-voltage to sub-voltage by means of the controller drum as shown in Fig. 44. In

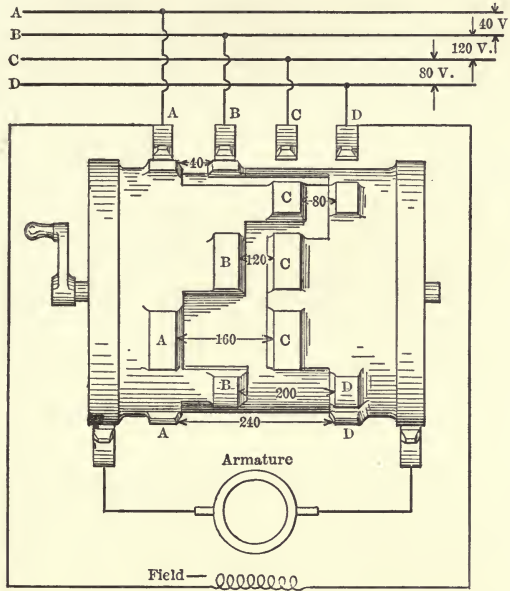

FIG. 44. — CONTROLLER AND MOTOR CONNECTIONS, MULTIPLE-VOLTAGE SYSTEM.

some cases the changes from one running speed to another are made gradually by shifting to the next higher voltage with some resistance inserted in the armature circuit and then gradually reducing this resistance until that voltage is applied to the armature terminals and so on with the various sub-voltages until the maximum pressure is attained. These gradual changes with intermediate speeds are also obtainable by diminishing the field current until the next higher speed is reached, then connecting the armature to the corresponding voltage, at the same time reestablishing full field current. Since the speed steps differ by only 10 or 15 per cent, the ordinary shunt motor is capable of this range of field weakening.

In some instances a combination of variable field current and armature rheostat control is employed in passing from one sub-voltage to another, thus obtaining as many as 36 different speed points from minimum to maximum.

The **Motor-Generator** and "**Boost and Retard**" Systems, both invented by H. Ward Leonard, are also multi-voltage or rather adjustable voltage methods of speed control, but the speed changes being gradual, no intermediate steps are required. In the case of the *motor-generator system*,* in addition to the working motor, a motor-dynamo is required for each machine so operated. The motor end (*M*) of the motor-dynamo is connected to the line or supply mains and controlled as any ordinary single-speed machine (Fig. 45). The generator terminals (*D*) are connected to the work-

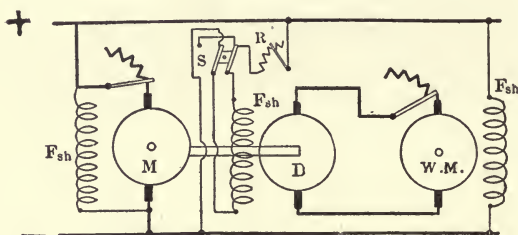

FIG. 45. — WARD LÉONARD MOTOR-GENERATOR SYSTEM OF CONTROL.

ing motor's armature (*WM*). Adjustable voltages and speeds are obtained by changes in the field strength of the generator, the field of which, as well as that of the working motor, being connected to the supply circuit. Reversal of rotation in this case is by means of a reversing switch (*S*) and rheostat (*R*) in the generator field circuit. By this method the reversal of voltage applied to the working motor is gradually accomplished, being first reduced to zero and then built up in the opposite direction. Furthermore the reversing switch *S* controls only a small field current instead of the armature current which would be 20 to 50 times greater, requiring large contact surfaces.

While this system is extremely flexible, it is not extensively employed on account of its great cost. The motor end of the motor-dynamo must be larger than the working motor by the amount of the losses in both the dynamo and working motor. For example, the 10-horsepower motor previously considered is of 86.6 per cent efficiency; hence to operate this machine at rated load, the input must be $10 \div .866$, or 11.6 horsepower. The efficiency of the dynamo is also about the same, so the motor end of the motor-dynamo must be

* U. S. Patent No. 463,802, November, 1891.

of $11.6 \div .866$, or 13.5 horsepower capacity. Thus three machines are required, each of a power equal to or somewhat greater than that needed for the actual work, the total rated capacity being $10 + 11.6 + 13.5 = 35.1$ horsepower.

The most extensive use of this method of speed control is for the operation of turrets and gun platforms in modern war-ships, for which very fine adjustment and yet wide range in speed are necessary. It is now used also for driving large rolls in steel mills, where in combination with a heavy flywheel it is known as the Ilgner system.

Both of the Ward Leonard methods and the "teaser" system, to be given later, involve motor-generator equipments. Their essential advantage is forcibly shown by the following example: To obtain 55.5 amperes at 17 volts, sufficient to develop a torque to start the standard 10-horsepower motor from rest under load, assuming 50 per cent increase in armature current above the rated value of 37 amperes, would require a motor-generator of 80 per cent efficiency to draw $55.5 \times 17 \div .8 = 944$ watts from the line, whereas to obtain the same starting torque directly from a 230-volt line by means of armature rheostat control would require 55.5×230 or 12.77 kilowatts, which is nearly 14 times as much power.

The "Boost and Retard" System* of Ward Leonard is very similar in principle to the preceding method but reduces somewhat its high cost by the following scheme. A motor-generator is also em-

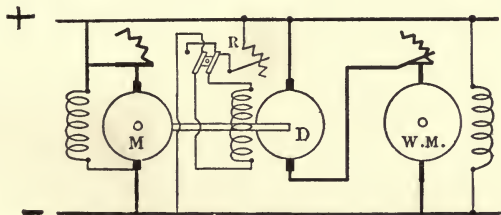

FIG. 46. — WARD LEONARD "BOOST AND RETARD" SYSTEM OF CONTROL.

ployed, but the generator end is placed in series with the line, so that its e.m.f. may be *added to* or *opposed to* the line pressure. This e.m.f. is controlled by variation of field resistance, and its direction by reversal of field connections. The operation of this system may be understood by referring to Fig. 46. To obtain the same speed range with

* U. S. Patent No. 572,903, December 8, 1896.

a 240-volt motor as with an ordinary multiple-voltage system, the line potential is only 120 volts, while the generator end *D* also develops 120 volts. Thus if both line and generator pressures are in series, the voltage *V* at the motor terminals will be 120 + 120 or 240. Decrease in value of *V* from 240 volts to 120 volts is obtained by weakening the field of the generator to zero, while a reduction of *V* below 120 volts is obtained by reversing the generator voltage and thus subtracting it from the line pressure. This is accomplished by arranging the field rheostat *F* to reverse the field connections, the current in the same having been, however, first gradually reduced practically to zero, in which manner the high voltage and spark accompanying the opening of a field circuit are eliminated. Since the voltage of the generator end is only one-half of that required by the working motor *WM* at rated speed, the watt-capacity of the "boost and retard" equipment need be only a little more than one-half that of the working motor, and accordingly the parts of the motor generator *MD* are 50 per cent smaller than in the preceding system.

The voltage and current relations existing between the units comprising the "boost and retard" system are as shown in Table X, and it should be noted that when the generator end of the *MD* set is "crushing" or "retarding" the line voltage, it has reversed its function and is acting as a motor driving what was previously the motor end as a generator, which then pumps back into the supply line, thus furnishing part of the current required by the working motor. For example, to run the working motor at one-quarter speed or 206 r.p.m. requires $11.8 + (218.2 \div 4) = 66.3$ volts, that is, armature and brush drop plus one-quarter of rated c.e.m.f. Hence the machine *D* must generate - 48.7, which, combined with 115, the line voltage, produces the required 66.3 volts for the working motor. The machine *D*, thus developing a c.e.m.f. of - 48.7 volts, is therefore running as a motor, consuming $48.7 \times 37 = 1802$ watts. Assuming the combined efficiency of the machines *D* and *M* as 80 per cent, the latter will generate $.80 \times 1802 = 1442$ watts at 115 volts, since it is connected to the supply lines. Hence it furnishes $1442 \div 115 = 12.6$ amperes and the supply circuit 24.4 amperes to make up the 37 amperes consumed by the working motor. The other values in Table X are calculated in a similar manner. For small currents the efficiency of *D* and *M* might be less than 80 per

cent, but the difference would be of little practical consequence. It is to be noted that this "boost and retard" method as well as the preceding "motor-generator" arrangement gives full rated torque with usual overload capacity at all speeds of the working motor, so that its horsepower output increases directly with its speed.

TABLE X.—BOOST AND RETARD EQUIPMENT — VOLTAGE AND CURRENT RELATIONS.

Working Motor.			Motor-Dynamo.				Supply Line.	
Speed R.p.m.	Volts.	Amp.	Dynamo End.		Motor End.		Volts.	Amp.
			Volts.	Amp.	Volts.	Amp.		
0	11.8	37	-103.2	+37	115	26.5	115	10.5
206	66.3	37	-48.7	37	115	12.6	115	24.4
412	120.8	37	5.8	37	115	-2.3	115	39.3
618	175.3	37	60.3	37	115	-23	115	60.0
825	230.0	37	115.0	37	115	-46.8	115	83.8

Examination of the table shows that this system of control is advantageous at speeds considerably below the rated value. For example, to start the working armature by supplying it with 11.8 volts consumes only 115 volts and 10.5 amperes or 1208 watts from the supply lines. To produce the same effect with a rheostat in the armature circuit would demand 230 volts and 37 amperes or 8510 watts, which is seven times as large an input. On the other hand, with this system at or near rated speed, the efficiency falls from 86.7 per cent for the individual motor to $\frac{7640}{115 \times 83.8} = 71.6$ per cent for the combination of the motor and motor-generator.

Bullock "Teaser" System. — This arrangement is designed especially for printing-press operation when the "inching" or slight forward movement of the press must be effected very accurately for "making ready," as it is called. While this could be accomplished by the two preceding multi-voltage methods, the cost of the equipment would be rather high, hence the development of this special method.

The apparatus and connections of the electrical units are as shown in Fig. 47. The "teaser" or motor-generator *MD* is of comparatively small capacity and its generator end generates a *low voltage*.

The operation is as follows: The motor-generator acts as a current transformer, to supply currents of considerable value at low voltage to the main motor for starting large presses, inching them forward or even running them for long periods at very low speeds. The speed of the working motor WM is gradually augmented by increas-

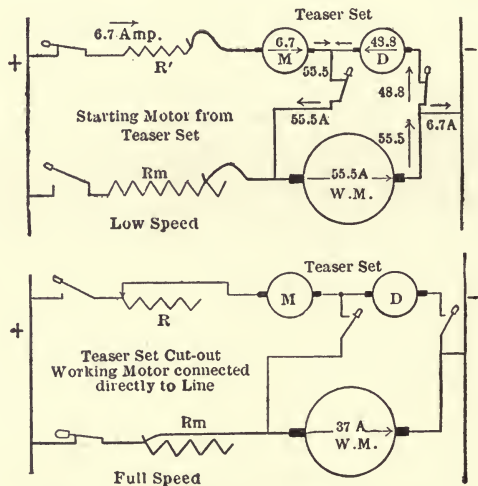

FIG. 47. — BULLOCK "TEASER" SYSTEM.

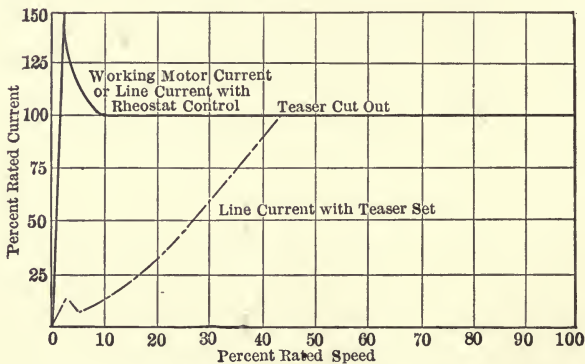

FIG. 48. — LINE CURRENTS, RHEOSTATIC AND "TEASER" CONTROL.

ing the speed and voltage of D by decreasing the value of the series resistance R or by field weakening of the motor end until the main motor WM is rotating at such a rate that it can be operated with comparative economy from the main line through the resistance R_m , at which instant the "teaser" is disconnected from the line and main

motor. The great economy of the teaser system over armature rheostat control is proved by the curves in Fig. 48, which represent the currents drawn from the line by the two methods when performing the same duty with the working motor. The dotted line compared with the solid line shows the reduction in line current with the teaser, the saving being more than 50 per cent up to about 30 per cent of rated speed. A little below half speed the teaser is cut out.

The conditions while starting the typical 10-horsepower motor are represented in the upper diagram of Fig. 47. The armature current of the working motor *WM* is assumed to be 55.5 amperes, which is 50 per cent above rated value, in order to overcome inertia and initial friction. Of this current 48.8 amperes are generated by the generator end *D* of the teaser, and 6.7 amperes are supplied through the motor, as indicated. Merely to start the motor demands 17 volts and 48.8 amperes or 830 watts from the machine *D*. Assuming 80 per cent efficiency for the motor-generator, the input of the motor end *M* must be $830 \div .8 = 1036$ watts. Hence the voltage consumed by it is $1036 \div 6.7 = 150$ volts and the drop in the series resistance *R* is $230 - (150 + 17) = 63$ volts, the amount of this resistance being $63 \div 6.7 = 9.4$ ohms, which is gradually decreased to raise the speed of the teaser and working motor. At starting only 230 volts and 6.7 amperes are drawn from the supply lines, instead of 230 volts and 55 amperes, which is more than eight times the power in watts.

When the teaser generator is of the simple shunt type, a sudden overload or sticking of the press rollers stalls the entire equipment, because the terminal volts of *D* fall too low to produce the current required. To overcome this difficulty the modification known as the Bullock Teaser Booster equipment has been developed. This is essentially like the preceding, but the generator end of the teaser is compound wound, so that any tendency to stall the working motor *WM* increases the current; thus the voltage of *D* and the motor torque are sufficiently augmented to carry it over the sticking point. With these teaser arrangements, the working motor may exert full torque at all speeds, so that its horsepower output increases with the latter as in the multiple-voltage or "boost and retard" systems.

Holmes-Clatworthy System. — This is similar to the teaser system in principle and is also applicable to the driving of printing presses, but the low speed for starting and inching purposes is

supplied from a special motor. The equipment comprises a main or working motor, a smaller auxiliary motor and a controller. In addition there is an electrically operated self-releasing clutch, situated between the two motors, by which the turning effort of the auxiliary motor is transmitted through worm gears to the press. The auxiliary motor is wound for such a speed that by means of the gearing it will drive the press for all purposes of starting up, inching, leading in, etc., and run it up to a sufficient speed so that the main motor may take the load advantageously. As soon as the main motor overspeeds the auxiliary one, the self-releasing clutch is automatically operated, and the latter machine is disconnected.

Double-armature Method. — This method of motor speed control is placed under the general head of multi-voltage or adjustable-voltage systems because even though the line voltage remains constant, adjustable speed is obtained by changing the voltage applied to a given armature winding, thus producing the same result as by altering line voltage. There are two general arrangements belonging to this class. The principle is the same for both, but with the first only two running speeds are obtained by connecting the armature windings either independently or in series, while in the second four speeds can be secured by changes in the manner of connecting the two armature windings to the circuit.

The first method (General Electric Company's,* and C. and C. Electric Company's systems) employs a motor with an ordinary field frame and winding which may be shunt or may be compound wound, but the armature core is provided with two windings and two commutators, which are alike in all respects. Thus if one armature winding be placed across the line a certain speed will be obtained. If both are placed across the line in series, the speed will be about one-half as great. This double-armature method is closely similar to the series-parallel control of railway motors. The successive steps in this method for the speed regulation of a compound-wound motor are as illustrated in Fig. 49.

An extension of the same principle is exemplified in the motor developed by the Commercial Electric Company, which employs one common field frame and winding (shunt or compound) and two independent armature windings, but instead of having these alike in

* U. S. Patent No. 757,394, April, 1904.

number of inductors, one of them has $2x$ inductors and the other $3x$ inductors; *i.e.*, one has 50 per cent more inductors in series than the other. Thus if the $2x$ winding be opposed to the $3x$ winding and connected in series to the line, only x inductors are effective in producing the c.e.m.f., hence the speed would be a maximum. If the

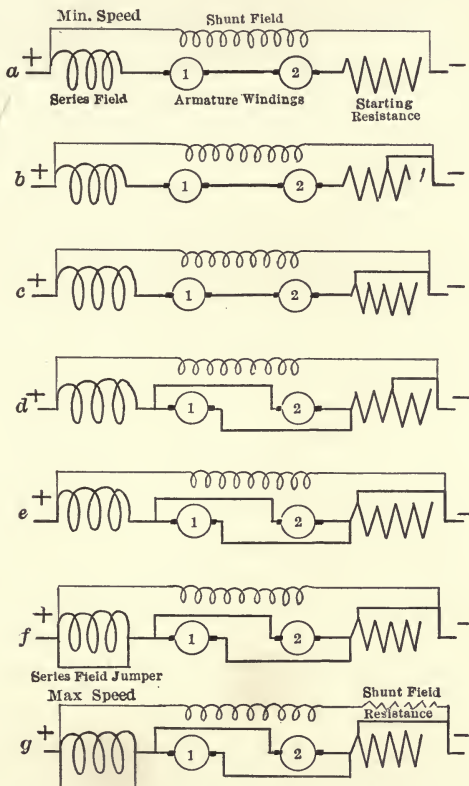

FIG. 49. — GENERAL ELECTRIC, DOUBLE-ARMATURE MOTOR CONTROL.

winding with $2x$ inductors were connected by itself to the line, a speed of one-half the maximum would be obtained. If the winding with $3x$ inductors were placed across the line, a speed of one-third the maximum would be obtained, while if both were placed in series across the line so that they generate e.m.f. in the same direction corresponding to $5x$ inductors, a speed of only one-fifth the maximum would be the result. The general connections for these steps are shown in Fig. 50. If used in combination with field or with rheo-

static control this method would give an extremely wide range; for example, a 6 to 1 field range would give a 30 to 1 speed range.

The series-parallel control, including ordinary railway motors, as well as the G. E. and C. and C. methods described above, gives *full rated torque* at all speeds unless the field is weakened, because both

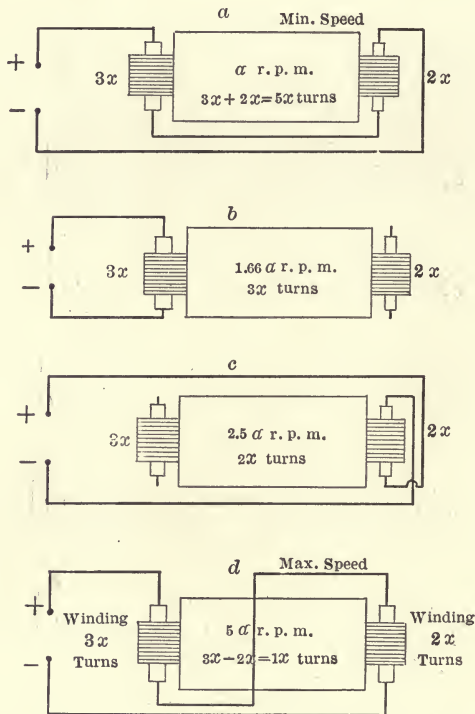

FIG. 50. — COMMERCIAL ELECTRIC COMPANY'S DOUBLE-ARMATURE METHOD OF MOTOR CONTROL.

armatures may carry full current, if desired. The Commercial Company's arrangement exerts only one-fifth torque at five times the speed, that is, *constant power* like field weakening.

Speed Control by Variation of Number of Poles. — The Bullock Company at one time manufactured a motor capable of giving various speeds by changing the number of poles. For example, consider a six-circuit armature with a six-pole field magnet. When the field coils are so connected that the ordinary relation of alternate north and south polarity exists, the number of armature circuits

(b) and the number of poles ($2p$) are each 6, hence from equation (2), the speed would be

$$\text{r.p.m.} = \frac{e 10^8 60 b}{n \Phi 2 p} = \frac{e 10^8 60}{n \Phi}$$

If, then, the connection of the field coils be changed so that three poles adjoining each other become S , and the other three N , we have with the same impressed voltage a speed in r.p.m. $= \frac{e 10^8 60}{n 3 \Phi}$ or $\frac{1}{3}x$ because the armature winding becomes a two-circuit one, the number of poles being two, while the flux per pole has increased to about 3ϕ provided the yoke and armature have sufficient cross section to carry the increased flux. Hence the speed in the second case would be only one-third of what it was in the first instance. The cost of this design is so great, due to larger frame, complex windings and switches, that it has not been commercially successful. For example, it would be necessary even in the smallest motors to have six poles in order to obtain a 3 to 1 speed range.

For further discussion of these various systems of shunt-motor control see the following publications:

- D. C. MOTOR SPEED REGULATION. J. W. Rogers. *Prac. Eng.*, London, 1907.
- DIE GLEICHSTROMMASCHINE. E. Arnold. Vol. II, p. 616, 1908.
- ELECTRIC JOURNAL, Vol. I, p. 251; Vol. II, pp. 11, 566; Vol. III, p. 348.
- ELECTRIC MOTORS. H. M. Hobart. 1904.
- ELECTRIC WORLD, Vol. XLIX, p. 947.
- ENGINEERING, September, 1905.
- LONDON ELECT., January 27, 1905.
- MOTOR CONTROL. *American Electrician*, Vol. XVI, 1904, p. 391; Vol. XVII, 1905, p. 303.
- MULTIPLE-VOLTAGE CONTROL, *Electric Power*, 1904.
- PROCEEDINGS ENG. SOCIETY WESTERN PA., October, 1905.
- SPEED CHARACTERISTICS AND CONTROL OF ELECTRIC MOTORS. C. F. Scott. *Eng. Mag.*, Vol. XXXI, p. 60, 1906.
- TRANSACTIONS A. I. E. E., Vol. XIII, p. 377, 1896; Vol. XX, pp. 111-197, 1902.
- ELECTRIC MOTORS IN MACHINE SHOP SERVICE. Chas. Day. *Trans. Internat. Elect. Congress*, Vol. I, 1904, p. 591.
- VARIABLE-SPEED CONTROL. *Eng. U. S. A.*, 1904.
- PUBLICATIONS CROCKER-WHEELER, BULLOCK, ELECTRO-DYNAMIC, GENERAL ELECTRIC AND WESTINGHOUSE COMPANIES.

CHAPTER IX.

DIRECT-CURRENT SERIES MOTORS.

As the name of this motor implies, the field and armature windings are in series, Fig. 51, hence the same current that flows through the armature also excites the field magnet.

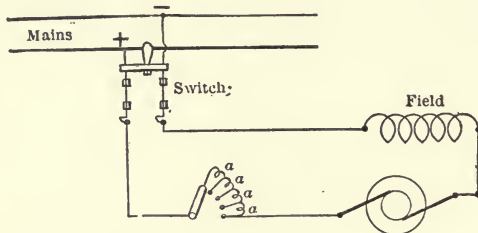

FIG. 51. — CONNECTIONS OF SERIES MOTOR.

Series motors are of two general types, constant potential and constant current. Attention will be paid chiefly to the former, since the latter are no longer used commercially. The greatest of all applications of the electric motor is to electric traction, for which purpose series motors are almost universally used in this country. It is natural, therefore, to discuss the action and control of series motors from the railway standpoint, although their application to hoists, fans, pumps, etc., is also important.

Speed-current Curve. — The speed of a series motor rises when the current is diminished, the exact relation depending upon the degree of magnetization of the magnetic circuit. At low current values, and therefore low flux densities, the speed is relatively high and the amount of its variation for a given change in torque is correspondingly great. The speed is much lower and more nearly constant when the field approaches saturation. The general formula for the speed of a motor as already given in equation (2) is

$$\text{r.p.m.} = \frac{E 10^8 60 b}{n \Phi_2 p} .$$

The flux Φ is the only variable and depends upon the field current, in the case of a series motor, being the same as or proportional to the armature current. The flux at low densities increases almost directly with the current, and if there were no voltage drop due to resistance, the *speed current curve* would take the form $n \times \Phi = \text{Constant}$, which is an equilateral hyperbola, asymptotic to both coördinate axes. However, as saturation of the magnetic circuit is approached there is a gradual reduction in the rate of increase of flux with current, so that the speed does not fall as rapidly, thus raising the right hand portion of the curve. Moreover, the resistance drops of the armature and field windings increase with the current, tending also to raise the same part of the curve. This relation between speed and amperes input is brought out numerically in the two following examples. The first assumes a series motor A with a field of relatively low flux density, and the second a series motor B of equal current capacity but having a field approaching saturation below rated load.

The series motor A is assumed to run on a 550-volt constant-potential circuit, its armature resistance being 0.7 ohm and field resistance of the same value. This motor, operated as a dynamo (separately excited) at a constant speed of 200 r.p.m., gives, in terms of voltage generated, the magnetization curve A in Fig. 52 with field-current variations from 0 to 50 amperes. Armature reaction may be practically neglected, being relatively small in series machines since the brushes are in the neutral position and because field m.m.f. rises with armature current and m.m.f. Brush drop is also a practically negligible item in most series motors which run at 550 volts or more in railway service and usually at voltages of 220 or higher for stationary work. Moreover, the field winding being in series with the armature, drop due to resistance is about twice as great as in a shunt machine of the same voltage, making brush drop relatively small, and it will be considered as included with the armature drop. (See Chapter III, pp. 16-19.)

The speed-current curve is calculated as follows:

At five amperes input the voltage drop due to armature and field resistance is $IR_a + IR_{se} = 5 (.7 + .7) = 7$ volts; hence the c.e.m.f. generated with 550 volts applied = $550 - 7 = 543$ volts. From Fig. 52, curve A, the field flux due to 5 amperes produces at 200 r.p.m. an e.m.f. of 56.5 volts; hence to develop a c.e.m.f. of 543 volts the

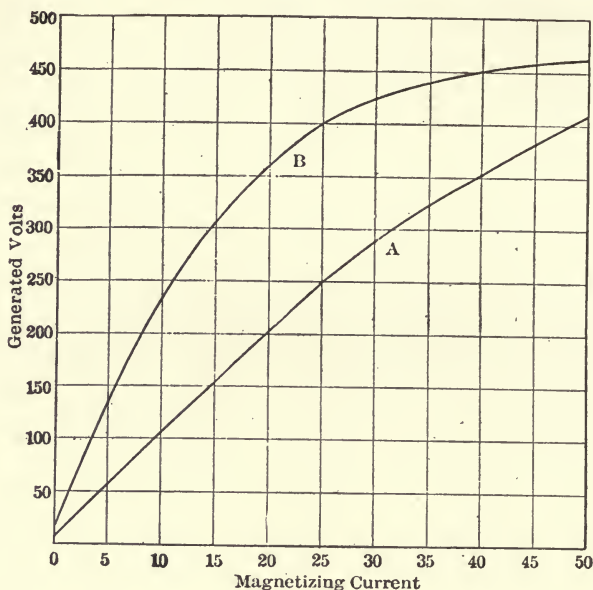

FIG. 52. — MAGNETIZATION CURVES OF SERIES MOTORS, A AND B.

r.p.m. = $(543 \div 56.5) \times 200 = 1920$. The speed at other torque conditions corresponding to 10, 20, 30, 40 and 50 amperes can be similarly calculated; the results being given in the following table.

TABLE XI.—CURRENT-SPEED DATA, SERIES MOTOR A (LOW FLUX DENSITY).

Amp.	A V.	B IR_a	C IR_{aa}	C.e.m.f. = $A - (B + C)$	Volts at 200 r.p.m. Curve A, Fig. 52.	R.p.m. = $\frac{200 \times \text{c.e.m.f.}}{\text{Volts at 200 r.p.m.}}$
5	550	3.5	3.5	543	56.5	$200 (543 \div 56.5) = 1920$
10	550	7.0	7.0	536	108.0	$200 (536 \div 108) = 1155$
20	550	14.0	14.0	522	200.0	$200 (522 \div 200) = 522$
30	550	21.0	21.0	508	283.0	$200 (508 \div 283) = 359$
40	550	28.0	28.0	494	350.0	$200 (494 \div 350) = 283$
50	550	35.0	35.0	480	412.0	$200 (480 \div 412) = 233$

Plotting these speed and current values in the form of a curve, *a*, Fig. 53, and comparing the various values, it is seen that the speed varies greatly with the current, the range being from 1920 to 233 r.p.m. with currents from 5 to 50 amperes.

In the case of series motor B, the armature and field resistance are 0.4 and 1.0 ohm respectively, and the magnetization-voltage curve of this machine operating at 200 r.p.m. with 5 to 50 amperes field current is curve *B*, Fig. 52, showing much higher flux densities than curve *A* of the first machine. The rated load current is 50 amperes and line pressure 550 volts, as in the case of motor A. The relations existing between current and speed can be calculated as in the preceding case, the results being given in Table XII.

TABLE XII.—CURRENT-SPEED DATA, SERIES MOTOR B (HIGH FLUX DENSITY).

Amp.	<i>A</i>	<i>B</i>	<i>C</i>	C.e.m.f. = <i>A</i> - (<i>B</i> + <i>C</i>)	Volts at 200 r.p.m. Curve <i>B</i> , Fig. 2.	R.p.m. = $\frac{200 \times \text{c.e.m.f.}}{\text{Volts at 200 r.p.m.}}$
	V.	IR_a	IR_{se}			
5	550	2	5	543	137	200 (543 ÷ 137) = 794
10	550	4	10	536	235	200 (536 ÷ 235) = 455
20	550	8	20	522	360	200 (522 ÷ 360) = 290
30	550	12	30	508	420	200 (508 ÷ 420) = 242
40	550	16	40	494	450	200 (494 ÷ 450) = 220
50	550	20	50	480	462	200 (480 ÷ 462) = 207

The effects of low and high magnetic flux densities upon speed of series motors at various loads are shown by comparing the two speed-current curves in Fig. 53. For motor B with high flux density the speed range is 794 to 207 r.p.m., or 3.84 : 1, while it is 1920 to 233 r.p.m., or 8.24 : 1 for motor A, which is more than twice as great as the variation in speed with the motor of high flux density, the current change being the same, that is, 5 to 50 amperes in both cases. The type of direct-current series motors commonly employed is that with the higher flux density on account of the greater economy of material and better operation under conditions of variation in the line voltage.

Comparing the speed curves of series and shunt motors, Fig. 54, it is apparent that the speed changes in series motors are due not only to $I(R_a + R_{se})$ effects but more especially (up to heavier loads) to increase in field strength. The IR_a drop is greater in series than in shunt motors of the same rating, because the former are usually designed for intermittent service, so that the current density in the field and armature windings can be made much higher than would be approved of in shunt machines, which are usually loaded more continuously.

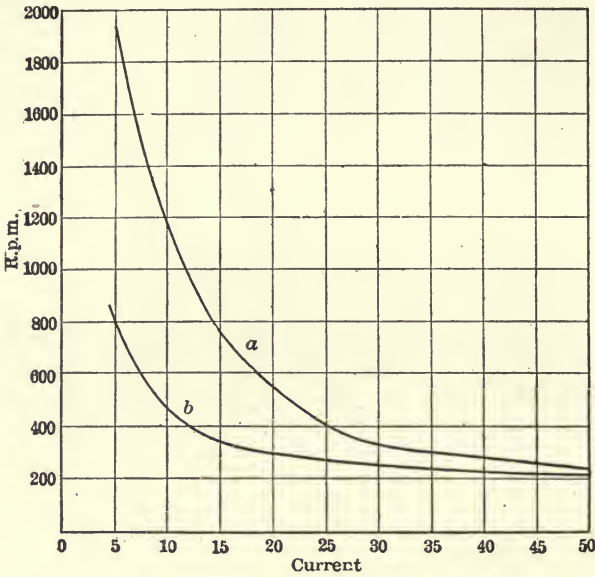

FIG. 53. — SPEED-CURRENT CURVES OF SERIES MOTORS, A AND B.

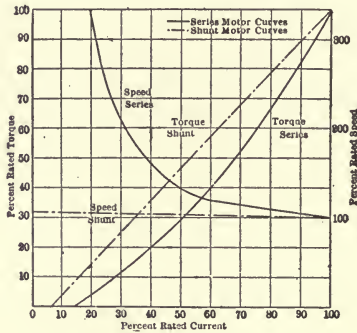

FIG. 54. — COMPARATIVE SPEED AND TORQUE CURVES OF 100-H.P. SERIES AND SHUNT MOTORS.

The speed for any given current, as already shown, depends upon the c.e.m.f. generated or upon $V - I (R_a + R_{se})$; hence the speed at any line voltage V_x is obtained from the equation

$$\text{r.p.m.}_x = \frac{V_x - I (R_a + R_{se})}{V - I (R_a + R_{se})} \text{r.p.m.}, \tag{11}$$

where r.p.m. and r.p.m._x are the speeds at the standard and fractional voltages respectively; V and V_x being these voltages while

$I(R_a + R_{se})$ is the resistance drop in the motor windings. When V_x is less than V , the speed corresponding to it is smaller than the ratio $\frac{\text{r.p.m. } V_x}{V}$, since the resistance drop is then a larger part of V_x than it is of V . Similarly when V_x is greater than V the reverse is true. When V_x is equal to $I(R_a + R_{se})$ the armature will stand still, exerting torque corresponding to I . For any increase in V_x above this value the speed rises proportionately.

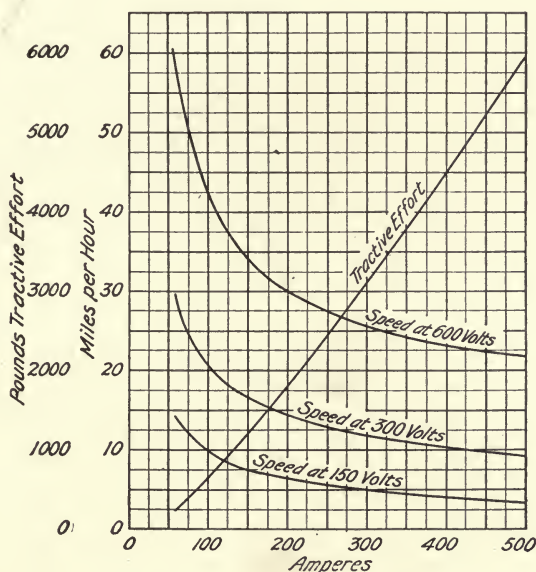

FIG. 55. — SPEED-CURRENT AND TRACTIVE EFFORT-CURRENT CURVES OF A SERIES MOTOR.

G. E. 69C Railway Motor. Gear Ratio, 1.885; Wheel Diam., 36 ins.; Resistance of windings, 0.14 ohms.

By means of the preceding speed-current equations, the corresponding curves (Fig. 55) of the typical 200-horsepower series railway motor (G. E. Type 69C, N. Y. C. "M. U." trains) at 150 and 300 volts have been calculated from the 600-volt curve given by the manufacturer.

Torque-current Curve. — The torque of any motor varies directly with the product of armature current and field flux. Hence in a series motor the torque at low flux densities varies directly as the square

of the current; that is, torque = KI^2 ; but as the magnetization approaches saturation the torque becomes more nearly proportional to the first power of the current.

The torque of a series motor is independent of the voltage except for variation in hysteresis, eddy-current, friction and windage losses resulting from the change in speed with the altered voltage. At low voltages and corresponding speeds, these losses are reduced and the available torque per ampere is similarly increased; at higher voltages the reverse is true. Since the hysteresis loss varies with the first power, and eddy-current loss as the square of speed, the difference in torque for any given current is greater between the 150 and 300 volt curves than that between the 300 and 600 volt curves. The percentage difference between torque values at any two voltages increases with the current on account of ratio of speeds at these voltages. Fig. 55 shows the torque-current curve for the typical 200-horsepower series motor at 600 volts, being approximately correct for 150 and 300 volts also, because the variation in the losses is small compared with the total torque.

The full-load value of motor current in the case of a railway equipment is generally employed as the starting current.

A comparison of the speed-current and the torque-current curves of a series motor (Fig. 55) shows that the maximum torque exists at the minimum speed. This is the *especially valuable* feature of the series motor, as maximum torque can thus be obtained at starting, with consequent rapid acceleration. Further study of these curves also brings out the *bad* feature of the series motor, namely, that very high, in fact dangerously high, speeds may be attained by the armature if the load be very much reduced. Series motors should, therefore, be either geared or directly connected to their load to prevent any breaking of the mechanical connection which is likely to occur with a belt.

The torque per ampere may be called the torque-efficiency of the motor. This varies with the current, but there is a gradual reduction in its rate of increase, because the magnetic circuit approaches saturation as the current becomes larger. The "torque per ampere-current" curve of a series motor, Fig. 56, is substantially the magnetization curve, because $T = K\Phi I$. $\therefore \frac{T}{I} = K\Phi$.

The torque per ampere curve in Fig. 56 gives the torque in terms

of pounds pull at 1 foot radius from motor shaft. This value is obtained by dividing the pounds tractive effort per ampere by the gear ratio and multiplying this quotient by the radius of the wheels in feet. For example, the torque per ampere at motor shaft with armature current of 300 amperes is $3120 \times 1.5 \div 300 \times 1.885 = 8.27$ pounds at a foot radius.

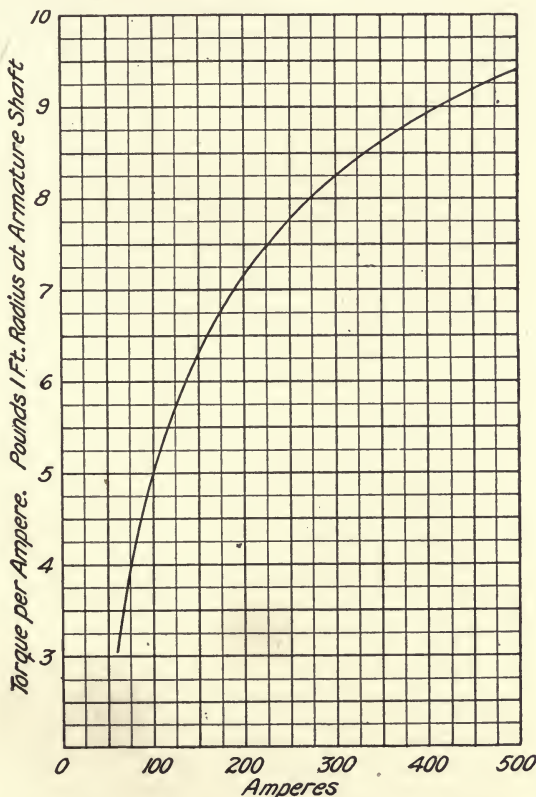

FIG. 56. — TORQUE PER AMPERE-CURRENT CURVE OF A G. E. 69c RAILWAY MOTOR.

A working value of the constant K can be obtained by determining the torque T at any reasonable current I and dividing this by the product of that current and the electromotive force corresponding thereto when the motor is operated as a separately excited dynamo at any given speed.

Horsepower-current Curves. — The output is readily calculated from the torque and speed, since torque is expressed as pounds pull at a one-foot radius. The output is derived as follows:

$$\text{h.p.} = \frac{2 \pi \text{ torque (r.p.m.)}}{33,000} = \frac{\text{torque (r.p.m.)}}{5250}. \quad (12)$$

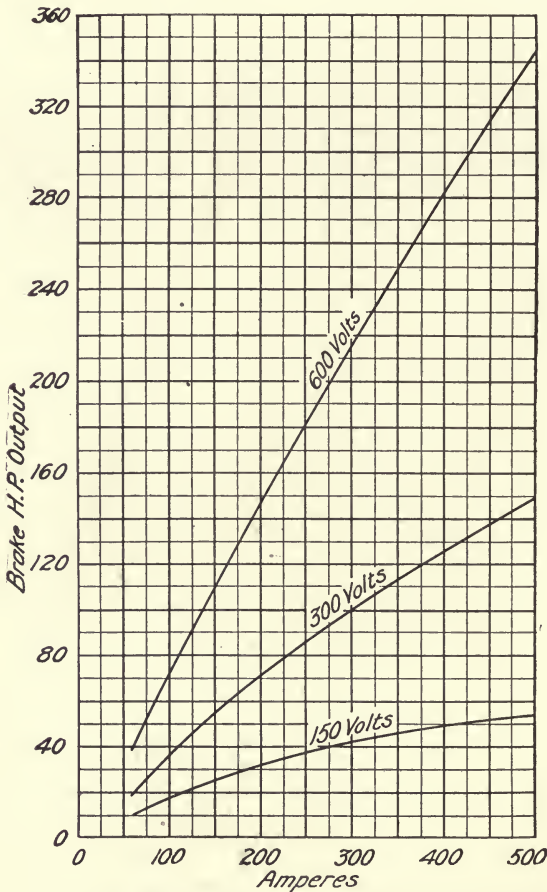

FIG. 57. — BRAKE HORSEPOWER-CURRENT CURVES OF A G. E. 69c RAILWAY MOTOR.

If the turning moment of the motor be expressed as *tractive effort* or *pounds pull at the rim of the car wheel* (t.e.) and the speed in miles per hour (m.p.h.), then the output is given by

$$\text{h.p.} = \frac{(\text{t.e.}) (\text{m.p.h.})}{375}. \quad (13)$$

The horsepower output for a given current varies almost proportionally with the voltage; thus at 150 and 300 volts the horsepower output is practically one-quarter and one-half, respectively, of the value at 600 volts. More exactly, the output at sub-voltages is a little less than the same fractional part of the output at 600 volts, since the percentage increase of torque at the reduced voltage is less than the corresponding decrease of speed. Fig. 57 shows the curves of *horsepower output and current* at 600, 300 and 150 volts for the 200-h.p. motor previously considered.

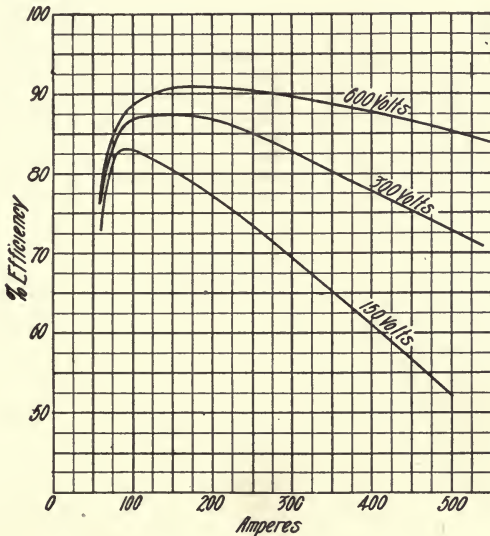

FIG. 58: — EFFICIENCY-CURRENT CURVES OF A G. E. 69C RAILWAY MOTOR (GEAR LOSSES INCLUDED).

Efficiency-current Curves. — The efficiency curves of this typical 200-h.p. series motor at 150, 300 and 600 volts in Fig. 58 show that the efficiency of such a motor at rated voltage is nearly constant over a very wide range of speed and load, but with very small or excessively large currents it falls to low values. At voltages less than normal, the efficiency is reduced, and this reduction is more marked as the voltage is lowered.

The efficiency at any load may be readily determined by any of the following formulæ:

$$\begin{aligned}
 \text{Efficiency} &= \frac{746 \text{ (h.p. output)}}{\text{watts input}} \\
 &= \frac{0.142 \text{ torque (r.p.m.)}}{\text{watts input}} \\
 &= \frac{1.99 \text{ (t.e.) (m.p.h.)}}{\text{watts input}}.
 \end{aligned}
 \tag{14}$$

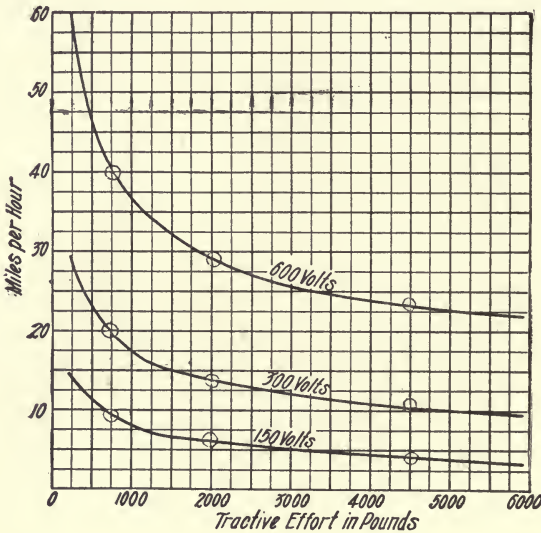

FIG. 59. — SPEED TRACTIVE EFFORT CURVES OF A G. E. 69C RAILWAY MOTOR.

Speed-Tractive Effort Curves.—This is the most important characteristic of a railway series motor in the determination of its fitness for a specified service. The speed-t.e. curves are similar in form to the speed-current curves, due to the fact that the t.e.-current curve is almost a straight line. The equation for the speed-tractive effort curve is of the form

$$\text{t.e.} = \frac{A}{\text{m.p.h.} + B} + C.
 \tag{15}$$

The constants change with the voltage, resistance and degree of magnetization of the magnetic circuit. Fig. 59 gives the speed-tractive effort curves of the typical 200-h.p. series motor at 150, 300 and 600 volts, the equations of which are:

$$\text{At 150 volts, t.e.} = \frac{12,800}{\text{m.p.h.} - 1.82} - 970.$$

$$\text{At 300 volts, t.e.} = \frac{25,300}{\text{m.p.h.} - 5.78} - 1050.$$

$$\text{At 600 volts, t.e.} = \frac{35,800}{\text{m.p.h.} - 16.43} - 740.$$

The insert points as shown in Fig. 59 are derived by calculation and agree very closely with the test values over a wide range of speed.

Gears and Wheels. — A railway motor is usually connected to the axle of the car drivers through a single pinion and gear, but in some cases the armature is directly mounted upon the axle of the car wheels. The speed and tractive effort at the rim of the driving wheels are respectively proportional and inversely proportional to the wheel diameter, while with gearing these two quantities are dependent upon the gear ratio, which is always designed to secure speed reduction. The proper ratio depends upon the type of service to be performed, but usually lies between 2 and 5, the lower value corresponding to high-speed service. The effect on tractive effort and speed of larger wheel diameter is exactly the reverse of that obtained by increasing the gear ratio.

The speed and tractive effort for any gear ratio and wheel diameter may be found for any other known conditions from the following formulæ, wherein m.p.h. and m.p.h._x are respectively the known and the unknown speeds, in miles per hour, for an existing gear ratio *r* and wheel diameter *D*. The gear ratio *r*_x and wheel diameter *D*_x correspond to the unknown speed (m.p.h._x). *T* is the torque for the known gear ratio, and *T*_x is the corresponding unknown value.

$$\text{m.p.h.}_x = \text{m.p.h.} \frac{rD_x}{Dr_x} = \frac{.003 \text{ (r.p.m.) } D}{r_x} = \frac{.003 \text{ (r.p.m.) } D_x}{r}. \quad (16)$$

$$T_x = T \frac{Dr_x}{rD_x}. \quad (17)$$

The characteristic curves of a standard Westinghouse railway motor with gear ratio of 22 : 62 are shown in Fig. 60. This has considerably smaller power than the typical General Electric machine to which the preceding curves relate, the maximum current being 200 amperes for the former and 500 for the latter.

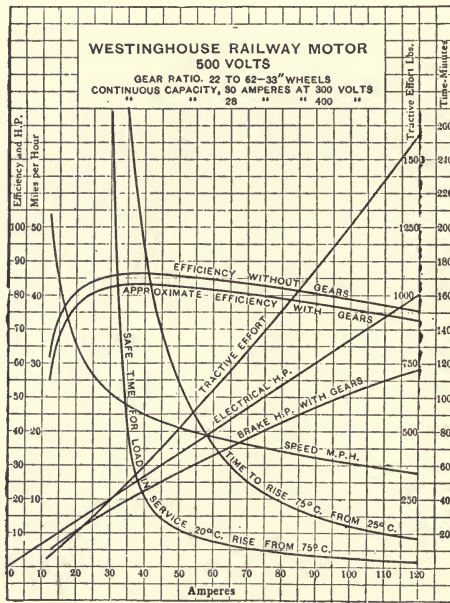

FIG. 60. — CHARACTERISTIC CURVES OF A TYPICAL RAILWAY MOTOR.

Motor Losses. — The rated output of a motor is determined by its commutation and heating limits; hence even a small reduction of the losses within the motor is of considerable importance. For example, assume the efficiency of a motor to be increased from 90 to 91 per cent, a difference of but 1 per cent, in which case the total loss within the motor is reduced from 10 to 9 per cent, resulting in a decrease of 10 per cent in the heat to be radiated and a probable lowering of the temperature rise by nearly 10 per cent. Thus it is seen that the rated output of a motor depends largely upon its efficiency. The permissible output is not, however, increased 10 per cent in the above example, because the heating effect is as the square of the current. For example, when current rises from 1.00 to 1.05, the heating effect is augmented from 1.00 to 1.1025. On the other hand, the I^2R heat

is only about one-half of the total (including core losses), so that armature current and output may be raised say 7 per cent. The increased output due to rise in field current would not be great, because the flux usually approaches saturation at maximum current and may be assumed to be 1 or 2 per cent additional.

The distribution of the losses between field and armature is of wide variation. The following tables taken from a paper by W. B. Potter give values of the loss distribution of typical railway motors.*

TABLE XIII.—LOSSES AT RATED LOAD IN PER CENT OF OUTPUT.

Commercial Rating, h.p.	Field I^2R .	Armature.			Motor Total.
		I^2R .	Core.	Total.	
38	4.70	4.00	2.37	6.37	11.07
38	4.60	3.80	4.92	8.72	13.32
50	4.20	2.10	3.45	5.55	9.75
50	3.25	2.80	4.80	7.60	10.82
50	4.33	3.36	4.17	7.53	11.86
75	3.20	2.50	2.93	5.43	8.63
125	2.48	2.40	2.12	4.52	7.00

TABLE XIV.—SEGREGATED LOSSES AT RATED LOAD IN PER CENT OF TOTAL LOSSES.

Commercial Rating, h.p.	Field I^2R .	Armature.			Ratio Field Loss to Armature Loss.
		I^2R .	Core.	Total.	
38	42	36	22	58	.74
38	35	28	37	65	.53
50	43	22	35	57	.76
50	30	26	44	70	.43
50	37	28	35	63	.57
75	37	29	34	63	.59
125	36	34	30	64	.55

Rating.—There are two ratings by which railway motors are commercially classified. The nominal rating of the General Electric Company is the better known. This is defined as that output which

* Trans. Amer. Inst. Elect. Eng., Vol. XIX (1902), p. 170.

causes a temperature rise of 75 degrees C. from a room temperature of 25 degrees C. after an hour's run upon test stand with motor covers open and 500 volts at motor terminals. This rating is much in excess of the continuous service capacity of the motor, but it gives a convenient means of classification and is a severe test upon the mechanical qualities of the machine. In view of the tendency to use higher voltages, a test at 550 volts in place of 500 volts would probably more nearly approach service conditions at the present time.

The continuous rating used by the Westinghouse Company corresponds to that current which supplied continuously to the motor on a test stand will produce a temperature rise of 60 degrees C. The voltage selected is an approximation of the average value throughout the period of starting as well as running. No attempt is made to reproduce the conditions of ventilation that obtain in actual service.

The instantaneous capacity of a railway motor is limited by its commutation; nevertheless in well-designed car equipments the motor should be able to slip the wheels under normal track conditions before the commutation limit is reached.

The rating of railway motors must necessarily be largely arbitrary because of the intermittent character and very variable conditions of such service. The only conclusive test is actual operation under the practical conditions of each particular road, which a shop test can only approximate in a general way. It is well, however, to have some nominal rating, as defined above, in order to estimate and compare the performance of different railway motors.

CHAPTER X.

CONTROL OF DIRECT-CURRENT SERIES MOTOR.

Function of Controller. — For all series motors, with the possible exception of those operating small fans and pumps, a starting device is necessary to increase gradually the voltage applied to motor terminals. By this means the starting current and acceleration are regulated, while the heating and sparking of the motor are restricted within reasonable limits. Starting is accomplished by inserting proper values of resistance in series with the motor, usually supplemented by change from series to parallel connection of two or more motors.

Rheostat Control. — The simplest form of control, Fig. 51 (page 94), is by means of series rheostat or resistance (R) which is gradually reduced in predetermined steps until the motor terminals are connected directly across the full line voltage. This method is practically the same as the rheostat control of shunt motors, except that only the armature current is affected in the latter machine. The same objections apply, however, in both cases. These include bulkiness of rheostat, widely varying speed with any considerable change in torque and very low efficiency. For example, the loss by this control with uniform acceleration is practically one-half the total energy supplied by the line during the period of starting and thus equals the energy consumed in the motor. Moreover, the only efficient running speed is the full value.

Series-parallel Control. — Where two or more motors or two or more windings on the same armature are to be controlled simultaneously, certain groupings may be obtained by means of which a single motor or winding receives but a fraction of the line voltage without external resistance in circuit. Thus, two motors operating together may be connected in series with each other and in series with starting resistance, which is gradually reduced until each motor receives one-half line voltage. The motors may then be thrown in parallel with each other and in series with resistance, which is again cut out in steps until each motor receives full voltage. Thus

there are two points of the control at which no resistance is in circuit. The total energy loss during the period from starting to full parallel operation is approximately one-third of the line supply or one-half of the motor consumption.

The speed of the motors when operated in series is about one-half that with the parallel connection. This series-parallel control is the method generally adopted for single cars and for multiple unit trains

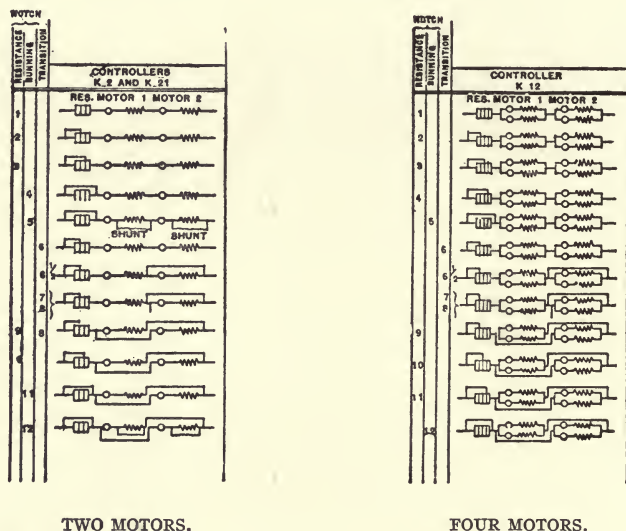

FIGS. 61 AND 62. — CONNECTIONS OF SERIES-PARALLEL CONTROL FOR TWO AND FOUR MOTOR EQUIPMENTS.

whenever two or more motors are operated simultaneously. The various steps of this method of control are diagrammatically illustrated in Figs. 61 and 62, which are respectively for two and four motor equipments.

Series, Series-parallel, Parallel Control. — When the equipment consists of four motors, it is a common arrangement, especially for electric locomotives, to employ three groupings of motors in starting them, as illustrated in Fig. 63. At first the four motors are all in series (*A*), then two groups, each consisting of two motors in series, are connected in parallel (*B*), while finally the four motors are placed in multiple (*C*). During the first few steps of each combination, series resistance is gradually cut out of the circuit. This method secures higher efficiency than the others but

necessitates more car wiring than either the simple rheostatic or series-parallel control. The energy loss with this method of control during the period of acceleration is about $\frac{3}{11}$ of the total supply, or about $\frac{3}{8}$ of the motor consumption. The three efficient running points are as shown in Fig. 63, and they correspond approximately to one-quarter, one-half and full speed.

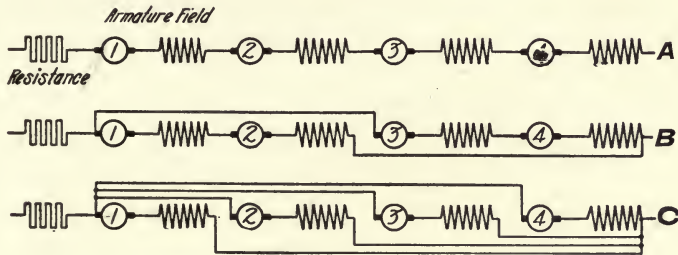

FIG. 63. — RESISTANCE CONNECTIONS OF THE THREE RUNNING POINTS OF THE SERIES, SERIES-PARALLEL, PARALLEL METHOD OF CONTROL.

Field Control. — During the early development of electric traction it was customary to increase speeds after the efficient running points (without external resistance) had been reached by shunting some of the field winding or by arranging the field coils in parallel combinations (field commutation). The resulting weakening of the field, however, led to objectionable sparking at the brushes, and this means of control for railway motors was discarded. The introduction of *interpoles* or commutating poles, which maintain a commutating flux independent of the condition of the main field, but proportional to the armature current, has revived the use of field control for high-speed railway motors.

The performance curves of a 35-horsepower series motor controlled in this manner are given in Fig. 64, while Fig. 65 illustrates the various steps of such a method of speed regulation.*

The control is by series-parallel connection supplemented by the increase of speed obtainable with field weakening. After starting with resistance in the ordinary way, the machines are brought into the series running condition (No. 5) with full-speed strength. Higher speeds are attained by combining the four field coils of each motor in partial series-parallel (No. 6), then in series-parallel (No.

* Article by G. H. Condit, *Electrical World*, Vol. XLVII, 1906, p. 1088.

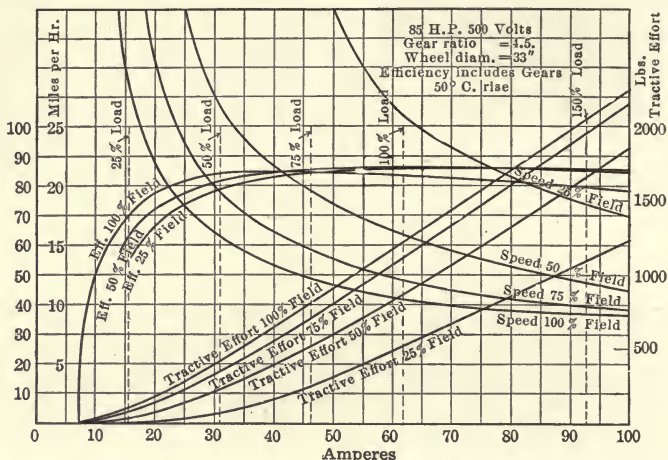

FIG. 64. — CURVES OF 35-H.P. E. D. CO. SERIES MOTOR WITH FIELD CONTROL.

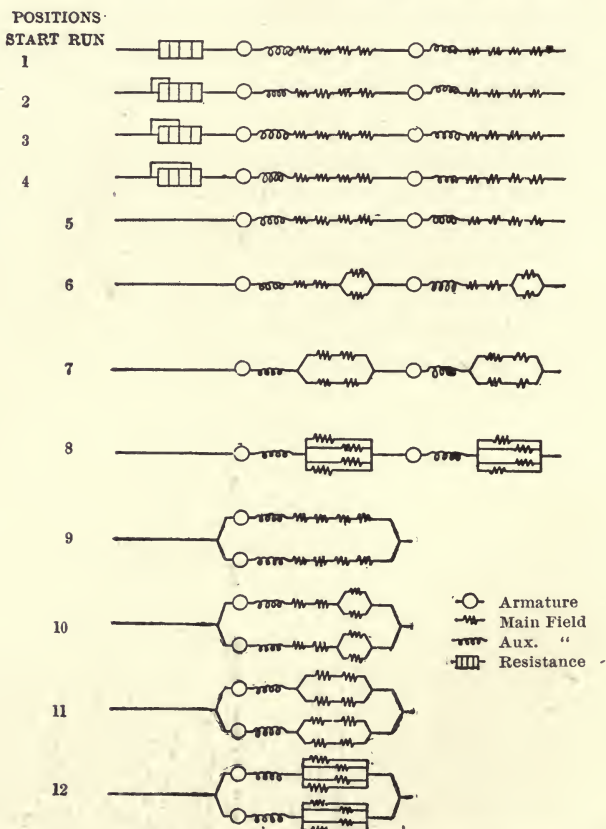

FIG. 65. — CONNECTIONS FOR FIELD CONTROL OF SERIES MOTORS.

7) and finally in parallel (No. 8), thus securing four field strengths for any given armature current. The speed rises as the field current is weakened but not in equal degree. Similar combinations of the field coils are employed with the parallel grouping of the motors. Thus by this method of control eight efficient running points are obtained with a two-motor equipment.

The speed range at rated load, or even at any intermediate load, is not, however, 8 to 1, because the field strength does not change directly with the m.m.f., the magnetic circuit being partially saturated.

It is apparent from the characteristic curves of this equipment (Fig. 64) that the speed with armature and field windings of both motors all in series, at full field strength and at rated load, is about 5.2 miles per hour, while with the two motors in parallel and all field coils in parallel (weakest field condition No. 12) the speed is about 26 miles per hour, a range of 5 to 1. This is a large gain over the ordinary series-parallel arrangement, which gives about 2 to 1 range of speed.

Drum and Master Controller.— For the smaller series motors such as are used for ordinary cars, hoists, pumps, fans, etc., the power circuits are made and broken in the controller by means of stationary fingers and movable contacts mounted upon a drum or cylinder. Where large currents are required, the circuits are made and interrupted by separate switches, called contactors, which are controlled electrically from a master controller and operated by a pneumatic or solenoid device. This latter form of control is almost always used where several cars are to be operated together, and from any car irrespective of sequence. The control circuits are made continuous from the first to the last coach by means of a train line and “jumpers.”

Hand and Automatic Starting.— The rate of acceleration in starting depends upon how rapidly the operator moves his controller handle from the first to the last notch. Some recent types either prevent the operator from passing to the next point until the current has decreased to a certain value, or cause the controller to move (“notch up”) automatically at the proper rate to a point predetermined by the operator.

The efficiency of control methods may be easily calculated, assuming that the current per motor is maintained constant by a gradual increase in voltage at the motor terminals. This is the ideal condi-

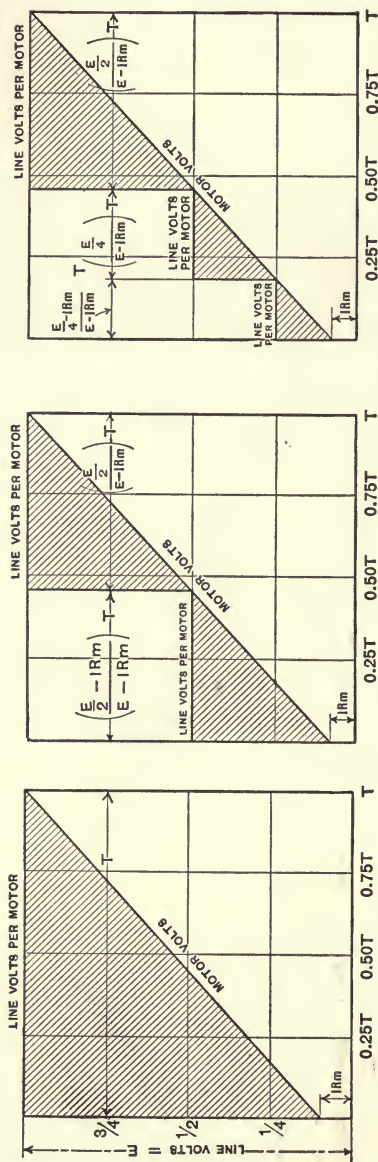

Rheostatic Control

Control Loss per Motor $\frac{E - I R_m}{2} IT$

Supply per Motor EIT

Consumption per Motor $\frac{E + I R_m}{2} IT$

Control Efficiency $0.5 + \frac{I R_m}{2E}$

Series-Parallel Control

$\left(\frac{E}{2} - I R_m\right)^2 + \left(\frac{E}{2}\right)^2$

$\frac{E(3E - I R_m)}{2} - I R_m IT$

$\frac{E + I R_m}{2} IT$

$\frac{E^2 - I^2 R_m^2}{E\left(\frac{3E}{2} - I R_m\right)}$

Series-Parallel, Parallel Control

$\left(\frac{E}{4} - I R_m\right)^2 + 5\left(\frac{E}{4}\right)^2$

$\frac{E(11E - I R_m)}{4} - I R_m IT$

$\frac{E + I R_m}{2} IT$

$\frac{E^2 - I^2 R_m^2}{E\left(\frac{11E}{4} - I R_m\right)}$

FIGS. 66, 67 AND 68. — DIAGRAMMATIC METHOD OF COMPARING LOSSES IN METHODS OF SERIES MOTOR CONTROL.

tion because it secures uniform acceleration and is closely approximated in practice with automatic starting. A comparison of the three methods of control described above is set forth in Figs. 66, 67 and 68. In these and the formulas accompanying them I is the current per motor, R_m is the resistance, E is line voltage and T the time from start to full speed (period of acceleration). It should be noted that the assumption made in developing these diagrams is that the time during which the motors are in series bears the same relation to the total time of starting as $\left(\frac{E}{2} - IR_m\right)$ bears to $(E - IR_m)$.

The shaded portion of the diagrams represents the losses during the period of starting with uniform acceleration by each of the three methods.

The following values are taken from a case in actual practice and the table below is calculated from them.

Line pressure = $E = 600$ volts.

Current per motor = $I = 250$ amps.

Motor resistance, $(R_a + R_{se}) = R_m = 0.14$ ohm.

Time occupied in starting = $T = 30$ sec.

Number of motors = 4.

COMPARISON OF DIFFERENT METHODS FOR STARTING SERIES MOTORS WITH UNIFORM ACCELERATION.

Items.	Rheostatic Control.	Series-parallel Control.	Series, Series-parallel, Parallel Control.
Supply for 4 Motors, kw.-sec	18000	13800	12900
Motor Consumption, kw.-sec	9500	9500	9500
Total Controller Loss, kw.-sec	8480	4240	3340
Relative Controller Losses	1.00	0.50	0.39
Relative Input to whole Equipment..	1.00	0.77	0.72
Total Efficiency	0.53	0.69	0.74

An examination of the results set forth in the above table brings out the great advantages of the series, series-parallel, parallel method of control, not only as regards the greater speed range, but also the higher efficiency of the equipment during the period of starting.

Constant-current Series Motors. — Although not used commercially at present, this type of machine is of such historical importance, and differs so radically from the constant-potential

motors now universally adopted, that it deserves some attention. Electric motors were first used in considerable numbers about 1886 or 1887. Then, and for some time afterward, there were constant-current arc lighting circuits in many smaller towns and in portions of large towns where constant-potential supply was not available. In such cases motors were operated on these circuits in series with arc lamps. The connections are represented

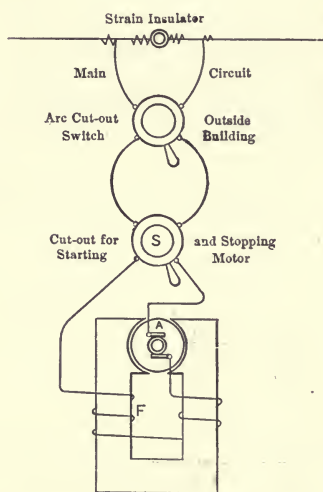

FIG. 69. — CONNECTIONS OF CONSTANT-CURRENT SERIES MOTOR.

in Fig. 69, A being the armature and F the field circuit of such a motor, the windings of which were designed to carry the constant current (usually 10 amperes) continuously. Hence, no starting box was required, the motor being introduced directly into the circuit by the cut-out switch S .

A plain series motor with constant current exerts constant torque (at full value), because $T = K\Phi I$ in which field flux Φ and armature current I are both constant. Unless the load happens to equal this torque some means for adjusting the motor torque to the load must be provided, otherwise the motor will either stop or race. The usual method was to short-circuit more or less of the field winding, or to shunt it with variable resistance by means of a switch controlled by a centrifugal governor mounted on the motor shaft. A diminution in load below the motor torque would produce a rise in speed, and the governor would then reduce the field strength and torque to the proper value. The speed of these constant current motors was also regulated by shifting the brushes or by moving the armature out of the field. The serious objection to the operation of motors on constant-current series circuits is the high e.m.f. of the latter, usually from 3000 to 6000 volts. Even the potential difference between the motor terminals is about 100 volts (1000 watts \div 10 amperes) per horsepower, which would amount to 1000 volts for a 10-horsepower machine. All of this except 30 or 40 volts drop in the field winding (IR_{se}) would exist as a potential difference between

the brushes, being dangerous to persons and high for commutation. To supply 50 horsepower to a factory by this system would involve a potential difference of 5000 volts between the two conductors, whether using one motor or several in series. The constant-current motor, however, possesses the great advantage that the armature may be stopped indefinitely with full current flowing and no injury results. In fact, its temperature is practically the same as at rated speed, because the absence of armature-core losses when standing still usually makes up for decreased ventilation.

For further information concerning series motors see the following :

- AMERICAN ELECTRIC RAILWAY PRACTICE. Herrick and Boynton. 1907.
 DIE GLEICHSTROMMASCHINE. Vol II, p. 630. E. Arnold. 1904.
 ELECTRIC MOTORS FOR RAILWAY SERVICE. W. B. Potter, Trans. A. I. E. E., Vol. XIX, p. 170.
 ELECTRICAL TRACTION, Vol. I. Wilson and Lydall. 1907.
 ELECTRIC JOURNAL, Vol. I, p. 479; Vol. III, pp. 14, 525; Vol. IV, p. 454.
 ELECTRIC RAILWAY ENGINEERING. Parshall and Hobart. 1907.
 ELECTRIC RAILWAYS. McGraw Co. 1907.
 TRANS. A. I. E. E., Vol. XXIV, p. 65; Vol. XXVI, p. 1407.
 STANDARD ELECTRICAL HANDBOOK, pp. 456, 828, 841. McGraw. 1908.
 ELECTRICAL ENGS.' POCKET BOOK, H. A. Foster, pp. 614, 753, 760. D. Van Nostrand Co. 1908.

CHAPTER XI.

COMPOUND-WOUND MOTORS.

THERE are two classes of compound-wound motors. In one case the ampere-turns of the series coil *reinforce* the shunt-field ampere-turns, producing the *cumulative-compound* motor; in the *second* case the series ampere-turns *oppose* those of the shunt winding, producing the *differential-compound* motor. The *former* machine is commercially called the *compound* motor, the latter being known as the *differential* motor. The connections of a compound-wound motor are shown in Fig. 70.

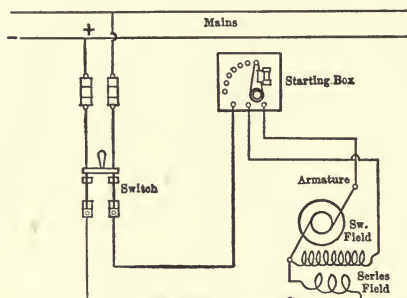

FIG. 70. — CONNECTIONS OF COMPOUND-WOUND MOTOR

As already noted, an ordinary shunt motor is usually operated with constant potential at the field-circuit terminals, so that the flux is practically constant at all loads (except for a slight effect of armature reaction which reduces this flux by a small percentage at rated armature current and torque). Hence the torque increases practically in direct proportion to the armature current. In a cumulative-compound motor the conditions are somewhat different, since the field becomes stronger with increase in load, due to the magnetizing action of the series coil, so that the torque increases more rapidly than the armature current. That is, the torque is proportional to the armature current and to the field flux (due to the sum of the series and shunt excitations), that is, torque = $KI_a \left(F \frac{V}{R_{sh}} + FI_a \right)$. At the same

time, since the field flux rises with increase in load, the speed decreases, due not only to $I_a R_a$ effects but to the relation $\text{r.p.m.} = \frac{e}{n\Phi} \frac{60 \cdot 10^8 b}{2p}$. This decrease in speed becomes relatively less as the load increases, because the field flux rises less rapidly as the magnetic density approaches saturation, further reduction in speed being caused solely by the armature and series field IR drop. Hence the compound motor combines the characteristics of the shunt and the series types, having a speed not extremely variable under load changes but developing a powerful starting torque. The stronger the shunt-field flux (no-load flux) the more nearly the action corresponds to that of the shunt motor; the weaker the shunt field the more closely does the machine resemble the series motor. In fact, two forms of cumulative-compound wound motors are manufactured, one with a low ratio of series field m.m.f. to shunt field m.m.f. varying from 10 to 25 per cent at rated load; the other having a series m.m.f. equal to 50 or 75 per cent of the shunt field m.m.f. at rated load.

The characteristic curves of a 40-horsepower 220-volt compound-wound motor having a field m.m.f. at rated load made up of 80 per cent shunt and 20 per cent series excitation, are shown in Fig. 71. The speed increase of this machine between rated load and running free is about 35 per cent. It is interesting to compare the curves of Fig. 71 with those given in Fig. 72 as the effect of weakening the shunt excitation and strengthening the series field becomes at once apparent. The curves in Fig. 72 are for a motor similar to that of Fig. 71, the ratio of excitations being now, however, 70 per cent series and 30 per cent shunt, just enough of the latter to prevent the motor from racing when load is entirely removed; nevertheless the motor speed varies from 590 to 1010 r.p.m. The former machines are employed extensively in shop practice where a motor may be required to start under heavy load but must maintain an approximately constant speed after starting, or when the load is removed. The heavily compounded motor is employed where powerful starting torque and resulting rapid acceleration are necessary with a speed not too widely variable under load changes as per the requirements of elevator, rolling-mill and similar service. In addition to the comparatively constant speed required after the running condition has been attained, elevator service has an additional require-

ment, namely, the motor must have the series field-winding cut out or short-circuited at full speed to avoid reversal of the machine should the elevator be heavily overbalanced. This would cause the motor to speed up, and if the series winding is relatively powerful compared with the shunt winding, it would reverse the excitation and result in a burn-out. Well-designed shunt motors have a speed

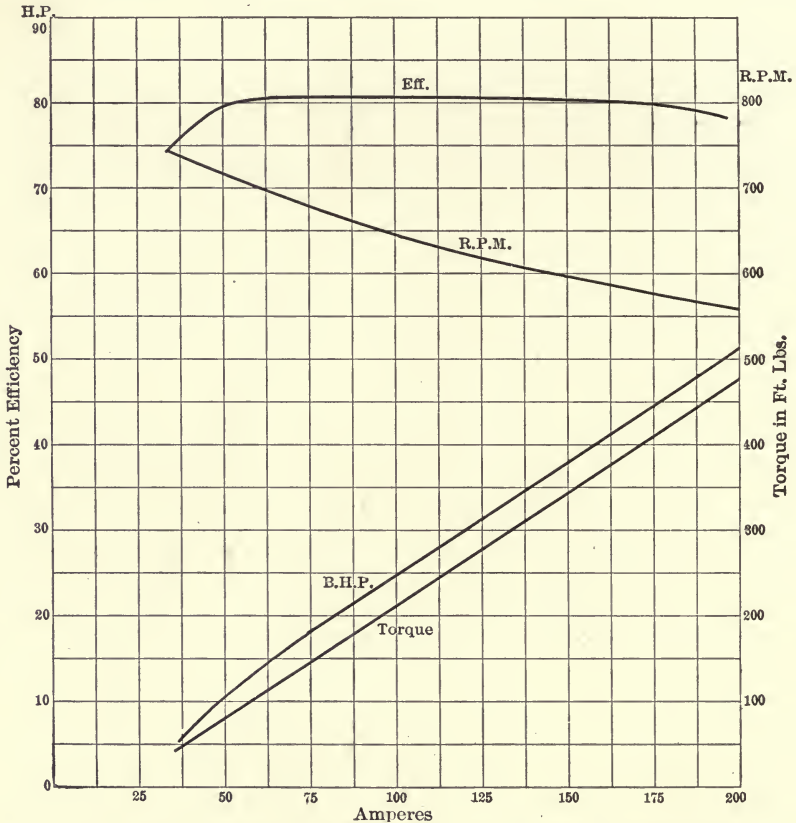

FIG. 71. — CHARACTERISTIC CURVES OF A 20 PER CENT 40-H.P. COMPOUND WOUND MOTOR.

regulation within 5 per cent; series motors have a speed change of almost unlimited ratio from no load to full load or *vice versa*, while compound-wound motors have speed variation from 12 to 100 per cent above that corresponding to the rated torque, depending upon the ratio of shunt to series field m.m.f. as set forth above.

The speed control employed with compound motors may be

any of the various methods explained in connection with the shunt motor, though when used for elevator service the control is generally entirely rheostatic, with the final cutting out of the series winding after acceleration has ceased.

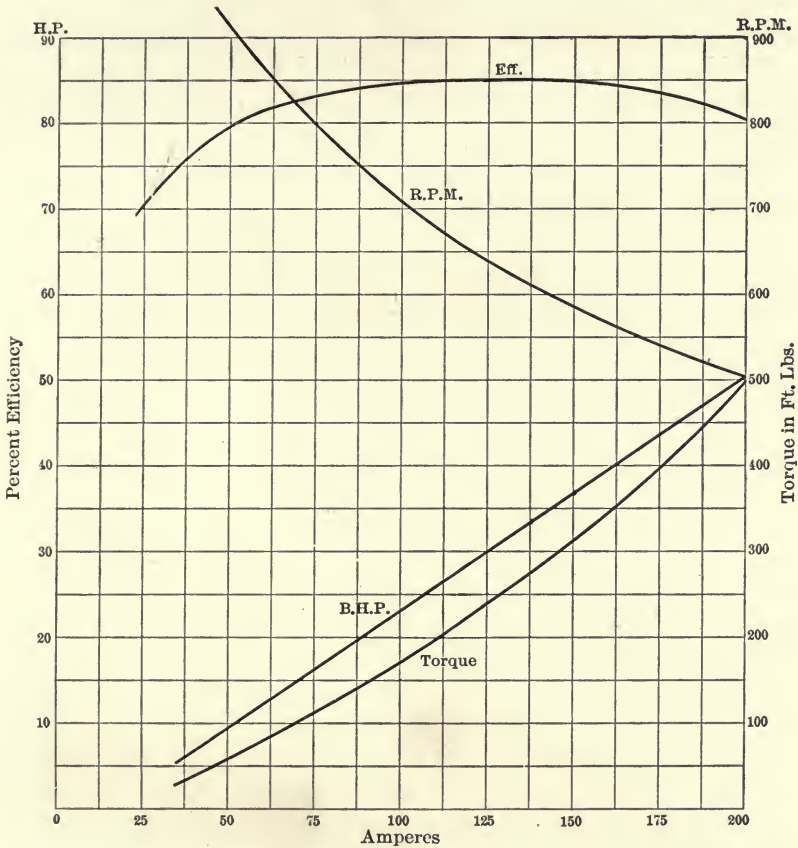

FIG. 72. — CHARACTERISTIC CURVES OF AN 80 PER CENT 40-H.P. COMPOUND WOUND MOTOR.

The Differential Motor. — In this class of compound-wound motor the m.m.f of the series winding *opposes* that of the shunt winding and thus weakens the field with increase of load. The object is to compensate for $I_a R_a$ drop and thus maintain the speed constant at all loads. These machines will operate satisfactorily if not overloaded, but if an overload occurs the field flux becomes so much reduced that the torque is not sufficient to maintain rotation,

hence the c.e.m.f. falls to zero and a burn-out of the armature winding results, unless the machine is protected by fuses or a circuit-breaker. A still further objection to this motor is the impossibility of obtaining a powerful starting torque on account of the weakening of the field with heavy currents. In fact, since the series circuit is of considerably lower inductance than the shunt circuit, the motor if quickly started, under load, would tend to rotate in the wrong direction. Hence the series winding should be automatically short-circuited during the starting of the machine.

The same regulation as that secured by differential winding may be obtained from a specially designed shunt motor with armature reaction exaggerated, also by brush lag, by an excessive number of armature turns, or by proper use of interpoles, without the serious weakness of the differential motor. For most practical purposes, however, the speed of a well-designed shunt motor does not vary to an extent that is objectionable, so that this special regulation is not needed. The differential machine is, therefore, rarely used.

Résumé of Characteristics of Direct-current Motors. —

Shunt motors have a speed varying only slightly with load changes, and good starting torque. They are employed where the speed should be approximately constant and also where the speed may be adjusted by some of the methods described.

Series Motors. — These machines are employed when powerful starting torque and rapid acceleration are demanded, also when speed must be automatically adjusted to load, but they have no customary or even limit of speed with variable loads.

Compound-wound motors have a speed decreasing considerably (12 to 50 per cent) with load, but possess the powerful starting torque characteristic of series motors, and are employed in connection with work requiring that capability and a speed not excessively variable under load changes. They may be safely belted to the tool, while series motors should never be, but must be positively connected.

Differential motors may be designed to give an almost absolutely constant speed under all load changes within their rating, but beyond this the motor is too likely to be stalled; the starting torque is also small. This motor is no longer used in practice, improvements in the design of shunt motors having secured nearly constant speed without the objectionable features of the differential type

CHAPTER XII.

ALTERNATING-CURRENT MOTORS.

CLASSIFICATION AND HISTORY.

THE salient facts in the historical development of the electric motor were briefly stated in Chapter I. These related chiefly to direct-current types because the only source of electrical energy commercially available up to 1880 or thereabouts was the voltaic battery. Furthermore, the electrical generating plants employing dynamo-electric machinery in operation prior to 1890 were almost all designed to supply direct currents only. Hence the commercial progress and as a natural result the scientific advance of the a. c. motor were held back, while the d. c. machine received much more attention. Nevertheless, during all this time experiments were being made and ideas evolved which led up to the various a. c. types now known, these being quite numerous and differing widely from one another. On the other hand, d. c. motors are practically all of one species, which may be defined as embodying essentially a drum armature with commutator in a bipolar or multipolar field, and is the same as the d. c. generator except for mere differences in form to suit particular conditions, as, for example, those of electric railway service. While there is only one important kind of d. c. machine, we have the following distinct *Types of Alternating-current Motors*.

1. *Synchronous Motor*, being an ordinary a.c. generator reversed in function.
2. *Induction Motor*, having armature winding closed upon itself or through a local circuit not connected to source of supply and without commutator.
3. *Repulsion Motor*, having armature with commutator and brushes connected through local circuit wherein current is induced.
4. Similar to d. c. motor, having armature (with commutator) and field winding both connected to supply circuit, hence often

called *conductive motor* in contradistinction to the two foregoing types.

5. *Shaded Pole or Creeping Field Motor*, in which the phase of the flux is retarded in parts of the field.

In addition to the above classification a further differentiation of a. c. motors is based upon the fact that either of the first two types may be operated by *single, two, or three phase currents*. The other three types are supplied with single-phase current, and even when fed from polyphase circuits each motor is connected to one phase only.

It is to be noted that the conductive type, No. 4 of the above classification, is the only one capable of being operated either as a d. c. or as an a. c. motor. With the entire field as well as armature iron laminated and with certain features to limit sparking, as explained later, the same machine will run well with either direct or alternating current; in fact many electric locomotives are so operated on the New York, New Haven and Hartford Railroad. The other forms, types Nos. 1, 2, 3, and 5 of the foregoing list, are incapable of operating with d. c. supply. It is true that type 3, the repulsion motor, has a commutator and is structurally similar to the d. c. machine; nevertheless it must be differently connected and current supplied to its armature by *conduction* instead of induction, in order that it may run as a d. c. motor. Hence it no longer belongs to the repulsion class.

It is evident from these statements that we have only a single important type of d. c. motor or generator, while there are five types of a. c. motor, one of which is the same as the d. c. machine. The only other kind of dynamo that has been used for d. c. generation is the unipolar or homopolar machine. This can also be operated as a d. c. motor and as an a. c. motor. Therefore the latter seems to include all cases of the former, in addition to which it has at least four distinct forms of its own.

The complete history of a. c. motors would include, therefore, an account of the development of each of these five types, which for the most part owe their existence to different times and different inventors. It is sufficient at this point to indicate briefly the principal historical facts, to be supplemented later by the discussion of the individual types, which contain references to inventors, authors, patents, and articles.

The history of the synchronous motor is essentially similar to that of the a. c. generator because the two machines are structurally identical; in fact the same machine may be used equally well for either purpose. This reversibility was not fully appreciated and applied by those who first brought out and experimented with electric generators and motors, so that they were designed quite differently and their development was to a large extent independently carried forward. Nevertheless, any improvement in the generator was equally applicable to the motor, and *vice versa*. It is also a fact, as stated in Chapter I, that the reversibility of the electric generator began to be understood many years ago. For example, Pacinotti in 1860 invented his ring armature for use in motors as well as generators and later others described machines to perform both functions.* In 1868 Wilde while operating alternators in parallel observed the fact that the armature of one of them was caused to oscillate as a motor when fed with current generated from another.† Hopkinson in 1883 published the theory of this phenomenon and showed that continuous rotation of the motor could be maintained.‡ In conjunction with Prof. W. G. Adams he soon verified these conclusions experimentally with three De Meritens alternators of several horsepower each, at the South Foreland lighthouse, the results being given in a paper by Adams on "The Alternate Current Machine as a Motor."§

The polyphase generator or motor may be regarded as a combination of two single-phase machines. At the same time the polyphase synchronous motor has the practical advantage that it is self-starting, while the corresponding single-phase motor requires some auxiliary means to bring it up to synchronous speed. This advantage is a fortunate incident, however, because polyphase systems owe their great importance not to this fact but to their capabilities of operating induction motors and their economy of material in transmission lines as well as in generators, etc. Early in 1887, Charles S. Bradley invented a machine to operate either as two-phase generator,

* Siemens, Brit. Patent No. 3134 of 1878.

Deprez, Brit. Patent No. 4128 of 1837.

Dredges, Electric Illumination, London, 1882, Vol. I, p. 69.

† Philosophical Magazine, January, 1869.

‡ Lond. Inst. Civ. Eng., 1883.

§ Soc. Eng. and Elec., November 13, 1884.

motor, or converter, but this invention is considered more fully under the following heading.

The evolution of the induction motor is directly related to that of polyphase currents and the production of rotary magnetic fields by means of such currents. Many pieces of apparatus have been devised and physical facts noted which have contributed to the advance in this direction. Arago* in 1824 observed the retarding effect upon the swinging of a compass-needle produced by surrounding it with a copper ring. He also deflected a stationary magnetized needle by motion of a copper disk immediately below it, and with more rapid motion he caused the needle to rotate continuously but at a lower speed than that of the disk. These phenomena are basic in relation to the induction motor, being due to the force set up between a magnet and a conducting body when they are moved with respect to one another so that electric currents are induced in the latter by cutting the magnetic lines of the former. It was not, however, until Faraday's discovery of magneto-electric induction in 1831 that the true explanation of these phenomena was forthcoming.

Walter Bailey read a paper before the Physical Society of London on June 28, 1879, entitled "A Mode of Producing Arago's Rotations," and exhibited a model in which a copper disk was caused to rotate by progressive shifting of magnetism among four fixed electromagnets, by throwing on and off as well as reversing through a revolving commutator the current obtained from two primary batteries. Thus the Arago effect was produced without bodily moving the magnet, or in other words, it was what is now known as the *rotary field*. In 1880 Marcel Deprez presented a paper before the Société Française de Physique describing a motor which operated by two-phase currents. It was, however, of the synchronous type, and is only interesting as a step of progress in this direction, because in 1883 he announced† an important theorem on the production of a rotary field by the combination of two alternating magnetic fields differing in phase by one quarter of a period. Deprez was the first to appreciate that this phenomenon is analogous to the mechanical production of rotary motion by the combination of two forces (or cranks) acting at right angles, and he was also the first to work out the theory of the magnetic case.

* Annales de Chimie et Physique, XXVII, 363; XXVIII, 325; XXXII, 213.

† Comptes Rendus, Vol. II, p. 1193, 1883.

A number of inventors had prior to that time constructed or published descriptions of generators for producing polyphase currents; for example, Wheatstone, Gramme,* Cabanellas,† and others.

The next important contribution was that of Professor Galileo Ferraris, who in 1885 built a two-phase motor having four poles, two of which were excited by one alternating current and the other two by another alternating current differing in phase, the rotary field thus produced causing the armature to revolve, without any electrical connection to the latter. This motor was not exhibited till 1888, on March 18th of which year Ferraris also read a paper before the Turin Academy in which he set forth the geometric theory of the rotary field and described experiments illustrating the same. He pointed out the fact that a motor armature in which the current is generated by induction must necessarily rotate less rapidly than the field, or in other words, there must be a *slip*. He employed armatures of iron, copper, as well as of mercury, and suggested that a. c. measuring instruments could be made in accordance with this principle. He also explained how two-phase currents could be obtained by dividing an a. c. circuit into two branches, one inductive and the other non-inductive, now known as the *split-phase* connection.

Charles S. Bradley on May 8, 1887, filed an application for U. S. patent (No. 390,439) in which he clearly showed and described a generator having a Gramme armature tapped at four equidistant points by connections to four collector rings. This machine generated two-phase currents, one of the objects stated being to obtain larger output by reason of the fact that one current is at a maximum when the other is zero and *vice versa*. This is one of the great advantages of polyphase apparatus of all kinds, which are usually capable of giving more power than single-phase apparatus of equal weight. Bradley also stated that his machine could be used as a motor if supplied with two-phase currents and that it would give out direct currents if fed with alternating currents, or conversely; that is to say, it was what is now called a rotary converter. In fact this was the basic and controlling patent on that machine in the United States. Bradley in another U. S. patent (No. 409,450) issued August 20, 1889, describes a similar machine with three

* British Patent No. 953 of 1878.

† British Patent No. 200 of 1881.

armature connections to generate three-phase currents or to operate as a motor when fed with such currents, which is nothing less than a three-phase system of power transmission, including also the rotary converter to supply d. c. railways, arc lamps, storage batteries, and other electrolytic apparatus.

Nikola Tesla in October, November, and December, 1887, filed applications for U. S. patents which were issued in May, 1888, as Nos. 381,968, 381,969, and 382,279, setting forth a generator to produce two-phase currents, connected to motor in which a rotary field was developed thereby and acted upon an armature of iron to cause it to revolve. It is interesting to consider wherein Tesla's work differed from the early contributions which have just been pointed out. Arago's disk and similar apparatus prior to that of Bailey were in no sense electric motors, because the motion of the disk was merely the result of bodily rotating the magnet by hand or by a belt. The device of Bailey was an induction motor, because currents supplied to its stationary magnets set up a rotary field which induced currents in and caused the revolution of its armature. On the other hand, the currents were not truly alternating, being merely currents from two batteries which were reversed by a commutator turned by hand. Furthermore, what Bailey exhibited in 1879 was only a small model with a disk about $2\frac{3}{8}$ inches in diameter, incapable of exerting any appreciable power, its design being wholly unadapted to practical use. On the contrary, Tesla particularly describes the use of a true "alternating current, each impulse of which involves a rise and fall of potential" in order that "the progression of the poles will be continuous and not intermittent" as in the case of reversed currents. He also points out "the practical difficulty of interrupting or reversing a current of any considerable strength." The drawings and specifications of these Tesla patents set forth machines which are evidently intended to be used as practical motors.

The theory of the rotary field, published by Deprez in 1883, gave a definite mathematical basis for this important physical principle, but he did not embody it in a concrete motor, and could not therefore have obtained a patent for his results, original though they were, since a principle unapplied is not patentable.

On the contrary, Ferraris did work out not only the theory involved but also constructed motors in accordance therewith. In this country, however, he labored under the legal disadvantage

that he could get no benefit for what he did prior to his printed publications, while Tesla could go back to his earliest notes, experimental work, and private disclosures to others. This is the one respect in which a foreigner's rights are not equal to those of an American citizen in the eyes of the patent law. It is also true that Ferraris did not appreciate the great practical value of his invention, but this is often the case even with the best ideas until they are applied and a demand created. In itself this would not invalidate his patent rights, especially as we have seen that he actually built working induction motors operated by polyphase currents and suggested the applicability of the same principle to a. c. measuring instruments. It would seem, therefore, that Ferraris had good moral claims to the credit of the invention, but in this country was disqualified legally from using the earlier evidence in his favor.

Bradley in his U. S. patent No. 390,439, already cited, which was applied for May 7, 1887, did not set forth or claim the induction motor, but he clearly showed and described a machine to serve as a generator of two-phase currents, as a rotary converter, or as a two-phase synchronous motor, thus including all the important elements of a polyphase system except the induction motor. It has already been stated also that Bradley's U. S. patent No. 409,450 fully describes a three-phase generator, converter, and synchronous motor. The earliest application for a patent by Tesla setting forth a three-phase generator and motor was filed Oct. 12, 1887. Even after the polyphase system and induction motor had been made known to the public during 1888 and 1889 by the patents and papers of Ferraris, Bradley, and Tesla, it required several years of experiment and design by many engineers, involving much labor and expense, before this type of motor became a really practical success. In fact, this cannot be said to have occurred until about 1894. Since that time still further improvement has been made in efficiency, higher power factor, economy of material, etc., as well as in auxiliary starting and regulating devices.

No one is directly credited with having invented the alternating-current series motor. The first mention of the possibility of such a machine was apparently made by Alexander Siemens before the British Institution of Electrical Engineers in 1884. At the same

time he indicated the advisability of laminating the entire magnetic circuit.*

For several years after that, in fact until about 1893, the simple a. c. series motor was manufactured quite extensively for small fan motors. During the early nineties, among others, Rudolph Eichmeyer and Dr. C. P. Steinmetz experimented with large-size a. c. series motors, hoping to produce a desirable single-phase railway motor, but they did not meet with much success on account of the high frequency of the current employed by them. Interest in this type of motor lapsed thereafter, on account of the development of the single-phase induction motor, until Mr. Lamme of the Westinghouse Company produced a practical machine in 1902, upon which the technical press and engineers again became much interested in the development of the machine, and many modifications to improve its action were devised.

The invention of the repulsion motor is generally credited to Prof. Elihu Thomson, who discovered the physical fact that any conducting body tends to be repelled by a magnet excited by alternating current. This phenomenon and various experiments illustrating it are described by him in a paper read May 18, 1887, before the American Institute of Electrical Engineers on "Novel Phenomena of Alternating Currents." † Professor Thomson in this paper also showed how to apply the principle and thus obtain a new type of electric motor. In this machine the coils are short-circuited only a portion of the time, that is, while moving away from the poles. The form of motor now known as the repulsion type embodies an armature having all of its coils short-circuited and carrying current all the time that it is in operation. This arrangement was first described by Professors Anthony, Jackson, and Ryan in their U. S. patent No. 389,352, issued September 11, 1888, the invention having been made in 1887. Neither of these forms of repulsion motor was considered to have much practical importance until 1902 or later, when the latter was experimentally tried and its use advocated for electric railway service by the General Electric Company and others.

* Journal British Institution of E. E., p. 527, Vol. XIII, 1884.

† Transactions, Vol. IV, p. 160.

‡ Papers and discussion by Slichter, Steinmetz, Blanck, and others in Trans. Amer. Inst. Elect. Eng., Vol. XXIII, pp. 1-100, January, 1904.

CHAPTER XIII.

THE SYNCHRONOUS MOTOR.

THE synchronous alternating-current motor is merely an *inverted alternator*; that is, the same machine may in general be used as a generator or motor. The simplest of this type is the *single-phase machine*, and a study of its characteristics will also explain the action of the corresponding polyphase motors. For example, a two-phase motor may be regarded as a combination of two single-phase machines. There is, however, the important practical fact that the single-phase synchronous motor is not at all self-starting (unless provided with special starting device), while the polyphase synchronous motor is self-starting without load, in which limitations both differ from the majority of other electric motors. It should also be noted that this type of motor whether single or polyphase requires a *direct-current supply for field excitation*.

Not Self-starting for Following Reasons. — The rotation of the armature of a direct-current motor is due to the fact that an unidirectional torque is exerted between the armature and field. Any increase in load tends to diminish its speed and counter e.m.f., which allows a greater armature current to flow, producing a corresponding increment in the driving effort of the motor.

In the case of a synchronous motor we have the following conditions: a field excited by direct current and an armature supplied with alternating current. The first condition provides a field of fixed magnetic polarity, the second gives an armature the current in which is alternating, therefore the direction of rotation also tends to be variable. (Fig. 73.) If, however, the motor could be brought to such speed (by external means) that the half of the armature represented above in Fig. 73 would be below after the current reversed, a fixed polarity in space would result, because the top of the armature would always be of *N* polarity and the lower part of *S* polarity, producing a torque in one direction and therefore continuous rotation. For this to occur, the armature must, however, revolve one-half a turn in the time occupied by one alternation of

current, and a full turn in the duration of one cycle of current. In other words, the armature must generate a counter e.m.f. of the same frequency as the applied voltage. When this condition is fulfilled the motor is said to be operating in *synchronism*, hence the

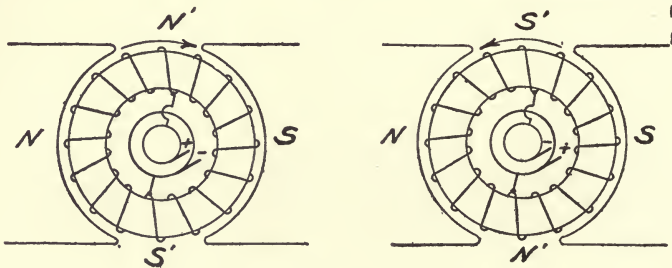

FIG. 73. — VARIATION OF ARMATURE POLARITY.

term *synchronous motor*. It is apparent that the speed of this motor must remain constant, since the torque must be unidirectional to maintain rotation, so that *the speed of any synchronous motor is fixed by its number of poles and the frequency of the applied voltage; i.e.,*

$$\text{speed in r.p.m.} = \frac{\text{periods per sec.} \times 60}{\text{pairs of poles}} \quad (18)$$

The polyphase synchronous motor is self-starting *without* load, because the polyphase currents set up a rotary magnetic field in the surface of the armature, which reacts upon the field magnet to produce mechanical rotation. The circuit of the field winding, however, must be open, because the rotary field would not be sufficiently powerful in the presence of the field flux. After the rotary member is up to speed, the usual d. c. field excitation is established. To prevent excessive voltage being generated in the field coils, these are separated from each other and not connected together in series until synchronous speed is nearly obtained. It is also desirable when thus starting synchronous motors to use less than their normal working voltage.

Action of Synchronous Motor under Varying Loads. — As shown above, the motor must operate at a definite speed on a circuit of given frequency, or not at all. The field strength being also constant, the effective counter e.m.f. of the motor is of constant value; therefore it would *seem* that with constant applied voltage, which is the practical condition, the armature current could not automat-

ically increase to enable the motor to exert more torque in order to carry additional load. The peculiar action which occurs and gives variable torque is explained as follows: Consider two ordinary single-phase alternators M and G driven by independent prime movers, but with their armatures electrically connected in series and jointly furnishing power to an external load Q (Fig. 74). The

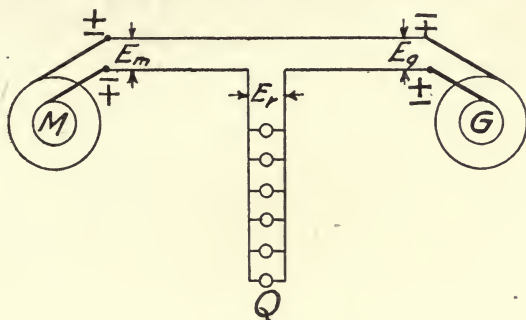

FIG. 74. — ALTERNATORS CONNECTED IN SERIES.

e.m.f. of the system (E_r) will under this condition be $E_m + E_g$ as shown by the wave and vector diagrams A and B , respectively (Fig. 76). Since there is inductance in the armatures and line, the

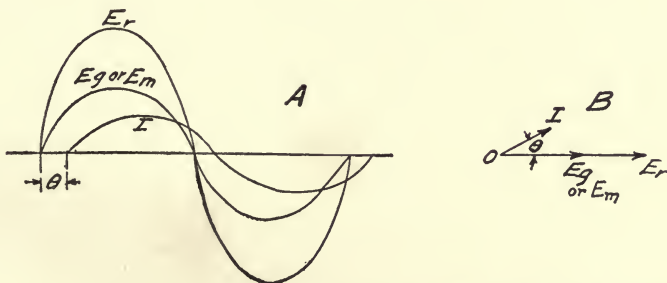

FIG. 75, A AND B. — ALTERNATORS IN SERIES WAVE AND VECTOR DIAGRAMS E.M.F.'S IN PHASE.

current I will lag behind the resultant e.m.f. or E_r by an angle θ . If the load should change or the steam pressure vary, the engine governors would tend to maintain constant speed; but one would naturally act before the other. This difference, however small, would cause one machine and its e.m.f. to fall behind, so that its phase angle with respect to the current would be less, its load therefore greater, and the power required to drive it correspondingly

increased. The converse is true of the other alternator, the consequence being that the former continues to drop back in phase until it is about 180 degrees behind the other machine. Referring to the vector diagram *B* in Fig. 76, let us consider exactly what occurs.

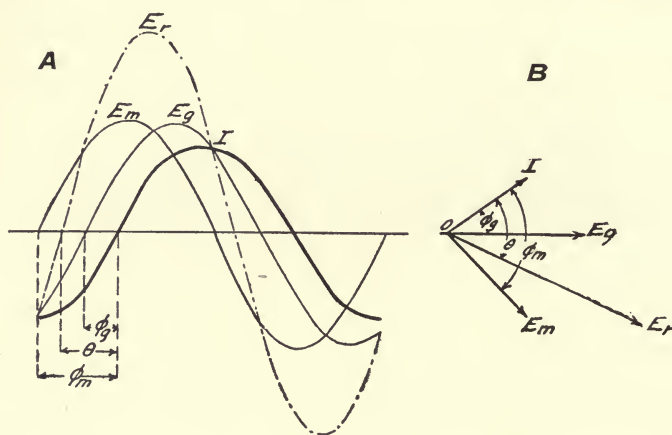

FIG. 76. — PHASE RELATIONS BETWEEN ALTERNATORS IN SERIES, SWINGING OVER TO PARALLEL CONDITIONS.

OE_g represents the e.m.f. of the lagging machine and OE_m that of the other, so that OE_r is the new resultant e.m.f. and OI the new current position, which maintains the same phase relation with E_r as before, because the resistance R and inductance L of the circuit have not changed. Let ϕ_m and ϕ_g represent the new phase displacement of E_m and E_g respectively with reference to the current. The load on each of the alternators is now $E_m I \cos \phi_m$ and $E_g I \cos \phi_g$ respectively; the angle ϕ_g being less than ϕ_m , the load $E_g I \cos \phi_g$ on the engine that drives the machine *G* is greater than that on the engine driving the machine *M*, hence the latter tends to run faster while *G* will fall off in speed. The load on *G* increases more and more and the angle between E_m and I becomes greater until it passes through 90 degrees, after which $\cos \phi_m$ has a negative value, so that the work done by alternator *M* is negative, that is, it is operating as a motor, the phase relations being represented in Fig. 77. Hence the operation of two or more alternators in series is a condition of unstable equilibrium, unless they are positively connected or driven from the same source of power so that any speed change is common to both; other-

wise, at the least variation in load or speed, they will instantly fall out of step and tend to pass into the condition of opposition, parallelism or 180° phase relation.

The parallel operation of two or more alternators is a stable one. If one machine tends to speed up, its voltage increases and thus it would supply a larger current, carry a heavier load and be compelled by the action of the engine governor to slow down, while the under-loaded machine would tend to speed up, thus equalizing

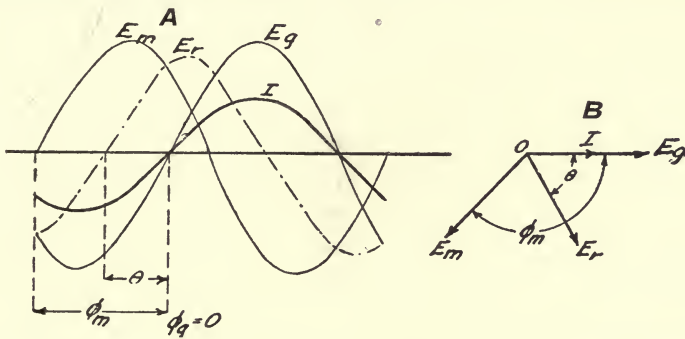

FIG. 77. — SYNCHRONOUS MOTOR, PHASE RELATIONS BETWEEN LINE VOLTAGE, CURRENT AND MOTOR E.M.F.

conditions. This statement is a general one corroborated by the fact that a. c. generators are successfully run in parallel in thousands of commercial plants. On the other hand practical difficulties arise in some cases of parallel operation, because of slight differences in angular velocities due to "hunting" of governors, which may throw the machines out of synchronism. If, after the alternator M reaches the 180 -degree phase relation with respect to the other machine, we disconnect its mechanical driving power, it would continue to operate as a motor, provided the current fed to its armature be sufficient to supply copper losses and stray power torque. If this is not enough, armature M will tend to lag a trifle, causing the resultant e.m.f. to increase so that more current flows. This increases its torque sufficiently to maintain rotation, unless the dropping back of M should be so great in duration or phase that the synchronous relation is broken.

The preceding facts may be summed up as follows: The ability of a synchronous motor to carry a variable load is due to the phase shifting of its e.m.f., which action, taking the place of the speed

changes of other types of motors, alters the resultant e.m.f. so that the armature current automatically adjusts itself to the load.

Starting and Synchronizing of Synchronous Motors. — The single-phase synchronous motor not being self-starting, as already explained, requires some auxiliary motor to bring it up to synchronous speed and into proper phase relation before it can be properly connected to the supply circuit. Such auxiliary starting device may be a series, repulsion or induction (split-phase) motor, or if the direct-current field exciter is large enough, it may be used as the starting motor, being supplied with current from a storage battery, which at that time also furnishes the main-field exciting current. Small synchronous motors are often constructed with the starting device as an integral part as follows: The armature core is provided with an additional winding and commutator, which, connected in series with an extra winding on the field cores, makes it possible to start the machine as a series motor. The commutated armature winding is connected across the main field after synchronous speed is attained and the main armature is connected to the a. c. supply lines; thus the machine becomes self-exciting.

Polyphase synchronous motors are self-starting, with about 10 to 15 per cent rated load torque, through the development of a rotary field by the currents in the armature windings, which, acting upon the polar faces, drags the rotor around. To start in this manner, the field circuit is opened, and the armature supplied with approximately rated load current at about one-half rated voltage through a transformer or compensator. This causes the revolving member to rotate at a speed approximating that of synchronism. The operator then closes the field circuit, thus accelerating the rotor to synchronous speed, after which the armature is supplied with current at rated voltage and the machine is ready to carry its load. This method of starting may, however, especially if the motor be large with respect to the generators, cause serious voltage fluctuations, and it then becomes desirable to use some other starting devices, for example, an auxiliary machine as already stated in the case of the single-phase synchronous motor.

It is impossible with ordinary mechanical speed-measuring instruments to determine the approach to synchronous speed as accurately as is necessary for the safe connecting of synchronous

motors to the line. Furthermore, the phase relations of the line and motor voltages must also be correct. There are, however, simple electrical methods of determining when agreement in frequency with proper phase relations exists, the simplest of these being the lamp methods, one of which follows: In Fig. 78 *L* and *M*

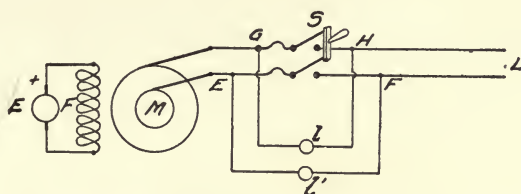

FIG. 78. — CONNECTIONS FOR SYNCHRONIZING SINGLE-PHASE MOTOR.
(LAMP FILAMENTS BLACK.)

represent respectively single-phase line terminals and a single-phase synchronous motor, which can be connected by the double pole switch *S*. Two *synchronizing* lamps *l* and *l'* are connected respectively, as shown, across the two gaps in the circuit, controlled by the switch *S*. By means of the auxiliary starting motor *EF*, the synchronous machine *M* is brought to approximately the proper speed. With the rotor member of the motor stationary, or when its frequency differs greatly from that of the circuit, the alternations of current and the corresponding flickering of the lamps *l*, *l'* are too rapid for the eye to detect, but when the motor frequency varies only slightly from that of the line, whether higher or lower, the synchronizing lamps will glow for one moment and be black the next. The smaller the difference in frequency the less rapid the flickering. At the instant that the voltages are opposite in phase, and of equal value, there will be no current through the lamps; but when the voltages are in phase their full sum is applied to the lamps, which then glow at their maximum brilliancy. When the flashing becomes very slow the motor may be connected to the line by closing the switch *S* at the instant that the lamps cease to glow. If the motor continues to operate properly, its field strength may be adjusted so that the line current will be small after the auxiliary motor or starting-up device is disconnected. It is better to connect the motor to the line as it approaches exact synchronism rather than when it is departing from

it; that is, the main switch S should be closed the instant the lamps cease to give light.

Owing to the fact that incandescent lamps do not glow with less than 30 or 40 per cent of their rated voltage, it is impossible to determine exactly the minimum voltage difference which is the proper condition for connecting a synchronous machine, and thus the current passing between the machines and the line may be rather high upon closing of switch S . To avoid the danger of such rush of current, the lamps may be diagonally connected, that is, between G and F and between E and H (Fig. 79), in which

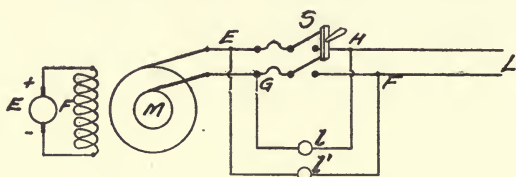

FIG. 79. — CONNECTIONS FOR SYNCHRONIZING SINGLE-PHASE MOTOR (MAXIMUM LIGHT).

case they glow at full brilliancy when the phase relation is correct. The lamps may also be replaced by voltmeters, which if connected as in the first instance would indicate zero voltage and in the latter case show full voltage.

The connections of the synchronizing lamps for a three-phase circuit are similar to the preceding, but three lamps are employed as shown in Fig. 80. If all three lamps simultaneously become

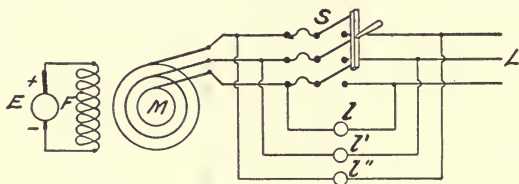

FIG. 80. — CONNECTIONS FOR SYNCHRONIZING THREE-PHASE MOTOR.

bright or dark, the connections are correct, and the line switch may be closed at the instant of darkness. It may happen, however, that the lamps do not glow at the same instant but successively. This indicates that the leads are not connected in their proper order. In this case the motor lines should be transposed until the lamps brighten simultaneously. After the machines have

been once properly connected their synchronizing can be accomplished with a single lamp. If the voltage of the circuit is too high for the direct use of lamps, transformers should be inserted as indicated in Fig. 81, their secondary coils being in series with each

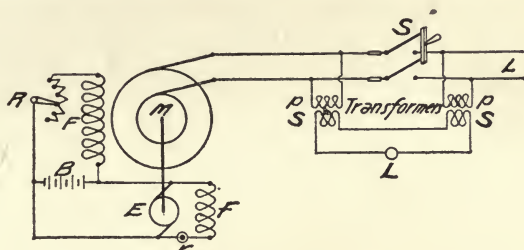

FIG. 81. — CONNECTIONS FOR SYNCHRONIZING ON HIGH-VOLTAGE CIRCUIT. EXCITER USED AS STARTING MOTOR.

other and with the lamp *l*. The latter will glow when the motor e.m.f. opposes that of the line, provided the connections of either the primary or secondary coils are reversed, the former case being represented in Fig. 81.

It has become apparent with the continual increase in the size of units that better means of synchronizing than those afforded by the lamp methods just described were desirable because serious trouble ensues if large machines with heavy revolving parts are connected together when not exactly in step. Such a device is secured in the synchronizer or "synchroscope."* This instrument consists essentially of a small induction motor, of which the fixed winding or stator is excited from the line, and the revolving member or rotor is supplied with current (through a phase-splitting device) from the machine to be synchronized. A rotating magnetic field is thus set up in the synchronizer, and the rotor thereof will revolve at a speed that is governed by the difference between the line and motor frequency. The shaft of the rotor is provided with an arm, which, revolving with it, serves as an indicator. When the frequencies of the currents in the rotor and stator of the synchronizer are the same, the magnetic field due to both is no longer a rotary one, and the pointer remains stationary. This condition may, however, indicate only an equality of frequency, not necessarily one of correctness of phase relation. There is only one particular position of rest assumed

* Electric Journal, Vol. I, 1904, p. 692; Vol. IV, 1907, p. 497.

by the rotor when frequency and phase agreement both exist; and its index is so set that it points vertically upward when these conditions are secured. Accordingly, while agreement in frequency is indicated by the fact that the index of the synchroscope is stationary, the angular difference between such direction and the vertically upward one shows the phase difference existing. Another feature of value in this instrument is the fact that it also shows whether the motor (or incoming machine) is running too fast or too slowly, because if running too fast the pointer will move forward in a clockwise direction, while if revolving at too low a speed the pointer will move in a counter-clockwise direction. Thus the synchroscope accurately indicates frequency and phase relations, and its use is to be recommended in connection with large synchronous motors.

Phase Relations between Constant Line Voltage and Motor Current.

— The synchronous motor in practice is supplied with current from a constant-potential a. c. circuit, and load changes cause the machine

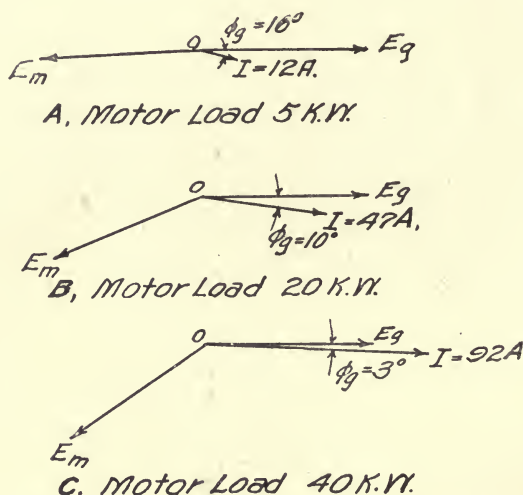

FIG. 82, A, B AND C.—CHANGES OF CURRENT VALUE AND PHASE WITH VARIATION IN SYNCHRONOUS MOTOR LOAD.

to draw currents varying not only in value but also in phase relation with respect to the line voltage. Fig. 82, A, B and C, illustrates the changes in current value and phase angle which occur in the case of a 30-kw. single-phase synchronous motor when the load is 5, 20, and 40 kw. respectively, motor e.m.f. and line voltage being equal

at 500 volts. These diagrams show that the angle ϕ_g between the current and line voltage becomes smaller and smaller as the load is increased, and would at about 45-kw. load reach a zero value, after which upon further addition of load it becomes greater again, in the opposite direction, but shifting from a leading to a lagging angle.

Change of load is not the only way to produce variations in the angular relation between line current and voltage; it may be caused by adjusting the excitation of the motor, and this is frequently done in practice to secure a leading current.

The actions occurring in a synchronous motor with variable field excitation can readily be studied by means of vector or circle diagrams. Assume for example any condition of motor load and let the line e.m.f. be represented by E_g , the current by I , and the angle between them by ϕ_g . The angle θ , existing between the resultant e.m.f. E_r and the current I (which depends upon the values of frequency f , inductance L , and resistance R of the circuit), is theoretically constant, but in practice it varies slightly, since the permeability of the magnetic circuit is only approximately constant. Hence, knowing the line frequency and voltage E_g , the load amperes I , the watts input and the machine constants (L and R), we can readily draw vector diagrams representing the various phase relations of E_g , E_m , E_r , and I at any input, or any mechanical output, if we recollect that this latter is equal to the input less the $I_a^2 R_a$ losses. Formulæ can be derived from these vector diagrams by which any one of the various components can be calculated if the others are known (pp. 150, 159).

In Fig. 83, A, lay off OE_g as the impressed or line voltage, OI as the current at an angle ϕ_g from E_g . The value of E_r is proportional to the value of the current and is equal to $I\sqrt{R^2 + (2\pi fL)^2}$, while the angle θ is $\cos^{-1}(R \div \sqrt{R^2 + (2\pi fL)^2})$; hence lay off this value of E_r at angle θ ahead of I . The motor e.m.f. is then found by completing the parallelogram; that is, it is parallel and equal to $E_g E_r$, its true vector position and relative value being OE_m .

The power input of the motor is $E_g I \cos \phi_g$. The motor output, including core and friction losses, is $E_g I \cos \phi_g - I_a^2 R_a$ or $E_m I \cos \phi_m$, wherein E_m is the motor e.m.f. and ϕ_m angle between E_m and I .

With the line voltage E_g maintained constant, the current I may have any value for a given input, depending upon the value of $\cos \phi_g$. For instance, in Fig. 83, B, let the motor input have the same value as in Fig. 83, A, but let the current be in phase with the line e.m.f.;

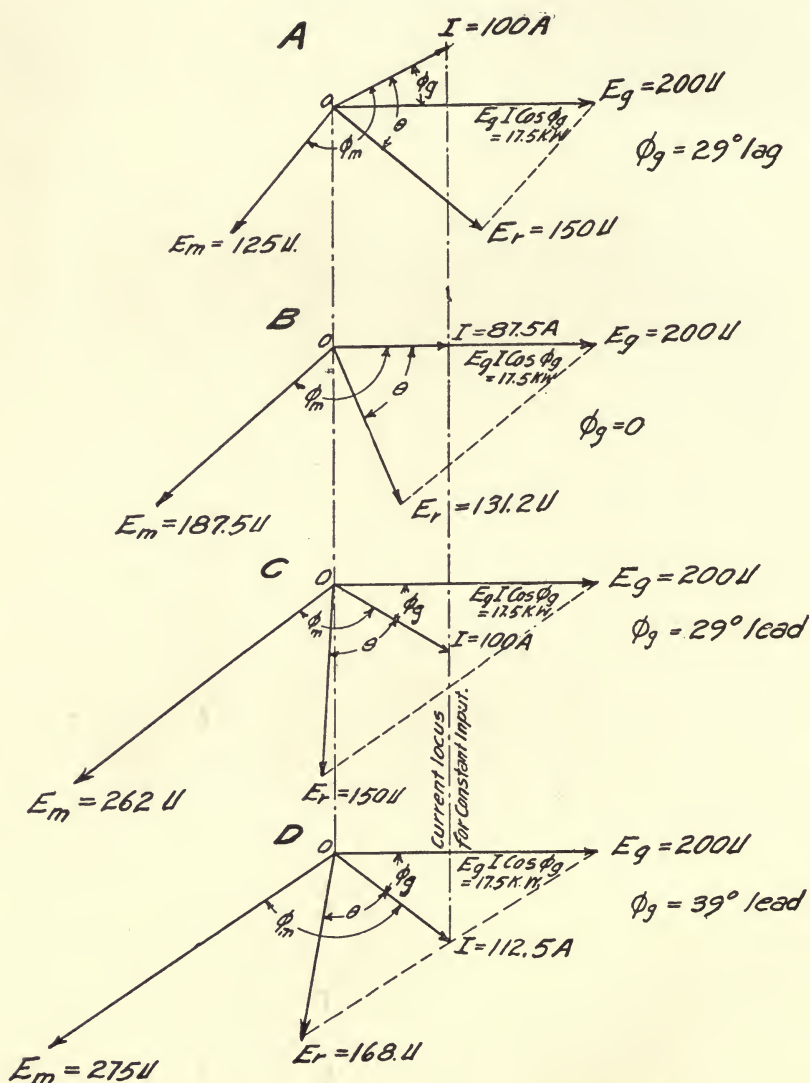

A, B, C AND D. — VARIATION OF POWER FACTOR ($\cos \phi_g$) OF CIRCUIT BY CHANGE OF SYNCHRONOUS MOTOR E.M.F. MAINTAINING CONSTANT INPUT.

that is, $E_g I \cos \phi_g = \text{const.}$ and $\phi_g = 0$. The new position of E_r (the resultant e.m.f.) is substantially the same angle ahead of the current I , since R and L have not changed materially, but E_r is smaller than before because I is less for the same load. The new value of E_m (the motor e.m.f.) is obtained by completing the parallelogram of which OE_g is one side and $E_g E_r$ another. This new position and value of E_m are shown by the line OE_m , which is longer than in the preceding case. This increase can be brought about only in one way, *i.e.*, by increasing the strength of the motor field, because the speed is synchronous and therefore constant.

In Fig. 83, C, let us assume a motor load of the same amount as in the two preceding instances, but with the current leading the line e.m.f. by an angle ϕ_g equal to the lag in the first case (Fig. 83, A). The angle θ between E_r and I remains practically constant because R has not changed and L only slightly. Lay off OE_r as the resultant e.m.f. an angle θ ahead of OI . Completing the parallelogram we have OE_m representing the phase and value of the motor e.m.f. that corresponds to these new conditions. An inspection of this diagram shows that the motor e.m.f. (E_m) is now of still larger value. In fact the field strength of the synchronous motor can be increased so much that the motor e.m.f. is considerably greater than the line e.m.f., the result being that the angle ϕ_g becomes a large leading one; which condition is shown in Fig. 83, D. Hence, if the motor field is gradually strengthened the line current can be made ultimately to lead the line e.m.f. This phenomenon of the synchronous motor is of value in the transmission of power, since a *super-excited motor can be employed to raise the power-factor of the circuit*, which usually tends to have a lagging current.

Torque Conditions of Synchronous Motor depending upon Angle between Current and Motor E.M.F. — The current flowing in the armature of a synchronous motor may have one of three general phase relations with respect to the motor e.m.f. or E_m . This phase angle may be 180 degrees (Fig. 84, A) because *motor* action is here considered, the same relation existing in a d. c. motor; it may be less than 180 degrees (Fig. 84, B) or it may be more than 180 degrees (Fig. 84, C).

The most efficient condition for motor output exists in the first case when the phase angle between E_m and I_a is 180 degrees, since then the current required to produce the desired torque is a mini-

mum. This may be proven as follows: In Fig. 85, A, the wave diagrams of current and e.m.f. are shown with a phase displacement of 180 degrees; the resulting power curve P being negative at every instant; thus for a given area (representing motor power) the

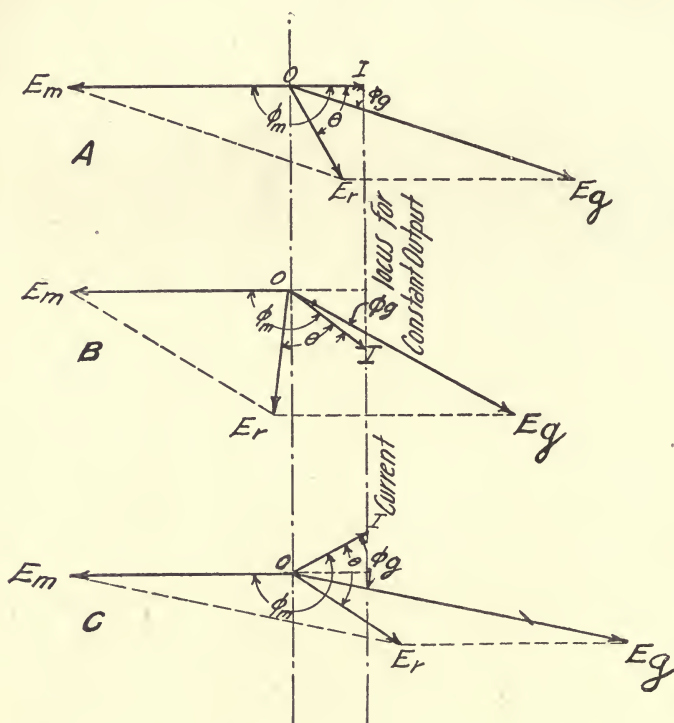

FIG. 84, A, B, AND C.—VARIOUS PHASE RELATIONS OF SYNCHRONOUS MOTOR E.M.F. AND CURRENT WITH CONSTANT OUTPUT.

value of I will be a minimum. This condition is also shown by the equation $E_m I \cos \phi_m = \text{motor power}$; because $\cos \phi_m$ has its maximum negative value $= -1$, when $\phi_m = 180$ degrees; hence to produce a given power with E_m constant, I will have minimum value. In Fig. 85, B, the wave diagram shows the current displaced less than 180 degrees with respect to motor e.m.f., in which case the resulting power wave has both negative and positive values; hence with a given current the motor power represented by the negative area is not only smaller than in the preceding case but is still further diminished by the positive area, so that the available

motor power is considerably less than when the current and e.m.f. differ by 180 degrees. Therefore, to have the same power the current must be greater in the second case (Fig. 85, B). Evidently similar conclusions apply when the current leads the motor e.m.f.

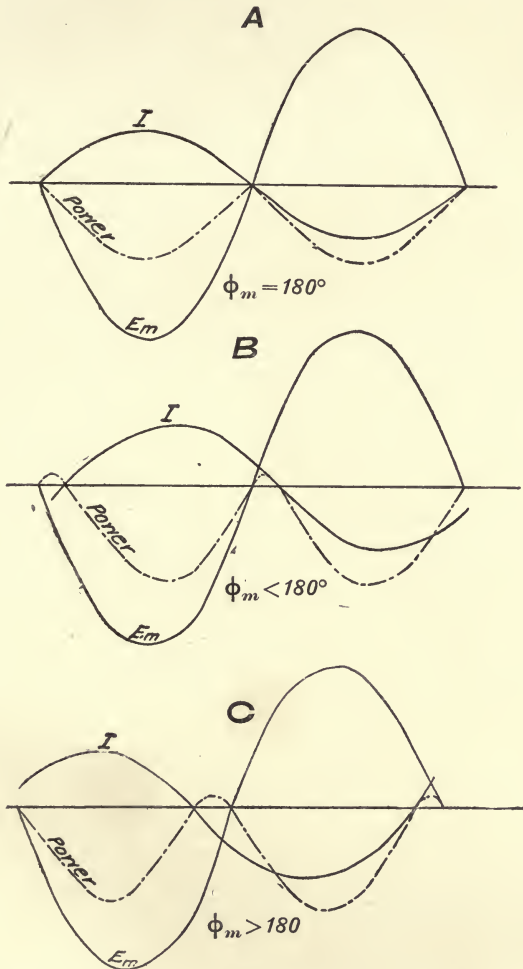

FIG. 85, A, B AND C. — POWER CURVES WITH $\phi_m =, <, > 180^\circ$.

as shown in Fig. 85, c. There is also another effect when the current and motor e.m.f. differ less or more than 180 degrees in phase; namely a strengthening or weakening of the motor field. For example, if the phase displacement between current and motor

e.m.f. is 180 degrees, the current reaches its maximum at the same instant as the e.m.f., which condition is represented by the position of the armature in Fig. 86. In this case the armature current

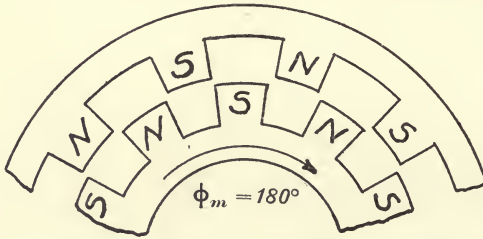

FIG. 86.—ANGLE BETWEEN E_m AND LINE CURRENT IS 180° DISTORTION OF MAIN FIELD.

neither magnetizes nor demagnetizes the field, with the moderate flux densities adopted for a. c. machinery. The effect is merely to distort the field, since the *N* poles of the armature increase the flux at the *S* poles of the field and diminish it equally at the *N* field poles — a similar balanced effect being produced by the *S* armature poles.

If the armature current lags less than 180 degrees behind the motor e.m.f. it reaches its maximum value at the instant indicated in Fig. 87. An inspection of this diagram shows that the field

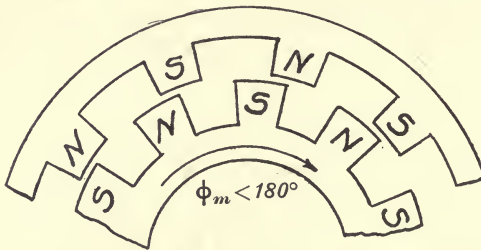

FIG. 87.—ANGLE BETWEEN E_m AND LINE CURRENT LESS THAN 180° ; MOTOR FIELD STRENGTHENED.

strength of the motor is increased because the flux direction of the armature favors that of the field.

If the armature current leads the motor e.m.f., that is, the phase difference is more than 180 degrees, then this current attains its maximum before the armature reaches the position of maximum e.m.f. as shown in Fig. 88. The result with this phase relation is a

weakening of the main field due to the opposition of the armature magnetization, like poles being contiguous.

A summary of the preceding facts is as follows.

1. For a given current a motor develops maximum torque when the phase angle between its e.m.f. (E_m) and the armature current (I) is 180 degrees.

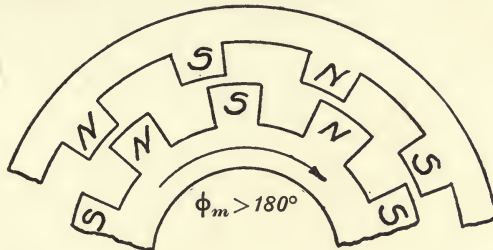

FIG. 88.— ANGLE BETWEEN E_m AND LINE CURRENT MORE THAN 180° ;
MOTOR FIELD WEAKENED.

2. When E_m and I differ in phase by more or less than 180 degrees the torque for a given value of I is less than when the phase angle is 180 degrees.

3. When the phase angle ϕ_m is 180 degrees the armature reaction merely distorts the field, because one pole tip is strengthened as much as the other is weakened, with ordinary flux density.

4. When the angle ϕ_m is less than 180 degrees (line current lagging with respect to E_m) the armature reaction strengthens motor field.

5. When the angle ϕ_m is more than 180 degrees (I leading E_m) the armature reaction weakens motor field.

6. The condition of lagging current with respect to motor e.m.f. ($\phi < 180$ degrees) gives more stable operation than the others because the increase of field strength augments the torque of the motor, tending thus to hold it in step.

Conditions of Maximum Output.—Various relations between the maximum motor output, line voltage E_θ , motor constants R , L , and I , the motor current, can be calculated. They are only of theoretical interest, however, and that of a low order, because the motor windings would be destroyed long before these conditions could be reached.

For example, a typical 138-kw. synchronous motor has an arma-

ture resistance of 0.13 ohm, the voltage across the terminals is 1443 volts, and for theoretical maximum output the current would be

$$I = \frac{E}{2R} = \frac{1443}{0.26} = 5550 \text{ amperes, which is about } 55 \text{ times its rated}$$

load current of 102 amperes, the heating effect being $55^2 = 3025$ times the normal. The corresponding values of maximum watts output and voltage have also been calculated, but the above preposterous result demonstrates that little time should be spent in determining or discussing such imaginary conditions.

Operative Limits of Synchronous Motor. — The rotation of a synchronous motor, as already explained, is absolutely dependent upon the maintenance of synchronous relation with the line voltage. Hence the driving power is exerted through a relatively easily broken link, somewhat flexible it is true, but not so strong as that of the series, shunt, or induction motors. These *gradually* drop in speed and finally become stalled upon application of excessive overload; whereas the stoppage of a synchronous motor is very sudden.

This abrupt stopping of a synchronous motor is due to the very fact upon which the ability of the machine to carry variable loads depends; namely, the phase swing of the armature e.m.f. with respect to the line voltage as load comes on, thus increasing the resultant pressure and armature current. This retardation of the motor armature cannot indefinitely increase its driving power, because ultimately the phase angle between motor voltage and current approaches 90 degrees. At this point the power falls to zero ($E_m I \cos \phi_m = 0$) and the machine stops, if it has not already done so before the 90-degree limit is reached. Practically, the stopping would occur before ϕ_m is reduced to 90 degrees, because the driving power must be sufficient to overcome the core losses, windage, friction, etc., plus any external load.

Investigation of the operative range curves (Fig. 89) of the synchronous motor indicates that it has two conditions of operation, namely, a stable and an unstable one. The unstable condition of operation exists when the phase angle between armature and line voltages is less than a certain value, ranging between 100 degrees and 120 degrees, depending upon the resistance and reactance of the motor armature. Thus, if the motor should be operating on the unstable portion of the curve, that is, between zero and about

110 degrees, any attempt to increase the load would be accompanied by retardation of the armature, which would not, however, augment the driving power of the machine; with the result that the synchronous link is broken and rotation ceases. Conversely, while operating

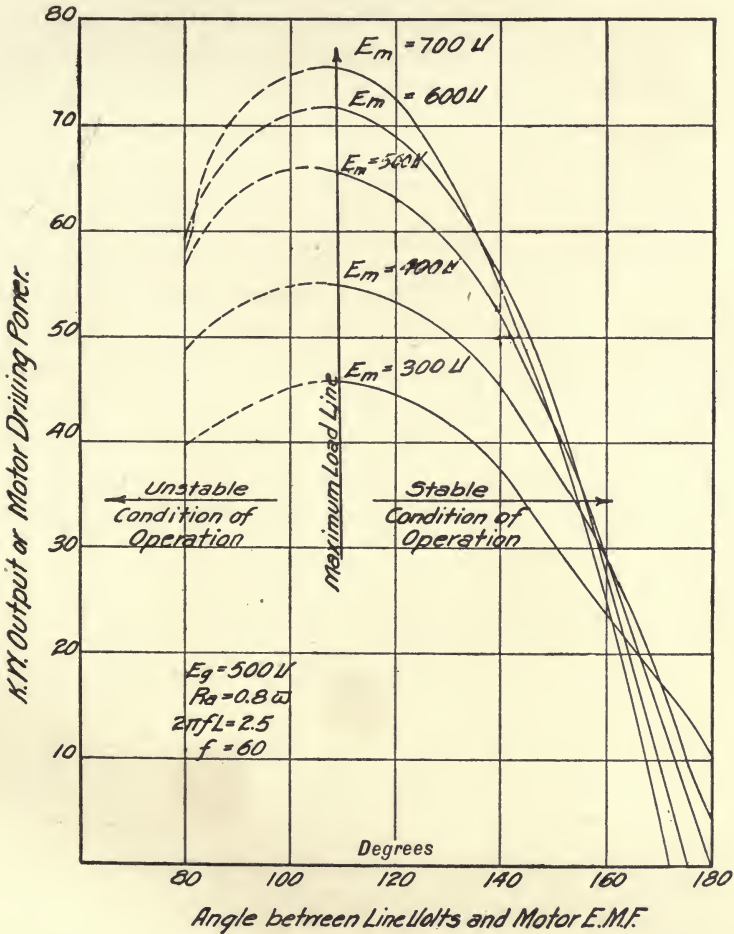

FIG. 89. — OPERATIVE-RANGE CURVES OF A 30-KW. 500-VOLT SINGLE-PHASE SYNCHRONOUS MOTOR.

on this unstable portion of the curve, if the motor load be decreased, acceleration of the armature results, which augments the driving power of the machine, and acceleration is continued until the crest of the power curve is passed and the stable condition reached.

The stable condition of operation for synchronous motors exists when addition of load causes a retardation of the armature with increase of driving power until load and driving power balance. If, however, it be attempted to overload the motor considerably, the resulting retardation of the armature causes the angle between the motor e.m.f. and line voltage to decrease so that it is less than the value corresponding to that of maximum driving effort; therefore the motor passes into the unstable condition of operation and stops. If the load on the motor be decreased while the motor is operating on the stable portion of the curve, the armature is accelerated and the driving power decreased until a balance is obtained.

The range of driving power, and thus the capacity of a given synchronous motor, depend upon its field excitation and armature constants (resistance and reactance of its winding). The driving power of such a machine is generally greater the stronger its field, within the limits attainable in practice. For different machines, other things being equal, that one having the larger impedance angle ($\tan^{-1} 2 \pi fL \div R$) has the higher overload capacity or greater stability.

The approximate operative range of any synchronous motor for various conditions of excitation can be predetermined if the line

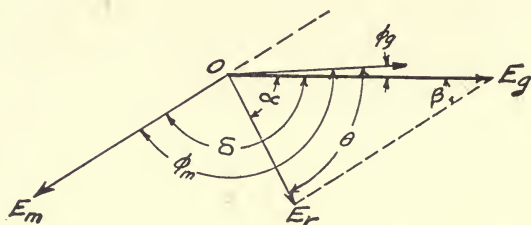

FIG. 90. — GENERAL VECTOR RELATIONS OF LINE VOLTAGE, CURRENT AND MOTOR E.M.F.

voltage, armature e.m.f., resistance, inductance and frequency are known. The equations for this calculation are obtained from the ordinary diagram showing the vector or space relations between the line voltage, current and armature e.m.f. Inspection of Fig. 90 shows that the resultant voltage

$$E_r = \sqrt{E_m^2 + E_g^2 + 2 E_m E_g \cos \delta}, \quad (19)$$

where δ is the angular relation between motor and line voltages. From this value the armature current can be obtained by dividing the resultant voltage by the armature impedance, thus:

$$I = E_r \div Z = \frac{\sqrt{E_m^2 + E_g^2 + 2 E_m E_g \cos \delta}}{\sqrt{R^2 + (2 \pi f L)^2}} \tag{20}$$

The driving power of the motor, or that portion of the input converted into mechanical power, is

$$W_m = E_m I \cos \phi_m,$$

ϕ_m being the angle between motor voltage and line current. The value of this angle ϕ_m depends upon the phase relation between line voltage and armature e.m.f., the value of these voltages and the constants of the armature circuit or

$$\phi_m = \delta + \theta - \cos^{-1} \frac{E_g + E_m \cos \delta}{E_r} \tag{21}$$

Thus

$$W_m = \frac{\sqrt{E_m^2 + E_g^2 + 2 E_m E_g \cos \delta}}{Z} \times E_m \cos \left(\delta + \theta - \cos^{-1} \frac{E_g + E_m \cos \delta}{E_r} \right), \tag{22}$$

where θ is the impedance angle of the motor armature. These equations will now be applied to the determination of the characteristic curves of the following synchronous motor:

Rated capacity.....	40 h.p. or 30 kw.
Speed.....	900 r.p.m.
Poles.....	8
Frequency (f).....	60 periods per sec.
Line voltage (E_g).....	500
Armature resistance (R).....	0.8 ohm
Armature reactance at 60 p.p.s. (X).....	2.5 ohms
Armature impedance at 60 p.p.s. (Z).....	2.63 ohms
Impedance angle of motor armature (θ).....	71° 30'
Stray power losses at 500 volts excitation and 900 r.p.m.	2.40 kw.

Let us for example determine the various values of armature current (I), of motor input W_g , and of motor output W_m , when both line (E_g) and motor (E_m) voltages are 500 volts, and the phase angle between E_g and E_m altered from 80 degrees to 180 degrees in

steps of 20 degrees. Proceeding for $\delta = 80$ degrees and $E_g = E_m = 500$ volts, we have from equation (19) p. 150,

$$E_r = \sqrt{(500)^2 + (500)^2 + 2 (500) (500) \cos 80^\circ} = 766 \text{ volts.}$$

From eq. (20), $I = E_r \div z = 766 \div 2.63 = 291$ amps.

From eq. (21), $\phi_m = 80^\circ + 71^\circ 30' - \cos^{-1} \frac{500 + 500 \cos 80^\circ}{766} = 111^\circ 30'$.
 $\cos \phi_m = - .368$.

From eq. (22),

$$W_m \text{ or motor output} = 500 \times - 291 \times .368 = - 53.5 \text{ kw.}$$

$$\phi_g = \phi_m - \delta = 111^\circ 30' - 80^\circ = 31^\circ 30'; \cos \phi_g = + .852.$$

$$W_g = 500 \times 291 \times .852 = 124 \text{ kw.}$$

The same steps could be followed out in deriving corresponding values of E_r , I , W_m , etc., when δ is varied. Collecting the results of such calculations and tabulating them we have:

δ .	E_r , volts.	$I = \frac{E_r}{Z}$, amps.	ϕ_m .	$\cos \phi_m$.	W_m , kw.	ϕ_g .	$\cos \phi_g$.	W_g , kw.
80°	766	291	111° 30'	-.368	-53.5	31° 30'	.852	124.0
100°	643	245	122°	-.530	-66.0	22°	.927	115.3
120°	500	190	132°	-.669	-63.5	12°	.978	93.0
140°	350	128	142°	-.783	-52.5	2°	.999	64.4
160°	175	66	152°	-.883	-29.6	-8°	.990	32.9
180°	0	0	0

A curve plotted between the listed values of δ° and W_m as abscissae and ordinates respectively gives the 500-volt load-range curve shown in Fig. 89. The corresponding curves for 300, 400, 600, and 700 volts indicated in the same figure could be obtained in the same manner, though for convenience the authors employed the circle diagrams shown later, on pages 155, 156.

It is to be noted that the possible load capacity of this machine is greatest at the highest field excitation considered; but at these heavier loads the armature current is excessive, as shown in Fig. 95. When excited so that its armature produces 500 volts counter e.m.f. the motor has about 80 per cent overload capacity before instability is reached. At greater excitations, for example at 600 volts, the

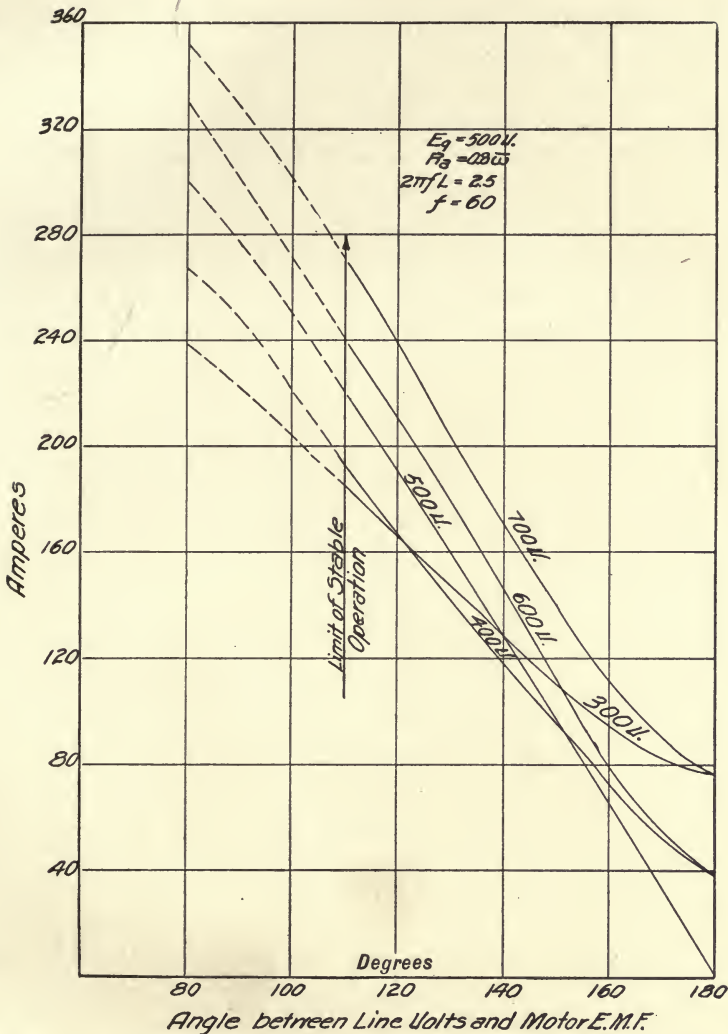

FIG. 91. — "CURRENT-PHASE SWING ANGLE" CURVES OF 30-KW. SINGLE-PHASE SYNCHRONOUS MOTOR.

crest of the power curve occurs at 140 per cent overload. The important fact follows that with a synchronous motor liable to be subjected to widely variable loads, greater stability is obtained by adjusting its field excitation so that the armature e.m.f. is equal to or somewhat greater than the line voltage. Increase of armature voltage should not, however, be carried very high, since the current for a given load thereby becomes too great, causing excessive heating

of the machine. For example, the armature current for 30 kw. at 500 volts is 70 amperes; at 600 volts, 82 amperes; and at 700 volts, 120 amperes. The curves between current and phase angle given in Fig. 91 are derived from the values of δ and I in the table just preceding. These show that as the angle between line e.m.f. and motor e.m.f. becomes smaller the current increases rapidly.

Circle Diagrams of Synchronous Motor. — If we consider a given line voltage and armature e.m.f. of a synchronous motor, and plot the vector positions and relative values of line voltage, armature e.m.f., resultant voltage and current through a phase swing of 180 degrees, it is found that while naturally the locus of the motor voltage is a circle, the loci of the resultant voltage and armature current are also circles. The centers of these circles are at different points. These circle diagrams of the synchronous motor are useful, and by their application the values of E_r , I , and ϕ_m can be directly determined and thus the power or operative load range curves of the motor obtained without the lengthy calculations based upon the preceding equations. One set of circle diagrams is required for each motor excitation. Their construction and application are as follows: Lay off in a horizontal direction and to scale the line OE_g (Fig. 92) representing the line voltage, then add to it, in the same direction, the line E_gE_m' which corresponds with and is proportional to the motor e.m.f.; also, lay off to the left of E_g a distance proportional to and representing the motor voltage as above. Then with E_g as a center and E_gE_m' as a radius describe a circle. This is the locus of the resultant voltage E_r . Its maximum value is proportional to the distance from O , through E_g to E_m , while its minimum value is the distance along the same diameter from O to the point at which this diameter cuts the left-hand side of the circumference; that is, the length OQ . With the point O as a center describe a circle having a radius representing and proportional to E_m . This is the locus of the motor voltage. Through the point O draw the line OK so that it makes an angle θ (the impedance angle = $\tan^{-1} \frac{2 \pi fL}{R}$) with the horizontal line OE_g . The location of the point K is obtained by using the point O as a center and a radius equal to OE_m' ; that is, OK is equal to OE_m' . Then from the point K along the line OK towards O lay off a distance equal to E_m and with this new point P as a center and PK as a radius describe a circle. This repre-

sents the locus of the current vector and is proportional thereto, being the impedance drop, which is numerically, for any vector position, equal to the amperes multiplied by the impedance Z . The maximum current position is represented by the line OK , which is numerically equal to $OK \div Z$, being obtained when the motor voltage and line voltage are in phase (*i.e.*, 360 degrees displacement existing between them). The minimum value of the current is the distance OL divided by the impedance, and is obtained when the motor voltage is 180 degrees from the line voltage. Three sets of circle diagrams are given. The first of these (Fig. 92) shows the

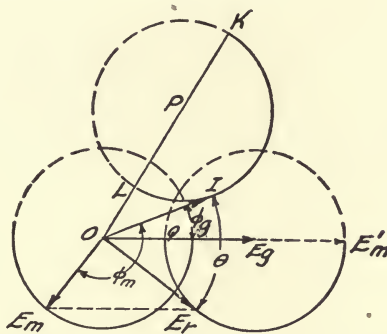

FIG. 92. — CIRCLE DIAGRAM OF SYNCHRONOUS MOTOR; $E_g = 500$ VOLTS, $E_m = 300$ VOLTS, $\theta = 60^\circ$.

loci of resultant voltage, motor voltage and current, when the motor voltage is 300 and the line voltage 500 volts. The second circle diagram (Fig. 93) illustrates the corresponding loci when motor and line e.m.f. are each 500 volts; and the third diagram (Fig. 94) sets forth the loci when the motor voltage is 700 and the line voltage 500 volts. Consider the first diagram, and let it be desired to obtain the resultant voltage, motor current, value of ϕ_m , and driving power of motor when the angle between the motor voltage and the line voltage is 130 degrees. The procedure is as follows: From the point O draw the line OE_m so that it makes an angle of 130 degrees with OE_g . This represents the angular position of the motor voltage with respect to the line voltage. Then with the point E_m as a center and a radius equal to OE_g describe an arc which cuts the resultant voltage vector locus at the point E_r . OE_r represents the scale value ($= 375$ v.) of the resultant voltage and its correct angular position. With O as a center and with the distance OE_r as a radius describe an arc inter-

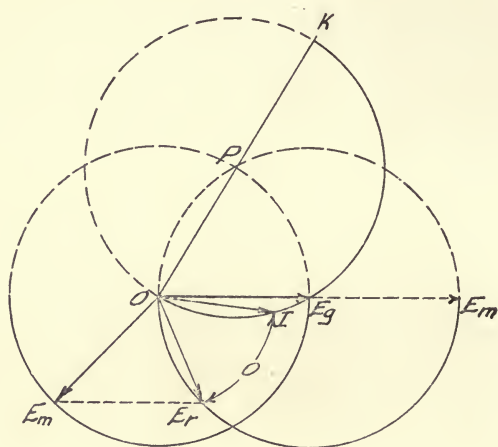

FIG. 93. — CIRCLE DIAGRAM OF SYNCHRONOUS MOTOR ;
 $E_g = 500$ VOLTS, $E_m = 500$ VOLTS, $\theta = 60^\circ$.

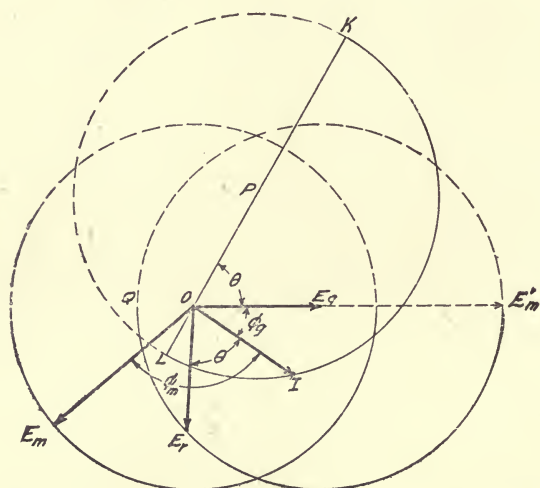

FIG. 94. — CIRCLE DIAGRAM OF SYNCHRONOUS MOTOR ; $E_g = 500$ VOLTS,
 $E_m = 700$ VOLTS, $\theta = 60^\circ$.

secting the current vector locus at the point I . The line OI represents the true vectorial position of the armature current, and if its scale value be divided by the impedance, the correct value of this current is given in amperes ($\frac{325}{2.2} = 146$). The angle contained between E_mOI is the angle ϕ_m , and its value (166 degrees) can be measured on the motor voltage circle. The product then of E_mI

$\cos \phi_m$ gives the motor driving power, or $300 \times 146 \times -0.97 = -42.5$ kw.

Various angular positions between E_g and E_m can similarly be assumed, the motor current and driving power determined as

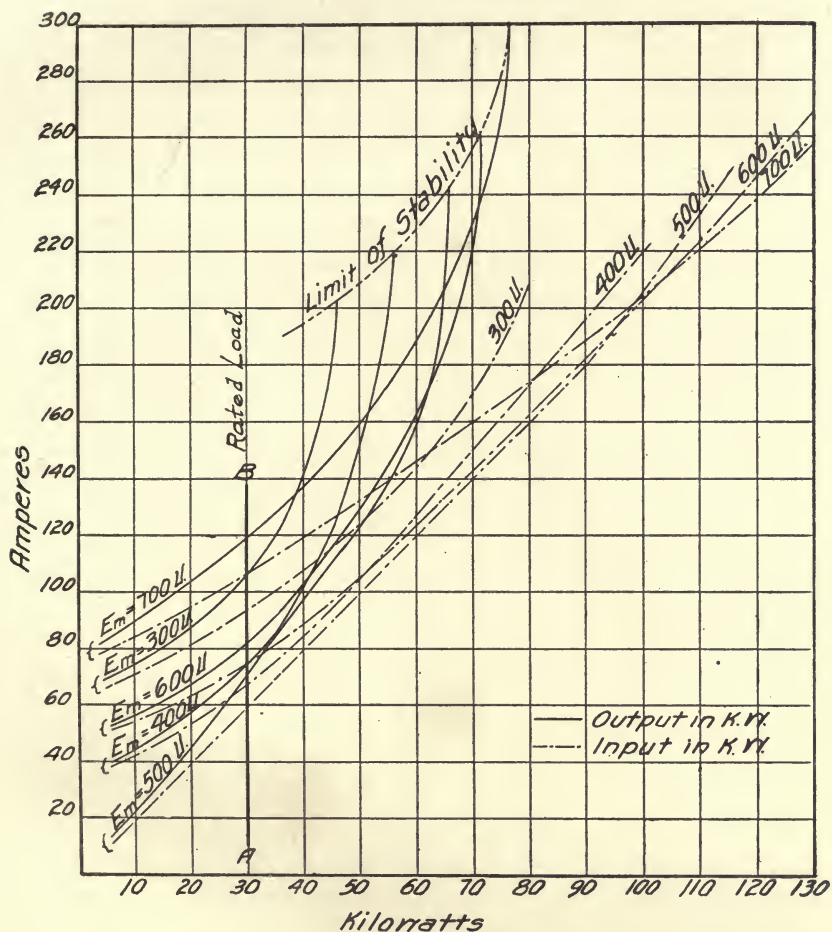

FIG. 95. — CURRENT-POWER CURVES, 30-KW. SYNCHRONOUS MOTOR.

shown, and these different values plotted as ordinates with the phase angle between E_g and E_m as abscissæ; the result being the motor "load-range curves" and "current curves" shown in Figs. 89, 90 and 95, respectively, of which the 500-volt series were obtained by calculation, using equations (19) to (22). It can very readily

be seen by means of the operative range curves what angle between motor voltage and line voltage represents the pulling out or stopping condition. This occurs with the typical 40-h.p. motor examined when the angle E_mOI is a little less than 110 degrees.

V Curves of the Synchronous Motor. — All the working characteristics of a synchronous motor can be determined from its *operative load range* curves, which were derived and discussed in the preceding pages. For example, the *current-power* curves are obtained by plotting curves, having corresponding current values as ordinates and kilowatts as abscissæ. Two sets of *current-power curves* exist (Fig. 95); one group showing the relation between current and output or driving power, and the other between current and armature input. The armature watts input are determined by adding the corresponding I^2R_a losses and watts output.

The characteristic *V curves* of the synchronous motor are readily determined from the *current-power* input curves, by proceeding as follows: Assume any constant input, say 30-kw., then draw the straight line AB vertically through the 30-kw. abscissa point of the current-power curve (see Fig. 95), and from the intersection of the line AB with the different input curves we can determine the various armature currents. For example, at 300 volts this current is 93 amps., at 400 volts it is 68 amps., at 500 volts 60 amps., etc. The relation existing between the motor e.m.f.'s and these current values used as abscissæ and ordinates, respectively, gives the 30-kw. *current V curve* for the motor of the text. The complete series of these *V curves* given in Fig. 96 were obtained by following a like procedure for the different values of input employed.

A study of these curves indicates that at any given input, as the motor voltage is increased the armature current decreases, until a minimum value is reached, after which, upon further strengthening of the motor field, the current begins to increase. The variation in the armature current for a given range of field excitation is greater at the lighter loads, and the curve obtained when the motor is running practically without load is of substantially a V shape, hence the name; while at the higher loads the curve flattens out considerably, appearing like an arc of a large circle at rated load input and beyond. These same *V curves* can be determined by calculation, employing a formula which is derived from the simple vector relations existing between line volts, motor volts,

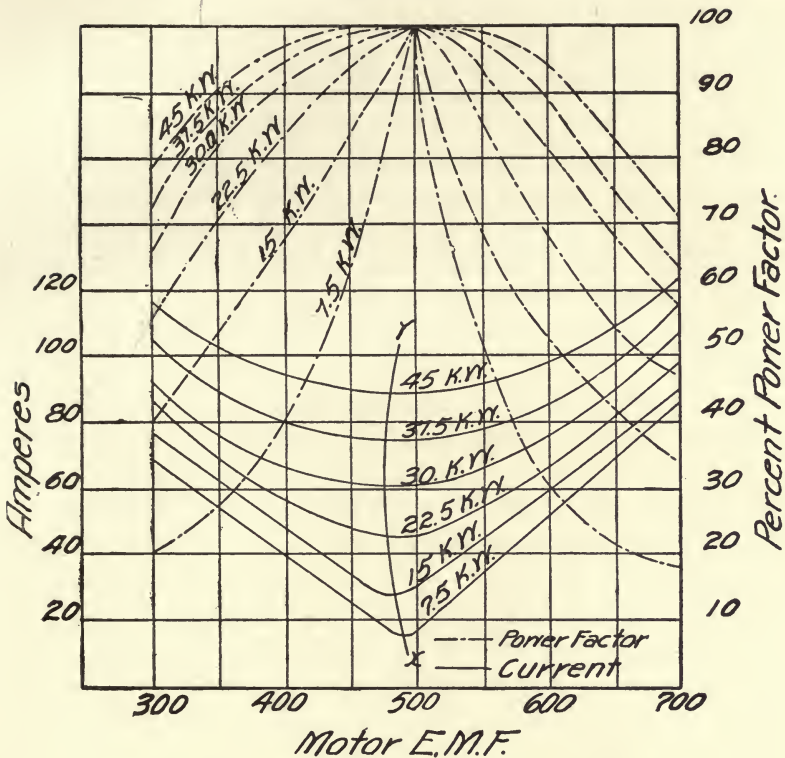

FIG. 96. — CURVES OF 30-KW. SYNCHRONOUS MOTOR.

and current in the case of a synchronous motor, this equation being

$$E_m = \sqrt{(E_g \cos \phi_g - IR_a)^2 + (E_g \sin \phi_g - IX)^2} \quad (23)$$

but its use is rather tedious.

* From vector diagram, Fig. 90, it is apparent that

$$E_m^2 = E_g^2 + E_r^2 - 2 E_g E_r \cos (\theta - \phi_g) \quad (A)$$

wherein

$$E_g^2 = E_g^2 (\cos^2 \phi_g + \sin^2 \phi_g).$$

$$E_r^2 = \bar{I}Z^2 = I^2 (R^2 + X^2). \quad \theta = \cos^{-1} \frac{R}{Z} = \sin^{-1} \frac{X}{Z}.$$

$$\cos (\theta - \phi_g) = \cos \theta \cos \phi_g + \sin \theta \sin \phi_g = \frac{R}{Z} \cos \phi_g + \frac{X}{Z} \sin \phi_g.$$

Substituting the above for their equivalent terms in equation (A) we have

$$\begin{aligned} E_m^2 &= E_g^2 \cos^2 \phi_g - 2 I R E_g \cos \phi_g + I^2 R^2 + E_g^2 \sin^2 \phi_g - 2 I X E_g \sin \phi_g + I^2 X^2 \\ &= (E_g \cos \phi_g - IR)^2 + (E_g \sin \phi_g - IX)^2 \end{aligned}$$

$$\text{or } E_m = \sqrt{(E_g \cos \phi_g - IR)^2 + (E_g \sin \phi_g - IX)^2} \quad (B)$$

which equation expresses the value of the motor e.m.f. in terms of the line voltage, current, phase angle, and armature constants.

A second set of these V curves is obtainable from the current-power curve, namely, those showing the relation between power factor and field excitation. These are determined as follows: Assume any condition of constant input and let this, as before, be 30 kw.; then refer to the current-power curves (Fig. 95) and multiply the current at any motor e.m.f. by the line voltage. This product is the volt-amperes input. A division of the corresponding abscissa value (which was 30 kw. input in this instance) by the volt-amperes gives the power factor at the selected field excitation and input. The curves obtained by using the power factor and the corresponding motor e.m.f.'s as ordinates and abscissæ, respectively, are those represented by the broken lines in Fig. 96. It is to be noted that these are the converse in shape of the current V curves. The power factor rises with field excitation up to about unity at 500 volts, but as the field strength of the motor is still further augmented the power factor decreases, even more rapidly than it rose. It is also apparent that the power factor of the machine is improved by addition of load to the motor.

Reference to these curves (Fig. 96) and to the formula for motor e.m.f. (E_m) shows that the smaller values of motor e.m.f. exist when ϕ_θ is a lagging angle, because then $\sin \phi_\theta$ is plus. The larger values of the motor e.m.f. exist when ϕ_θ is a leading angle, $\sin \phi_\theta$ then being minus, which increases the second term under the radical and consequently E_m is greater. Hence, variation of the motor excitation produces a change in the angle between line volts and motor current. Low field excitations cause a lagging current to flow and high excitations draw a leading current. Thus a synchronous motor whose e.m.f. is greater than that of the line (motor super-excited) draws a leading current and acts as if it possessed electrostatic capacity.

The above property of the synchronous motor, used as such or as a rotary converter, is frequently utilized to improve the power factor of long-distance transmission systems, because when energy is supplied to induction motor loads they are apt to produce a very low power factor, (p. 192) necessitating a large lagging current to be transmitted. This condition not only increases the line drop but also interferes seriously with alternator regulation. The installation of a super-excited synchronous motor at the receiving end of a line reduces this angle of lag by drawing a leading current.

In fact, the motor field can be so adjusted that the phase displacement between line voltage and current becomes small or even nil.

Balancing Action of Synchronous Motor. — The fact that a synchronous motor draws a leading current when super-excited, and that the extent of lead is increased with the degree of super-excitation, gives to this type of polyphase machine the property of restoring a balance to an unbalanced polyphase circuit. When a slightly super-excited motor is connected to the terminals of a balanced or an unbalanced polyphase system, all phases of the motor armature draw a leading current. That phase winding, however, which is connected across the line terminals of lower voltage draws a current of greater lead than the other windings because its super-excitation is relatively higher; hence, the compounding tendency of the leading current is more marked in this phase than in the others and the voltage thereof is increased. This action tends to balance the circuit, not only in voltage but in current as well, because combinations of leading and lagging currents give reduced resultant currents.

Hunting of Synchronous Motor. — A trouble which sometimes arises in connection with synchronous motors is that of *hunting*, *pumping*, or *phase swinging*. These terms signify the periodic fluctuations in speed and armature current occurring under certain conditions. Such surgings may be produced by several causes. Let us suppose the typical motor to be running at a constant load up to a certain instant, and that then the load is suddenly varied, say increased. A momentary retardation of the motor armature naturally results, and we see from power curves (Fig. 89) that the angle between E_m and E_g must decrease to allow of increase in the driving power of the motor. The proper value of armature current is not obtained at the instant that the correct phase angle between E_m and E_g exists, but somewhat later, owing to time lag caused by inertia and the inductance of the armature winding. Thus, while the armature may momentarily pass through the right angular relation with respect to the line e.m.f., it will ultimately draw more current than its load requires. This causes the armature to be accelerated and the angle (δ) between E_m and E_g is increased beyond its proper value, until the driving torque is so much reduced as to be insufficient for the motor load, whereupon lagging or retardation of the armature again ensues, and so on. This *phase swinging* of the arma-

ture and *current variation* accompanying are included under the term *hunting*. The amplitude of this swinging or pendular motion usually dies down, due to frictional, eddy current, and hysteretic effects, so that the armature finally finds its correct load position. The irregular rotation above considered may be regarded as consisting of a uniform motion of rotation at synchronous speed with a to-and-fro or pendular motion superposed upon it.

We see, therefore, that a change of load upon a synchronous motor will produce oscillations in its angular velocity and armature current. There are, however, other actions by which such fluctuations may be started. Assume the motor load to remain quite constant but the speed of the generator to undergo a sudden rise. This corresponds to an advance of the angular position of the line voltage vector, which naturally decreases the angle between E_m and E_g , thus increasing the driving torque of the synchronous motor (see operative-range curves, Fig. 89), and producing an acceleration, which will, as already shown, develop the hunting phenomenon. Similarly a sudden change in excitation of the motor or in the line voltage will produce a variation in the motor torque and thus bring about the phase surging action. This fluctuation is very slow compared with the line frequency, and its period can be readily determined by the violent swinging of the needle of an ammeter connected in the supply line.

As already stated, the *hunting* started by any one sudden disturbance will gradually subside. If, however, before the oscillations due to one cause have been damped out, another disturbance should occur of such nature as to reënforce the already existing fluctuations, their combined amplitude may become so great as to cause the motor armature to swing beyond the range of stability, with the result that it falls out of step and stops. This action is likely to occur, because sudden load changes are usually accompanied by marked variations in line voltage, both acting to produce a like effect. The surges of the armature current thus developed may affect the alternator speed, and then all three disturbing factors act in unison. If the phase swinging is not violent enough to cause the motor to pull out of step, the variation thus produced in the line voltage may be, nevertheless, of such low periodicity that it becomes apparent in the flickering of lamps connected to the circuit, and it may even develop hunting in other

synchronous motors fed thereby. The fact that hunting of a synchronous motor not only interferes with its own stability but may react upon other synchronous units connected to the line is very objectionable, and the prevention of marked hunting becomes a practical necessity.

Prevention of Hunting. — Inspection of the power or operative range curves of synchronous motors (Fig. 89) shows that a given

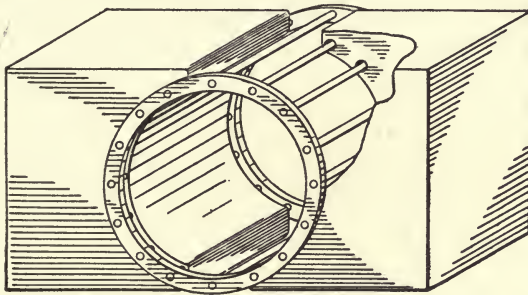

FIG. 97. — THE HUTIN AND LE BLANC AMORTISSEUR OR DAMPER.

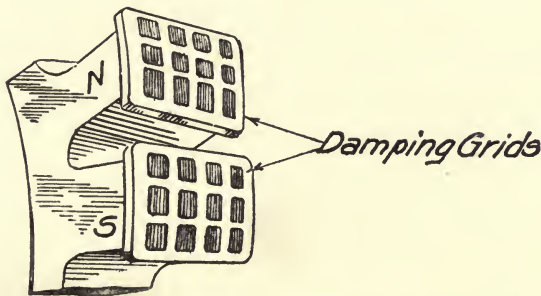

FIG. 98. — ANTI-HUNTING DEVICE.

change in torque will be obtained with a smaller phase swing when the field is strong than when it is weak, and naturally the smaller the initial phase shift the less the resulting oscillation; hence, use of strong fields is favorable in checking hunting, but this by itself will not suffice.

It has already been indicated that the production of eddy currents by the surging of the armature current tends towards the reduction of the duration of the surges, and theoretically any device wherein currents are generated by the pendular motion of the armature will act by Lenz's law to stop the motion producing them. Hence it is

necessary to design a device wherein heavy eddy currents are developed by even slight hunting tendencies, in order to arrest the surging in its very development. The devices producing this checking effect are known as *damping coils* or *dampers*. One of the earliest of these dampers was proposed by Hutin and Le Blanc* (Fig. 97), and consists of a series of thick copper bars embedded in each pole piece, parallel to the armature axis, and connected in parallel by heavy copper rings concentric with the armature. A more modern and probably more economical arrangement (Fig. 98) consists of a copper grid placed in corresponding slots cut in the polar face, the outer rim of the grid forming a closed band around the pole piece.†

* U. S. Patent No. 529,272, November 13, 1894.

† U. S. Patent No. 575,116, January 12, 1897.

For further information concerning synchronous motors see :

ALTERNATING CURRENTS, D. C. and J. P. Jackson, p. 571.

ALTERNATING CURRENT PHENOMENA. C. P. Steinmetz. 1908.

DIE WECHSELSTROMTECHNIK, Vol. IV. E. Arnold. 1904.

ELECT. ENG. POCKET-BOOK, p. 430.

LONDON INST. CIV. ENGS. J. Hopkinson. 1883.

STANDARD HAND-BOOK, p. 431. McGraw. 1908.

SYNCHRONOUS MOTOR DIAGRAMS. A. S. McAllister. *Elect. World*, August, 1907.

SYNCHRONOUS MOTORS. Prof. C. A. Adams. *Harvard Eng. Journal*, 1907.

SYNCHRONOUS MOTORS. F. G. Baum. *Electric World*, March, 1902.

Trans. A. I. E. E., Vol. XIX, 1902, p. 718. C. P. Steinmetz.

Trans. A. I. E. E., Vol. XXIII, 1904, p. 481. G. B. Lamme.

Trans. A. I. E. E., Vol. XXVI, 1907, p. 1027. M. Brooks.

CHAPTER XIV.

POLYPHASE INDUCTION MOTORS.

THE polyphase induction motor as developed through the inventions of Ferraris, Tesla, and others is undoubtedly the most important of alternating-current motors.* Two-phase or three-phase machines are employed, depending upon the system by which the current is supplied. The operation of the induction motor is very different from that of the preceding types because there is no electrical connection between the armature (usually called secondary or rotor) and the source of current supply. The motion of the armature is produced by a rotating magnetic field, and it is this peculiar field which is the characteristic of induction motors.

Production of Rotary Field. — A laminated iron ring, wound with insulated wire, as represented in Fig. 99, is supplied with two-phase or quarter-phase currents at four equidistant points *A*, *B*, *C* and *D*. Two conductors of one phase are connected at *A* and *B*, and those of the other phase across *C* and *D* respectively. The direction of the winding is such that a current entering at *A* will produce a *south* pole at this particular point and a *north* pole at *B*, therefore if a compass needle were placed inside of the ring, it would tend to point vertically upward as indicated by the dotted arrow.

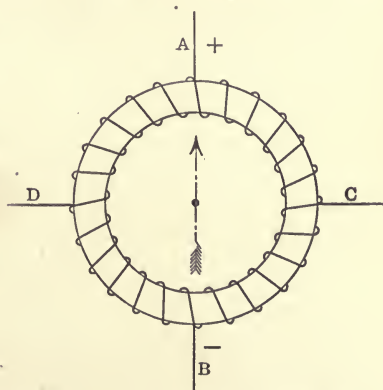

FIG. 99. — RING SUPPLIED WITH TWO-PHASE CURRENTS.

This condition is represented at 1 in Fig. 100, the current of phase *AB* having its maximum positive value, and that of phase *CD* zero value, in accordance with the usual phase difference of 90° or one-quarter period existing between two-phase currents. A moment later, *i.e.*, one-eighth of a period, the current in *AB*

* See pages 125-128.

has decreased somewhat, and the other has increased, so that they are now equal. In this case, each current will tend to produce a *south* pole where it enters the winding at *A* and *D* respectively, so that a resultant polarity is developed midway between, as shown at point 2, the arrow being inclined at an angle of 45° . The next instant, the current of phase *AB* has fallen to zero, and that of *CD* has reached its maximum, so that the needle takes the horizontal position as represented at 3 in Fig. 100. Again at 135° , the current *AB* has reversed, tending to make a south pole at *B*, the needle being inclined downward at an angle of 45° as shown at point 4. By following the successive conditions, the needle will

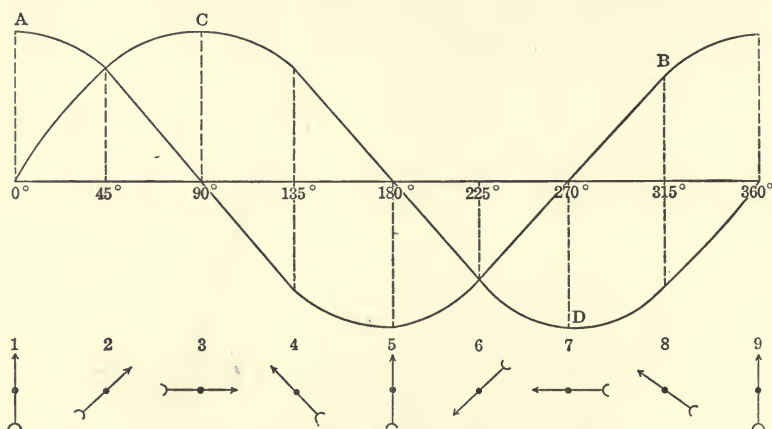

FIG. 100. — MAGNETIC RESULTANTS DUE TO TWO-PHASE CURRENTS.

be found to take the various positions represented at points 5, 6, 7, 8, and finally at 9 it assumes its original vertical direction, the current having then completed one cycle of its changes, having passed through two alternations. Thus, the compass needle tends to be rotated on its support continuously by the shifting resultant field, as long as the winding is supplied with two-phase or quarter-phase currents. If either one of the connections *AB* or *CD* (Fig. 99) were reversed, the direction of rotation of the needle would then be *counter-clockwise*, instead of *clockwise*. Hence, to reverse the direction of rotation of such a field, it is necessary to interchange the terminals of one of the two phases.

The Action of Three-Phase Currents in producing a rotary field is quite similar to that explained for two-phase currents. The

laminated ring of Fig. 101 is wound as before, but the current is led in at the three equidistant points X , Y and Z , instead of at four points, as was indicated for two-phase currents. Taking the instant when the current flowing in at X is a maximum, then currents flowing out at Y and Z each have one-half the value of that entering at X . This tends to produce a south pole at X , and two north poles at Z and Y respectively. The resultant due to the latter is a north pole at T , midway between Y and Z ; consequently a magnetic needle placed within the ring would assume the position indicated by the dotted arrow at T in Fig. 102. One-sixth of a period later, currents enter at both X and Z , and a maximum current flows out at Y ,

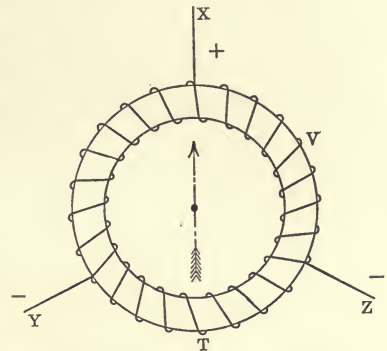

FIG. 101. — RING SUPPLIED WITH THREE-PHASE CURRENTS.

One-sixth of a period later, currents enter at both X and Z , and a maximum current flows out at Y ,

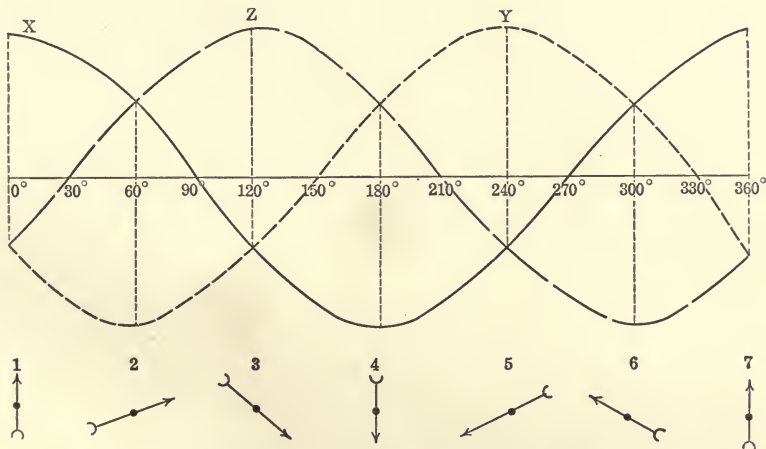

FIG. 102. — MAGNETIC RESULTANTS DUE TO THREE-PHASE CURRENTS.

hence the needle would point towards V . At the end of another one-sixth of a period, the maximum current would enter at Z , and the needle would turn to that point as shown at 3 in Fig. 102, and so on until it had made a complete revolution in one period of the alternating current. If any of the two connections shown

in Fig. 101 be transposed, the direction of rotation of the corresponding magnetic field will be reversed.

Variation of Flux with Two-Phase and Three-Phase Stator Windings. — If the stator is wound for two-phase currents as in Fig. 100 we have an induction or flux produced which varies between two limits, namely between that developed when the current in phase *AB* is a maximum, and that existing when the currents in the two phases are equal. Numerically this variation is between KI_{\max} and $2KI_{\max} \sin 45^\circ$, or proportionally between 1 and 1.414; that is, there is variation of about 20 per cent from its mean value. This variation, however, becomes considerably reduced by the effects of the rotor currents and the storage of electro-magnetic energy.

The currents in the case of the three-phase winding (Fig. 101) may be taken as $I_{\max} \sin \omega t$, $I_{\max} \sin (\omega t + 120^\circ)$ and $I_{\max} \sin (\omega t + 240^\circ)$ being represented in Fig. 102. The maximum flux is produced at the instants corresponding to positions 1, 2, 3, 4, etc., in Fig. 102, and the minimum flux is developed at instants midway in time between those shown.

The maximum value of the flux may be written

$$M_{\max} = KI_{\max} + 2KI_{\max} \sin 30^\circ = 2KI_{\max}$$

and the minimum value is

$$M_{\min} = 0 + 2KI_{\max} \sin 60^\circ = 1.73KI_{\max}.$$

Thus the flux varies between limits which are proportional to 2 and 1.73, or the variation from its mean value is approximately 7 per cent.

The above comparison would indicate that an increase in the number of phases employed to produce the flux in the stator of an induction motor would diminish the per cent variation from its mean value.

The smooth running of a motor depends to a certain extent upon the uniformity of the turning effort exerted upon the rotor, and consequently upon the regularity of the magnetic field in which it revolves. It might accordingly be supposed that the greater the number of phases for which the stator is wound, the steadier would be the action of the motor. In practice, however, this does not obtain, no noticeable difference in smoothness of rotation being found between two-phase and three-phase machines.

The particular advantage of the three-phase motor with respect to the two-phase machine is that it is more economical as regards copper for its stator winding, since the smaller current per phase of the former would produce an equivalent induction. The three-phase winding also lends itself better to the production of a simple starting device, being connected in "Y" at starting and in delta for running. In practice three-phase machines are more generally employed, because the corresponding generators, transformers, transmission lines, etc., are more economical of material.

The ring with the magnetic needle just described illustrates the *synchronous* polyphase motor, since the armature revolves in exact synchronism with the phases of the currents. If the needle is replaced by a cylinder of laminated iron wound with inductors like an ordinary armature except that they are short-circuited, it is found that this will also revolve, but in this case the speed is a little less than that of the synchronous armature. The difference in speed (angular velocity) between the rotary field and the armature divided by that of the former is called the *slip*; or denoting the slip by S , the angular velocity of the rotary field by ω_1 and that of the armature by ω_2 , we have:

$$S = \frac{\omega_1 - \omega_2}{\omega_1}. \quad (24)$$

This slip represents a relative motion of the rotating field, with respect to the armature inductors; consequently the latter are cut by lines of force and therefore currents are induced in them. Since it is the action of the field upon these induced currents which causes the armature to revolve, this type of machine is called the *induction motor*. It is to be noted that *no* current is supplied to the moving part, hence it need have no electrical connections made to it, except (as will be shown later) for purposes of starting and regulation, in which case electrical connection is necessary.

The stationary part of the typical motor is that connected to the source of current supply, and it is usually termed the *stator* or *primary*. The moving part is called the *rotor* and forms a *secondary* to the *stator*.

The terms *field* and *armature* could without error be retained, because the *primary* forms the *inducing member* or field, while the *secondary* or *rotor* is that part *acted upon* inductively, or the *armature*.

Typical Induction Motor. — The type of winding illustrated in the development of the rotary field does not lend itself to the production of a commercial machine on account of the waste of copper and its high leakage reactance.* The rotor winding and core must also be modified to suit practical conditions.

The typical stator core consists of an assemblage of thin iron or mild steel rings of about .014 to .025 inches in thickness, with teeth and slots upon the inner circumference. These slots contain a distributed drum winding of substantially the same character as the armature winding of polyphase alternators. The magnetic poles are therefore not produced by windings concentrated at certain points of the gap periphery on salient or separately projecting masses of iron as in d. c. machines. Nevertheless, magnetic poles are formed by properly connecting the groups of coils. Although a diagram as in Fig. 99 may be used to represent the stator winding for theoretical discussion, it does not portray the actual commercial machine. The windings are seldom closed-coils, the three-phase stator is usually Y connected, although certain manufacturers employ this grouping simply for starting, changing to delta connection when running.

The winding is divided into *a number of groups, equal to the product of the number of phases and the number of poles.* Fig. 103 represents the diagram of an 8-pole two-phase winding. Consider the instant when the currents in the two phases are in the same direction (that is between 0° and 90° or 180° and 270° , Fig. 100), then by tracing out the connections, it will be found that the currents circulate in the same direction in two adjacent groups. Thus a pole is formed by two groups, both phases being represented in each pole. When the current in each phase reverses (after a half cycle) the pole shifts the angular distance covered by two groups, so that the field completes one revolution in eight alternations of current. Thus if the current supplied had a frequency of 60 cycles per second, the field would make 15 revolutions per second, or 900 per minute.

To minimize the length of cross-connecting wire, it will be seen that every fourth group is connected in the same direction in each phase. A coiled arc such as *A* represents a group comprising a

* Leakage reactance is that component of the inductive reactance, due to such lines of force (stray) as are not effective in the production of torque.

certain number of coils in series, each coil being located in a separate pair of slots and the end of one being connected to the beginning of the next.

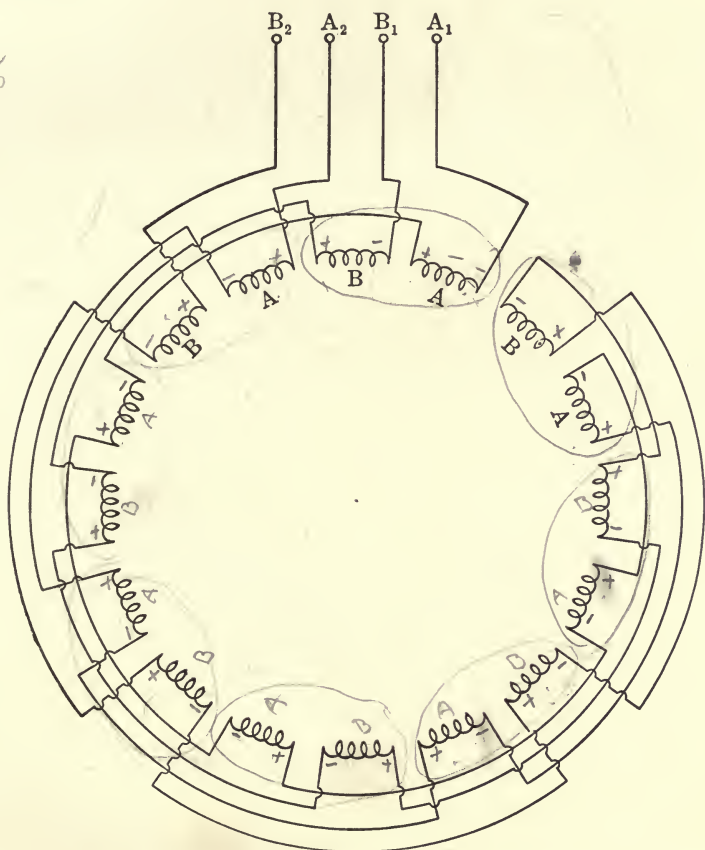

FIG. 103. — EIGHT-POLE TWO-PHASE STATOR WINDING.

A six-pole three-phase winding of 18 groups is indicated in Fig. 104. The phases are represented in counter-clockwise direction in the order A , B , C , A' , B' , C' , analogous to the two-phase winding. The phases are thus only 60 degrees apart. To get the star or Y , which is a 120-degree relation, the middle phase is reversed, as in Fig. 105, so that a pole will be formed by the three consecutive phases when the current is in the same direction in A and C , and opposite in B . The beginning of the middle coil (C), and not the end, as with the other two, is connected to the common point O .

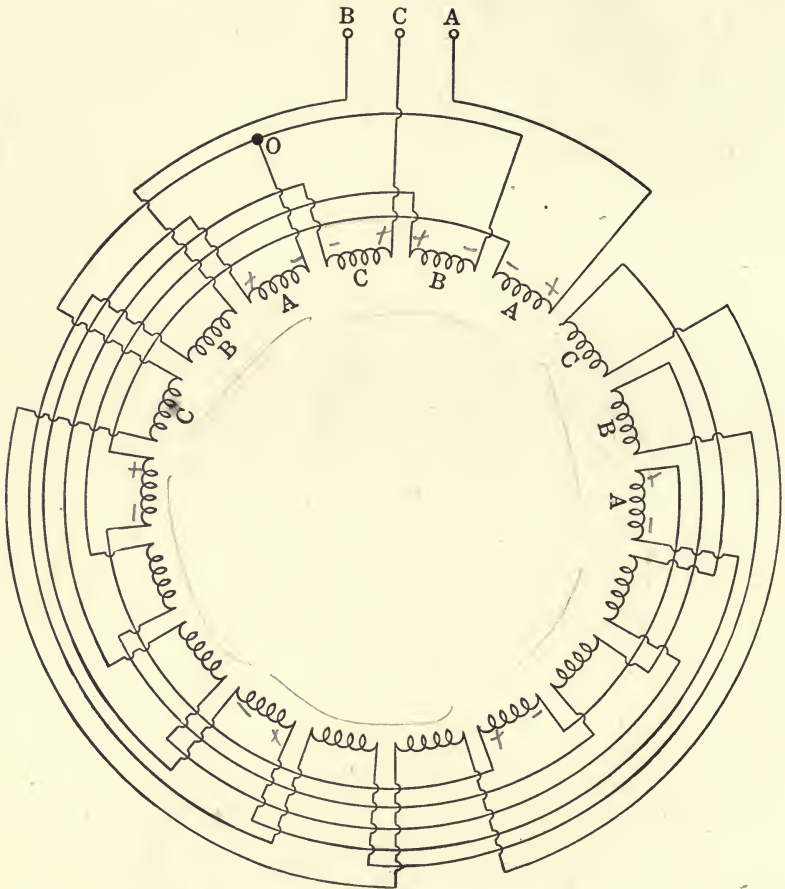

FIG. 104. — SIX-POLE THREE-PHASE STATOR WINDING.

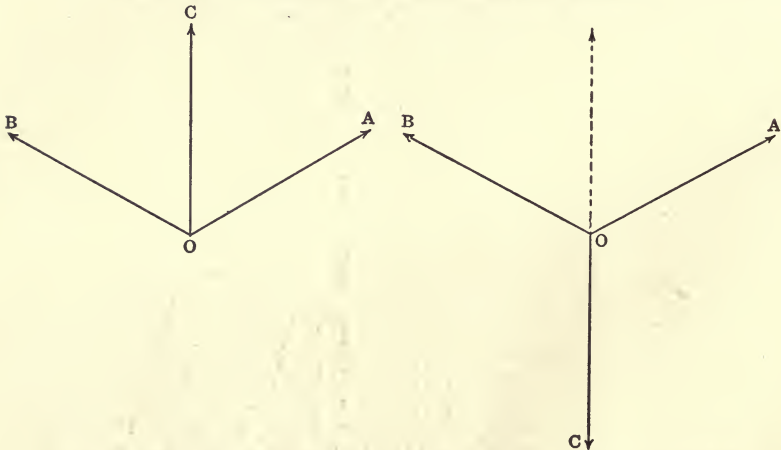

FIG. 105. — REVERSAL OF MIDDLE COIL WITH 60° SPACING TO OBTAIN 120° STAR ARRANGEMENT.

In this case the pole shifts the distance of three groups for each alternation, so that one revolution of the field is completed in three periods, making 20 r.p.s. or 1200 r.p.m. with 60 cycle current.

The speed or number of revolutions made by the rotating field accordingly depends upon the frequency as well as upon the number of poles, being directly as the former and inversely as the latter, or

$$\text{r.p.m.} = 60 \times \text{frequency} \div \text{pairs of poles.} \quad (25)$$

Since speeds of more than 1800 r.p.m. are higher than can conveniently be employed, the majority of induction motors have four, or a still greater even number of poles. For example, a group of commercial 60 cycle machines has two pairs of poles up to 5 horsepower capacity, three pairs from 7.5 to 30 horsepower, four pairs from 30 to 50 horsepower and five or six pairs for sizes between 50 and 200 horsepower.

The rotor core consists of a laminated iron cylinder, with the winding either of copper bars or of wires embedded in it.

The simplest form of rotor construction employs what is known as the *squirrel-cage* winding, which was devised by Dobrowolsky. It consists of a number of lightly insulated copper rods or bars arranged in holes or slots around the rotor periphery, and connected at each end by brass or copper rings of ample cross-section. There must be no common factor between the number of rotor and stator slots, otherwise the latter may tend to "lock," or fail to start when current is supplied to the stator winding. The end rings may be solid or laminated copper punchings, and connection to the bars can be made by means of rivets, screws or solder. Riveting is expensive in labor, and if not done well gives poor contact, which results in heating and large slip. Screws and bolts are also expensive and poor contacts are likely to exist. Soldering by itself secures good contact but at heavy overloads or slow starting it is likely to melt. Hence a combination of screws or rivets with soldering is usually employed. In the example of squirrel-cage winding which Fig. 106 illustrates, the rotor has a number of equidistant rectangular holes near its periphery, and through these holes pass copper rods, the projecting ends of which are bolted and soldered to two cast metal end rings. A type of rotor winding frequently adopted is similar in form to the three-phase

Y stator winding already described, but the three free ends of the winding are led to three slip rings upon which brushes bear

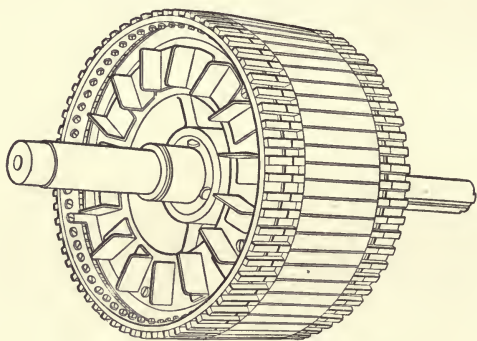

FIG. 106. — SQUIRREL-CAGE ROTOR.

(Fig. 107). These brushes are connected by leads to a variable resistance, the function of which will be considered later.

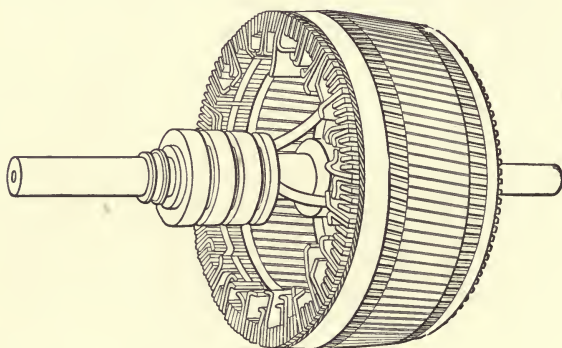

FIG. 107. — SLIP-RING (WOUND) ROTOR.

Fundamental Equation of the Induction Motor. — The fundamental equation of the induction motor is the same as that of the transformer, with the exception of the winding constant K_1 .

$$E = K_1 \sqrt{2} \pi f N \Phi_m 10^{-8}, \quad (26)$$

where E = the c.e.m.f. in volts, N the turns in series per phase, f = cycles per second and Φ_{\max} the total maximum flux per pole. K_1 is a constant required to correct for the departure of the flux distribution from the true sine wave form, and its value varies between .35 and .95, depending upon the number of phases and inductors per stator slot.

The total average induction around the air gap then becomes

$$P\Phi_a = \frac{E 10^8 P}{\sqrt{2} 2K_1 N f}, \text{ where } P = \text{number of poles.}$$

Putting $P\Phi_a = \Phi$ and $\frac{f}{P} = \frac{\text{r.p.m.}}{120}$ we have,

$$\Phi = \frac{E 10^8 120}{2\sqrt{2} K_1 N \text{ r.p.m.}} = \frac{4.25 E 10^9}{K_1 N \text{ r.p.m.}} \quad (27)$$

Formulae 26 and 27 show that for a given induction or flux the turns of winding are directly proportional to the voltage and inversely as the speed. With a given motor winding the flux varies directly as the volts and inversely as the frequency.

An equation for the *magnetizing current* of the induction motor may be developed as follows:

To produce a certain flux density in the gap, a number of ampere turns $I \cdot N_a$ are required for the path through air, and a number $I \cdot N_i$ are necessary for the path through the iron. Then the magnetization factor, or the total m.m.f. in terms of that required to produce the necessary flux in the air path, is

$$MF = \frac{I \cdot N_i}{I \cdot N_a} + 1. \quad (28)$$

This quantity varies in actual design from 1.1 to 1.5. That is, the ampere-turns required for the gap are the controlling factor. The $I \cdot N_i$ may be calculated from magnetization curves of the punchings employed, and the $I \cdot N_a$ may be obtained from the relation

$$I \cdot N_a = .3133 \Phi_m L_g \div S. \quad (29)$$

Where S the total surface of air gap is the length of core \times circumference, L_g is the effective length of mechanical gap $\times 2$. All values of the above are expressed in inches. The magnetizing current I_{mag} corresponding to the air gap should be as low as possible because it reduces the power factor of the motor. It can readily be obtained with the magnetization factor evaluated, being

$$I_{\text{mag}} = I_a \times \text{M.F.} \quad (30)$$

The value of I_{mag} varies from 15-30 per cent of the rated load current, depending upon the size of the motor, the larger per cent being for the smaller sizes.

The value of I_a is given by the equation

$$I_a = \frac{.3133 \Phi_m L_g P}{\sqrt{2} NS} \quad (31)$$

The magnetization volt-amperes will therefore be

$$EI_{\text{mag}} = \frac{.3133 E \Phi_m L_g P}{\sqrt{2} NS} \text{ M.F.} \quad (32)$$

Combining this with equation 28, we get for a given motor the relation

$$EI_{\text{mag}} = K_1 \frac{E^2 P^2}{N^2 f} \text{ M.F.} \quad (33)$$

That is, the magnetizing volt-amperes for a certain magnetic circuit are proportional to the *square* of the voltage and to the *square* of the number of poles, while *inversely* proportional to the *square* of the number of turns and to the frequency. It is evident from this that to keep the same percentage of magnetizing current, the turns and volts must be proportional if one or the other change. Similarly with a change in the frequency, the volts should vary as the *square root* of the frequency.

The *leakage reactance*, or those portions of primary and secondary reactances which are due to leakage of flux, is difficult to determine accurately without tests. It may be predetermined within about ten per cent by means of such a formula as given by Professor C. A. Adams (A. I. E. E. Transactions, June, 1905). It may be expressed in *reactance ohms* or *inductive volts* per ampere, or per cent of total flux. There are four components comprising the total leakage, namely, *primary*, *secondary*, *zig-zag*, and *end-leakage*. Each of these four factors is proportional to the *ampere turns per slot*. The slot leakage, primary and secondary, varies inversely as the slot-width, and directly as the slot depth, the exact functions being quite complex. The zig-zag leakage, threading from primary to secondary slots, varies inversely as the air gap length. The end leakage varies roughly with the throw or circular span of the coils, or inversely as the number of poles. A certain number of corollaries follow from the above relations.

(a) Either of the quantities which determine a low-speed motor, *i.e.*, low frequency or large number of poles, increases the per cent

of leakage for a given total induction by decreasing the flux per pole.

(b) The per cent leakage varies inversely as the square of the voltage, since for a given apparent watts input, the current and the flux per pole respectively vary inversely and directly as the voltage.

(c) The effect of the slot openings is to cut down the slot leakage flux. Hence the use of open secondary slots, even where the conductors are placed in slots from the ends and not from above as in the primary.

The leakage current is that additional magnetizing current required to maintain the primary flux against the secondary reactions. It may be determined from tests, very easily and with considerable accuracy; either from *pull out* (or maximum torque), or from the locked current (which is the current drawn by the motor when rated voltage is applied to the stator with the rotor held stationary). The following empirical relation between pull out torque and per cent leakage has been found to hold:

$$\text{Per cent leakage} = \frac{40 \text{ Rated load torque}}{\text{Pull out torque}}. \quad (34)$$

If readings of voltage, amperes and watts are taken with the rotor locked, the leakage ohms (ω) are:

$$\omega = \frac{EI \sin \phi}{I^2}. \quad (35)$$

However, since the conditions are even more exaggerated than they are in a transformer with its secondary short-circuited, the mutual flux is reduced to the very small value required to maintain the current through such an exceedingly low resistance, and the magnetizing current is relatively also very low. Under these conditions the percentage leakage will be given by:

$$\text{Per cent leakage} = \frac{I \cos \phi}{E - Ir_1}. \quad (36)$$

Where I equals rated load current, $\cos \phi$ equals full load power factor, E equals rated voltage, and Ir_1 equals rated load primary drop. The denominator only approximates the useful or c.e.m.f., since it does not take into account the Ix drop; but will be found

satisfactory as far as practical results go, although not rigorously exact.

The *power factor* of an induction motor may be determined for any load, from the per cent value of the two wattless components of the current input, by means of the relation:

$$\begin{aligned}\cos \phi &= \sqrt{100^2 - (\text{per cent magnetization} + \text{per cent leakage})^2} \\ &= \sqrt{100^2 - (M + L)^2}.\end{aligned}\quad (37)$$

wherein M and L are the respective values of the magnetization and leakage currents in per cent of the total current.

The magnetization current is substantially the same at all loads, hence its percentage varies inversely with the load. The leakage current, however, is a direct function of the load, being substantially zero at no load.

To show the effect of various relative values of percentage leakage and magnetization currents the following example is given, the selected motors having the same value of $M + L$ at rated load.

EFFECT OF LEAKAGE AND MAGNETIZATION CURRENTS UPON MOTOR POWER FACTOR.

Load.		Motor No. 1.	Motor No. 2.	Motor No. 3.
50 % Rated	Per cent L	5	10	15
	Per cent M	60	40	20
	P.F.	76	86.6	93.5
Rated	Per cent L	10	20	30
	Per cent M	30	20	10
	P.F.	91.7	91.7	91.7
	Pull Out Torque*	4	2	1.33
125 % Rated	Per cent L	12.5	25	37.5
	Per cent M	24.0	16	8
	P.F.	93	91.3	89.2
150 % Rated	Per cent L	15.0	30	45.0
	Per cent M	20.0	13.3	6.6
	P.F.	93.6	90.1	85.6
175 % Rated	Per cent L	17.5	35.0	52.5
	Per cent M	17.2	11.4	5.7
	P.F.	93.8	88.5	81.3
200 % Rated	Per cent L	20	40.0	Pull Out.
	Per cent M	153.6	86.5	

* In terms of rated load torque.

Examination of this table indicates that motor No. 1 is best suited to heavy overloads on account of the small percentage of its leakage current. Motor No. 3 is best suited to light loads by reason of the small percentage of its magnetization current. The curves given in Fig. 108 are drawn from the data of the above table, per cent load and per cent power-factor being employed as abscissæ and ordinates respectively.

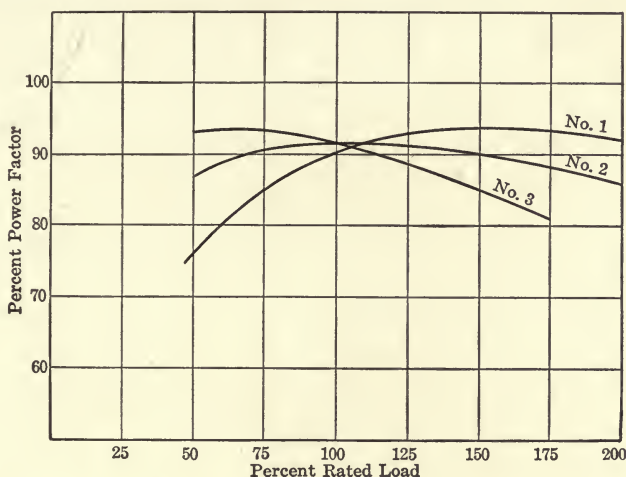

FIG. 108. — EFFECT OF LEAKAGE AND MAGNETIZATION CURRENTS UPON POWER FACTOR OF MOTOR.

Torque and Speed. — It was shown in the development of the elementary induction motor that the phenomenon which caused the secondary of the motor to revolve was the mutual action of the rotary field and the secondary currents. That is, the rotating magnetic field induces currents in the secondary, and these currents acting according to Lenz's law tend to stop the motion producing them. The rotation of the rotary field cannot, however, be halted by the secondary currents, but its speed can be relatively reduced; that is, the rotor can follow the field.

At no load the e.m.f. induced in the rotor need only be extremely small, hence the rate of relative motion between field and secondary is very low, and the rotor revolves at *approximately* synchronous speed. As the load gradually increases, the current required in the secondary becomes larger; at the same time the frequency of the secondary e.m.f. is higher. The current does not increase at the

same rate as the e.m.f., since the reactance of the circuit is greater, hence the speed must fall off more rapidly than the torque growth would indicate. In addition to this, the decrease in speed with increase in torque is still further accentuated because the secondary current lag becomes great, consequently a proportionately larger current is required to produce the corresponding torque. Finally magnetic leakage becomes pronounced, the effective flux reduced and the speed must drop off an extra amount to compensate for this condition. Ultimately the required rate of flux cutting can no longer be maintained, and the motor stops or becomes stalled. The exact form of the speed torque curve depends upon the relation existing between the resistance and reactance of the secondary winding, and upon the leakage factor.

The general form of the speed-torque or more correctly the torque-slip curve of an induction motor is indicated by the following equation:

$$T = N_2^2 e^2 r_2 s \div \omega_1 (r_2^2 + s^2 x_2^2) \quad (38)*$$

wherein N_2 is the number of turns per secondary circuit.

e = induced volts per turn at standstill.

r_2 = resistance per secondary circuit.

x_2 = reactance per secondary circuit at standstill.

s = rotor slip.

ω_1 = angular velocity of the rotary field.

* The derivation of equa. 38 is based upon relations existing between the corresponding quantities in a transformer as follows:

Let E be the line voltage per primary circuit, and with the usual low resistance of the stator winding, it may be placed equal to the voltage induced per primary circuit by the rotary field, or if e is the voltage induced per turn,

$$N_1 e = E_1.$$

Similarly at standstill the secondary induced voltage per circuit may be written $E_2 = N_2 e$, and at any slip s , this secondary voltage becomes $SN_2 e$. This voltage has two components, its resistance and reactance drops, or

$$SN_2 e = I_2 \sqrt{r_2^2 + s^2 x_2^2} \quad (a)$$

from which,

$$I_2 = \frac{SN_2 e}{\sqrt{r_2^2 + s^2 x_2^2}} \quad (b)$$

The energy component of the secondary current is consequently

$$I_2 \cos \phi_2 = \frac{SN_2 e}{\sqrt{r_2^2 + s^2 x_2^2}} \frac{r_2}{\sqrt{r_2^2 + s^2 x_2^2}} = \frac{r_2 SN_2 e}{r_2^2 + s^2 x_2^2} \quad (c)$$

This energy current, in terms of the primary current, when multiplied by the primary voltage corresponds to that part of the motor input which represents the power of

An examination of this torque formula indicates many of the characteristics of the induction motor, for example:

1. The torque becomes a maximum when $r_2 = sx_2$; this follows directly by placing the differential of equation (g) with respect to r equal to zero:

$$\frac{d}{dr} \left(\frac{r_2^s N_2^2 e^2}{\omega_1 (r_2^2 + s^2 x_2^2)} \right) = \frac{\omega_1 (r_2^2 + s^2 x_2^2) s N_2^2 e^2 - \omega_1 2 r_2 (r_2 s N_2^2 e^2)}{\omega_1 (r_2^2 + s^2 x_2^2)^2}$$

which placed equal to zero and simplified gives

$$r_2^2 + s^2 x_2^2 - 2 r_2^2 = 0$$

or $sx_2 = r_2$ which is the condition of maximum torque above stated.

2. The torque of an induction motor at standstill is

$$T_0 = \frac{N_2^2 e^2 r_2}{\omega_1 (r_2^2 + x_2^2)} \quad (39)$$

which evidently is greater the less the resistance of the motor winding, and the lower the angular velocity of the rotary field.

3. The maximum torque of a motor occurring when $r_2 = sx_2$ shows that maximum torque is exerted at standstill when $r_2 = x_2$ because s is then unity, or,

$$T_{0 \max} = \frac{N_2^2 e^2}{2 \omega_1 r_2} \quad (40)$$

which varies *inversely as the resistance* and consequently to produce a great starting torque not only should r_2 and x_2 be equal but they should both be as small as possible.

the rotor. The relation between these two currents is, however, expressed by the inverse ratio of turns, or this energy component of the primary current is:

$$\frac{r_2 s N_2^2 e}{N_1 (r_2^2 + s^2 x_2^2)} \quad (d)$$

and when multiplied by the primary voltage $E_1 = N_1 e$ it gives the watts input representing the power of the rotor, or

$$\text{Rotor power} = \frac{r_2 s N_2^2 e^2}{r_2^2 + s^2 x_2^2}. \quad (e)$$

This quantity, however, includes the copper losses occurring in the rotor, and these are from equation (b) expressed by the term $I_2^2 R_2 = \frac{r_2 s^2 N_2^2 e^2}{r_2^2 + s^2 x_2^2}$; thus the available power of the rotor becomes:

$$\frac{r_2 s N_2^2 e^2}{r_2^2 + s^2 x_2^2} - \frac{r_2 s^2 N_2^2 e^2}{r_2^2 + s^2 x_2^2} = \frac{r_2 s N_2^2 e^2 (1 - s)}{r_2^2 + s^2 x_2^2}. \quad (f)$$

The torque exerted by the induction motor is obtained by dividing the rotor power by the rotor slip $\omega_2 = \omega_1 (1 - s)$, or we have

$$\text{Torque per rotor circuit} = \frac{r_2 s N_2^2 e^2}{\omega_1 (r_2^2 + s^2 x_2^2)} \quad (g)$$

4. The power factor of the secondary circuit is expressed by the relation $\frac{r_2}{\sqrt{r_2^2 + s^2x_2^2}}$; but since at maximum torque $r_2 = sx_2$ we have the condition that the power factor of the secondary at maximum starting torque should be $\frac{r_2}{\sqrt{2}r_2} = 0.707$.

5. The value of the secondary copper loss is from equa. *b* (p. 180) $I_2^2r_2 = r_2s^2N^2e^2 \div (r_2^2 + s^2x_2^2)$, which may be written from equa. *g* (p. 181) as:

$$I_2^2r_2 = s \text{ torque } \omega_1;$$

hence we see that for a given torque and frequency the rotor copper losses vary directly as the slip. For example: Consider a motor with 85 per cent efficiency at rated load and a slip of 5 per cent. The efficiency with 10 per cent slip at rated load would be approximately 80 per cent, and with 15 per cent slip it would be about 75 per cent, one per cent in efficiency being lost with each per cent increase in slip.

6. The input into the motor, not considering the core losses, primary copper losses or windage and friction, is from equa. *e* (p. 181):

$$\text{Motor input} = \frac{sN_2^2e^2r_2}{r_2^2 + s^2x_2^2} \text{ while from equa. } f, \text{ same page, the motor}$$

output is

$$\text{Motor output} = \frac{sN_2^2e^2r_2(1-s)}{r_2^2 + s^2x_2^2}.$$

Since the output divided by input gives the motor efficiency, it is apparent that per cent of electrical efficiency is equal to percentage of synchronous speed $(1 - s)$ attained by the rotor. The total losses of the motor were not included in the input as above considered, so that the true motor efficiency at any load can never equal the percentage of synchronous speed attained by the rotor.

7. Further inspection of equa. 38 (p. 180) indicates that for a given slip the motor torque varies as e^2 , but the line voltage being N_1e , it follows that for a given slip, the motor torque varies directly as the square of the line voltage, and conversely at a given torque the rotor slip varies inversely as the square of the line voltage.

Circle Diagram of the Induction Motor. — The characteristic curves show how the power-factor, torque, speed, efficiency and

current vary with load, that is, they give the performance of the motor. The simplest method of determining the series of curves relating to the induction motor is by means of the circle diagram. Many diagrams of this kind have been suggested since the first one was developed by Heyland and described by him in the "Elektrotechnische Zeitschrift" of October 11, 1894. The majority of these later diagrams are modifications which merely simplify construction and the interpretation of results. The circle diagram is entirely based upon the fact that the induction motor is substantially a transformer with considerably increased magnetic leakage. *The essential difference in action is the fact that the energy of the transformer secondary appears in electrical form, whereas that of the motor is given out in mechanical form.* The motor problem may accordingly be studied from the transformer standpoint by substituting the equivalent transformer shown in Fig. 109, which replaces each

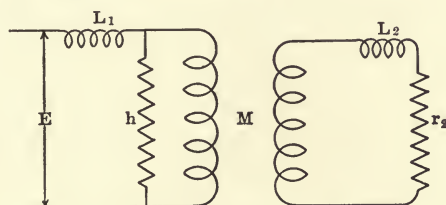

FIG. 109.—TRANSFORMER DIAGRAM OF THE INDUCTION MOTOR.

phase of its winding. Let L_1 and L_2 denote those portions of the primary and secondary self-inductance which are due to the leakages of flux which contribute nothing towards the development of torque. The non-inductive resistances h and r_2 are introduced as shunts in the primary and secondary circuits respectively. Resistance h is intended to represent a loss proportional to the hysteresis and eddy currents of the primary core. This loss is supposed to remain practically constant; while this is not exactly true, the fact that the primary copper loss increases as the load is augmented, largely compensates for the error of this assumption.

Let I_1 be the primary current, r_1 the true primary resistance and E the primary voltage per phase. This latter may be considered as being made up of three components, namely: *

* The transformer method here employed was originally proposed by C. F. Bedell and the development of current locus is substantially that given by J. Bethenod, L'Éclairage Électrique, Vol. XL, page 253, 1904. See also Hay's Alternating Currents, pp. 185-188.

(1) That due to $I_1 r_1$ which is in phase with I_1 .

(2) That due to the leakage reactance of the primary, *i.e.*, that produced by the winding L_1 being in quadrature with I_1 and equal to $\omega L_1 I_1$.

(3) That due to the mutual flux existing between primary and secondary. To determine the value of this we must consider the secondary current. Let its instantaneous value be $i_2 = I_{2m} \sin \omega t$. The flux through the primary due to this current is Mi_2 , wherein M is the coefficient of mutual induction between primary and secondary. The voltage thereby induced in the primary, assuming a one to one ratio of transformation, is $-\omega MI_{2m} \cos \omega t$. To balance this the impressed voltage must have an opposite component or $+\omega MI_{2m} \cos \omega t$, the effective value of which is ωMI_2 in quadrature with I_2 . The total secondary e.m.f. is that due to the primary current, its value being ωMI_1 lagging in quadrature with respect to the current I_1 . It is made up of two components, one in phase with

the secondary current, namely, the $I_2 r_2$ drop, and one the leakage reaction, $\omega L_2 I_2$ in quadrature with I_2 .

These various voltages are shown vectorially in Fig. 110, wherein the primary current OI_1 is taken as the horizontal axis of reference. The resistance drop of the primary is represented by OA in phase with OI_1 ; the leakage reaction of the primary is OL_1 , 90° behind OI_1 . OP is the induced e.m.f. in the secondary, due to the mutual flux. Its two components are PR_2 and OR_2 , corresponding to the secondary leakage reaction and resistance drop respectively. The component of the primary applied voltage, due to the mutual inductive reaction, is $L_1 C$ perpendicular to OR_2 . The impressed primary voltage is then the vector resultant of OA , OL_1 and $L_1 C$, or it is represented by the vector OC at an angle COA or ϕ ahead of the primary current, the cosine of which represents the power factor of the motor. The

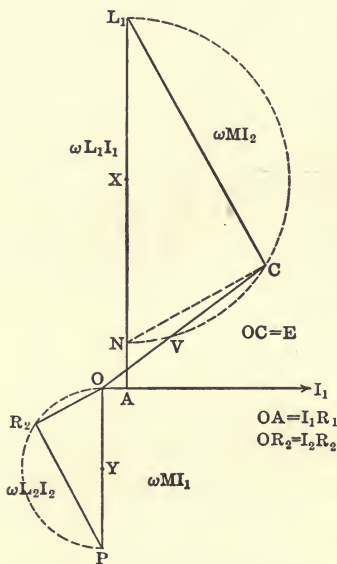

FIG. 110.—VECTOR DIAGRAM OF VOLTAGES PER PHASE OF INDUCTION MOTOR.

vector resultant of OA , OL_1 and L_1C , or it is represented by the vector OC at an angle COA or ϕ ahead of the primary current, the cosine of which represents the power factor of the motor. The

angle POR_2 corresponding to ϕ_2 is the phase angle between the secondary voltage and current. From C draw a line parallel to OR_2 , let this intersect AL_1 at N . This construction gives us two similar triangles, namely, OER_2 and NL_1C , wherein L_1C and ER_2 are proportional.

Now divide each vector by I_1 , thus fixing the points A , L_1 and P in position, because now the corresponding vectors represent R_1 , ωL_1 , and ωM which are of constant value. Hence as the secondary current varies, the angle OR_2P being a right angle, the point R_2 must describe a semicircle about OP as a diameter. The triangle NL_1C , however, is similar to OPR_2 , so that any change in the latter must be accompanied by a corresponding change in the former, or the point C must describe a semicircle on L_1N as a diameter.

The point O , being the origin of axes, is fixed in position; accordingly it follows that $OV \times OC$ is constant for all values of C^* , which may be expressed as $OV \times OC = K$ or $OV = K \div OC$.

However, by construction $OC = \frac{E}{I_1}$; consequently $OV = \frac{K}{E} I_1$. The

voltage E is constant, therefore OV is directly proportional to the primary current, and we have the important fact *that the extremity of the vector representing the primary current moves along an arc of a circle as the load of the motor changes*. With this rule established, we can construct particular circle diagrams adaptable to practical use. We shall employ the circle diagram proposed by A. S. McAllister in the "Electrical World" of April and May, 1906.† For the construction of this diagram the following readings must be determined, namely, voltage, current and watts with motor running without load, and voltage, current and watts with its rotor locked, also the resistance of each primary phase winding.

The equivalent single-phase current is obtainable from the no load ammeter reading, and the equivalent single-phase locked current is derived from the locked conditions. The equivalent single-phase resistance of the stator can be calculated if resistance per phase winding is known. The reason for using single-phase equivalents is that the circle diagram when thus constructed gives directly the true motor input, torque and output.

* The area of the rectangle constructed upon any total secant and its external part is equal to the square of the corresponding tangent.

† Alternating Current Motors, A. S. McAllister, p. 109, 1909.

The equivalent single-phase current in the case of two-phase circuits is the sum of the current in both phases, while in the three-phase system the equivalent current is $\sqrt{3} I$, where I is the average of the currents in each line. The equivalent single-phase resistance for any two-phase or three-phase system, when considering the like currents, is one-half that measured between phase lines by direct currents.*

The watts input and current for the locked condition cannot be obtained safely with rated line voltage because of the danger of damaging the motor by the large current which then flows. In practice a locked saturation curve is obtained by plotting a series of four or five readings of current, power and torque with the test voltage at rated frequency, and varied between one-fifth and about three-fifths of the operating pressure employed as abscissa. The various curves are then continued beyond the test points by extrapolation. A rough approximation of the locked current and watts can be made by testing at one-half rated voltage, and then multiplying the current by two and the watts by four, but possible change in saturation is likely to introduce an error of large value, especially in the power-factor.† The above curve method is therefore preferable, although it is evidently open to some question. A series of locked saturation curves of a three-phase 8-pole, 60-cycle, 215-volt 20-h.p. induction motor are illustrated in Fig. 111.

Construction of Diagram.—Let the vertical line OE , Fig. 112, represent the line voltage drawn to scale. Draw at their proper phase positions, also to scale, the equivalent single-phase no load and locked currents (OM and OF), respectively. Through M draw a line OK perpendicular to OE , join M and F ; draw, also, a line perpendicular to the middle of MF , intersecting OK at X . With X as center and either XM or XF as a radius, describe the arc MCF ; this is the locus of the primary current. The distance HG represents the added primary or stator loss existing with rotor locked, its length = (added primary copper loss \div total locked watts) $\times IF$. Draw the line GM . With this construction completed, the performance of the machine may be determined directly

* A. S. McAllister, *Alternating Current Motors*, pages 13, 14, 15.

† The rotor should be allowed to rotate very slowly during this test, or the position of the rotor should be varied and the results averaged.

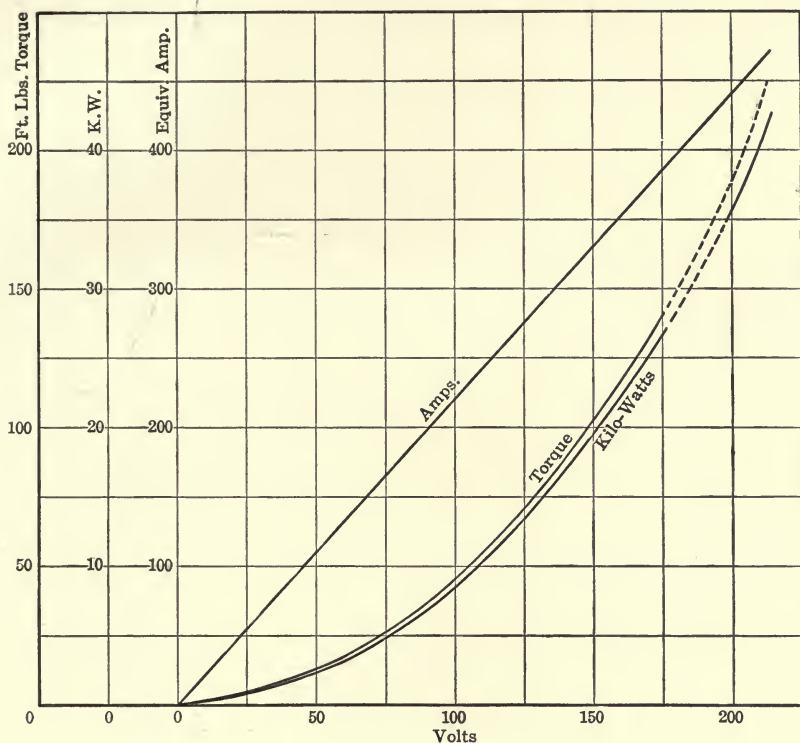

FIG. III. — LOCKED SATURATION CURVE, 20-H.P., 215-VOLT, INDUCTION MOTOR.

by inspection. For example, the factors indicating the operation of the motor with a current P are as follows:

\overline{OP} to scale represents the equivalent single-phase primary current.

$\cos POE$ equals power factor of motor.

\overline{MP} equals secondary current in primary equivalents.

\overline{PT} equals primary input in watts.

\overline{TS} equals no load losses in watts.

\overline{RT} equals total primary loss in watts.

\overline{PR} equals total secondary input in watts.

\overline{RS} equals the added primary copper loss.

\overline{QR} equals secondary copper loss.

\overline{QP} equals motor output in watts.

$\frac{\overline{OM'}}{\overline{OP}} = \text{per cent magnetizing current.}$

$\frac{\overline{M'T}}{\overline{OP}} = \text{per cent leakage current.}$

Maximum torque is $\overline{CG'}$, the point C being obtained by drawing a radius perpendicular to \overline{MG} .

Maximum output is \overline{BJ} , the point B being obtained by drawing a radius perpendicular to \overline{MF} .

Maximum power factor exists when primary current vector is a tangent to the arc, corresponding to point P in the diagram.

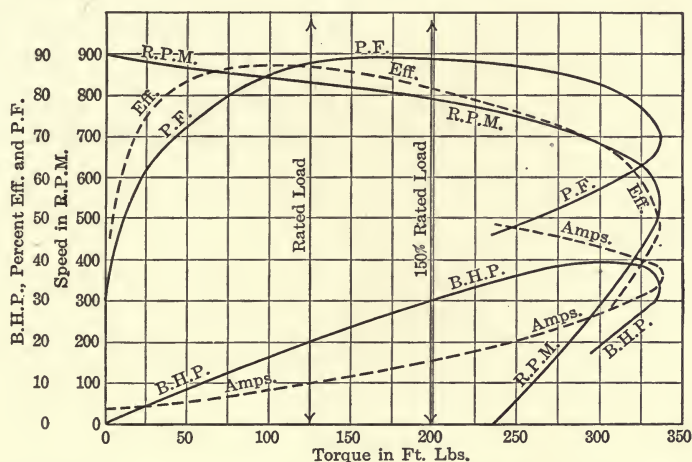

FIG. 113. — CHARACTERISTIC CURVES OF A 60-CYCLE, 215-VOLT, 20-H.P. INDUCTION MOTOR.

The characteristic curves in Fig. 113 are those of a three-phase, 60-cycle, 8-pole, 215-volt induction motor of 20 horsepower capacity, the values for the construction of these curves being obtained from the circle diagram just given. The fundamental data employed were derived from test and are as follows:

	No Load Values.	Locked Values, (See Fig. 112.)
Volts	215	215
Equivalent single-phase amperes	33.5	470
Total watts	930	43×10^3
Power factor	12.9%	46.5%

Hot resistances of stator: Ph (1-3) = .107 $\bar{\omega}$; Ph (3-2) = .109 $\bar{\omega}$;
 Ph (2-1) = .106 $\bar{\omega}$

Equivalent single-phase resistance = $\frac{.108}{2} = .054 \bar{\omega}$

Construction. — Draw the power factor circle Fig. 112 with radius of 2.5 in. (.25 in. = 10 per cent p.f.).

Lay off p.f. = 12.9 per cent and draw no load current = .335 in. (1 in. = 100 amperes).

Lay off p.f. = 46.5 per cent and draw locked current $MF = 4.7$ in.

Join F and M , draw MK perpendicular to voltage line OE . Bisect MF and erect a perpendicular at this point. The intersection of this perpendicular with OK at point X is the center of current locus. Draw an arc through M and F with X as center.

Determination of motor performance at load corresponding to current OP .

$OP = 1.33$ in. = 133 amperes; continue OP until it intersects power factor circle, then project intersection to power factor ordinate = 2.22 in., or $2.22 \div 2.5 = 88.8$ per cent.

Line MG is drawn as follows:

FI = total input at starting motor = 43 kw.

$HI = MM'$ = no load input = 930 watts.

HF = secondary copper loss at starting + increase of primary copper loss for current OF , or 470 amperes.

Primary copper loss at starting with line voltage = $470^2 \times \frac{.108}{2}$
= 12 kw.

No load primary copper loss = $33.5^2 \times \frac{.108}{2} = .6$ kw.

Increase in primary copper loss at starting = 11.4 kw.

The line $FI = 43$ kw. = 2.15 in. or 20 kw. = 1 in.; thus distance HG or added primary loss = $\frac{11.4}{20.0} = .57$ in., which determines position of G , and from it MG is drawn.

The slip at load corresponding to current P (i.e., 133 amperes) is $QR \div RP = \frac{.12}{1.10} = 10.9$ per cent. Synchronous speed = $\frac{3600}{4}$
= 900 \therefore speed = 900 (1.00 - .109) = 802 r.p.m.

Motor input = $TP = 1.18$ in. or $1.18 \times 20 = 33.6$ kw.

Motor output = $PQ = .98$ in. or $.98 \times 20 = 19.6$ kw. = 26.3 h.p.

Motor efficiency = $PQ \div TR = 19.6 \div 23.6 = 83.1$ per cent.

$$\text{Motor torque} = \frac{\text{kw. output} \times 7.05}{\text{r.p.m.}} = \frac{19.6 \times 7.05}{\text{r.p.m.}} = 172 \text{ lbs.}$$

at a ft. radius. Since the torque corresponding to current OP is by calculation 172 ft. lbs., and the vector RP corresponding thereto is 1.12 in. long, we can state that 1 in. on the torque lines of Fig. 113 is equivalent to an effort of 153 lbs. at a foot radius.

$$\text{Per cent magnetization current} = OM \div OP = \frac{33}{133} = 24.8 \text{ per cent.}$$

$$\text{Per cent leakage current} = M'T \div OP = \frac{27}{133} = 20.3 \text{ per cent.}$$

DATA FOR CHARACTERISTIC CURVES OF A 20-H.P. INDUCTION MOTOR DERIVED FROM CIRCLE DIAGRAM, FIG. 112.

Point.	Equi. Primary Amps.	Slip QR/PR = s %	R.P.M. Alts. (1-s) poles	Effic. PQ/PT = %	Output. 1" = 26.8 H.P. PQ" H.P.	Torque. 1" = 153 PR Ft. Lbs.	P.F. %
1	40	$\frac{.005}{.165} = 3$	873	$\frac{.165}{.220} = 76.8$.165 = 4.4	.165 = 25.8	63.0
2	53	$\frac{0.14}{.36} = 3.6$	867	$\frac{.32}{.38} = 84.3$.32 = 8.6	.36 = 56.0	73.0
3	77	$\frac{.03}{.55} = 5.4$	851	$\frac{.52}{.60} = 86.8$.52 = 14.0	.55 = 86.0	83.0
4	97	$\frac{.06}{.78} = 7.7$	830	$\frac{.73}{.88} = 86.5$.73 = 19.5	.78 = 122.0	87.0
P	133	$\frac{.12}{1.10} = 10.9$	802	$\frac{.98}{1.18} = 83.1$.98 = 26.3	1.10 = 172.0	89.0
6	174	$\frac{.19}{1.140} = 13.6$	778	$\frac{1.20}{1.52} = 79.0$	1.2 = 32.2	1.40 = 218.0	88.0
7	228	$\frac{.34}{1.76} = 19.3$	725	$\frac{1.42}{1.95} = 73.0$	1.42 = 38.0	1.76 = 275.0	85.0
B	277	$\frac{.52}{2.00} = 26.0$	666	$\frac{1.48}{2.25} = 66.0$	1.48 = 39.0	2.00 = 312.0	81.0
9	330	$\frac{.75}{2.13} = 35.0$	585	$\frac{1.38}{2.46} = 56.5$	1.38 = 37.0	2.13 = 332.0	75.0
10	349	$\frac{.90}{2.20} = 41.0$	530	$\frac{1.26}{2.52} = 50.0$	1.26 = 33.8	2.20 = 340.0	72.0
11	376	$\frac{.95}{2.15} = 44.3$	500	$\frac{1.16}{2.55} = 45.5$	1.16 = 31.0	2.15 = 336.0	68.0
12	425	$\frac{1.25}{1.96} = 64.0$	324	$\frac{.72}{2.50} = 29.0$.72 = 19.3	1.96 = 306.0	58.0
13	445	$\frac{1.38}{1.80} = 76.5$	212	$\frac{.42}{2.38} = 17.6$.42 = 11.3	1.80 = 281.0	54.0
14	457	$\frac{1.46}{1.70} = 86.0$	126	$\frac{.24}{2.25} = 10.7$.24 = 6.4	1.70 = 265.0	51.0
15	470	$\frac{1.50}{1.50} = 100.0$	0	0	0 0	1.50 = 234.0	46.5

Maximum motor torque $CG' = 2.16 \times 176 = 340$ ft. lbs.

Maximum motor output = $1000 (BJ \times 20) \div 746 = 30.0 \div .746$
 = 40.2 horsepower.

The performances for different current values corresponding to a series of points indicated on the circle diagram were similarly obtained, and for convenience of reference are arranged in the preceding table, page 191, to which the curves in Fig. 113 correspond.

The speed regulation of this particular motor is fairly good up to 150 per cent of rated torque, beyond which limit the drop in speed becomes pronounced, and at a torque of 340 ft. lbs. (2.7 times rated value) the motor reaches its "pull out torque." The "pull out" limit (*i.e.*, maximum torque developed) of an induction motor is that point upon its speed-torque curve at which any attempt to further increase the torque causes the motor to drop rapidly in speed and stop. This characteristic is very pronounced in induction motors, the exact location of this point depending largely upon the flux leakage occurring. It usually varies between *two* and *three* times the rated torque, depending upon the size of the motor, and may be obtained at starting if the rotor resistance and "standstill" reactance are made equal (p. 181). The maximum horsepower output of this induction motor is obtainable at a speed greater than that existing at its maximum torque, and this is usually the case with electric motors. The power factor curve indicates one of the difficulties caused by induction motor loads, namely, the production of a wattless current, which is particularly pronounced at light loads. The power factor of an induction motor increases with the load to nearly the "pulling out" point, after which it decreases, and unless a special method be employed to secure maximum torque at starting, the power factor at standstill is usually much lower than when running at or near rated load.

The following table gives the characteristics of operation attained by standard machines, and it should be noted that the power factor increases somewhat with the size of the motor.

Starting torque and pull out torque are in terms of rated load torque.

Starting amperes equal amperes to start with rated load torque at line voltage, in terms of rated load current.

DATA OF STANDARD INDUCTION MOTORS.

Machines Two- and Three-phase for 100 to 550 volts.

H.P.	Poles.	Slip Per Cent.	Amps. Start.	Start Torque	Pull Out Torque	Per cent Power Factor.				Per cent Efficiency.			
						$\frac{1}{2}$ Load.	$\frac{3}{4}$ Load.	Rated Load.	$1\frac{1}{4}$ Load.	$\frac{1}{2}$ Load.	$\frac{3}{4}$ Load.	Rated Load.	$\frac{1}{2}$ Load.
$\frac{1}{2}$	4	6.7	1.5	1.7	2.0	57	66	72	72	72	74	74	72
1	4	7.0	2.1	2.2	2.4	68	73	78	79	75	78	79	77
2	4	6.0	2.3	1.9	2.6	69	78	83	83	80	82	82	80
3	4	7.4	2.5	1.5	2.2	75	83	86	87	82	84	83	82
5	4	8.5	2.3	1.7	2.2	76	84	88	88	83	84	85	83
7.5	6	7.4	2.3	1.9	2.5	75	83	87	87	83	85	85	84
10	6	6.8	2.5	1.8	2.3	78	86	88	88	84	85	85	83
15	6	7.3	2.2	1.9	2.5	80	86	89	89	85	86	86	84
20	6	7.2	2.3	1.8	2.3	82	87	90	90	85	86	86	83
20	8	8.0	2.7	2.0	2.7	78	85	88	89	86	87	86	84
25	6	7.0	2.2	1.8	2.3	80	87	88	89	85	87	87	84
30	8	6.7	2.7	1.8	2.4	83	88	90	90	87	87	86	85
40	8	6.5	2.6	2.8	2.8	80	86	89	90	87	87	87	85
50	8	6.2	2.5	2.3	3.0	82	88	91	91	87	88	88	86
75	10	5.6	2.6	2.3	3.1	78	84	88	89	87	88	88	87

For further information upon theory and construction of induction motors, the reader is referred to the following standard works:

- ALTERNATING CURRENT MOTORS. A. S. McAllister. New York, 1909.
 ALTERNATING CURRENT PHENOMENA. C. P. Steinmetz. New York, 1908.
 COURANTS ALTERNATIFS, Vol. II. G. Sartori. Paris, 1905.
 DYNAMO-ELECTRIC MACHINERY, Vol. II. S. P. Thompson. London, 1905.
 ELECTRIC MOTORS. H. M. Hobart. London, 1904.
 ELECTRIC TRANSMISSION OF ENERGY. Gisbert Kapp.
 THE INDUCTION MOTOR. Behrend. New York, 1903.
 THE INDUCTION MOTOR. De la Tour-Mailoux. New York, 1904.
 WECHSELSTROM-TECHNIK, Vol. V. E. Arnold. Berlin, 1909.

CHAPTER XV.

STARTING OF INDUCTION MOTORS.

THE fact that an induction motor is substantially a transformer with a short-circuited secondary causes difficulty in starting, especially when its terminals are directly connected to full line pressure. For example: The locked saturation curves of an induction motor, as shown in Fig. 111 (p. 187), indicate that direct application of the full line pressure to the stator terminals, with the rotor short-circuited and standing still, produces an inrush primary current which is nearly five times rated value. Such excessive current is likely to injure the insulation of the windings and should be avoided. In addition to this, the power factor of this current is very low, being about thirty to forty per cent. It also affects the line regulation, causing voltage fluctuation. Consequently, when the motor to be started is of even moderate size (over 3 h.p.) some means should be employed to limit the line current at starting to reasonable values.

Two general forms of rotor windings are employed in practice, and as a result two methods of starting have been developed which depend respectively upon:

- (a) Reduction of Line Voltage.
- (b) Resistance Control.

Starting by means of reduced line voltage is necessary when squirrel-cage rotors are employed, and it is generally accomplished through the introduction of an *auto-transformer* or *compensator* into the primary circuit. The underlying principle of this type of starter will be understood by referring to Fig. 114. The device is equivalent to a single-coil step-down transformer, the ratio of transformation being that existing between the total number of turns across which the primary terminals are connected and those between which the load is placed. In the specific instance illustrated in Fig. 114, the primary potential is 440 volts, the secondary voltage is 176, secondary current 200 amperes, and primary current 80 amperes. The voltage across the stator terminals is only a frac-

tion of the line potential, when the switch is placed in the starting position, but after the motor has approximately reached its rated speed, the switch is thrown over *rapidly* into the *running* position, the stator being then directly connected to the supply voltage.

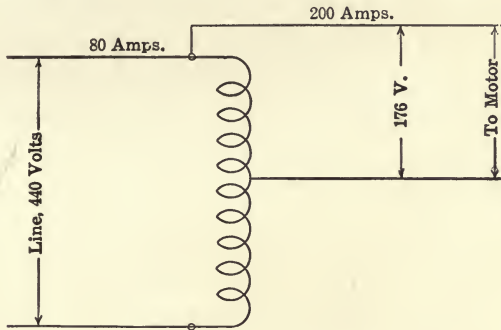

FIG. 114. — SIMPLE AUTO-TRANSFORMER CONNECTIONS.

The compensator windings for a three-phase motor consist of three coils, one for each phase, each coil being placed upon a separate leg of a laminated iron core. Each coil is provided with three or more taps, so that a number of sub-voltages may be obtained, any one of which may be selected for permanent connection to the throw-over

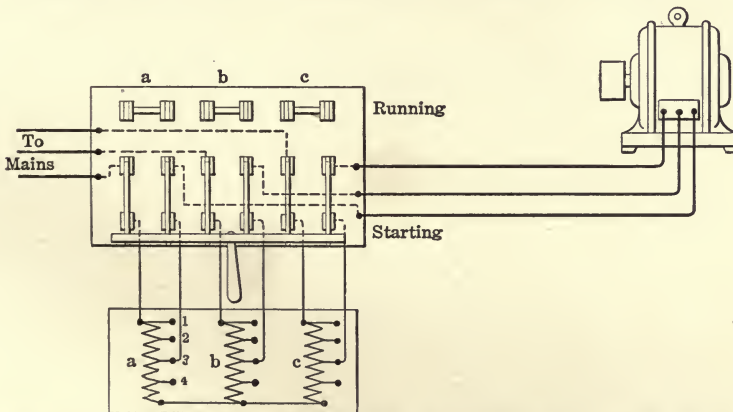

FIG. 115. — CONNECTIONS OF STARTING COMPENSATOR FOR THREE-PHASE INDUCTION MOTOR.

switch, according to service conditions. The three coils of the compensator are Y-connected, the supply line to the three free ends and the starting connections of the motor to the taps being as shown in Fig. 115. To meet various requirements, compensators are generally provided with taps giving potentials approximately equal to

Three-phase motors may be started without a compensator, by Y-connecting the stator windings at starting, and employing delta connections for running, the change being rapidly made by means of a special throw-over or double-throw four point switch. The connections for such a starting scheme are as illustrated in Fig. 117.

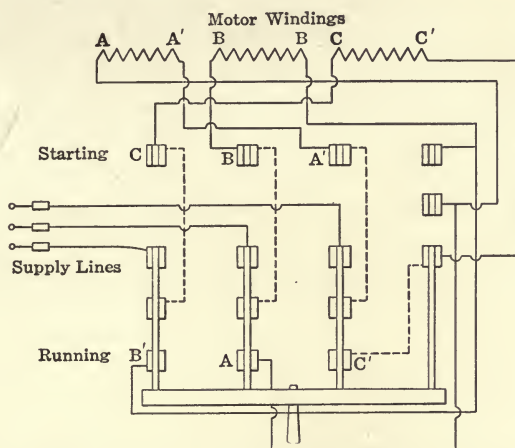

FIG. 117. — CONNECTIONS FOR STARTING THREE-PHASE INDUCTION MOTOR. STATOR Y-CONNECTED FOR STARTING.

By this method the voltage per phase at starting is only $1 \div \sqrt{3}$ or 58 per cent of the line voltage. It follows, then, that the starting current and torque are also reduced. For example, consider the 20-h.p. motor already referred to; the starting current employing Y-connection on starting would be only one-third of that taken if the motor were thrown directly on the line with delta-connected stator, or it would be $(470 \div 97) \div 3 = 1.62$ times full load current. The starting torque being proportional to the square of the potential difference employed, would give a value of torque equal to one-third of the value obtained with full line voltage.

Boucherot Method. — An excellent method for starting induction motors provided with squirrel-cage rotors is that devised by M. P. Boucherot.* The general scheme is to employ the ordinary form of stator as the primary, and to provide a rotor with several squirrel-cage windings of graded resistance and reactance varying from high resistance with low inductance to low resistance with high

* Bulletin de la Société Internationale des Électriciens, February, 1898, and Electric Motors, H. M. Hobart, pp. 266-270, London, 1904.

inductance. The high resistance circuits are the seats of large induced currents at starting, while those of high inductance have only small currents, because at standstill their reactance is high. The starting is due to the high resistance windings. As the rotor speeds up from standstill, the frequency of the secondary e.m.f. decreases; consequently the reactance of the windings diminishes, and all circuits carry current, that of the highly inductive circuits becoming relatively larger, because their resistance is extremely low. Thus by this method the advantages of a high resistance rotor for starting are secured, while the poor speed regulation and low efficiency of such a winding under varying load are avoided by the fact that the low resistance (high reactance) windings are the working ones.

A double squirrel-cage winding is usually found to be sufficient to meet practical requirements, Fig. 118 showing a rotor punching

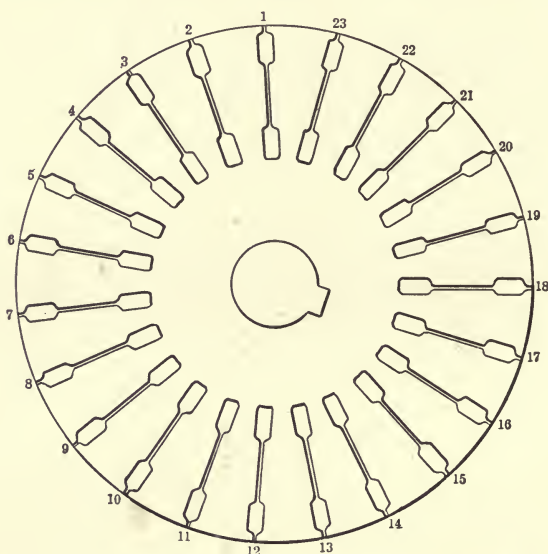

FIG. 118. — ROTOR LAMINATIONS OF A BOUCHEROT MOTOR.

of such a motor. The radial openings joining the upper and lower slots are designed to prevent the occurrence of excessive magnetic leakage with respect to the inner winding. Copper bars are placed in the outer series of holes, and these are connected by means of high resistance end rings formed of German silver or other resistance alloy. Copper bars of larger cross section than those of the outer

group are placed in the inner series of slots, and these are secured to low resistance end rings.

The speed-torque curves of such a motor are illustrated in Fig. 119;* of these, curve *A* represents the action when the motor is op-

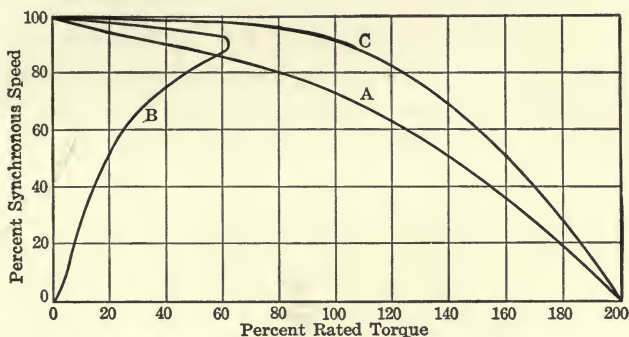

FIG. 119. — SPEED-TORQUE CURVES OF A BOUCHEROT INDUCTION MOTOR.

erated with only the outer or high resistance winding active. In this case the starting torque available is nearly twice that at rated load, and the slip at rated load is about 25 per cent. Curve *B* indicates the speed-torque relations when the inner or highly reactive winding only is used. Under this condition the motor has practically no starting torque, while the maximum available torque when running is only 60 per cent of the rated value, and the corresponding slip is 6 per cent. The speed torque characteristic of the motor with both windings active is shown in curve *C*. The starting torque then obtained is substantially twice that existing at rated load. The speed regulation is excellent, a slip of but 6 per cent occurring at rated load.

It is surprising that this method of control is not more widely employed, since the efficiency of the motor thus designed is high, the starting torque good, and the control extremely simple, all that is necessary to start the motor being a simple closing of an ordinary supply switch.

Resistance Control. — It was proven in the discussion of the torque equation of the induction motor (p. 181) that the starting torque of this type of machine may be varied by changing the resistance of its secondary winding. With this method of control the starting torque can be made anything up to the maximum value,

* Electric Motors, H. M. Hobart, p. 269, London, 1904.

that is, two or three times the rated load torque. In the case of small machines (3 to 5 horsepower), in which no speed regulation is required, provision may be made to locate the special resistance grids in the annular space between rotor core and shaft, employing for this purpose an overhung core. For example, the three free ends of the rotor winding are connected to three resistance grids placed within the rotor spider. This resistance is subsequently cut out, by operating a lever which engages a collar free to slip longitudinally upon the shaft. This collar moves over the resistance grids, gradually reducing their value, until they are completely short-circuited. This method, while applicable to small machines, is not advisable for large ones on account of excessive I^2R loss in the resistances, which if confined within the rotor would produce extreme heating and perhaps ultimately injure the motor. Consequently, in large machines, or in the case of those whose speed is to be adjusted, the regulating resistances are placed external to the motor, connections being made to the free ends of the Y-rotor winding by means of three slip-rings and brushes, Fig. 120. This type of resistance control, owing to the presence of the slip-rings, is commercially known as the *slip-ring* method.

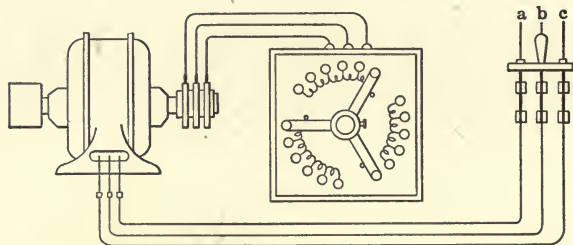

FIG. 120. — CONNECTIONS OF SLIP-RING STARTING DEVICE.

The slip of an induction motor at a given torque varies directly as the secondary copper losses (p. 182); hence if the rotor resistance per phase winding be doubled, the slip for any given torque will be increased 100 per cent; if the resistance be increased to three times its initial value, the slip will be thrice its former amount, etc. The curves shown in Fig. 121 are obtained from the speed-torque curve of Fig. 113, and they correspond to secondary rotor resistances of one, one and one-half, two, four, five and eight times that existing with the rotor short-circuited. These externally added resistances

are Y-connected and the movable contact arms cut out resistance equally in each of the branches, as shown in Fig. 120.

The amount of external resistance needed to obtain any given starting torque within the range of the motor's capabilities can be readily determined from the speed-torque curve obtained when the rotor is operated with its windings short-circuited. For example, it is desired to have the typical motor operate so that it will give, as a maximum, approximately rated torque when starting; and Fig. 113 shows that rated torque exists when the slip is eight per cent.

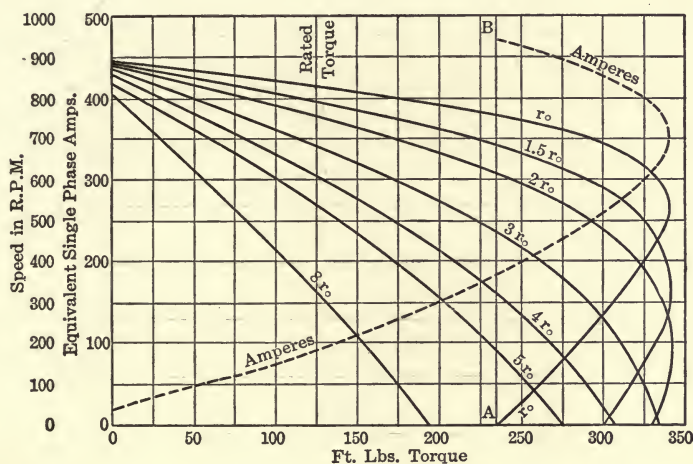

FIG. 121. — SPEED-TORQUE CURVES OF A 20-H.P. INDUCTION MOTOR, WITH VARIOUS VALUES OF ROTOR RESISTANCE.

Hence to have this torque developed at standstill, the desired resistance of the rotor circuit must be such as to increase the slip about twelvefold. However, since the resistance per phase winding of the rotor is .044 ohm, approximately .5 ohm additional must be placed in each branch. Similarly, if it be desired that the motor exert the maximum torque available at starting, the necessary external resistance can be also determined directly from the speed-torque curve of Fig. 113. The slip at maximum torque is 40 per cent, therefore to have 100 per cent slip and same torque, the rotor resistance must be increased to about 2.5 times its initial value, that is, a total of $.044 \times 2.5 = .110$ ohm must be placed in each phase circuit of the rotor.

The advantage of employing an adjustable resistance in the rotor

circuit for starting a motor is clearly indicated by the curves in Fig. 122. Of these, curve *A* shows the starting current drawn by the typical induction motor, when connected directly to the line without starting resistance in the rotor circuit. Curve *B* shows the

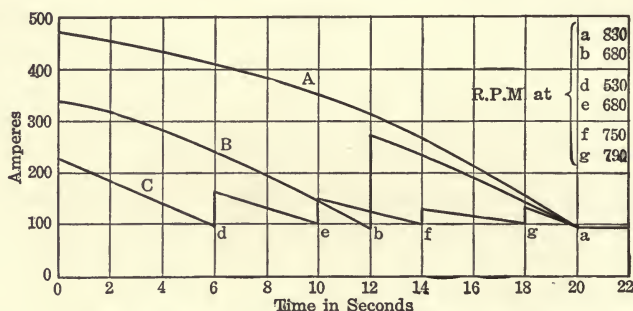

FIG. 122. — STARTING OF 20-H.P. INDUCTION MOTOR, WITH VALUES OF ROTOR RESISTANCE.

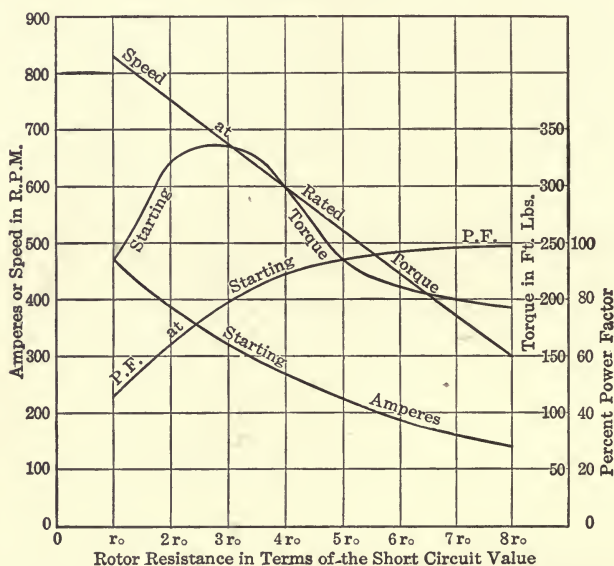

FIG. 123. — EFFECT OF ROTOR RESISTANCE UPON THE ACTION OF A 20-H.P. INDUCTION MOTOR

starting current existing when three times the initial rotor resistance (.132 ohm per circuit) is employed and the increase of current occurring when this resistance is short-circuited on the second step after twelve seconds acceleration. Curve *C* shows what results when the added external resistance is four times the rotor

resistance (total per phase .22 ohm), and is gradually reduced in five steps to its short-circuit value. This method causes a very marked reduction in the average starting current, and is used where the supply circuit must not be disturbed by voltage fluctuations.

The effects of adjustable resistance in the rotor circuit upon power factor, torque and primary current at starting, as well as upon the speeds attained at rated torque, are indicated in the curves of Fig. 123, which refer to the 20-h.p. motor previously considered. These curves show that addition to rotor resistance at starting improves the power factor, reduces the starting current, while it also increases the starting torque until the rotor resistance equals rotor reactance, beyond which the torque falls off.

Excellent discussions concerning the various methods employed for starting polyphase induction motors are given in the following:

- ALTERNATING CURRENTS. A. Hay. London, 1906.
- ELECTRIC MOTORS. H. M. Hobart. London, 1904.
- ELECTRIC MOTORS. N. G. Meade. 1908.
- HANDBUCH DER ELEKTROTECHNIK, Vol. IX. Leipzig, 1901.
- POLYPHASE MOTOR. B. G. Lamme. *Electric Journal*, Vol. I, 1904.
- THE INDUCTION MOTOR, CHOICE OF TYPE. G. Stevenson. *Journal Inst. E. E.*, Vol. XLI, 1908.
- WECHSELSTROMTECHNIK. E. Arnold. 1909.

CHAPTER XVI.

SPEED CONTROL OF POLYPHASE INDUCTION MOTORS.

THE induction motor, as already shown, is substantially a constant speed machine. Its change in speed between rated load and no load is from 4 to 8 per cent, depending upon the capacity of the machine, the larger sizes usually having the better speed regulation. However, for many practical applications, such as hoisting, machine tool and traction work, it becomes advisable to have a motor, the speed of which may be adjusted over wide limits. It is the object of this chapter to examine the various methods by means of which the adjustability of the speed of an induction motor can be secured, and these are:

Variation of the frequency of the supply voltage.

Variation of the number of motor poles.

Variation of the rotor resistance.

Cascade or concatenated connection.

Variation of applied potential.

Frequently combinations of these methods are employed in order to obtain wider speed ranges, better regulation or more gradual steps of adjustment than would be economically possible with any single control.

Variation of Supply Frequency. — The speed in r.p.m. of the rotary field of an induction motor is, as already shown, equal to $60 \text{ frequency} \div \text{pairs of poles}$; hence any change in the periodicity of the applied voltage would be reproduced in exact proportion in the speed of the rotary field. Thus any method which offers a wide range of frequency is theoretically the ideal system of speed control; unfortunately, however, the obtaining of such a source of power supply is not commercially feasible at present. In the case where but a single motor is operated, the generator speed could be altered, and thus the frequency of the current. The voltage should be varied as the frequency when this method of control is em-

ployed, otherwise the no load current would either be excessive or too small, according as the frequency is low or high, and thus the power-factor of the machine considerably changed.

The induction motor, when operated in the manner above indicated, is substantially a constant torque machine, in the sense employed in this book (p. 47). The speed-torque, current-torque, and power factor-torque curves of a 20-h.p. motor, when operated with currents having frequencies of 20, 40 and 60 cycles, are respectively as shown in Fig. 124. The supply voltage is

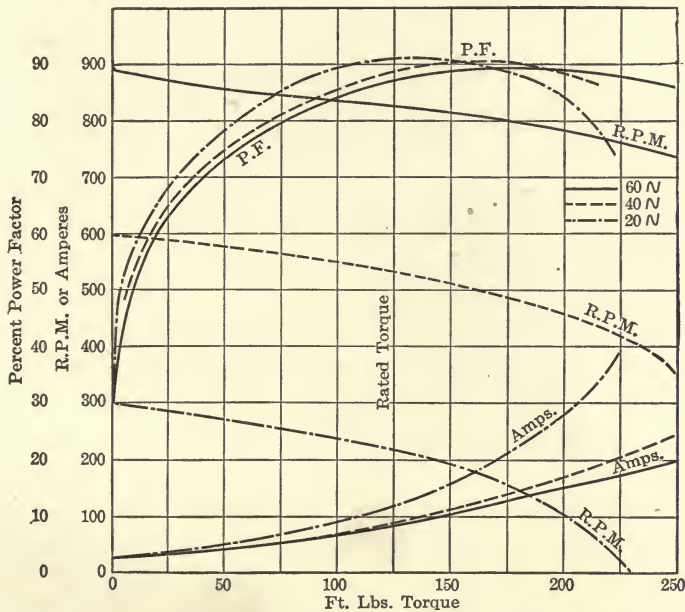

FIG. 124. — CHARACTERISTIC CURVES OF AN INDUCTION MOTOR WITH FREQUENCY CONTROL.

altered with the frequency; that is, pressures of 72.5, 143 and 215 volts are employed. This group of curves shows that the current and power factor for any given torque equal to, or less than, the rated value are practically constant, and independent of the frequency employed. The speeds attained at a given torque vary in a greater ratio than the frequency, being 836 r.p.m. at rated torque and 60 cycles, 530 r.p.m. at 40 cycles; and 230 r.p.m. at 20 cycles, practically a 4 to 1 range. This difference is due to the departure of the machine from ideal conditions, since resistance and leakage

are present. The regulation becomes poorer as the periodicity is lowered.

Speed Control by Changing Number of Poles. — The synchronous speed in r.p.m. of an induction motor being given by the expression $60 \times f \div p$ (p. 173), it is evident that the speed varies inversely as the number of poles. Thus a motor wound for six pairs of poles and operating normally at 600 r.p.m. will rotate at a speed of 1200 r.p.m. if its stator winding be rearranged so as to have 3 pairs of poles. The simplest method of applying this control is to employ a stator having two or more separate windings, corresponding to different numbers of poles. One winding may be used, it being arranged for different speeds by means of a commutator switch, which alters the grouping of the coils and thus the number of poles. A rotor of the squirrel-cage type is the *only* practical one, because this being short-circuited upon itself is adapted to any number of poles. A grouped or polar rotor winding requires a rearrangement of its coils in the same order as those of the stator, though two or more independent rotor windings could be used.

The connections of a *multi-speed* motor of this type are relatively simple, especially if only a two to one speed step is required and the rotor is of the cage type. In such instance, only six leads are brought out from the machine if it is for three-phase circuits, and eight when for two-phase lines. However, should a polar rotor winding be used (to allow for slip-ring control), twelve leads must be brought out from the machine if it is for three-phase connection, six of these terminals being for the stator winding and the remainder for the rotor. Similarly if a three to one speed adjustment (in three steps) were wanted, three-pole groupings would be required, and eighteen leads would be brought out from the motor, nine for the stator and rotor respectively. Consequently this method of control is objectionable as regards complication of connections when more than a two to one speed is desired, especially in the case of machines having wound rotors. A further criticism is that the speed changes can be made *only* by opening and closing the connections to the supply lines, which as already shown (p. 194) is very likely to cause wide variations in the primary current and fluctuations in the line voltage.

The power factor of this type of *multi-speed* machine is not greatly affected by change in the number of poles, though it is somewhat

higher with the smaller number. The efficiency and speed regulation are better with the greater number of poles. This method for adjusting the speed of an induction motor, when a two to one range is desired, is undoubtedly the most satisfactory as regards efficiency and excellence of speed regulation. High first cost and the need of disconnecting it from the line to change the speed are the objections which operate against its general adoption.

Variation of Resistance of Rotor Winding. — The third method of adjusting the speed of an induction motor is by varying the resistance of the rotor winding. This arrangement has already been considered under the heading of slip-ring control, and curves showing the effect of resistance in the rotor are given on pp. 201, 202. It does *not* give a constant or even approximately constant speed over the torque range. The speed changes occurring upon variation of torque are very marked, and depend upon the value of the external resistance employed, the character being as shown in the curves of Fig. 121. The speed regulation is comparable to that of a d. c. shunt motor having an external resistance in series with the armature, and the other objections mentioned as regards low efficiency and considerable space occupied by the controller also obtain. Consequently, this method should be employed only when the periods of speed adjustment are of relatively short duration, the motor being operated most of the time at rated speed. It is, however, used considerably in connection with the other methods of speed control, for transition from one running speed to another.

Speed Control by Cascade Connection. — The fourth system of induction motor speed adjustment is variously known as the *cascade*, *concatenation* or *tandem* control.* The application of this method necessitates the use of at least two motors, the revolving members of which are coupled together, either directly upon the same shaft or indirectly by the load, as in the case of an electric locomotive. The first of the motors (*i.e.*, that normally connected to the line) has its rotor provided with a polar winding, so arranged as to deliver at standstill a voltage of the same pressure and number of phases

* C. P. Steinmetz, *Electrotechnische Zeitschrift*, 1899, Vol. XIX, p. 884. Speed Control of Induction Motors, H. C. Specht, 1909, *Elect. Journal*, Vol. VI, Nos. 7 and 8. Multi-speed Induction Motors, H. Reist and H. Maxwell, *Trans. A. I. E. E.*, Vol. XXVIII, 1909, p. 971. *Wechselstrom-technik*, E. Arnold, Vol. V, pp. 485-519, 1909.

as is furnished by the power circuit. This secondary is connected to the stator winding (primary) of the second motor. The rotor of this latter machine may be of the squirrel-cage or slip-ring type. In case the slip-ring rotor is employed, resistance control may be utilized for transitional steps.

The cascade connection of two three-phase induction motors is shown diagrammatically in Fig. 125. Motor *A* receives the line

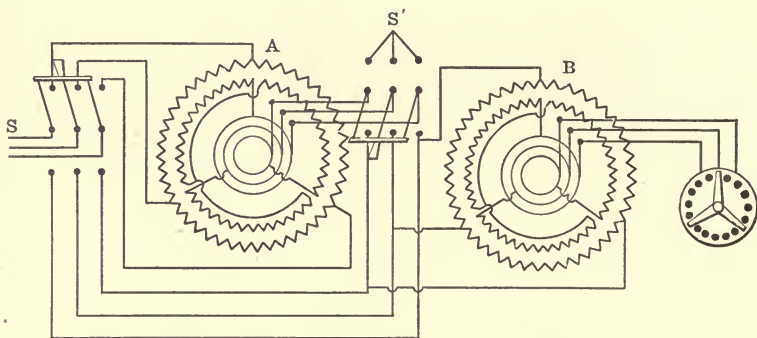

FIG 125. — TWO THREE-PHASE MOTORS ARRANGED FOR CASCADE OR INDEPENDENT OPERATION.

(Switch *S* up and *S'* down for cascade connection.)

voltage at rated frequency upon closing the supply switch *S*. Its secondary delivers three-phase currents of the same frequency and voltage to the stator of machine *B* when jaw of switch *S'* is connected to its lower set of terminals; consequently both motors will accelerate. However, as motor *A* speeds up, the frequency of its rotor currents will decrease, and at fifty per cent rated speed this latter current will have a frequency of one-half of that of the line. Motor *B* receiving a current of one-half line frequency will also run at one-half speed. Therefore, if both motors are coupled as above shown, this half speed is the point at which the machines tend to operate together. Rated speed is obtained when one machine only is employed, the second being cut out entirely by short-circuiting the slip-rings of rotor *A* by means of the switch *S'*; consequently this system gives a two to one speed adjustment.

The above argument applies to the use of two motors having an equal number of poles. If, however, the machines connected in cas-

cade have a different number of poles, they will operate at speeds other than half normal. For example, referring to Fig. 125, when either motor *A* or *B* is operated singly, the synchronous speed in r.p.m. = $\text{frequency} \times 60 \div \text{pairs of poles}$, or the cascade set could be employed to give the speed of either motor, depending upon which one was connected to the line. The next step would be to connect the secondary of machine *A* to that of the primary of motor *B*, short-circuiting the rotor of the latter. This connection also gives one of two speeds, depending upon the employment of *direct* or *differential* concatenation. If the former is used, *both motors tend to rotate in the same direction* and the synchronous speed of such a combination is given by the expression:

$$\text{r.p.m.} = f \times 60 \div (p_A + p_B) \quad (41)$$

wherein *f* is the frequency of the supply circuit in cycles per second, while p_A and p_B are the pairs of poles of motors *A* and *B* respectively.

Inverse or *differential* concatenation is obtained when the machines are so connected *that they tend to start up in opposite directions*; in such case the synchronous speed is:

$$\text{r.p.m.} = f \times 60 \div (p_A - p_B). \quad (42)$$

Cascade connection of two motors having a different number of poles consequently provides a method of obtaining a four speed outfit, the speed range depending upon the number of poles of the respective machines. For example, if motor *A* has 6 pairs of poles and *B* has 2 pairs, while the line has a frequency of 60 cycles per second, the following synchronous speeds could be obtained:

1. Motor *B* operating alone, $\text{r.p.m.} = f \times 60 \div p_B = 60 \times 60 \div 2 = 1800$.
2. Motors *A* and *B* connected in *differential* concatenation, $\text{r.p.m.} = f \times 60 \div (p_A - p_B) = 60 \times 60 \div (6 - 2) = 900$.
3. Motor *A* operating alone, $\text{r.p.m.} = f \times 60 \div p_A = 60 \times 60 \div 6 = 600$.
4. Motors *A* and *B* connected in *directed* concatenation, $\text{r.p.m.} = f \times 60 \div p_A + p_B = 60 \times 60 \div (6 + 2) = 450$;

or a speed range of four to one is attained.

The torque developed by a group of motors in cascade *depends upon whether they are connected* in direct or differential order, and it may be determined by the following equation:

$$\text{Torque in lbs. at 1 ft. radius} = .117 (W_i - \omega_l) \frac{p_A \pm p_B}{f} \quad (43)$$

wherein W_i represent motor watts input, ω_l watts lost in primary of the motor, p_A and p_B number of pairs of poles of machines A and B respectively, and f the frequency of the supply current in cycles per second. The plus sign is employed in case of direct concatenation and the minus sign when differential connection is used. The latter gives the lowest starting torque, and the set will not start up if the motor having the larger number of poles is connected to the line. The method of starting in such instance is to speed up the set by using the motor with the smaller number of poles singly, and when the synchronous speed for differential connection has been slightly exceeded, the switches are thrown over so that the desired differential arrangement is secured, after which the equipment will continue to work properly. It is possible to operate in cascade, having the motor with the smaller number of poles normally connected to the line, which condition gives a self-starting differential arrangement, but such order of connection is not particularly desirable, because the iron losses of the set would be greatly exaggerated, owing to the high frequency of the current in the secondary circuit.

The characteristic curves of a group of induction motors connected in cascade can be determined by means of any of the circle diagram methods, the test data necessary for the construction being determined in substantially the same manner as for a single machine. The power factor and efficiency of a cascade group of given capacity at any torque and speed, on account of the combined wattless components and losses, will be lower than that of a single machine having the same rating.

A great advantage of the two motor equipment is that two efficient running speeds can be obtained *without* opening the supply switch, and thus the possibility of producing line disturbances, as would occur with the other form of *multi-speed* induction motors, is eliminated.

It is possible by an extension of the cascade connection to three

motors to obtain a very wide speed range of many steps. For example, by using on a 60-cycle circuit a set of three motors having 14, 8 and 2 pairs of poles respectively, a speed range from 138 to 1800 r.p.m. is secured. The cost of such a system is, however, extreme, and the usual demands of practice are more economically met by employing a two motor set, utilizing gearing to secure the wider speed ranges.

Speed Control of Variation of Applied Potential. — The slip of an induction motor, at a given torque, varies approximately inversely as the square of the primary voltage (p. 182), and this is the principle governing the action of the potential method of speed control. The usual manner of securing this adjustable voltage is through a multi-tapped compensator, which is introduced into the primary circuit. The connections of this method are substantially the same as those of the compensator starting device shown in Fig. 115 (p. 195), excepting that the contactors slide over the taps, instead of being fixed in position. The speeds secured at different values of poten-

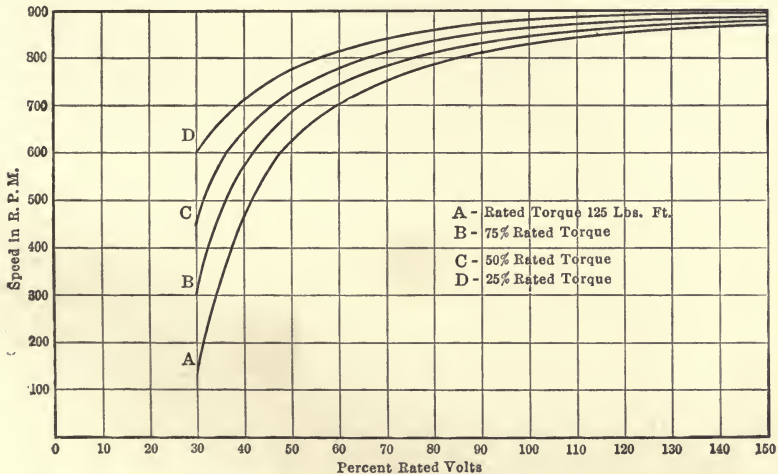

FIG. 126. — SPEED-VOLTAGE CURVES OF A THREE-PHASE 20-H.P. INDUCTION MOTOR.

tial with various values of torque are shown in the curves of Fig. 126, and from these the speed regulation, for any selected voltage, upon change in torque is readily obtained. For example, the speeds for different torques at 50 per cent rated potential are determined by drawing a vertical line through this voltage abscissa. The

intersections of this line with the curves gives the speed developed at the corresponding torques. The speed regulation of a motor controlled by this method is very poor, while the power-factor and efficiency decrease with the speed.

The regulation and efficiency are even less satisfactory when adjustable resistance in the primary is employed in place of the compensator. In fact, the potential method of induction motor speed control is most unsatisfactory. Its use should not be at all recommended except perhaps in the special case of traveling cranes, where the more desirable methods already considered introduce too great a complication in wiring and trolley connections.

For further information concerning induction motor speed control see the following:

ALTERNATING CURRENTS. A. Hay. London, 1906.

DIE REGULIRUNG VON DREHSTROM-MOTERN. W. Burkard. *Elektrotech-Zeit*, August, 1903.

DIE TOURENREGULIRUNG VON INDUKTIONS MOTERN. M. Osnos. *Elektrotech-Zeit*, 1902, p. 1075.

SPEED CONTROL BY FREQUENCY CHANGERS. H. C. Specht. *Elect. Journal*, Vol. VI, 1909.

SPEED CONTROL: POLYPHASE MOTOR. B. G. Lamme. *Electric Journal*, Vol. I, 1904; Vol. VI, 1909.

THREE-PHASE MOTORS — WIDE SPEED RANGE. Dr. H. B. Eschenburg. *Electrician*, London, 1903.

TOURENREGULIRUNG VON INDUKTIONS MOTERN. J. K. Sumac. *Zeit-für Elek.-Tech.*, 1904.

WECHSELSTROMTECHNIK. Vol. V. E. Arnold. 1909.

CHAPTER XVII.

THE SINGLE-PHASE INDUCTION MOTOR.*

THE simplicity of single-phase systems in comparison with poly-phase ones makes them more desirable for small alternating-current plants. The constant-speed motor most extensively used in connection with such service is of the single-phase induction type and structurally it is very similar to the corresponding polyphase machine.† In fact any polyphase induction motor will operate as a single-phase machine of somewhat smaller capacity and lower power factor, if it is at first caused to rotate at nearly synchronous speed by some starting arrangement. The necessity of providing some such auxiliary device arises from the fact that the single-phase motor, *per se*, has no starting torque. That such is the case may be readily seen without the introduction of mathematical proof.

Absence of Starting Torque. — Consider a bipolar single-phase motor, provided with a squirrel-cage rotor. The distribution of current in the secondary at standstill is as indicated in Fig. 127. The current in bars aa' is zero, because these are equivalent to a closed loop the plane of which is parallel to the flux. The maximum current is set up in bars bb' . However, this equivalent loop, if it moves at all, must move parallel to the direction of the lines of force, hence it exerts no turning effort. The bar m , carrying current as indicated, will exert a torque upon the rotor, as shown by the arrow alongside it. However, owing to the symmetry of the secondary winding, for every bar m there is another m' having a current of equal amplitude but of opposite sign. This latter bar being in a field of the same strength and direction as that in which m is located, will exert a torque equal to that developed by m , but in the reverse direction, as indicated by the corresponding arrow. In the same way the effort exerted due to the current in

* The Single-phase Induction Motor, J. H. Morecroft and M. Arendt, G. E. Review, Vol. 13, No. 5, 1910.

† The first successful motor of this type was built by C. E. L. Brown, see London Electrician, Vol. XXX, p. 358, 1893.

any bar of the winding will be neutralized by that of another symmetrically located with respect to the axis of the primary field, consequently at standstill no turning effort is developed and the motor fails to accelerate.

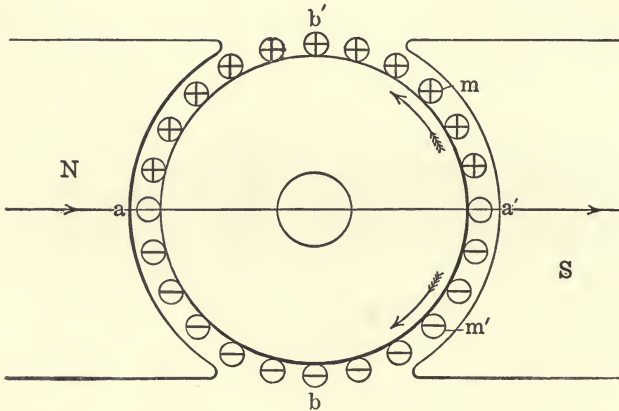

FIG. 127. — DISTRIBUTION OF CURRENT IN STATIONARY ROTOR OF SINGLE-PHASE INDUCTION MOTOR.

The above fact may be proved as follows: Assume the rotor winding as composed of symmetrically placed short-circuited coils, and consider one having its plane at any angle α to the axis of the

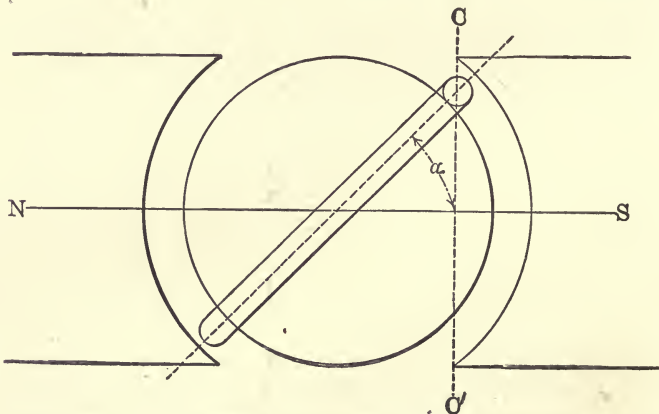

FIG. 128. — SHORT-CIRCUITED COIL INCLINED TO AXIS OF MAGNETIC FIELD.

field *NS*, as illustrated in Fig. 128. Further suppose the flux distribution to be a cosine function of α ; this is approximately the case with actual motors provided with distributed stator windings,

and then let

B represent the maximum flux density at $\alpha, = 0^\circ$,

$B \cos pt$ represents the instantaneous flux density at $\alpha, = 0^\circ$,

$B \cos pt \cos \alpha$ represents the corresponding value at the inductors selected, and with A as the area of the coil the flux passing through it becomes

$$\Phi = \int_0^\alpha AB \cos pt \cos \alpha d\alpha = BA \cos pt \sin \alpha. \quad (44)$$

The e.m.f. induced in the selected coil is

$$e = - \frac{d\Phi}{dt} = BA p \sin pt \sin \alpha. \quad (45)$$

The instantaneous value of the corresponding current is

$$i = BA p \sin (pt - \theta) \sin \alpha \div Z'. \quad (46)$$

Naturally in the case of a single coil this current will react upon the stator field and produce flux distortion; but as we are going to sum up the effects of all the rotor coils, the individual reactions balance, and the field distortion becomes negligible. It is to be noted that the impedance of a coil will be modified by the action of the neighboring coils, consequently Z' in equa. 46 represents the effective impedance. The angle $\theta = \cos^{-1}(r' \div Z')$, wherein r' is the effective resistance of the coil and Z' the impedance as above defined.

If there are n coils on the rotor equally spaced from one another, the torque of the K th coil will be

$$t_k = lB^2A p [\sin (2 pt - \theta) + \sin \theta] \sin \frac{2K}{n} \pi \div 2 Z', \quad (47)$$

wherein l is the length of one coil.

The instantaneous torque exerted by the whole rotor is

$$T = \Sigma t = lB^2A p [\sin (2 pt - \theta) + \sin \theta] \Sigma_1^n \sin \frac{2K}{n} \pi \div 2 Z' = 0.* \quad (48)$$

Development of Revolving Field. — We have just shown that when we have an oscillating magnetic field the rotor placed therein fails to exert any starting torque. Therefore, if a single-phase induction motor does develop a turning effort after it is caused to revolve, it must be because it has, by some reactions of the rotor

* This same result is obtained from analysis of equation 60, p. 225.

currents upon the stator flux, provided for itself a rotating magnetic field. That such is the case may be shown non-mathematically. Assume a two-pole motor (Fig. 129) the stator winding of which is supplied with a single-phase alternating current, producing an oscillating field between the poles AA' . The rotor currents pro-

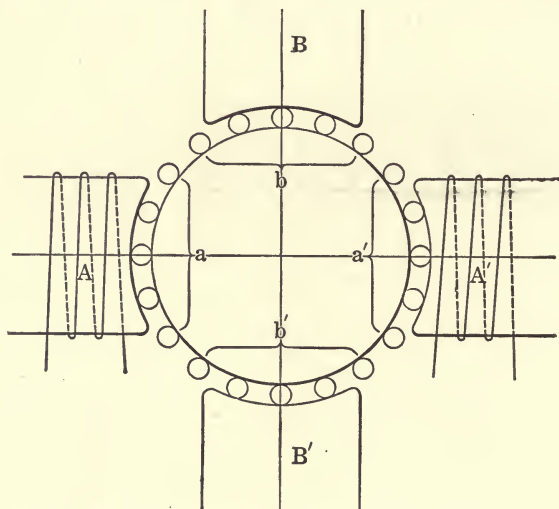

FIG. 129. — MAIN AND QUADRATURE FIELDS, SINGLE-PHASE INDUCTION MOTOR.

duce a field at right angles to the main field, and for convenience we will assume this to be represented by the poles BB' . In commercial machines no such empty pole spaces exist, as practically all of the stator is covered with coils.

The inductors of the revolving rotor have e.m.f.'s induced in them due to two actions, namely by motion through the field and by the time rate of change of the flux threading the coils. The first we shall designate as a *rotational* e.m.f. and the second as a *transformer* e.m.f.

The inductors aa' will always have a rotational e.m.f. set up in them except when the stator field passes through zero value. The amplitude of this e.m.f. for any given speed will be proportional to the instantaneous value of the stator flux. Conductors aa' may be considered equivalent to closed coils, and the current flowing in them will produce a field in direction BB' . Neglecting temporarily the IR drop in the rotor, the e.m.f. induced in aa' may be placed equal to $\frac{d\Phi_r}{dt}$, where Φ_r denotes the cross field developed by

the currents due to the motion of the rotor in the main field. The rotational e.m.f. is in time phase with the main field, hence the cross field Φ_r will be in time quadrature with it. The direction of the main field and the motion of the rotor inductors are such that the e.m.f. generated in aa' is positive.* The rotor currents are in such direction that when pole A is of north polarity and decreasing, pole B will be of like sign but increasing, reaching its maximum strength one-quarter of a period later. The strength of pole B decreases after a similar lapse of time, the main field reverses and a north pole begins to build up at A' . *That is, the main field and quadrature field so combine that a north pole travels around the stator in the direction $ABA'B'$ at synchronous speed.* Hence there exists a rotating field produced by the combined action of stator and rotor currents. This simple explanation gives an idea of the production of the rotating field in the single-phase induction motor, but it does not consider all the reactions which occur.

The inductors bb' moving in the quadrature field have a rotational e.m.f. induced in them, in the same manner as those passing through the main field, and this is of maximum positive value when the north pole at B attains its highest value. In addition to these *two rotational* e.m.f.'s, the varying fields AA' and BB' set up *transformer* e.m.f.'s, in coil groups bb' and aa' respectively. Consequently, there are *four* e.m.f.'s, to be considered before the actual rotor currents which produce the quadrature field can be determined.

The rotational e.m.f. induced in inductors aa' is of maximum positive value when the pole A is at its greatest north polarity, but the transformer e.m.f. set up in these bars by the quadrature field is at the same moment of maximum negative value. Hence the actual e.m.f. (E_a) existing in AA' is the *algebraic* sum of these two voltages. The rotational e.m.f. due to the main field must be greater than the transformer e.m.f. of the quadrature field; in fact the latter is of such strength that the actual e.m.f. (E_a) will be just enough to establish the current which produces the field BB' . Since this quadrature field is at right angles to the main field, its m.m.f. cannot be furnished directly by the stator magnetizing current, so we must investigate further to see how it is taken, as it must be, from the line. It must be remembered that the imped-

* Currents flowing away from the reader into the plane of the paper are called positive.

ance of the rotor coils is here assumed to be such that the IZ drop is negligible; if this is not the case, the rotational and transformer e.m.f.'s will not be in time opposition and then *vector sum*, instead of *algebraic sum*, must be considered.

The main field, by transformer action, induces an e.m.f. in bars bb' , and this is opposed to the e.m.f. developed in the same inductors by their motion through the quadrature field. The resultant e.m.f. (E_b) in these conductors sets up a current affecting the main field and consequently the current drawn from the line. The current flowing in inductors bb' due to E_b is equal to that existing in bars aa' , which latter is that producing the cross m.m.f. Moreover, the current bb' is in such direction that it increases the magnetizing current taken from the line, the increment being that which would be necessary to directly magnetize the quadrature field. The reluctance of the cross field's magnetic circuit is substantially the same as that of the main field, consequently the m.m.f. required for both will be the same, and obviously, therefore, a two-phase

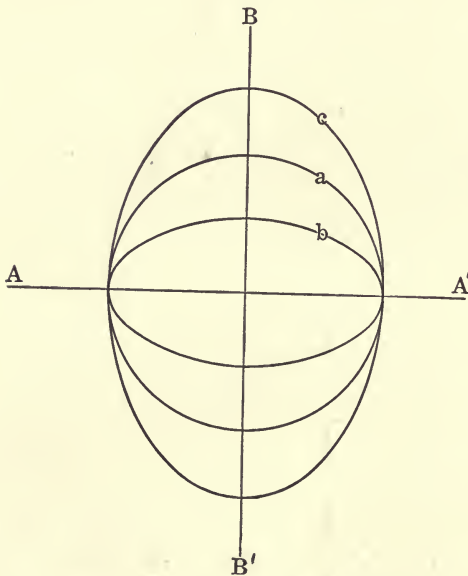

FIG. 130. FORMS OF ROTATING FIELD AT VARIOUS ROTOR SPEEDS.

motor run on one phase will draw twice its normal magnetizing current. This conclusion is borne out by actual practice, tests showing that *the magnetizing current of a single-phase motor is double that taken per phase by a two-phase and three times that required by a three-phase machine, the potential difference, frequency and turns per phase winding being the same.*

At synchronous speeds the two component fields are of equal strength; accordingly they combine to give a circularly rotating field. Below synchronous speed the rotating e.m.f. in the bars aa' is reduced in inverse proportion to the slip, and thus the

quadrature field diminishes, while the main field remains constant. Consequently the rotating field developed below synchronous speed is of an elliptical form, the shorter axis being in the direction of the quadrature field BB' . When driven above synchronous speed the field is also of elliptical form, the major axis, however, being in the direction of the cross field. The field forms for different speeds are as illustrated in Fig. 130, a, b, c, respectively, corresponding to synchronous, sub-synchronous and super-synchronous speeds.

The maximum torque which a motor is capable of exerting, other things being equal, depends upon the average value of the magnetic field in which the rotor moves. This mean value, neglecting IR drop and leakage, is in the polyphase induction motor independent of the slip, while for the corresponding single-phase machine the average value of the field decreases as the slip increases; thus the pull-out torque of a polyphase machine connected single phase will be less than when normally operated.

Many interesting facts concerning the rotor currents as well as the development of the rotating field may be derived through

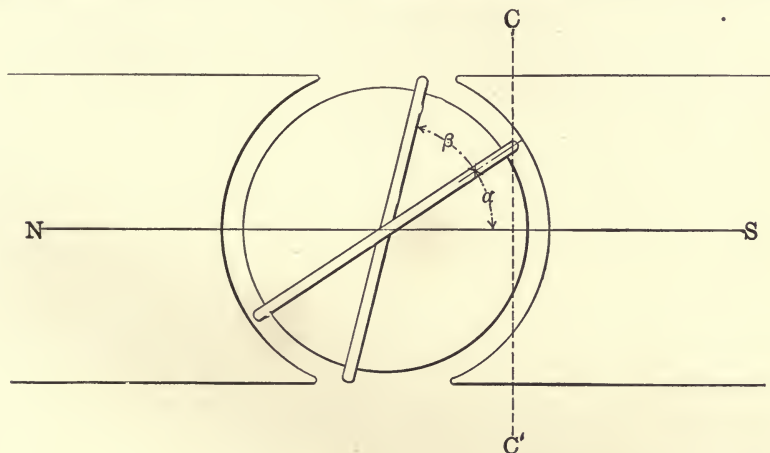

FIG. 131. COILS INCLINED TO AXIS OF OSCILLATING FIELD.

a simple mathematical analysis. Let us consider the elementary bipolar single-phase induction motor represented in Fig. 131 with a coil at an angle α to the main polar axis. Assume as before (p. 214) that the flux distribution is a cosine function of time, and adopt the following notation:

A = area of coil.

ω = angular velocity of the coil, or $\alpha = \omega t$.

$A \sin \alpha = A \sin \omega t$ = projected area of coil on plane CC' perpendicular to the flux NS .

B = maximum flux density, its instantaneous value being $B \cos pt$.

Instantaneous flux interlinking coil α is

$$\begin{aligned}\Phi &= AB \cos pt \sin \omega t \\ &= .5 AB [\sin (p + \omega) t - \sin (p - \omega) t];\end{aligned}\quad (49)$$

the e.m.f. induced in coil α is

$$e = -\frac{d\Phi}{dt} = .5 AB \{ (p - \omega) \cos (p - \omega) t - (p + \omega) \cos (p + \omega) t \}.\quad (50)$$

Let r_1 and L_1 represent respectively the effective resistance and inductance of the coils; the values of these constants are based not only upon the character of an individual coil but also to some extent upon the action of neighboring coils. With this notation the current in any secondary coil can be considered as resulting from the e.m.f. of equa. 50, or

$$I = .5 AB \left\{ \frac{p - \omega}{[r_1^2 + (p - \omega)^2 L_1^2]^{\frac{1}{2}}} \cos [(p - \omega) t - \theta_1] - \frac{p + \omega}{[r_1^2 + (p + \omega)^2 L_1^2]^{\frac{1}{2}}} \cos [(p + \omega) t - \theta_2] \right\},\quad (51)$$

wherein

$$\theta_1 = \cos^{-1} \frac{r_1}{[r_1^2 + (p - \omega)^2 L_1^2]^{\frac{1}{2}}} \quad \text{and} \quad \theta_2 = \cos^{-1} \frac{r_1}{[r_1^2 + (p + \omega)^2 L_1^2]^{\frac{1}{2}}}.$$

The fluxes produced by one rotor coil and the main field will so react upon each other that the value of the secondary current, if but a single coil be considered, can be expressed only by an infinite series. It has been experimentally shown, however, that the flux-distorting reactions between primary and secondary do not exist with a rotor winding composed of a number of coils which are divisible into pairs, the members of which are placed at 90 degrees (electrical) to each other. The rotor winding of a commercial machine substantially satisfies this condition; consequently the

higher harmonics of the rotor current disappear and the same is correctly represented by equa. 51 given above. This equation indicates that the rotor current consists of two parts having different frequencies and amplitudes.

At standstill any coil spaced an angle γ from the axis of the magnetic field will have a current of the following form:

$$I \text{ standstill} = - \frac{ABp \cos (pt + \gamma - \theta_{ss})}{(r_1^2 + pL_1^2)^{\frac{1}{2}}}, \quad (52)$$

which shows that the secondary current at standstill is of line frequency. The current component with frequency $(p - \omega)$ decreases in value as the rotor speed rises toward synchronism, being zero at that limit, and the secondary current then becomes

$$I \text{ syn} = - \frac{ABp \cos (2pt + \gamma - \theta_{\text{syn}})}{(r^2 + 2pL_1^2)^{\frac{1}{2}}}, \quad (53)$$

which is of double-line frequency.

These variations of rotor current frequencies as well as the presence of the differential $(p - \omega)$ and additive $(p + \omega)$ components may be conveniently observed by the application of a reed frequency meter. Connect such an instrument across the slip rings of the wound rotor of a polyphase motor, excite the stator with single-phase current and then start the machine. As the speed of the rotor increases, the frequency meter will indicate the presence of two currents, one increasing and the other diminishing from the line frequency.

Let us now select a coil on the rotor displaced any angle β from the loop α we have just considered, Fig. 131. The flux through this new coil at *synchronous speed* ($\alpha = \omega t = pt$) will be, from equa. (49),

$$\begin{aligned} \Phi &= AB \cos pt \sin (pt + \beta), \\ &= \frac{AB}{2} \left\{ \sin (2pt + \beta) + \sin \beta \right\}, \end{aligned} \quad (54)$$

$$\text{e.m.f. coil } \beta = e = - \frac{d\Phi}{dt} = -ABp (\cos (2pt + \beta)), \quad (55)$$

$$\text{current coil } \beta = i = - \frac{ABp}{\sqrt{r^2 + 2pL^2}} \cos (2pt + \beta - \theta), \quad (56)$$

$$= K_1 \cos (2pt + \beta - \theta). \quad (57)$$

The total magneto-motive force of all the coils on the rotor may be expressed as $K_1 \Sigma i$. The maximum m.m.f. exists in the plane of the coil in which the current is equal to zero, and hence the poles of the rotor will be in the same plane. Let β' be the angle of that particular coil; then

$$i = K_1 \cos (2 pt + \beta' - \theta).$$

But since i is equal to zero,

$$K_1 \cos (2 pt + \beta' - \theta) = 0,$$

whence

$$2 pt + \beta' - \theta = \frac{\pi}{2}$$

and

$$\beta' = \left(\frac{\pi}{2} + \theta \right) - 2 pt.$$

This means that the angle between the reference coil and the magnetic pole of the rotor changes at the rate of $-2pt$. It also indicates that the pole rotates backwards on the rotor. The latter, however, is turning forward at a rate pt , consequently the rotor poles revolve backward in space at a rate pt , and the equation of this pole in space is

$$\beta' = \left(\frac{\pi}{2} + \theta \right) - pt.$$

If the equation for the current in the general coil is referred to the magnetic axis instead of to the reference coil, we have

$$i = K_1 \cos \left\{ (2 pt + \beta - \theta) + \left(\frac{\pi}{2} + \theta - 2 pt \right) \right\} = K \cos \left(\beta + \frac{\pi}{2} \right).$$

That is, referred to the magnetic axis of the rotor the current distribution is constant, hence the m.m.f. of these currents is constant and rotates backward at synchronous speed, as above proved.

The relative value of the stator and rotor m.m.f.'s may be derived as follows: Assume the rotor stationary; this corresponds to considering it the same as the short-circuited secondary of a transformer. Thus the relations existing between primary and secondary m.m.f.'s of a transformer apply or, neglecting resistance and leakage, the secondary m.m.f. is equal and opposite to that of the

primary. The current distribution in the bars on the rotor on the basis of the above assumption is expressed by equa. 46 as

$$i_0 = \frac{ABp}{\sqrt{r^2 + pL^2}} \sin(pt - \theta) \sin \beta,$$

which upon neglecting r makes $\theta = \frac{\pi}{2}$ and reduces to

$$i_0 = -\frac{ABp}{pL} \cos pt \sin \beta;$$

this if $t = 0$ becomes

$$i_0 = -\frac{AB}{L} \sin \beta. \quad (58)$$

It is to be noticed that when $t = 0$, the equation of the rotor currents at synchronous speed (equation 56) reduces to

$$i_r = -\frac{ABp}{\sqrt{r^2 + 2pL^2}} \cos(\beta - \theta),$$

which can be still further simplified, if r is negligibly small with respect to pL , to the following form,

$$i_r = -\frac{AB}{2L} \sin \beta. \quad (59)$$

Comparing these values of i_0 and i_r we see that these currents have the same distribution in the rotor, but the amplitude of the latter is only one-half that of the former. Consequently, since the m.m.f.'s of the stationary rotor and of the stator are equal, the m.m.f. of the synchronously revolving rotor is one-half that of the stator winding.

The magneto-motive force effective in developing the flux $B \cos pt$ when the two fields coincide may be expressed as $Y - X$, wherein Y represents the maximum m.m.f. developed by the stator and X that due to the rotor. But, as above shown, $X = Y \div 2$, hence the excitation necessary to produce the flux $B \cos pt$ throughout the magnetic circuit of the machine is $\frac{Y}{2}$ or X .

The two magneto-motive forces acting at any instant in this type of machine are:

$Y \cos pt$, stationary in space.

X , constant in value, but rotating backward at synchronous

speed. Since X rotates backwards it may be written $X = X \cos pt - X \sin pt$, and consequently $Y - X$, the total magneto-motive force acting at any instant, becomes

$$Y \cos pt - X \cos pt + X \sin pt = X \cos pt + X \sin pt.$$

This means that *the total m.m.f. acting at any instant is of constant value and rotates forward at synchronous speed.*

The magnetic reluctance of commercial single-phase motors, due to the use of uniformly distributed windings, is practically the same, whatever the axis of the field, consequently the reactions existing between stator and rotor currents produce at or near synchronous speed a circular rotating field, and the formulæ which apply to polyphase motors may be utilized. The effect of leakage and rotor resistance will modify this rotating field somewhat, changing it from circular to elliptical form.

Torque Equations. — It has been indicated on p. 220 that when the secondary of a single-phase induction motor is caused to rotate at any rate ω , its current may be expressed as

$$I = \frac{AB}{2} \left\{ \frac{(\rho - \omega)}{\sqrt{r_1^2 + (\rho - \omega)^2 L_1^2}} \cos [(\rho - \omega)t - \theta_1] - \frac{(\rho + \omega)}{\sqrt{r_1^2 + (\rho + \omega)^2 L_1^2}} \cos [(\rho + \omega)t - \theta_2] \right\}.$$

Inspection of this equation shows that the rotor current is composed of two parts, one of a lower and the other of a higher frequency than the rotating field. We may consequently consider that this current is set up through the action of two synchronously rotating fields, one revolving in the same direction as the rotor and the other oppositely.* The frequency of the rotor current component due to the suppositional field revolving in the same direction as the rotor is naturally less (by the velocity of the rotor) than synchronous value or it is $(\rho - \omega)$. The component due to the oppositely rotating field has a frequency higher than that of the line, its value being $(\rho + \omega)$.

The per cent slip of the rotor with respect to the first field is $\left(\frac{\rho - \omega}{\rho}\right) 100$, and referred to the second field it is $\left(\frac{\rho + \omega}{\rho}\right) 100$.

* G. Ferraris, Mem. Reale Accad. di Scienze Torino, Series II, Vol. xlv, December 1893. Electrician, Vol. 33, pp. 110, 129, 152, 184. London, 1894.

The effective turning effort of the motor is the resultant of the interaction between the rotor current and two oppositely rotating fields. But, since the rotor and one field turn in the same direction, the torque due to this latter field must be greater than that set up by the other. We have seen from equa. 38 (p. 180) that the torque developed by a polyphase induction motor is expressed by the following equation:

$$T = \frac{N_2^2 e^2 s r_2}{\omega_1 (r_2^2 + s^2 X_2^2)},$$

wherein s is the per cent slip between rotating field and rotor core, while $\omega_1 = p$ is the angular velocity of the revolving field. We may accordingly write the two component torques existing in the single-phase motor as

$$T_1 = \frac{N_2^2 e^2 s_1 r_2}{\omega_1 (r_2^2 + s_1^2 X_2^2)},$$

$$T_2 = - \frac{N_2^2 e^2 s_2 r_2}{\omega_1 (r_2^2 + s_2^2 X_2^2)},$$

wherein $s_1 = \frac{p - \omega}{p} = \frac{\omega_1 - \omega}{\omega_1}$ and $s_2 = \frac{p + \omega}{p} = \frac{\omega_1 + \omega}{\omega_1}$.

The total effective torque is

$$T = T_1 + T_2 = \frac{N_2^2 e^2 r_2 (s_2 - s_1) (s_1 s_2 X_2^2 - r_2^2)}{\omega_1 (r_2^2 + s_1^2 X_2^2) (r_2^2 + s_2^2 X_2^2)}, \quad (60)$$

wherein $s_2 - s_1$ is positive for speeds below synchronism, while $s_1 s_2$ is variable but never greater than unity.

Analysis of this equation brings out the following facts:

1. That the torque of the single-phase machine varies as the square of the impressed voltage, this being the same relation as obtains in polyphase induction motors.

2. That the motor exerts no torque at standstill because $s_2 - s_1$ then equals zero, which makes the numerator of the same value.*

3. The motor cannot operate at synchronous speed, because this makes s_1 zero, in which case the torque developed is of negative value, $s_1 s_2 X_2^2 - r_2^2$ reducing to $-r_2^2$, and the machine tends to act as a generator. Consequently the single-phase induction motor must rotate at less than synchronous speed.

* (See equations (47) and (48), p. 215.)

4. The maximum value of $s_1 s_2$ being unity indicates that the single-phase induction motor cannot operate unless the reactance of its rotor winding at standstill is greater than its resistance. Unless such is the case $s_1 s_2 X_2^2 - r_2^2$ will have a negative value, which means that the machine would tend to develop a negative

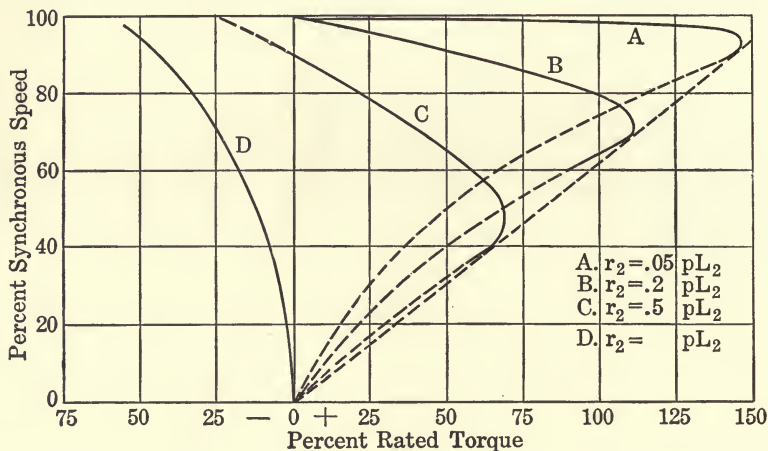

FIG. 132.—SPEED-TORQUE CURVES WITH ROTOR RESISTANCE VARIED.

torque or act as a generator. Fig. 132 indicates how the speed-torque curves of a single-phase induction motor are affected by change in the value of rotor resistances. Curves A and B may be considered as representative of standard machines. Curves C and D indicate the effects produced by inserting relatively large resistances into the rotor winding. It is apparent from these curves that the introduction of resistance into the rotor circuit for purposes of speed regulation is attended by a marked reduction of the overload capacity of the motor, and cannot be used as conveniently or advantageously as with polyphase motors (p. 201). It is, however, employed to limit the starting current (pp. 199 and 238).

5. The torque developed by a polyphase motor operated as a single-phase machine is less than that produced when normally connected, because of the presence of the counter torque T_2 .

6. If we take the first differential coefficient of equa. 60 with respect to r_2 and place it equal to zero, we find that the maximum torque developed for any rotor speed ω exists when

$$r_2 = X_2 \overline{s_1 s_2}^{\frac{3}{2}} \div (\overline{s_1 s_2}^{\frac{1}{2}} + 2),$$

and that the maximum torque

$$T_{\max} = N_2^2 e^2 s_1 s_2 (s_2^{\frac{1}{2}} - s_1^{\frac{1}{2}}) \div \omega_1 r_2. \quad (61)$$

This equation shows that the torque at any selected speed is greater the less the value of r_2 .

Characteristic Curves. — The preceding torque equation, while valuable in that it indicates the general characteristics of single-phase induction motors, is not readily applied to the detail study of any specific machine. The working curves are most accurately determined by actual test. They may, however, be derived with moderate accuracy by means of a circle diagram somewhat similar to that utilized in connection with the study of the polyphase motor.

The particular diagram described herein (Fig. 133) is that developed by A. S. McAllister, and its construction is as follows:*

Let the vertical line OE (Fig. 133) represent the line voltage. Draw at their proper phase positions and scale values the no-load as well as the locked currents OM and OF respectively. The value of OF is determined as already explained in connection with the polyphase induction motor (p. 186).

MN and IF represent the energy components of the corresponding currents and are therefore directly proportional to the respective inputs. Through M draw a line MK perpendicular to OE , join M and F ; draw also a line perpendicular to the middle of MF intersecting MK at X . With X as a center and either XM or XF as a radius, describe the circular arc $MPPF$, this being the locus of the primary current. The distance IG represents the added primary or stator loss existing with the rotor locked, its length = (added primary copper loss \div total locked watts) $\times HF$. Draw the line GM . With this construction completed the performance of the motor may be determined by inspection. For example, the factors determining the performance of the motor with a current P are as follows:

OP to scale represents the primary current.

$\cos POE$ is the power factor of current OP .

PT represents the watts input at current OP .

MN represents the watts input at no load.

TQ represents the watts loss at current OP .

* Alternating Current Motors, A. S. McAllister, pp. 115-119. McGraw Co., New York 1909.

TR represents the total primary loss at current OP .

QR represents the added secondary copper loss.

QP represents the watts output at current OP .

$QP \div PT$ represents the efficiency of the motor at current OP .

$100 (PQ \div PR)^{\frac{1}{2}}$ represents the per cent slip.

$7.05 QP \div \text{r.p.m.}$ represents the torque at current OP .

The field set up through the motion of the rotor varies as the speed (ω), consequently the torque (T) for a given rotor input (W') will be proportional to the product of $\omega W'$, or

$$T = K_1 \omega W'. \tag{62}$$

The torque, however, is also proportional to the secondary output (W'') divided by the speed (ω), or

$$T = K_2 (W'' \div \omega)$$

whence

$$\omega = K (W'' \div W')^{\frac{1}{2}} \tag{63}$$

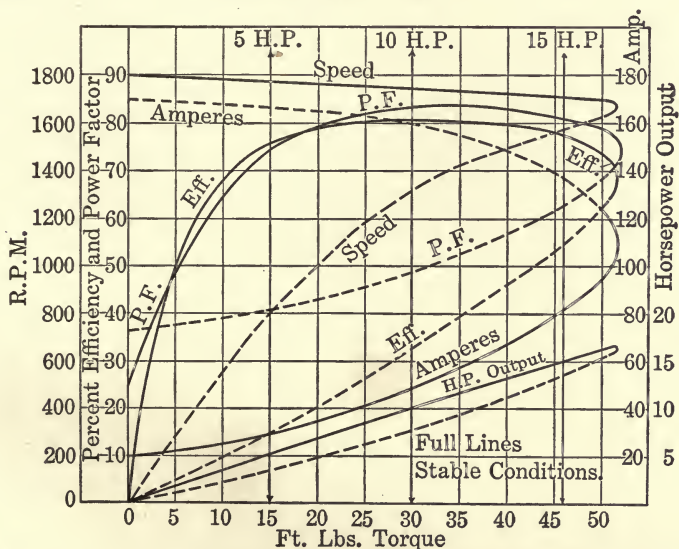

FIG. 134. — CHARACTERISTIC CURVES OF A 220-VOLT, 60-CYCLE, 4-POLE, 10-H.P. SINGLE-PHASE INDUCTION MOTOR.

The secondary input, from the circle diagram, is proportional to PR ; the output is similarly represented by PQ ; consequently $(PQ \div PR)^{\frac{1}{2}}$ corresponds to the rotor speed as above stated.

The diagram shown in Fig. 133 has been applied to the determination of the characteristic curves of a standard 220-volt, 60-cycle, 4-pole, 10-horsepower single-phase induction motor. The fundamental data employed in the construction of this diagram

were derived by test, and are as follows: stator resistance, .304 ohm; current with motor running free, 19 amperes; corresponding input, 1 k.w.; and power factor 24 per cent. The current with rotor at standstill is 170 amperes; input, 13.4 k.w.; power factor, 36 per cent. Line potential in both instances is 220 volts.

The values derived from the diagram are given in the following table and presented in the form of curves in Fig. 134.

CHARACTERISTICS OF A 220-VOLT, 60-CYCLE, 10-HORSE-POWER, SINGLE-PHASE INDUCTION MOTOR.

Point.	Amp.	% P.F.	K.W. Input.	H.P. Output.	% Eff.	R.P.M.	Ft.-lbs. Torque.
<i>M</i>	19	24	1	0	0	1800	0
1	25	65	3.56	3.4	70	1782	10
2	30	75	4.95	5.03	76	1772	15
3	40	81	7.15	7.65	80	1760	23
<i>P</i>	50	83	9.24	10.0	81	1745	30
5	60	85	11.2	12.0	80	1738	36
6	80	81	14.2	14.75	78	1715	45
7	100	78	17.2	16.5	72	1690	51
8	119	70	18.7	16.0	64	1640	51
9	140	61	18.8	13.1	52	1550	44.5
10	155	51	17.6	8.8	37.5	1400	33.0
<i>F</i>	170	36	13.4	0	0	0	0

Comparison of these characteristic curves of the single-phase induction motor with those of the standard polyphase induction motor brings out the fact that the former has zero torque not only at synchronous speed but also at standstill, whereas the latter has a starting torque in excess of that developed at rated load.

The following table gives characteristics of operation attained by standard single-phase induction motors.

DATA OF STANDARD SINGLE-PHASE INDUCTION MOTORS.
110 TO 440 VOLTS.

H.P.	Poles.	Per cent Slip.	Pull-out Torque.*	Per cent Power Factor Load.				Per cent. Efficiency Load.			
				$\frac{1}{2}$	$\frac{3}{4}$	Rtd.	$1\frac{1}{4}$	$\frac{1}{2}$	$\frac{3}{4}$	Rtd.	$1\frac{1}{4}$
$\frac{1}{2}$	4	6	1.5	46	58	66	68	53	60	63	60
1	4	4	1.6	55	59	73	75	60	63	68	62
2	4	2.5	1.8	56	65	77	76	71	75	78	77
5	4	2.5	1.8	78	83	86	86	71	76	77	76
10	4	2.5	1.8	75	81	84	83	75	79	80	79
20	6	2	1.9	78	80	86	87	85	88	86	85
30	8	2	1.9	68	80	85	84	77	81	83	82
50	4	2.3	2.0	91	94	93	91	82	84	86	86

* Pull-out torque in terms of rated load torque.

Comparison of the values of this table with the corresponding one on p. 193 shows that in general the power factor, efficiency and pull-out torque are higher for polyphase than for single-phase motors, while the speed regulation of the single-phase machine is better. This latter feature of the single-phase induction motor is accounted for by Dr. C. P. Steinmetz as follows:*

“Since in the single-phase motor one primary circuit and a multiplicity of secondary circuits exist, all secondary circuits are to be considered as corresponding to the same primary. Thus the joint impedance of all secondary circuits must be used as the secondary impedance, at least at or near synchronism. Thus, if the armature has a quarter-phase winding of impedance Z_1 per circuit, the resultant secondary impedance is $\frac{Z_1}{2}$; if it contains a three-phase winding of impedance Z_1 per circuit, the resulting secondary impedance is $\frac{Z_1}{3}$. In consequence thereof, the resulting secondary impedance of a single-phase motor is less in comparison with the primary impedance than in the polyphase motor. Since the drop in speed under load depends upon the secondary resistance, that occurring in the single-phase induction motor is generally less than with the polyphase motor.”

Methods of Starting. — As already shown (pp. 215 et seq.), the simple single-phase induction motor cannot exert any starting torque. In practice, however, except in the smallest sizes which may be started by hand, the conditions of service which this motor is to meet require a starting torque as high as 150 per cent of the rated value, consequently some device producing this feature must be connected with or incorporated into the machine. The methods of accomplishing this result may be grouped into two general classes. The first is technically known as *phase-splitting* and the second as the *repulsion-motor* method.

Split-phase Starting. — Two-phase currents may be obtained on a single-phase circuit by dividing it into two branches one of which is inductive and the other non-inductive. If supplied with two-phase currents, even though these be less than 90 degrees apart, an induction motor is self-starting; thus when synchronous speed is approximated the phase-splitting device may be cut out and the machine will continue to operate. There are many ways to obtain such split currents. The two parts of the circuit may be in series, one being shunted by inductance or capacity (Fig. 135). They may also be put into inductive relation to each other to produce a phase difference.†

* Elements of Electrical Engineering 1902, p. 284.

† U. S. Patent No. 401,520, April 16, 1889, to Nikola Tesla.

Motors employing the above starting methods are provided with two stator windings, a *working* winding and a *starting* winding. The two windings are displaced from each other by about ninety magnetic degrees, just as in the ordinary two-phase motor. The

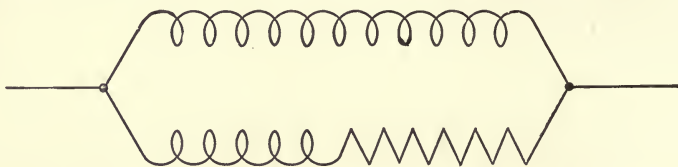

FIG. 135.—SLIP PHASE CIRCUIT, USING INDUCTANCE AND RESISTANCE.

working winding, however, is of more turns, being spread over a larger surface, and of heavier wire than the starting winding, because it remains in circuit as long as the motor operates, whereas the starting coils are only in use momentarily.

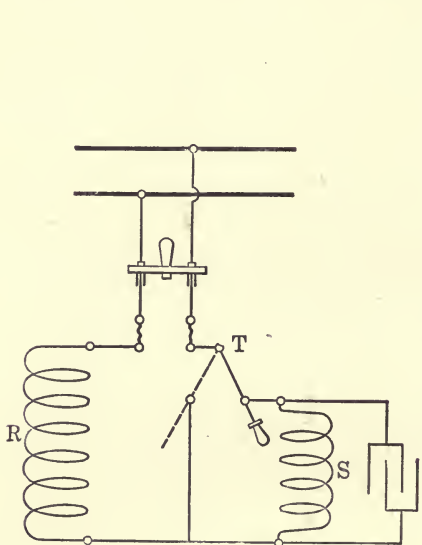

FIG. 136.—CONNECTIONS FOR STARTING SMALL SINGLE-PHASE INDUCTION MOTORS.

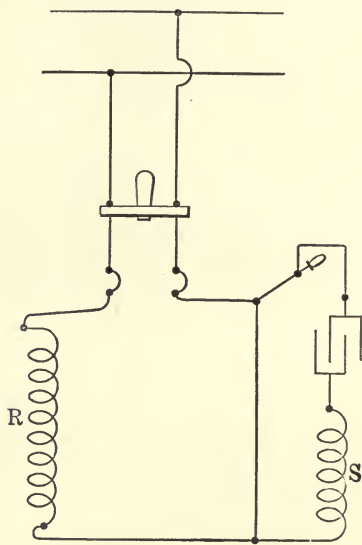

FIG. 137.—PHASE-SPLITTING METHOD DEvised BY BROWN, BOVERI FOR USE WITH LARGE MOTORS.

The method illustrated in Fig. 136 has been developed by Brown, Boveri and Co. of Baden, Switzerland. At starting the two windings are placed in series across the supply lines, the starting winding *S* being shunted by the condenser. The current

consequently lags more in that winding, the difference in phase between the currents in *R* and *S* being sufficient to set up an elliptically formed rotating field. The starting winding and its condenser are cut out, and the working winding placed directly across

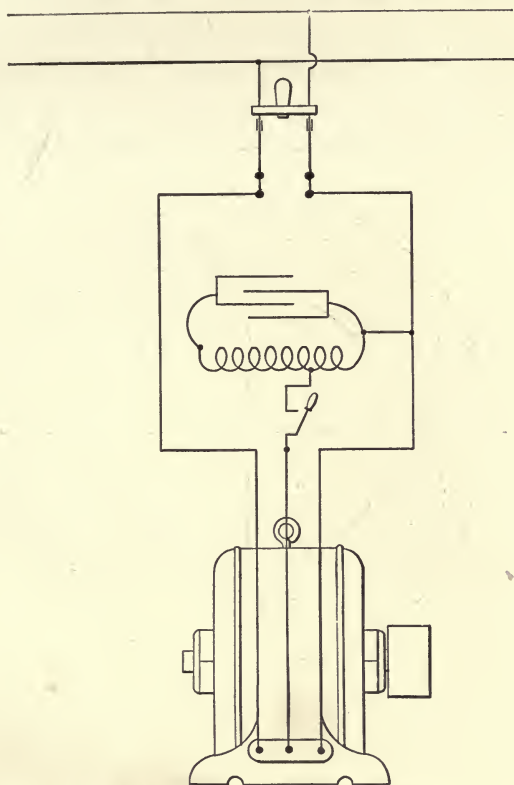

FIG. 138.—CONNECTIONS OF GENERAL ELECTRIC COMPANY CONDENSER COMPENSATOR FOR PHASE-SPLITTING AND STARTING SINGLE-PHASE INDUCTION MOTORS.

the line by means of the double-throw switch *T* when the motor has approximately attained synchronous speed. This method is slightly modified when machines of over 5-h.p. capacity are to be started. The two windings in such instances are placed in parallel, as shown in Fig. 137. By this means the working coil circuit is not broken and the flash occurring upon cutting out the auxiliary winding is eliminated.

An excellent method for starting single-phase motors has been developed by the General Electric Company under patents granted

to Dr. C. P. Steinmetz, the connections for which are substantially as shown in Fig. 138.* Two terminals of the stator winding, which is substantially of standard three-phase construction, are connected directly to the supply lines. The third terminal is also connected to either one of the mains through an auto-transformer (p. 194), the order depending upon the direction of rotation desired. The ends of this compensator are placed across a condenser. This combination is technically known as a *condenser-compensator*, and is employed because a condenser of given volt-ampere

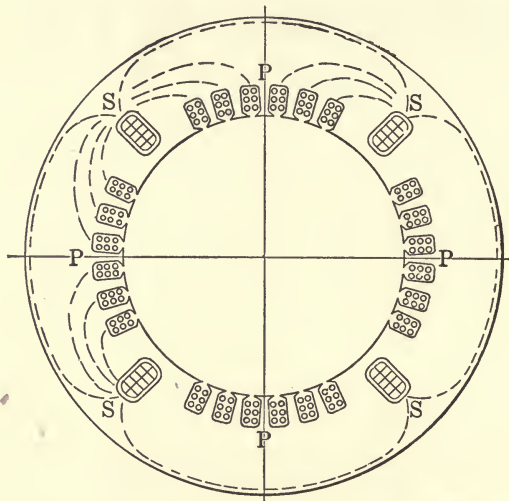

FIG. 139.—ARRANGEMENT OF WORKING AND AUXILIARY STATOR COILS, HEYLAND SELF-STARTING SINGLE-PHASE INDUCTION MOTOR.

capacity is more economically constructed for high than for low voltage. The starting winding can be cut out by opening the switch at *S* after the motor is up to speed. It may, however, be advantageous to keep the starting coil in circuit, if of sufficient current capacity for continuous service, because the increased power factor at light loads thus obtained more than compensates for the losses occurring in the transformer.

The use of external phase-splitting apparatus may, however, be dispensed with if the two stator windings are arranged to have different time constants. This is accomplished by having the auxiliary winding of larger self-inductance than the main coil.

* U. S. Patent Nos. 602,920 and 602,921, April 26, 1898.

Heyland devised a very successful motor of this type, utilizing the scheme suggested in the Tesla patent cited above (page 231). The working winding P is distributed in a series of semi-closed slots. The starting coils S are short-circuited upon themselves and placed in closed ducts, the result being a highly inductive secondary circuit, the general arrangement being as illustrated in Fig. 139. The current induced in the secondary winding lags almost 90 degrees with respect to the primary current, producing a field component similar to that caused by the second phase of a two-phase current. The starting torque thus produced is large, though the power factor of the machine is necessarily low, and therefore the starting coil should be cut out as soon as the machine has come up to speed.*

The rotor windings employed in connection with any or all of the preceding methods for starting may be of the standard squirrel-cage or slip-ring type.

Repulsion Motor Starting.— A very interesting type of self-starting single-phase induction motor is manufactured by the Wagner Electric Mfg. Co. of St. Louis.† This motor is provided with an armature of the ordinary direct-current drum type, having a disk commutator with radial bars. The brushes bearing upon the commutator are displaced about 45 degrees from the corresponding neutral zones and short-circuited upon each other. The stator winding is connected to the supply lines, and at starting the machine speeds up as a repulsion motor (p. 257). In the annular space between the armature core and the shaft are two governor weights w (Fig. 140), which are forced outward, further and further, by centrifugal force as the machine accelerates. When synchronous speed is nearly attained the force acting upon these weights is sufficient to push the heavy copper ring R , against the action of spring S , into contact with the inner cylindrical surface of the commutator bars G , thus completely short-circuiting the armature winding. Simultaneously with this action the sleeve P is forced to the left sufficiently to lift the brushes B from the commutator. This series of automatic actions transforms the machine from a repulsion to a single-phase induction motor, having in the latter form what is substantially a squirrel-cage armature winding.

* Electrical Engineer, Vol. XXXVI, p. 306. London, 1896.

† U. S. Patent No. 543,836, December 4, 1894.

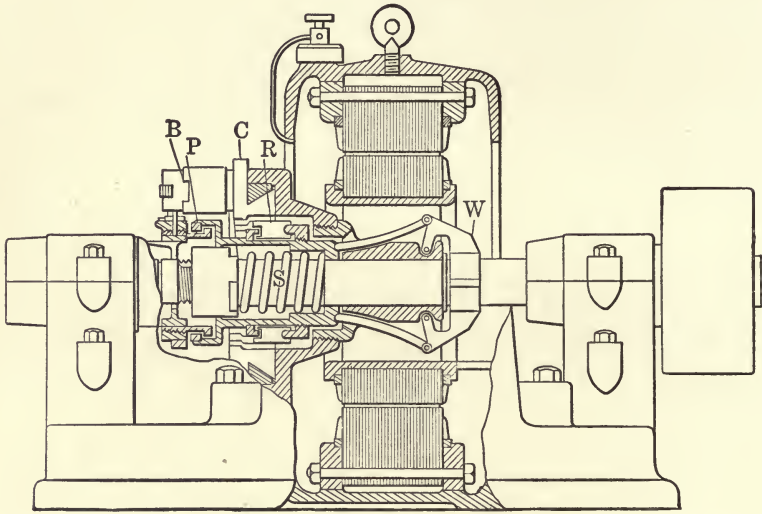

FIG. 140. — GENERAL ARRANGEMENT OF WAGNER MOTOR SHOWING AUTOMATIC SHUNT-CIRCUITING DEVICES.

The starting torque thus obtained may be readily adjusted to about twice the normal value, without an excessive current being required.

A very interesting feature of the Wagner motor, and one equally pertinent to repulsion motors, is the relation between torque and thickness of rotor brushes. The series of curves shown in Fig. 141 were determined from tests of a 5-h.p., 220-volt Wagner motor. Curve *A* shows the speed-torque relation on accelerating with normal brush thickness, this being substantially that of a commutator bar. Curve *B* represents the relations existing with a brush of twice normal thickness, etc. It is apparent from these curves that the normal thickness of brush gives the highest starting and synchronous speed torques. Further study of Fig. 141 indicates that use of a brush thinner than normal might tend to produce starting and synchronous speed torques of greater value than occur with normal brush thickness. Practical questions, however, as regards mechanical strength limit the reduction of brush thickness.

Single-phase induction motors, in addition to being provided with one or another of the preceding means for developing starting torque, require, when over moderate size (3 or 5 h.p.)

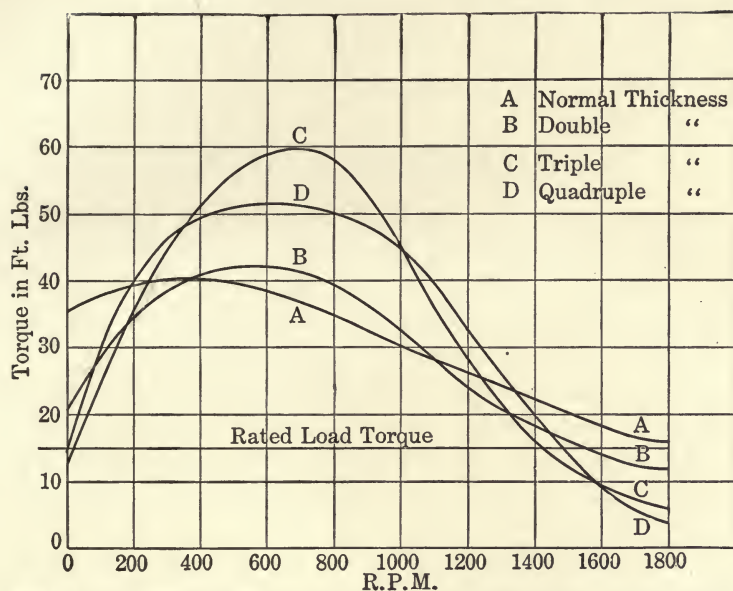

FIG. 141. — SPEED-TORQUE CURVES WITH VARIOUS BRUSH THICKNESSES.

the introduction of starting compensators (p. 195), or use of wound rotors with slip-ring control (p. 199). This precaution is necessary, as the inrush current otherwise occurring would be considerable and likely to react upon the line, producing voltage fluctuations.

For further information on single-phase induction motors, the reader is referred to the following:

ALTERNATING-CURRENT MOTORS. A. S. McAllister. New York, 1909.

SINGLE-PHASE INDUCTION MOTOR. A. Still. *Elect. World*, New York, 1906. Vol. XLIII, pp. 1108, 1152, 1182, 1202.

SINGLE-PHASE INDUCTION MOTORS. Dr. C. P. Steinmetz. *Trans. A. I. E. E.*, Vol. XV, 1898, pp. 35-110.

SINGLE-PHASE INDUCTION MOTORS. W. S. Franklin. *Trans. A. I. E. E.*, Vol. XXIII, 1904, p. 429.

THEORY OF SINGLE-PHASE INDUCTION MOTOR. V. A. Finn. *Elect. Rev.*, London, February, 1906.

WECHSELSTROMTECHNIK. Vol. V, by Arnold and La Cour, pp. 112 and 275. Berlin, 1909.

CHAPTER XVIII.

COMMUTATING ALTERNATING-CURRENT MOTORS.

COMMUTATING alternating-current motors are those having a closed-coil armature provided with a commutator, being similar to d.c. motors in general construction. Fundamentally there are three such types, namely, *shunt*, *series*, and *repulsion* motors, but many modifications and combinations have been devised, the more important of which will be considered later. The general historical facts concerning these and other a.c. motors have already been given in Chapter XII.

Alternating Current Shunt Motor. — Owing to the fact that the direction of rotation of any d.c. motor is the same irrespective of the direction of current supply, early attempts were made to adapt such machines for service on alternating-current systems. Of course these motors must be provided with laminated field frames to reduce the great losses due to eddy currents that would otherwise occur. The simple shunt motor of this type is not, however, of any commercial value, for the following reasons:

1. Low power factor, due to the many turns of the field winding, the inductance of which is extremely large.
2. Severe sparking at the brushes, due to the fact that as each coil passes under a brush it becomes a short-circuited secondary of a transformer, and thus a seat of heavy currents.
3. Low weight efficiency. This trouble is caused by the phase difference between armature and field currents and corresponding relation between their respective fluxes, resulting in greatly reduced torque.

The inductance of the armature is small with respect to that of the shunt-field circuit, hence, the two currents differ considerably in phase. Let the vector OB (Fig. 142) represent the current in the armature circuit and θ_1 its small angle of lag with respect to the line e.m.f. OA , while AC represents the field current and θ_2 its large angle of lag; then $\phi = \theta_2 - \theta_1$ is the angular difference between OC

and AB , the field and armature currents (also fluxes), respectively. The relation between these currents is also shown in the wave diagram of Fig. 142. The torque at any moment is $t = KI_a \sin \theta_1 I_f \sin \theta_2$, which by reduction gives $T = KI_a I_f \cos \phi$ as the effective value. In other words, the torque developed by an a.c. shunt motor is

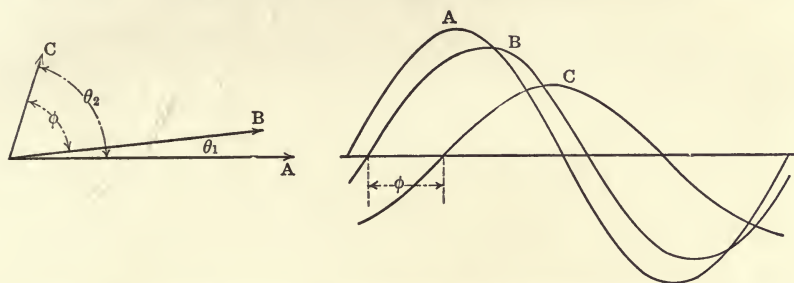

FIG. 142. — VECTOR AND WAVE DIAGRAMS OF E.M.F. AND CURRENT OF A.C. SHUNT MOTOR.

dependent not only upon the field and armature currents, but also upon the cosine of the angle between them.

If the currents were in phase $\cos \phi$ would be unity and the torque of the a.c. shunt motor would be equivalent to that of the d.c. machine. Economy of design and efficiency of operation demand a shunt-field winding of many turns and an armature winding of comparatively few turns, so that ϕ , which is the phase difference between field and armature currents, will always be large. Hence, as already stated, the torque and power per unit of weight of such an a.c. shunt motor are necessarily small.

The a.c. shunt motor may be used with greatly increased weight efficiency on two-phase circuits, by supplying the field winding from the leading phase, and the armature from the lagging phase. The lag of field current would bring it very closely in phase with the armature current; thus ϕ would be small and the torque correspondingly increased with the same values of I_a and I_f . Another advantage of this scheme is that adjustable voltage speed control becomes available through the simple introducing of a variable ratio auto-transformer in armature circuit. This modification of the shunt motor, however, has not been adopted to any extent in practice, because induction motors on account of their higher power factor and better balanced condition would naturally be used when two-phase currents are available.

The Alternating-current Series Motor. — The powerful starting torque and adaptation of speed to load characteristics of the d.c. series motor make this type particularly suitable for traction and many other uses requiring such qualities. The limitations of direct current generation and transmission, as well as special advantages of a.c. voltage control, have made the development of a corresponding a.c. motor very desirable, a fact appreciated for many years.*

Synchronous motors, whether single or polyphase, and single-phase induction motors, all having little or no starting torque, are obviously unsuited to railway and many other purposes. Poly-phase induction motors require at least three supply conductors and are for that reason less desirable than single-phase apparatus, especially for traction. Hence a single-phase motor with a powerful starting torque has an enormous field of usefulness. Up to the present time the series and repulsion motors both with commutators are the only a.c. types fulfilling this condition.

The operation of series motors on the high frequency circuits formerly employed (100 to 133 p.p.s.) was attempted at various times, but not with success, except in the case of very small machines. This failure was due to excessive transformer action in the coils of the armature winding, short-circuited during commutation, as well as to the low power factor caused by the large reactance of the field windings.

The introduction and use of low frequency (25 p.p.s.) systems for power transmission is the basis for the later commercial development of the a.c. series motor. In 1902, Mr. G. B. Lamme, of the Westinghouse Elect. & Mfg. Co., called attention to an a.c. series motor which operated on circuits having a frequency of $16\frac{2}{3}$ p.p.s.† This motor had a powerful starting torque, high power factor, and was of relatively high efficiency, but the low frequency necessary for its proper operation unsuited it for service on circuits of standard frequency. Furthermore, illumination by arc or incandescent lamps at $16\frac{2}{3}$ cycles is not satisfactory. The design has since then been modified to adapt this type of motor to the standard frequency of 25 p.p.s.

The same current flows through both field and armature windings of an a.c. as well as d.c. series motor, hence there can be no phase

* Alex. Siemens, *Journal British Inst. of Elect. Engs.*, p. 527, Vol. XIII, 1884.

† *Transactions A. I. E. E.*, pp. 10-49, Vol. XX, 1902.

difference between field and armature currents. In this respect it differs from the a.c. shunt motor whose torque depends not only upon field and armature currents but also upon the cosine of the phase angle between them, as already explained. There are, however, other limitations of the a.c. series motor and special features of design are found necessary by reason of the following phenomena, *peculiar to a.c. machines*:

1. *Iron losses* throughout the magnetic circuit, due to alternations of the flux.

2. An e.m.f. generated in the armature windings by the alternating magnetic field, and defined as a *transformer e.m.f.* in contradistinction to the voltage developed by armature rotation.

3. A *local current* circulating in those coils short-circuited by the brushes. This current is due to the transformer e.m.f. of No. 2.

4. An *e.m.f. of self-induction* in the field and armature windings.

5. *Power factor less than unity*, due to inductance of the windings.

1. *Iron Losses.* The total iron losses occurring in the a.c. series motor may be divided into two parts: that taking place in the armature coil and polar faces due to the rotation of the former, and that occurring in the entire magnetic circuit, due to the alternations of the magnetic flux. The losses arising from rotation of the armature coil, being common to both a.c. and d.c. motors, are often called "d.c. iron losses." These are supplied mechanically and act like the resisting torque of friction. The losses caused by flux alternation are supplied electrically and are due to eddy currents and hysteresis, the former being reduced to a reasonable amount by employing laminated field magnets as well as a laminated armature coil. A reduction in hysteresis loss is possible by operating at low flux densities. Hence in the case of a series motor designed for a.c. service a wholly laminated magnetic circuit is necessary. This feature, combined with the limitation of flux densities, results in a total weight 30 to 50 per cent greater than that of a corresponding d.c. machine. The overall dimensions are also proportionately larger.

2. *Transformer e.m.f.* In addition to the c.e.m.f. of rotation a second e.m.f. is generated in the armature winding, which does not, however, appear at the brushes, except locally as a cause of sparking, explained in 3. The rate of cutting lines of force due to armature

rotation is a maximum at the position of coils *A* and *B*, Fig. 143, while the minimum rate of cutting occurs while the coils are in the so-called "neutral" position, *CD*. The e.m.f. generated by the armature rotation tends to cause current flow from coil *D* upwards through each half of the armature winding to the coil *C*, producing poles at *C* and *D*. The second or transformer e.m.f. is produced by the alternations of flux passing through the armature coil. For example, in the case of a ring wound armature placed in a bipolar

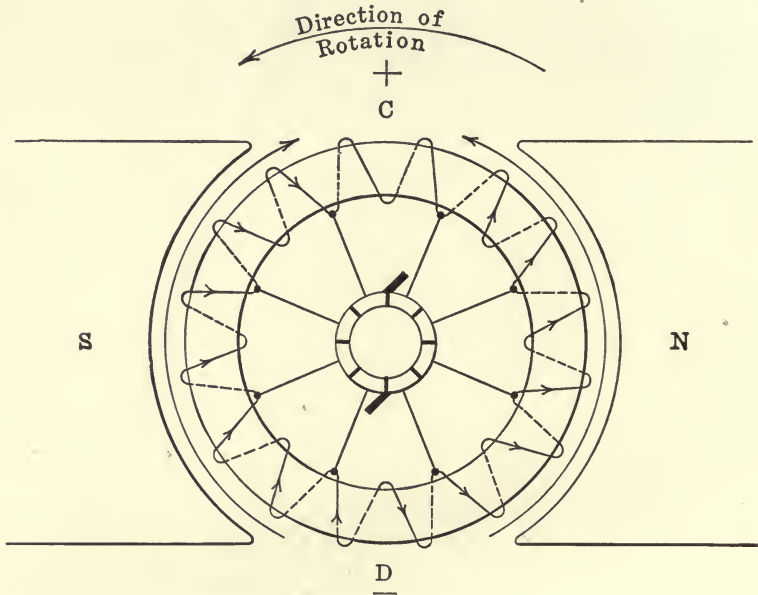

FIG. 143.—ARMATURE OF SERIES MOTOR SHOWING DIRECTION OF C.E.M.F.

field, one-half of the total flux passes through the sections at *C* and *D* respectively, hence maximum flux variation occurs there. On the contrary, no lines of force pass through coils *A* and *B*, so that no transformer action occurs and no e.m.f. is induced in them. This transformer e.m.f. produces no difference of potential at the brushes placed vertically in their usual position as indicated, because the portions of the armature winding in connection with them are of equal potential, the transformer e.m.f. being shown by heavy arrows (Fig. 144). It is evident that this e.m.f. does not act against the flow of current from the supply lines and produces no effect, except that the particular coils short-circuited by the brushes

experience maximum transformer induction, which tends to set up large currents in them, as already explained under heading 3.

The value of this transformer e.m.f. in the armature is

$$E = \frac{4.44 f \Phi_m S}{10^8}, \tag{64}$$

this being the well-known expression for transformer e.m.f. in which f is the frequency, Φ_m the maximum armature flux due to the field m.m.f., and S the *equivalent* number of armature turns. If the total number of armature conductors, counting all around the per-

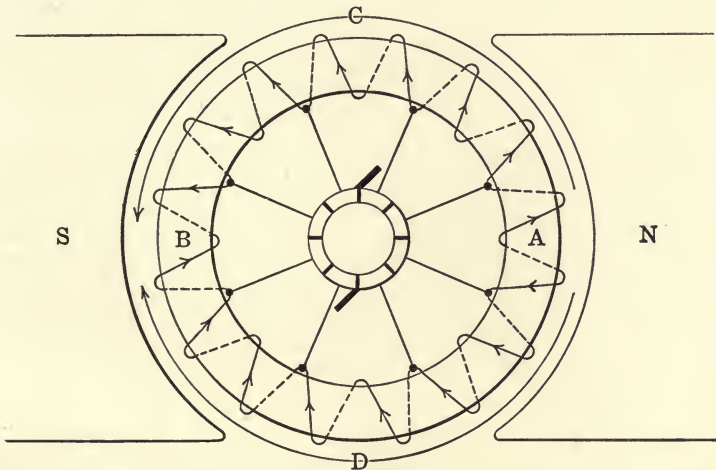

FIG. 144. — DIRECTION OF TRANSFORMER E.M.F. INDUCED IN ARMATURE WINDING BY AN A.C. FIELD.

iphery, is S_a , the turns in *series* are $S_a \div 2$ on the bipolar ring armature in Fig. 144, which is simpler than a drum winding to represent and study. As already stated, the field flux linked with each turn of armature winding depends upon its position, being proportional to the cosine of its angular displacement from the line CD . The average value of the cosine in each quadrant is $\frac{2}{\pi}$, and each turn in a ring armature carries only one-half of the flux, hence the effect of S_a total conductors is equivalent to

$$S = \frac{S_a}{2} \cdot \frac{2}{2\pi} = \frac{S_a}{2\pi}.$$

Substituting this value of S in equa. 64, the transformer e.m.f. induced in the armature winding by the alternating field flux, and lagging one-quarter period or 90 degrees with respect to it, is

$$E = \frac{.707 f \Phi_m S_a}{10^8}. \quad (65)$$

This same formula applies equally well to a drum armature, in which case the turns are only one-half as many as the total conductors, but the flux is not divided between two turns as in a ring winding. Hence these two factors would cancel out if introduced in equation.

3. *Local Armature Current.* Since those coils undergoing commutation are the seat of maximum transformer action, a large current will flow in them as in any short-circuited secondary. The flux due to this secondary current being in opposition to the primary flux tends to weaken the field just when and where its greatest strength is required for commutation. This local current may be greatly in excess (5 to 15 times) of the normal armature current, thus producing local heating as well as an additional current and I^2R loss in the primary (*i.e.*, field) winding.* The sudden interruption of the heavy current in the short-circuited coil also draws a large spark at the brushes and causes commutator troubles. Since the transformer e.m.f. and current depend upon the *frequency of flux alternations, the number of turns in, and resistance of, each short-circuited coil*, they can be reduced by proper modification of these three factors. That is, frequency of the supply circuit should be as low as possible, consistent with standard practice, and the number of turns of wire or inductors in series between consecutive commutator bars should be small, the transformer e.m.f. being directly proportional to these two factors. This latter condition increases the number of armature sections as well as commutator bars, and therefore cost of construction, but greatly diminishes the tendency to spark, self-induction being proportional to the square of the number of turns of wire. The e.m.f. is reduced, as just shown, while the resistance of the coil circuit is increased by employing brushes of higher contact resistance than is usual with d.c. machines, or by inserting high resistance connectors or preventive leads (P) of German silver between the armature sections and the commutator bars (Fig. 145). The high resistance of the special

* Electric Journal, p. 7, Vol. VI, 1909.

brush contacts or of the preventive leads is only a small factor of the resistance of the whole armature winding; consequently it does not lower the efficiency of the machine to any marked extent. The additional resistance of the preventive leads is, however, a considerable

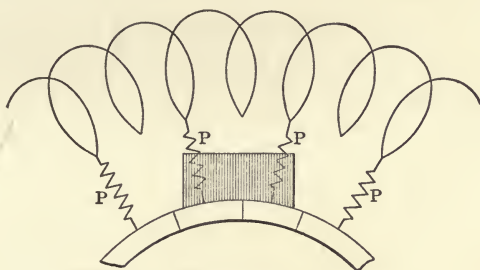

FIG. 145.—PREVENTIVE LEADS.

factor of the local circuit, hence it is very effective in cutting down the value of the local or short-circuit current.

4. *E.M.F. of Self-induction* occurring in both field and armature windings. This e.m.f. is due to the alternating flux, and introduces a factor not existing in the d.c. motor, that is, in addition to the c.e.m.f. of rotation, the impressed voltage must overcome an e.m.f. of self-induction equal to ωLI . To cause an equal current to flow, with other conditions the same, the applied e.m.f. must therefore be greater than in the d.c. machine. As a matter of fact, the actual voltage supplied to the terminals of an a.c. series railway motor is usually lower than for the d.c., being about 250 compared with about 550 volts, hence the e.m.f. of rotation must be relatively still lower in the former machine. In other words, the a.c. machine is designed for a lower voltage. Another difficulty due to this inductive e.m.f. arises when one or more field turns become short-circuited, forming a closed secondary circuit and drawing excessive current, very likely to result in a burned out field winding. The transformer e.m.f. set up in the armature of a bipolar machine, as given in equa. 65, is equal to the full c.e.m.f. developed by rotation when the line frequency equals motor r.p.m. $\div 60$, which relation corresponds to synchronous speed. This is evident because the armature turns cut the flux at the same rate in both cases. Hence the effect of a short circuit in the armature is aggravated in the series a.c. motor.

5. *Power Factor.* Since the field winding is highly inductive, and the armature winding may have considerable inductance, the current flowing through them is not in phase with the line e.m.f. This condition does not affect the torque of the motor, but the resulting low power factor impairs the regulation of the alternators, transformers and line, at the same time lowering the efficiency of the entire system. This e.m.f. of self-induction in the field winding is directly proportional to the frequency of the supply voltage, to the field flux and to the square of the number of its turns, hence in any attempt to improve the power factor of the motor, these various factors must all be considered.

a. The frequency cannot be lowered indefinitely, since the motor must operate on existing circuits, few of which have a frequency of less than 25 p.p.s. Many engineers are agitating the use of 15-cycle circuits for series motors, hoping in this way to improve the power factor, and while that result undoubtedly would be thus obtained, the greater cost of the alternators and transformers might readily offset this gain.

b. Total Flux. By increasing the number of inductors and at the same time the number of sections on the armature, the field flux can be reduced and the torque maintained constant. That is, the armature is made strong with respect to the field, so that the field inductance can be decreased. Hence in practice the total flux of the a.c. series motor at corresponding current values is not as high as in the d.c. machine. The increase in armature inductance is eliminated by "compensation," as explained later.

c. Turns in the Field Coil. These can be kept down, first, by having steel of high permeability, and secondly by having a somewhat shorter air gap, thus obtaining the necessary flux with a smaller number of ampere-turns. In fact, the lower value of flux indicated above (*b*) tends to reduce the number of field turns required.

It has been suggested that the power factor of the series motor could be improved by increasing its resistance or decreasing the ratio $\omega L \div R$. This short-sighted improvement in power factor would merely result in an increased I^2R loss with lowered efficiency and horsepower capacity.

The electrical action in a plain a.c. series motor can be readily shown by vector diagram, as in Fig. 146. In the field we have a large inductance reaction OY and a small resistance reaction YR ,

the resulting voltage across the field terminals being OR . The inductance drop RJ in the armature is relatively small, and not very much greater than its resistance drop JD . The vector RD represents the voltage required to overcome the impedance reaction of the armature winding, and OD measures the voltage balancing the

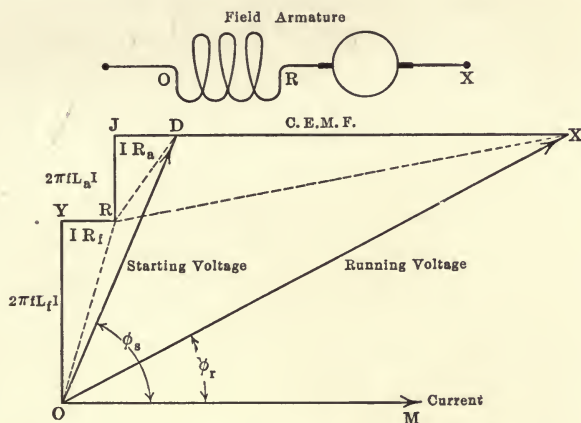

FIG. 146. — VOLTAGE DIAGRAM OF SERIES MOTOR.

joint impedance reaction of armature and field windings. This is also the starting voltage of the motor, since this reaction represented by OD is all that exists with the motor at rest.

A c.e.m.f. is developed in the armature winding, when it is rotated in the magnetic field. This c.e.m.f. or *rotative e.m.f.* is vectorially represented as an energy component, since it is proportional to the power required to overcome the rotative iron losses and counter torque of the load. If, as before with a bipolar model, S_a be the total number of inductors around the armature core, and Φ_m the maximum value of the field flux, the value of the *rotative e.m.f.* is expressed by

$$E_{rot} = \frac{.707 \Phi_m \text{ r.p.m. } S_a}{60 \times 10^8}. \quad (66)$$

The line DX , parallel to the base line in Fig. 146, represents the above c.e.m.f. and OX corresponds to the applied voltage, producing rotation against the counter torque. The value of this applied voltage is

$$V = \sqrt{(E_{rot} + IR_m)^2 + (E_f + E_a)^2}. \quad (67)$$

In the case of a completely compensated series motor the value E_a becomes negligible because the armature inductive e.m.f. is neutralized, as explained later. The ohmic drop IR corresponds to the summation of the lines YR and JD , which vary directly with the current I and total resistance R . E_f and E_a , the inductive drops or reactance voltages of the field and armature windings respectively, are represented by the lines OY and JD . These vary directly with the current I so long as the flux density is low, under which condition the motor torque increases as the square of current which flows in both armature and field. The counter e.m.f. (DX) rises directly with speed and current, at moderate flux densities, hence it does not change greatly with constant impressed voltage OX , because the speed diminishes as current is increased. The phase relation existing between the impressed voltage OX and the current I varies with the motor load, the power factor decreasing as the torque is augmented, a fact borne out by the working curves of the series motor in Fig. 148. Still further study of this voltage diagram (Fig. 146) brings out the fact that the *starting* voltage of the a.c. motor is nearly one-half of the impressed *running* voltage, while with d.c. machines the starting voltage is small, not exceeding one-eighth of the line potential. Under the same conditions of field and armature resistance and low current, the latter would be only the sum of the energy components YR and JD , because the inductive e.m.f.'s OY and RJ are absent. Another fact indicated by the vector diagram is the low power factor of the motor at starting, being the lowest value over the entire load range; this is so because the inductive component is about the same as when the motor is loaded, while the energy component is very much smaller.

The curves representing the performance of a.c. series motors can be approximately determined by means of a circle diagram. This method presupposes constant permeability of the magnetic circuit, and hence unvarying reactance of the motor windings, even though the load current be considerably varied. This condition maintains only approximately in practice, consequently results obtained from the circle diagram are not rigorously correct; nevertheless, the speed and power factor values derived therefrom agree very closely with test results. The main difficulty with this method is the fact that the torque values thus obtained are founded upon the assumption that the motor torque varies as the square of the

current, whereas, in fact, this relation exists only for the *total torque* developed and with the magnetic circuit operated well below saturation. An approximation which gives the *effective* torque at different current values with reasonable accuracy will be given later.

The circle diagram is directly developed from the vectorial voltage relations shown in Fig. 146, because if the impedance of the motor windings is constant and the impressed voltage of fixed value, the variations of current and power factor are such that the extremity of the current vector moves in the arc of a circle.

Construction of Circle Diagram. — Lay off the line OX , representing the vector position of the line voltage (Fig. 147), then at an angle ϕ_s lay off to scale the short-circuit current OS . This short circuit current is taken at full line voltage, and its phase angle $\cos^{-1} \frac{\text{watt meter reading}}{\text{volts} \times \text{amperes}} = \phi_s$. Next apply a brake to motor shaft or driving wheel and allow the armature to rotate, adjust the brake so that the machine draws a certain current, say about one-third of the short-circuit value, note volts, amperes, watts input, speed and torque, calculate speed in miles per hour, tractive effort, horsepower output, and efficiency at this selected load. Lay off this last current OI to scale and in its determined phase position with respect to line voltage. The locus of the current drawn by the motor under different loadings at a fixed voltage and frequency is then the arc of a circle drawn through the points O , I , and S . The power factor of any current can be determined by projecting the intersection of its vector with the circle KNC across to the power factor scale upon OX . The speed corresponding to any load current OI , for example, is also determinable from the circle diagram, as follows: Draw a line through S parallel to OX , then continue the current vector OI until it intersects this line at P ; the distance between points S and P is proportional to the motor speed existing when the current is OI at voltage OX . This relation is true by construction, because OI is at constant impedance proportional to the impedance drop and OS to the line voltage; consequently IS is proportional to the c.e.m.f. due to rotation and therefore to speed of rotation itself. Comparing the triangles OIS and OSP , it is seen that they are similar because the three included angles of one are equal to those of the other; accordingly SP is proportional to IS , or to the motor speed as above stated. If line SP

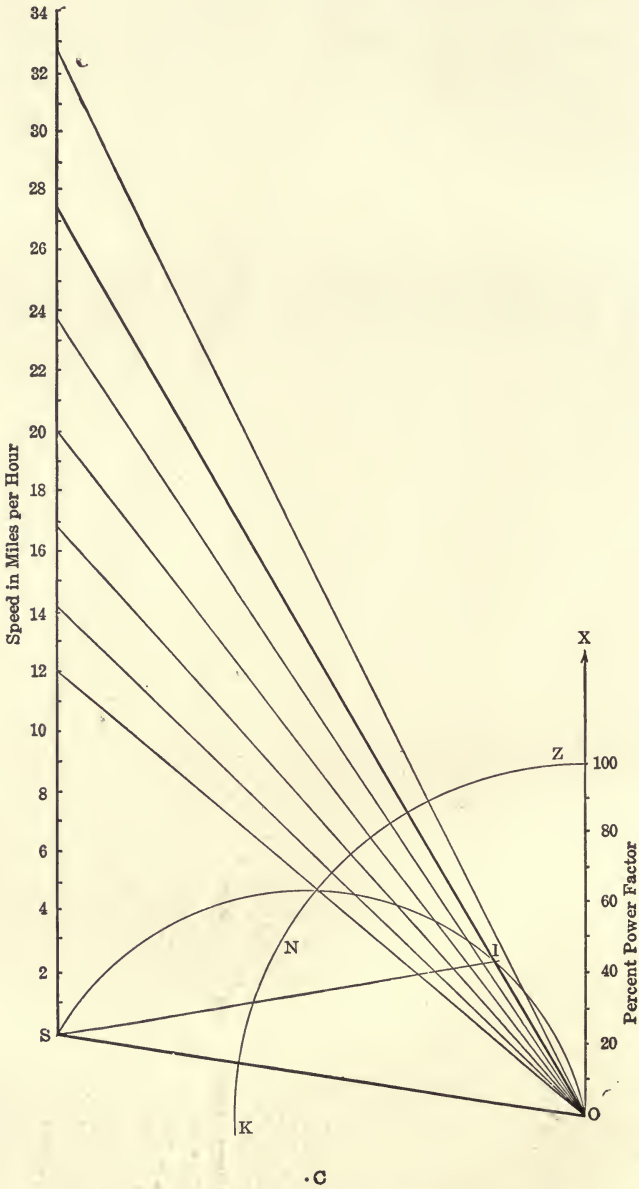

FIG. 147. — CIRCLE DIAGRAM FOR A.C. SERIES MOTOR.

be divided to scale, the speed at any assumed current can be read off directly by continuing its vector to intersect *SP* or its prolongation. The torque of the motor can be calculated with an error not exceeding a few per cent, by the relation $T = k\Phi I$. Relative values of the field flux Φ existing at different current values are determined from the e.m.f. of rotation, which in the circle diagram is

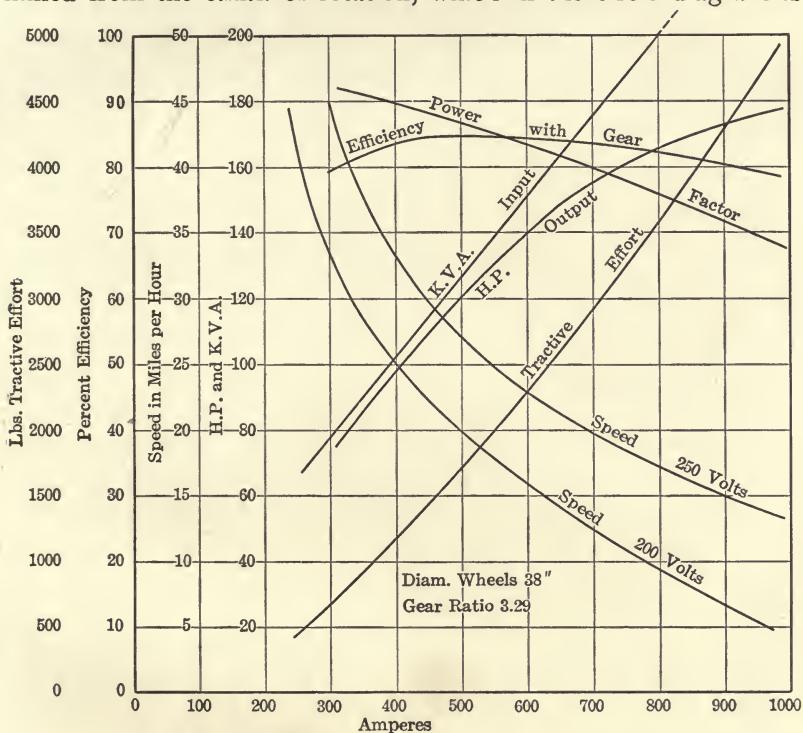

FIG. 148. — CHARACTERISTIC CURVES 25-CYCLE, 250-VOLT, 150-H.P. SERIES MOTOR.

proportional to the line *IS* for the current *OI*, and for any other current proportional to the corresponding line. Naturally, to obtain the true ratio existing between the different rotational e.m.f.'s and therefore between corresponding values of field flux, these e.m.f.'s must be reduced to a common speed basis. The torque T_1 with any current I_1 is then determined from that exerted with the test current I flowing, by the relation:

$$T_1 = T(\Phi_1 I_1 \div \Phi I). \tag{68}$$

The results obtained from the circle diagram in Fig. 147 are compared in the following table, with values taken from test curves

of Fig. 148. These characteristic curves are for a 150-horsepower, 250-volt, 25-cycle compensated-series motor.

COMPARISON OF RESULTS OBTAINED BY TEST AND FROM CIRCLE DIAGRAM.

150-h.p., 25-cycle, 250-volt Compensated Series Motor.

Amperes.	Power Factor.		Speed in M.p.h.		K. V. A.	H.P. Input.	
	Test.	Diagram.	Test.	Diagram.	Input.	Test.	Diagram.
400	.90	.90	33.5	32.7	100	121	121
500	.86	.86	27.5	27.5	125	144	144
600	.83	.83	23.2	23.4	150	167	167
700	.79	.80	20.0	20.0	175	188	188
800	.75	.75	17.5	17.0	200	201	201
900	.71	.70	15.2	14.5	225	214	212.
1000	.67	.66	13.2	12.2	250	224	221.

Amps.	Rotational C.E.M.F.		Torque Ratio $\frac{\Phi_1 I_1}{\Phi I}$	Pounds, Tractive Effort.		Horsepower Output.		Per cent Efficiency.	
	Diag.	At Common Speed.		Test.	Diag.	Test.	Diag.	Test.	Diag.
	Volts.	Volts.							
400	216	181	.70	1175	1210	108	105	89.4	89
500	207	207	1.00	1750	1750	128	128	89	89
600	195	227	1.32	2300	2300	142	143	85	85
700	182	250	1.71	2975	3000	150	158	84.5	85
800	167	273	2.14	3650	3740	170	170	84.5	84.5
900	153	290	2.52	4300	4410	175	172	81.6	82
1000	138	313	3.02	5050	5300	178	174	78	78

The agreement between test and calculated results is reasonably close. The differences existing may be charged to two facts, namely, the basic assumption in the construction of the diagram that the winding impedance remains constant, which is not strictly true, and again to the difficulty of making very close linear measurements in a small diagram.

An examination of the working curves (Fig. 148) of the a.c. series motor indicates that the speed- and torque-current characteristics are very similar to those of the corresponding d.c. machine, but owing to the lower flux densities of the former, the torque increases more nearly as the square of the current throughout the load range.

For the same reason its speed does not tend to become so nearly constant at heavier loads. The motor speed at fractional voltages can be determined from the circle diagram, or by the relation existing between the rotational e.m.f.'s.

$$E_{rot}^2 = E_{line}^2 + I^2 Z^2 - 2 E_{line} I Z \cos(\phi_s - \phi). \quad (69)$$

In this expression I is the armature current at which the value of E_{rot} is desired; Z the impedance of the windings, ϕ_s the phase angle of the short-circuit current, ϕ the phase angle of the current I , and E_{line} is the value of the line voltage at which the speed is to be calculated.

The losses in an a.c. series motor may be divided into two classes, namely, those which also occur in d.c. machines, and those peculiar to machines having magnetic fields set up by alternating currents. Since these latter motors operate at a lower voltage than the corresponding d.c. machines, the current required for a given power is greater, hence the copper losses will be more, or the amount of copper required in the windings will be larger. As a matter of fact, the total losses in an a.c. series motor are about twice those occurring in a corresponding d.c. motor. The various losses of the a.c. motor may be conveniently arranged as shown in the following chart.*

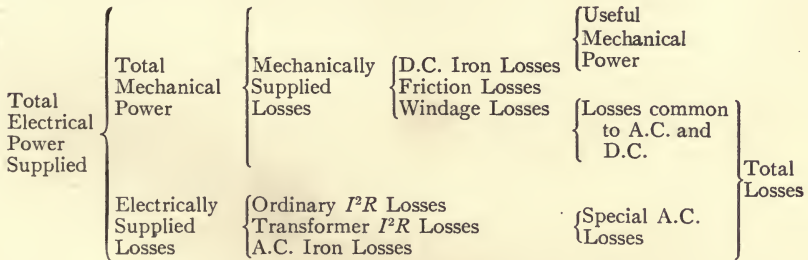

Compensation of Armature Reaction and Inductance. — It has already been shown (p. 246) that to improve the power factor of an a.c. series motor, the practice is to weaken the field and strengthen the armature by decreasing the turns of the former and increasing those of the latter. This change in design tends, however, to exaggerate armature reaction as well as commutation difficulties. These two troubles can to a very marked extent be reduced or even eliminated by the introduction of a *compensating* m.m.f. in substantially

* Electric Club Journal. Vol. I, 1904, p. 16.

the same manner as employed in the case of d.c. adjustable speed shunt motors of the Thompson-Ryan design pp. 49, 55. This method of preventing the field distortion by the armature m.m.f. and reducing the armature inductance is to surround the revolving armature with a fixed winding placed in slots cut in the polar faces if salient

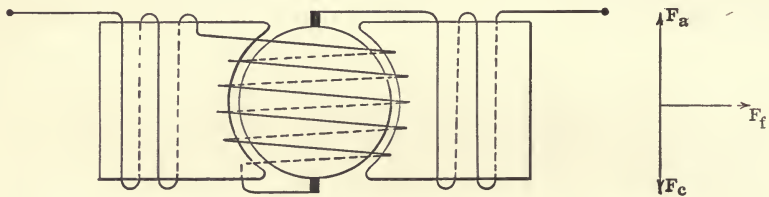

FIG. 149. — SERIES MOTOR WITH COMPENSATING WINDING (CONDUCTIVE COMPENSATION).

poles are employed, or if an induction motor stator frame is used the compensating winding is displaced 90 magnetic degrees or half a pole pitch from the field winding. The compensating coils carry a current equal in m.m.f. and opposite in phase to the current in the armature, and this current may be obtained either *conductively* by connecting the balancing winding directly in series with the field

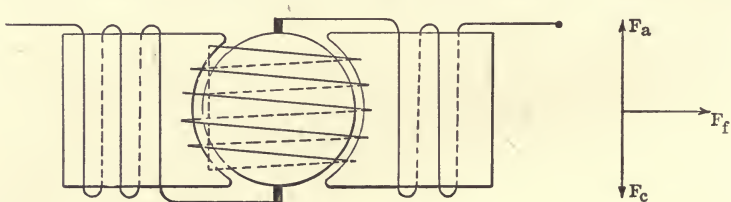

FIG. 150. — SERIES MOTOR WITH COMPENSATING TRANSFORMER (INDUCTIVE COMPENSATION).

and armature windings, as in Fig. 149, or *inductively* by using the stationary winding as the short-circuited secondary of a transformer, of which the armature is the primary, as in Fig. 150. It is found that the best effects are produced when the balancing of the armature reaction is complete. The conductive method is the more desirable when the motor is to be operated on *mixed* service, that is, partly on a.c. circuits and partly on d.c. circuits.

Methods of Control of A.C. Series Motors. — The series motor may be controlled by means of a rheostat in series with it, an auto-transformer or an induction regulator. With external resistance

the efficiency of the system is low, as in the case of rheostatic control with d.c. machines. When the auto-transformer is employed, the line is bridged by a single coil transformer provided with taps, so that various voltages can be applied to the motor circuit, and low voltages for starting can be obtained without the

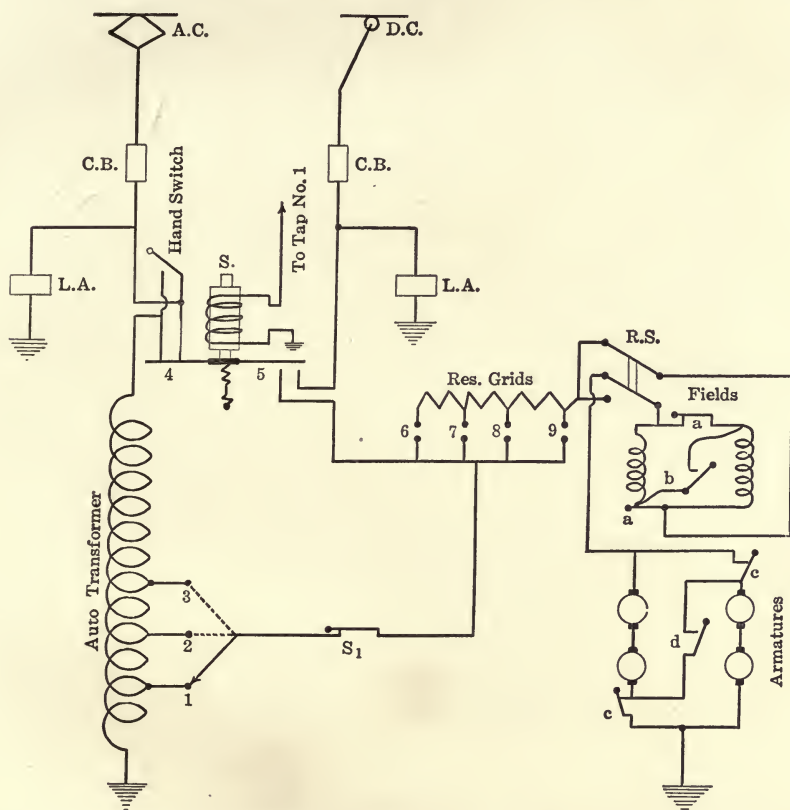

FIG. 151. — CONNECTIONS FOR OPERATING SERIES MOTOR ON MIXED SERVICE.

large losses involved in resistance control. The speeding up of the motor is accomplished by including more and more sections of the auto-transformer between the motor terminals.

The trolley voltage usually employed in a.c. traction work is 11,000 volts or thereabouts, while the motors are designed to operate at 250 volts or less. The line from the trolley to the ground passes through an auto-transformer designed with taps so as to give an adjustable secondary pressure up to 500 volts, sufficient to

operate two motors in series. The general scheme of connecting a.c. series motors, with auto-transformer control, for traction service is shown in Fig. 151. Since these motors are rated at 250 volts each, they are connected in series-parallel groups, two motors being permanently connected in series so as to fit them also for d.c. operation. The switch *S*, automatically operated, cuts out the auto-transformer when the alternating current fails, and inserts the rheostatic or series-parallel control of the two groups necessary for d. c. service. Switches *aa* and *cc* are open, while *b* and *d* are closed for series connection of motors — the converse is the order for parallel service. The switch *RS* reverses the current in the field coils and thus the direction of rotation. The auto-transformer method of controlling the speed of a.c. series motors corresponds to the multiple voltage (p. 74) and motor-generator systems for d.c. motors, because they all supply an adjustable voltage corresponding to the speed desired. The a.c. means are much simpler, however; in fact the facility of transforming voltage is the great advantage of the a. c. control.

The Repulsion Motor. — As stated in Chapter XII, the physical phenomenon upon which the operation of this motor largely depends

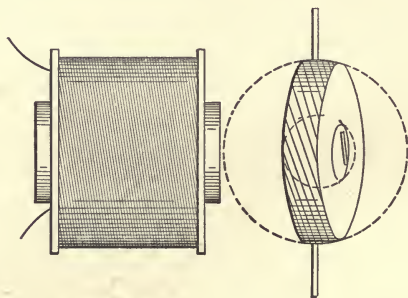

FIG. 152. — REPULSION OF SINGLE COIL.

was discovered by Prof. Elihu Thomson in 1887, and he applied it the same year to the development of an experimental motor.* The production of the repulsion phenomenon is as follows: If a closed coil of wire be suspended or pivoted near the pole of an alternating current magnet in such a manner that lines of force from the latter pass through the former as represented in Fig. 152, an alternating e.m.f. will be induced in the coil. This secondary e.m.f. will be 90 degrees later in phase than the inducing flux, and

* Transactions A. I. E. E., Vol. IV, 1887, p. 160. * U. S. Patent No. 263,185 of 1887.

if the coil contains no inductance, the secondary current will also be in quadrature with the primary flux. Under such conditions there will be no development of torque by the mutual action of the magnetic field and current as explained on page 239. Practically, however, every coil of wire contains some inductance, so that the secondary current lags more or less with respect to the secondary e.m.f., being therefore more than 90 degrees later than the primary flux, with the result that the cosine of this phase relation becomes a *negative* quantity. This means that the coil is *repelled* by the field. The maximum repulsion occurs theoretically if primary flux and secondary current differ in phase by 180 degrees, but even to approximate this value requires the coil reactance (ωL) to be very large with respect to its resistance. This condition implies an extremely small current, so practically the maximum repulsion occurs when the coil has such impedance that the secondary current lags about 45 degrees with respect to the e.m.f.

If the movable coil above considered be pivoted in the magnetic field, the only way in which the negative torque or repulsion can act is by turning this coil on its axis, until such position is reached that no lines of force pass through it, or in other words, it will turn until it assumes a position parallel to the lines of force. A coil perpendicular to the flux may rotate in either direction, hence it must be placed obliquely with respect to the flux, to compel rotation in a definite direction, and if the inertia of the coil be sufficient to carry it beyond the dead center, continuous motion will be developed.

The elementary repulsion motor devised by Professor Thomson is diagrammatically illustrated in Fig. 153. The magnetic circuit was completely laminated and the armature winding was of the open coil type, the terminals of each coil being connected to diametrically opposite commutator bars. The field winding was connected directly across the line, and the armature short-circuited by means of diametrically opposite brushes connected by a copper lead. With these brushes placed so that they short-circuit the armature coils at an oblique angle to the flux direction, torque and rotation are set up as for the single coil already considered and are continued through the successive action of the different coils. The limitation of this early type of repulsion motor is the fact that the effective torque developed at any moment is due only to a single armature coil, since no current exists in the others whose circuits

are open. Hence to develop any considerable power, the current in the short-circuited coil must necessarily be high, and the opening of this circuit as the corresponding commutator bars pass out of contact with the brushes causes excessive sparking. Professors

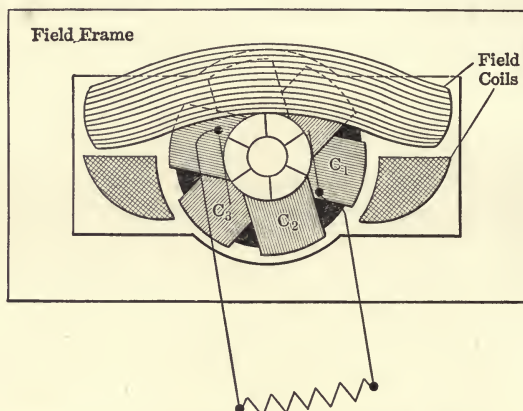

FIG. 153. EARLY THOMSON REPULSION MOTOR.

Anthony, Ryan and Jackson appreciated the seriousness of this defect, and in 1888 suggested the use of a closed coil armature winding in place of the open coil type.* This resulted in a greatly increased power for a given weight, because the effective turns on the armature were augmented and a given current produced more torque, or a smaller current produced the same torque without as much sparking. On the other hand, sparking with this type of armature is due not only to reversal of current in the coil short-circuited by the brush, as in d.c. machines, but also to transformer action, as already explained with reference to the series a.c. motor (p. 242).

Sparking in the brushes in the more modern designs is reduced by compensation, as in the series motor; by use of a distributed field winding; high brush contact resistance; prevention leads, etc. With the simple form of repulsion motor indicated in Fig. 154, the field winding is directly across the line and there is no electrical connection between the armature and field or supply circuit, resembling in this respect the transformer with a leaky magnetic circuit and movable secondary winding.

* Trans. A. I. E. E., Vol. XXIII, 1904, p. 77.

* U. S. Patent 389,352, September, 1888.

The flux impressed on the armature core by the field, and represented in Fig. 155 by the vector OR , may be resolved into two components, the first being OB along the line of commutation of the armature winding and the second OA perpendicular thereto.

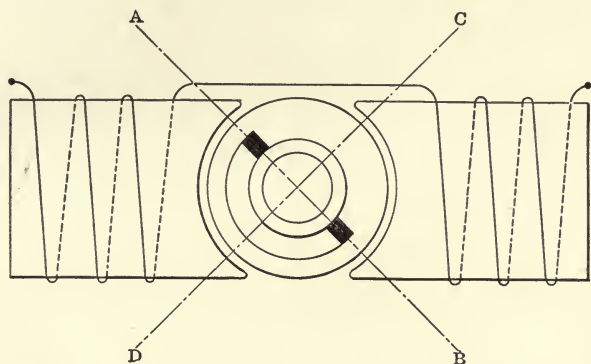

FIG. 154.—CONNECTIONS OF SIMPLE REPULSION MOTOR.

Currents are developed in the armature winding by two independent actions, namely, transformer and rotational induction. The component OB is that which produces current in the armature winding by transformer effects, while OA is that producing current

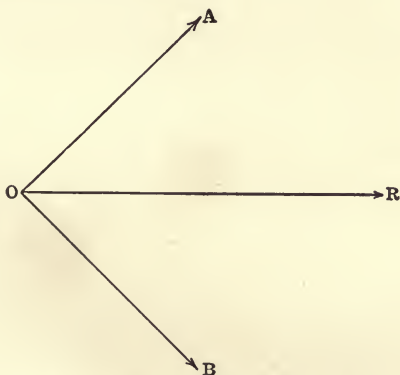

FIG. 155.—COMPONENTS OF REPULSION MOTOR FIELD FLUX.

in the secondary winding by rotation. These two independently produced armature currents are combined to give the total armature current actually existing.

The line voltage applied across the field terminal may be regarded as being made up of three components, namely: First, the component required to overcome the resistance drop in the field winding;

second, that required to overcome the equivalent reactance of the primary winding; and third that needed to overcome the e.m.f. induced in the field winding by the rotation of the armature.

By considering these three components, a circle diagram somewhat similar to that of the series motor can be developed. The torque of the repulsion motor cannot be assumed to vary as the square of the current, since the phase relation between stator and rotor currents, as well as the brush position, must be considered.

An excellent performance diagram of the repulsion motor was given by Mr. Osnos in the "Electrotechnische Zeitschrift" for Oct. 29, 1903, p. 905. This diagram is shown in Fig. 156, and its construc-

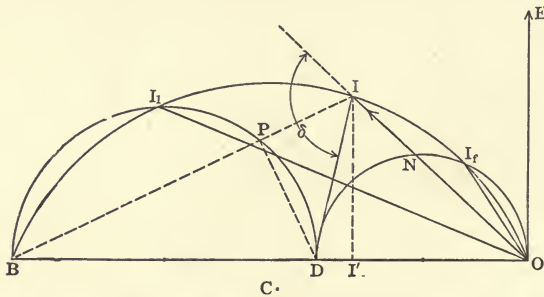

FIG. 156. — THE OSNOS CIRCLE DIAGRAM OF THE REPULSION MOTOR.

tion is as follows: OE represents the direction of the impressed voltage, OI_1 the primary current with the rotor locked, drawn at an angle EOI_1 corresponding to its phase displacement. OI_f is the current with the rotor revolving without load and EOI_f is its corresponding phase angle. Draw an arc of a circle through OI_fI_1 , the point C being the center of the circle. This is the circle of current input, and the angle EOI corresponds to the phase angle of any particular primary current. The ordinate II' is the working or energy component of the current I and is proportional to the input. Describe the circle BI_1D , which has its center on OB perpendicular to OE . Then on OB as a diameter describe a second semicircle OI_fD . The first of these semicircles or BI_1D is the circle of speed and the second circle OI_fD is the torque circle. Thus for a load requiring a current I , the speed is represented by the ratio IP/PD , and the torque by the product $OI \times IN$. The line ID represents the secondary current in phase and magnitude

(reduced to primary equivalents). The angle δ is the difference in phase between corresponding primary and secondary currents. This diagram takes into account the copper losses as well as leakage effects, but does not include the windage, friction or iron losses, which must be allowed for, either by addition to the input or subtraction from the output.

The speed regulation of the repulsion motor may be altered by simply shifting the brushes. This type of motor, however, is very sensitive to comparatively slight change of the brush position, hence extreme care should be taken in attempting thus to vary the speed characteristics.

The direction of rotation of the repulsion motor may be reversed, either by shifting the brushes over to the other side of the neutral line of the field flux, that is from AB to CD in Fig. 154, or by shifting the primary connections by 90 degrees magnetically when a distributed closed coil stator winding is employed.

The Compensated Repulsion Motor * is a development of the preceding motor and was designed with the object of overcoming field distortion, and to increase the power factor of the machine.

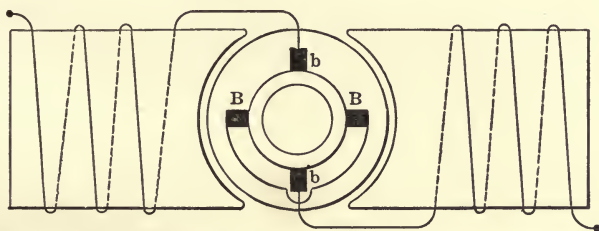

FIG. 157. — CONNECTIONS OF COMPENSATED REPULSION MOTOR.

The diagrammatic connections of the simplest form of this modification are shown in Fig. 157. At first sight, this motor does not differ much from the ordinary series machine, but the presence of brushes B and b considerably modifies the action. One effect is largely to neutralize the self-inductance of the field winding, since the current flowing in the armature across these brushes acts as the current of a short-circuited secondary, of which the field winding is the primary. The field winding, therefore, acts as a transformer coil; on the other hand, it does not supply the entire magnetic

* Transactions, 1904, International Elect. Congress, Vol. III, pp. 129-185.

field necessary for the production of the turning effort. This latter field is now mainly supplied by that component of the current which passes through the armature at brushes *bb*. The current flowing between *bb* is variously known as the *exciting or compensating* current, while that developed between brushes *BB* is called the *short-circuit* current. This type of motor is characterized by high power factor at speeds above synchronism, but at low speed its power factor is less than with the a.c. series motor, while at all speed points its torque per ampere is not as high.

A further criticism of this construction is the fact that the greatest advantage of the repulsion motor — its connection directly to high tension lines — is no longer practicable, because now the revolving member is also in the main circuit so that the necessary insulation is difficult. This bad feature of the compensated motor is avoided by the Winter-Eichberg modification shown in Fig. 158. In this

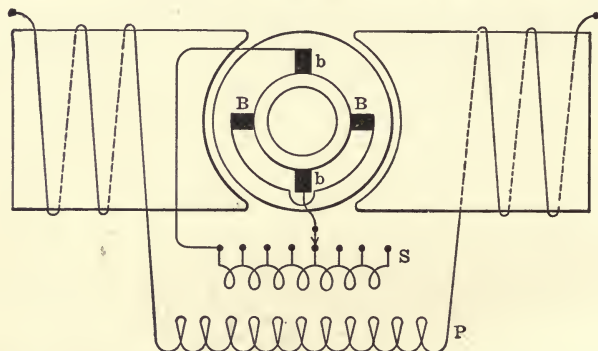

FIG. 158. — CONNECTIONS OF WINTER-EICHBERG COMPENSATED REPULSION MOTOR.

design the armature exciting current, flowing between brushes *bb*, instead of being supplied directly to the armature from the high tension lines, is obtained from the secondary of a transformer whose primary is in series with the stator and high tension circuit. Variable speed is obtainable by variation of the voltage supplied by this secondary, which is provided with taps, as shown.

Even though the repulsion motor, in its various forms, possesses the majority of the desirable features of the a.c. series motor, with the possibility of even better power factor at higher frequencies, combined with high voltage supply to which the armature is not subjected, nevertheless, it has not been as favorably received in

this country as the series machine, on account of the following features:

1. Noisy in starting up.
2. Lower starting torque per ampere, on account of the "blowing out" of the primary flux, due to secondary flux of the armature, as well as the difference in phase.
3. Greater tendency to spark at the brushes, due to excessive transformer currents, upon which its action largely depends.
4. With *compensated* motors, though sparking is much less, the motor is provided with twice as many sets of brushes, which are always a source of weakness and trouble, especially in traction service.
5. Reversal of direction of rotation not as convenient as with the series motor.
6. Shifting from a.c. to d.c. and back again not as easy as with series motor, because of the extra short-circuiting brushes, commutation devices, etc.

COMPARISON OF D.C. AND A.C. COMMUTATOR MOTORS.

With d.c. machines, each circuit or portion thereof, whether in series or shunt, must obtain its current by electrical connection to the supply conductors. On the other hand, a.c. circuits may be supplied *inductively* as well as *conductively*. For example, any d.c. motor must have its field and armature windings, also its compensating winding to neutralize armature reaction (if provided therewith), all connected to the supply circuit. The windings of an a.c. motor, however, may be energized in four different ways: first, by electrical connection to and *conduction* from the supply; second, by *induction* through a transformer; third, by *induction* in the winding short-circuited upon itself; and fourth, by *induction* to another one of the three circuits to which the given winding is connected as a tertiary circuit.

The Winter-Eichberg motor in Fig. 158 has its field winding directly connected to the supply circuit; the armature receives current by the brushes *b* and *b* from the secondary of the transformer *PS* and at the same time the brushes *B* and *B* are connected by very low resistance so as to short-circuit the armature. Thus the first three of the above arrangements are in most a.c. commutator machines present in this one machine. The field winding is con-

nected directly to the supply conductors because it is more easily insulated for the high voltage which they usually carry. The armature, on account of its construction and motion, is more difficult to insulate, and for that reason is often connected as a secondary circuit, the voltage of which may be made as low as desired. This arrangement is characteristic of the repulsion motor and constitutes one of its most prominent advantages. The possibility of energizing any one of the three windings of an a.c. commutator motor in any one of the ways specified above affords opportunity for making many different combinations, but this does not mean that all of them are practically advantageous.

Any a.c. machine may be protected from high-voltage by supplying it through a transformer. Such protection is not absolute in the case of an auto-transformer, but the potential at the motor may be made as low as desired. This arrangement at the same time enables variable voltage to be easily obtained for speed control, as explained in connection with Figs. 151 and 158. The facility of *transformation and variation of voltage* constitute the advantages of a.c. compared with d.c. commutator machines. On the other hand, the low flux densities and power factor, also sparking difficulties of the former, render them less powerful and more troublesome than the latter. In other words, they cost more and develop less power pound for pound, and at the same time are less satisfactory in operation.

For further information on commutating a.c. motors, the reader is referred to:

ALTERNATING-CURRENT ELECT. RAILWAY. G. B. Lamme. Trans. A. I. E. E., Vol. XX, 1902, p. 15.

ALTERNATING-CURRENT MOTORS. A. S. McAllister. New York, 1909.

ALTERNATING-CURRENT RAILWAY MOTORS. W. I. Slichter, Dr. C. P. Steinmetz and W. A. Blank. Trans. A. I. E. E., Vol. XXIII, 1904, pp. 1, 9 and 83.

ELECT. TRACTION. Wilson and Lydall. Vol. 2. London, 1907.

HISTORY AND DEVELOPMENT OF SINGLE-PHASE COMMUTATOR MOTORS. Feldmann, Haga, and Noome. *Der Ingenieur*, March, 1909.

SINGLE-PHASE COMMUTATOR MOTORS. F. Punga, R. F. Looser. 1906.

SINGLE-PHASE COMMUTATOR MOTORS. J. Fischer-Hinnen. *Elect.*, London, Vol. 63, 1909.

SINGLE-PHASE COMMUTATOR MOTORS. M. Deri, M. Latour, O. Bragstad, E. Danielson. Inter. Elect. Cong., St. Louis. 1904, Vol. III, pp. 129-184.

SINGLE-PHASE R. R. MOTORS AND CONTROL. T. H. Schoepf. Jour. Inst. of E. E., London, Vol. 36, 1906.

UEBER WECHSELSTROMME-KOMMUTATOR MOTOREN. M. Osnos, also F. Eichberg, *Electrotechnische Zeitschrift*, Vol. 25, Vol. 27, Vol. 29 (1904-1908).

CHAPTER XIX.

SERVICE CONDITIONS AND APPLICATIONS OF ELECTRIC MOTORS.

ELECTRIC motors employed as a source of driving power must be adapted in speed and torque to the particular purpose to which they are applied. For example, if the speed of the driven machine is required to be practically constant, the motor should also be suitable for *constant speed operation*. It is not necessary in such a case for the motor and the machine driven by it to have the *same* speed, the conditions being often fulfilled more conveniently by a *fixed ratio of speeds* obtained through gearing or belting instead of by direct connection. To secure very low or very high speeds this arrangement with large speed ratios usually becomes practically necessary, as in the case of a triplex plunger pump running at about 50 r.p.m. connected to a 5-horsepower motor whose normal speed is about 800 r.p.m. Another example is afforded by the "buzz" wood planer, the cutting cylinder of which rotates at about 4000 r.p.m. driven by a 3-horsepower motor at say 1000 r.p.m.

If the driven machine or car is to run at *variable velocity*, then the speed of the motor must be varied in the same proportion with either direct connection or fixed ratio of speeds. It is possible to make use of mechanical connections, such as two or more sets of gearing as in gasoline automobiles, to obtain *variable speed ratios*. These may be employed either in place of or in combination with the speed adjustment of the electric motors, depending upon circumstances. In many cases, however, it is preferable to adjust the speed of the motor electrically rather than to introduce two or more sets of gears or other mechanical means of speed control. For instance, a radial drill costs less and is more convenient with a 3:1 adjustable-speed motor than with change gear box and constant-speed motor. There are some cases, especially with large machines which run at one speed for several hours, and only infrequently at a different speed. Under these conditions it would probably be as well to use a practically constant-speed motor and

adjust the speed ratios mechanically. The time required for gear changing is unimportant in such cases, because it occurs but occasionally. In lathes, milling machines and similar tools it is practically necessary to introduce gearing for the very low speeds.

The Speed Classification of Motors recommended in the Standardization Rules of the A. I. E. E., Transactions, Vol. 26, p. 1800, June, 1907, is as follows:

1. Constant-speed motors, in which the speed is either constant or does not materially vary, such as synchronous motors, induction motors with small slip and ordinary direct-current shunt motors.

2. Multispeed motors (two-speed, three-speed, etc.), which can be operated at any one of several distinct speeds, these speeds being practically independent of the load, such as motors with two armature windings.

3. Adjustable-speed motors, in which the speed can be varied gradually over a considerable range, but when once adjusted remains practically unaffected by the load, such as shunt motors designed for a considerable range of field variation.

4. Varying-speed motors, or motors in which the speed varies with the load, decreasing when the load increases, such as series motors.

Classes of Service.—In order properly to understand the action and speed control of electric motors it is important to consider at least in a general way their application to the many practical uses for which they are now employed.

The operating conditions of almost all kinds of machinery with respect to *varying speed, torque and power* may be divided into five general cases, as follows:

(a) Service requiring practically *constant speed, regardless* of changes in torque, sudden as well as gradual.

(b) Service in which the torque is *fairly steady or varies* as some *function* of the speed should the latter change.

(c) Service which involves *frequent starting and stopping* or wide variations in speed with *rapid acceleration*.

(d) Service which involves *frequent starting and stopping* or wide variations in speed with *gradual acceleration*, including very slow operation or "inching."

(e) Service in which the *torque varies regardless* of the speed, or for which *speed variations may be desired irrespective* of torque.

The first case (a) includes the driving of one or more machines by a single electric motor running at practically constant speed. A wood-working shop with circular saws, band saws, planers, etc., is a common and typical example. The direct-current shunt-wound motor and the alternating-current induction or synchronous motors are applicable to this purpose. Direct-current compound-wound motors are particularly suitable if heavy machinery must be started from rest or where heavy overloads, even momentary, are likely to occur. On the other hand the speed of compound motors with variable torque is not so closely constant as in the case of shunt-machines, but in many practical instances the difference would not be objectionable. The torque-exerting capabilities of compound motors and their speed characteristics have been discussed in Chapter XI.

A single machine driven by a motor may be *directly connected* by coupling their shafts or by employing the same shaft for both, provided they are adapted to run or can properly be made to run at the same speed. Buffing wheels, emery wheels or tool grinders mounted upon or directly coupled to the motor shaft are prominent and characteristic examples. If their speeds are different they may be connected by belting for *moderate speed ratios*, and these should not ordinarily exceed 4 to 1. It is customary to use gearing or chain belt for reducing speed in *higher ratios*, especially for *positive driving*. About 8 to 1 speed ratio is the practical limit of a satisfactory chain drive. On the other hand, with sufficient distance between centers, spur gearing will give almost any speed reduction with very high efficiency.

The driven machine may require constant torque as well as constant speed and therefore constant power as in an ordinary pumping installation. Thus there would be nothing to cause speed variation, but even with these simple conditions d.c. shunt motors or a.c. induction motors should be used because their speed is definite with given voltage or frequency, a certain speed being usually desired, and the danger of running away which exists with a series motor is avoided. In most power applications, however, included in this first case (a) the torque and power demanded of the motor are variable even with practically constant speed. Very often, indeed, the torque and power may be almost nil at one moment and at rated value or even greater a second or two later.

Such extreme changes occur very frequently with circular saws, grindstones, drills, punching presses, shears, buffing wheels and many other kinds of machinery. For extremely or even moderately *variable torque with constant speed* the d.c. shunt motor or a.c. induction or synchronous motors are especially applicable, also the d.c. compound motor for strong starting torque or temporary overloads as noted above.

A number of machines operated by one motor are usually driven through a *line shaft* by pulleys and belting. This arrangement distributes the power conveniently, enables the various machines to be run at different speeds by using various ratios of pulley diameters and readily permits the starting and stopping of individual machines by clutches or shifting belts. A group of wood-working or many other kinds of machines are often driven by a single motor in this way, as already stated. Usually the number in use and the torque demanded by each are varying greatly, at the same time approximately constant speed is desired, hence the direct-current shunt or the alternating-current induction or synchronous motor is employed.

A refinement of this problem is encountered in the driving of textile machinery, especially silk looms, with which even a slight speed variation might affect the appearance of the finished product. In such instances the alternating-current induction or synchronous motors are generally employed because the speed of direct-current motors varies considerably with voltage changes and with the variation in temperature which occurs after several hours of operation, as explained in Chapter III, whereas the speed of the alternating-current motors, unless the voltage varies greatly, is dependent upon the frequency of the supplied current.

The second case (b) covers service in which the torque is fairly steady or varies with, but usually more rapidly than, the speed if the latter changes. This case includes the operation of pumps, fans or blower equipments, and its requirements are satisfied by the series motor, whose speed adjusts itself to the work and because it exerts the maximum torque required at starting. It must be, however, either *geared or directly connected* to the apparatus, because the breaking of the belt or the sudden removal of the load would cause a series motor to race and become injured (p. 100). To avoid these dangers or to permit the use of a clutch which might allow a series motor to run away, also because very widely

variable speeds are undesirable, it is common practice to employ heavily compound-wound motors for driving reciprocating pumps or positive blowers. If a break should occur in the suction pipe of a pump a series motor is likely to race, while a compound motor would not rise in speed above the danger limit. The operation of pumps by electric motors is usually effected by gearing, since ordinary plunger pumps do not operate efficiently if driven in excess of fifty strokes per minute, and to accomplish this by direct connection would demand a very low speed and costly motor. Centrifugal pumps or blowers operating at high speed may be direct driven.

The third case (c) includes electric traction and crane service, in which the motor is frequently started and stopped and rapidly accelerated at starting, adjusting itself automatically to the load, slowing down when heavily loaded as when a car is climbing a steep grade. These conditions are satisfied by series motors of either the direct- or alternating-current types, depending upon the current available. Elevator service is of this character, as regards frequent starting and stopping, but after rapid acceleration it calls for a speed independent of the load. Hence, to fulfill both these requirements elevator motors when of the direct-current type are heavily over-compounded to give the series characteristic at starting; then, when the motor is up to speed, its series field winding is short-circuited and it operates as a shunt machine. Recently, however, *two-speed shunt motors* have been employed for this service, the field being of maximum strength for starting, and sparking prevented by use of interpoles. If only alternating current is available, the polyphase induction motor should be employed, but for powerful starting torque slip-ring control would be necessary in order to avoid very excessive currents and low power-factors in starting up or at low speed (pp. 194 and 202).

The fourth case (d) requires the motor to be started and stopped frequently and not rapidly accelerated, but on the contrary slightly moved or "inched" forward at the start, as in the operation of printing presses, gun turrets, etc. These conditions of service are satisfied by direct-current compound-wound motors provided with double armature and series-parallel control (p. 90). This character of work is also well performed by having a double or variable potential source of current supply for the working motor, low voltage being used for starting and "inching" and higher voltages

for running. These features are found in the Bullock "teazer" system, the Holmes-Clatworthy two-motor method, or the Ward-Leonard motor-dynamo equipment. The last named, however, being somewhat expensive, is employed for the operation of gun turrets, steel-rolls and such special service, in which cost is a secondary consideration. This "inching" or very slow operation can also be accomplished by the use of a multiple disk oil clutch, which can be very gradually and smoothly applied.

The fifth case (e) includes individual machine-tool service, for which the maximum allowable cutting or turning speed requires the number of revolutions of the work or tool to vary inversely as the diameter of the cut, maintaining the load at a constant value. This condition is satisfied best by direct-current shunt motors, as these are readily controlled in speed, as described in Chaps. V-VII.

It is to be noted that in cases (a) and (b), the motor usually regulates automatically to maintain practically constant speed. In remaining cases (c), (d) and (e), on the contrary, the motor is controlled by hand to give variable speeds. Furthermore, in case (c) the motor is under control of the hand at all times, while in cases (d) and (e) the motor or machine driven by it, after being started, is set to operate at a desired speed for some time and regulates automatically when so adjusted to maintain that speed.

For further information on the application of electric motors, the reader is referred to the following:

- ELECTRIC DRIVEN MACHINERY. Dr. S. S. Wheeler. *Elec.*, N. Y., May, 1898.
- ELECTRIC POWER IN ENGINEERING WORKS. Dr. Louis Bell. *Eng. Mag.*, October, 1899, January, 1900.
- ELECTRIC DISTRIBUTION OF POWER IN WORK SHOPS. F. B. Crocker. *Fr. Inst.*, January, 1901.
- THE CASE FOR ELECTRIC POWER DISTRIBUTION. W. B. Esson. *Elect. Eng.*, London, January 11, 1901.
- ELECTRIC POWER IN MFG. PLANTS. D. C. and W. B. Jackson. *Cassier's Mag.*, Vol. 26, 1904, p. 151.
- ELECTRIC MOTORS AND THEIR APPLICATIONS. W. E. Reed. *Proc. Eng. Soc.*, W. Penn., October, 1905.
- INDUSTRIAL ENGINEERING. H. W. Peck. *Electric Journal*, Vol. VI, 1909, p. 83.
- APPLICATION OF MOTORS TO MACHINE TOOLS. J. M. Barr. *Electric Journal*, Vol. II, 1905, p. 11.
- APPLICATIONS OF MOTORS. *Electrical Record*, June, 1909.
- COST OF OPERATING MACHINE TOOLS. A. G. Popcke. *Electric Journal*, Vol. VI, 1909, pp. 674, 757.
- ECONOMIC FEATURES OF ELECTRIC DRIVE. Chas. Robbins. *Trans. A. S. M. E.*, April, 1910.

APPENDICES

APPENDIX A.

STANDARDIZATION RULES OF THE AMERICAN INSTITUTE OF ELECTRICAL ENGINEERS.

NEW YORK, June 17, 1907.

DR. SAMUEL SHELDON,

PRESIDENT, AMERICAN INSTITUTE ELECTRICAL ENGINEERS,
33 West 39th Street,
New York City.

DEAR SIR: —

In accordance with a motion made by Dr. Steinmetz, and duly carried at the last Annual Convention of the Institute, at Milwaukee, the Standardization Rules have been revised in form and wording and in accordance with various suggestions received from members of the Institute. This work has been accomplished by the Standards Committee, which has held monthly meetings beginning in September last.

Dr. Steinmetz' motion provided that the Standardization Rules when completed by the Committee should be submitted to the Board of Directors for final adoption and promulgation. I therefore submit the revised Standardization Rules through you to the Board of Directors, and request that they be formally approved and adopted.

Respectfully yours,

(Signed) FRANCIS B. CROCKER,
Chairman Standards Committee.

STANDARDS COMMITTEE.

FRANCIS B. CROCKER, Chairman, Columbia University, New York, N. Y.	CHARLES F. SCOTT, Pittsburg, Pa.
ARTHUR W. BERRESFORD, Milwaukee.	HENRY G. STOTT, New York, N. Y.
DUGALD C. JACKSON, Boston, Mass.	CHARLES P. STEINMETZ, Schenectady.
ARTHUR E. KENNELLY, Cambridge, Mass.	SAMUEL W. STRATTON, Washington, D. C.
C. O. MAILLOUX, New York, N. Y.	ELIHU THOMSON, Lynn, Mass.
ROBERT B. OWENS, Montreal, Can.	

Approved by vote of the Board of Directors, June 21, 1907.

RALPH W. POPE,
Secretary.

New York, June 21, 1907.

PORTIONS OF THE
STANDARDIZATION RULES OF THE A. I. E. E.
RELATING TO ELECTRIC MOTORS AND
RHEOSTATS.

The rules in full may be obtained from the Secretary of the Institute.

I. DEFINITIONS AND TECHNICAL DATA.

1 *Note:* The following definitions and classifications are intended to be practically descriptive and not scientifically rigid.

E. MOTORS. SPEED CLASSIFICATION.

45 MOTORS may, for convenience, be classified with reference to their speed characteristic as follows:

46 *a.* CONSTANT-SPEED MOTORS, in which the speed is either constant or does not materially vary; such as synchronous motors, induction motors with small slip, and ordinary direct-current shunt motors.

47 *b.* MULTISPEED MOTORS (two-speed, three-speed, etc.), which can be operated at any one of several distinct speeds, these speeds being practically independent of the load, such as motors with two armature windings.

48 *c.* ADJUSTABLE-SPEED MOTORS, in which the speed can be varied gradually over a considerable range; but when once adjusted remains practically unaffected by the load, such as shunt motors designed for a considerable range of field variation.

49 *d.* VARYING-SPEED MOTORS, or motors in which the speed varies with the load, decreasing when the load increases; such as series motors.

II. PERFORMANCE SPECIFICATIONS AND TESTS.

A. RATING.

65 RATING BY OUTPUT. All electrical apparatus should be rated by output and not by input. Generators, transformers, etc., should be rated by electrical output; motors by mechanical output.

66 RATING IN KILOWATTS. Electrical power should be expressed in kilowatts, except when otherwise specified.

67 APPARENT POWER, KILOVOLT-AMPERES. Apparent power in alternating-current circuits should be expressed in kilovolt-amperes as dis-

tinguished from real power in kilowatts. When the power factor is 100 per cent, the apparent power in kilovolt-amperes is equal to the kilowatts.

68 THE RATED (FULL-LOAD) CURRENT is that current which, with the rated terminal voltage, gives the rated kilowatts; or the rated kilovolt-amperes. In machines in which the rated voltage differs from the no-load voltage, the rated current should refer to the former.

73 NORMAL CONDITIONS. The rating of machines or apparatus should be based upon certain normal conditions to be assumed as standard, or to be specified. These conditions include voltage, current, power-factor, frequency, wave shape and speed; or such of them as may apply in each particular case. Performance tests should be made under these standard conditions unless otherwise specified.

D. REGULATION.

(I) DEFINITIONS.

187 DEFINITION. The regulation of a machine or apparatus in regard to some characteristic quantity (such as terminal voltage, current or speed) is the ratio of the deviation of that quantity from its normal value at rated load to the normal rated load value. The term "regulation," therefore, has the same meaning as the term "inherent regulation," occasionally used.

188 CONSTANT STANDARD. If the characteristic quantity is intended to remain constant (*e.g.*, constant voltage, constant speed, etc.) between rated load and no load, the regulation is the ratio of the maximum variation from the rated load value to the no-load value.

189 VARYING STANDARD. If the characteristic quantity is intended to vary in a definite manner between rated load and no load, the regulation is the ratio of the maximum variation from the specified condition to the normal rated-load value.

195 IN CONSTANT-SPEED DIRECT-CURRENT MOTORS and INDUCTION MOTORS the regulation is the ratio of the maximum variation of speed from its rated load value (occurring within the range from rated load to no-load) to the rated load speed.

196 The regulation of an induction motor is, therefore, not identical with the slip of the motor, which is the ratio of the drop in speed from synchronism, to the synchronous speed.

206 WAVE FORM. In alternating apparatus receiving electric power, regulation should refer to a sine wave of e.m.f., except where expressly specified otherwise.

207 EXCITATION. In commutating machines, rectifying machines, and synchronous machines, such as direct-current generators and motors,

alternating-current and polyphase generators, the regulation is to be determined under the following conditions:

- (1) At constant excitation in separately excited fields.
- (2) With constant resistance in shunt-field circuits, and
- (3) With constant resistance shunting series-field circuits; *i.e.*, the field adjustment should remain constant, and should be so chosen as to give the required full-load voltage at full-load current.

E. INSULATION.

(I) INSULATION RESISTANCE.

210 INSULATION RESISTANCE is the ohmic resistance offered by an insulating coating, cover, material or support to an impressed voltage, tending to produce a leakage of current through the same.

211 OHMIC RESISTANCE AND DIELECTRIC STRENGTH. The ohmic resistance of the insulation is of secondary importance only, as compared with the dielectric strength, or resistance to rupture by high voltage. Since the ohmic resistance of the insulation can be very greatly increased by baking, but the dielectric strength is liable to be weakened thereby, it is preferable to specify a high dielectric strength rather than a high insulation resistance. The high-voltage test for dielectric strength should always be applied.

212 RECOMMENDED VALUE OF RESISTANCE. The insulation resistance of complete apparatus should be such that the rated voltage of the apparatus will not send more than $\frac{1}{1000}$ of the rated-load current, at the rated terminal voltage, through the insulation. Where the value found in this way exceeds 1 megohm, it is usually sufficient.

213 INSULATION RESISTANCE TESTS should, if possible, be made at the pressure for which the apparatus is designed.

(II) DIELECTRIC STRENGTH.

(A) TEST VOLTAGES.

214 DEFINITION. The dielectric strength of an insulating wall, coating, cover or path is measured by the voltage which must be applied to it in order to effect a disruptive discharge through the same.

215 BASIS FOR DETERMINING TEST VOLTAGES. The test voltage which should be applied to determine the suitability of insulation for commercial operation is dependent upon the kind and size of the apparatus and its normal operating voltage, upon the nature of the service in which it is to be used, and the severity of the mechanical and electrical stresses to which it may be subjected. The voltages and other conditions of test which are recommended have been determined as reasonable and proper

for the great majority of cases and are proposed for general adoption, except when specific reasons make a modification desirable.

216 **CONDITION OF APPARATUS TO BE TESTED.** Commercial tests should, in general, be made with the completely assembled apparatus and not with individual parts. The apparatus should be in good condition, and high-voltage tests, unless otherwise specified, should be applied before the machine is put into commercial service, and should not be applied when the insulation resistance is low owing to dirt or moisture. High-voltage tests should, in general, be made at the temperature assumed under normal operation. High-voltage tests considerably in excess of the normal voltages to determine whether specifications are fulfilled are admissible on new machines only.

217 **POINTS OF APPLICATION OF VOLTAGE.** The test voltage should be successively applied between each electric circuit and all other electric circuits including conducting material in the apparatus.

218 The **FREQUENCY** of the alternating-current test voltage is, in general, immaterial within commercial ranges. When, however, the frequency has an appreciable effect, as in alternating-current apparatus of high voltage and considerable capacity, the rated frequency of the apparatus should be used.

219 **TABLE OF TESTING VOLTAGES.** The following voltages are recommended for testing all apparatus, lines and cables, by a continued application for one minute. The test should be with alternating voltage having an effective value (or root mean square referred to a sine wave of voltage) given in the table and preferably for tests of alternating apparatus at the normal frequency of the apparatus.

	Rated Terminal Voltage of Circuit.	Rated Output.	Testing Voltage.
220	Not exceeding 400 volts.....	Under 10 kw.....	1,000 volts.
	“ “ “	10 kw. and over....	1,500 “
	400 and over, but less than 800 volts....	Under 10 kw.....	1,500 “
	“ “ “	“ “ “	2,000 “
	800 “ “ “ 1,200 “	Any	3,500 “
	1,200 “ “ “ 2,500 “	Any	5,000 “
	2,500 “ “	Any...Double the normal rated	voltages.

222 **EXCEPTION.—FIELD WINDINGS.** The tests for field windings should be based on the rated voltage of the exciter and the rated output of the machine of which the coils are a part. Field windings of synchronous motors and converters, which are to be started by applying alternating current to the armature when the field is not excited and a high voltage is induced in the field windings, should be tested at 5000 volts.

F. CONDUCTIVITY.

260 COPPER. The conductivity of copper in electric wires and cables should not be less than 98% of Matthiessen's standard of conductivity, as defined in the Copper Wire Table of the AMERICAN INSTITUTE OF ELECTRICAL ENGINEERS.

G. RISE OF TEMPERATURE.

(I) MEASUREMENT OF TEMPERATURE.

(A) METHODS.

261 There are two methods in common use for determining the rise in temperature, viz.: (1) by thermometer, and (2) by increase in resistance of an electric circuit.

262 1. By THERMOMETER. The following precautions should be observed in the use of thermometers:

263 *a.* PROTECTION. The thermometers indicating the room temperature should be protected from thermal radiation emitted by heated bodies, or from draughts of air or from temporary fluctuations of temperature. Several room thermometers should be used. In using the thermometer by applying it to a heated part, care should be taken so to protect its bulb as to prevent radiation from it, and, at the same time, not to interfere seriously with the normal radiation from the part to which it is applied.

264 *b.* BULB. When a thermometer is applied to the free surface of a machine, it is desirable that the bulb of the thermometer should be covered by a pad of definite area. A convenient pad may be formed of cotton waste in a shallow circular box about one and a half inches in diameter, through a slot in the side in which the thermometer bulb is inserted. An unduly large pad over the thermometer tends to interfere with the natural liberation of heat from the surface to which the thermometer is applied.

265 2. By INCREASE IN RESISTANCE. The resistance may be measured either by Wheatstone bridge, or by drop-of-potential method. A temperature coefficient of 0.42 per cent per degree C., from and at 0° C., may be assumed for copper.

The temperature-coefficients from and at each degree cent. between 0° C. and 50° C. are given in Appendix E. The temperature rise may be determined either (1) by dividing the percentage increase of initial resistance by the temperature-coefficient for the initial temperature expressed in per cent; or (2) by multiplying the increase in per cent of the

initial resistance by 238.1 plus the initial temperature in degrees C., and then dividing the product by 100.

266 3. COMPARISON OF METHODS. In electrical conductors, the rise of temperature should be determined by their increase of resistance where practicable. Temperature elevations measured in this way are usually in excess of temperature elevations measured by thermometers. In very low resistance circuits, thermometer measurements are frequently more reliable than measurements by the resistance method. Where a thermometer applied to a coil or winding indicates a higher temperature elevation than that shown by resistance measurement, the thermometer indication should be accepted.

(B) NORMAL CONDITIONS FOR TESTS.

267 1. DURATION OF TESTS. The temperature should be measured after a run of sufficient duration for the apparatus to reach a practically constant temperature. This is usually from 6 to 18 hours, according to the size and construction of the apparatus. It is permissible, however, to shorten the time of the test by running a lesser time on an overload in current and voltage, then reducing the load to normal, and maintaining it thus until the temperature has become constant.

268 2. ROOM TEMPERATURE. The rise of temperature should be referred to the standard condition of a room temperature of 25° C.

269 TEMPERATURE CORRECTION. If the room temperature during the test differs from 25° C., correction on account of difference in resistance should be made by changing the observed rise of temperature by one-half per cent. for each degree C. Thus with a room temperature of 35° C., the observed rise of temperature has to be decreased by 5 per cent, and with a room temperature of 15° C., the observed rise of temperature has to be increased by 5 per cent. In certain cases, such as shunt-field circuits without rheostat, the current strength will be changed by a change of room temperature. The heat production and dissipation may be thereby affected. Correction for this should be made by changing the observed rise in temperature in proportion as the I^2R loss in the resistance of the apparatus is altered owing to the difference in room temperature.

270 3. BAROMETRIC PRESSURE. VENTILATION. A barometric pressure of 760 mm. and normal conditions of ventilation should be considered as standard, and the apparatus under test should neither be exposed to draught nor enclosed, except where expressly specified. The barometric pressure needs to be considered only when differing greatly from 760 mm.

271 BAROMETRIC PRESSURE CORRECTION. When the barometric pressure differs greatly from the standard pressure of 760 mm. of mercury, as at high altitudes, a correction should be applied. In the absence of more accurate data, a correction of 1% of the observed rise in tempera-

ture for each 10 mm. deviation from the 760 mm. standard is recommended. For example, at a barometric pressure of 680 mm. the observed rise of temperature is to be reduced by $\frac{760 - 680}{10} = 8\%$.

(II) *LIMITING TEMPERATURE RISE.*

272 GENERAL. The temperature of electrical machinery under regular service conditions should never be allowed to remain at a point at which permanent deterioration of its insulating material takes place.

273 LIMITS RECOMMENDED. It is recommended that the following maximum values of temperature elevation, referred to a standard room temperature of 25 degrees centigrade, at rated load under normal conditions of ventilation or cooling, should not be exceeded.

(A) MACHINES IN GENERAL.

274 In commuting machines, rectifying machines, pulsating-current generators, synchronous machines, synchronous commutating machines and unipolar machines, the temperature rise in the parts specified should not exceed the following:

275 Field and armature, 50° C.

276 Commutator and brushes, by thermometer, 55° C.

277 Collector rings, 65° C. *x*.

278 Bearings and other parts of machine, by thermometer, 40° C.

279 (B) ROTARY INDUCTION APPARATUS. The temperature rise should not exceed the following:

280 Electric circuits, 50° C., by resistance.

281 Bearings and other parts of the machine 40° C., by thermometer.

282 In squirrel-cage or short-circuited armatures, 55° C., by thermometer, may be allowed.

(D) RHEOSTATS.

287 In RHEOSTATS, HEATERS and other electrothermal apparatus, no combustible or inflammable part or material, or portion liable to come in contact with such material, should rise more than 50° C. above the surrounding air under the service conditions for which it is designed.

288 *a.* PARTS OF RHEOSTATS. Parts of rheostats and similar apparatus rising in temperature, under the specified service conditions, more than 50° C. should not contain any combustible material, and should be arranged or installed in such a manner that neither they, nor the hot air issuing from them, can come in contact with combustible material.

(E) LIMITS RECOMMENDED IN SPECIAL CASES.

289 *a.* HEAT RESISTING INSULATION. With apparatus in which the insulating materials have special heat-resisting qualities, a higher temperature elevation is permissible.

290 b. HIGH AIR TEMPERATURE. In apparatus intended for service in places of abnormally high temperature, a lower temperature elevation should be specified.

291 c. APPARATUS SUBJECT TO OVERLOAD. In apparatus which by the nature of its service may be exposed to overload, or is to be used in very high voltage circuits, a smaller rise of temperature is desirable than in apparatus not liable to overloads or in low-voltage apparatus. In apparatus built for conditions of limited space, as railway motors, a higher rise of temperature must be allowed.

292 d. APPARATUS FOR INTERMITTENT SERVICE. In the case of apparatus intended for intermittent service, except railway motors, the temperature elevation which is attained at the end of the period corresponding to the term of rated load should not exceed the values specified for machines in general. In such apparatus the temperature elevation, including railway motors, should be measured after operation, under as nearly as possible the conditions of service for which the apparatus is intended, and the conditions of the test should be specified.

H. OVERLOAD CAPACITIES.

293 PERFORMANCE WITH OVERLOAD. All apparatus should be able to carry the overload hereinafter specified without serious injury by heating, sparking, mechanical weakness, etc., and with an additional temperature rise not exceeding 15° C., above those specified for rated loads, the overload being applied after the apparatus has acquired the temperature corresponding to rated load continuous operation. Rheostats to which no temperature rise limits are attached are naturally exempt from this additional temperature rise of 15° C. under overload specified in these rules.

294 NORMAL CONDITIONS. Overload guarantees should refer to normal conditions of operation regarding speed, frequency, voltage, etc., and to non-inductive conditions in alternating apparatus, except where a phase displacement is inherent in the apparatus.

295 OVERLOAD CAPACITIES RECOMMENDED. The following overload capacities are recommended:

296 a. GENERATORS. Direct-current generators and alternating-current generators, 25 per cent for two hours.

297 b. MOTORS. Direct-current motors, induction motors and synchronous motors, not including railway and other motors intended for intermittent service, 25 per cent for two hours, and 50 per cent for one minute.

301 *f.* A CONTINUOUS-SERVICE RHEOSTAT, such as an armature- or field-regulating rheostat, should be capable of carrying without injury for two hours, a current 25 per cent greater than that at which it is rated. It should also be capable of carrying for one minute a current 50 per cent greater than its rated load current, without injury. This excess of capacity is intended for testing purposes only, and this margin of capacity should not be relied upon in the selection of the rheostat.

302 *g.* An INTERMITTENT SERVICE OR MOTOR-STARTING RHEOSTAT is used for starting a motor from rest and accelerating it to rated speed. Under ordinary conditions of service, and unless expressly stated otherwise, a motor is assumed to start in fifteen seconds and with 150% of rated current strength. A motor-starter should be capable of starting the motor under these conditions once every four minutes for one hour.

303 (*a*) This TEST may be carried out either by starting the motor at four-minute intervals, or by placing the starter at the normal temperature across the maximum voltage for which it is marked, and moving the lever uniformly and gradually from the first to the last position during a period of fifteen seconds, the current being maintained substantially constant at said 50% excess by introducing resistance in series or by other suitable means.

304 (*b*) OTHER RHEOSTATS FOR INTERMITTENT-SERVICE are employed under such special and varied conditions that no general rules are applicable to them.

IV. GENERAL RECOMMENDATIONS.

313 NAME PLATES. All electrical apparatus should be provided with a name plate giving the manufacturer's name, the voltage and the current in amperes for which it is designed. Where practicable, the kilowatt capacity, character of current, speed, frequency, type, designation and serial number should be added.

314 DIAGRAMS OF CONNECTIONS. All electrical apparatus when leaving the factory should be accompanied by a diagram showing the electrical connections and the relation of the different parts in sufficient detail to give the necessary information for proper installation.

315 RHEOSTAT DATA. Every rheostat should be clearly and permanently marked with the voltage and amperes, or ranges, for which it is designed.

(I) RATING. RAILWAY MOTORS.

325 INTRODUCTORY NOTE ON RATING. Railway motors usually operate in a service in which both the speed and the torque developed by the motor are varying almost continually. The average requirements,

however, during successive hours in a given class of service are fairly uniform. On account of the wide variation of the instantaneous loads, it is impracticable to assign any simple and definite rating to a motor which will indicate accurately the absolute capacity of a given motor or the relative capacity of different motors under service conditions. It is also impracticable to select a motor for a particular service without much fuller data with regard both to the motor and to the service than is required, for example, in the case of stationary motors which run at constant speeds.

326 SCOPE OF NOMINAL RATING. It is common usage to give railway motors a nominal rating in horsepower on the basis of a one-hour test. As above explained, a simple rating of this kind is not a proper measure of service capacity. This nominal rating, however, indicates approximately the maximum output which the motor should ordinarily be called upon to develop during acceleration. Methods of determining the continuous capacity of a railway motor for service requirements are given under a subsequent heading.

327 The NOMINAL RATING of a railway motor is the horsepower output at the car-axle, that is, including gear and other transmission losses, which gives a rise of temperature above the surrounding air (referred to a room temperature of 25 degrees cent.) not exceeding 90 degrees cent. at the commutator and 75 degrees cent. at any other part after one hour's continuous run at its rated voltage (and frequency, in the case of an alternating-current motor) on a stand, with the motor-covers removed, and with natural ventilation. The rise in temperature is to be determined by thermometer, but the resistance of no electrical circuit in the motor shall increase more than 40% during the test.

(II) SELECTION OF MOTOR FOR SPECIFIED SERVICE.

328 GENERAL REQUIREMENTS. The suitability of a railway motor for a specified service depends upon the following considerations:

329 *a.* Mechanical ability to develop the requisite torque and speeds as given by its speed-torque curve.

330 *b.* Ability to commute successfully the current demanded.

331 *c.* Ability to operate in service without occasioning a temperature rise in any part which will endanger the life of the insulation.

332 OPERATING CONDITIONS, TYPICAL RUN. The operating conditions which are important in the selection of a motor include the weight of load, the schedule speed, the distance between stops, the duration of stops, the rate of acceleration and of braking retardation, the grades and the curves. With these data at hand, the outputs which are required of the motor may be determined, provided the service requirements are

within the limits of the speed-torque curve of the motor. These outputs may be expressed in the form of curves giving the instantaneous values of current and of voltage which must be applied to the motor. Such curves may be laid out for the entire line, but they are usually constructed only for a certain average or typical run, which is fairly representative of the conditions of service. To determine whether the motor has sufficient capacity to perform the service safely, further tests or investigations must be made.

333 CAPACITY TEST OF RAILWAY MOTOR IN SERVICE. The capacity of a railway motor to deliver the necessary output may be determined by measurement of its temperature after it has reached a maximum in service. If a running test cannot be made under the actual conditions of service, an equivalent test may be made in a typical run back and forth, under such conditions of schedule speed, length of run, rate of acceleration, etc., that the test cycle of motor losses and conditions of ventilation are essentially the same as would be obtained in the specified service.

334 METHODS OF COMPARING MOTOR CAPACITY WITH SERVICE REQUIREMENTS. Where it is not convenient to test motors under actual service conditions or in an equivalent typical run, recourse may be had to one of the two following methods of determining temperature rise now in general use:

335. I. METHOD BY LOSSES AND THERMAL CAPACITY CURVES. The heat developed in a railway motor is carried partly by conduction through the several parts and partly by convection through the air to the motor-frame whence it is distributed to the outside air. As the temperature of the several parts is thus dependent not only upon their own internal losses but also upon the temperature of neighboring parts, it becomes necessary to determine accurately the actual value and distribution of losses in a railway motor for a given service and reproduce them in an equivalent test-run. The results of a series of typical runs expressed in the form of thermal capacity curves will give the relation between degrees rise per watt loss in the armature and in the field for all ratios of losses between them met with in the commercial application of a given motor.

336 This method consists, therefore, in calculating the several internal motor losses in a specified service and determining the temperature rise with these losses from thermal capacity curves giving the degrees rise per watt loss as obtained in experimental track tests made under the same conditions of ventilation.

337 The following motor losses cause its heating and should be carefully determined for a given service: I^2R in the field; I^2R in the armature; I^2R in the brush contracts, core loss and brush friction.

338 The loss in the bearings (in the case of geared motors) also adds

somewhat to the motor-heating, but owing to the variable nature of such losses they are generally neglected in making calculations.

339 2. METHOD BY CONTINUOUS CAPACITY OF MOTORS. The essential losses in the motor, as found in the typical run, are in most cases those in the motor windings and in the core. The mean service conditions may be expressed in terms of the current which would produce the same losses in the motor windings and the voltage which, with that current, would produce the same core losses as the average in service. The continuous capacity of the motor is given in terms of the amperes which it will carry when run on a testing stand — with covers on or off, as specified — at different voltages, say, 40, 60, 80 and 100 per cent of the rated voltage — with a temperature rise not exceeding 90 degrees at the commutator and 75 degrees at any other part, provided the resistance of no electric circuit in the motor increases more than 40 per cent. A comparison of the equivalent service conditions with the continuous capacity of the motor will determine whether the service requirements are within the safe capacity of the motor.

340 This method affords a ready means of determining whether a specified service is within the capacity of a given motor and it is also a convenient approximate method for comparing the service capacities of different motors.

INDEX

	Page
A	
Adams, Prof. C. A.	176
Adams, W. G.	125
Adjustable-speed Motors	267, 273
Advantages of Electric Power	4
Alternating-current Motors	
History of	125
Polyphase Induction	126, 165
Repulsion	130, 257
Series	129, 240
Shunt	239
Single-phase Induction	214
Synchronous	125, 130
Alternators	
Parallel Connection	125, 136
Series Connection	133
Anthony, Prof. W. A.	130
Application of Motors	266
Arago, F. J.	126
Armature	
Heating	13, 26
Resistance	18
Resistance Control	38
Armature Reaction	21
Balancing Winding	50, 58
Compensation of	48, 58
Effect on Speed	25
Auto-transformer	195
Auxiliary Poles	49, 60
B	
Bailey, W.	126
Balancer Sets, Multiple Voltage	82
Balancing Actions of Synchronous Motors	161
Balancing Windings, Ryan, H. J.	50, 58
Ball Bearings	65
Barlow's Wheel	1
Boost and Retard System	83
Boucherat, P.	197
Bradley, C. S.	124, 127
Brush-contact Resistance	16, 19
Brush Drop	18
Brush Shifting	45
Bullock Elec. Mfg. Co.	
Adjustable-speed Shunt Motors	60, 92
Multiple-voltage System	78
Teaser System	85
C	
Cascade Control	207
Chain Drive	268

	Page
Characteristic Curves of	
Compound Motors	120
Induction Motors	181, 189, 228
Series Motors	106, 252
Shunt Motors	50, 74
Synchronous Motors	149, 154, 159
Circle Diagram of	
A. C. Series Motor	250
Heyland, A.	182
McAllister, A. S.	186, 230
Polyphase-Induction Motors	182, 186
Repulsion Motor	261
Single-phase Induction Motor	230
Synchronous Motor	152
Classification of Motors	4, 123, 267
Commercial Electric Co.	
Double Armature Control	90, 92
Commutating Fringe	49
Commutation Lug	48
Commutation Poles	49, 60
Compensation	
Armature Reaction	49
Thompson-Ryan	49
Windings	49, 254, 259, 262
Compensator Starter	194
Compound-wound Motors	118
Condenser-Compensator	235
Condit, G. H.	111
Constant	
Current Motor	114
H. P. Motors	47, 74
Torque Motors	47, 74
Controller	
Drum and Master	113
G. E. Type K	110
Resistance	38, 109
Counter E.M.F.	14, 16, 46
Crocker-Wheeler Co.	
Multiple-Voltage System	77
Current Equivalent	
Single Phase	186
D	
Damping Grids	162
Data of	
Induction Motors	192, 230
Shunt Motors	20
Deprez, M.	126
Design Features of Series A. C. Motors	244
Design Features Shunt Motors	47
Design of Resistance Controller	39

	Page		Page
Diehl Co. Field Control	68		
Dielectric Strength	275		
Differentially Wound Motors	118, 121		
Direct Current Motors	4		
Double-armature Control Methods	90		
Double-frequency Currents	222		
Drum and Master Controller	113		
Dunn, G. S.	66		
E			
Edison, Reluctance Control	67		
Efficiency			
Calculation of	22		
Field-controlled Motors	52, 55, 59, 65, 73		
Induction Motors	193, 231		
Multiple-voltage Control	81		
Name Plate	22		
Resistance Control	41		
Series Motor Control	103, 113		
Eichmeyer, R.	130		
Electric Drive			
Advantages of	5		
Applications of	266		
Reliability of	8		
Speed Control	8		
Electro-Dynamic Co.	61		
Equivalent Single-phase			
Current	186		
Resistance	186		
Equivalent Transformer	183		
F			
Faraday's Disk	1		
Ferraris, Prof. G.	127, 165, 225		
Field			
Heating of Windings	12, 26		
Reluctance Variation	67		
Rotating	126, 165, 216		
Speed Control	46, 111		
Flux Distribution	51, 53, 57, 64		
G			
Gears	105, 366		
General Electric Co.			
Double-armature Control	90		
Induction Motor	232		
Series Motor Type 69	105		
Type K Controller	110		
H			
Heating			
Armature	13, 26		
Field	12, 26		
Limits	12, 106, 109, 277, 279		
Heyland, A	183, 236		
Heyland Circle Diagram	183		
Heyland Induction Motors	235		
History of Motors	124		
Holmes-Clatworthy System	89		
Hopkinson, J.	124		
Horse-power Current Curve	102		
Hunting of Motors	161		
		I	
Induction Motor, Polyphase	127, 165		
Advantages of Three-phase	169		
Cascade Connection	207		
Characteristic Curves	189		
Circle Diagram	182, 186		
Compensator for	190		
Construction of	165		
Development of	127		
Efficiency of	192		
Equivalent Single-phase	185		
Equivalent Transformer	186		
Field-Magnetic	165		
Flux Equation	174		
Leakage Component	176		
Current	178		
Reactance	176		
Locked Current	187		
Saturation Curve	187		
Magnetizing Current	175		
Factor	175		
Poles	173		
Power Factor	178, 192		
Pull-out Torque	177, 181, 192		
Resistance Control	173, 207		
Rotors for	165, 173, 197		
Slip	169, 192		
Slip-ring Control	173		
Speed Control	204		
Starting of	194		
Starting Torque	181, 202		
Stator for	165, 169		
Torque and Resistance	180, 201		
Torque-Voltage	182, 212		
Induction Motor, Single-phase	214		
Absence of Starting Torque	214		
Brown, Boveri & Co. Types	233		
Characteristic Curves	230		
Condenser Compensator	235		
Form of Field	219		
G. E. Starter	234		
Methods of Starting	232		
Rotating Field	216		
Rotor Currents	222		
Slip	231		
Slip-rotor Resistance	227		
Split-phase	232		
Starting of	232		
Steinmetz, C. P.	232, 234		
Tesla Patent	232		
Wagner Electric Co.	232		
Insulation Resistance	275		
Interpoles	49		
Interpole Motor	49, 60, 111		
Iron Loss, Series Motor	242		
J			
Jackson, Prof. D. C.	130		
Jacobi Motor	1		
L			
Lamme, G. B.	130, 241		
Leakage			
Current	178		

Leakage — <i>Continued.</i>	Page
Flux	176
Primary	176
Reactance	170, 176
Reduction of Power Factor by	178
Secondary	176
Lincoln Motor	72
Load Factor	5
Locked Current	187
Locked Saturation Curve	187
Losses, Division of	24

M

McAllister, A. S.	185, 230
Magneto Electric Co.	52
Master Control	113
Motors	
Advantages of	5
Application of	266
Classes of Service	266
Compensated	48, 55, 254, 262
Definition	1
Compound	118
Induction	127, 165, 214
Interpole	49, 60, 111
Series	94, 241
Shunt	10, 239
Speed Classification	273
Synchronous	125, 131
Rating of	273
Repulsion	130, 257
Types of	4, 123
Motor-generator System	83
Multiple-voltage System	
Balancer Sets for	82
Bullock Electric Co.	78
Control of	83
Crockier-Wheeler Co.	77
Efficiency of	79
Three-wire	75
Ward-Leonard, H.	76

N

Name Plate	
Data	22, 281
Efficiency	22
Nominal Rating	282
Northern Elec. Mfg. Co.	55

O

Osnos, M.	261
Osnos Circle Diagram	261

P

Pacinotti	1, 125
Page Motor	1
Performance	
Specifications	273
Tests	273
Pfatscher, M.	49, 60
Phase	
Splitting	232
Swinging	161

Potter, W. B.	107
Power Factor	
of Induction Motors	179, 194, 203, 231
of Repulsion Motors	262
of Series Motors	242, 247, 254
of Synchronous Motors	140, 160
Press Control	87, 270
Preventive Leads	246

Q

Quarter Phase	165, 168
-------------------------	----------

R

Rated	
Current	11, 12
Voltage	11
Rating	
Motors	273
Series Motors	107, 282
Repulsion Motor	
Anthony-Jackson-Ryan	130
Circle Diagram	261
Compensated	259, 262
History	130
Speed Regulation	262
Thomson, Prof. E.	130, 257
Winter-Eichberg	263
Resistance Control	
Induction Motors	199, 207, 212
Series Motors	109
Shunt Motors	33, 38
Rheostats	
Continuous Service	281
Heating of	179
Intermittent Service	281
Starting	33, 109, 199, 281
Ridgway Motor	48, 55
Rotary Field	126, 165, 216, 219
Rotor Windings	165, 173, 197
Ryan, Prof. H. J.	48, 130

S

Saturation Factor	29
Series Motor, A. C.	123, 129, 241
Characteristic Curves	252
Circle Diagrams	250
Compensated	254
Construction	242
Control	255
Losses in	242, 254
Power Factor	242, 247
Preventive Leads	246
Siemens, Alex.	129
Sparking	245, 254
Transformer Action	242, 244
Vector Diagram	248
Voltages occurring in	242
Series Motor, D. C.	4, 94
Constant Current	94, 114
Constant Potential	94
Characteristic Curves	94 et seq.
Connections	94, 100, 105
Control of	109

	Page		Page
Series Motor, D. C.— <i>Continued.</i>		Starting — <i>Continued.</i>	
Drum and Master Control	113	Series Motors	109, 255
Field Control	111	Shunt Motors	33
Gears for	105	Synchronous Motors	136
G. E. Type 69C	99	Stator Windings	169
Racing of	100	Steinmetz, Dr. C. P.	129, 232, 234
Rating of	107, 282	Storey Motor	52
Resistance Control	109	Stow Motor	68
Series-parallel Control	109	Synchronous Motor	131
Speed-current	94	Action	132, 148
Speed-tractive Effort	104	Balancing Action	161
Torque-current	99	Circle Diagram	153
Torque per ampere	100	Current-phase Angle Curves	153
Westinghouse Motor	107	Current-power Curves	157
Shunt Motor	10, 239	Damping Coils	164
Adjustable-speed Types	46, 67	Driving Power	151
Armature Resistance-Speed	25, 38	History	125
Auxiliary Pole	49, 60	Hunting	162, 164
Brush Shifting and Speed	45	Limit of Stability	148, 150
Bullock Co.	49	Maximum Output	147
Commutation Pole	49, 60	Phase Relations	141
Compensated	48, 55	Power-factor, Improvement	142
Data, Constant-speed Types	20	Speed of	132
Double Armature	90	Starting of	136
Efficiency	22, 52, 56, 59, 65, 71	Starting Torque	136
Electro-Dynamic Co.	49, 60	Super-Excitation	143
Field Control	46, 68	Synchronism	132
Flux Distribution	52, 54, 58, 65, 71	Synchronizing	136
Heating	26	Torque	143
Interpolar	61, 63	V Curves	159
Lincoln Mfg. Co.	72	Variation of Field	142
Magneto Electric Co.	52	of Power Factor	143
Methods of Speed Control	38, 46, 68, 74	Synchroscope	139
Multiple-voltage Control	74		
Resistance Control	38	T	
Speed-load Curves	50, 55, 59, 63, 70, 72	Tandem Control	207
Starting Box	33	Teaser Control	85
Storey Motor	52	Temperature Rise	11, 277
Stow Mfg. Co.	68	Limit of	279
Voltage Variation-Speed	28	Tesla, N.	128, 165, 232
Ward-Leonard, H. Controls	74	Test Voltage	11, 275
Service, Intermittent	280	Thompson, M. E.	49
Siemens, Alex.	129	Thompson-Ryan Motor	49, 55
Single-phase Induction Motor (see <i>Induction Motor</i>).		Thomson, Prof. E.	130, 257
Slip	127, 169, 194, 232	Torque	15
Slip-ring Control	199	Tractive Effort	104
Slip-ring Rotors	174	Train Lines	113
Slip-ring Resistance	182, 201, 227	Types of Motors	4, 123
Speed Classifications	273	Types of Service	267
Speed Control of			
Induction Motors	204	V	
Repulsion Motors	263	V Curves	158
Series Motors	109, 255	Vector Diagrams	
Shunt Motors	38, 46, 68, 74	Induction Motor	184
Split Phase	127, 232	Repulsion Motor	260
Squirrel-cage Rotor	173	Series Motor	248
Standardization Rules	272	Shunt Motor	240
Starting		Synchronous Motor	142, 150
Box	33, 281	Voltage-speed	
Compound Motors	119	Induction Motor	182, 211
Induction Motors	194, 235	Repulsion Motor	263
Repulsion Motors	263	Series Motor	99, 253
		Shunt Motor	28, 74

INDEX

291

	Page		Page
Voltage Test	11, 275	Wilde, Prof.	125
Voltage-Torque	182, 266	Windings	
W			
Wagner Motor	235	Balancing	50, 58
Ward-Leonard, H.	76, 83	Compensation	48, 254, 259, 262
Westinghouse Series Motor	106	Double-armature	90
Wheels	105	Rotor	165, 173, 197
		Starting	232
		Stator	169

LIST OF WORKS
ON
ELECTRICAL SCIENCE

PUBLISHED AND FOR SALE BY

D. VAN NOSTRAND COMPANY,

23 Murray and 27 Warren Streets, New York.

* WRITE FOR COMPLETE 96 PAGE CATALOG, GRATIS

- ABBOTT, A. V. *The Electrical Transmission of Energy.* A Manual for the Design of Electrical Circuits. *Fifth Edition, enlarged and rewritten.* With many Diagrams, Engravings and Folding Plates. 8vo., cloth, 675 pp. Net, \$5.00
- ADDYMAN, F. T. *Practical X-Ray Work.* Illustrated. 8vo., cloth, 200 pp. Net, \$4.00
- ALEXANDER, J. H. *Elementary Electrical Engineering in Theory and Practice.* A class-book for junior and senior students and working electricians. Illustrated. 12mo., cloth, 208 pp. \$2.00
- ANDERSON, GEO. L. *Handbook for the Use of Electricians in the operation and care of Electrical Machinery and Apparatus of the United States Seacoast Defenses.* Prepared under the direction of Lieut.-General Commanding the Army. Illustrated. 8vo., cloth, 161 pp. \$3.00
- ARNOLD, E. *Armature Windings of Direct-Current Dynamos.* Extension and Application of a general Winding Rule. Translated from the original German by Francis B. DeGress. Illustrated. 8vo., cloth, 124 pp. \$2.00
- ASHE, SYDNEY W. *Electricity Experimentally and Practically Applied.* 422 illustrated. 12mo., cloth, 375 pp. Net, \$2.00
- ASHE, S. W., and KEILEY, J. D. *Electric Railways Theoretically and Practically Treated.* Illustrated. 12mo., cloth.
- Vol. I. *Rolling Stock. Second Edition.* 285 pp. Net, \$2.50
- Vol. II. *Substations and Distributing Systems.* 296 pp. Net, \$2.50

- ATKINSON, A. A. *Electrical and Magnetic Calculations.* For the use of Electrical Engineers and others interested in the Theory and Application of Electricity and Magnetism. *Third Edition, revised.* Illustrated. 8vo., cloth, 310 pp. Net, \$1.50
- ATKINSON, PHILIP. *The Elements of Dynamic Electricity and Magnetism.* *Fourth Edition.* Illustrated. 12mo., cloth, 405 pp. \$2.00
- Elements of Electric Lighting,* including Electric Generation, Measurement, Storage, and Distribution. *Tenth Edition,* fully revised and new matter added. Illustrated. 12mo., cloth, 280 pp. \$1.50
- Power Transmitted by Electricity and Applied by the Electric Motor,* including Electric Railway Construction. Illustrated. *Fourth Edition,* fully revised and new matter added. 12mo., cloth, 241 pp. \$2.00
- AYRTON, HERTHA. *The Electric Arc.* Illus. 8vo., cloth, 479 pp. Net \$5.00
- W. E. *Practical Electricity.* A Laboratory and Lecture Course. Illustrated. 12mo., cloth, 643 pp. \$2.00
- BAKER, J. T. *The Telegraphic Transmission of Photographs.* 63 illustrations. 12mo., cloth, 155 pp. Net, \$1.25
- BEDELL, FREDERICK. *Direct and Alternating Current Testing.* Assisted by C. A. Pierce. Illustrated. 8vo., cloth, 250 pp. Net, \$2.00
- BEDELL, F. & CREHORE, ALBERT C. *Alternating Currents.* An analytical and graphical treatment for students and engineers. *Fifth Edition.* 112 illustrations. 8vo., cloth, 325 pp. Net, \$2.50
- BLAINE, ROBERT G. *The Calculus and Its Applications.* A practical treatise for beginners especially engineering students. 79 illustrations. 12mo., cloth, 330 pp. Net \$1.50
- BIGGS, C. H. W. *First Principles of Electricity and Magnetism.* Illustrated. 12mo., cloth, 495 pp. \$2.00
- BONNEY, G. E. *The Electro-Plater's Hand Book.* A Manual for Amateurs and Young Students on Electro-Metallurgy. *Fourth Edition, enlarged.* 61 Illustrations. 12mo., cloth, 208 pp. \$1.20
- BOTTONE, S. R. *Magnetos For Automobilists, How Made and How Used.* A handbook of practical instruction on the manufacture and adaptation of the magneto to the needs of the motorist. *Second Edition, enlarged.* 52 Illustrations. 12mo., cloth, 188p pp. Net, \$1.00
- Electric Motors, How Made and How Used.* Illustrated. 12mo., cloth, 168 pp. 75 cents
- BOWKER, WM. R. *Dynamo, Motor, and Switchboard Circuits for Electrical Engineers:* A practical book dealing with the subject of direct, alternating, and polyphase circuits. *Second Edition, greatly enlarged.* 130 illustrations. 8vo., cloth, 180 pp. Net, \$2.50

- CARTER, E. T. Motive Power and Gearing for Electrical Machinery; a treatise on the theory and practice of the mechanical equipment of power stations for electric supply and for electric traction. *Second Edition, revised.* Illustrated. Svo., cloth, 700 pp. Net, \$5.00
- CHILD, CHAS. T. The How and Why of Electricity: a book of information for non-technical readers, treating of the properties of Electricity, and how it is generated, handled, controlled, measured, and set to work. Also explaining the operation of Electrical Apparatus. Illustrated. Svo., cloth, 140 pp. \$1 00
- CLARK, D. K. Tramways, Their Construction and Working. *Second Edition.* Illustrated. Svo., cloth, 758 pp. \$9.00
- COOPER, W. R. Primary Batteries: their Theory, Construction, and Use. 131 Illustrations. Svo., cloth, 324 pp. Net, \$4.00
- The Electrician Primers. Being a series of helpful primers on electrical subjects, for the use of students, pupils, artisans, and general readers. *Second Edition.* Illustrated. Three volumes in one. Svo., cloth, Net, \$5.00
- Vol. I.—Theory Net, \$2.00
- Vol. II.—Electric Traction, Lighting and Power. Net, \$3.00
- Vol. III.—Telegraphy, Telephony, etc. Net, \$2.00
- CROCKER, F. B. Electric Lighting. A Practical Exposition of the Art for the use of Electricians, Students, and others interested in the Installation or Operation of Electric-Lighting Plants.
- Vol. I.—The Generating Plant. *Sixth Edition, entirely revised.* Illustrated. Svo., cloth, 482 pp. \$3.00
- Vol. II.—Distributing System and Lamps. *Sixth Edition.* Illustrated. Svo., cloth, 505 pp. \$3.00
- and ARENDT, M. Electric Motors: Their Action, Control, and Application. 160 Illustrations. Svo., cloth, 296 pp. Net, 2.50
- and WHEELER, S. S. The Management of Electrical Machinery. Being a *thoroughly revised and rewritten edition* of the authors' "Practical Management of Dynamos and Motors." *Eighth Edition.* Illustrated. 16mo., cloth, 232 pp. Net, \$1.00
- CUSHING, H. C., Jr. Standard Wiring for Electric Light and Power. Illustrated. 16mo., leather, 156 pp. \$1.00
- DAVIES, F. H. Electric Power and Traction. Illustrated. Svo., cloth, 293 pp (Van Nostrand's Westminster Series.) Net, \$2.00
- DAWSON, PHILIP. Electric Traction on Railways. 610 Illustrations. Svo., half leather, 891 pp. Net, \$9.00
- DEL MAR, W. A. Electric Power Conductors. 69 illustrations. Svo., cloth, 330 pp. Net, \$2.00
- DINGER, Lieut. H. C. Handbook for the Care and Operation of Naval Machinery. *Second Edition.* Illustrated. 16mo., cloth, 302 pp. Net, \$2.00

- DYNAMIC ELECTRICITY**; Its Modern Use and Measurement, chiefly in its application to Electric Lighting and Telegraphy, including: 1. Some Points in Electric Lighting, by Dr. John Hopkinson. 2. On the Treatment of Electricity for Commercial Purposes, by J. N. Shoolbred. 3. Electric-Light Arithmetic, by R. E. Day, M.E. *Fourth Edition*. Illustrated. 16mo., boards, 166 pp. (No. 71 Van Nostrand's Science Series.) 50 cents
- EDGUMBE, K.** Industrial Electrical Measuring Instruments. Illustrated. 8vo., cloth, 227 pp. Net, \$2.50
- ERSKINE-MURRAY, J.** A Handbook of Wireless Telegraphy: Its Theory and Practice. For the use of electrical engineers, students, and operators. *Second Edition, revised and enlarged*. 180 illustrations. 8vo., cloth, 388 pp. Net, \$3.50
- Wireless Telephones and How they Work. Illustrated. 16mo., cloth, 75 pp. \$1.00
- EWING, J. A.** Magnetic Induction in Iron and other Metals. *Third Edition, revised*. Illustrated. 8vo., cloth, 393 pp. Net \$4.00
- FISHER, H. K. C., and DARBY, W. C.** Students' Guide to Submarine Cable Testing. *Third Edition, enlarged*. Illus. 8vo., cloth, 326 pp. Net, \$3.50
- FLEMING, J. A.** The Alternate-Current Transformer in Theory and Practice.
- Vol. I.: The Induction of Electric Currents. *Fifth Issue*. Illustrated. 8vo., cloth, 641 pp. Net, \$5.00
- Vol. II.: The Utilization of Induced Currents. *Third Issue*. Illustrated. 8vo., cloth, 587 pp. Net, \$5.00
- Handbook for the Electrical Laboratory and Testing Room. Two Volumes. Illustrated. 8vo., cloth, 1160 pp. Each vol. Net, \$5.00
- FOSTER, H. A.** With the Collaboration of Eminent Specialists. Electrical Engineers' Pocket Book. A handbook of useful data for Electricians and Electrical Engineers. With innumerable Tables, Diagrams, and Figures. The most complete book of its kind ever published, treating of the latest and best Practice in Electrical Engineering. *Fifth Edition, completely revised and enlarged*. Fully Illustrated. Pocket Size. Leather. Thumb Indexed. 1636 pp. \$5.00
- FOWLE, F. F.** The Protection of Railroads from Overhead Transmission Line Crossings. 35 illustrations. 12mo, cloth, 76 pp. Net, \$1.50
- GANT, L. W.** Elements of Electric Traction for Motormen and Others. Illustrated with Diagrams. 8vo., cloth, 217 pp. Net, \$2.50
- GERHARDI, C. H. W.** Electricity Meters; their Construction and Management. A practical manual for central station engineers, distribution engineers and students. Illustrated. 8vo., cloth, 337 pp. Net, \$4.00

- GORE, GEORGE. The Art of Electrolytic Separation of Metals (Theoretical and Practical). Illustrated. 8vo., cloth, 295 pp.....Net, \$3.50
- GRAY, J. Electrical Influence Machines: Their Historical Development and Modern Forms. With Instructions for making them. *Second Edition, revised and enlarged.* With 105 Figures and Diagrams. 12mo., cloth, 296 pp.....\$2.00
- GROTH, L. A. Welding and Cutting Metals by Aid of Gases or Electricity. 124 illustrations. 8vo., cloth, 280 pp..... Net, \$3.00
- HAMMER, W. J. Radium, and Other Radio-Active Substances; Polonium, Actinium, and Thorium. With a consideration of Phosphorescent and Fluorescent Substances, the properties and applications of Selenium, and the treatment of disease by the Ultra-Violet Light. With Engravings and Plates. 8vo., cloth, 72 pp.....\$1.00
- HARRISON, N. Electric Wiring Diagrams and Switchboards. Illustrated. 12mo., cloth, 272 pp.....\$1.50
- HASKINS, C. H. The Galvanometer and its Uses. A Manual for Electricians and Students. *Fifth Edition, revised.* Illus. 16mo., morocco, 75 pp..\$1.50
- HAY, ALFRED. Principles of Alternate-Current Working. *Second Edition.* Illustrated. 12mo., cloth, 390 pp.....\$2.00
- Alternating Currents; their theory, generation, and transformation. *Second Edition.* 1178 Illustrations. 8vo., cloth, 319 pp.....Net, \$2.50
- An Introductory Course of Continuous-Current Engineering. Illustrated. 8vo., cloth, 327 pp.....Net, \$2.50
- HEAVISIDE, O. Electromagnetic Theory. Two Volumes with Many Diagrams. 8vo., cloth, 1006 pp. Each vol.....Net, \$5.00
- HEDGES, K. Modern Lightning Conductors. An illustrated Supplement to the Report of the Research Committee of 1905, with notes as to methods of protection and specifications. Illustrated. 8vo., cloth, 119 pp..Net, \$3.00
- HOBART, H. M. Heavy Electrical Engineering. Illustrated. 8vo., cloth, 338 pp.....Net, \$4.50
- Electricity. A text-book designed in particular for engineering students. 115 illustrations. 43 tables. 8vo., cloth, 266 pp.....Net, \$2.00
- HOBBS, W. R. P. The Arithmetic of Electrical Measurements. With numerous examples, fully worked. *Twelfth Edition.* 12mo., cloth 126 pp...50 cents
- HOMANS, J. E. A B C of the Telephone. With 269 Illustrations. 12mo., cloth, 352 pp.....\$1.00
- HOPKINS, N. M. Experimental Electrochemistry, Theoretically and Practically Treated. Profusely illustrated with 130 new drawings, diagrams, and photographs, accompanied by a Bibliography. Illustrated. 8vo., cloth, 298 pp.....Net, \$3.00

- HOUSTON, EDWIN J. A Dictionary of Electrical Words, Terms, and Phrases. *Fourth Edition, rewritten and greatly enlarged.* 582 Illustrations. 4to., cloth. Net, \$7.00
- A Pocket Dictionary of Electrical Words, Terms, and Phrases. 12mo., cloth, 950 pp. Net, \$2.50
- HUTCHINSON, R. W., Jr. Long-Distance Electric Power Transmission: Being a Treatise on the Hydro-Electric Generation of Energy; Its Transformation, Transmission, and Distribution. *Second Edition.* Illustrated. 12mo., cloth, 350 pp. Net, \$3.00
- and IHLENG, M. C. Electricity in Mining. Being a theoretical and practical treatise on the construction, operation, and maintenance of electrical mining machinery. Illustrated. 12mo., cloth. *In Press*
- INCANDESCENT ELECTRIC LIGHTING. A Practical Description of the Edison System, by H. Latimer. To which is added: The Design and Operation of Incandescent Stations, by C. J. Field; A Description of the Edison Electrolyte Meter, by A. E. Kennelly; and a Paper on the Maximum Efficiency of Incandescent Lamps, by T. W. Howell. *Fifth Edition.* Illustrated. 16mo., cloth, 140 pp. (No. 57 Van Nostrand's Science Series.) . . . 50 cents
- INDUCTION COILS: How Made and How Used. *Eleventh Edition.* Illustrated. 16mo., cloth, 123 pp. (No. 53 Van Nostrand's Science Series.) . . . 50 cents
- JEHL, FRANCIS. The Manufacture of Carbons for Electric Lighting and Other Purposes. Illustrated. 8vo., cloth, 232 pp. Net, \$4.00
- JONES, HARRY C. The Electrical Nature of Matter and Radioactivity. *Second Edition, completely revised.* 12mo., cloth, 212 pp. \$2.00
- KAPP, GISBERT. Electric Transmission of Energy and its Transformation, Subdivision, and Distribution. A Practical Handbook. *Fourth Edition, thoroughly revised.* Illustrated. 12mo., cloth, 445 pp. \$3.50
- KAPP, GISBERT. Alternate-Current Machinery. Illustrated. 16mo., cloth, 190 pp. (No. 96 Van Nostrand's Science Series.) 50 cents
- Dynamos, Alternators, and Transformers. Illustrated. 8vo., cloth, 507 pp. \$4.00
- KELSEY, W. R. Continuous-Current Dynamos and Motors, and their Control; being a series of articles reprinted from the "Practical Engineer," and completed by W. R. Kelsey, B.Sc. With Tables, Figures, and Diagrams. 8vo., cloth, 439 pp. \$2.50
- KEMPE, H. R. A Handbook of Electrical Testing. *Seventh Edition, revised and enlarged.* 285 Illustrations. 8vo., cloth, 706 pp. . . . Net, \$6.00
- KENNEDY, R. Modern Engines and Power Generators. Illustrated. 4to., Electrical Installations of Electric Light, Power, and Traction Machinery. Illustrated. 8vo., cloth, 5 vols. The Set, \$15.00. Each, \$3.50

- KENNELLY, A. E. *Theoretical Elements of Electro-Dynamic Machinery.* Vol I. Illustrated. Svo., cloth, 90 pp. \$1.50
- KERSHAW, J. B. C. *The Electric Furnace in Iron and Steel Production.* Illustrated. Svo., cloth, 74 pp. Net, \$1.50
- Electrometallurgy.* Illustrated. Svo., cloth, 303 pp. (Van Nostrand's Westminster Series.) Net, \$2.00
- KINZBRUNNER, C. *Continuous-Current Armatures; their Winding and Construction.* 79 Illustrations. Svo., cloth, 80 pp. Net, \$1.50
- Alternate-Current Windings; their Theory and Construction.* 89 Illustrations. Svo., cloth, 80 pp. Net, \$1.50
- KOERTER, F. *Hydroelectric Developments and Engineering.* A practical and theoretical treatise on the development, design, construction, equipment and operation of hydroelectric transmission plants. 500 illustrations. 4to., cloth, 475 pp. Net, \$5.00
- *Steam-Electric Power Plants.* A practical treatise on the design of central light and power stations and their economical construction and operation. Fully Illustrated. 4to., cloth, 455 pp. Net, \$5.00
- LARNER, E. T. *The Principles of Alternating Currents for Students of Electrical Engineering.* Illustrated with Diagrams. 12mo., cloth, 144 pp. Net, \$1.50
- LEMSTROM, S. *Electricity in Agriculture and Horticulture.* Illustrated. Svo., cloth. Net, \$1.50
- LIVERMORE, V. P., and WILLIAMS, J. *How to Become a Competent Motorman:* Being a practical treatise on the proper method of operating a street-railway motor-car; also giving details how to overcome certain defects. *Second Edition.* Illustrated. 16mo., cloth, 247 pp. Net, \$1.00
- LOCKWOOD, T. D. *Electricity, Magnetism, and Electro-Telegraphy.* A Practical Guide and Handbook of General Information for Electrical Students, Operators, and Inspectors. *Fourth Edition.* Illustrated. Svo., cloth, 374 pp. \$2.50
- LODGE, OLIVER J. *Signalling Across Space Without Wires:* Being a description of the work of Hertz and his successors. *Fourth Edition.* Illustrated. Svo., cloth, 156 pp. Net, \$2.00
- LORING, A. E. *A Handbook of the Electro-Magnetic Telegraph.* *Fourth Edition, revised.* Illustrated. 16mo., cloth, 116 pp. (No. 39 Van Nostrand's Science Series.) 50 cents
- LUPTON, A. PARR, G. D. A., and PERKIN, H. *Electricity Applied to Mining.* *Second Edition.* With Tables, Diagrams, and Folding Plates. Svo., cloth, 320 pp. Net, \$4.50
- MAILLOUX, C. O. *Electric Traction Machinery.* Illustrated. Svo., cloth. *In Press*

- MANSFIELD, A. N.** Electromagnets: Their Design and Construction. *Second Edition*. Illustrated. 16mo., cloth, 155 pp. (Van Nostrand's Science Series No. 64.).....50 cents
- MASSIE, W. W., and UNDERHILL, C. R.** Wireless Telegraphy and Telephony Popularly Explained. Illustrated. 12mo., cloth, 82 pp.....Net, \$1.00
- MAURICE, W.** Electrical Blasting Apparatus and Explosives, with special reference to colliery practice. Illustrated. Svo., cloth, 167 pp.....Net, \$3.50
- MONCKTON, C. C. F.** Radio Telegraphy. 173 Illustrations. Svo., cloth, 272 pp. (Van Nostrand's Westminster Series.).....Net, \$2.00
- MORGAN, ALFRED P.** Wireless Telegraph Construction for Amateurs. 153 illustrations. 12mo., cloth, 220 pp.....Net, \$1.50
- NIPHER, FRANCIS E.** Theory of Magnetic Measurements. With an Appendix on the Method of Least Squares. Illustrated. 12mo., cloth, 94 pp...\$1.00
- NOLL, AUGUSTUS.** How to Wire Buildings. A Manual of the Art of Interior Wiring. *Fourth Edition*. Illustrated. 12mo., cloth, 165 pp.....\$1.50
- OHM, G. S.** The Galvanic Circuit Investigated Mathematically. Berlin, 1827. Translated by William Francis. With Preface and Notes by the Editor, Thos. D. Lockwood. *Second Edition*. Illustrated. 16mo., cloth, 269 pp. (No. 102 Van Nostrand's Science Series.).....50 cents
- OLSSON, ANDREW.** Motor Control as Used in Connection with Turret Turning and Gun Elevating (The Ward Leonard System.) 13 illustrations. 12mo., paper, 27 pp. (U. S. Navy Electrical Series No. 1.).....Net, .50
- ODIN, MAURICE A.** Standard Polyphase Apparatus and Systems. Illustrated with many Photo-reproductions, Diagrams, and Tables. *Fifth Edition, revised*. Svo., cloth, 369 pp.....Net, \$3.00
- PALAZ, A.** Treatise on Industrial Photometry. Specially applied to Electric Lighting. Translated from the French by G. W. Patterson, Jr., Assistant Professor of Physics in the University of Michigan, and M. R. Patterson, B.A. *Second Edition*. Fully Illustrated. Svo., cloth, 324 pp.....\$4.00
- PARR, G. D. A.** Electrical Engineering Measuring Instruments for Commercial and Laboratory Purposes. With 370 Diagrams and Engravings. Svo., cloth, 328 pp.....Net, \$3.50
- PARSHALL, H. F., and HOBART, H. M.** Armature Windings of Electric Machines. *Third Edition*. With 140 full-page Plates, 65 Tables, and 165 pages of descriptive letter-press. 4to., cloth, 300 pp.....\$7.50
- Electric Railway Engineering.** With 437 Figures and Diagrams and many Tables. 4to., cloth, 475 pp.....Net, \$10.00
- Electric Machine Design.** Being a revised and enlarged edition of "Electric Generators." 648 Illustrations. 4to, half morocco, 601 pp....Net, \$12.50

- PERRINE, F. A. C. **Conductors for Electrical Distribution: Their Manufacture and Materials, the Calculation of Circuits, Pole-Line Construction, Underground Working, and other Uses.** *Second Edition.* Illustrated. 8vo., cloth, 287 pp. Net, \$3.50
- POPE, F. L. **Modern Practice of the Electric Telegraph.** A Handbook for Electricians and Operators. *Seventeenth Edition.* Illustrated. 8vo., cloth, 234 pp. \$1.50
- RAPHAEL, F. C. **Localization of Faults in Electric-Light Mains.** *Second Edition, revised.* Illustrated. 8vo., cloth, 205 pp. Net, \$3.00
- RAYMOND, E. B. **Alternating-Current Engineering, Practically Treated.** *Third Edition, revised.* With many Figures and Diagrams. 8vo., cloth, 244 pp., Net, \$2.50
- RICHARDSON, S. S. **Magnetism and Electricity and the Principles of Electrical Measurement.** 254 illustrations. 12mo., cloth, 604 pp. Net, \$2.00
- ROBERTS, J. **Laboratory Work in Electrical Engineering—Preliminary Grade.** A series of laboratory experiments for first- and second-year students in electrical engineering. Illustrated with many Diagrams. 8vo., cloth, 218 pp. Net, \$2.00
- RUHMER, ERNST. **Wireless Telephony in Theory and Practice.** Translated from the German by James Erskine-Murray. Illustrated. 8vo., cloth, 224 pp. Net, \$3.50
- RUSSELL, A. **The Theory of Electric Cables and Networks.** 71 Illustrations. 8vo., cloth, 275 pp. Net, \$3.00
- SALOMONS, DAVID. **Electric-Light Installations.** A Practical Handbook. Illustrated. 12mo., cloth.
- Vol I.: **Management of Accumulators.** *Ninth Edition.* 178 pp. \$2.50
- Vol. II.: **Apparatus.** *Seventh Edition.* 318 pp. \$2.25
- Vol. III.: **Application.** *Seventh Edition.* 234 pp. \$1.50
- SEVER, G. F. **Electrical Engineering Experiments and Tests on Direct-Current Machinery.** *Second Edition, enlarged.* With Diagrams and Figures. 8vo., pamphlet, 75 pp. Net, \$1.00
- and TOWNSEND, F. **Laboratory and Factory Tests in Electrical Engineering.** *Second Edition.* Illustrated. 8vo., cloth, 269 pp. Net, \$2.50
- SEWALL, C. H. **Wireless Telegraphy.** With Diagrams and Figures. *Second Edition, corrected.* Illustrated. 8vo., cloth, 229 pp. Net, \$2.00
- Lessons in Telegraphy.** Illustrated. 12mo., cloth, 104 pp. Net, \$1.00
- T. **Elements of Electrical Engineering.** *Third Edition, revised.* Illustrated. 8vo., cloth, 444 pp. \$3.00
- The Construction of Dynamos (Alternating and Direct Current).** A Text-book for students, engineering contractors, and electricians-in-charge. Illustrated. 8vo., cloth, 316 pp. \$3.00

- SHELDON, S., and HAUSMANN, E. **Dynamo-Electric Machinery: Its Construction, Design, and Operation.**
 Vol. I.: **Direct-Current Machines.** *Eighth Edition, completely rewritten.*
 Illustrated. 8vo., cloth, 281 pp.....Net, \$2.50
- and MASON, H. **Alternating-Current Machines: Being the second volume of "Dynamo-Electric Machinery; its Construction, Design, and Operation."** With many Diagrams and Figures. (Binding uniform with Volume I.) *Seventh Edition, rewritten.* 8vo., cloth; 353 pp.....Net, \$2.50
- SLOANE, T. O'CONNOR. **Standard Electrical Dictionary.** 300 Illustrations. 12mo., cloth, 682 pp.....\$3.00
- Elementary Electrical Calculations.** A Manual of Simple Engineering Mathematics, covering the whole field of Direct Current Calculations, the basis of Alternating Current Mathematics, Networks, and typical cases of Circuits, with Appendices on special subjects. 8vo., cloth. Illustrated. 304 pp.....Net, \$2.00
- SNELL, ALBION T. **Electric Motive Power.** The Transmission and Distribution of Electric Power by Continuous and Alternating Currents. With a Section on the Applications of Electricity to Mining Work. *Second Edition.* Illustrated. 8vo., cloth, 411 pp... ..Net, \$4.00
- SODDY, F. **Radio-Activity; an Elementary Treatise from the Standpoint of the Disintegration Theory.** Fully Illustrated. 8vo., cloth, 214 pp..Net, \$3.00
- SOLOMON, MAURICE. **Electric Lamps.** Illustrated. 8vo., cloth. (Van Nostrand's Westminster Series.).....Net, \$2.00
- STEWART, A. **Modern Polyphase Machinery.** Illustrated. 12mo., cloth, 296 pp.....Net, \$2.00
- SWINBURNE, JAS., and WORDINGHAM, C. H. **The Measurement of Electric Currents.** Electrical Measuring Instruments. Meters for Electrical Energy. Edited, with Preface, by T. Commerford Martin. Folding Plate and Numerous Illustrations. 16mo., cloth, 241 pp. (No. 109 Van Nostrand's Science Series.).....50 cents
- SWOOPE, C. WALTON. **Lessons in Practical Electricity: Principles, Experiments, and Arithmetical Problems.** An Elementary Text-book. *Eleventh Edition, enlarged with a chapter on alternating currents.* 404 illustrations. 12mo., cloth, 507 pp.....Net, \$2.00
- THOM, C., and JONES, W. H. **Telegraphic Connections, embracing recent methods in Quadruplex Telegraphy.** 20 Colored Plates. 8vo., cloth, 59 pp..\$1.50
- THOMPSON, S. P., Prof. **Dynamo-Electric Machinery.** With an Introduction and Notes by Frank L. Pope and H. R. Butler. Fully Illustrated. 16mo., cloth, 214 pp. (No. 66 Van Nostrand's Science Series.).....50 cents
- Recent Progress in Dynamo-Electric Machines.** Being a Supplement to "Dynamo-Electric Machinery." Illustrated. 16mo., cloth, 113 pp. (No. 75 Van Nostrand's Science Series.).....50 cents

- TOWNSEND, FITZHUGH. Alternating Current Engineering. Illustrated. 8vo., paper, 32 pp.....Net, 75 cents
- UNDERHILL, C. R. Solenoids, Electromagnets and Electromagnetic Windings. 218 Illustrations. 12mo., cloth, 345 pp.....Net, \$2.00
- URQUHART, J. W. Dynamo Construction. A Practical Handbook for the use of Engineer Constructors and Electricians in Charge. Illustrated. 12mo., cloth.....\$3.00
- Electric Ship-Lighting. A Handbook on the Practical Fitting and Running of Ship's Electrical Plant, for the use of Ship Owners and Builders, Marine Electricians, and Sea-going Engineers in Charge. 88 Illustrations. 12mo., cloth, 308 pp.....\$3.00
- Electric-Light Fitting. A Handbook for Working Electrical Engineers, embodying Practical Notes on Installation Management. *Second Edition*. With numerous Illustrations. 12mo., cloth.....\$2.00
- Electroplating. *Fifth Edition*. Illustrated. 12mo., cloth, 230 pp.....\$2.00
- Electrotyping. Illustrated. 12mo., cloth, 228 pp.....\$2.00
- WADE, E. J. Secondary Batteries: Their Theory, Construction, and Use. *Second Edition, corrected*. 265 illustrations. 8vo, cloth, 501 pp.....Net, \$4.00
- WADSWORTH, C. Electric Ignition. 15 Illustrations. 16mo. paper. *In Press*
- WALKER, FREDERICK. Practical Dynamo-Building for Amateurs. How to Wind for any Output. *Third Edition*. Illustrated. 16mo., cloth, 104 pp. (No. 98 Van Nostrand's Science Series.).....50 cents
- SYDNEY F. Electricity in Homes and Workshops. A Practical Treatise on Auxiliary Electrical Apparatus. *Fourth Edition*. Illustrated. 12mo., cloth, 358 pp.....\$2.00
- Electricity in Mining. Illustrated. 8vo., cloth, 385 pp.....\$3.50
- WALLING, B. T., Lieut.-Com. U.S.N., and MARTIN, JULIUS. Electrical Installations of the United States Navy. With many Diagrams and Engravings. 8vo., cloth, 648 pp.....\$6.00
- WATT, ALEXANDER. Electroplating and Refining of Metals. *New Edition*, rewritten by Arnold Philip. Illustrated. 8vo., cloth, 677 pp..Net, \$4.50
- Electro-Metallurgy. *Fifteenth Edition*. Illustrated. 12mo., cloth, 225 pp., \$1.00
- WEBB, H. L. A Practical Guide to the Testing of Insulated Wires and Cables. *Fifth Edition*. Illustrated. 12mo., cloth, 118 pp.....\$1.00
- WEEKS, R. W. The Design of Alternate-Current Transformer. *New Edition in Press*

- WEYMOUTH, F. MARTEN.** Drum Armatures and Commutators. (Theory and Practice.) A complete treatise on the theory and construction of drum-winding, and of commutators for closed-coil armatures, together with a full résumé of some of the principal points involved in their design, and an exposition of armature reactions and sparking. Illustrated. 8vo., cloth, 295 pp.....Net, \$3.00
- WILKINSON, H. D.** Submarine Cable-Laying, Repairing, and Testing. *New Edition.* Illustrated. 8vo., cloth.....*In Press*
- YOUNG, J. ELTON.** Electrical Testing for Telegraph Engineers. Illustrated. 8vo., cloth, 264 pp... ..Net, \$4.00
- ZEIDLER, J. and LUSTGARTEN, J.** Electric Arc Lamps. Their principles, construction and working. 160 illustrations. 8vo., cloth, 200 pp... ..Net, \$2.00



A 96-page Catalog of Books on Electricity, classified by subjects, will be furnished gratis, postage prepaid, on application.

UNIVERSITY OF CALIFORNIA LIBRARY
BERKELEY

Return to desk from which borrowed.
This book is DUE on the last date stamped below.

ENGINEERING LIBRARY

OCT 28 1949

M

NOV 16 1949

R

APR 6 1950

Rd

DEC 5 1951

v

U.C. BERKELEY LIBRARIES



C039746811

789478

TK 2511

C8

**U. C. BERKELEY
ENGINEERING LIBRARY**

Engineering
Library

UNIVERSITY OF CALIFORNIA LIBRARY

