



This is a digital copy of a book that was preserved for generations on library shelves before it was carefully scanned by Google as part of a project to make the world's books discoverable online.

It has survived long enough for the copyright to expire and the book to enter the public domain. A public domain book is one that was never subject to copyright or whose legal copyright term has expired. Whether a book is in the public domain may vary country to country. Public domain books are our gateways to the past, representing a wealth of history, culture and knowledge that's often difficult to discover.

Marks, notations and other marginalia present in the original volume will appear in this file - a reminder of this book's long journey from the publisher to a library and finally to you.

Usage guidelines



Google is proud to partner with libraries to digitize public domain materials and make them widely accessible. Public domain books belong to the public and we are merely their custodians. Nevertheless, this work is expensive, so in order to keep providing this resource, we have taken steps to prevent abuse by commercial parties, including placing technical restrictions on automated querying.

We also ask that you:

- + *Make non-commercial use of the files* We designed Google Book Search for use by individuals, and we request that you use these files for personal, non-commercial purposes.
- + *Refrain from automated querying* Do not send automated queries of any sort to Google's system: If you are conducting research on machine translation, optical character recognition or other areas where access to a large amount of text is helpful, please contact us. We encourage the use of public domain materials for these purposes and may be able to help.
- + *Maintain attribution* The Google "watermark" you see on each file is essential for informing people about this project and helping them find additional materials through Google Book Search. Please do not remove it.
- + *Keep it legal* Whatever your use, remember that you are responsible for ensuring that what you are doing is legal. Do not assume that just because we believe a book is in the public domain for users in the United States, that the work is also in the public domain for users in other countries. Whether a book is still in copyright varies from country to country, and we can't offer guidance on whether any specific use of any specific book is allowed. Please do not assume that a book's appearance in Google Book Search means it can be used in any manner anywhere in the world. Copyright infringement liability can be quite severe.

About Google Book Search

Google's mission is to organize the world's information and to make it universally accessible and useful. Google Book Search helps readers discover the world's books while helping authors and publishers reach new audiences. You can search through the full text of this book on the web at <http://books.google.com/>



Library
of the
University of Wisconsin

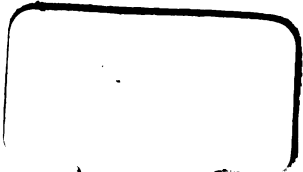

416 N FRANCES. 3

6-0722



ELECTROLYTIC DEPOSITION
AND
HYDROMETALLURGY OF ZINC



McGraw-Hill Book Co. Inc.

PUBLISHERS OF BOOKS FOR

Coal Age ▽ Electric Railway Journal
Electrical World ▽ Engineering News-Record
American Machinist ▽ Ingeniería Internacional
Engineering & Mining Journal ▽ Power
Chemical & Metallurgical Engineering
Electrical Merchandising

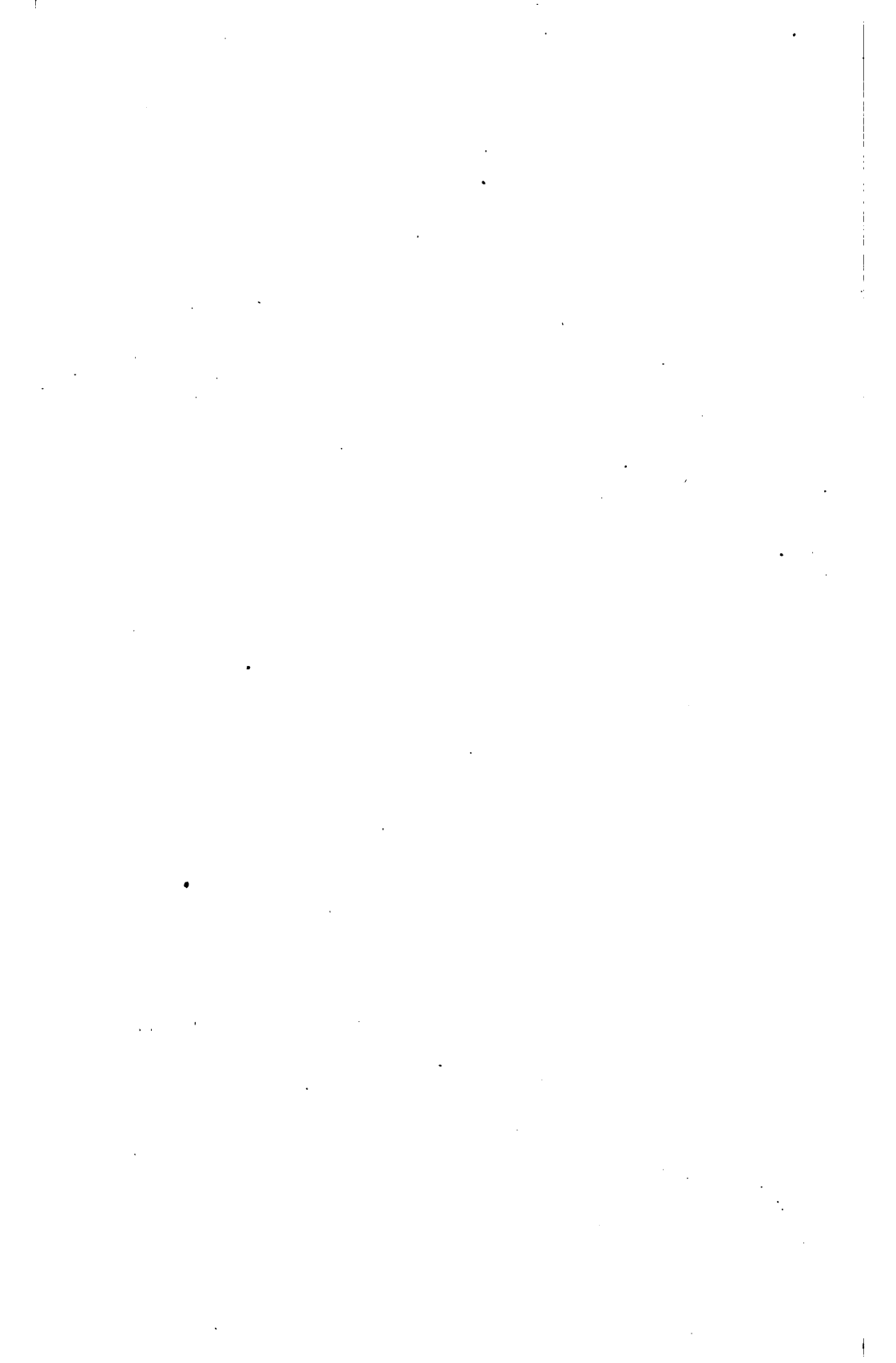



Cell Room in Zinc Plant at Great Falls, Montana

FRONTSPICE

ELECTROLYTIC DEPOSITION
AND
HYDROMETALLURGY OF ZINC

BY

OLIVER C. RALSTON

METALLURGIST, HOOKER ELECTROCHEMICAL CO., NIAGARA FALLS, N. Y.

FIRST EDITION

McGRAW-HILL BOOK COMPANY, Inc.

NEW YORK: 370 SEVENTH AVENUE

LONDON: 6 & 8 BOUVERIE ST., E. C. 4

1921

COPYRIGHT, 1921, BY THE
MCGRAW-HILL BOOK COMPANY, INC.

THE MAPLE PRESS YORK PA

242148
FEB - 8 1921

MKR
R13

6011806

PREFACE

The stage of development of hydrometallurgic zinc processes is hardly enough to justify an extensive book on the subject but they are now sufficiently standardized to call for a simple text, setting forth present practice and especially the underlying theory of leaching, purification and electrolysis on which they are all founded. Ever since 1880 serious attempts to commercialize hydrometallurgic processes for recovering zinc have been made and the theories of leaching and electrolysis have been well worked out but no one recognized the immense importance of purification of the solutions before electrolysis. This phase of the subject has needed exposition and it is with this particularly in mind that the present book has been written.

O. C. R.

SEATTLE, WASH.
October 15, 1920.

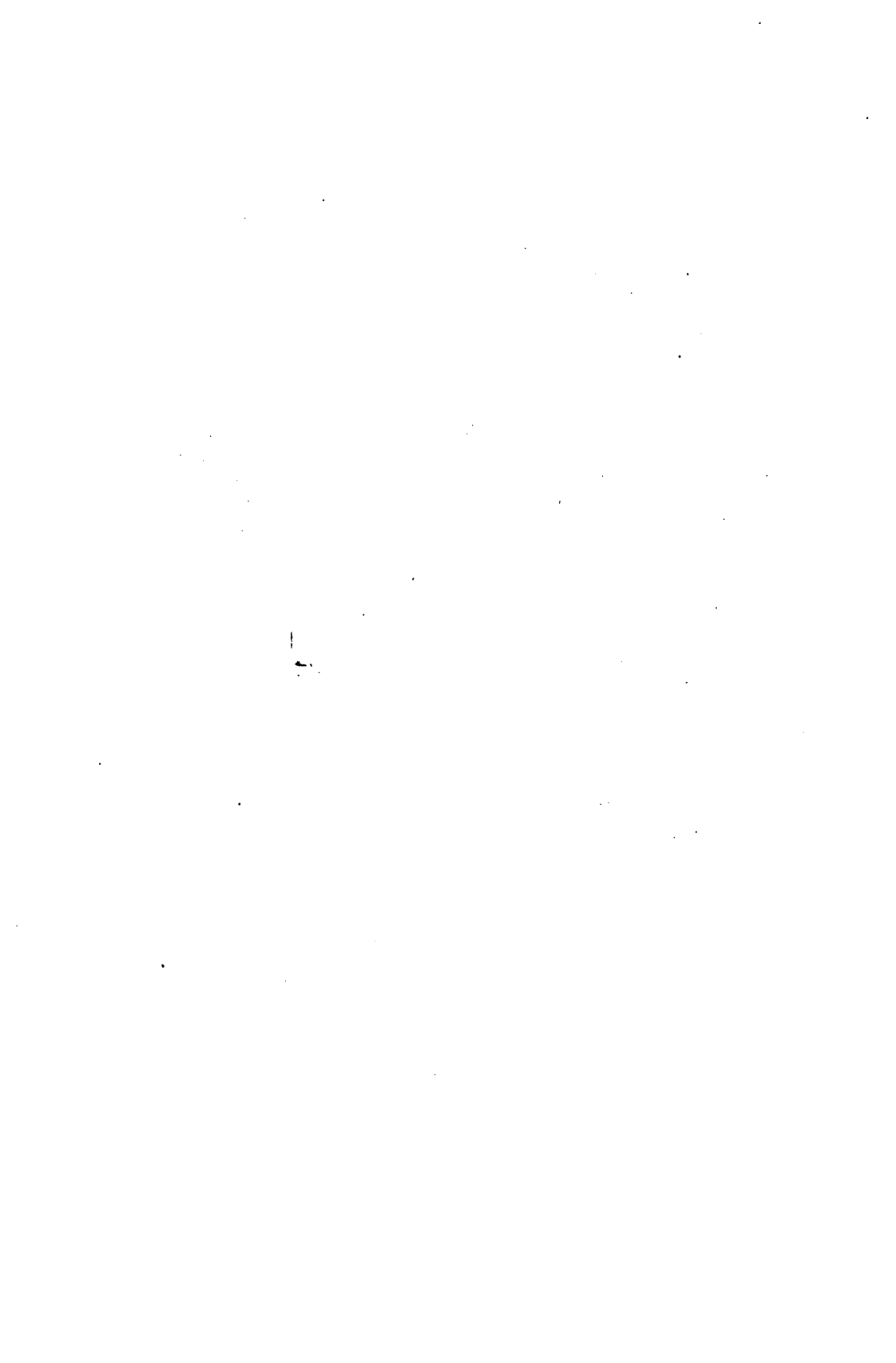

TABLE OF CONTENTS

CHAPTER	Page
I. INTRODUCTION	1
II. HISTORY OF ZINC HYDROMETALLURGY	11
III. ROASTING ZINC ORES	24
IV. SULPHATE SOLUTIONS, LEACHING AND PURIFYING	40
V. ELECTROLYSIS OF ZINC SULPHATE SOLUTIONS.	74
VI. CHLORINATING ZINC ORES AND PURIFYING SOLUTIONS	111
VII. ELECTROLYSIS OF ZINC CHLORIDE.	124
VIII. ELECTROLYTIC ZINC REFINING	144
IX. MELTING ELECTROLYTIC ZINC	154
X. EXAMPLES OF PRACTICE	160
XI. ZINC CHEMICALS	182
XII. ECONOMICS IN ZINC HYDROMETALLURGY	189
INDEX	195



ELECTROLYTIC DEPOSITION

AND

HYDROMETALLURGY OF ZINC

CHAPTER I

INTRODUCTION

The hydrometallurgy of zinc consists in the preparation of metallic zinc or its compounds through the medium of aqueous solutions of zinc compounds prepared from zinc ores or other zinc products.¹ The most widely practiced hydrometallurgy of zinc is the process of dissolving zinc from its ores by proper chemical reagents, followed by electrolytic recovery of the dissolved zinc. Zinc may also be electrolytically refined by using anodes of impure zinc in proper solutions. Further, zinc is used by the electroplater for "wet galvanizing" various articles in order to prevent their corroding. In addition, zinc chloride, zinc sulphate, zinc oxide, lithopone and similar products are prepared in part by hydrometallurgic methods.

The hydrometallurgy of gold and silver has existed for many years in the chlorination and cyanide processes and likewise copper has been leached from its ores for many years. The methods of hydrometallurgy have not always been nice or attractive and the late Anton Eillers was doubtless right when he spoke in a disgusted tone of all wet methods of extracting metals as being such a "schweinerei" (beastly, or pig-like mess.) Slops and smells are always likely to be met in a hydrometallurgic plant but experience in thousands of cyanide mills developed leaching machinery

¹This definition of hydrometallurgy differs somewhat from the commonly accepted sense of the term in that "hydrometallurgy" usually has meant lixiviation and chemical precipitation of a metal.

and practice to such a point that wet methods of extracting metals have become highly efficient and very often quite simple. Agitators, classifiers, ball-mills, thickeners, filters, clarifiers and similar machines have been so perfected in the cyanide processes that they have found very quick success in the hydrometallurgy of copper and of zinc in recent years.

The most outstanding success in the hydrometallurgy of zinc is the sulphuric acid extraction and electrolysis method adopted by the Anaconda Copper Co., in Montana, where the largest plant using any hydrometallurgic process for zinc is located. Briefly, this process, which is now in use in many other smaller plants, consists in roasting a complex zinc sulphide ore in order to form zinc oxide and zinc sulphate in varying proportions, followed by treatment of the ore with a dilute sulphuric acid solution. This dissolves the zinc as zinc sulphate, together with some of the other constituents of the ore. The solution is then purified and the pure solution submitted to electrolysis in tanks with sheet lead anodes and sheet aluminum cathodes. The zinc is deposited in a thin layer on the aluminum sheets and the sulphuric acid is regenerated by virtue of the fact that the lead anodes are insoluble in sulphuric acid. The sulphuric acid solution can be reused in the leaching of more roasted ore.

A number of less well-known processes use solutions of zinc chloride in a similar manner, preparing them by various methods, such as, dissolving roasted zinc ore or zinc oxide in muriatic acid, or by treating unroasted zinc sulphide ore with chlorine gas. In the electrolysis of zinc chloride solutions carbon anodes must be used and the chlorine gas liberated must be collected and used.

While the hydrometallurgy of zinc has been practiced for over twenty years, not enough was generally known about working details of the processes used until the Anaconda metallurgists attacked the problem of treating the complex zinc sulphide ores of Butte, Montana, in 1914. With characteristic progressiveness and efficiency the technical staff of this company developed their present process. Their

process can hardly be called new,—in that most of the chemical methods applied had long before been proposed or even used,—but they made a distinct contribution in combining the best methods previously known with a few discoveries and in adapting them to commercial work on a large scale. In addition, a liberal management permitted the information acquired by this remarkable staff to be disseminated, thus encouraging others to further develop the process. Practically simultaneously the metallurgists of the Consolidated Mining & Smelting Co., at Trail, British Columbia, worked out the same process for their ores. In fact, they started six months earlier.

Zinc is at present extracted from its ores by three principal methods: fuel smelting, electric smelting and hydrometallurgical treatment. The smelting of ores by the standard fuel distillation process is admittedly awkward and expensive. Nevertheless, the bulk of the zinc used throughout the world is produced by this method. It seems strange that zinc ores should still be smelted on the scale that they are. The ore is placed by hand in little retorts, each capable of holding only about sixty pounds of ore and these retorts are then heated externally to a temperature which causes them to fail in from twenty to forty days, but which is nevertheless necessary in order to distill the zinc from the ore. The consciousness that this "one-horse" method still rules has spurred inventors to devise electric smelting of zinc and also hydrometallurgy of zinc, the former of which has been successful only in Norway and the latter successful only under special conditions.

Electric furnaces for reducing and distilling zinc from its ores have been tested or even put into practice in a number of places but the condensation of zinc vapor into liquid zinc which can be cast into ingots has presented so many problems that electric furnaces are not popular. At present several inventors seem to be mastering this difficulty—at least partly—and it is possible that this method of treating zinc ores will become more useful.

Hydrometallurgic methods likewise suffered from serious difficulties for a long time, but the adaptation of cyanide machinery allowed the mechanical solution of many of the troubles encountered. Then, too, the realization of the necessity to purify the zinc solutions to an extent previously unattained in the treatment of any other metal helped clear the way for a successful hydro-metallurgy of zinc. Many complex sulphide ores containing zinc, lead, silver, copper and gold have been marketed for years with a seemingly large economic margin between what is actually paid for the ores and the gross value of the constituent metals if they could be simply and cheaply separated and recovered. The possibilities of profit led to a quick application of leaching methods by many other companies who followed the lead of the Anaconda Copper Co. Not only were complex ores in large quantities made available for profitable exploitation, but an increase in the extraction of the zinc seemed possible as compared with the old smelting methods. Another very important advantage possessed by hydrometallurgic methods was that flotation concentrates could be leached easily, whereas the pyrometallurgist has some difficulty in treating this type of material.

It was very soon discovered that hydrometallurgy had its limitations. The electrolytic deposition of zinc consumes more energy than the deposition of almost any other major metal. An ampere-hour deposits almost as much zinc as it does copper, but a higher voltage is necessary so that the energy consumption is practically twice what it is in the electrolysis of copper solutions. Further, a pound of zinc is worth only one-third as much as a pound of copper, so it is easily understood that as long as the commercial recovery of copper by hydrometallurgic methods was not an undisputed success, zinc hydrometallurgy has met opposition. It is now very well understood that a wet process of zinc extraction must be located at a source of very cheap power or else of very cheap zinc. Note the placing of electrolytic zinc plants at Great Falls, Montana, Keokuk Dam, Iowa, and Hobart,

Tasmania. All of these places are at sources of cheap electric power and the zinc ore is shipped to them.

It has also been found that certain ores can not be leached successfully by the present standard methods. Most of the naturally oxidized ores of zinc contain enough zinc silicate to form a silicic acid jelly when leached with sulphuric acid. This jelly causes such serious difficulties in filtering and handling the solutions that these ores are not treated. Some of the zinc-iron sulphide ores are also ill-adapted to wet methods for the reason that part of the zinc and iron sulphides are in "solid solution" in each other in the form of a mineral called marmetite, and when this mineral is roasted the zinc and iron oxides combine to form a compound known as zinc ferrite, which is insoluble in dilute solutions of sulphuric acid. Further, some of the zinc sulphide ores contain such large amounts of antimony and arsenic that they are treated by wet methods only by exercising most painstaking purification of the solutions and even then commercial operation is precarious. Other impurities cause similar difficulties.

The necessity for cheap power is fundamental but the trouble with ferrites and with impurities will doubtless find more or less complete solution with advances in the art. For instance, the chlorides of antimony and arsenic are so very volatile that chlorination methods will probably greatly assist in solving the impurities problem. Likewise, direct chlorination of high-iron sulphide ores is not hindered by formation of zinc ferrites.

The best zinc mineral for present commercial wet processes is the sulphide of zinc, sphalerite. If the zinc is present in the ore in the form of clean sphalerite without any iron sulphide in solid solution, or without the zinc sulphide and iron sulphide too intimately crystallized, the formation of ferrite during roasting is not to be feared. Marmatite is to be avoided unless direct chlorination of the unroasted sulphide is practiced.

Hydrozincite (the basic hydrous carbonate of zinc),

smithsonite (the normal carbonate), and zincite (the oxide of zinc) are all well adapted to hydrometallurgy but are usually accompanied by silicates of zinc which cause the troubles mentioned above. The silicates of zinc, calamine, willemite and similar compounds must be treated with strong sulphuric acid and the ore then heated to high enough a temperature to dessicate and destroy silicic acid jels before they can be successfully treated by the standard processes.

It is therefore necessary for a wet zinc extraction plant to choose its ores rather carefully in order that it may operate successfully. In fact, it is almost necessary to use a special purification of solutions for each different ore encountered. For instance, the methods which worked so well at Anaconda did not prove satisfactory when applied to the Broken Hill ore at Hobart, Tasmania. After long search it was found that this was due to traces of cobalt in these ores and methods had to be developed by which the cobalt could be removed from the solutions. At the present time there is no assurance that a custom plant located at any source of cheap power and buying ore from all sources could operate successfully by present hydrometallurgic methods. The present day art demands the building of plants adapted to treat ores from one mine or district only.

The following table gives the data about the more important plants which are now in operation or have recently been in operation making electrolytic zinc. The list is admittedly incomplete, especially for countries other than the United States. Wet galvanizing plants, lithopone and similar plants are also excluded from the list.

TABLE I. ELECTROLYTIC ZINC PLANTS OF THE WORLD

Company	Location	Daily Tons Zinc	Remarks
American Smelting & Refining Co.....	Murray, Utah.	Experimental.	Operated in 1916.
American Smelting & Refining Co.....	Omaha, Nebraska.	Experimental.	Treated zinc crusts.
Anaconda Copper Co.....	Anaconda, Montana.	25-ton experimental.	Operated 1915-1916.
Anaconda Copper Co.....	Great Falls, Montana.	150 tons.	Built in 1916.
Basin Salvage Co.....	Basin, Montana.	Experimental.	Operated in 1907. Remodeled in 1916.
Bully Hill Copper Co.....	Bully Hill, California.	Experimental.	Operated 1915-1919.
Chas. Butters.....	San Francisco, California.	3-ton experimental.	Built 1918.
Electrolytic Zinc Co.....	Baltimore, Maryland.	10 tons.	Dismantled 1919.
Judge Mining & Smelting Co.....	Park City, Utah.	7 tons.	Built 1916-1917.
Mammoth Copper Mg. Co.	Kennett, California.	25 tons.	Operated 1917-1919.
Northwestern Metals Co...	Helena, Montana.	Experimental.	Operated 1913-1914.
Reed Zinc Co.....	Palo Alto, California.	Experimental.	Operated 1914-1915.
River Smelting & Refining Co.....	Keokuk, Iowa.	10 tons.	Operated 1916-1919. Dismantled 1919.
Tennessee Copper Co.....	Copperhill, Tennessee.	Experimental.	Operated 1917.
Western Chemical Co.....	Denver, Colorado.	10 tons.	Built in 1918.
Consolidated Mining & Smelting Co.....	Trail, B. C., Canada.	50-75 tons.	First unit 1914.
French Zinc Co.....	Nelson, British Columbia.	Experimental.	Built 1916-1919.
Weedon Mining Co.....	Welland, Ontario.	Experimental.	Operated 1915.
Brunner, Mond & Co.....	Winnington, England.	5 tons.	Operated 20 years.
British Electrolytic Zinc Co.	Widnes, Lancashire, England.	Experimental.	Test Isherwood process.
British Metals Extraction Co.....	Llansamlet, Wales.	25-ton experimental.	Bisulphite process, not electrolytic.
Electrolytic Zinc Co. of Australasia.....	Hobart, Tasmania.	15 tons.	Operated 1917-1919. Expanding to 100 tons.
Tasmanian Metals Extraction Co.....	Mt. Read, Tasmania.	Experimental.	Abandoned 1915.
Takada & Co.....	Japan.	2 tons.	Operated 1917-date.
Mitsui & Co.....	Nagasaki, Japan.	Experimental.	Operating 1919.
Anon.....	Duisburg, Germany.	Commercial.	Dieffenbach process.
Anon.....	Hruschau, Austria.	Commercial.	Hoepfner process.
Anon.....	Finland.	1 ton.	Borchgrevink process.

From this list it can be estimated that the total capacity of electrolytic zinc plants soon to be in operation all over the world is about 300 tons daily or about 110,000 tons per annum. The total consumption of zinc in 1920 should be about 1,200,000 short tons, of which nearly half should come from the United States and more than half of the electrolytic zinc capacity is in the United States. These figures show that about 10 per cent of the total world production of zinc will soon be made by hydrometallurgy. Present indications are that this figure will not be exceeded for at least five years and probably ten. This production had not been attained up to the end of 1918, but only the capacity for producing a total of 110,000 tons per annum had been built or authorized. The actual United States production for the last four years was as follows:

1915.	252 tons.
1916.	10,229 tons.
1917.	27,245 tons.
1918.	38,885 tons.
1919.	27,056 tons.

The zinc obtained by smelting in the United States during the last three years was as follows:

1916.	611,141 tons.
1917.	643,424 tons.
1918.	478,888 tons.
1919.	465,743 tons.

As to the special uses of electrolytic zinc, its high purity led to its use in cartridge brass during the war, although the army specifications were finally lowered to allow use of some of the less pure grades of zinc for this purpose. This change of specifications did not result in the production of much poor brass and it is probable that the old ideas on the effect of cadmium on brass are forever exploded.

Zinc, or spelter, was classified into the following four grades for many years, this classification having received the sanction of the American Society for Testing Materials in 1911:

1000
22
2200.0

INTRODUCTION

TABLE II

Grade	Lead, Per Cent	Iron, Per Cent	Cadmium, Per Cent	Total, Not Over
A. High grade.....	0.07	0.03	0.05	0.10
B. Intermediate.....	0.20	0.03	0.05	0.50
C. Brass Special.....	0.75	0.04	0.75	1.20
D. Prime Western.....	1.50	0.08

During the World War the demand for high-grade zinc became so great that the ancient specifications of the Ordnance Department of the United States Army were modified to the following:

TABLE III

	Grade A, Per Cent	Grade B, Per Cent	Grade C, Per Cent
Zinc, minimum.....	99.85	99.35	98.00
Cadmium, maximum.....	0.05	0.50	0.75
Iron, maximum.....	0.03	0.03	0.08
Lead, maximum.....	0.07	0.20	1.00
Other elements.....	None	None	Trace

The principal change was in lowering the total zinc content of "High Grade" from 99.90 per cent to 99.85 per cent. On the large scale it had been found difficult to make electrolytic zinc containing 99.90 per cent of zinc, although it was quite easy to make zinc with 99.83 to 99.85 per cent zinc and the change of specifications made practically all of the electrolytic zinc fall in the Grade A class.

The war also brought to the attention of brass manufacturers the desirability of using high-grade zinc and it is to be expected that many of them will continue to use it when fine brass is required. High-grade zinc is also used for special brasses and ornamental bronzes, for slush castings,

for galvanizing steel wire for telegraph and telephone work, for the chemical industry and for the rolling of sheet zinc, wire and tubing. The high-grade zinc is more malleable and ductile than ordinary zinc and seems to be opening a new market for zinc. Such zinc can be easily stamped and spun so that such articles as eyelets, pencil tops, etc., are now being popularized. Where harder zinc is needed, as in washboards, floor plates, etc., zinc sheet made from lower grade spelter is used.

The difference in price between High Grade and Prime Western zinc was as much as 4c. per pound during the war, but dwindled to about $\frac{3}{8}$ c. in a few months after the armistice, although there is no basic market price for it like the St. Louis price of Prime Western "spelter."

CHAPTER II

HISTORY OF ZINC HYDROMETALLURGY

It is certain that zinc hydrometallurgy was impossible until electrolysis of zinc solutions had been accomplished. This took place some time during the decade beginning with 1870, and the first patents dealing with the subject appeared in 1880. To be sure, early experimenters, using the primary cell as a source of current, had determined that metallic zinc could be obtained from its solutions by electrolysis. Their zinc deposits rarely possessed sufficient adherence to stick to the cathodes and were often spongy and oxidized during drying. It is not certain just who first prepared zinc electrolytically in the laboratory.

Werner von Siemens built the first dynamo-electric machine in 1867 and thereby made possible a cheaper source of electric current than the primary cell, and it was this invention that made possible the commercial electrolytic deposition of metals.

It is known that Elkington was investigating electrolytic refining of copper in 1865 and he immediately seized upon the "dynamo" for a commercial source of current, founding a firm by the name of Elkington, Mason & Co., at Pambrey, near Swansea, Wales. Copper was thus the first metal produced electrolytically on a commercial scale.

The first United States patent involving electrolytic deposition of zinc was that of Charles Besley¹ of Paris, France, and dealt with an improved process for electroplating iron, steel, etc., for purposes of protection. He stated that it was very difficult to obtain an adherent deposit of zinc on iron and therefore he first applied a thin coating of tin, followed by the electrolytic deposition of a film of zinc. His patent describes the primary cells used for generating current, zinc

¹United States Patent 36,750, dated Oct. 21, 1862.

being used as the anodes in the primary cells. Not much is said by him regarding the zinc electrolyte to be used for electroplating except that he prefers "sub or proto sulphates and the subacetates of zinc, etc., combined together."

The first patents involving electrolytic preparation of zinc metal on a commercial scale seem to have been applied for in Germany almost simultaneously by C. Luckow of Dautz¹, and by Leon Létrange of Paris.²

The process of Létrange is particularly interesting because it substantially describes modern sulphate practice. His United States patent is No. 286,208 of Oct. 9, 1883 and the following is abstracted from it: The ore is first pulverized and an effort is made to mix calamine and blende in order that during roasting a maximum of zinc sulphate could be formed. The zinc is then leached out of the calcine with either water or sulphuric acid. Létrange does not describe the purification of the solution, as the preparation of zinc sulphate solutions for the making of lithopone was a well-known art at that time and he merely refers to purification "by known means." He then electrolyses in a cell in which thin sheets of zinc serve as cathodes, although copper and brass can also be used. The anodes are of carbon or "a conducting material of an insoluble nature, or a conducting material covered with a coating which is insoluble in the acid." The bath was a wooden tank lined with sheets of glass or lead. With the exception of carbon anodes, which are known to deteriorate in sulphate solutions, and the use of zinc sheet cathodes, which are now usually displaced by aluminum sheet in order to obtain easy stripping, Létrange practically anticipated modern practice. Only elaboration in detail, especially in the purification of solutions, was needed to put the process on its feet technically. It is a matter of surprise that so many years elapsed and such a voluminous patent literature grew up before what is essentially Létrange's process was adapted to the needs of the

¹D. R. P. 14,256 of April 20, 1880.

²D. R. P. 21,775 of July 8, 1881.

ores at Anaconda, Montana, and Trail, British Columbia, in 1914.

Since 1881, literally thousands of workers have contributed to the development of electrolytic methods of recovering zinc and of preparing and purifying solutions of zinc. To digest their patents here and to abstract the papers which they have written would fill many times the space that can be allowed for this book. Only important or successful phases of all this work can be described. The reader is referred to the excellent bibliographies by E. P. Mathewson¹ and H. L. Wheeler,² as well as the book by E. Günther.³

The importance of the purity of solutions was not at first realized and was never emphasized sufficiently until work was done in 1914 which led to the building of the present large electrolytic zinc plants.

During the '80s very little was done to advance the art beyond where Létrange placed it. Due appreciation of the economics of electrolytic zinc was shown in the early literature and efforts were made to recover zinc without the high consumption of electrical energy that is involved by decomposition of solutions of either zinc sulphate or zinc chloride. Attempts were made to use zinc ore or zinc oxide for anodes, thus depolarizing them and lowering the effective working voltage of the zinc cell. Sulphur dioxide was introduced around the anodes in a similar effort to cause depolarization and many other proposals were made for carrying on anodic oxidation of such products as chromates, in the effort to make two valuable products simultaneously and work at a lower voltage.

The most feasible proposal made at this period received semi-commercial test at the Royal Frederick smelter in

¹Canadian Mining Institute, *Bulletin*, March, 1917.

²School of Mines and Metallurgy, University of Missouri, *Bulletin*. Feb., 1918, revised to June, 1919, Rolla, Missouri.

³"Die Darstellung des Zinks auf Elektrolytischem Wege," by EMIL GÜNTHER, printed in 1904 by Wilhelm Knapp, Halle a.S., Germany.

Tarnowitz, Germany, by B. Roesing.¹ This proposed the recovery of zinc from the zinc crusts made in the Parkes process for desilverizing lead bullion. In the Parkes process, argentiferous lead is melted and treated in a kettle with metallic zinc. The zinc alloys with the silver present and rises to the surface as a scum, which is skimmed, together with more or less lead. This gives material rich in silver from which the zinc is usually distilled. The zinc crust was broken up and the lumps placed on lead plates under a zinc sulphate solution, the plates tending to convey the current to the pieces of crust, which acted as anode. Cathodes of zinc sheet were placed parallel to them. Due to the fact that the zinc crusts consisted of 80 per cent lead it was soon found that the lead buried the zinc beyond reach of the current and only the surfaces of the lumps could be de-zincd.

The idea of using zinc anodes was really advanced by R. P. Hermann, of Berlin.² He proposed using impure commercial zinc or scrap zinc cast into anodes, using pure zinc sheet cathodes and a zinc sulphate electrolyte containing double salts of zinc with aluminum or alkali metals. From the present writer's experience, he does not believe it possible to obtain pure zinc by following only the directions given by Hermann since cadmium, lead and iron are the principal impurities to be dealt with and only the lead sulphate formed at the anode is insoluble. Unless provision is made for keeping the anode slime in electrical contact with the anodes the cadmium will go into solution and be precipitated with the zinc on the cathodes. There was no demand for specially pure zinc at that time and consequently Hermann's proposals were not tested. It was really the proposal of Roesing which seemed to have commercial value.

At about the same time, A. Watt, of London, proposed

¹German Patent 33,589. *Zeitschrift für Berg-, Hütten- und Salinenwesen im Preussischen Staate*, 1886, p. 91. Also *Berg- und Hütten-männische Zeitung*, 1886, p. 463. Also *Dingler's Polytechn. Journ.*, 1887, 263, p. 87-94.

²German Patents 24,682 of April 24, 1883, and 26,091 of June 26, 1883, an addition to the first patent, as well as 33,107 of Sept. 14, 1884, another addition to the first patent.

using anodes cast from galvanizers' "hard dross," the hard alloy of zinc and iron which forms in the bottoms of galvanizing kettles where articles of iron are dipped into molten zinc. His patents¹ claim an electrolyte containing an organic acid, preferably acetic acid, but later he found too much lead in his cathodes and returned to the use of a zinc sulphate solution containing acetates. The Gülcher Co., of London, tested Watt's process, but never applied it in practice.

A few years later, Roessler and Edelmann improved the Parkes process for desilverizing lead and obtained zinc scums containing 80 per cent of zinc in place of 80 per cent lead, as was the case when Roesing did his work. This material could be cast into anodes and permitted electrolytic refining of the zinc in a zinc sulphate solution. Under these conditions the process was used for several years at the Hamburg Gold und Silber Scheideanstalt, but was later abandoned.²

The work of Roessler and Edelmann was carried on in the early '90s. In the meantime one of the most prolific and able inventors, Carl Hoepfner, was developing processes for the treatment of complex zinc ores and the electrolysis of zinc chloride solutions. Hoepfner's patents and journal articles are too numerous to mention, but Gunther³ has reported on this work at great length.

A company was formed in 1892, named after Hoepfner, and organized with the purpose of exploiting his processes. Development work was carried on at several places in Germany (Giessen, Eiserfeld, near Siegen, etc.), and finally a small electrolytic establishment with sixty cells was built at Förfurt on the Lahn, in 1894 and 1895. Pyrite cinder from a near-by sulphuric acid plant was roasted with salt. A small amount of zinc and copper present in the cinder was

¹English Patents 6,294 of 1887 and 3,369 of 1888.

²See report by HASSE in *Zeitschrift für das Berg- und Hütten-männische Zeitung*, vol. 45, p. 322. Also *Berg- und Hüttenmännische Zeitung* (1895), p. 431.

³GUNTHER: "Die Darstellung des Zinks auf Electrolytischem Wege."

thus made available by being chloridized and leached. The leaching solutions were purified until nothing but zinc and sodium chlorides were left and this solution was submitted to electrolysis in Hoepfner's cells (described later) giving electrolytic zinc cathodes and chlorine gas. The chlorine was absorbed in lime to make bleaching powder. In this way Hoepfner utilized both cathode and anode products commercially.

Hoepfner regarded his Fűrfurt plant as a semi-commercial one built for demonstration purposes, and it operated only two years. It resulted in the construction of three plants, two in Germany and one in England. Very little is known by the writer about the two German plants except that one was later moved to Austria. The plant in England was at the works of Brunner, Mond & Co., in Winnington, Cheshire. Here zinc oxide, resulting from the roasting of zinc sulphide ore, is treated with by-product calcium chloride liquor and carbon dioxide flue-gas, forming zinc chloride solution and calcium carbonate precipitate. The zinc chloride solution is purified and electrolysed to form zinc and chlorine. The zinc is advertised by the company as 99.96 per cent pure, and during the World War this plant was spoken of as being exceedingly important in supplying pure zinc for cartridge brass and chlorine for the making of poison gases. This plant has now operated for over twenty years, and it is to be regretted that technical details about it have not been published.

While Hoepfner was busy developing his chloride processes in Germany, another versatile inventor, Edgar A. Ashcroft, was busy in England. He proposed roasting zinc sulphide ore, leaching with a solution of ferric chloride and then electrolysing the solution first in a series of cells provided with iron anodes and then a series of cells with carbon anodes. The leaching step threw out most of the iron as ferric hydroxide and took the zinc into solution as zinc chloride. The first series of cells deposited some zinc and replaced it with ferrous iron from the anodes. In the second

series of cells the ferrous iron was oxidized to the ferric condition in the anode compartment of the cell. In about 1896 the Sulphide Corporation built a 1,500-lb. test plant to try this process at Cockle Creek, New South Wales, Australia. This is in the Broken Hill district in which more complex sulphide zinc ore has been mined than in almost any similar set of mines in the world. The plant met with economic and technical failure, although quite a number of tons of metal were produced during the operation. Ashcroft gave the results of this work in a paper read before the Institution of Mining and Metallurgy in London, on June 22, 1898.

Ashcroft then combined forces with James Swinburn in developing a new process which he called the "Phoenix process." A finely powdered sulphide ore of zinc was suspended in fused zinc chloride at a temperature of about 600° C. and chlorine gas blown through the mass. Sulphur vapor issued from the mouth of the "converter" and zinc chloride, with chlorides of any other metals present in the ore, remained in the converter. The mass of chlorides was then dumped into water and the solution worked for the various metals by known methods until nothing but zinc chloride remained in the solution. Then the solution was evaporated till fused zinc chloride was obtained, part of which could be returned to the process and the remainder electrolysed in the molten condition in a specially devised cell. A chlorinator of 30-ton ore capacity per week was set up and tested at the works of the British Castner-Kellner Co. in about 1903, but so far as can be learned this machine did not operate long. The proposal to electrolyse fused zinc chloride was not new, but was the practical adaptation of ten years of development by others, especially G. Nahnsen,¹ R. Lorenz,² F. M. Lyte,³ H. Schultze,⁴ and O. J. Steinhart,

¹Berg- und Hüttenm. Zeitg. 50:393-397, Oct. 23, 1891.

²English Patent 25,074 of 1894. German Patent 82,125. Also Zeit. f. anorg. Chem. 10:78-116, 1895, and 12:272-276, 1896.

³English Patent 15,813 of 1895.

⁴Zeit. f. anorg. Chem. 20:323-332, 333-339, 1899.

J. F. L. Vogel and H. G. Fry.¹ While the present writer finds much of interest and promise in this process it has not as yet found practical application beyond the partial test above mentioned.

During the time that Hoepfner and Ashcroft were in the limelight with their chloride processes, the firm of Siemens & Halske in Berlin were experimenting with the sulphate process initiated by Létrange, and the proof of their increase in knowledge is shown by the patents which they took out during the nineties and the first ten years of the present century. It is probably due to them, especially their engineers, Englehardt and Huth, that the improved technique in purifying zinc sulphate solutions and electrolysis of such solutions was developed. Blount ("Practical Electro-Chemistry," pp. 134-150) mentions a test plant built by the Smelting Company of Australia at Illawarra, N. S. W., to try out the Siemens-Halske process, but no information has ever been given out as to why this plant was not a success. It is another instance of where good time and money has been spent, and a publication of the results could have easily been of great benefit to the profession even though the results themselves may have been adverse to the application of the process at that particular spot. There is no doubt that the publication of his results by Ashcroft on the Cockle Creek plant has been of great benefit in the development of the art, even though the results were largely negative.

About 1906 the "Bisulphite" process of leaching and recovering zinc from its ores began to attract attention and received development at the hands of such men as H. L. Sulman, W. Hommel, H. Rees, H. T. Durant,² and others. The fundamental facts on which this process rested have been known for many years, and had been mentioned in

¹English Patent 19,876 of 1898.

²British Patents 23,901 of 1907, 13,492 of 1908; United States Patents 966,389 and 1,074,203. *Eng. and Min. Journal* 87:791 (April 17, 1909) and 92:1,120 (Dec. 9, 1911) and 95:792 (April 19, 1913) and 102:895-898 (Nov. 18, 1916).

patent literature by Edwards¹ in 1890, and by C. Hoepfner² in 1895. In this process the soluble salt is the bisulphite of zinc. In most of the variations of the bisulphite processes the roasted zinc ore is treated with sulphur dioxide gas and water or a solution of sulphur dioxide in water. This solution acts like a solution of sulphurous acid, H_2SO_3 , which first forms zinc sulphite, ZnSO_3 , and then by adding more sulphurous acid, zinc bisulphite, $\text{ZnH}_2(\text{SO}_3)_2$. Most inventors try to recover the zinc by treating the zinc bisulphite solution in such a manner that the zinc will be converted into the monosulphite, ZnSO_3 , which is insoluble, and then roast this compound to drive off sulphur dioxide and leave zinc oxide in pure condition. The British Metals Extraction Co. built a semi-commercial plant at Llansamlet, Wales, about 1912, to test the process, with results that were not satisfactory, especially from the mechanical point of view (see *Eng. and Min. Journal*, 102:895). As far as is known, this is the only plant of the kind ever operated.

During the period between 1907 and 1914, several other inventors were improving details of the sulphuric acid-leaching-and-electrolysis process, making it easier for the final economic success of the plants at Trail, British Columbia, and Anaconda, Montana. Prominent among these men were P. C. C. Isherwood, who depended upon the solubility of zinc oxide from ores in hot solutions of zinc sulphate under pressure; U. C. Tainton, who improved the technique of electrolysing zinc sulphate solutions, especially by using higher current densities, pure solution and a new addition-agent, Gum tragacanth; finally, A. G. French developed a process for electrolysing solutions of zinc sulphate containing manganese sulphate, coherent zinc being formed at the cathodes and hydrated manganese dioxide at the anodes, the latter representing a second commercial product. Isherwood's work was carried on near New York, and in England. In 1916 the Venture Trust was forming the British Electro-

¹English Patent 8,716 of 1890.

²English Patent 8,445 of 1895.

lytic Zinc Co. to work Isherwood's processes, but the writer is not informed of anything done by this company. French induced the provincial officials of British Columbia to finance a test plant for his process at Nelson, and after partly constructing his plant met difficulties in the expenditure of funds, and to date the difficulties have not been adjusted.

In this same period a chlorination method, of which J. L. Malm, of Denver, was the principal exponent, met trial and discouragement in semi-commercial test plants at Corbin, Montana, in 1907, Georgetown, Colorado, in 1910, at Kellogg, Idaho, in 1914 and Niagara Falls, New York, in 1917. This process involves treating a zinc sulphide ore in a rotating kiln furnace with dilute chlorine gas, followed by leaching out the zinc chloride with water, purifying and evaporating the zinc chloride solution, and finally electrolysing the fused zinc chloride in order to regenerate the chlorine and make metallic zinc ready for market. Unsolved mechanical difficulties and inadequate finances to find the solutions to these problems caused the repeated failures.

Some time before 1910 the General Electric Co. bought copper mines in Shasta County, California, and on developing them at greater depth found that zinc ores largely replaced the copper ores. Below the permanent water level the ore consisted mainly of complex sulphides. J. B. Keating, manager, worked out a sulphuric acid leaching and electrolysis process in which zinc sulphate solution was electrolysed in the presence of suspended zinc hydroxide and calcium sulphate, made by treating some of the zinc sulphate solution with lime. This was on the assumption that it was possible to get good yields of zinc from sulphate solutions only if the acid liberated at the anodes was neutralized. This idea seemed to have a firm hold on most of the California metallurgists during the years 1910 to 1916. The process was tested in a semi-commercial plant at the mine (Bully Hill) and C. A. Hansen, of the General Electric Co., contributed to its further development. Ultimately it was found that the presence of zinc hydrate was unnecessary

and undesirable. Only a test plant was built for the treatment of this ore.

C. J. Reed likewise installed a semi-commercial test plant at Palo Alto, California, for the treatment of bag-house dusts from the Kennett smelter. Sulphuric acid leaching was followed by crystallization of zinc sulphate from the solution and redissolving in water to make up the electrolyte. The anodes consisted of spongy lead which was to take up the sulphate ions during electrolysis to prevent the formation of the sulphuric acid with the supposed bad effects mentioned above. These anodes, after sulphating, were removed to other tanks and made the cathode in a cell with sheet-lead anodes and sulphuric acid electrolyte. This reduced the lead sulphate to spongy lead and sulphuric acid. The use of spongy lead and sulphuric acid in storage batteries is well known. This process was not adopted commercially. It was operated in 1914 and 1915 at the time when the Anaconda and Trail plants were just experiencing technical success.

Finally, in 1913, the Consolidated Mining & Smelting Co., at Trail, British Columbia, and in 1914 the Anaconda Copper Co., at Anaconda, Montana, took up the problem, and each arrived at a satisfactory solution, each building a commercial plant in 1915 and further enlarging it during the war. Each developed the simple process of roasting the complex sulphide ore, followed by leaching with a dilute sulphuric acid solution, purification of the solution and electrolysis to obtain zinc cathodes and regenerate sulphuric acid at the anodes. The details of purifying the solutions were the all-important points worked out by each of these companies, together with the mechanical apparatus in which the processes were carried out. It is well understood that the credit for the Anaconda work is due F. Laist, F. F. Frick and J. O. Elton, together with their assistants, whereas a considerable number of men were responsible for the success at Trail, among whom are F. W. Guernsey, B. A. Stimmel, F. E. Lee and S. G. Blaylock.

The Anaconda plant was developed to about twenty-five tons daily capacity before it was dismantled and transferred to Great Falls, Montana, where the present daily capacity is 150 tons of metallic zinc. This is by far the largest plant in the world, and will probably not be exceeded for some time to come. The Trail plant has a capacity of fifty to seventy-five tons.

The success of the Anaconda and Trail plants encouraged other companies to try out the sulphate-leaching-and-electrolysis process during the war, with varying economic success. The Weedon Mining Co. installed a test plant at Welland, Ontario, in 1915, using roasted zinc ore in the anode compartments of a special cell and depositing zinc on the cathodes from a sulphate solution. They believed that the acidity must be neutralized at the anode in order to prevent re-solution of the zinc cathode. This process was not sufficiently promising to be adopted commercially. The American Smelting & Refining Co. built test plants at Omaha, Nebraska, and at Murray, Utah. The former, under the direction of A. E. Hall, treated zinc crusts from the refining of lead by the Parkes process. The latter plant, in the hands of R. W. Hyde, treated zincy-lead ores, which are regularly smelted for lead and silver, in the Murray smelter. In each case it was realized that only a large plant could operate economically and the experiments were abandoned in 1916. The River Smelting & Refining Co. built a semi-commercial unit at Keokuk, Iowa, under the direction of R. G. Hall and F. G. Schol, to treat zinc-lead oxide flue dusts made in a plant at Florence, Colorado. This plant was closed down early in 1919, after about two years' life, since the company realized that only a larger plant could be operated economically, and this they did not care to build at that time. The Judge Mining & Smelting Co., under the direction of C. A. Hansen, built a 7-ton plant at Park City, Utah, in 1916-1917. It is in operation at the present time, although it was closed down for a while after the signing of the armistice reduced the demand for high-grade zinc. The United States Smelting,

Refining & Mining Co. built a plant at Kennett, California, to treat a complex flue-dust consisting mainly of zinc oxide. They operated till after the armistice and then dismantled their plant. This plant was under the direction of H. R. Hanley. Charles Butters built a plant on San Francisco Bay during 1917-1918 which is said to be in operation at the present time testing the Tainton process. Lewis Skinner, of the Western Chemical Co., of Denver, built a 10-ton plant, which is still in operation.

The Electrolytic Zinc Co., directed by C. H. Aldrich and J. K. Bryan, built a zinc refining plant in Baltimore, Maryland, about 1915, in which impure Prime Western spelter was cast into anodes ready to be refined. These were wrapped tightly in canvas bags and placed in a zinc sulphate solution as anodes with aluminum plates for cathodes. This plant closed down and was dismantled after the armistice in 1918.

In 1917 the Electrolytic Zinc Company of Australasia sent its general manager, H. W. Gepp, to the United States to study the electrolytic zinc problem and find men capable of applying the process to the Broken Hill, N. S. W., ores. After two years of experimentation on the small and large scale at Hobart, Tasmania, where cheap power is available, the first 50-ton unit of a 100-ton plant is now being built. Cobalt was found in the ores from Broken Hill, and it caused serious re-solution troubles. In studying this problem much was learned about the function of addition agents. They also learned that the lead anodes had a much longer life if they were allowed to coat over with a thick covering of manganese dioxide.

From the experiences recorded above it can be seen that the extraction of zinc from ores and metallurgical products by sulphuric-acid-leaching-and-electrolysis is now a well established practice, and it is economical if operated on a sufficiently large scale. Electrolysis of zinc chloride solutions has been practiced for many years, but the operating details have not been open for publication.

CHAPTER III

ROASTING ZINC ORES

In the standard processes for treating zinc by wet methods the zinc must be present in the form of oxide. Therefore, the sulphide ores of zinc must be roasted. The roasting of zinc ores in order to prepare them for hydrometallurgic processes is one of the least satisfactorily developed phases of the subject. This is due to many mechanical problems involved in producing the desired chemical result. They are problems which can hardly be solved by small-scale experimentation. For instance, heat-control in large masses of ore and machinery can only be investigated by operating on full scale. Changes on the large scale are expensive and consequently, due to the youth of the process, not a great fund of experience has yet accumulated in order to allow for general improvement in the design of roasting furnaces.

In the roasting of zinc ores to prepare them for recovery of the zinc by distillation, the problem is one of removing as much of the sulphur as possible whether it be present in the ore as zinc sulphide or zinc sulphate. It is known that one pound of sulphur restrains two pounds of zinc from distilling and consequently the zinc smelter-man roasts his ore "dead" and finishes at a high temperature (800°-1,000° C.) in order to break up any zinc sulphate which formed at lower temperatures. Such a roast is not at all adapted to preparing zinc ores for leaching processes unless they contain practically no impurities, and even then a high finishing temperature seems to make a dense form of zinc oxide or particles of zinc oxide that are glazed over with small amounts of fusible impurities, so that it is difficult to get all of the zinc into solution. The most successful roasting for hydrometallurgic purposes has been carried on at temperatures between 550 and 650° C. or even as high as 750°.

Obviously, the guiding principle in roasting ores for leaching is to obtain the maximum percentage of soluble zinc. This means that the minimum percentage of zinc sulphide should remain in the calcine. The roasting should be carried on long enough to allow the oxygen to penetrate completely to the core of each particle of ore. For many purposes it does not matter if some of the zinc sulphide is converted to zinc sulphate during the roasting, since this is soluble—in fact, it is often desired. In order to obtain speed of roasting, the temperature must be carried as high as possible without injuring the solubility of the oxidized forms of zinc. This is due to the fact that zinc sulphide is not easily oxidized, having a high “kindling temperature” and the speed of oxidation rapidly increases with the rise of temperature. Whereas many other metal sulphides are easily roasted at temperatures as low as 400° C., zinc sulphide is usually untouched at this temperature and does not oxidize with any rapidity until temperatures well above 500° C. are attained. It resembles graphite to some extent in being difficult to ignite and completely oxidize, even though the heat of combustion is very high.

Overheating a zinc ore during roasting causes several other objectionable things to take place. For instance, if galena or a similar easily fusible mineral is present, it will tend to fuse and coat over the surfaces of zinc sulphide particles so they cannot be oxidized. Even more harmful, zinc oxide tends to combine with ferric oxide to form a ferrite, $ZnFe_2O_4$, which is almost insoluble in dilute sulphuric acid, sulphurous acid or caustic soda solutions, even when heated. Dilute hydrochloric acid will attack zinc ferrite slowly, but for practical purposes the ferrite is insoluble in any of the commercial leaching solutions. Zinc oxide and iron oxide begin to combine at temperatures in the neighborhood of 730-750° C., although the action is slow at this temperature, and increases in velocity with rise of temperature. This statement needs qualification since in roasting a marmatite (zinc sulphide containing iron sulphide in “solid solution” or

isomorphous crystallization), the resulting zinc and iron oxides are formed in practically molecular contact and are therefore in a position to combine with each other to some extent at any temperature usually met in a roasting furnace. If pieces of zinc sulphide minerals are roasted with pieces of iron sulphide minerals, only a few of the zinc oxide molecules of the total mass are actually in contact with iron oxide molecules, and consequently the opportunity for combination is much smaller. Hence, ores in which the zinc sulphide is "free" can safely be heated to higher temperature during roasting, and can therefore be roasted more quickly. Ores containing marmatite require up to twenty hours or more to be roasted to the maximum soluble content of zinc, whereas clean yellow sphalerite can be roasted in eight or ten hours.

The ferrite of zinc, when made by combining iron hydroxide and zinc hydroxide precipitates and then heating them, is a yellowish-brown magnetic material which invariably has been found to correspond to the formula $ZnO.Fe_2O_3$ or $ZnFe_2O_4$. One unit of iron by weight is combined with 0.58 units of zinc. Since the highest percentage of iron usually found isomorphously crystallized with zinc sulphide in marmatite is about 15 per cent, and a corresponding zinc content of 52 per cent, it can be seen that $0.58 \times 15 = 8.8$ per cent zinc is all that is likely to be held in the insoluble form. Eight and eight-tenths parts of zinc out of 52 is 17 per cent of the total zinc. This means that in roasting marmatite about the maximum percentage of the total zinc which could form ferrite is 17 per cent, leaving 83 per cent soluble. In addition there will always be some unroasted zinc sulphide and some ferrite formed where zinc oxide particles are in contact with roasted pyrite particles. Due to all causes, it is not unusual to find marmatite-bearing ores which on roasting give up only 60-70 per cent of their zinc to leaching solutions. While iron in zinc sulphide ores is hardly the greatest technical enemy to hydrometallurgic processes, it is undoubtedly the greatest economic enemy—due to the losses of zinc which it causes.

Sulphur is not the only element eliminated in the roasting of the ore. Arsenic and antimony are also largely eliminated but never quite completely. Antimony is so powerful in deleteriously affecting the electrolytic deposition of zinc from its solutions, that no roasting process can sufficiently free the ore from it. Selenium, tellurium and cadmium also tend to concentrate somewhat in the fume from the roasting furnaces. It has also been observed that 10 to 40 per cent of the silver in zinc sulphide ores can be volatilized. Whether the silver volatilized is present in the ore as silver chloride is not known. There is often enough chlorine present in the ore as sodium chloride to provide chlorine for combining with the silver. In the electrolytic plant at Hobart, Tasmania, chlorine is known to be present in the roasted ore, and is removed from the solutions by adding silver sulphate. By properly controlling the roast it is possible to form enough silver sulphate to combine with all chlorine present. This is very desirable, since chlorine in the zinc sulphate solution causes corrosion of the lead anodes.

Copper in a zinc ore is usually over-roasted to an insoluble oxide form. The temperatures at which zinc ores are roasted are higher than the ones at which copper ores are roasted for leaching, and any copper sulphate formed at the lower temperatures of the roasting furnace is finally decomposed into a difficulty soluble oxide or even ferrite before the zinc sulphide is completely roasted. Consequently only 20 to 50 per cent of the copper in the average zinc ore is soluble in dilute sulphuric acid. The percentage of copper found in zinc ores is usually low, although few zinc ores do not contain some copper. Providing the residue from the zinc plant is to be smelted in a lead smelter, it makes little difference whether the copper dissolves and is recovered by precipitation during the purification of solutions or is recovered in the lead smelter as matte.

Almost without exception, zinc sulphide ores are now roasted for leaching processes in circular multiple hearth furnaces of the McDougall type, especially in the Wedge

modification. The essential parts of this latter well-known furnace are given in Fig. 1.

Briefly, the slightly damp ore is fed onto the top drying hearth of the furnace and raked around by rabblers on rabble

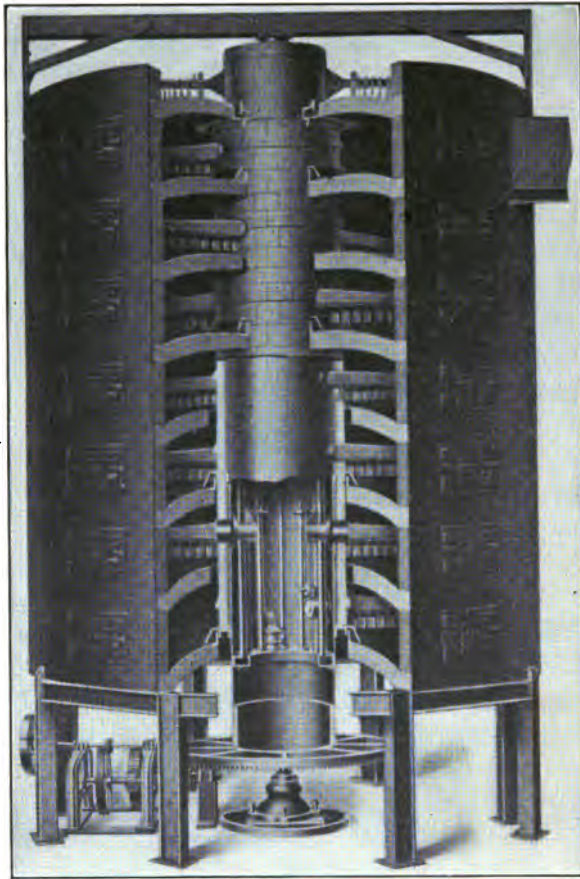

FIG. 1.—The Wedge zinc roaster

arms which are carried on a central rotating shaft. The rabblers rake the ore finally to a central hole through which it drops into the first hearth below it where it is heated and ignited by hot gases rising from the hearths below. On this

hearth it is raked to a hole near the circumference, where it drops to the second hearth, is rabbled back to the center and drops to the third hearth, and so on. Most of the roasting takes place in the second, third, fourth and fifth hearths. The seventh hearth, or the sixth and seventh hearths, where remaining traces of zinc sulphide are oxidized, is fired by an external fire box in order to keep it up to a sufficient temperature to burn the zinc sulphide. The air enters with the combustion gases through the fire boxes and is thus preheated before it passes up through the furnace.

C. A. Hansen¹ has made a most excellent heat balance of the Wedge zinc-roasting furnace, and finds that most of the heat due to combustion of the zinc sulphide is liberated on the upper hearths of the furnace, heating the flue gases, which escape at a high temperature into the stack, while in the lower hearths there is not sufficient evolved to maintain combustion, making necessary extraneous fuel for firing. In fact, more than 80 per cent of the heat evolved in the zinc roaster at the Judge Mining & Smelting Co., Park City, Utah, escaped in the stack gases. Practically all the other zinc roasters used for zinc smelting are subject to the same criticism. Hansen finds that something like 7.8 times the air volume theoretically required for the oxidation of the concentrates and something like 4.4 times as great as the air volume required for the concentrates and coal is actually supplied to the Judge plant roaster. Since the roaster at this plant is operated in about the same manner as the roasters at other plants, it can be seen that much might be done toward conservation of fuel by either admitting air in controlled volumes at appropriate places, or making the furnace regenerative and preheating the air supplied to it by the use of checkerwork flues heated by the exhaust gases.

The fuel consumption at the Judge plant varies from 12 to 20 per cent on the weight of the ore, depending on how much ore is being fed through at a given time. This tonnage

¹Paper on "Electrolytic Zinc," Chicago meeting, American Institute of Mining and Metallurgical Engineers, Sept. 1919.

varies from thirty-seven to twenty-six tons respectively, and the insoluble (largely unroasted) zinc in the calcines varies from 6.0 to 10.5 per cent respectively. This roaster is a standard Wedge roaster with seven hearths, 25 ft. outside diameter and 21 ft. inside diameter. Each hearth is rabbled by two arms carrying ten to fifteen rabblers each. The rabble arms on the upper five hearths are air-cooled, using 5,000 cu. ft. air per minute at 2 oz. pressure. This heated air is discharged into the tops of the sixth and seventh hearths. The rabble arms on the sixth and seventh hearths are water-cooled, requiring twenty gallons water per minute.



FIG. 2.—Zinc ore roasters at Great Falls, Montana

The roasting installation of the Great Falls plant of the Anaconda Copper Co. consists of fourteen of the same type Wedge furnaces which have been modified to the so-called Anaconda-Wedge type. A photograph of one row of seven of these furnaces is shown in Fig. 2. These are 25-ft. outside diameter with seven hearths and a drying hearth. All the arms are water-cooled, there being four arms each on the drying hearth and the first roasting hearth, and three arms

in each of the other hearths. The seventh hearth is heated by two coal-dust fire-boxes with special coal-dust burners, placed on opposite sides of the hearth. The flue gases pass through a dust chamber where flue dust is settled and returned to the roasters. Apron feeders are geared onto the drive-shaft and are adjustable so that the amount of ore fed to the furnaces can be varied at will. Storage bins over the furnaces supply the feeders. The hot calcine passes through coolers. Industrial railways bring in the ore and take the calcine away to the leaching plant. Not all of the six-hundred tons of ore treated daily are roasted in this plant, but each furnace roasts from thirty to forty tons, the ore being in the furnace up to twenty hours or even more.

At the Trail, British Columbia, plant of the Consolidated Smelting & Refining Co., Wedge roasters of the same general type are in use. It was noticed here that overheating, with consequent formation of ferrites, often took place just behind the rabblers as they turned over fresh masses of hot ore to be acted on by the air.¹ This led these metallurgists to try to roast for a longer time at a lower temperature, but they found this left too much unroasted zinc sulphide. They concluded that a Wedge furnace cannot properly desulphurize the ore, and at the same time avoid the formation of ferrites, although they were able to get good results in an assay muffle in their laboratory. In a large mass of ore, the more rapid the rabbling the greater the rapidity of oxidation and the heat liberated raised the temperature too high. They concluded that less frequent rabbling was better in the part of the furnace where the ore was burning readily. It is also possible that a lower concentration of oxygen in the atmosphere over the ore at this point would also cut down the rate of oxidation and provide a medium to better absorb the excess heat, although experiments along this line have hitherto failed. Also roasted ore mixed with the raw feed would provide a reservoir to absorb heat of oxidation and

¹E. H. HAMILTON, G. MURRAY and D. McINTOSH: Formation of Zinc Ferrate. *Bull. Canadian Min. Inst.* July, 1917.

tend to prevent overheating. More recent developments at Trail on roasting a concentrate containing less pyrite show a less tendency to overheat. Also the treatment of roasted ore in a strong sulphur dioxide atmosphere has been found to break up ferrites of zinc, forming zinc sulphate.

The above discussion hints at one of the factors which restrict the speed of roasting. The older roasters used in the zinc smelters often required sixty hours to "dead roast" the ore, and hence Wedge roasters taking twenty to twenty-four hours do not seem so bad. However, in none of the commercial roasters is the ore *ventilated* during roasting as much as it might be. The ore lies in a bed as much as three inches deep with the combustion gases passing over it, and the diffusion of oxygen into the ore-bed and of sulphur dioxide out of it is quite slow. Only the rabbling is of much importance in actually getting oxygen in contact with the surfaces of the zinc sulphide particles. The compact form of the Wedge roaster makes it difficult for much heat to be radiated from the zone of most intense combustion and by slowing down the rabbling the air supply to the center of the ore bed is effectively lowered and the air passes on without combining with as much sulphur as it might. In fact, the percentage of sulphur dioxide in the flue gas is usually quite low, being below 2 per cent, and often below 1 per cent. That is to say, air, with a high concentration of oxygen is doing most of the cooling, and this high concentration carries with it the danger of overheating the ore just behind the rabbles, no matter how slowly they move, when the hot fresh ore is exposed to the air. The narrow zone of temperature, between 450 and 700° C., in which the ore must be maintained, makes the attainment of speed in roasting and satisfactory chemical composition of the calcine difficult.

The size of ore particles also has an effect on the speed of roasting. Hansen (loc. cit.) gives screen analyses on the calcine from the roaster at the Judge plant, and most of the unroasted blend is found in the sizes coarser than a standard 60-mesh screen. This leads him to recommend that for

general work the ore should be crushed to pass at least a 60-mesh screen. Of course this means that more fine dust will be carried away in the flue gases, and a system for recovery of this dust will be made all the more imperative. In fact, at the Trail plant, a Cottrell precipitator has been installed for this purpose. The presence of coarse pieces of zinc sulphide in the furnace feed not only make it necessary to roast the whole batch of ore longer, but the finer or smaller particles are in danger of being over-roasted. One of Hansen's sets of curves for Judge ore roasted isothermally at 650° C. shows that the solubility of the zinc in the smallest

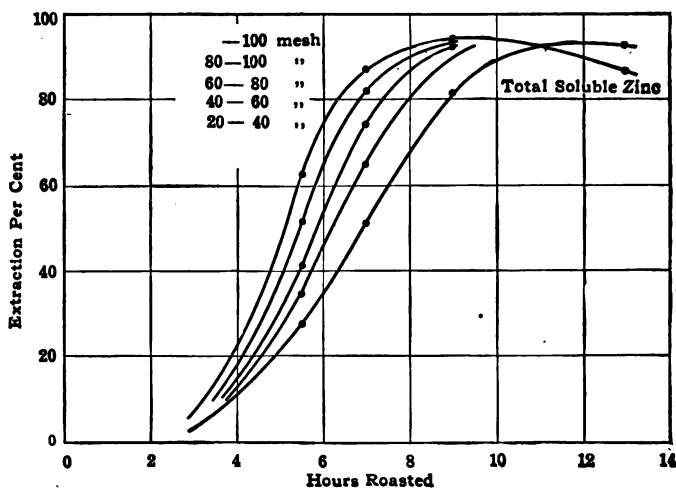

FIG. 3.—Daly-Judge concentrates roasted isothermally at 650° C. Effect of screen size

sizes fell off (Fig. 3) before the zinc sulphide in the coarsest size had been completely roasted. This brings out the point that it would be much better to size the ore into particles of several different sizes before roasting in order to obtain more perfect roasting. In a large plant like that of the Anaconda Copper Co., with its numerous roasting furnaces, this would not be difficult, since special furnaces could treat each size continuously, and allow the greatest possible speed of roasting for each size.

Another of the highly important things in roasting for sulphuric acid leaching is the amount of zinc sulphate formed during the roasting of the sulphide. There should be enough zinc sulphate formed to make up for all the sulphuric acid lost in the cyclic leaching and electrolysis. While theoretically the ore is leached with a sulphuric acid solution and this solution is electrolysed to give zinc and sulphuric acid back again, all of this sulphuric acid is not recovered. Some of the zinc sulphate remains in the leached ore and is not washed out. Some of the zinc sulphate solution is also lost by "slopping" around the plant. The sulphuric acid lost in various ways must either be made up by adding new sulphuric acid to the leaching solution or by forming zinc sulphate in the ore during roasting. Fortunately no difficulty is encountered in making enough zinc sulphate to meet this demand, since the average ore of zinc does not contain many constituents which use up sulphuric acid.

More sulphate of zinc is formed by low temperature roasting than at higher temperatures because zinc sulphate is dissociated thermally into zinc oxide, sulphur trioxide and sulphur dioxide and oxygen at temperatures above 575° C. While only rough measurements have been made, it is safe to say that zinc sulphate has a certain decomposition pressure at each temperature, and this decomposition pressure is of sufficient magnitude to become measurable at about 575° C., increasing with temperature, after the manner of a vapor pressure curve. Just where the decomposition pressure of zinc sulphate reaches one atmosphere is not known, but it is probably somewhere above 850° C. and may be as high as 1,000° C. The zinc sulphate first splits into ZnO and SO₃, and if it is held in a closed vessel, could give off SO₃, until the pressure of this gas equals the decomposition pressure of the zinc sulphate. By pumping in enough sulphur trioxide vapor at this pressure, any sulphur trioxide in excess over that necessary to maintain the dissociation pressure would have to combine with zinc oxide to form zinc sulphate again. Unfortunately for this theory, sulphur

trioxide also dissociates thermally into sulphur dioxide and oxygen, so that the system is a complicated one. Be that as it may, it has been found that more zinc sulphate remains in the calcine after roasting at lower temperatures, and this is probably due to the low decomposition pressure at these temperatures.

Another observation worthy of attention is the fact that more zinc sulphate is formed in zinc ores containing iron than in ores containing "clean" zinc sulphide. Thus, Hansen finds that under similar conditions the relatively clean ore of the Butte and Superior mine (Butte, Montana) yields only 20 per cent of its zinc as sulphate, while the high-iron zinc ore of the Bully Hill mine ore (Bully Hill, Shasta County, California) yields 76 per cent. The same experience has been had with the different ores treated by the Anaconda Copper Co. To the writer, this can only be interpreted in the light of the known fact that iron oxide acts as a catalyzer for the oxidation of sulphur dioxide to sulphur trioxide. In the ores containing closely intermingled sulphide of iron with the zinc sulphide, both zinc oxide and iron oxide are formed by the roasting. The iron oxide is naturally in the proper situation to catalyze the oxidation of the sulphur dioxide and the sulphur trioxide then has the opportunity to combine with the zinc oxide.

Hansen feels that the formation of zinc sulphate is due to direct addition of oxygen to zinc sulphide according to the equation:

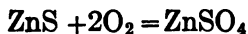

He gives as his reason the statement that during the first stage of the roasting the sulphur dioxide concentration is high, but not much sulphate is formed, while in several instances cited by him, after the sulphur dioxide concentration had fallen below 1 per cent and the oxygen concentration in the air passing over the ore was practically up to that of air, most of the remaining zinc sulphide in the ore was roasted to zinc sulphate. This may be true, but it does

not explain the favorable action of iron oxide. On the other hand it is known that the oxidation of sulphur dioxide to trioxide in the presence of iron oxide is most efficient at the low concentrations of sulphur dioxide (iron oxide catalyzer is used in several processes for making sulphuric acid, notably the Mannheim), and hence Hansen's phenomena can be interpreted as substantiating the theory represented by the following reactions:

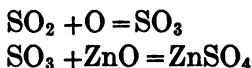

The oxygen must be atomic and the catalyzer supplies the atomic oxygen by splitting the inactive oxygen molecule, O_2 , into two active atoms. During the first stages of roasting very little iron oxide is present to catalyze the oxidation, and also very little zinc oxide is present to absorb any sulphur trioxide formed, but as the concentration of zinc oxide and iron oxide in the roasting mass increases the efficiency of formation of zinc sulphate should correspondingly increase. The most recently developed plant for applying sulphate leaching and electrolysis is that of the Electrolytic Zinc Company of Australasia, where roasted calcines are added to the roasting ore in order to increase the formation of zinc sulphate. The efficiency of formation of zinc sulphate was found roughly proportional to the concentration of zinc oxide in the mass, especially at the end of the roasting.

All of the above phenomena could be interpreted as favoring the theory that oxygen can add directly onto zinc sulphide as easily as they can be interpreted to say that the oxygen adds onto the sulphur dioxide molecule and then the sulphur trioxide combines with zinc oxide. The ferric oxide in both cases functions in supplying atomic oxygen. However, the reactions called for by the sulphur trioxide theory are well known, while the reaction called for by the direct oxidation theory has not been definitely substantiated.

Another factor which affects the amount of zinc sulphate

formed is the size of the ore particles. If the particles are large, less sulphate is formed than when the ore is finely powdered. Supposedly this is due to difficulty for oxygen to diffuse into the cores of the particles. Fine grinding is hence desirable, not only to increase the speed of roasting, but to increase the amount of zinc sulphate formed, if this is also desired.

Too much zinc sulphate is as embarrassing as too little zinc sulphate in the calcine. If too much is formed, the electrolytic decomposition of the resulting solutions will make more sulphuric acid than the ore can use and some of it will have to be neutralized or thrown away. This is embarrassing because the electrolytic plant never strips the solutions of zinc, and it is difficult to discard dilute sulphuric acid solutions without throwing away zinc with them. On that account each plant must control the roast to make only slightly more zinc sulphate than is needed by the plant, and the slight excess sulphuric acid will be neutralized by the limerock which is added later to hydrolyze any iron sulphate present.

From the above discussion it can be seen that the roasting department is not merely a place in which zinc sulphide ores can be roasted to make zinc soluble, with very little care or thought, but careful control is necessary in order to prevent spoiling the ore for leaching purposes, and in order to keep the plant supplied with just the right amount of sulphuric acid for leaching purposes. Inexperienced men can cause much loss and worry, and a man who can roast lead or copper ore is not necessarily a good roasterman on zinc ore.

A most recent development in roasting practice has been experimented with at the Trail plant by Mr. A. L. McCallom and Mr. F. E. Lee. The leached zinc ore tailing, containing over 10 per cent of zinc as ferrite, is treated at about 1,000° F. with the sulphur dioxide gases from a pyrites burner, with the result that the ferrite of zinc is reduced, and the zinc forms zinc sulphate which can be leached out with water, leaving a residue containing less than 1 per cent of zinc.

This process, or a modification of it, promises to be of prime importance in solving the troublesome question of zinc ferrites, since it gives a method of recovering the zinc economically from these refractory compounds. If this step works out well in practice it is possible that the first roasting will not require so much care, and the final roasting in an atmosphere high in sulphur dioxide will be of greater importance.

The action of the sulphur dioxide in decomposing ferrites of zinc and forming zinc sulphate, also probably accounts for the success of the roasting experiments at Hobart, where roasted ore was mixed with green ore, since this automatically provided the desired conditions.

Most of this discussion has been devoted to roasting as applied in plants using sulphate processes. For plants where a solution of zinc chloride is used, other considerations enter. Only one plant is operating in which zinc chloride solution is known to be prepared from roasted ore (Brunner-Mond & Co.). In this case no data is available as to the effect of sulphates in the electrolyte, but any zinc sulphate present would react with the calcium chloride solution used so that only the slightly soluble sulphate of calcium could be in the solution, and this is probably too small in amount to cause trouble. It therefore seems safe to say that for the Brunner-Mond process, a calcine containing zinc sulphate is acceptable.

In case the ore is to be treated with hydrochloric acid in order to take the zinc into solution, all the zinc sulphate present will be found in solution. This is very undesirable, as sulphates cause rapid deterioration of the carbon or graphite anodes used in electrolysis of zinc chloride solutions. Unless special arrangements are made to remove sulphates from these solutions, ordinary calcines are not acceptable and only calcines made by roasting very pure ore, such as that from Joplin, Missouri, at a high temperature in order to break up sulphate of zinc, is satisfactory.

The difficulties in obtaining satisfactory roasting, and the

low extractions made by the processes in which leaching solutions follow roasting, make it problematic whether chlorination processes, in which zinc sulphide is treated directly with chlorine gas, are not best. The writer has tested a number of these and finds that it is possible to make practically every atom of zinc soluble as zinc chloride. The present sulphate processes are simpler, less dangerous and more pleasant to the workers, but still leave much to be desired in recovery of the zinc.

CHAPTER IV

SULPHATE SOLUTIONS, LEACHING AND PURIFYING

The process of wet extraction of zinc most widely practiced in the United States or in the world, is "sulphate-leaching-and-electrolysis." An ore or other source of zinc is properly prepared for leaching and then treated with a dilute solution of sulphuric acid in order to take the zinc into solution as zinc sulphate. This solution is then purified from all interfering elements and submitted to electrolysis in order to recover metallic zinc at the cathodes and regenerate the sulphuric acid at the anodes. Since this solution is used again for leaching more ore, care must be taken that undesirable impurities do not build up in the cyclic travel of the solution.

Purification of solutions has come to be regarded as the most important step in the hydrometallurgy of zinc. Neglect to sufficiently purify the zinc sulphate solutions delayed for a great length of time the commercial success of wet zinc extraction. The electrolytic cell for decomposing these solutions is more sensitive to some impurities than are the methods of detecting them chemically. This accounts for the great number of instances in which seemingly inexplicable difficulties were met in depositing good zinc cathodes.

Leaching.—Properly roasted zinc ore, on treatment with dilute sulphuric acid solution, will easily give up all of its zinc content, forming a solution of zinc sulphate. However, in order that proper purification can take place it is necessary to form a neutral zinc sulphate solution, and this requirement introduces complications into the leaching process. It is difficult to extract all the soluble zinc by treating a batch of ore with just enough sulphuric acid to extract all the zinc and have no acid left over. Either an excess of acid must be used and the excess neutralized with zinc oxide, lime or lime-

stone, or some similar expedient resorted to. "Methodical," or counter-current leaching allows an approximation to this ideal.

Chemically, the problem consists in more than merely dissolving zinc oxide from the ore with dilute sulphuric acid solution. The average zinc ore calcine contains sulphates and oxides of zinc, lead, copper, iron, aluminum, manganese, silicon, and many other elements. The ore then must be so leached that only desirable elements go into solution. Fortunately, roasting renders the iron in most ores insoluble in acid for the most part, and likewise the alumina. Any lead oxide will require sulphuric acid to convert it to lead sulphate, which is insoluble in the solution. Part of the copper in the ore always dissolves and also a considerable amount of manganese, cadmium, arsenic, etc. Many of these impurities can be removed during the leaching, and consequently leaching and purification of solutions often take place in the same vessels.

Leaching consists in treating the prepared zinc product with enough dilute sulphuric acid to take into solution all the acid-soluble zinc. By performing the leaching in two steps, first treating the ore with excess of sulphuric acid, in order to insure complete extraction of all soluble forms of zinc, and then removing the solution to another vessel where an excess of ore is added to it in order to completely neutralize any remaining sulphuric acid, many of the impurities which dissolved in the first step are thrown down in the second and remain in the ore. This is known as "methodical" leaching. It is also known as counter-current leaching since the ore and the solution are traveling in opposite directions.

The solution used for leaching being return-liquor from the electrolytic cells, is not merely a dilute sulphuric acid solution. It will actually contain from 5 to 15 per cent of sulphuric acid, 2 to 10 per cent of zinc as zinc sulphate, accumulated sodium and magnesium sulphates (together with small quantities of other alkali and alkaline earth

sulphates), small quantities of iron, variable quantities of manganese, variable quantities of arsenic, and small amounts of many other elements which may accumulate in the solutions.

The solution made during leaching will be practically free of sulphuric acid, will contain 6 to 12 per cent of zinc as zinc sulphate, depending upon the experience of the particular plant, and variable amounts of iron, manganese, copper, cadmium, arsenic, antimony, silica, nickel, cobalt, chlorine, etc.

Machinery used for leaching zinc consists of adaptations of the leaching machinery which has been used for years in the hydrometallurgy of gold and silver, particularly in cyaniding. Agitators of the Pachuca or Brown type, the Dorr, the Parrall, etc., are used. Dorr classifiers, thickeners and settling tanks are likewise employed. The Pachuca agitator, of wooden construction, seems to be the most widely favored. The usual size of these tanks for zinc work is about 8 or 10 ft. in diameter and 20 to 30 ft. high—somewhat smaller than those commonly used for cyaniding. In the original Anaconda plant these “pachucas” received separate charges of ore and leaching solutions, and were operated till most of the dissolving reaction was over. The excess acid was then neutralized with either finely divided oxide-of-zinc ore, or by finely ground limestone. At the Trail plant the ore and solution are continuously fed to the first of a series of pachucas and passed gradually from one to the next, circulating many times in each agitator, until at last the pulp is discharged into a thickener where the solution can be allowed to settle and clarify. In other words, the original Anaconda practice treated batches of ore while the Trail plant treated a continuous stream of ore. Later, the Anaconda plant was converted to the continuous system. Complete flow sheets of several leaching and purification plants are given later in this chapter.

A common form of pachuca agitator is sketched in Fig. 4. It is a round, wooden tank, about 8 ft. in diameter and 20 ft.

high. A conical bottom is provided so that any particles which tend to settle will be deflected to the center. A central air lift of wood, provided with an inlet for compressed air, takes the pulp from the point of the cone, lifting it to the top of the tank quite rapidly. There is a condition of slow

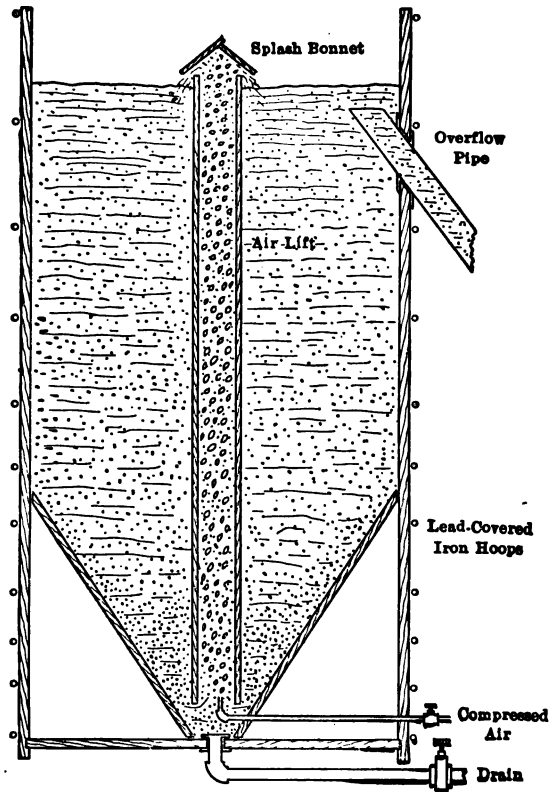

FIG. 4.—Pachuca agitator

settling in the main conical tank and rapid hoisting back to the top in the center. Particles go round and round in the tank and solids and solutions are well mixed together. If the tank is used for agitating successive batches of ore and solution together, the pulp is finally drawn out near the bottom, but if a series of pachuca agitators are used for

continuous treatment, measured amounts of ore and solution will be fed continuously into the first one and a corresponding stream of pulp will overflow continuously near the top of the tank into the next adjoining pachuca tank. This machine is too well known to need further description.

The time of agitation of zinc ore and leaching solution in pachuca tanks will vary from two to eight hours, depending upon the ore treated and the object in view—whether the last trace of soluble zinc is to be dissolved by excess sulphuric acid, or the excess sulphuric acid is to be neutralized by an excess of fresh ore. The latter step usually takes place in a few seconds in the laboratory, but requires a couple of hours in practice in order to allow efficient mixing.

Classifiers for the separation of sand from slime are also in common use by the various zinc leaching plants. Finely divided slimes need to be settled in thickeners in which sands are not desired, since they cause heavy strains on the rake arms of the thickeners. The Dorr classifier is of widest use and is well known in ore-dressing practice. It consists of a shallow trough into which a pulp is fed. Moving rakes push the quickly settling sand up an incline out of the pulp, while the slowly settling slime is kept stirred up by the movement of the rake arms and overflows from the other end of the machine with the water. In case the sand needs to be further ground in order that it can be efficiently leached, a classifier removes it from the remainder of the pulp ready for the grinding operation.

Thickeners are used for separation of finely divided solids from the leaching solutions. These are likewise machines adapted from cyaniding practice or from ore-dressing practice. They are merely round tanks with overflow launders encircling the top for the removal of clear solution and a discharge hole in the middle of the bottom for the removal of a thickened pulp. A vertical section through an ordinary thickener is given in Fig. 5 which explains itself.

Filters of many types are in use, such as old-fashioned plate and frame presses, Kelly pressure filters, drum suction

filters of the Oliver or Portland type, and many others. In the larger plants the drum suction filters are used because they are continuous and also adapted to taking the thickened pulp from a thickener. Fig. 6 is a photograph of the Oliver filters in the zinc plant at Great Falls, Montana.

Where the solutions are acid, wood or lead construction is used, but with neutral solutions wood, lead or iron is permissible. Thus, the pachuca agitators must necessarily be of wood, or wooden tanks lined with lead. Pipe-lines

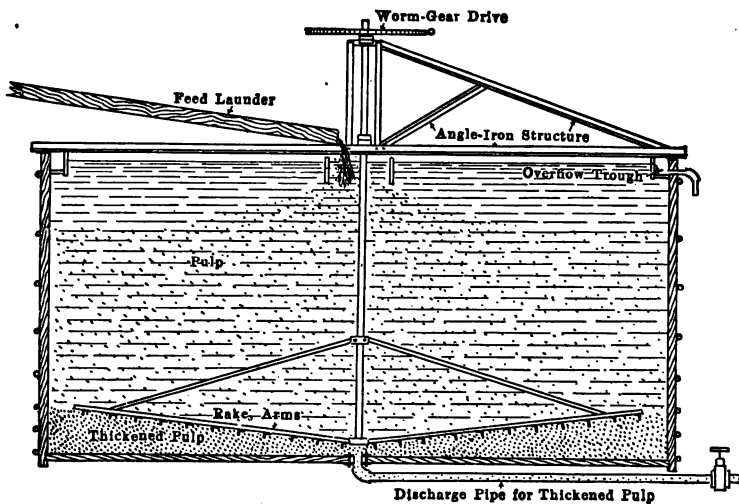

FIG. 5.—Dorr thickener

and pumps are generally made of lead or of lead-lined iron. The best classifiers and thickeners are of wood construction. Filters are of wood, lead, iron and bronze.

PURIFICATION OF SOLUTIONS

Zinc sulphate solutions contain two main kinds of impurities which must be removed:

1. Impurities which will accompany the zinc and render it impure. Cadmium is the most common of these.
2. Impurities which are likely to cause trouble in the recovery of the zinc. These consist of two classes:



Fig. 6.—Drum suction filters at Great Falls, Montana

- (a). Those which cause trouble in electrolysis.
- (b). Those which cause trouble in other operations.

✓ Cobalt and antimony are perhaps the two worst offenders in causing trouble during electrolysis. Silica and iron cause ✓ trouble in filtering or separating the solution from the insoluble residue.

Another class of impurities are those compounds in the solution which do not deposit with the zinc and which do not cause difficulty in other operations unless present in very large amount. Sodium sulphate and magnesium sulphate ✓ are examples of these latter compounds.

Impurities have also been classed according to whether they are cumulative or non-cumulative. Some impurities will be removed completely or nearly completely at each cycle while others will build up from harmless amounts in the first few cycles into very harmful quantities as the solution gets older, due to repeated use. Cobalt is an example ✓ of a cumulative impurity, although when present in the ore in small amounts it does not tend to accumulate.

The methods of removing impurities are best understood if discussed in connection with each impurity so the common elements which have been studied are taken up separately in the paragraphs which follow.

Iron.—This is an impurity which is always present in zinc ores and which must always be removed from the solutions in the regular course of their purification. If the ore is properly roasted all of the iron will be roasted to a ferric oxide, Fe_2O_3 , which is practically insoluble in sulphuric acid. Under all other conditions a greater amount of iron will dissolve in the leaching solutions. About 30 mg. of iron per liter of solution can be allowed during electrolysis, but above that the iron causes trouble. Supposedly, this is due to the fact that the iron is multivalent. Ferrous iron is oxidized at the anodes to ferric iron and the ferric ions when coming in contact with the cathodes are reduced to ferrous iron ions. This lowers the efficiency of zinc deposition, since the discharge of ferric ions at the

cathode goes on in place of zinc being deposited. Further, ferric iron solutions are reduced to ferrous iron solutions by zinc. If the iron can be made to remain in the ferrous condition in the zinc cell it has very little effect on the efficiency of deposition of zinc, although a small portion of the iron is deposited with the zinc. It is impossible to keep the iron in the ferrous condition without the use of a diaphragm cell and consequently it is necessary to remove iron in the purification system so that complications in the electrolytic deposition tanks are avoided.

Ferrous iron is not easily removed from zinc sulphate solutions, and in order to do this it is necessary to convert it into ferric iron. By blowing air (especially ozoneized air) through solutions containing ferrous iron, it is possible to convert the iron to the ferric condition. Any other oxidizing agent added to the solution will have the same effect, but usually compressed air is the most economical oxidizer. It has been found, however, that in acidified solutions ferrous iron is very slow to oxidize and it is necessary to reduce the acidity to nearly the neutral point or slightly beyond it in order to find a condition where air can quickly oxidize the ferrous iron to ferric iron. Although little has been written by the zinc metallurgists on the reason for this, it is perfectly well known among chemists that the hydrate of ferrous iron is oxidized with extreme ease, and that both ferric sulphate and ferrous sulphate solutions will hydrolyse to some extent when dissolved in water. This is particularly noticeable with ferric sulphate and ferric chloride solutions, and it is practically impossible to prepare solutions clear of all turbidity unless they are acidified. As soon as the acidity is neutralized these solutions start to hydrolyse, giving ferric hydroxide and sulphuric or hydrochloric acid. The chemical reaction involved is represented by the following equation:

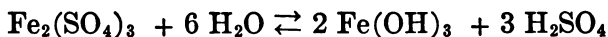

The ferric hydrate and sulphuric acid exist in equilibrium

with the ferric sulphate and water in the solution and by adding an excess of sulphuric acid the equilibrium in the above equation is driven to the left until practically no ferric hydrate remains. On the other hand, if any substance is present which can absorb the sulphuric acid formed by the above hydrolytic reaction, further hydrolysis will take place rapidly until all of the ferric sulphate has been decomposed. By filtering out the ferric hydrate precipitate the solution is found practically free from iron. Ferrous salts do not hydrolyse to the same extent as ferric salts and besides, ferrous hydroxide is relatively quite soluble while ferric hydroxide is practically insoluble in water. It is therefore easily seen why oxidation of the ferrous iron to the ferric condition is necessary and why the solution is always kept neutral or slightly basic during oxidation. The reactions which take place on neutralizing and agitating a ferrous solution with compressed air can be represented by the following equations:

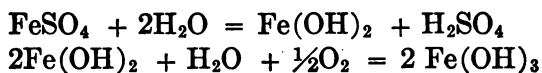

The materials commonly used for neutralizing the acid are zinc oxide, or an ore containing zinc oxide, ground limerock or whiting, and slacked lime. The reaction for complete hydrolysis of ferric sulphate in solution is represented as follows:

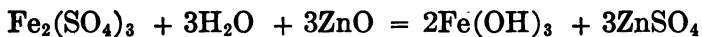

Or, where limerock or whiting is used,

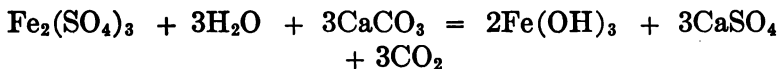

In the case where zinc oxide is used for the hydrolysis, the net result is that iron has been replaced from the solution by zinc and any iron sulphate formed by action of sulphuric acid on iron compounds merely reacts with zinc oxide to form zinc sulphate in the end. Thus, theoretically, no sulphuric acid is lost.

When calcium carbonate is used as the acid neutralizer during hydrolysis, the sulphate radical is locked up as calcium sulphate (gypsum) which is more or less insoluble in the zinc sulphate solution and remains with the ferric hydroxide. Zinc sulphate solutions are also hydrolyzed by CaCO_3 while hot or on long standing.

With a well-roasted ore no ferrous iron should be found in the leaching solution, but if any unroasted iron sulphide or any other metal sulphides are left in the solution the iron dissolves as ferrous sulphate and the hydrogen sulphide formed by the action of sulphuric acid on the other metal sulphides reduces some of the ferric sulphate in the solution to ferrous sulphate. Further, if the leaching solution comes in contact with metallic iron or metallic zinc, ferric iron is reduced to ferrous iron. Consequently, it is usually necessary to oxidize the solutions and hydrolyze them before they are suitable for use in the electrolytic zinc plant.

In practice, leaching and purification of the solution from iron often takes place in the same tank. At the original Great Falls plant of the Anaconda Copper Co. calcines were treated in pachuca tanks with the spent electrolyte returned from the zinc cells, and the sulphuric acid acted on the zinc oxide in the calcine, forming zinc sulphate, as well as reacting with other metal oxides to form their sulphates. An effort was made to use only enough leaching solution to take all the zinc oxide into solution. After several hours of agitating this ore pulp in the pachuca tank, the result was impure zinc sulphate solution with suspended solids like silica, ferric oxide, lead sulphate, dehydrated clay, etc. Without filtering out the solids the solution could be purified of iron by adding crushed lime rock to neutralize any remaining acid and cause the hydrolysis of iron compounds in the solution. The proper amount of crushed lime rock to add is determined by test, although an excess does no harm, since the calcium carbonate is insoluble in the neutral zinc sulphate solution and all calcium carbonate, calcium sulphate and iron hydroxide precipitates mix with the insoluble constituents of

the ore. The pulp was agitated for several hours by the air which drove the pachucas and also entered the reaction by oxidizing ferrous iron. Two to eight hours, or even longer, were consumed in oxidizing all the ferrous iron and precipitating it. Then the pulp was ready for separating the zinc sulphate solution from the insoluble residue. It is better to precipitate the iron hydroxide in the presence of the granular insoluble portions of the ore than to remove the latter before the iron is precipitated. The reason is that iron hydroxide precipitate is usually quite "colloidal," gummy and difficult to filter by itself. Further, one filtration is made to suffice for the removal of the insoluble portions of the ore and the iron hydroxide simultaneously.

At the Trail plant, and the present Anaconda plant, partly leached ore is treated in a series of pachuca tanks with excess of leaching solution, and the pulp then passes through Dorr classifiers to remove sands, and Dorr thickeners to remove slimes, and the slightly acid solution is sent to another series of pachuca tanks where it is treated with fresh calcine. There is more zinc oxide in the calcine than corresponds to the acid in the partly neutralized leaching solution so that there is excess zinc oxide available for hydrolyzing any iron sulphates present. The partly leached ore is then sent to the first series of pachucas.

Aluminum.—The presence of aluminum salts in zinc sulphate solutions improves rather than hinders the deposition of zinc, but aluminum is rarely found in the leaching solutions because during roasting of the ore any soluble forms of aluminum are converted to more or less insoluble forms. Thus clays and aluminum hydroxide are converted to dense forms of alumina which are practically insoluble in dilute acid. What little aluminum sulphate does form is hydrolyzed with the iron sulphate, forming aluminum hydroxide.

Arsenic and Antimony.—Both of these elements, especially antimony, cause serious trouble in the electrolytic deposition of zinc. They tend to accumulate in the solution as it circu-

lates from leaching tanks to electrolytic tanks and back. Hansen¹ has observed that their action is less prejudicial in the absence of manganese than when it is present. One milligram of antimony per liter of electrolyte has a bad effect and consequently extraordinary precautions must be taken to insure its removal. Arsenic is not so deleterious. At one time as much as 100 mg. per liter was found in the solutions at Great Falls during the treatment of some flue dust containing 12 per cent arsenic. This caused trouble.

—The common method of removing these two impurities is to insure the presence in the leaching solution of enough ferric sulphate to form ferric arsenate and ferric antimonate with them. If insufficient iron is in the leaching solutions it is necessary to add a solution of ferric sulphate made by dissolving scrap iron in sulphuric acid in the presence of oxidizing agents. When plenty of oxidized compounds of manganese are in the solution returning from the electrolytic plant the iron can be added as ferrous sulphate. In acid solutions ferric arsenate and antimonate do not precipitate, but as soon as the solutions are neutralized they precipitate completely from the solution. In other words, the same operation which removes iron from the solutions will also remove the arsenic and antimony, provided enough iron is present to combine with the two latter. Laist and Elton² have patented the addition of iron compounds in this manner in order to assure the removal of arsenic and antimony, although the insolubility of ferric arsenate under these conditions has long been known to chemists. They use manganese dioxide ore for oxidizing the ferrous sulphate solution to the ferric condition. In case this causes the formation of too much manganous sulphate in the leaching solution, reliance will have to be placed on air or ozonized air to oxidize ferrous hydroxide to ferric hydroxide during the hydrolysis, and the ferric hydroxide then combines with the

¹C. A. HANSEN: *Electrolytic Zinc*. Am. Inst. Mining Engineers 60:206, Colorado meeting, Sept. 1918.

²F. LAIST and J. O. ELTON: United States Patent 1,255,436, Feb. 5, 1918.

arsenic and antimony oxides or their acid compounds, arsenic acid and antimonious acid. A substantial excess of iron over that theoretically necessary is found imperative. Not only must the iron be completely oxidized, but the arsenic and antimony should also be in their higher states of oxidation.

When the solutions contain a large percentage of arsenic and antimony, so that it is inconvenient to add a large quantity of iron sulphates, other methods of removing the arsenic are used, all depending upon analytical methods which have long been known. Thus a fresh, bright copper surface is known to precipitate arsenic. Hydrogen sulphide will also throw out arsenic sulphide and antimony sulphide from the neutral or slightly acid solutions. A flue dust containing a high percentage of arsenic can be mixed with strong sulphuric acid and "fumed" by heating in a furnace of proper design, the arsenic passing into the fume and the zinc oxide forming zinc sulphate with the sulphuric acid. All of these methods have been commercialized and used in electrolytic zinc plants.

Caples and Frick¹ have patented and assigned to the Anaconda Copper Co. a method whereby copper sulphate is added to the solution of zinc sulphate after neutralizing to precipitate the iron, and the copper then precipitated with zinc dust. The freshly precipitated copper carries down the arsenic with it. At least one part of copper for one part of arsenic or antimony (calculated as trioxides) must be added. The completeness of the reaction is said to be somewhat dependent on the temperature at which the precipitation takes place, 80° C. being desirable. At lower temperatures a greater proportion of copper must be used. Copper can be added to the solutions in a number of ways, either by adding a solution of copper sulphate, or by adding copper sulphide ores to the zinc ore during roasting. The latter method is not economical in copper, as rarely more than

¹R. B. CAPLES and F. F. FRICK: United States Patent 1,263,852, April 23, 1918.

50 per cent of the copper in the zinc oxide calcine is soluble in dilute sulphuric acid solutions. Only enough copper need be added to make up for arsenic and antimony not removed by ferric hydroxide.

Both the hydrogen sulphide precipitation methods and the sulphuric acid fuming methods were used by H. R. Hanley at the Kennett, California, plant of the United States Smelting Co.¹ The sulphuric acid fuming method was desired because selenium and tellurium were also present in the ore, and sulphuric acid fuming tended to remove them almost completely during the roasting. Part of the arsenic is also removed in this way and the remainder by precipitation with iron hydroxide, and then by treatment with hydrogen sulphide. Hydrogen sulphide was made by treating a copper-iron matte with sulphuric acid. The sulphuric acid used for fuming was 50 per cent acid, a concentration easily attained in lead pans when evaporating dilute solutions

Complete removal of antimony seems to require its thorough oxidation in order that it will combine with the iron to form iron antimonate. Compounds like permanganates or ozone greatly assist in this final oxidation.

Cobalt and Nickel.—Cobalt has proved to be one of the most baffling impurities so far discovered in zinc sulphate solutions. Antimony caused trouble enough, but cobalt had not been suspected, and such minute quantities of it had such powerful effects that it was not identified for some time. Cobalt was first identified in solutions made during the development of a process for treating the Broken Hill complex sulphide ores. The work was carried on at the Bully Hill, California, testing plant of the General Electric Co., for the Electrolytic Zinc Co. of Australasia. Baffling resolution effects in the zinc deposition cells could not be attributed to any known impurity that could be identified. Synthetic solutions with every imaginable known impurity in all com-

¹See H. R. HANLEY: United States Patent 1,241,966 of Oct. 2, 1917.

binations failed to reproduce the same undesirable effects. Finally it was found that some of the manganese dioxide precipitated on the anodes in the electrolytic zinc tanks was different from ordinary manganese dioxide in that it caused the above-mentioned bad effects. It gave an uncertain test for cobalt. Professor G. H. Clevenger of Stanford University was commissioned to examine the manganese dioxide precipitate, and confirmed the presence of cobalt. The addition of cobalt to the zinc sulphate solutions proved it to be the disturbing element. Quite a number of methods for overcoming the difficulty have since been developed.

Cobalt (and nickel) requires a high oxidation potential to convert it to cobaltic condition. It resembles iron in that it forms cobaltous sulphate, CoSO_4 , and cobaltic sulphate, $\text{Co}_2(\text{SO}_4)_3$, and only the cobaltic sulphate is easily hydrolyzed. A neutral or slightly basic solution is not oxidized by air like the iron salts are, and it requires a more powerful oxidizer like ozone.¹ Manganese dioxide is slow to do this unless freshly precipitated. Lead peroxide is better, especially in the presence of manganese dioxide. Sixty parts of manganese and six of lead peroxide, or of calcium plumbate (which is more easily and cheaply made), are used for each part of cobalt, and the reaction is best carried on at 40-50° C. (See British patent 126,296 of April 28, 1919, also United States Patent 1,322,104 of Nov. 18, 1919. H. W. Gepp, D. Avery, R. H. Stevens, W. C. Snow and W. M. Whitecotton.) At the 10-ton pilot plant of the Electrolytic Zinc Co. of Australasia, Proprietary, Ltd., in Hobart, Tasmania, it was found that the addition of glue to the solution counteracted the bad effects of cobalt during electrolysis. Even a piece of canvas or a "gunny sack" suspended in the cell supplied organic addition agents which restrained the action of the cobalt. Five pounds of glue per ton of zinc produced will suffice for solutions containing up to 100 mg. cobalt per liter of solution. After that an additional pound of glue for each extra 50 mg. of cobalt

¹SAMUEL FIELD: United States Patent 1,331,334, Feb. 17, 1920.

must be added, and at about 250 mg. of cobalt it is necessary to purify the solution. The operation of the plant does not collect this much cobalt in the solution at one cycle so the solution is purified of cobalt only occasionally. The effect of the glue is now believed by metallurgists of the above company to be due to its forming complex ions with the cobalt ions, slowing down their migration velocity in the electrolysis of the solution. The use of the glue is due to R. H. Stevens of this company.

Another method of purifying the solutions of cobalt, mentioned in the above patent, is to heat the solution to 75° C. and add zinc dust or blue powder, in the presence of arsenic and preferably copper, twelve to fifteen parts of zinc and 1.5 parts of dissolved arsenic and copper being added per part of cobalt. The chemistry of this process is not explained, and it is difficult to see just how the cobalt is removed unless it be as arsenite or arsenide. It is stated that addition of the zinc is preferably made in stages, and part of the arsenic and copper kept back and added just before the last part of zinc goes in.

Clevenger has patented two methods of removing the cobalt. His first patent¹ states that the addition of manganates or permanganates to the zinc sulphate solution during the "lime" treatment in the cycle (hydrolysis of iron with limestone or lime), will also remove the cobalt. The solution should be neutral or slightly alkaline as in the hydrolysis of iron. In other words, if the hydrolysis operation is carried on with the addition of zinc permanganate (or other permanganates or manganates) toward the end of the operation, cobalt will accompany the iron.

In Clevenger's second patent, the addition of nitroso-beta-naphthol as a precipitant for the cobalt is recommended.² He states that in place of the nitroso-beta-naphthol, it is permissible to use beta-naphthol and sodium nitrite, added together or separately. Any excess of nitrous compound is

¹G. H. CLEVINGER: United States Patent 1,283,077, Oct. 28, 1918.

²G. H. CLEVINGER: United States Patent 1,283,078, Oct. 29, 1918.

converted by zinc dust into ammonia, which is harmless. Precipitation of the cobalt is best carried on in the slightly acid zinc sulphate solution, and any iron or copper present accompany the cobalt. Since the addition agent is expensive it is best to work with solutions from which the iron and copper have been removed. The precipitate is the familiar red cobalti-nitroso-beta-naphthol, so often seen in the laboratory of the analytical chemist. Somewhat more than the theoretical quantity of reagent is required.

Nickel has not been mentioned as occurring in any of the zinc ores which have been tested. It can be removed by hydrolysis of the higher oxidized nickelic sulphate which can be formed by the use of permanganates, lead peroxide and calcium plumbate. Nickel is somewhat more resistant toward oxidation from the lower valence compounds, but by raising the temperature of the solution to near the boiling point, nickel finally comes down as the black oxide, resembling the black cobalt oxide. Cobalt can be practically completely precipitated in cold solutions in the presence of nickel.

Oxidation by use of ozonized air has been patented by Samuel Field¹ who claims by this means the removal of iron, cobalt, arsenic and antimony. The use of ozone for this purpose is particularly desirable, as it introduces no further impurities into the solution.

Field has also patented a method of removing nickel and cadmium from zinc sulphate solutions² which consists in slightly acidifying the solution, heating it to 80-100° C., adding a small percentage of copper in a soluble form, then adding zinc "powder" and agitating the solution. By this method the nickel content is said to be reduced to substantially 0.5 parts per million of solution, or 0.5 mg. per liter. This process is almost identical with that of Caples and Frick, described above for the removal of arsenic.

Manganese.—As stated by Hansen (*loc. cit.*) manganese is one of the few elements which exert little harmful influence

¹United States Patent 1,331,334, Feb. 17, 1920.

²SAMUEL FIELD: United States Patent 1,337,058.

by itself at least, in the zinc cell. At Hobart, up to 15 gm. manganese per liter is not harmful. It accumulates in the solutions, being only partly precipitated in the zinc cell at the anodes. In the cells, manganous sulphate is oxidized at the anodes, going through various color changes, among which the green of manganates and the red of permanganates are sometimes observed, and finally being precipitated as black or brown hydrated peroxide at the anodes. This latter product is probably due to the well-known reaction of manganous sulphate on zinc permanganate formed at the anode. If glue is present in the solutions the manganese dioxide adheres better to the anodes. (See R. H. Stevens United States Patent 1,322,071 of Nov. 18, 1919.) Warm solutions are also better than cold solutions for making adherent deposits. This precipitated manganese dioxide almost always has lead peroxide present, possibly originating from the lead anodes or from minute amounts of lead present in the solution as dissolved lead sulphate. Very few zinc plants have operated with as high manganese content in the electrolyte as the Hobart plant.

That manganese is entirely harmless is somewhat open to question, since in combination with other impurities, especially arsenic and antimony, it seems to cause trouble, catalyzing the solution of the zinc cathodes in the dilute acid solution formed by electrolysis. The manganese is usually present in solution as manganous sulphate, although the liquor issuing from the electrolytic cells contains higher oxidized forms of manganese which are capable of oxidizing ferrous to ferric iron in the leaching stage. Manganous sulphate reacts with any soluble permanganate which is added to the solution during the hydrolysis of the iron, forming black hydrated higher oxides of manganese which accompany or follow the iron precipitate. However, permanganates are somewhat too expensive to encourage their use on any very extensive scale for this purpose. Lead peroxide and calcium plumbate also have the power of oxidizing manganese to the insoluble black dioxide, but have

not yet been prepared especially for this purpose. At the present date about the only manganese deliberately removed from the systems of the various plants is the dioxide precipitated on the anodes. With acidities below 60 to 70 gm. per liter (Hansen, loc. cit.) the manganese dioxide adheres to the anode, but at higher acidities it falls to the bottom of the cell as a finely divided powder. Hansen finds that this manganese dioxide contains 68 per cent MnO_2 , 13.7 per cent Pb and 1.2 per cent Zn. The lowest lead content encountered by him was 8 per cent. This was derived from solutions containing 0.04 gm. Mn per liter.

Thus far we have discussed only the impurities which are removed by oxidizing and neutralizing the ore pulp. Starting with iron, which is easily oxidized and hydrolyzed, arsenic, which is easily oxidized and combined with iron hydroxide, antimony, which is less easily oxidized and caused to combine with iron hydroxide (the last traces of antimony are removed only on adding stronger oxidizing agents than air or ferric sulphate), we reach cobalt, nickel and manganese, which require oxidizing agents of high potential, and even heating of the solution. One more impurity is also removed from solution during the hydrolytic reactions—namely silicic acid.

Silica.—This impurity is found in solution in the form of silicic acid which precipitates in a gelatinous form when the ~~ground limestone~~ or zinc oxide are added to hydrolyze iron compounds. At this point the addition of some zinc dust, in the presence or absence of copper salts,¹ precipitates residual traces of silica.

Why this latter effect should take place is hard to explain unless ions which are powerful in coagulating the colloidal silica are formed after the addition of zinc dust. Laist states in his patent that occasionally so much colloidal silica is present in the insoluble residue that it cannot be filtered efficiently when the zinc sulphate solution is to be separated from the insoluble portion of the ore. The filter cake retains 30 to

¹F. LAIST: United States Patents 1,281,031 and 1,281,032, Oct. 8, 1918.

80 per cent of zinc sulphate solution, and the cake is so gummy and impervious that it is impossible to wash out this solution on the filter. His two patents propose two methods of getting around this difficulty; one is to heat the filter cake to 150° C., at which temperature the silicic acid is dehydrated, leaving granular insoluble silica. This product can then be easily leached to remove the zinc sulphate solution present, and it can be washed with water to remove the last traces of zinc sulphate. Laist's other proposal is to repulp the slimy filtercake with plenty of water, thereby diluting the zinc sulphate solution present, and then allow the solids to settle out in a thickener in the regular manner, followed by a second filtration. The second filter cake could then be thrown away, as it would only contain a dilute zinc sulphate solution.

Trouble with silica is almost invariably met with when naturally oxidized ores, containing zinc carbonate and zinc silicate, are leached with sulphuric acid. Even the purest "carbonate" ores contain enough silica to cause disturbance. In the writer's experience as little as 0.5 per cent of SiO_2 in a neutral zinc sulphate solution will cause it to set to a gel on standing over night, and higher percentages of silica will act more quickly. The solutions are thick and viscous and filtration is almost impossible. The oxidized ores must be treated with strong sulphuric acid and heated to high enough a temperature to dessicate the silicic acid before anything can be done with a leaching process.

Copper, Cadmium, Lead.—All of the impurities discussed above can be and are commonly removed in the hydrolysis of the iron, before filtering the zinc sulphate away from the insoluble residue of the ore. After filtration it is common to treat the solution with one or another form of metallic zinc in order to precipitate copper, lead and cadmium. Copper and cadmium are present in the solution in quite large amounts and lead only in minute amounts, since lead sulphate is substantially insoluble in zinc sulphate solution. The copper is easily and quickly precipitated, but cadmium

is much more slowly removed. Both come down as a metallic sponge which must be removed in a filter-press.

Zinc dust made by atomizing molten zinc with a jet of compressed air, is the most popular form of zinc to use for this purpose, although electrolytic zinc sponge¹ has been proposed and tested at the works of the Anaconda Copper Co. during their earlier work. They likewise tested ball mills filled with zinc balls for precipitation of copper and cadmium, the theory being that the balls would keep themselves ground off clean and present very active surfaces² for the precipitation of cadmium.

The present practice in nearly all plants is to add zinc dust to the copper- and cadmium-bearing solution in an agitator, preferably of the pachuca type, and then pass the solution through a filter press to remove suspended particles of metal. A layer of zinc dust on the leaves of a filter press is often quite sufficient for the practical removal of copper and cadmium without any agitation or mixing in a pachuca tank.

Vanadium.—This is about the only remaining impurity which has been reported as troublesome in the electrolytic deposition of zinc. It is said by Hansen (*loc. cit.*) to be present in the Leadville complex zinc ores, but nothing is said about its removal from the solutions that might be made from such ores. The Western Chemical Co. plant at Denver receives ores from the Leadville district, but the writer has learned of no difficulty due to vanadium.

Chlorine.—The presence of chlorides in the zinc sulphate solution has been found to be objectionable, due to their causing corrosion of the lead anodes during electrolysis. The chlorides are derived from salt in the water supply or chlorides in the ore, the former being the main supply. In fact, the water supply of electrolytic zinc plants should be carefully investigated from this standpoint, since the presence of much chlorine causes the lead anodes to disin-

¹F. LAIST and J. O. ELTON: United States Patent 1,255,439, Feb. 5, 1918.

²F. LAIST and J. O. ELTON: United States Patent 1,255,434, Feb. 5, 1918.

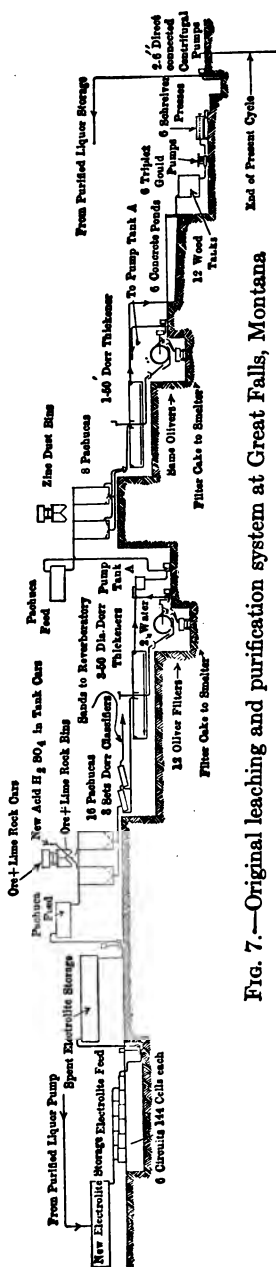

Fig. 7.—Original leaching and purification system at Great Falls, Montana

tegrate in a short time. Lead chloride is slightly soluble in water, whereas lead sulphate is practically insoluble.

Methods of removing the chlorides from solution are almost entirely restricted to the use of silver salts, like silver sulphate, in order to precipitate the chlorine as insoluble silver chloride. The large plant of the Electrolytic Zinc Co. of Australasia will include roasters in which, among other things, an attempt will be made to produce silver sulphate during roasting of the zinc-lead-silver sulphide ore. During the operation of the 15-ton test plant it was found that almost enough silver sulphate could be produced to take care of all chlorides in the incoming wash water of the plant.

It is not known just how low the chlorine content of the solution can be kept, but 50 mg. Cl_2 per liter of solution is known to be about the upper limit beyond which anode corrosion becomes serious.

Leaching and Purification at Great Falls.—The above discussion of the effects of various impurities and the methods for their elimination makes it possible to understand the original flow sheet of the Anaconda plant at Great Falls (see Fig. 7). This is an idealized flow sheet, and does not show the various pieces of apparatus in their actual relative

positions, but arranged in one long string in order to simplify the flow sheet.

The purified liquor from the leaching and purification system enters an electrolyte storage tank from which it is drawn as needed to the tank room, where it is electrolyzed to form zinc cathodes and dilute sulphuric acid containing some undecomposed zinc sulphate (it is not economical to strip the solutions of zinc by electrolysis, and since the solution is reused in the leaching plant, there is no need to deposit all the zinc in the solution at one passage through the cells). This liquor is collected in another storage tank ready to use in the leaching system, being lifted to a supplementary feed tank by a centrifugal pump made of lead. The tanks are lead-lined.

The roasted ore is taken into the top of the leaching plant in cars on a high trestle. These cars dump into storage bins above the pachuca agitators in which the calcine is treated with dilute acid solution. There are two rows of these agitators, and the proper quantities of calcine and solution are measured into them. After several hours of contact the acidity has fallen to a low figure and much of the zinc has been dissolved. Ground lime rock (likewise brought in on cars and stored in bins) is then added in excess of the amount necessary to neutralize the remaining sulphuric acid and agitation is continued for several minutes longer. During this neutralizing the iron present is oxidized and hydrolyzed, carrying down with it the arsenic and antimony and most of the silica from the solution. Various other impurities can also be removed in these tanks, as described under the individual headings above, the manipulations depending upon which impurities are present and in what amounts.

When the charge in each pachuca has been sufficiently agitated, it is fed to a series of Dorr classifiers. In the first one the sand is separated from the slime and solution. In the remaining classifiers the sand is washed with water to remove adhering solution, and finally the washed sand is sent to the smelter so that its content of silver, lead, copper

and other valuable metals can be recovered, and any remaining zinc volatilized and recovered as a zinc oxide fume.

The slime and solution from the classifiers pass to a set of Dorr thickeners of wood and lead construction, in which the slime settles out. The thickened slime pulp is then filtered in a series of Oliver continuous drum suction filters (wood, lead and iron construction), and two sprays of water wash the filter cake as it passes under them on the way to the discharge scrapers. This filter cake is likewise sent to the smelter for recovery of metals. The filtered and decanted solution, from the filters and thickeners respectively, is then pumped back to the pachuca agitators, where it is treated with atomized zinc and agitated until all copper, cadmium and other precipitable metals are thrown out of solution. The solution then passes to a Dorr thickener and Oliver filters in the same manner as before to remove the metallic zinc, copper, cadmium and other metals.

This solution is still somewhat murky and is allowed to pass through long settling ponds made of concrete, and finally into a row of wooden tanks. Finely divided ore slime and spongy metal separate in all of these containers. Before sending the solution to the electrolyte storage tank it is forced by Gould triplex pumps through bronze Shriver filter presses, using canvas as the filtering medium. The finished neutral electrolyte is then pumped to the electrolyte storage tank at the head of the tank house.

Redwood tanks are used, and the iron hoops are encased in lead, throughout the plant. While the solution is acid or contains copper it must not come in contact with iron on account of the chemical action, but neutral pure electrolyte has practically no action on iron. Most of the pumping is done with cast lead pumps, and the lines are either lead pipe or rubber hose. The same applies to practically every sulphate electrolytic zinc plant at present operating. Bronze parts are permissible in those portions of the system ahead of the point where copper is removed from solution by the use of zinc dust.

After the continuous leaching and purification system at Trail showed signs of success, the Great Falls plant was rearranged into a similar system, as shown in the flow sheet

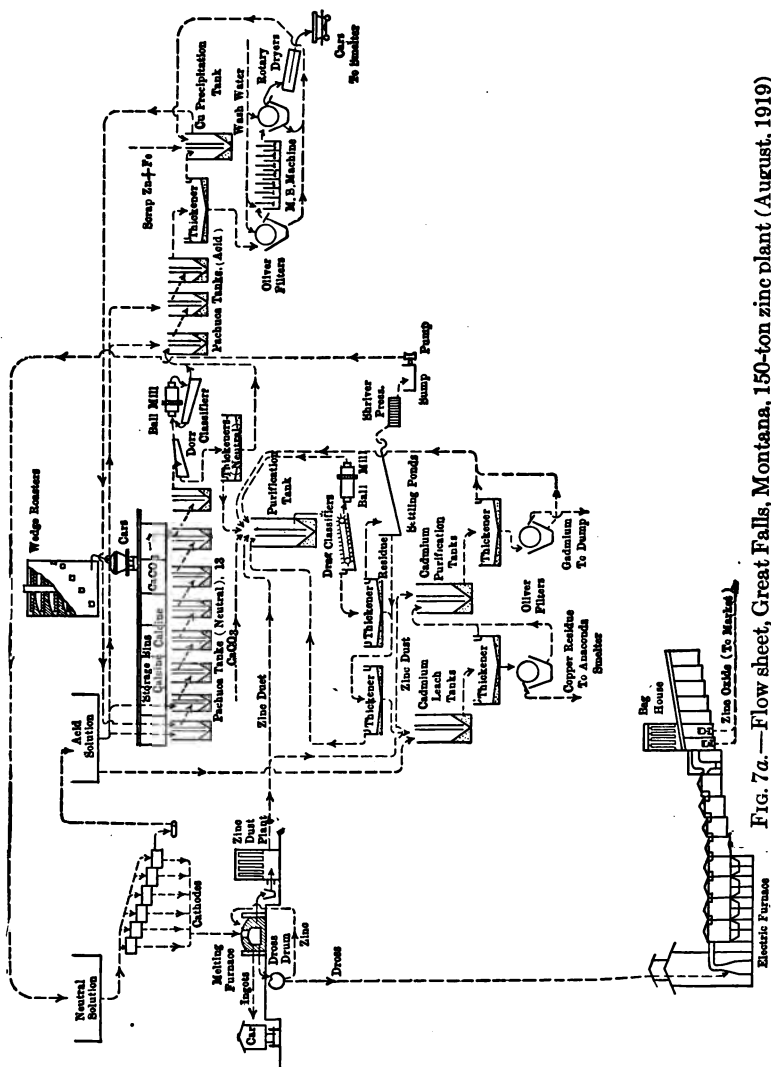

Fig. 7a.—Flow sheet, Great Falls, Montana, 150-ton zinc plant (August, 1919)

(in use Aug., 1919) of Fig. 7a. The calcine from the Wedge roasters was still transported by cars to the storage bins above

the pachuca tanks. Thirteen of these tanks were connected in series, so that the partly neutralized solution from a later step in the process could be treated with excess of calcine in these pachucas and passed continuously down the line. Only seven of the pachucas are indicated in the flow sheet. Powdered lime rock was fed into the sixth tank to neutralize the last traces of acidity and complete the precipitation of the iron and other impurities. The overflow from the last tank was passed to a Dorr classifier, and the sand passed on to a ball mill running in closed circuit with another classifier. The slime was thickened in a Dorr tank, and the thickened slime joined the ground ore. This pulp was mixed with the acid solution in proper proportion, so that a slight excess of acid existed over that necessary to leach the soluble constituents of the ore and passed to a second series of pachuca tanks (called the acid series). Here the remaining zinc was leached out. The pulp passed into a thickener, the overflow solution then passed back to the head of the first (neutral) series of pachucas to be completely neutralized by the fresh ore. On the way it was passed through a pachuca tank containing scrap zinc and iron, on which copper could be precipitated together with some arsenic and antimony. No cadmium precipitates at this point, due to the fact that the solution is slightly acid. The thickened sludge from the "acid" thickener was passed to Oliver filters, as in the original plant. The filter cake was then repulped with wash water by passing it through a Minerals Separation flotation machine, and then filtered on a second set of Oliver filters. In this manner the zinc sulphate solution lost in the tailing was reduced to a minimum. The final filter cake was then dried and dropped into cars to be sent to the reverberatory furnaces in the copper smelter for recovery of copper matte carrying the gold and silver of the ore, and a lead-zinc fume which was caught in a bag-house and shipped to the lead smelter at Toole, Utah.

The neutral zinc sulphate solution from the neutral thickeners overflowed to a series of purification pachucas

where more lime rock and some zinc dust were added to further purify the solution of iron, arsenic, cobalt, cadmium and similar impurities. Following the purification tanks came a drag classifier to recover coarse particles of zinc so that they might be further ground in a ball mill and returned to the purification tank. The pulp then passed to thickeners, followed by concrete settling ponds where most of the suspended ore slime and precipitated metals was collected. The solution was finally clarified by passage through the Shriver presses used in the original plant, and was then ready to be pumped to the neutral solution storage tank above the electrolytic tanks.

The sponge metal from the thickeners and settling ponds was passed through cadmium leaching tanks (pachucas) and mixed with a restricted amount of acid solution from the acid solution storage tank. Here only the cadmium and zinc dissolved, leaving the precipitated copper undissolved. On passage through a thickener this copper and some ore slime settled out and were filtered in an Oliver filter, yielding a cupriferosus filter cake suitable for the copper smelter. The zinc and cadmium sulphate solution passed to the "cadmium purification tanks" where the cadmium was precipitated by the use of zinc dust. This was likewise caught by use of a thickener and a filter and the cadmium stored on a dump awaiting future disposal.

Zinc dust was made by putting molten spelter from the melting furnace into a Rockwell furnace which allowed a small stream of molten zinc to be poured into a V-shaped jet of compressed air issuing from a special nozzle, where it was atomized. The atomized zinc dust was caught in a bag-house. The dross from the melting furnace was put into a rotating drum which allowed all the molten zinc to be shaken out of the dross and returned to the melting furnace. The dross passed to an electric furnace where it was mixed with carbon and distilled. The zinc vapor was allowed to mix with air and burn to zinc oxide, which was caught in a bag-house. This zinc oxide, being free from lead, is of great

value in the rubber trade, and can therefore be marketed to advantage in this form. This experimental zinc oxide plant was later abandoned due to difficulty in getting a pure white product.

Leaching and Purification at Trail, British Columbia.—
An idealized flow sheet of the Consolidated Smelting &

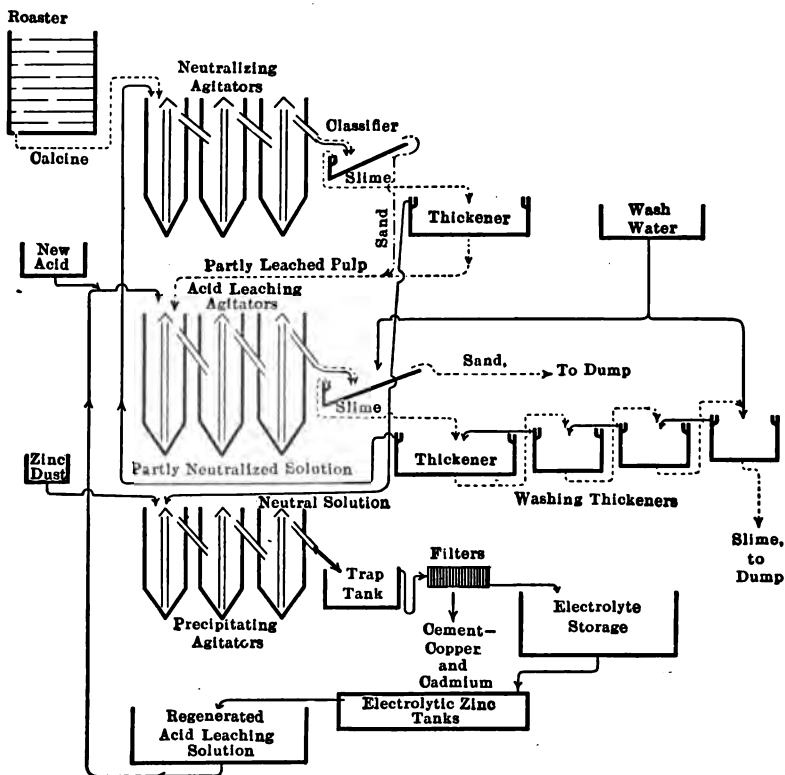

FIG. 8.—Idealized flow sheet of Electrolytic Zinc Plant at Trail, British Columbia

Refining Co. of Canada, Ltd., at Trail, British Columbia, is given in Fig. 8. This flow sheet is derived from United States Patent 1,320,805 of Nov. 4, 1919, which was granted to R. H. Stewart, S. G. Blaylock, R. Vaughan and J. K. Batchelder, as well as a description of the plant

given by E. H. Hamilton in a paper before the American Electro-chemical Society at Pittsburgh, Pennsylvania, in Oct. 1917.¹

A visit to this plant just before sending this book to press revealed a number of additions to the flow sheet. The partly neutralized solution, before entering the neutralizing agitators, was passed through two "manganese pachucas" where manganese dioxide sludge from the electrolytic deposition tanks was added to completely oxidize any ferrous iron present. The solution at this point contains only 0.5 per cent sulphuric acid.

Experience also showed that one thickener was not sufficient to clarify the neutral solution, so that five additional thickeners receive the overflow of the single thickener shown in the flow sheet, the solution being divided between them, in order to further clarify the somewhat turbid overflow from the first main thickener. Even this settling capacity is insufficient and some turbidity passes on with the solution to the precipitating agitators and is finally removed from the solution, together with the zinc dust precipitate in the Kelley filters just preceding the electrolyte storage tanks.

The sand residue from the acid leaching agitators is washed and reground with water and treated in flotation machines to catch any particles of zinc sulphide that escape roasting and leaching. The flotation concentrate is returned to the roasters. Most of this zinc sulphide is the result of lumps of concentrate that form in the roaster during drying out of the material fed to the plant. It is difficult to prevent the formation of these lumps in the roaster, and they invariably carry cores of unroasted material.

American disc filters are used in this plant for dewatering the thickened slime from the washing thickeners.

The ore is roasted in thirteen Wedge roasters with seven hearths each. An average analysis of the ore fed to the plant is as follows:

¹Trans. American Electrochem. Soc. 32:317-319 (1917).

Lead.....	6-14%
Iron.....	23-31%
Insol.....	4%
Alumina.....	3%
Lime.....	2%
Magnesia.....	2%
Sulphur.....	24-29%
Zinc.....	16-20%
Cadmium.....	0.04%

Experience has demonstrated that it must be crushed to about the following screen analysis before roasting and leaching:

On 48 mesh screen.....	3%
On 100 mesh screen.....	10%
On 150 mesh screen.....	3%
On 200 mesh screen.....	12%
Through 200 mesh screen.....	72%

Recently a flotation plant has been installed to concentrate this ore and the flotation concentrate now going to the zinc roasters contains 27 per cent zinc, 12 per cent lead and 21 per cent iron.

The calcine is treated with partly neutralized spent electrolyte in a series of "neutral pachucas" until the solution is quite neutral. It will be noticed that this practice differs from that at Great Falls where neutralizing takes place by the use of lime rock. Solution and ore are fed continuously to this series of pachuca tanks and circulate in each tank, finally passing into the next one and so on until discharged from the last one into a Dorr classifier. Here the sand is removed and the solution, carrying the slime, passes to a series of Dorr thickeners. The thickened pulp is then combined with the sand from the classifier and enters the series of "acid pachucas" similar to the neutral series. In these agitators the pulp is mixed and agitated continuously with fresh acid solution from the electrolytic cell room and enough solution is used to convert all zinc oxide into zinc sulphate. Curiously enough, very little of the ferric hydroxide formed in the neutral pachucas redissolves here. The solution from the last agitator flows out into

another Dorr classifier and a series of Dorr thickeners, where the acid solution is separated from the exhausted ore. The solution is used in the neutralizing agitators first mentioned. The series of Dorr thickeners at this point is operated in counter-current with wash water in order to wash out all zinc sulphate solution before the ore residue is discharged to the dump, or it is sent to the lead smelter, depending on its metal content.

As seen in the flow sheet, the overflow from the neutral thickener goes to a third series of pachuca agitators, in which the solution is treated with zinc dust in order to precipitate the copper and cadmium. The solution, after leaving the last agitator passes through a trap tank where much of the excess zinc with the precipitated copper and cadmium settles out. The remainder is caught in Kelly filters so that only clarified electrolyte passes on to the electrolyte storage tank above the electrolytic cells.

Enough ore is treated to yield fifty tons of zinc cathodes daily in this plant, although seventy-five tons could be made. This involves about three hundred tons of crude ore.

Net Recovery of Soluble Zinc.—The practice at Great Falls and at Trail has been more or less followed by other plants, and nearly all of them, when treating zinc ores or concentrates, extract 70 to 80 per cent of the total zinc in the ore. The recovery of the acid-soluble zinc is about 95 to 98 per cent, obtained in solution, the remainder being held as zinc sulphate solution wetting the ore residue. The insoluble zinc is composed largely of unroasted zinc sulphide or of zinc ferrite. While the leaching efficiency for acid-soluble zinc is high, it has been a great disappointment that a total extraction of the zinc has not been more nearly approximated. Even though 75 to 80 per cent of the total zinc is obtained in solution, this is not all recovered as slabs of zinc from the melting pot where the zinc cathodes are melted down. About 5 per cent is obtained as a dross from these melting pots, and due to the fact that chloride fluxes are generally used for melting zinc, this dross cannot be

reused in the plant unless special precaution is taken in fuming off the chlorides as hydrochloric acid by treating the dross with strong sulphuric acid.

At Great Falls the residue from the zinc plant was for a while smelted in a reverberatory furnace. About 20 per cent of the zinc in this residue was volatilized, together with most of the lead and the copper, silver and gold collect in a matte beneath the slag formed by the other insoluble constituents of the ore. The zinc oxide-lead sulphate fume was collected in a bag-house and returned to the leaching plant, but is now shipped to a lead smelter. At Trail the residue is smelted in lead blast furnaces, and most of the residual zinc passes into the slag. However, this is not a great drawback at Trail as the electrolytic zinc plant was originally built to remove part of the zinc from the lead-silver ore normally fed into the lead smelter. More recently the Trail plant has found that zinc ferrite decomposes in pyrites burner gases at about 400-500° C., forming zinc sulphate and iron oxide.

Unit Figures on Leaching Machinery.—The following unit figures for leaching machinery in zinc leaching mills are the average results obtained in a number of plants.

Agitators.—About three hours' agitation is usual with a charge of zinc ore and leaching solution. With ores, such as those at Trail and Great Falls, the solution ratio figures out four to five tons to one ton of ore, and the total agitator space necessary is about 30 cu. ft. per ton calcine leached per twenty-four hours. Thus 10 ft. x 20 ft. pachuca agitators should treat about twenty to seventy-five tons calcine per day, and use 300 tons of leaching solution.

With zinc dust in the agitators a much greater capacity is obtained, since the time of contact need not be so long. The zinc dust used is from 2 to 4 per cent of the final weight of zinc. At Trail, with a 50-ton daily capacity, about one to two tons of zinc dust daily are used, and at Great Falls with 150-ton capacity, ten to twelve tons of dust are needed. Two hours' agitation are sufficient, and hence only

40 cu. ft. agitator space per ton solution per twenty-four hours is needed. A 10 ft. x 20 ft. pachuca will handle 350 tons of solution in a day.

Classifiers.—Dorr classifiers have about the same capacity for separating the sand and slime in zinc sulphate solutions as they have in water pulps. For instance, a good classifier will easily treat the pulp containing one hundred tons of ore in twenty-four hours.

Filters.—So much depends upon the physical condition of the ore that it is difficult to find any agreement among the figures on the filters used. The Oliver filters at Great Falls each handle about 120 tons of thickened sludge containing two parts of solution to one of solid, with a filtering surface of about 450 sq. ft.

Thickeners.—From 5 to 10 sq. ft. of thickener area will handle one ton of the usual zinc ore tailing products per twenty-four hours.

CHAPTER V

ELECTROLYSIS OF ZINC SULPHATE SOLUTIONS

General Practice.—Most of the electrolytic zinc on the market at the present time has been made from zinc sulphate solutions. The cell for decomposing zinc sulphate solutions is much more simple than the one necessary for zinc chloride, and a number of similar advantages make the sulphate leaching and electrolysis processes preferable to chloride processes.

An electrolytic zinc cell is very sensitive to the effects of impurities which either cause the zinc to deposit in a spongy or loose condition, or cause re-resolution of the zinc in the sulphuric acid solution. On that account the processes of purifying the zinc sulphate solution previous to electrolysis are most highly important. It has been well said that the zinc cell is more sensitive to some impurities than are the analytical methods of detecting them.

The solutions entering the cell room from the purification department will usually contain 6 to 10 per cent of zinc, and will be neutral in reaction. A number of plants find it advantageous to acidify the solution before electrolysis, but this is not universal practice. A very slight acidification will suffice to get the solution into a condition such that sponge-zinc cannot form. The amounts of impurities commonly allowed individually in the solutions were mentioned in Chapter IV, but can be summarized as follows:

- 10 mg. copper per liter.
- 350 mg. manganese per liter.
- 1 mg. arsenic per liter.
- 1 mg. antimony per liter.
- 30 mg. iron per liter.
- 12 mg. cadmium per liter.
- 1 mg. cobalt per liter.

These figures are by no means fixed and rigid, but usually they can not be exceeded without special arrangements in

the plant having first been made to take care of these impurities. It is desirable to have solutions containing much less than the above mentioned amounts of impurities if a number are present simultaneously.

The solutions issuing from the cell room are commonly from 2 to 4 per cent zinc and 4 to 15 per cent sulphuric acid. The electrolysis of the zinc sulphate solution results in the formation of zinc and some hydrogen at the cathodes, and of the equivalent oxygen and sulphuric acid at the anodes. One pound of zinc is combined with 1.5 lb. of sulphuric acid in zinc sulphate, and hence for every per cent of zinc removed from the solution by electrolysis the acidity is raised 1.5 per cent. Thus, if a 6 per cent zinc solution went into the cell room in a neutral condition and were electrolyzed down to 2 per cent zinc, the final acidity would be 6 per cent H_2SO_4 . So far it is impracticable to completely strip a zinc sulphate solution of its zinc content by electrolysis, as will be seen later.

The general practice is to electrolyze in tanks similar to those used in electrolytic copper deposition. The anodes are of sheet lead, about 3 ft. square, and the cathodes are of sheet aluminum or sheet zinc of the same size and spaced about two inches away from the anodes and parallel to them. Anodes and cathodes are hung alternately in the tanks and all the anodes and all the cathodes of each tank are connected electrically in multiple. A 5000-ampere cell will have about ten cathodes, if the cathode current density is about twenty amperes per sq. ft. Each cell calls for about 3.5 volts, and enough of them are connected in series to allow the use of generators which supply energy at from one hundred to five hundred volts. At Trail thirty-two cells are connected on each circuit, and about 125 volts are needed at the generator.

The current density at both anodes and cathodes will be from ten to twenty-five amperes per sq. ft., depending upon the experience of the plant in question. Even higher current densities have been tried, but the solutions become so

heated, due to secondary reactions taking place in the cells and to electrical resistance, that too much artificial cooling of the solutions becomes necessary.

The solution commonly flows through a series of tanks "in cascade" so that each tank is receiving a solution of constant acidity and zinc content, but the acidity increases and the zinc decreases as the solution passes down the line. Cascades of five to ten tanks are common. The solution is fed into the cell in such a manner that it will flow between each pair of plates and pass out of the opposite side of the cell. The best natural and uniform circulation possible is desired, since the deposit of zinc in a portion of the cell not receiving good circulation is different in nature from the zinc in a well-supplied section. Some operators favor a high rate of circulation and provide pumps or air lifts to return part of the solution to each cell or to agitate the solution in the cell. It has been the common experience that new plants will be found wanting in circulation facilities when first started and that increasing installation of circulating machinery takes place till quite violent circulation is used. Then, by gradual changes, the distribution of solution through the cells is improved and less circulation is found to do just as well. The final operating condition is that of no extra circulation over that caused by the solution passing quietly through the cell. By using rapid circulation good deposits of zinc can be obtained from more impure solutions than can be worked in quiet tanks. Smoother and thicker cathodes also result from a pure solution, it being found unnecessary to strip the cathodes as frequently.

Fundamental Principles.—Zinc has such a high affinity for oxygen that it is somewhat difficult to separate it from solution by electrolysis. Finely powdered zinc (zinc dust) will slowly decompose water with evolution of hydrogen, even at ordinary room temperatures. It is practically impossible to dry a sample of wet zinc dust without serious oxidation, even at low temperatures, and even then it is impossible to melt the resulting dry powder, due to non-

coalescence of the globules of zinc. It is therefore imperative to obtain coherent deposits of zinc when its solutions are electrolyzed, and all tendency to form sponge metal or "trees" should be corrected.

In order to obtain coherent reguline deposits it is necessary to adhere to certain well-defined rules which have been established and which are discussed below.

Current Density.—The density of the current at the cathodes is the main point of interest in a zinc cell. Little attention is paid to the anode current density. Since the cathode usually consists of a thin sheet of aluminum or of zinc, the current density is calculated for the two faces of the sheet. Thus a cathode 3 ft. x 3 ft. in area has 9 sq. ft. on each face, or a total surficial area of 18 sq. ft. available for the deposition of zinc. The common current densities in practice vary from ten to twenty-five amperes per sq. ft. of cathode surface. Zinc is very prone to deposit in "trees" or "sprouts," especially along the edges of the plates, but it is very important to obtain uniform distribution of the electrical current over the cathode surface. To that end, the anodes are also made of sheet metal (lead) and are spaced as nearly parallel to the cathodes as possible. The anodes are also commonly an inch or more smaller all around, in order that there will not be a crowding of current at the sharp edges of the cathodes. In spite of all this care, there is usually a row of trees all around the edge of an electrolytic zinc cathode when it is removed from the bath.

Current Efficiency.—The current efficiency (or ampere-hour efficiency) obtainable in a definite zinc cell, from a definite solution, is one of the most important factors which must be observed. So many things tend to depress current efficiency that it is easy to understand why the development of the art has been so slow.

Theoretically, one ampere flowing for one hour (one ampere-hour) should deposit 1.2194 gm. metallic zinc from any of its solutions. Actually, this figure is never quite attained, although 96 to 98 per cent of this amount (96 to 98

per cent current efficiency) is often obtained in the first stages of electrolysis of pure solutions.

The operation of a zinc cell is complicated by the fact that sulphuric acid is formed during the electrolysis and remains in the solution, and further, zinc dissolves in dilute sulphuric acid, so a certain amount of corrosion or re-solution of the deposited zinc is going on all the time, making 100 per cent current efficiency impossible. The nearer the zinc is to being pure the slower is its corrosion, or the nearer it is to being "passive." The presence of even minute amounts of more electronegative impurities, like arsenic, antimony, copper, cobalt, etc., increases the rate of corrosion of the zinc and it has been observed that the hydrogen resulting from the action of the acid on the zinc is mostly deposited on the little specks of impurities present. This is similar to the action of the primary cell where zinc is used as an anode, and a less electropositive metal for cathode. On making electrical contact between the zinc and the other metal the zinc goes into solution in the electrolyte, while hydrogen is deposited at the cathode. The amount of corrosion has been determined to be a function of the amount and kind of impurities present and of the concentration of the sulphuric acid in the electrolyte.

↘ A typical curve of corrosion as a function of acid concentration has been given by Hansen¹ whose curve is reproduced in Fig. 9. This was determined by suspending pieces of smooth cathodes in active cells, but out of electrical contact with the bus bars. Thus a fairly accurate measure of the corrosion was obtained. For convenience, Hansen has also translated the results into equivalent amperes per sq. ft. Thus, with a solution containing 100 gm. H₂SO₄ per liter the corrosion amounts to about 65 gm. zinc per sq. ft. cathode surface per twenty-four hours, which is equivalent to the amount of zinc that would have been deposited by a current of 2.3 amperes acting for the same time. In other

¹C. A. HANSEN: Electrolytic Zinc. *Trans. Am. Inst. Mining Engineers*, 60:206 (1918).

words, if the current density in the cell while at that acidity had been only 2.3 amperes per sq. ft. deposition of zinc would have taken place at the same rate as corrosion of zinc and the result would have been no zinc deposited and merely an evolution of hydrogen at the cathode.

Corrosion, being a chemical reaction, should be more rapid at high temperatures than at low, and hence, from a current efficiency standpoint, pure, cold solutions are desirable in order to keep down corrosion.

Another complication causes lowering in current efficiency. The zinc sulphate solutions contain hydrogen ions, due to

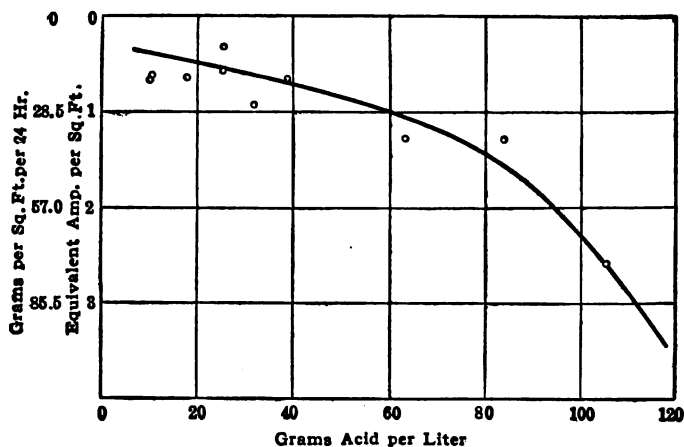

FIG. 9.—Corrosion of smooth cathodes, suspended in active cells, but insulated from bus bars. Bully Hill, March, 1915. (C. A. Hansen)

dissociation of water and of sulphuric acid, and these ions compete with zinc ions to be discharged at the cathode. Fortunately, the over-voltage of hydrogen on a zinc cathode is so high that zinc is deposited preferentially, unless, due to depletion of the electrolyte or poor circulation there are not enough zinc ions in the solution in contact with the cathode at any given instant. Hydrogen has a higher over-voltage on zinc than on almost any other common metal except mercury. Consequently, if the zinc sulphate solution is impure, the moment an atom of impurity is deposited on the

cathode, along with the zinc, it becomes the center where hydrogen ions can be more easily discharged than on the zinc surface. Hydrogen is therefore deposited at impure spots, due both to re-solution of zinc and to direct electrolysis of the water or sulphuric acid in solution. Raising the current density increases the hydrogen over-voltage and raising the temperature decreases it. From this standpoint, it is therefore desirable to have pure cold solutions and high current density.

If the solution is too dilute in zinc, or is not circulated sufficiently rapidly to remove the depleted layer of electrolyte in direct contact with the cathode, evolution of hydrogen takes place. Hence, it is desirable to have a certain minimum circulation. However, the circulation of solution brings more sulphuric acid in contact with zinc, allowing faster corrosion, and it is easy to conceive of there being too much circulation to allow of efficient deposition of zinc. We therefore conclude that there is a certain optimum amount of circulation corresponding to each set of conditions in order to get the best current efficiency. Another conclusion is that the solution must not be too dilute in zinc. Concentrated solutions of zinc do not require as much circulation as dilute ones, since they have an ample supply of zinc ions.

Finally, corrosion is a function of the surface exposed and is greater for loose, spongy or warty deposits of zinc than for smooth ones. It is therefore desirable to supply all parts of the cathode with equal quantities of solution and to have no points of higher concentration of the electric current. Anything which will contribute to smoothness of a deposit will increase the current efficiency. The addition of small amounts of colloids, like glue, to the zinc solution has this effect, and the presence of aluminum salts in the solution also seems to improve the smoothness of the deposits. Loose, spongy deposits or trees tend to grow out into the cell and short circuit between the anode and the cathode. They also hold large amounts of solution when the cathode is

removed from the bath, cannot be dried without oxidation, and are difficult to melt.

Hansen has given some curves for the current efficiency of a zinc cell operated at constant acidity for a series of days. Two of his sets of curves are given herewith (Figs. 10 and 11)

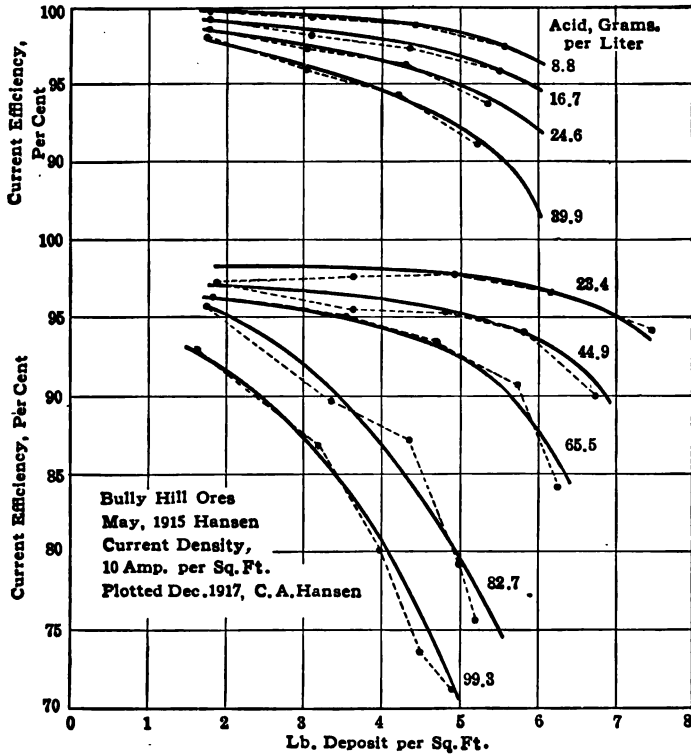

FIG. 10.

and show the current efficiency plotted as a function of the thickness of the zinc deposit (lb. zinc per sq. ft. cathode surface). The heavier deposits are, of course, the older, and at any acidity the falling off in current efficiency, due to increased corrosion, becomes quite important after two or three pounds of zinc have been deposited on each square foot of cathode, and a 5-lb. deposit is practically the commercial

limit for all solutions except those very low in acidity. In other words, in a cell house where the solution descends through a cascade of cells, the cathodes in the upper cells of the cascade can be allowed to remain in the tanks longer than can those farther down in the series, due to the increasing acidity formed by electrolysis. The cathodes at the bottom of the cascade receive solution which is quite acid, and hence they can only be allowed to remain in the tanks until two or three pounds of zinc per sq. ft. have been deposited. Roughly, with cells operating at fifteen amperes per sq. ft., almost one pound of zinc should be deposited in

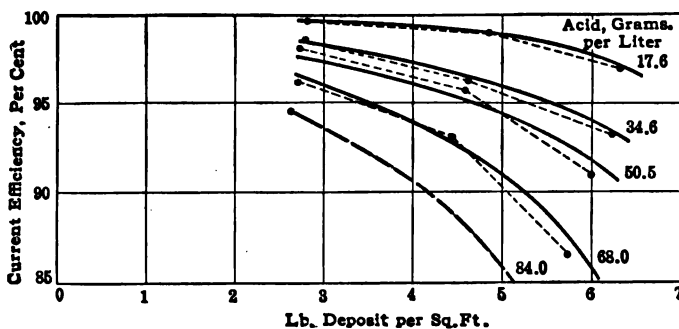
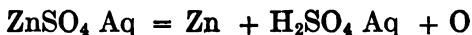

FIG. 11.—Bully Hill ores, June, 1915. (Hansen.) Current density, 15 amp. per sq. ft.

twenty-four hours, provided the current efficiency is 100 per cent. These curves will therefore explain why it is now the usual practice to pull out the zinc cathodes after two to four days and strip them of their deposits. The older the deposits, the more irregular they become, on account of the formation of trees which grow faster than the remaining portions of the plate. A one-day deposit is usually quite smooth and a two-day deposit is just beginning to become quite warty, unless very good conditions for deposition are maintained. The more irregular the deposit, the greater the surface exposed, and hence the greater the corrosion and the lower the current efficiency. Generalized curves derived

from Figs. 10 and 11 are given in Figs. 12 and 13, which show the current efficiency as a function of the solution acidity.

Voltage.—It is possible to calculate the decomposition voltage of a zinc sulphate solution from the heat of reaction involved in the chemical equation:



This heat is known to be in the neighborhood of 106 Cal. By converting this into electrical units and then dividing

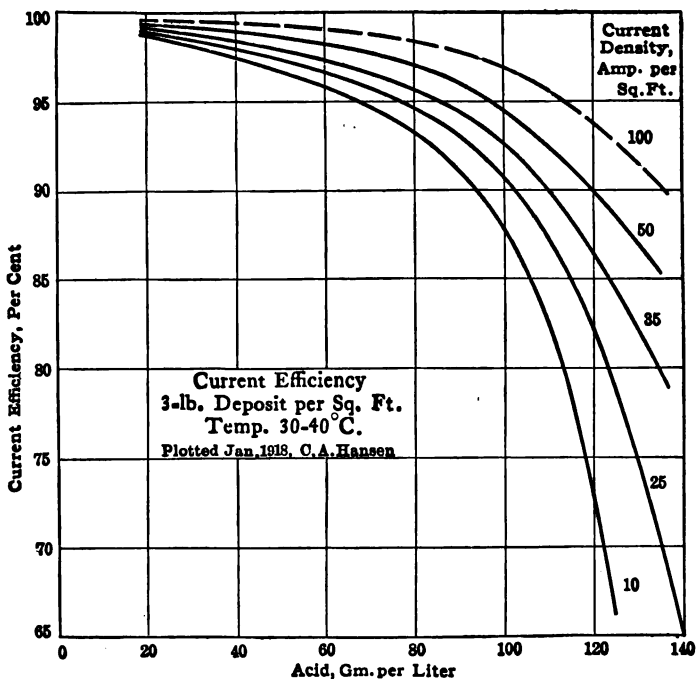

FIG. 12.

by the number of grams of zinc per ampere-hour (1.219) we arrive at the theoretical voltage. Authorities differ on the heat of reaction and hence on the theoretical voltage necessary, the latter figure varying from 2.25 to 2.50 or even higher. The most authoritative figures give 2.35 volts as

the theoretical decomposition voltage. This figure applies to platinum anodes, pure dilute solutions of zinc sulphate and standard conditions of temperature and pressure.

In cells of practical construction, with peroxidized lead anodes and commercial zinc sulphate solutions, Hansen has

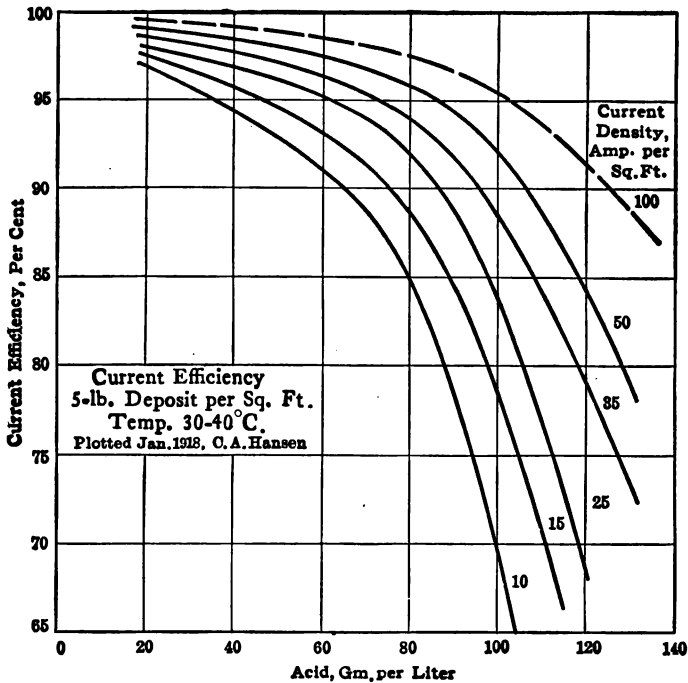

FIG. 13.

observed that the voltage corresponding to zero current at about 40° C. is 2.68. The discrepancy is probably largely due to overvoltage of oxygen on lead peroxide anodes. In fact the over-voltage of oxygen on lead peroxide was measured by Coehn and Osaka (*Zeit. anorg. Chem.* 34:86, 1903) and at low current densities was 0.28 volts, decreasing with temperature.

TABLE IV. VOLTAGE AT DIFFERENT TEMPERATURES

(Bully Hill Ores. June, 1915 (Hansen). Peroxidized Lead Anodes. Electrode Spacing, 2 in.)

Temp. °C.	Acid, Grams per Liter	Current Density						
		0	10	20	30	40	50	100
40	0	2.68	3.48	4.25	5.02	5.75	6.50	10.25
40	20	2.68	3.26	3.80	4.33	4.87	5.40	8.07
40	40	2.69	3.16	3.58	3.98	4.38	4.78	6.78
40	60	2.69	3.08	3.42	3.72	4.02	4.33	5.86
40	80	2.70	3.02	3.28	3.51	3.74	3.97	5.12
40	100	2.70	2.96	3.15	3.33	3.51	3.72	4.69
50	0	2.64	3.34	4.00	4.67	5.32	6.00	9.38
50	20	2.65	3.13	3.67	4.15	4.61	5.07	7.37
50	40	2.65	3.07	3.48	3.82	4.20	4.58	6.48
50	60	2.65	2.97	3.32	3.62	3.91	4.20	5.90
50	80	2.66	2.92	3.17	3.43	3.65	3.87	4.97
50	100	2.66	2.89	3.08	3.27	3.50	3.62	4.50
60	0	2.56	3.24	3.80	4.40	4.97	5.55	8.42
60	20	2.58	3.08	3.55	3.95	4.40	4.83	7.00
60	40	2.58	2.98	3.38	3.72	4.06	4.40	6.10
60	60	2.60	2.92	3.25	3.53	3.79	4.05	5.22
60	80	2.62	2.89	3.12	3.37	3.57	3.77	4.77
60	100	2.62	2.85	3.03	3.22	3.39	3.55	4.37
70	0	2.52	3.10	3.65	4.17	4.64	5.20	7.77
70	20	2.54	3.00	3.44	3.83	4.09	4.55	6.62
70	40	2.56	2.95	3.30	3.62	3.88	4.26	5.85
70	60	2.57	2.91	2.19	3.45	3.71	3.97	5.27
70	80	2.59	2.87	3.07	3.31	3.50	3.70	4.77
70	100	2.60	2.81	3.00	3.17	3.32	3.49	4.32

A very complete set of voltage measurements has been made by C. A. Hansen (loc. cit.) on solutions of zinc sulphate made from Bully Hill ores and is contained in Table IV. The figures for solutions at 40° C., a common operating

temperature, have been plotted in Fig. 14. From these figures it can be seen that the minimum decomposition voltage at 40°, for peroxidized lead anodes parallel to and spaced two inches from the zinc cathodes, is 2.68 volts, as mentioned in the last paragraph.

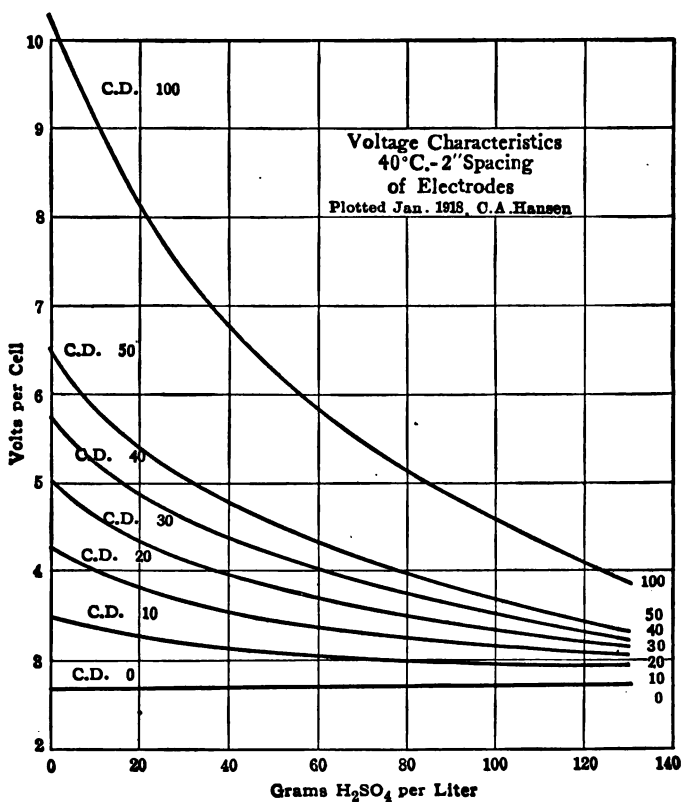

FIG. 14.

The voltage necessary to maintain a given current density is proportional to the total resistance of the cell. As mentioned above, a certain minimum voltage must be impressed in order to make any zinc deposit and then for higher and higher current densities higher and higher voltages are neces-

sary. The resistance of the cell is made up of a number of resistances:

1. Resistance of the solution.
2. Resistance of the electrodes.
3. Resistance at the surfaces of electrodes.

From the standpoint of the zinc metallurgist the resistance of the solution is of the greatest importance. This resistance is in turn due to a number of factors. Thus, a higher voltage is needed for 3-in. spacing of cathode to anode as compared to a 2-in. spacing, the distance between electrodes being one factor which makes up the resistance of the solution. The concentrations of zinc sulphate and of sulphuric acid in the solution are very important in determining the resistance of the solution. The effect of acidity is very plainly evident from Hansen's curves. Pure water has a very high resistance. Temperature of the solution is also a factor, since the resistance of the solutions decreases with rising temperature. If it were not for the fact that corrosion increases with rising temperature it would be desirable to use hot solutions for electrolysis in order to obtain lower operating voltages.

The resistance of the electrodes is usually quite small. Sheet lead anodes are good conductors and likewise aluminum cathodes. However, with the accumulation of lead peroxide on the surfaces of the lead anodes, as well as manganese peroxide formed by deposition from the solutions, the resistance to the passage of current rises and with it the voltage necessary to maintain a definite current density. This is why a fresh lead anode will allow operation at a lower voltage than an older anode. At the cathode there is usually an accumulation of hydrogen bubbles, due to corrosion of the zinc or to electrolysis of sulphuric acid, and these decrease the effective area for the current to flow to the cathode from the solution. This means a definite resistance which calls for a definite voltage. The oxygen bubbles at the anodes have a like effect.

The voltage in the zinc cell can theoretically be lowered if

13/	6
12/	3
10/	10
2	9
120	4
120	3
119	9
117	6
	50

a reaction can be caused to take place at the anode, which will use-up the SO_4 ions liberated there or the oxygen liberated from the action of SO_4 on water. Thus, if the anode consists of zinc or other metal which can combine with SO_4 to form a soluble sulphate, the voltage will be lowered by 2.35 volts, more or less. The cell will then deposit zinc at the cathode and dissolve zinc at the anode.

Another way of utilizing the anode reaction is to oxidize some other chemical, such as a chromate solution or a managanous sulphate solution. The latter offers promise, as there is a large market for pure manganese dioxide, and any lowering in voltage due to this reaction would also cheapen the electrolytic deposition of zinc. As mentioned above, manganese is one of the few impurities which can be present in the zinc sulphate solution without doing any harm. A few tests made by C. F. Sims under the author's direction gave the following results:

Cell: 3 x 4 in. aluminum cathodes.

3 x 4 in. lead anodes, slightly peroxidized.

Solutions:

1. Blank test for comparison, pure ZnSO_4 , with 8 per cent Zn in soln.
2. Same solution with 4.5 per cent Mn as MnSO_4 .

Voltages at 24 amps. per sq. ft.

Pure Solution	Manganiferous Solution
1 in. spacing, 3.7 volts.	3.7 volts.
2 in. spacing, 4.9 volts.	4.8 volts.
3 in. spacing, 5.4 volts.	5.6 volts.

These results show practically no effect due to the anodic oxidation of manganese sulphate to manganese dioxide. A hard coating of manganese dioxide formed quickly on the anodes, but the current efficiency in oxidizing manganese was only 30 to 40 per cent, whereas the current efficiency for depositing zinc at the cathode was about 95 per cent. Evidently the increased resistance, due to the film of manganese peroxide offset any reduced voltage due to anodic oxidation.

The deposition of zinc from an acid solution is somewhat of an electrochemical anomaly, since the electrolytic poten-

tial of zinc in a normal zinc solution, referred to the hydrogen electrode, is + 0.770 volts. Therefore, by theory, hydrogen is more easily deposited than is zinc. However, the over-voltage of hydrogen on zinc is about 0.7 to 0.8 volts. This, therefore, makes hydrogen and zinc about equally susceptible to electrolytic deposition under the conditions in which the zinc metallurgist is interested. Even then it seems easier to deposit zinc and the explanation is not exactly clear. Rideal¹ suggests that possibly some active hydrogen is reducing zinc according to the equation:

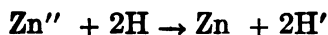

although this assumption is open to question since zinc usually displaces hydrogen from solution.

Energy Efficiency.—Knowing the theoretical decomposition voltage of zinc sulphate solutions (2.35 volts), and the electrochemical equivalent of zinc (1.2194 gm. zinc per ampere-hour), we have only to divide the latter into the former to find that theoretically it should require only 1.927 watt-hours to produce one gram of zinc. This figure can be converted into various units, all of which represent the theoretical energy (100 per cent energy efficiency) necessary to produce electrolytic zinc. These alternative unit figures are as follows:

1.927	watt-hours per gram zinc.
874.9	watt-hours per pound zinc.
1749.2	kw.-hr. per ton zinc.
0.268	hp.-year per ton zinc.
0.520	gm. zinc per watt-hour.
520.	gm. zinc per kw.-hr.
20.75	lb. zinc per hp.-day.
7580.	lb. zinc per hp.-year.

If more energy than the above is used per unit of zinc, the energy efficiency will be below 100 per cent. Thus, if three watt-hours are expended per gram of zinc obtained, the energy efficiency is $1.927/3.000 = 65$ per cent energy efficiency. Most of the energy which is wasted can be

¹Industrial Electrometallurgy, p. 65 (1919).

accounted for by the heat generated in the cell. The average energy efficiency of present operating plants varies from 40 to 70 per cent, depending on the current density, the condition of the anodes and the length of time the cathodes are allowed to stay in the tanks before they are stripped.

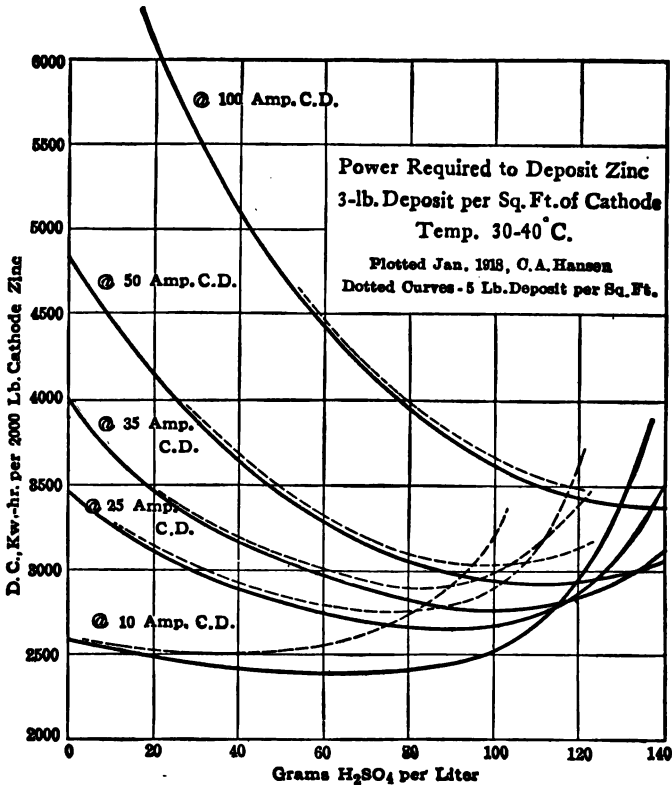

FIG. 15.

Hansen (loc. cit.) has summarized his data into some power consumption curves which are given in Fig. 15. The dotted lines represent deposits carrying 5-lb. zinc and the full lines deposits of 3-lb. zinc per sq. ft. These curves give direct current power per ton of cathode zinc deposited. Since 100 per cent energy efficiency corresponds to 1,749

kw.-hr. per ton of zinc, all of the curves show lower than 100 per cent energy efficiency. In fact, the lowest point on the ten ampere per sq. ft. curve corresponds to about 74 per cent energy efficiency, while the average of the ten ampere curve for electrolysis until 110 gm. acid per liter are present, is about 71 per cent.

These figures are of great interest in that they show a much higher energy consumption in solutions of low acidity than those of high acidity when the current density is high. It suggests that when operating on a twenty-five ampere per sq. ft. basis, it would be best to start electrolysis with about 40 gm. acid per liter and stop at about 120 gm. acid per liter. This means that about 60 gm. zinc per liter are simultaneously extracted, since 1.5 gm. of acid are formed for every gm. zinc deposited. Some of the partly exhausted electrolyte, with 120 gm. acid per liter could then be mixed with incoming neutral electrolyte in order to make a 40-gm. acid per liter solution. One volume of exhausted electrolyte, mixed with two of fresh electrolyte would give the required 40-gm. acidity. This acidification of new electrolyte with partly exhausted electrolyte is very commonly practiced in order to get better energy efficiency.

A very useful set of diagrams has been published by G. H. Clevenger and F. S. Mulock,¹ which is reproduced here in Fig. 16. Their explanation of their diagram is as follows:

POWER DATA FOR ELECTROLYTIC ZINC

BY G. H. CLEVINGER AND F. S. MULOCK

"The accompanying straight line diagram shows graphically the relationships between the principal electrical data involved in the production of electrolytic zinc. It will be noted that each vertical line is subdivided into a logarithmic scale. The position and scale of the heavy lines A, C, E and IJ are first arbitrarily laid off.

"The position and scale of line B, which represents the product of A, C and a constant, is then determined from the arbitrary scales on lines A and C. As line A represents ampere-hour efficiency and line C current in amperes, their product, when multiplied by time and the electro-chemical equivalent of zinc, will give the weight of zinc deposited for that time. Here the con-

¹Chemical and Metallurgical Engineering, 20:Feb. 15, 1919, supplement.

stant used was such that the scale of line B represents pounds of zinc per 24-hour day.

"Similarly, the product of line C, representing current in amperes, and line E, representing voltage, is given on line D, which represents power in kilowatts.

"Line D, representing kilowatts, multiplied by 24, gives kilowatt-hours per day. This product divided by line B, representing pounds of zinc per day, gives kilowatt-hours per pound of zinc, which is represented by scale F on line FG.

"Using the theoretical decomposition voltage of the electrolyte and the electrochemical equivalent of zinc, it is possible to determine the theoretical kilowatt-hours required per pound of zinc. This value divided by the actual number of kilowatt-hours per pound of zinc (as found on scale F) gives the power efficiency. Scale G gives the power efficiency for a zinc sulphate electrolyte.

"Line IJ gives the cost of power both in cents per kilowatt-hour and in dollars per kilowatt-year. From scale J of line IJ and scale F of line FG is determined the line H, which represents the cost of power in cents per pound of zinc.

"The following problem will illustrate the use of the diagram:

"Given: 1. Current, 5,000 amperes. 2. Ampere-hour efficiency, 90 per cent. 3. Voltage, 3 volts. 4. Cost of power, \$20 per kilowatt-year.

"To find: 1. Pounds of zinc deposited per day. 2. Power in kilowatts. 3. Kilowatt-hours per pound of zinc. 4. Cost of power in cents per pound. 5. Power efficiency.

"1. Place a straight edge on 90 of the A scale and 5,000 of the C scale. Read pounds of zinc per day (291) at point where straight edge intersects the B scale.

"2. Set at 5,000 on scale C, and 3 on E, and read power (15 kw.) on D.

"3. Set at points determined in 1 and 2, *i.e.*, 291 on scale B and 15 on scale D; read kw.-hr. per lb. of zinc (1.24) on scale F.

"4. Set at 1.24 on scale F and 20 on scale I, and read the cost of power per pound of zinc (0.283 cents).

"5. With the same setting as in 3, if the electrolyte is zinc sulphate, read the power efficiency (71 per cent) on scale G. (This scale cannot be used for electrolytes other than zinc sulphate.)

"(NOTE.—The voltage to be used on scale E is the voltage per cell. When cells are connected in series, divide the total voltage by the number of cells. The output of each cell may be ascertained by using the average current per cell on scale C. The total output of the plant may then be found by multiplying this result by the number of cells in use.)

"Similar straight line diagrams can be prepared showing the relationship between the electrical data involved in the electro-deposition of the other metals."

Character of the Electrolytic Zinc Deposit.—It has already been mentioned that the character of the deposit very greatly affects the current efficiency since smooth, flat deposits expose so much less area to corrosion than do rough, warty

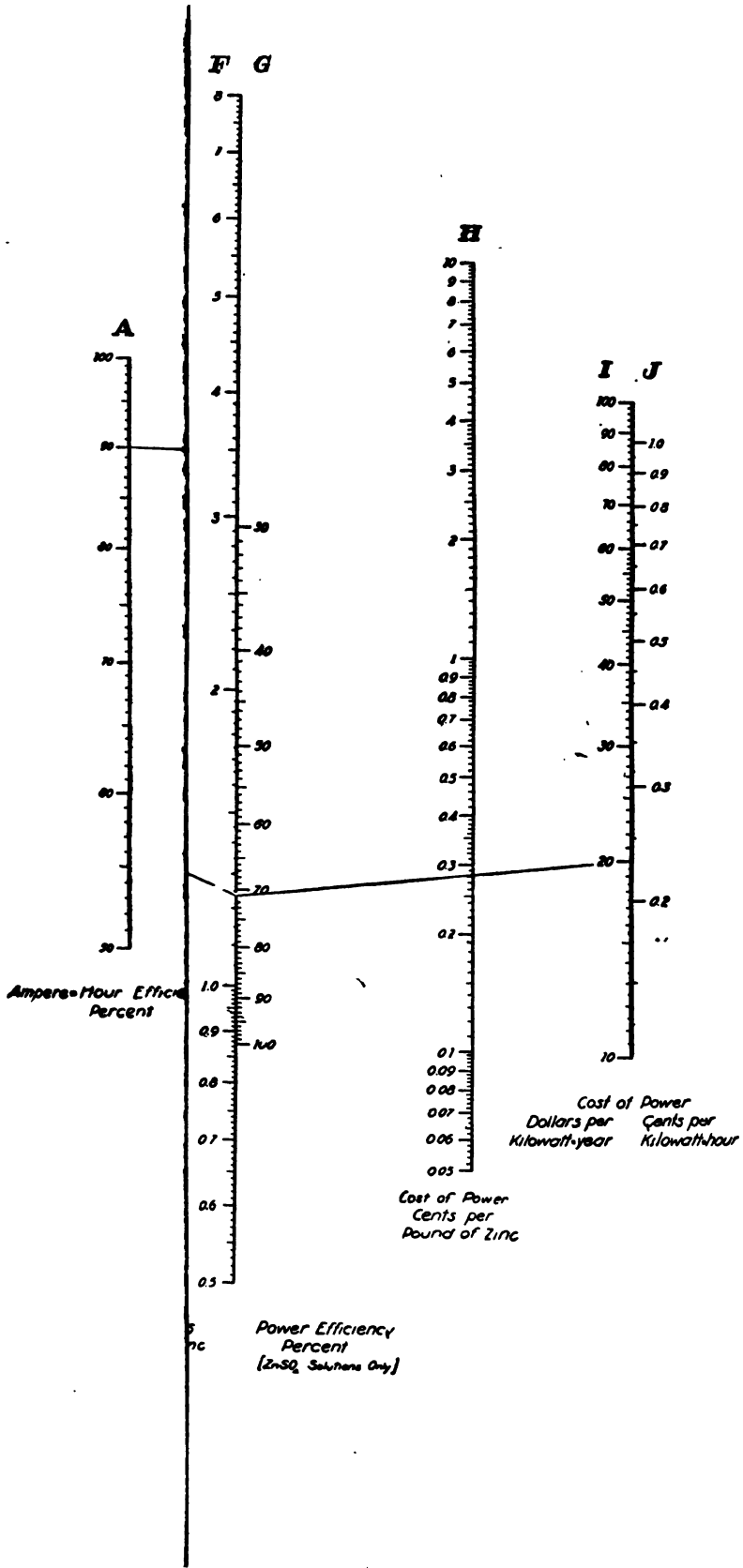

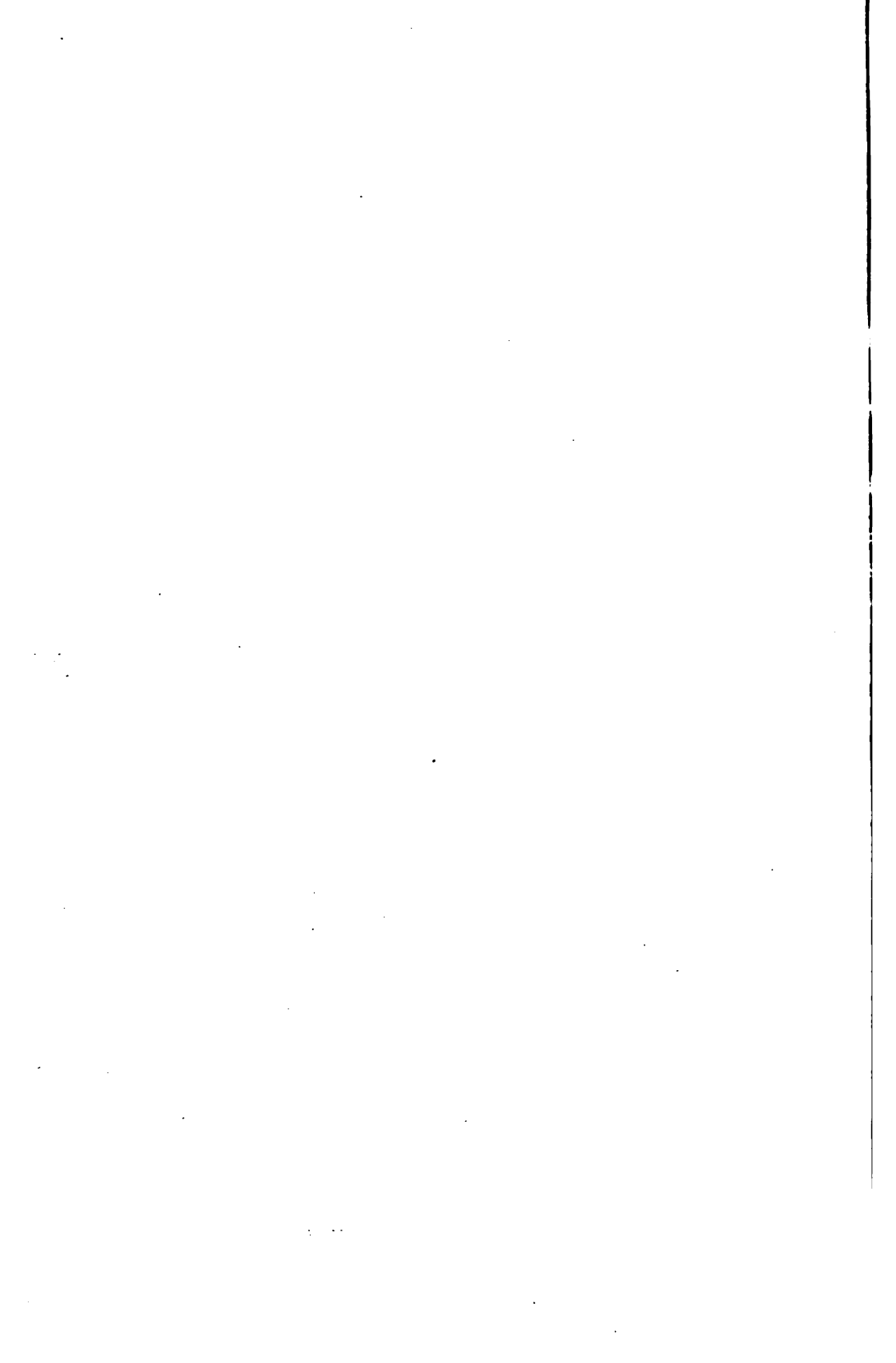

or spongy ones. The causes of rough deposits are not all known. However, some of them are very definitely known.

Spongy zinc is formed, due to at least two causes. If the acidity is substantially zero, or if the solution is somewhat basic with dissolved zinc oxide (a zinc sulphate solution can dissolve small amounts of zinc oxide), the deposit is almost sure to be spongy and as soon as enough acid has been generated at the anodes this spongy zinc redissolves. The other main cause of spongy zinc is the presence of impurities like copper or arsenic in the solutions. After all the impurities have been thrown out with the spongy zinc, it is possible to pass the purified solution into another cell and obtain good deposits of zinc. Rarely, however, can a solid coherent deposit be caused to form over a spongy deposit, and the best thing that can be done is to pull out the spongy cathodes and clean them.

Trees, warts and similar projections from a plane cathode are in part due to impurities, but mainly due to poor circulation of the electrolyte and unequal distribution of the electric current. If the solution flowing through a cell is unequally divided and more solution passes some cathodes than others, or parts of one cathode than the other parts of the cathode, the regions having the greatest supply of solution are smoothest. This has led many operators, especially during the earlier stages of their experience, to apply more circulation to the deposition tanks than is actually needed. With experience, it is possible to adjust the flow of solution through each tank so that it divides more or less equally among all the cathodes, and by properly purifying the solution the tendency toward uneven deposits is cut down so that no more than the natural velocity of the electrolyte in flowing through the cell in a cascade of five to ten cells is needed. There is no doubt but that strong circulation within the cell will suppress the tendency toward "tree-ing" in insufficiently purified solutions. In the electro-analytical determination of zinc a very high velocity of circulation of the electrolyte is used for this very purpose.

"Trees" form with more difficulty in solutions of high acidity than in low acid solutions, since the trees have a tendency to redissolve faster than the plane surface of the cathode.

Hydrogen bubbles forming at the cathode often adhere to it, and at every point where a bubble adheres no zinc is deposited. This makes the adjacent areas grow faster so that the natural tendency with continued electrolysis is to form a cathode which resembles a honeycomb. Increased circulation of solution of greater purity will diminish this effect.

The addition of a colloid, like glue, to the solution will also restrain the development of trees. Many feel that the effect is due to selective adsorption of the glue for the ions of the impurities, slowing down their rate of migration in the electrolyte until they become harmless. The most commonly accepted theory is that the glue particles tend to migrate to the cathode (electrophoresis, or cataphoresis) and adhere there. Since the points of the trees are the points of highest current density, more ions are being discharged on them than at any other place on the cathode and hence there is a tendency to plaster a thicker layer of glue (or other colloid) on them than at other points. Since the glue is more or less of a non-conductor the resistance to depositing zinc on the trees increases till the current adjusts itself equally over the plate. It is usually difficult to plaster over trees after they are once formed, but the addition of glue to the solution will often accomplish this result, and it undoubtedly tends to restrain their formation on fresh cathodes.

Holes of varying sizes are also frequently found on the cathodes. Pinholes, which do not penetrate completely to the aluminum cathode, are often due to the adherence of small hydrogen bubbles in spots. Larger holes are due to re-solution of zinc, due to the presence of impurities, especially cobalt, nickel, antimony or arsenic. The holes due to cobalt are quite characteristic. The zinc plate will form

nically for a time and then the zinc begins to re-dissolve next to the aluminum cathode and large areas will be dissolved before the defect appears on the surface. However, the cathode finally looks like a Swiss cheese and the rate of re-solution becomes as great as the rate of electrolytic deposition.

Temperature Effects.—The temperature at which a zinc cell is allowed to run is one of the most important variables which must be controlled. The higher the current density, the higher the temperature of the cell. In order to operate at a current density of 25 amp. per sq. ft. or more, it is practically necessary to introduce cooling coils of lead pipe into the cells, usually at the inlet end, in order to absorb the heat due to electrolysis. The amount of cooling water needed for a large plant is also a considerable item. From the standpoint of first cost it is desirable to operate as high a current density as possible, since it makes fewer cells necessary.

With increase in temperature the rate of corrosion on the zinc from the cathodes increases, as mentioned earlier in this chapter. Nearly all chemical reactions increase in speed with rise of temperature. Many reactions in solutions roughly double their velocity for every 10° C. rise in temperature, but for the dissolving of zinc cathodes in cell solution, Hansen (*loc. cit.*) finds that the velocity doubles for every 21.7° C. rise in temperature. Hansen has made a careful study of the capacity of the zinc cell to dissipate heat and to compare this with the rate at which heat is generated in the cell. In this way it is possible to calculate the temperature at which the cell would reach equilibrium with the atmosphere of the cell room. Usually this is too high a temperature to allow of efficient use of electrical energy, and it is a better plan to cool the electrolyte within the cell circuit artificially.

Rise in temperature increases the conductivity of the solution, which means a decrease in resistance, or a lower operating voltage. This, of course, is a favorable effect.

Rise of temperature also lowers the hydrogen over-voltage and hence the current efficiency of zinc deposition.

The conclusion is therefore inevitable that low temperature is most desirable for the operation of the zinc cell.

Acidity.—The effects of acidity of the electrolyte have already been discussed under various headings above in this chapter. These effects are therefore only summarized:

1. A small acidity is necessary to prevent formation of sponge zinc at the cathode.

2. The corrosion of the cathodes increases with the acidity of the solution, especially in the presence of impurities.

3. The resistance of the solution decreases with acidity, and hence voltage likewise drops. This is a very important effect in that only a slight drop in voltage often means a large increase in energy efficiency.

4. High acidity calls for higher current density in order to more than equalize the increased rate of corrosion.

Impurities.—The effects of many impurities have been mentioned in the chapter on purification of solutions and only the important electrolytic effects will be mentioned here.

Iron.—Ferrous iron seems to cause no harm in the deposition of zinc (as discovered in the electrolytic refining of zinc) and only ferric iron is to be feared. The iron is not deposited with the zinc electrolytically to any important extent and the only evil effects are its corrosion effects. Ferric sulphate reacts on cathode zinc mildly to form ferrous sulphate and zinc sulphate. The ferrous sulphate reoxidizes to ferric sulphate at the anode, especially in the presence of manganese, and is then ready to repeat the cycle. However, the effect of iron in the zinc sulphate cell is not regarded as seriously prejudicial by most authorities, although it is practically fatal in a zinc chloride cell. The usual amount of iron allowed in solution in zinc sulphate cells is from 20 to 30 mg. per liter.

Aluminum seems to improve rather than to hinder the deposition of zinc from sulphate electrolytes.

Arsenic and Antimony cause re-solution and poor deposits.

The antimony is the most serious in its re-solution effects, almost exceeding cobalt in its destructiveness. These effects have been noted by Hansen (*loc. cit.*) to be worse in the presence of manganese. Both of these impurities are not wanted in the solution in amounts exceeding 1 mg. per liter, although arsenic can be present in several times this quantity without causing seriously prejudicial effects.

Cobalt.—This is practically the worst impurity which can enter the electrolyte, due to its causing re-solution of the cathodes, leaving them looking like they had been shot full of holes. The presence of glue in the solution restrains its action, presumably by forming complex ions with it. Other colloids cause the same effect, even a canvas sack or diaphragm hung in the electrolytic tank supplying enough colloid to assist in restraining the cobalt.

Manganese.—This is not prejudicial to the electrolytic deposition of zinc and the manganous sulphate is oxidized through all stages of oxidation to manganese dioxide at the anode. In the neighborhood of the anodes the pink color of zinc permanganate is often observable. This tends to oxidize any multivalent impurities in solution which can then attack the zinc at the cathode again. If the manganese dioxide is allowed to accumulate on the lead anode it tends to protect it from further deterioration. At low temperatures the manganese dioxide is not as tightly adherent as at higher temperatures. Likewise at high acidities the manganese dioxide is not as adherent and tends to fall to the bottom of the cell as fast as it is formed. Hansen believes that the manganese dioxide sludge always contains lead from the anodes, and this is possibly true if the manganese is always allowed to form a loosely adherent flaky deposit which falls off.

Copper.—This element is so easily removed from the solution that it rarely reaches the zinc cell. When present it is deposited with the zinc, contaminating it, and causes a decrease in current efficiency. It also tends to form sponge zinc if present in any important quantity.

Cadmium.—This metal does not affect the zinc deposit so much in character as in purity. Cadmium is not wanted in high grade zinc and hence must not be allowed to reach the zinc cell.

Lead.—This metal is so slightly soluble in sulphate solutions that it is usually regarded as being completely insoluble. It is undoubtedly soluble to a slight extent but is usually not detected by ordinary means and the contamination of the cathode by it is not appreciable, although there is at times more than enough lead peroxide in the manganese sludge to account for the loss of lead from the anodes.

Chlorides.—The presence of chlorides in the electrolyte causes serious attack of the lead anodes. Therefore care should be taken to remove the chlorine with silver sulphate. It must be kept below 50 mg. per liter of solution.

DETAILS OF PRACTICE

Tanks.—The electrolytic tanks used in sulphate practice are almost invariably wooden tanks with lead linings. They are rectangular wooden tanks about 30 to 40 in. wide, 36 to 48 in. deep and 48 to 100 in. long, depending upon the amperage, the current density, the spacing of electrodes and the method of handling. They are set on insulating foundations, such as wooden beams supported at two to four points with glass or porcelain insulators. Thick "sidewalk" glass is quite popular for this purpose. A copper bus bar is placed about the top of each side, and on these bus bars rest the electrodes. The anodes are allowed to come into electrical contact with the bus bar on one side and on the other side each anode rests on a piece of glass or other insulating medium placed on top of the cathode bus. In like manner the cathodes are supported on the other side by the cathode bus and rest on insulators placed on the anode bus. This is not the invariable arrangement, but the equivalent to it is used in almost every plant. A cross-section of a tank with a lead anode is given in Fig. 17, and the same section would substantially apply to a cathode, except that it rests on the

opposite bus. From six to twenty-seven cathodes are used per tank, depending on how much current is available, and from seven to twenty-eight anodes to correspond. The later figures of twenty-seven cathodes and twenty-eight anodes apply to the zinc plant at Great Falls. These large tanks take 6,000 to 9,000 amperes, depending on the current density. At 6,000 amperes per tank the current density is about 15 amp. per sq. ft.

Tanks of concrete construction have been tried and abandoned by almost every company except the one at Trail, where they seem to be a success. However, mastic tanks

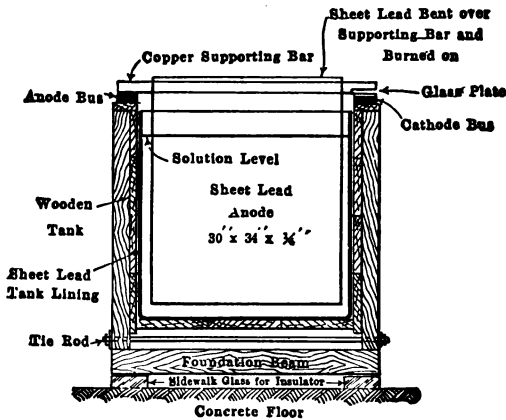

FIG. 17.

have not been tested thoroughly, and it is possible that they will soon find an application. The author has electrolyzed zinc chloride solutions in tanks made of a mastic concrete consisting of ground quartz of all sizes held by "hermastic," a rather stiff asphaltic composition compounded by one of the companies which deals in tar products and asphalts. The stiffness of a mastic concrete wall depends upon the percentage of quartz or other filler. Mixtures containing a high content of filler melt at temperatures as high as 250 to 300° C., whereas the pure mastic binder melts at around 70° C. A mastic concrete does not cost much more than

the ordinary portland cement concrete, although it must be mixed hot and poured in a molten condition. Mastic concretes are acidproof and waterproof, and if mixed sufficiently dry are strong at all temperatures likely to be met in a zinc cell.

The dimensions of ordinary zinc-depositing tanks vary from 5 to 10 ft. in length and 30 to 40 in. wide, with depths varying from 36 to 48 in. The reason is that tanks of any greater length require such a high amperage that it presents electrical problems to the builder of generators. Tanks of any greater width or depth would call for cathodes so large that they could not be conveniently lifted for inspection by the operators.

The anodes and cathodes are spaced about two inches from each other in nearly all of the zinc plants in operation. Closer spacing causes too much trouble in short circuits and difficulty in handling, while wider spacing is wasteful of energy because it requires a higher voltage to cause the same current to flow.

Circulation.—The supplying of sufficient numbers of zinc ions to the immediate vicinity of the cathodes is a problem which must be taken care of, especially in a new plant. As mentioned earlier in this chapter, a high rate of circulation of the solution in a cell means smoother deposits and defects in the purification system can be to some extent corrected by a high rate of circulation. The cells at Great Falls and at Trail receive the solution at one end of the tank without taking much trouble to distribute it equally over the faces of the cathodes. This is permissible for the reason that no effort is being made to strip the solutions entirely of zinc, and consequently the low current efficiencies obtainable from high acid solutions are not reckoned with. If it is necessary to electrolyze the solutions until the liquor issuing from the last cell contains less than 2 per cent Zn, artificial agitation, in addition to the natural flow of the solution through the cell, is necessary. The plant of the United States Smelting Co., at Kennett, California, used anodes

made up of lead pipes through which compressed air was supplied to the bottom of the cell. The rising air bubbles agitated the liquor, swept adhering hydrogen bubbles from the cathodes plates and thereby allowed making smoother cathodes which were less subject to corrosion, and also allowed of greater depletion of the solution in zinc during each cycle. A drawing of this arrangement is shown in Fig. 18 which is taken from the patent specification of the inventor, H. R. Hanley.¹ He claims that the cathodes

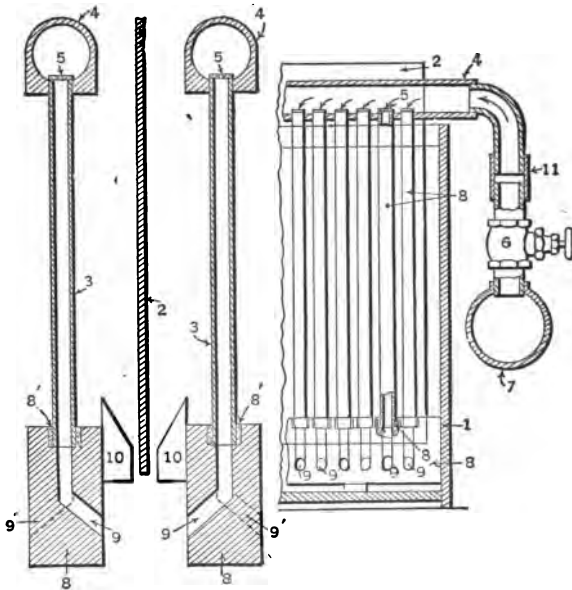
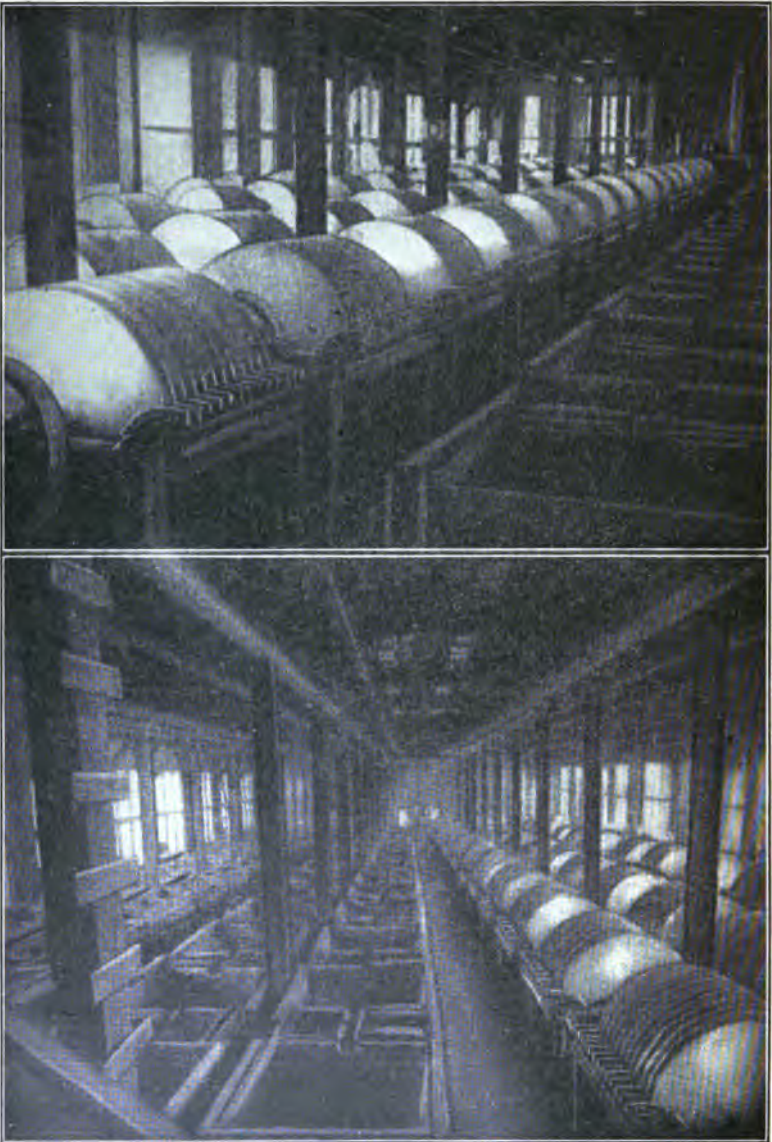

FIG. 18.

resulting from the use of air agitation, under the conditions met at Kennett, weighed 20 to 25 per cent more than would the cathodes resulting from a solution which was not so agitated. Such anodes cost about three times as much as simple sheet-lead anodes and only exceptional conditions should justify their use. In fact, it is not necessary to use

¹United States Patent 1,241,967 of Oct. 2, 1917. HERBERT R. HANLEY, assignor to Bully Hill Copper Mining & Smelting Co.

**FIG. 19.**

hollow anodes to introduce air to the solution in the tanks, but air stirring may be obtained in a number of ways, or the solution may be withdrawn from the bottoms of the tanks and distributed again at the tops by either pumps or air lifts, in order to obtain increased agitation with the resulting smooth cathodes. The author, in common with most investigators, has used excessive agitation of the solution, and there can be no doubt that the improvement in appearance of the cathodes is very marked. However, with solutions sufficiently purified, the necessity for high depletion of the electrolyte at one cycle is removed and likewise the necessity for violent agitation of the electrolyte.

A good idea of the circulation system at Great Falls can be obtained from the photographs in the frontispiece and also Fig. 19. Part of the solution flows into the first of a cascade of six cells through a regulating valve and then flows by gravity through each cell, overflowing into the next cell in the cascade. About six inches drop between cells permits easy gravity flow. The frontispiece shows many rows of cells placed side by side in pairs to allow easy access. Neutral solution is also fed to each cell individually. The photograph shows that the cell room is divided into two halves, the solution being fed into the head tanks on each side of the room and flowing down through the cascades to the center of the room.

Another method of agitation of the solution was used during 1917 at the plant of the Judge Mining & Smelting Co., in Park City, Utah, in order to obtain smoother deposits. This is shown in the photograph¹ of Fig. 19. The cathodes consist of aluminum discs which dip into the electrolytic tank and are slowly rotated. This tends to renew the solution directly in contact with the cathodes and hydrogen bubbles have no opportunity to adhere long and render the surfaces of the cathodes uneven. Difficulty in keeping the aluminum discs lined up true to the rotating shaft, difficulty

¹Photographs of the Judge cell room shown in the *Engineering and Mining Journal* of May 12, 1917, page 833.

in stripping the zinc from these discs, and improved purification of the solution made it advantageous to replace these disc cathodes by stationary plates of the type used at Trail and Great Falls.

Cathodes.—The cathode plates used for deposition of zinc are almost invariably of aluminum, and occasionally sheet zinc. Deposited zinc can be stripped more easily from the

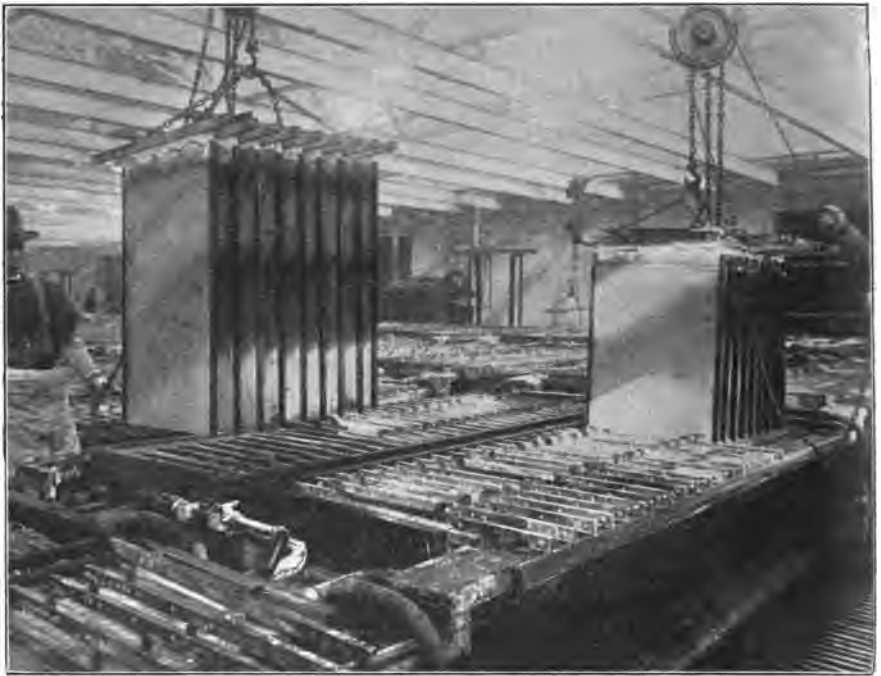

FIG. 20.—Gang-lifting of cathodes (Great Falls)

surface of sheet aluminum than from any other metal which is available at a reasonable cost. In addition, aluminum is more or less passive as an anode in sulphate solutions and does not dissolve appreciably, whereas sheet zinc cathodes will often dissolve in the electrolyte to a prohibitive extent. At Great Falls and at Trail, the sheets of aluminum used for cathodes are about 26 in. wide and 42 in. high, although not

completely immersed in the solution. Only about 36 in. of the plate dips into the solution. (See Fig. 19). The sharp edges of the aluminum cathodes are points of higher current density than the plane surface and consequently there is usually a tendency toward the heavy growth of trees at these edges. In addition, the heavy deposit of zinc on the edges joins the zinc on one face of the sheet with the zinc on the other face of the sheet and makes it difficult to remove the zinc from the aluminum when it is desired. It is therefore necessary to provide wooden strips (see Fig. 19) which can be grooved on one side so that they can be slipped over the edges of the aluminum plate to prevent this. This practice is not peculiar to zinc deposition. At the Hobart, Tasmania, plant, a groove is made in the side of the aluminum sheet. A sharp chisel can be run down this groove when it is desired to strip the zinc deposit. This does away with the wooden strips. The writer has also used mastic edges on the aluminum or zinc sheet cathodes. The mastic may be kept molten and the edges of the plate barely dipped into it or molten mastic can be supplied to the edge of the plate with a brush. The only trouble with this method is that the mastic must be applied to the plates when dry. However, the mastic need not be removed when stripping the zinc from the plate as a chisel can be introduced under the zinc through the soft mastic at only one or two points, making replacement of the mastic necessary only twice monthly when it has been cut through at a number of places.

The aluminum or zinc sheets corrode above the liquor line to some extent. Supposedly, this is due to acid electrolyte splashed up by the bursting bubbles of hydrogen, since the acid can corrode the plates at this level without their being protected by electrolytic deposition. Therefore, it is best to coat the cathodes above the liquor line with a protective covering. Varnishes do not protect well as they are too thin and tend to crack off. A coat of heavy mastic or bitumen, smoothly applied to a dry cathode, is much more effective. In fact, it is well to cover the copper supporting

bar as well, in order to preclude the possibility of copper being corroded and the copper sulphate dropping into the solution in the cell, or corroding the aluminum sheets.

The cathode sheets must be attached to a cross bar of aluminum or copper at the top of the tank and hang from these cross bars into the tank. The method of attachment at the Great Falls plant is shown in Fig. 19. A strip of copper is riveted onto each side of the aluminum at the top. This copper support in turn rests on the bus bars which form the top portions of the sides of the tank. Fig. 19 shows the heavy copper bus bar quite plainly. On the opposite side of the tank the copper cross bar would likewise rest on the anode bus, except that small blocks of glass are interposed to insulate the cathode from these anode bus bars. (See Fig. 17.)

2 At Great Falls both bus bars are on one side of the tank.

Since each cathode has about 10 sq. ft. of surface on either side and a 3- to 5-lb. per sq. ft. deposit is made, the total weight of zinc deposited before stripping is 60 to 100 lb. This is about as heavy as one man can lift when inspecting the condition of the tanks.

As soon as the deposit has grown so thick and uneven that the current efficiency is falling off seriously, the cathodes are removed and stripped. They may be lifted out one by one by hand labor or they can be lifted out in gangs by use of a differential pulley, as shown in Fig. 19. When gang lifting is employed, small lugs are placed on the tops of the cathodes to allow placing a small lifting bar under them. At Great Falls, nine cathodes are lifted and taken to the stripping racks simultaneously. This removes one-third of the cathodes that are in the tank and the current is carried temporarily by the other two-thirds until fresh, clean plates are introduced.

Stripping the electro-deposited zinc from the cathode plates is quite easy if the plates are kept in good condition. A fresh aluminum plate will allow the zinc deposit to fall off of its own weight if it becomes quite heavy and is subjected to a slight jar. With further use the aluminum surface

becomes rough, and it is necessary to insert a sharp tool like a chisel, screwdriver or putty knife under the edge of the zinc deposit and then pry it off. If it is a thick deposit it may come off in one piece, but sometimes it is necessary to strip the zinc when it is almost as thin as paper, and under these conditions it breaks up badly and requires quite a little hand work in removing it. When the aluminum blanks become too rough to strip with ease they need to be polished again. Stripping compounds like paraffin dissolved in benzol, thin rubber solutions, resin solutions, etc., can be washed over the surfaces of aluminum or zinc sheets used for cathodes and improve the stripping, although not with the same success as is met with in copper practice. The only stripping compound which the author has found of much benefit is the "electrotypers' lead" sold by some of the graphite companies. This must be applied with a rag dampened with gasoline or benzol and rubbed in. All grades of finely divided graphite do not work. With this stripping compound it is even possible to strip cathode zinc from iron or copper blanks.

One man can pull out 250 to 400 cathodes in gangs of six to nine, strip them, replace them and polish the bus bars in eight hours. The number attended depends upon the condition of the aluminum plates and of the zinc deposit. This means from five to ten tons of zinc.

Anodes.—In practically every sulphate electrolysis plant, rolled or cast lead sheet anodes are in use. No other anode material is as satisfactory. Ferro-silicon anodes are expensive, brittle, heavy, and allow too much iron to pass into solution. Fused magnetite anodes are open to the same objections. Manganese dioxide anodes are also expensive, fragile and heavy, as well as being rather poor conductors.

The sheet lead of which the anodes are made is best of soft or "corroding" lead, as antimonial lead causes trouble. The lead is usually wrapped around the copper cross bar at the top and burned on. This makes a simple joint and covers the copper with lead so that there is not so much

danger of the copper corroding and getting into the solution. Lead weighing 12 lb. per sq. ft. is heavy and retains its shape well, while lighter lead costs less and is more easily worked when being made up into anodes. The tendency is to use heavier and heavier lead and aluminum sheet for the anodes and cathodes, as more experience is gained. The life of the electrodes has not been determined with much satisfaction, as few of the operating plants have yet had enough experience to know just how long they will last. It is known that the life of the anodes is greatly dependent upon the amount of chlorides that get into the zinc sulphate solution. The lead is corroded at least one pound per ton of zinc deposited in the best practice and ten to twenty pounds is very commonly corroded. Of course, this lead falls to the bottom of the tank as lead peroxide, together with the manganese peroxide which is deposited from the solution, and in case the manganese is smelted in a lead furnace the lead is ultimately recovered. After the lead has been corroded about half through the remaining portion is usually melted up and fresh anodes put in.

The anodes are made about 1 in. shorter than the cathodes and a similar 1 in. is cut off of the sides in order that too much current will not be crowded onto the edges of the cathodes with the resultant excessive growth of trees.

The copper cross bars on which they are hung must have a cross section of about 1 sq. in. in order to support the weight. These cross bars rest on the bus bars at the sides of the tank, making metallic contact with the anode bus, but with a glass plate interposed between the cross bar and the cathode bus. (See Fig. 17).

The oxygen and hydrogen evolved at the electrodes rises as small bubbles through the bath and escapes into the air above the cells. It is charged with some H_2SO_4 vapor which is practically invisible but which irritates the membranes of the nose and throat. The operators, therefore, suffer from nose-bleed and hoarseness. A slight mask or a cloth over the mouth and nose relieves this discomfort considerably.

Bus Bars.—It is practically universal practice to use copper bus bars placed along the tops of the sides of the tank, and on these rest the anode and cathode supports or cross bars. The bus bars must be kept polished bright and clean in order that good metallic contact can be made between them and the electrodes.

A flat, rectangular cross-section is most commonly met, although it has been found possible to get better metallic contact with the electrode supporting bars if either the bus or the electrode bar is of triangular cross-section. While theoretically a knife edge is a poorer electric connection than two flat surfaces, practically, a knife edge bearing against a flat surface affords less resistance.

The details of bus bar sizes, contact resistances, heating, etc., are exactly the same in copper refining and considerable literature exists on this subject.

Operation.—The operation of a zinc cell room is much like that of a copper cell room. The flow of the solution must be so adjusted that the solution coming from the last cell of each cascade is sufficiently low in zinc to return to the leaching tank. The control of this point is obtained by analyzing the solution for acidity, since a pound and a half of sulphuric acid is generated for every pound of zinc deposited. The titration for acidity is made with a standard sodium hydroxide or sodium carbonate solution, with methyl orange as an indicator. The writer finds that methyl red is a much more satisfactory indicator than methyl orange. If it is found that the outflow from the last cell is too high or too low in acidity, the inflow of solution at the head of the cascade is adjusted to provide more or less solution to the cascade.

Inspectors must pass along and inspect enough plates in each tank to see if the deposition of zinc is taking place in the right manner and whether all the cathodes make good contact with the bus bars. They must also look for short circuits in the tanks as indicated by the cell ceasing to evolve

gas bubbles or to deposit zinc or by a low voltage across the cell.

Operators are needed for removing the cathodes after sufficient zinc has been deposited, taking them to the stripping racks or stripping table, removing the zinc, cleansing the aluminum or zinc sheets ready for use again, polishing the bus bars, and returning the cathodes to their places. Some one must then check up to see that the cathodes are properly spaced from the anodes and that they make proper contact with the bus bars.

Faulty purification of the solutions will show up in the cell room, causing difficulties in the electrolysis. The effects of these various impurities have already been described to some extent, but it is not always easy to identify the cause of each defect that appears in the cathodes. In fact, the cell operator lives a harrassed life during the early months of operation of an electrolytic zinc plant. For example, if a considerable amount of dissolved copper passes through to the cells it causes violent re-solution of the zinc cathodes with attendant evolution of hydrogen. This hydrogen occasionally takes fire and the only thing that can be done is to quickly replace solution or plates or both, or even to shut down the generators.

CHAPTER VI

CHLORINATING ORES AND PURIFYING SOLUTIONS

General.—Although practically all of the electrolytic zinc at present on the market is deposited from zinc sulphate solutions, the chloride solution is in use in one or two places. In fact, the first commercial work was done with chloride solutions. The plant of Brunner, Mond & Co. at Winnington, England, was designed by C. Hoepfner in the nineties and has been in operation ever since.

Zinc chloride solutions are of greater importance in the chemical manufacturing business than in metallurgy. Zinc chloride, both in solution and in fused or granular condition, is widely used for preserving timber, for flux in melting metals, for making hard fiber, and numerous smaller uses. Methods of chlorinating zinc ores hence vary according to whether the solution is to be used for electrolysis or to be evaporated and sold as zinc chloride. In the latter case care must be taken to avoid introducing appreciable quantities of alkali and alkaline-earth chlorides into the solution.

Chlorinating agents are likewise classified according to whether they are used as primary reagents or whether they are byproducts from other operations and must be used up in some profitable manner. For instance, most of the muriatic acid used in making commercial zinc chloride is a byproduct of the manufacture of glassmakers' salt cake from salt and sulphuric acid. Likewise, chlorine gas from the electrolytic caustic soda plants can be regarded as a byproduct and can be used up in chlorinating zinc sulphide ores for the purpose of making zinc chloride. In the case of chlorine, however, most of the proposals involve making it directly in order to form zinc chloride solution which can be electrolyzed. In this latter case, chlorine is a primary prod-

uct which is used in a cycle and only losses of chlorine are made up from an outside source.

Chlorination with Salt.—The roasting of various metallic sulphide ores with salt is a very old process. The cheapest form of chlorine is in sodium chloride and it is natural that the roasting of ores with salt in an endeavor to form metallic chlorides in an inexpensive manner should have been attempted early in the development of the art.

The chemical mechanism of chloridizing roasting has been discussed very thoroughly in connection with the treatment of copper ores and of silver ores.¹ There are no essential differences in the chloridizing roasting of zinc ores. Chloridizing is most successful if a sulphide of zinc is treated. Air acts on the sulphide in the roasting furnace liberating sulphur oxides which can act on the salt, liberating chlorine and hydrochloric acid gas, or on the oxide of zinc, forming sulphate of zinc. Chlorine and hydrochloric acid can react on zinc sulphide to form zinc chloride and hydrochloric acid gas can also react on zinc oxide. Salt and hydrochloric acid gas can also react on zinc sulphate. The net result is that by roasting a mixture of salt and a zinc sulphide ore or an oxidized zinc ore in the presence of sulphur dioxide gases, in an oxidizing atmosphere at a temperature of less than 600° C., most of the zinc is converted into zinc chloride. Since the boiling point of zinc chloride is at 720° C., it is necessary to keep the temperature considerably below this in order that losses by volatilization may be prevented. The speed of the roasting is very low at temperatures below 500° C., so the operating range is between 500° and 600° C. Since zinc chloride is fused at these temperatures, it is somewhat difficult to induce complete chloridizing to take place, due to the fused material coating over the surfaces of zinc sulphide particles and preventing access of the roasting gases. Only low-grade ores can be successfully chloridized in one roast. Higher-grade ores must be roasted once,

¹O. HOFFMAN: *Hydrometallurgy of Silver*. McGraw-Hill (1907).

GREENAWALT: *Hydrometallurgy of Copper*. McGraw-Hill (1912).

leached, and the residue dried and roasted again. Supposedly this is due to the fact that in the lower-grade ores there is much gangue material to absorb the fused zinc chloride as fast as formed and thus prevent the filming action.

The only commercial attempt to treat a zinc ore by chloridizing roasting was made by Hoepfner at Fürfurt am Lahn, Germany, in the early nineties. A zinciferous pyrite cinder (the residue from roasting iron pyrites as a source of sulphur dioxide), was obtainable from a sulphuric acid plant nearby and it was proposed to roast this with salt, leach the zinc chloride, purify the solution and electrolyze it for zinc and chlorine, the chlorine to be used in the manufacture of chloride of lime (bleaching powder). The cinder contained 10 to 12 per cent of zinc, most of it still present as zinc sulphide, while the balance was iron oxide resulting from the roasting operation in the sulphuric acid plant. This was mixed with 18 to 22 per cent salt and roasted at a barely perceptible red heat for twenty to twenty-two hours in a muffle roasting furnace 14 meters (43 ft.) long, 3 meters (10 ft.) wide and 2 meters (6 ft.) high, containing a muffle 12 meters (37 ft.) by 2 meters (6 ft.) by about 1 meter (3 ft.). It took a charge of about five tons of ore and required the services of three laborers for rabbling, firing and hauling ore and supplies. The consumption of coal for a five-ton charge was one ton. The chloridizing efficiency of the Fürfurt plant is not given¹ but the resulting calcine, after leaching, was said to contain 1.4 to 1.5 per cent of zinc. This means about 95 per cent extraction, but an unknown loss by volatilization and other causes.

The soluble materials in the calcine were largely zinc chloride, sodium chloride and sodium sulphate. They were leached with water (placed on the hot calcine) in iron tanks. The solution was then chilled to -5° or -6° C. in order to crystallize out the sodium sulphate as Glauber's salt, $\text{Na}_2\text{SO}_4 \cdot 10\text{H}_2\text{O}$. This left an impure solution of zinc and sodium chlorides containing only 0.5 per cent of sulphates.

¹GUNTHER: *Dis Darstellung des Zinks auf Elektrolytischem Wege*, 100.

The Glauber's salt, after washing on a suction filter, contained 0.05 to 0.07 per cent of zinc as zinc chloride, but this did not seem to detract from its market value, the main trouble coming from small amounts of ferrous sulphate which sometimes accompanied it and later discolored the salt on exposure to air. Iron, manganese, nickel and cobalt were removed by heating the solution and adding a mixture of bleaching powder and marble in tanks made of iron or wood lined with an acidproof material. Oxidation and hydrolysis, similar to that described for the purification of zinc sulphate solutions, took place, the chloride of lime serving as the oxidizer and also as hydrolyzer. Chloride of lime may be regarded as essentially a hypochlorite of calcium, approximately CaOCl_2 , which is capable of yielding free chlorine to the solution or at higher temperatures giving free oxygen. The temperature was best held at 40 to 50° C. and the mass was agitated by wooden paddles sheathed with lead, although lead did not last well in this solution. Addition of bleaching powder was continued until a sample of the filtered solution gave a test for free chlorine. During this precipitation of iron, manganese, etc., most of the remaining sulphates were precipitated as calcium sulphate. The solution was then filtered in a press using a diaphragm pump and tile-lined pipes. The filtered solution was then treated with zinc dust in about the theoretical quantity to remove lead, copper, cadmium, arsenic, thallium and other impurities electronegative to zinc. This reaction was quite rapid and complete at 40 to 50° C., and left a solution containing only zinc and sodium chlorides. Its average analysis was 9.0 to 9.5 per cent Zn and 23 to 24 per cent Cl_2 . This solution was used for electrolytic deposition of zinc in Hoepfner's cells.

It is self evident that such a solution is not adaptable for use in making zinc chloride for commerce, since there is so much excess sodium chloride present. Electrolytic deposition is the only treatment to which this solution is adapted. Since electrolytic deposition of zinc from chloride solutions

is difficult and the operating details are known to only a few people, chloridizing roasting and leaching of zinc is not practiced at present. Zinciferous pyrite cinder from sulphuric acid plants is quite common and in some cases it is treated for copper. As an instance, for many years (before the war) the Pennsylvania Salt Co., near Pittsburgh and also near Philadelphia, has given a chloridizing roast to Spanish pyrite cinder to chloridize copper which is present to the extent of 0.5 to 2.0 per cent. The solutions run to waste from the copper plant were known to contain up to ten thousand pounds of zinc daily.

Recent work with the so-called "chloride volatilization" process under the direction of the author¹ has been quite successful in rapid chlorination of lead, copper, gold and silver in a revolving kiln furnace, forming volatile chlorides of the metals in question. However, with either sulphide or oxidized zinc ores erratic recoveries which rarely exceeded 50 per cent were obtained by all known variations of the process. Chloridizing roasting of zinc is only successful in long, slow roasting at low temperatures.

Chlorination with Chlorine Gas.—Few chemical reagents react on natural zinc sulphide with any speed or avidity, but chlorine gas is quite active at temperatures above 100° C. Cold dry ore is not attacked by chlorine gas with any speed whatever, although chlorine acts on the ore if it is suspended in water. In this latter case the velocity of the reaction seems to depend upon the percentage of chlorides of iron and copper present. Ferric chloride reacts on the zinc sulphide and is reduced to ferrous chloride and it is the ferrous chloride which absorbs the chlorine gas. Multivalent elements like iron and copper are much better adapted to wet chlorinations of this character. However, wet chlorination is not an easy or desirable process to use, due to the fact that it requires the presence of an appreciable quantity

¹United States Bureau of Mines *Bulletin* 157, Innovations in the Metallurgy of Lead, by D. A. LYON and O. C. RALSTON. Also *Bulletin* 168, Recovery of Zinc from Low-Grade and Complex Ores, by D. A. LYON and O. C. RALSTON.

of some multivalent element and also the sulphur from the zinc sulphide and other sulphides is converted into either sulphates or into sticky plastic sulphur which coats the ore particles and makes filtration difficult. For this reason, dry chlorination is the only type which has been favorably considered.

In the field of dry chlorination a great deal of work has been done and much money expended. The various processes tested have often come very near to commercial success, but none of them have ever had enough time and money expended on them to work out the various mechanical and chemical problems which arose. The two most prominent efforts to develop a dry chlorination of ores have been made by E. A. Ashcroft and J. Swinburn in England, and by J. L. Malm in the United States.

An extensive experimental plant was operated by E. A. Ashcroft at Cockle Creek, New South Wales, in about the year 1896. This was a wet chlorination plant using ferric chloride as the chlorinating agent and proposing the electrolytic recovery of the zinc and regeneration of the solution. This process failed after about two years' work and the expenditure of a large amount of money. However, Ashcroft returned to England and in collaboration with James Swinburn came out with a new proposal. This "Phoenix Process," as it was called, involved the preparation of a bath of molten zinc chloride in which the finely ground zinc sulphide ore was to be suspended. A stream of chlorine gas or of sulphur chloride vapor was then passed through the mass and the effort was made to maintain the temperature at from 550 to 650° C. This was for the reason that the reaction became sluggish below 550° C. and above 650° C. too much zinc chloride was evaporated (zinc chloride boils at 730° C.). In this manner, the chlorine attacked the zinc sulphide according to the equation:

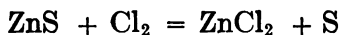

The sulphur, being liberated above its boiling point

(444.5° C.), came off as vapor, carrying some zinc chloride vapor, and could be condensed in an air-cooled condenser. The apparatus in which this reaction was carried out is sketched in Fig. 21. It consisted of a steel shell lined with fire brick, with a suitable tap hole of iron and a carbon tube

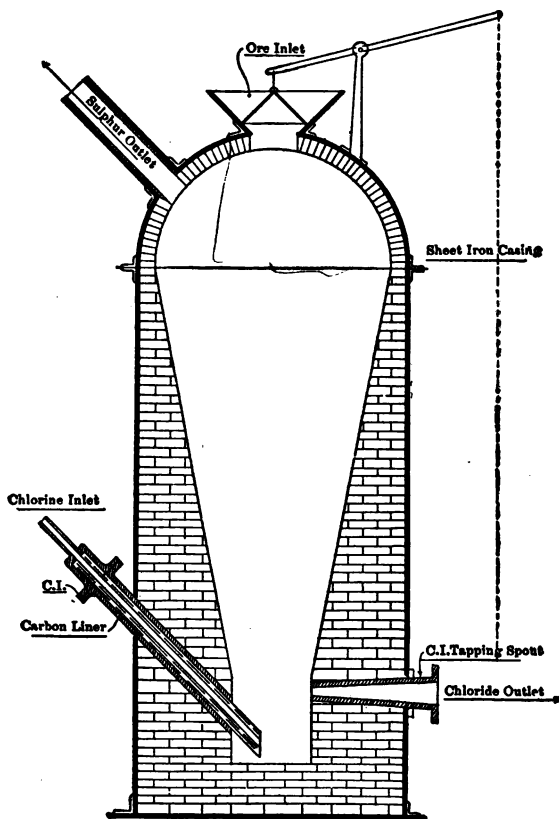

FIG. 21.

for introducing the chlorine. One of these "converters" was operated at the works of the (British) Castner-Kellner Co. for some time, treating about thirty tons of ore per week, but was not retained.¹

¹Chloro-Electrolytic Smelting, COBELDICK, *Electrochemical Industry*, 3:63 (1905).

A smaller converter, capable of treating about one thousand pounds of ore daily, was also tested by the author at the works of the Hooker Electrochemical Co., in Niagara Falls, New York, in 1918, but was abandoned for reasons stated below. During the work practically every statement given in the paper by Prof. W. Morley Cobeldick was substantiated.

When the charge in this converter gets too cold, 550-575° C., some sulphur chloride appears in the exit gases. It is then the duty of the operator to turn on more gas to bring the temperature back up to the proper operating range. If the converter gets too hot (700° C.) the sulphur vapor will be contaminated with too much zinc chloride vapor and will be lighter colored. This means that the gas feed must be diminished. When all the ore in the converter has been chloridized, any ferrous chloride present as a result of chlorinating iron sulphide will be converted to the very volatile ferric chloride which lends a marked brown or red color to the exit vapor. Simultaneously the sulphur vapor disappears. This is taken as the end point and the mixture of molten chlorides, with any gangue originally present in the crushed ore, can then be tapped out of the converter into water in order to form a solution of impure zinc chloride which can be purified by known methods. Enough molten zinc chloride is left in the converter to start the next charge. The writer finds the main trouble with this apparatus is the narrow temperature range which must be maintained during chlorination. The thick walls of the converter do not allow much heat to be dissipated and the reaction is so exothermic that a serious problem of heat disposal is involved. Heat is used up in vaporizing sulphur, and in heating the cold ore dropped into the converter, as well as in heating the gas blown into it. A further amount of heat is removed from the converter in the molten chlorides tapped. The ore can only be fed in gradually since a large charge of ore cools the molten zinc chloride below the temperature at which chlorine will react vigorously and it is then difficult to bring

the charge back up to the operating temperature while all the time offensive chlorine and sulphur chloride vapor are issuing from the apparatus. The volatilized sulphur is of a yellow color and can be condensed in brick or iron flues. It must be washed to remove volatilized chlorides and is then contaminated only with ore dust which may have been blown into the condensers before becoming wetted with the molten zinc chloride.

If there is any air in the chlorine blown into the converter the oxygen forms sulphur dioxide which goes through the sulphur condenser, together with the nitrogen of the air. This exit gas tends to carry along solid particles of sulphur and special arrangements must be made for its discharge. Ashcroft made an alternative proposal to use sulphur chloride vapor for the blast of the converter, the sulphur of the sulphur chloride joining the sulphur of the ore. Sulphur chloride can be made from dilute chlorine gas easily, and can be stored in iron tanks with little difficulty. This is a very practical proposal since it puts a reservoir for the chlorine between the source of chlorine gas and the converters and eliminates exit gas. Sulphur chloride is also a byproduct from the manufacture of carbon tetrachloride and a large use for it would allow the expansion of the carbon tetrachloride business.

There is no reason why the Swinburn-Ashcroft converter could not succeed technically if operated by a good grade of labor and with uninterrupted supply of ore and chlorine. Units of bigger size would tend to smooth out inequalities of feed and heat dissipation, but they would have to be designed in different shape from that shown in Fig. 21.

The Swinburn-Ashcroft process is covered by United States Patents 691,822 and 695,126 of 1902.

In the Malm process for treating zinc sulphide ores with chlorine, the effort is made to keep down the temperature of the mass to such an extent that chlorine can attack the ore and form solid zinc chloride and solid sulphur. Since sulphur melts at slightly above the boiling temperature of water

this restricts Malm's method of chlorination to about the boiling temperature of water. The chlorination is carried on in a revolving cylinder with a fire-clay lining and the chlorine is diluted with air to keep down the temperature. The writer has found the action of chlorine rather sluggish at this temperature and has never been able to obtain complete chlorination of the sulphides in a concentrated ore. A small commercial experiment by Malm was made at Corbin, Montana, in about 1907, but failed, due to lack of capital to see it through to completion. A similar venture and failure were made at Georgetown, Colorado, in 1909 and 1910. Finally a well financed experiment was made at the Bunker Hill and Sullivan mine, in Kellogg, Idaho, in 1914. In this case, technical difficulties with other parts of the process never allowed a thorough test of the chlorinating cylinder before the work was abandoned. There seems little doubt but that chlorination can be carried on with the dry ore in a revolving cylinder, especially with a low-grade ore containing much gangue, but as to the ability to keep down the heat to a point where the ore will not ball up with plastic sulphur, or even molten zinc chloride, the writer is skeptical.

Dry chlorination at intermediate temperatures between those of Malm and of Ashcroft is attended with the difficulties caused by melting of sulphur or of zinc chloride, and it is doubtful if there are any conditions which will allow easy technical operation in this range of temperature.

Chlorinating with Solutions of Metal Chlorides.—Literally hundreds of processes have been proposed for using solutions of ferric chloride, cupric chloride and similar multivalent metal chlorides in order to chlorinate zinc sulphide ores. Many of these require the use of hot solutions in order to obtain speed in the chlorination. Practically every one of these processes fails, either due to difficulty in designing hydrometallurgic machinery which will withstand the reagents used, or due to the formation of sulphates or plastic sulphur from the sulphur of the zinc ore. Further, all of the iron and copper must be removed from the zinc chloride

solutions before the zinc can be recovered in any marketable form. Whereas these processes may have chances of technical and economic success in the treatment of ores of copper, silver, gold and even lead, the difficulty of recovering zinc from its solutions makes these processes impossible.

Byproduct Chlorinating Agents.—We will now turn from the agents which are used directly for the chlorination of zinc ores, to products which are byproducts of other industries and which have found profitable outlet in the treatment of zinc ores. Calcium chloride and muriatic acid have been used in this manner for years and the possible use of dilute chlorine has already been mentioned in discussing the Swinburn-Ashcroft process.

Calcium Chloride.—For over twenty years calcium chloride has been used at the plant of Brunner, Mond & Co., Winnington, England, for treating roasted zinc ore, forming a zinc chloride solution which is electrolyzed to form metallic zinc of high purity and chlorine gas. The calcium chloride is a byproduct from the manufacture of sodium carbonate by the ammonia process. The calcium chloride solution is passed down a tower with roasted zinc ore and carbon dioxide or flue gas is passed up the tower. The reaction which takes place is:

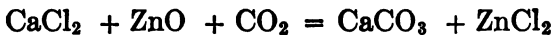

The calcium carbonate is an insoluble precipitate and the zinc chloride solution can therefore be filtered off and purified ready for electrolysis.

Muriatic Acid.—Byproduct muriatic acid has also been used for years in the manufacture of zinc chloride both in England and the United States and it has undoubtedly been likewise used in Germany and France. In the United States the principal byproduct muriatic acid comes from the salt cake plants of the various heavy chemical companies. Salt cake (sodium sulphate) is required in large quantities in the glass-making industry and the demands of the glass industry largely determine how much muriatic acid is on the market.

The salt cake is made by treating salt with sulphuric acid, which gives hydrochloric acid gas as a byproduct. This gas must be absorbed in water and sold as muriatic acid or the muriatic acid converted into something else which can be sold. The manufacture of zinc chloride from this acid and roasted zinc ore or zinc skimmings or scrap zinc, is carried on in the United States by three large companies and a number of smaller ones. Zinc skimmings and drosses are most commonly used for supplying the zinc.

Another source of byproduct muriatic acid, of growing importance since the World War, is the hydrochloric acid formed during the chlorination of various organic compounds with chlorine gas. The chlorination of benzene and toluene gave large quantities of muriatic acid during the war.

PURIFYING ZINC CHLORIDE SOLUTIONS

The purification of zinc chloride solutions does not differ greatly from that of sulphate solutions in either the chemistry involved or the apparatus used. Where oxidizing agents with high oxidizing potential are required, chlorine, hypochlorites, chlorates and similar reagents are easily and cheaply available, whereas the best oxidizing agents for sulphate solutions are somewhat expensive and often hard to obtain.

Zinc chloride solutions have a powerful solvent effect on cellulose and lignin, especially while hot and concentrated. A cold dilute solution of zinc chloride can be handled in wood with satisfaction, but it has been found best to use wood or concrete tanks lined with lead or with mastic or with acid-proof masonry if hot or concentrated solutions are to be used. For filtering, filtros or alundum make good filters when set in lead and packed with asbestos rope or mastic. For pumping neutral solutions there can be used tile air-lifts, porcelain pumps, bronze pumps, wood pumps, or even iron pumps, providing the solutions do not contain impurities which can be precipitated by iron (copper, silver, etc.).

Iron.—The removal of iron from zinc chloride solutions

takes place by oxidation and hydrolysis in the same manner as with zinc sulphate solutions. Crushed lime rock may be used for hydrolysis if the solution is to be electrolyzed, but if the solution is to be concentrated and sold for its zinc chloride, zinc oxide is used for hydrolysis. Zinc oxide works much more quickly in hot than in cold solutions. For an oxidizing agent, chlorine gas can be bubbled into the solution until most of the iron is gone, or air may be blown through the solutions. Oxidation by air is slow. At the end the final traces of iron can be oxidized and hydrolyzed by the addition of a small amount of bleaching powder or of sodium chlorate. The latter works well only in hot solutions when it decomposes, due to the heat, giving oxygen and oxides of chlorine.

Aluminum is hydrolyzed together with the iron.

Manganese is oxidized to the higher oxides of manganese by the use of chlorine or bleaching powder or sodium chlorate. It is not completely thrown out of solution at ordinary temperatures, except on long standing. The hydrolysis and oxidation is greatly helped by heat. Light also catalyzes the oxidation of manganese and its precipitation as the black or brown hydrated oxide.

Cobalt and Nickel usually accompany the manganese when it is thrown out. They require about the same oxidizing potential for their removal.

Copper, Cadmium, Lead and Thallium are easily removed by zinc dust in the same way as in zinc sulphate solutions.

Antimony and Arsenic are less harmful in the electrolysis of zinc chloride solutions than in sulphate solutions and are not so difficult to remove. The presence of plenty of ferric iron during the hydrolysis usually sweeps out most of the arsenic and antimony.

Solutions of zinc chloride containing up to 35 per cent of $ZnCl_2$ are easily filtered while cold, and easily purified, but with more concentrated solutions heat is usually necessary.

CHAPTER VII

ELECTROLYSIS OF ZINC CHLORIDE

After a purified solution of zinc chloride has been obtained, the zinc and chlorine can be separated from each other by electrolysis in two different ways. The solution may be electrolyzed under proper conditions, or it may be evaporated to dryness and the resulting zinc chloride fused and electrolyzed in the molten state. Only aqueous electrolysis is in successful commercial use, although fused zinc chloride cells have been tested on a large scale by several different companies, both in Great Britain and in the United States. The aqueous electrolysis plant of Brunner, Mond & Co., at Winnington, England, so often mentioned in this book, is the only one definitely known to the writer to be in commercial operation. The details of this plant are kept secret by the company. It was designed by Carl Hoepfner, who installed the original demonstration plant at Fűrfurt, Germany, where sixty cells in series were operated. The Fűrfurt installation has been very completely described in a book by Emil Gűnther¹ and much of that which follows is a review of this work, together with the more recent experience of the writer. Except for needing more modern materials of construction for the cell and changing the mechanical arrangements to some extent, Hoepfner's work can be accepted as good modern practice in the electrolysis of zinc chloride solutions.

The electrolytic decomposition of zinc chloride solutions differs from that of zinc sulphate solutions in that the chlorine must be trapped and led away separately from the extracted solution, whereas in sulphate electrolysis the anode products are sulphuric acid which remains in the solu-

¹"Die Darstellung des Zinks auf Elektrolytischem Wege," by EMIL GűNTH^{ER}, published by Wilhelm Knapp, Halle, 1904.

tion and oxygen gas which escapes into the air of the cell-room. The sulphuric acid causes re-solution of zinc, but it lowers the resistance of the solution so that a lower voltage compensates for the increased corrosion of the cathode. In the case of chlorine most of it passes away as gas, but it is soluble in the zinc chloride solution to some extent and if this solution gets in contact with the cathode, corrosion takes place. If the electrolyte is free from iron, it is possible to deposit zinc with fair efficiency in the presence of a chlorine-saturated solution, but when ferric iron is present to the extent of 10 mg. or more per liter, serious re-solution sets in. It is therefore necessary to use diaphragms between the anode and cathode to trap most of the chlorine and allow little chlorine-bearing solution to diffuse into the vicinity of the cathode.

Electrolytic Tanks.—The Furfurt plant was built with wooden tanks, white birch or similar non-resinous wood proving to be the most resistant to the zinc chloride solutions. Pitch pine is a very poor material for this purpose. The writer has found mastic concrete tanks very easy to construct, and chemically impervious to the action of the solution, with the exception that the outer layer allows some iron to go into solution for the first few weeks of use. Albarene stone or slate tanks are even better, or wood tanks with stoneware slabs in acidproof cement for a lining. These latter materials all have iron in their composition and for a time give up iron to the solution in contact with them. After all the iron in the surface layers has leached out they make very satisfactory materials of construction.

Due to the fact that Hoepfner used rotating cathodes, he built his tanks in a V-shape, to more nearly conform to the disc cathodes, the lower halves of which dipped into the electrolytic tank between the anodes. Individual anode compartments of wood with nitrated cotton diaphragms for sides were submerged in the tank and surrounded the carbon anodes.

Anodes.—The anodes consisted of slabs of gas-retort

carbon in the Förfurt plant, but the modern carbon anode is of artificial graphite. The retort carbon was hard to cut into the desired shape and only had a life of six to eight months. Artificial graphite has been used by the writer for periods of over twelve months without much visible deterioration and the indications are that it should have a five-year life when used at not over 25 amps. per sq. ft. in a zinc chloride solution.

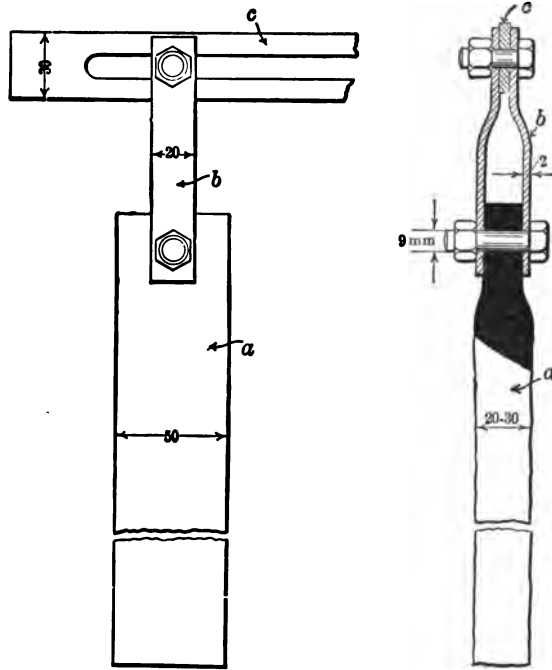

FIG. 22.—Anode connections at Förfurt

The method of making connections to the carbon anodes, as used at Förfurt, is shown in Fig. 22. The carbon anodes are designated by the letter *a*, connected by screw-bolts to lead strips *b* which are in turn bolted to a slotted zinc conductor *c*, which supplies current to the other carbon slabs which make up the remainder of the anode. The top end

of the carbon anode should be dipped in molten paraffin or other heavy oil in order to prevent electrolyte creeping up the carbon to the contacts with resulting corrosion. Modern artificial graphite has about 30 per cent pore-space which must be filled with some non-conducting oil to prevent electrolytic disintegration of the carbon anode due to gases liberated in the pores. Nearly all the oils used for this impregnation are subject to attack by chlorine and ultimately turn into a sticky mass called "cell gum." The cell gum sometimes causes stoppages in the outlet holes intended for chlorine gas or spent electrolyte.

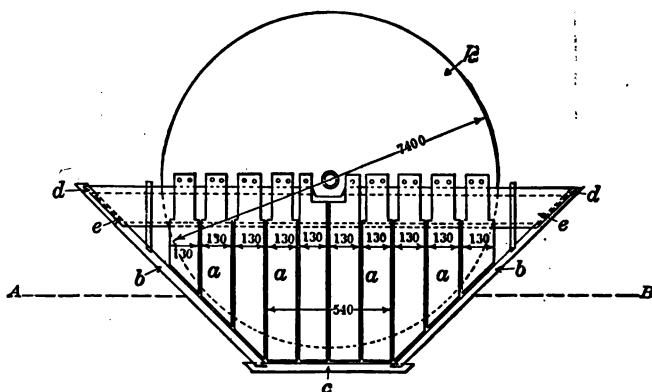
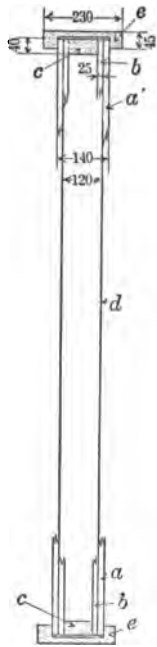
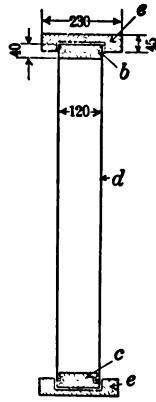

FIG. 23.—Elevation of one anode frame and anodes

Drawings of Hoepfner's anode compartment (taken from Günther's book), are given in Figs. 23, 24, 25 and 26 (dimensions in millimeters). The side view is given in Fig. 23, which shows the wooden frame conforming in shape to the V-box of the tank, but with the bottom cut off to allow passage of the electrolyte underneath between the various cathode compartments without difficulty. The anodes are also shown in place. A top section of the anode compartment shown in Fig. 23 is given in Fig. 24, which shows the wooden frame and the nitrated cotton diaphragm. A cross-section through the line *AB* of Fig. 23 is given in Fig. 25. All dimensions are in millimeters. Finally, a section through



Top View



Section at AB

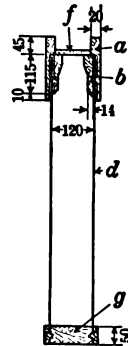

Section at CD

FIGS. 24, 25, 26.

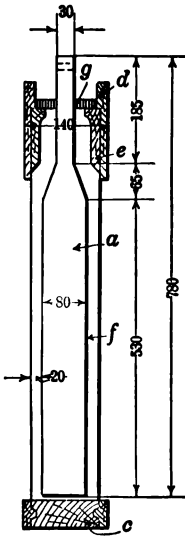

FIG. 27.

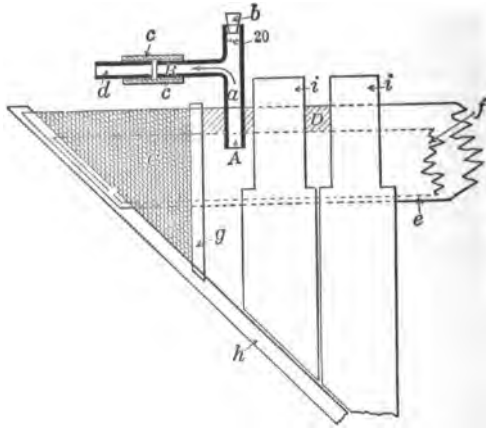

FIG. 28.

CD is given in Fig. 26. These views, which omit the anodes, show that the wooden frame is provided with grooves into which the nitrated cotton diaphragm cloth is clamped by strips of wood. Along the top the diaphragm is supported between two boards which dip below the level of the solution in order that the chlorine gas rising from the anolyte will be properly trapped. In Fig. 27 is shown a section of the anode compartment with an anode in it. The anode sticks through a slot in the top board and space is left above the board to pour mastic or tar around the anode in order that it may be made gas-tight. A general view of an assembly of carbon rods into one composite anode is given in Fig. 23, which also shows the disc of one of the rotating cathodes behind the anode. A more detailed section of this anode compartment is given in Fig. 28, which also shows the arrangement for conducting the chlorine gas from the anode compartment. The hatched areas denote spaces filled with tar or mastic. A heavy glass or hard rubber T-tube conducts the chlorine from the gas space above the liquor line. A rubber hose connection allows the chlorine to pass into a header-line and leaves a stopper in the top of the T for purposes of clearing obstructions or venting the compartment when necessary.

Diaphragms.—One of the most important things about a zinc chloride cell is the diaphragm material. Hoepfner used nitrated cotton. The writer has used asbestos cloth and "electro-filtros" blocks. The latter have the advantage of being mechanically strong, but impose too high a resistance to the passage of the electric current. At 15 to 25 amp. per sq. ft. the resistance of electro-filtros is equivalent to 1.0 to 1.5 volts so that in place of using 2.9 volts, 4.0 volts are required.

Fair energy efficiency can be obtained in the deposition of zinc without any diaphragm, providing the solutions are sufficiently pure, but it is almost impossible to prevent the entrance of sufficient iron to cause serious re-solution trouble. What is wanted is something which will keep 95 to 98 per

cent of the anolyte in the anode chamber and yet not impose a high resistance to the passage of the electric current. Solid diaphragms like electro-filtros or "alundum" impose a high resistance, but act as perfect diaphragms. Nitrated cotton cloth or asbestos cloth come nearer the ideal of imposing a negligible resistance and yet trapping most of the chlorine solution.

Hoepfner's plant at Fűrfurt used nitrated muslin which had first been boiled in soda solution to remove grease and fats. This cloth was then immersed two hours in cold nitric acid of 46-47° Bé., followed by immersion for 1.0 to 1.5 hours in cold concentrated sulphuric acid. The fabric was then carefully washed free of acid and stored under water. While it was very tender and never lasted more than six or seven months, it was the best that could be done at the time. Unequal nitration, due to inequalities in the cloth and the presence of greases, was thought to account for much of the trouble. There is no doubt but that a much more satisfactory material should now be possible, especially if the cloth were impregnated under pressure or in vacuo, depending on conditions. Alternate baths in sodium silicate and sulphuric acid have been suggested as another method of preparing the cloth, but the writer fails to see how this would make it resistant to chlorine which can diffuse through the colloidal silica.

Asbestos cloth with a close weave and extra heavy thickness was found fairly satisfactory by the writer, although it too often tore or was ruptured soon after its installation. Furthermore, most asbestos cloth contains undesirable loading materials and gives off iron to the solution. It is therefore best to wash the cloth with muriatic acid before use in the cell.

Cathodes.—Hoepfner used rotating discs of sheet zinc for cathodes, the lower half or third of the disc dipping into the electrolyte. A plan view of a cell is given in Fig. 30, showing the arrangement of a gang of seven cathodes on a common rotating shaft with iron dogs as spacers. The electric con-

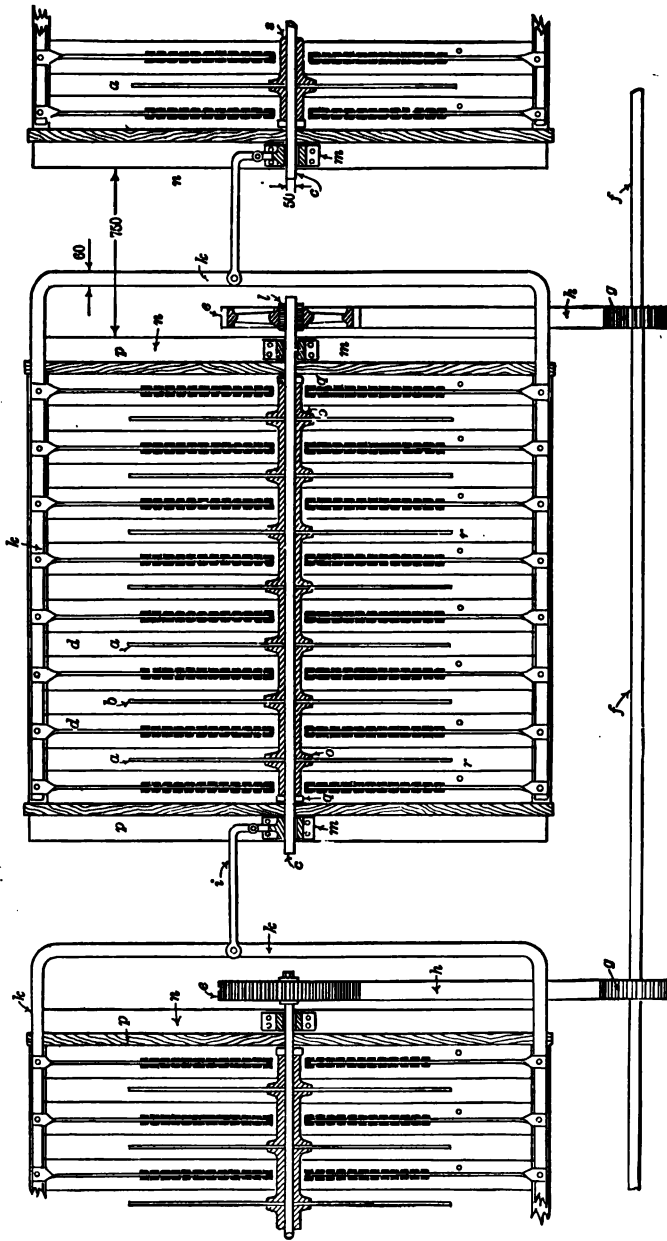

Figs. 29-30.

nections for conveying the current into the cell through the anodes and out through one of the bearings of the shaft supporting the disc cathodes is also shown. The cells were connected electrically in series. These discs were about 60 in. in diameter (1,400 mm.). The writer used aluminum discs and aluminum shafting, in order to avoid contamination of the solution with iron. It was found that in impure solutions better current efficiency could be obtained in a cell with stationary cathodes, while in pure solutions it did not make much difference. This led ultimately to the abandoning of rotating cathodes, due to greater difficulty in keeping them lined up exactly perpendicular to the shaft and in stripping them. At Fürfurt the cathode shaft was rotated from a line shaft by cogwheels and chain. Each cell took 1,000 amp. and the current density was about 8 amp. per sq. ft.

Voltage.—Similar to the voltage necessary to operate a zinc sulphate electrolytic cell, the voltage of the zinc chloride cell depends upon the resistance of the solution and upon the desired current density, higher voltage being needed to obtain a high current density than is necessary for a low current density. However, in the sulphate cell the sulphuric acid formed at the anode remains in the solution and greatly modifies the properties of the solution, whereas the small amount of dissolved free chlorine in a zinc chloride solution does not appreciably lower the voltage. A set of voltage measurements for a small experimental cell are plotted in Fig. 31, these figures having been collected under the direction of the writer by B. H. Jacobson. The curves show that it takes a very high voltage to operate in dilute solutions of zinc chloride and that it will probably not pay to strip the solutions much below 3 per cent of zinc. Similarly, in the more concentrated solutions a higher resistance is met and it would not pay to electrolyze solutions containing more than 22 or 24 per cent zinc (45 to 50 per cent zinc chloride). The best operating range at 15 amp. per sq. ft. is between 20 per cent zinc and 6 per cent zinc. These measurements

were taken with a cell containing no diaphragm, but not operated long enough to allow chlorine-saturated electrolyte to come in contact with the cathode.

Where a diaphragm is used, additional resistance is introduced into the cell and a higher corresponding voltage is necessary. A closely woven asbestos cloth diaphragm adds about 0.2 volts to the above figures, while an electro-filtros diaphragm adds 1.0 to 1.4 volts to the necessary voltage to operate a cell.

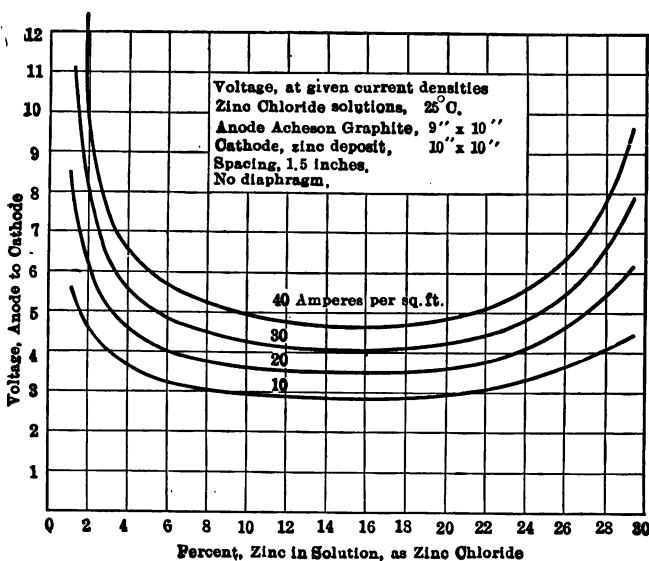

Fig. 31.

With a solution saturated with chlorine, very little hydrogen is evolved at the cathodes, the deposit is smoother, the voltage is lowered 0.5 to 1.3 volts, but the current efficiencies are lowered from 90 per cent or better in a clean chlorine-free solution to 60 per cent or less in the chlorine-saturated solution. However, the lower voltage compensates for the lower current efficiency to a considerable extent so that the energy efficiency is not much affected. A few figures on the effect of chlorine in the electrolyte on the vol-

tage will illustrate: At a current density of 10 amp. per sq. ft. in an 11 per cent zinc solution, the voltage should be 2.9 according to Fig. 31. Actually it is 2.6 when the solution is saturated with chlorine. At a current density of 33 amp. per sq. ft. in a 15 per cent zinc solution, the voltage according to our curves should be 4.2, but is actually 3.1. At a current density of 36 amp. per sq. ft. in a 2 per cent zinc solution, the voltage should be 7.2, but is actually 4.8.

The theoretical decomposition voltage of a zinc chloride solution, calculated from the heat of formation of zinc chloride, is 2.43 volts at zero current density. In a solution saturated with chlorine, at 9 amp. per sq. ft., readings as low as 2.50 volts can be obtained with current efficiencies as high as 50 per cent.

Current Efficiency.—The current efficiency of zinc deposition is greatly influenced by the presence or absence of free chlorine dissolved in the electrolyte, in conjunction with the presence of iron. As stated before, a current efficiency of 70 per cent or even higher can be obtained in a solution saturated with chlorine, provided the ferric iron content is below about 10 mg. per liter. This current efficiency rapidly falls off with increasing amounts of iron. In fact, enough iron is introduced into the solution from the carbon anodes, the tile pipe and other stoneware used for launders, and other parts of the apparatus to cause a lowering of current efficiency to 60 per cent or 50 per cent, and toward the end of a run, when the zinc content of the solution has been reduced to 2 per cent or less, the current efficiencies drop to 40 per cent or 30 per cent.

This effect can be practically eliminated by the use of electro-filtros diaphragms, although even then some chlorine gets into the catholyte where it can reoxidize any ferrous iron to the undesirable ferric state. Current efficiencies of 85 to 95 per cent have been obtained by the writer when these diaphragms were in use.

Asbestos cloth diaphragms impose less resistance to the passage of the electric current and retain the chlorine-

saturated solution sufficiently to give current efficiencies of 80 to 90 per cent. However, the asbestos cloth contains enough iron to cause trouble during the latter part of the first few runs. The great trouble with asbestos cloth and similar fabric diaphragms is that they are so easily injured while in use and a small rent will allow a great deal of chlorine solution to pass from the anode compartments into the catholyte. Hoepfner's Fürfurt plant operated with about 0.2 per cent free chlorine in the anolyte and 0.01 per cent in the catholyte, and even this much was thought to be too much for the best operation.

Another cause of decreased efficiency is the presence of dissolved organic matter in the solutions. This slowly chlorinates and liberates hydrochloric acid so that the acidity of the solution usually rises somewhat at the beginning of the electrolysis and then begins to fall off as the hydrochloric acid reacts on the zinc cathodes. Too much organic matter causes very poor current efficiency and rough black cathodes. At Fürfurt it was found that hot solutions or strong solutions of zinc chloride attacked the wood of launders, tanks and other apparatus so much that it was impossible to get good cathodes. By using only cold solutions in wood vessels and substituting other materials of construction where hot solutions had to be used, satisfactory solutions for electrolytic deposition were obtained.

Energy Efficiency.—According to theoretical deductions from the decomposition voltage of zinc chloride solutions and the electro-chemical equivalent of zinc, a ton of zinc requires 1,809 kw.-hr. of electric energy for its deposition. The observed amounts of energy for depositing zinc under various conditions are plotted in Figs. 32 and 33, which are taken from data collected by the writer. From these diagrams it can be seen that 2,500 kw.-hr. per ton is the lowest commercially attainable figure (when a solution containing 18 per cent of zinc is stripped to about 10 per cent of zinc in a cell with good asbestos cloth diaphragms, operated at about 10 amp. per sq. ft. with a current efficiency of about

90 per cent). This corresponds to about 72.5 per cent energy efficiency.

Since the current efficiency depends so much on the purity of the solutions and the kind of diaphragm used, it is not

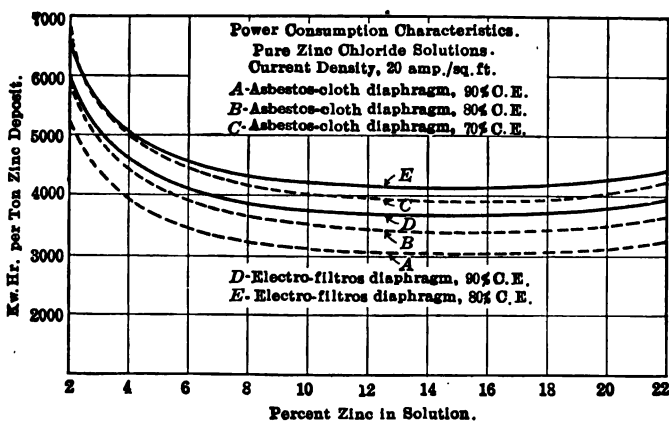

FIG. 32.

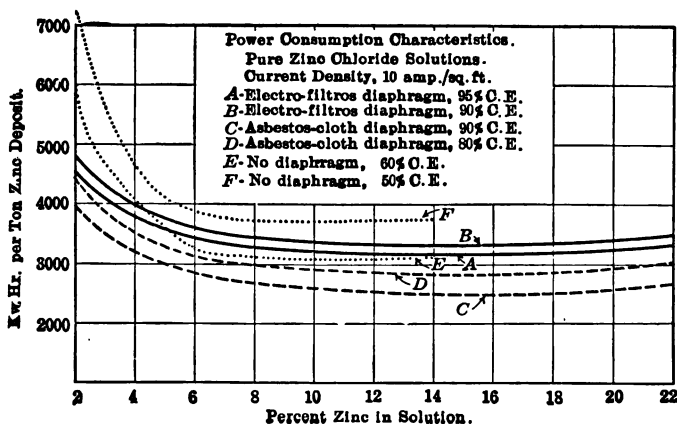

FIG. 33

possible to plot curves of the current efficiency as a variable with respect to any of the ordinary electrolytic factors, such as the acidity of sulphate solutions in Hansen's curves. Likewise the voltage depends on the kind and condition of diaphragm used, and it is therefore impossible to prepare any

generalized curves. On that account the writer has prepared the curves in Figs. 32 and 33 to represent three sets of conditions which have been tested by him. In Fig. 32 the solid lines represent power consumptions per ton of zinc at various dilutions of solution for two different conditions of an electro-filtros diaphragm—one well set in the cell and the other allowing some leaks of chlorine into the catholyte. All of these figures are for cells operating at 20 amp. per sq. ft. The leaky diaphragm is assumed to offer a resistance equivalent to 1.0 volt and to allow a current efficiency of 80 per cent. The well-set diaphragm is assumed to present a resistance equivalent to 1.0 volt and to allow a current efficiency of 90 per cent. The three dotted curves represent three similar conditions of asbestos cloth diaphragms which consume 0.2 volts and allow current efficiencies of 90, 80 and 70 per cent respectively. The spacing of the electrodes in these two sets of figures was 2 in.

The curves of Fig. 33 give similar figures for current densities of 10 amp. per sq. ft. with thicker and tighter electro-filtros diaphragms, asbestos cloth diaphragms and no diaphragms. The electro-filtros diaphragms are assumed to consume 1.5 volts, the asbestos cloth diaphragms consume 0.2 volts and the cells with no diaphragms operate at lower voltages than those given in Fig. 32, due to the excess free chlorine in solution.

Asbestos-cloth diaphragms, at 10 amp. per sq. ft. cathode current density, with solutions containing over 6 per cent zinc, offer the best possibilities of economy of power. In this range the energy efficiency varies from 65 to 70 per cent which is almost identical with that possible over somewhat shorter ranges of concentration of solution in zinc sulphate cells. From the standpoint of power consumption there seems to be little choice between sulphate and chloride electrolytes.

Circulation.—Mechanical circulation of the solution through a zinc chloride cell has different effects from those in a sulphate cell. To be sure, the cathodes are much smoother

with circulation than without, but if the solution is moved past the diaphragms with any rapidity, a considerable amount of chlorine can diffuse out and lower the current efficiency of cathodic deposition. On that account Hoepfner devised the rotating disc cathodes in order to have a slow, gentle motion of the cathodes through the solution without affecting the solution in contact with the diaphragms. The present writer finds that while rotating disc cathodes are very effective in giving smooth deposits, the deposits made on stationary cathodes without any circulation of solution whatever are somewhat rough, but show good current efficiency up to seventy-two or even ninety-six hours.

At Fürfurt a serious question arose when it was found that a cascade of fifteen tanks could not be operated successfully. Good cathodes were obtained in the upper tanks but those lower in the series did not operate well and no set of conditions could be found which seemed to remedy this trouble. The solution fed into the top tanks contained 9.0 to 10.0 per cent Zn and the solution from the last tank contained 1.0 to 1.5 per cent Zn. The solution was distributed to each tank and stripped there to 1.8 to 2.5 per cent zinc before overflowing from the opposite side of the tank and much better cathodes resulted. No explanation could be found for this behavior except that possibly the solution flowing through the cascade picked up a certain amount of impurities from each cell which caused trouble in the deposition in the lower cells.

Fürfurt Plant.—The general arrangement in the cell room at the Fürfurt plant is shown in Figs. 34 to 36, which are taken from Günther's book. There were sixty cells in four rows of fifteen each, but never all running at once. Each cell took 1,000 amp. at less than four volts. Room was allowed under each cell for working space and a concrete floor was installed, sloping to a recovery sump in order to recover any leaks. A small crane served the cells, being used for lifting the gangs of cathodes on their common rotating shaft, taking them to the end of the room and

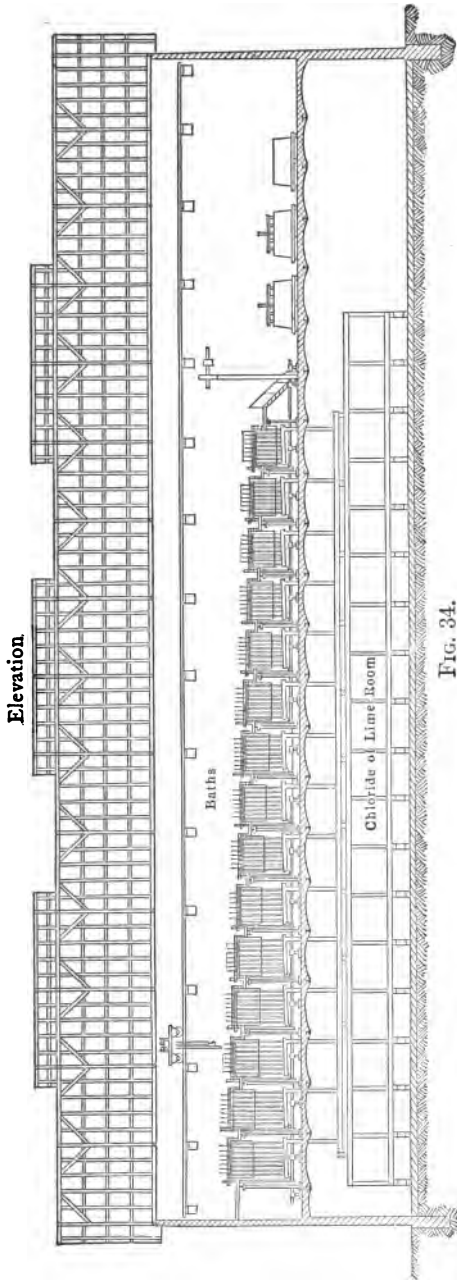

FIG. 34.

Plan

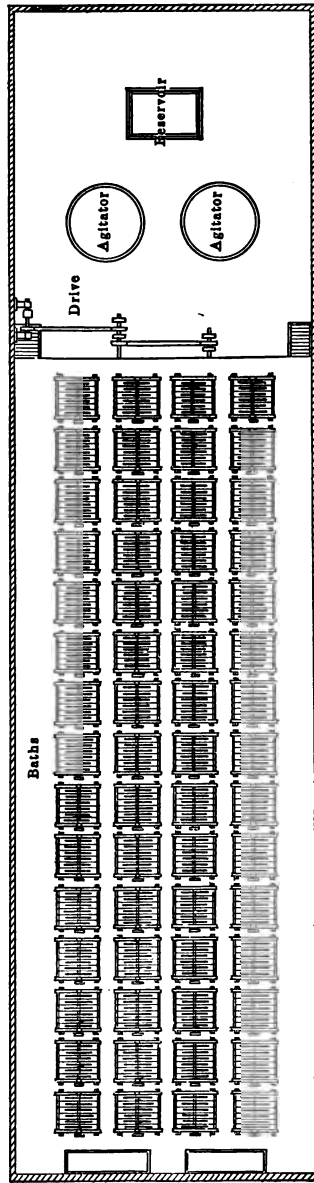

FIG. 35.—Hoepfner's plant at Fürturt

returning with a fresh set ready to place in the cell. The crane likewise lifted out any defective anode compartments and replaced them with compartments having fresh diaphragms. Copper bus bars, painted with a varnish to keep off the corrosive vapors, were used. The chlorine generated was allowed to pass to four chloride-of-lime rooms on the floor below the cell room.

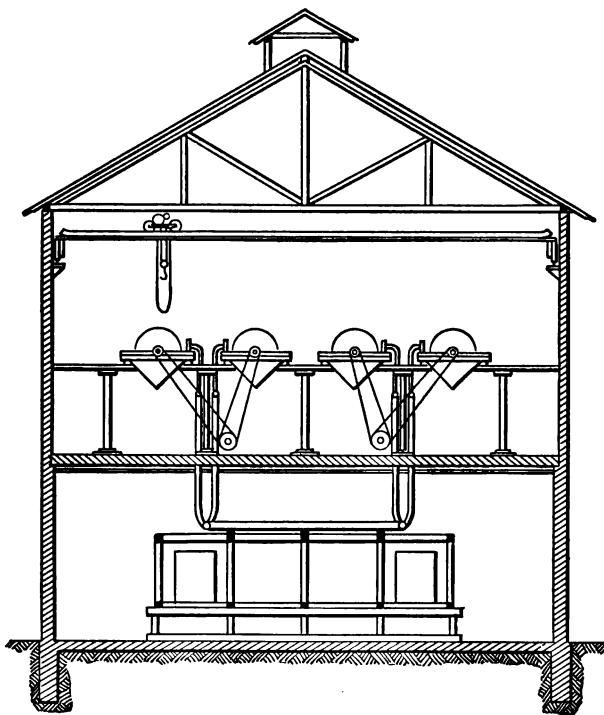

FIG. 36.—Hoepfner's plant at Fűrfurt (cross-section)

Conditions for Successful Electrolysis.—Beside the conditions mentioned above a number of other highly important conditions must be observed. The freshly prepared solution from the purification plant will be somewhat basic and on electrolyzing this solution sponge zinc is sure to form sooner or later. Hoepfner found at Fűrfurt that an excess of hydrochloric acid corresponding to 1-20 to 1-30 normal (0.18

to 0.12 per cent by volume of hydrochloric acid) was necessary to prevent formation of sponge, and the writer and co-workers have found this to be true except that 0.3 to 0.5 gm. HCl per liter is a better figure. This can be allowed to become as low as 0.1 gm., but at 0.2 gm. the solution will often begin to foam and the acidity must be raised to prevent foaming. If 0.5 gm. HCl per liter is exceeded the corrosion of the cathode becomes too excessive. Zinc is not passive toward hydrochloric acid in the same degree that it is passive to sulphuric acid, especially when pure, and on that account the lowest acidity which will prevent formation of sponge-metal is desirable.

The upper limits of allowable impurities are very similar to those permissible in zinc sulphate solutions, and are somewhat as follows:

Ferrous iron.....	300	mg. per liter.
Ferric iron.....	10	Do.
Manganese.....	15	Do.
Cadmium.....	10	Do.
Copper.....	10	Do.
Lead.....	5	Do.
Nickel.....	5	Do.
Cobalt.....	5	Do.
Antimony.....	5	Do.
Arsenic.....	1	Do.

The use of glue in zinc chloride solutions as an addition is not as successful in improving the condition of the cathodes as it is in sulphate solutions. It has a desirable effect and causes smoother plates, but it is an organic substance which can be chlorinated, just as other organic matter dissolved from wood, rags and other sources are chlorinated, and the electrolysis is unsatisfactory after compounds of this kind have accumulated to any extent. This is especially true when ferric iron is present. One part of glue in fifty thousand of solution is usually sufficient.

When the solutions contain too much ferric iron and organic matter, it is sometimes necessary to stop and send them back to the purification department where the slight

acidity can be neutralized with zinc oxide so that the iron will be thrown out of solution, sweeping with it some of the colloidal organic material. The filtered solution can then be acidified and returned to the tank-house.

The acidity of solutions containing organic matter undoubtedly increases, as Hoepfner observed, as soon as chlorine gets into the catholyte, due to chlorination of the organic matter, and this acidity may be so high as to cause serious corrosion. Manganese in the solution is also oxidized to manganic chloride and then the manganic chloride hydrolyzes even in slightly acid solutions, giving manganese dioxide hydrates,—in or near the anode compartment,—and hydrochloric acid. This is the reason that the percentage of manganese in the solution must be restricted more than in sulphate solutions.

ELECTROLYSIS OF FUSED ZINC CHLORIDE

A solution of zinc chloride can be evaporated to dryness and the resulting product fused. During the evaporation 4 or 5 per cent of the zinc chloride is hydrolyzed into hydrochloric acid vapor and zinc oxide which remains in the liquor. The solution becomes pasty at about 200-230° C., while 3 to 5 per cent of water are still present, and the pasty mass fuses to a clear liquid at about 260° C. The evaporation can take place in enameled iron pans and this is the general practice among the chemical companies, although special evaporators are also in use.

The proposal to electrolyze this fused zinc chloride has attracted a number of inventors. Swinburn and Ashcroft proposed to do this as a part of the "Phoenix" process described earlier in this book. They tested a cell using a carbon anode and a molten zinc cathode, claiming very satisfactory results. A mass of molten zinc chloride at about 450° C. was contained in a brick-lined iron pot with a carbon electrode passing in at the bottom. On this carbon electrode some molten zinc was poured, and on top of the molten zinc was the molten zinc chloride. A carbon anode projected

down into the molten zinc chloride, and on passing a current the zinc chloride was decomposed, chlorine collecting on the carbon anode in bubbles and escaping through a pipe on the top of the cell. The zinc deposited directly in the cathode of molten zinc so that occasionally molten zinc had to be tapped from the cell.

The Malm process likewise proposed the evaporation of the zinc chloride solution, followed by electrolysis in a specially designed cell. Several cells were built and operated at the test plant of the Bunker Hill and Sullivan Mining & Concentrating Co., in Kellogg, Idaho, but without success. Later, another test of a full-sized cell was made at the plant of the Hooker Electrochemical Co., in Niagara Falls, but failed again due to faulty details. This cell likewise used graphite anodes suspended above and parallel to a surface of molten zinc in a bath of molten zinc chloride. The cell body was of concrete lined with fire-clay slabs and the cover was of transite board.

The writer and co-workers have tested the electrolytic factors involved and find that with over a 3-in. spacing between anode and cathode the voltage is 4.5 to 6.0 volts, depending upon the current density, and it is practically impossible to get lower voltages than this, even with much closer spacing. At first sight it would seem to be desirable to make the electric current heat the cell during its passage through it, but it was found that the amount of heat passing out of the cell through the walls and especially along the graphite electrodes was very high and made it seem advisable to supply outside heat.

A fused zinc chloride cell is very desirable from one standpoint in that it does away with the necessity for diaphragms, concentrates the electrolytic plant into a very small space (a 5,000-amp. cell would occupy only 4 x 6 ft. floor space) and would simplify the operation. However, the high voltage necessary to operate the cell, as compared with aqueous electrolysis, makes it too wasteful of power and, in the writer's opinion, it should therefore be avoided.

CHAPTER VIII

ELECTROLYTIC ZINC REFINING

Three forms of impure zinc are available at present, all of which can be refined electrolytically. These are:

1. Ordinary spelter.
2. Galvanizer's hard dross.
3. Zinc crusts from desilverizing base bullion.

These differ in the impurities which are to be removed in order that pure electrolytic zinc can be obtained.

The bulk of the zinc sold in the world's zinc markets consists of a product containing small amounts of lead, cadmium and iron. In the first chapter, Tables II and III, are given the analyses of the various grades of zinc sold in the zinc markets of the United States.

The Prime Western zinc is the grade made in greatest quantity and sold at a price somewhat below that of the higher grades. For instance, during normal times there is rarely a difference of more than 1c. per pound between the cost of high grade and Prime Western, although the difference sometimes amounts to 2c. During the war in Europe a very heavy demand for High Grade zinc developed for use in cartridge brass. After production had been well established the prices of zinc settled down to a condition where Prime Western zinc was worth about 8c. per pound and High Grade worth 12c. This condition continued until the end of the war. Then the differential dwindled and was less than normal for over a year.

In addition to the differential between Prime Western and High Grade zinc, the value of the cadmium and lead recovered can be added to the assets developed by electrolytic refining of the zinc. Cadmium sells at the present moment for about \$1.40 per pound and since Prime Western zinc containing 0.6 to 1.0 per cent cadmium is easily obtainable, each

pound of zinc contains cadmium worth about 1c. The lead sells for less per pound than the zinc which it displaces, but it nevertheless has a positive value. The iron is present in such small quantity that it is disregarded as either a liability or an asset.

Galvanizers' hard dross is an alloy of zinc and iron which is removed from the galvanizing pots of establishments where iron or steel is coated with zinc by the "hot galvanizing" process. Iron slowly dissolves from the articles coated and from the body of the galvanizing pot, until the alloy contains about 10 per cent of iron and 90 per cent zinc. At this point it is withdrawn and cast into ingots which are sold to refiners. The common method of removing the iron from this alloy is to distill the zinc in a graphite retort.

The zinc crust formed in desilverizing base bullion (lead containing silver) mentioned above, is an alloy of zinc and silver, contaminated with lead, copper, iron and a few minor impurities. It is formed when silver-bearing lead is melted in a pot and treated at the right temperature with some molten zinc. A silver zinc alloy forms and floats on the top as a scum or crust, which can be skimmed off with a perforated ladle, allowing the lead to run out as much as possible, or even pressing out the molten lead in a press adapted to the purpose. Crusts containing as much as 80 per cent zinc can be made. The common method of treating them is to place in graphite retorts and distill the zinc. Most of the zinc is lost (20 to 40 per cent), due to poor condensation, the formation of blue powder, or non-distillation.

All of the above zinc products contain impurities which make their refining somewhat different from the problem presented in the electrolytic refining of copper. In the case of copper, the impurities like gold, silver and platinum which are less electropositive than the copper do not dissolve in the electrolyte used for refining and the impurities like iron and nickel, which are more electropositive than copper, go into solution and are not deposited electrolytically with the copper. In the case of zinc, the cadmium and lead are less

electropositive than the zinc, but cadmium is soluble in substantially every electrolyte which can be used for refining zinc. Where a chloride of zinc electrolyte is used, lead is likewise soluble. The iron in the impure zinc is likewise soluble, but is not deposited with the zinc, much like the case of iron in copper refining. The problem presented then is to prevent cadmium, and sometimes lead, from passing into solution at the anode and depositing with the zinc at the cathode. It was the non-recognition of this necessity which caused failure of the earlier refining schemes.

One of the first zinc refining processes to be patented was that of Hermann¹ which appeared in 1883. This process proposed casting commercial zinc or scrap zinc into anodes and using an electrolyte consisting of a double salt of zinc with one of the alkali or alkaline earth metals, such as sodium-zinc sulphate. The foreign materials of the anode were said to be transformed to insoluble form and precipitated out on the bottom of the tank. This would be true of lead, but not true of iron or cadmium. In case the solution were neutral some of the iron might hydrolyze but practically none of the cadmium would do so. The cadmium in the anode does not go into solution immediately, but the zinc dissolves, leaving a sponge metal containing cadmium and lead. This sponge metal does not dissolve as long as it is in electrical contact with the zinc anode, but as soon as the sponge falls to the bottom of the tank the cadmium tends to redissolve. On that account the present writer cannot find the elements of successful zinc refining described in Hermann's patents.

Alexander Watt, of London, also experimented in zinc refining, using galvanizers' hard dross. He proposed an electrolyte containing zinc sulphate and zinc acetate, the purpose of the acetate being to diminish the formation of trees and other irregularities. No mention is made of the disposal of iron dissolved from the anode. Watt estimated

¹German Patents 24,682 of April 24, 1883; 26,091 of June 26, 1883; and 33,107 of Sept. 14, 1884.

the cost of refining as 3 lb. sterling per ton (\$15 per ton) and the Gülcher Company, of London, is known to have tested his process and pronounced it very good. No commercial installation is recorded.¹

Johannes Pfleger, of Frankfort-on-the-Main, Germany, obtained a United States Patent² in 1893 for refining zinc in a basic zinc solution, such as basic zinc chloride or basic zinc sulphate. Zinc oxide dissolves to a slight extent in the chloride and sulphate solutions so that they become "basic". Under these conditions none of the impurities are supposed to be soluble in the bath. This may be true of lead and iron, but is certainly not true of cadmium.

Roelsing³ in 1884 worked out the details of a process for recovering zinc from the zinc crusts of the lead refinery of the Royal Frederick smelter at Tarnowitz. The zinc content of this material varied from 10 to 50 per cent, but was usually 12 per cent, and the following is an average analysis:

Lead	81.2%
Zinc	12.1%
Silver	1.075%

This material was too fragile and brittle to be cast into anodes and was therefore broken up and placed on a flat lead plate in the bottom of a cell containing a pure zinc sulphate solution. A zinc sheet cathode was placed in a horizontal position above the layer of broken alloy. The zinc of the alloy was found to be so imbedded in lead that it was not electrolytically available for solution in the electrolyte and the process was therefore abandoned.

Later, the development of the Roessler-Edelmann process of desilverization made available a zinc crust with about 80 per cent zinc which was much better adapted to this idea, and the work was again taken up at the Friederick smelter

¹British Patents 6,294 of 1887 and 3,369 of 1888.

²United States Patent 495,637 of April 18, 1893.

³German Patent 33,589. Also *Zeit. f. Berg-Hütten-und Salinenwesen im Preussischem Staate*, 1886, p. 91.

(Hamburg Gold und Silber Scheideanstalt) and was reported on by Hasse¹ in 1895.

The analysis of this material averaged as follows:

Silver.....	11.32%
Lead.....	3.13%
Copper.....	6.16%
Bi, As, Sb.....	Traces
Ni and Co.....	0.51%
Iron.....	0.24%
Zinc (by dif.).....	78.64%

This material could easily be cast into anodes 1 cm. thick, weighing 20-30 kg. (50-70 lb.), with lugs to rest on the sides of the bath. Zinc starting sheets were made, as in copper practice, and stripped off to serve as cathodes. The electrolyte consisted of zinc sulphate, the current density was 8 to 9 amp. per sq. ft. and the necessary voltage to operate the bath was 1.25-1.45 volts. Iron, copper and arsenic were reported to be very harmful to solutions, possibly due to the formation of sponge metal when the latter two were present. Ordinary room temperature was found best as heating the solutions caused poor deposits and cooling the solutions caused no improvement. Hasse stated that the silver could be recovered from the anode slime in a very simple manner and that the process was undoubtedly profitable. However, after two or three years of operation it was abandoned.

Schnabel² also experimented with zinc crusts at a smelter in Hoboken, near Antwerp, Belgium, using a solution containing chlorides of zinc and magnesium and a rotating cathode. He concluded that the recovery of zinc by this method was less profitable than by the old distillation method.

The American Smelting & Refining Co., at their lead refinery in Omaha, Nebraska, likewise tested electrolytic

¹Zeit. f. das Berg-Hütten-und Salinen-wesen im Preussen, 45, 322. Also Berg.- und Hüttenmännische Zeitung 1895, 431.

²Handbuch der Metallhüttenkunde, vol. 2, 233. SCHNABEL (Lewis Translation).

recovery of the zinc in the zinc crusts, during the years 1914 to 1916. While it was found more profitable than the distillation method, it was found that the zinc oxide market was even more profitable and the zinc of their crusts is now recovered as zinc oxide.

Prof. J. W. Richards, of Lehigh University, read a paper at the April 18, 1914 meeting of the American Electrochemical Society in which he described some experiments on electrolytic recovery of zinc from galvanizers' dross.¹ He describes the dross as having about 90 per cent zinc, 5 to 6 per cent iron, 1 to 3 per cent lead and sometimes up to 2 per cent tin. The usual market price of this product is 70 per cent of the price of commercial zinc, which leaves about 20 per cent of the price of commercial zinc as the margin. This at present means a margin of 1.75c. per pound.

Richards melted the alloy in iron pots and kept it at its melting point for a considerable length of time, skimming off the zinc that floated on top. In this manner 25 per cent of the alloy was recovered as salable spelter, leaving the remaining alloy more impure and with a higher melting point than the original. (In practice this is called sweating.) This alloy was cast into anode molds with 0.1 per cent aluminum to prevent liquation and swelling in the molds. The anodes were 1 to 1.5 in. thick and 18 x 48 in. in area. For cathodes he used rolled sheet zinc 0.25 in. thick, greased with a methyl alcohol solution of paraffin or with glycerine. The greasing was done to prevent adhesion of the deposited zinc, so that stripping would be possible. (Electrotypers' "finishing lead," moistened with lubricating oil is better.—Author). The electrolyte contained 15 per cent $ZnSO_4 \cdot 7H_2O$, 1.7 per cent acetic acid (commercial) and 0.8 per cent sodium acetate. At a current density of 9 amp. per sq. ft. the voltage drop per cell was 1.25 at 30-32° C. Under these conditions the plates remained smooth for three days. If trees around the edge were then knocked off electrolysis could be continued another three days. The ampere effi-

¹*Trans. Am. Electrochem. Soc.* 25:281 (1914).

ciency was nearly 100 per cent except when spongy plates were made. A 20 to 25 per cent loss was sustained during melting down until sal ammoniac flux was used, but the loss after it was used is not stated. The ingots averaged 99.95 per cent zinc. Ferrous sulphate accumulated in the electrolyte, slowly oxidized, and threw out hydrated ferric oxide which had to be filtered out. Air was injected into the tanks to cause circulation of the electrolyte past the cathodes.

Richards' conclusion was that electrolytic refining was practicable, but the cost was nearly equal to the economic margin. On that account the work was discontinued after two months of experimenting.

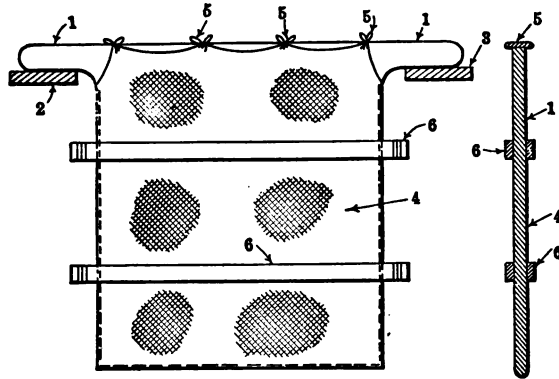

FIG. 37.

From about 1914 to 1918 a successful electrolytic zinc refining plant was operated near Baltimore, Maryland, by the Electrolytic Zinc Co., Inc., refining Prime Western zinc and selling High Grade electrolytic zinc, soldering flux, zinc oxide and lead-cadmium sludge. The following description of their operation is taken from the patents¹ by Aldrich, Bryan and Stuart, as well as from a thesis on this plant

¹United States Patent 1,299,414 of April 8, 1919 to CHAS. H. ALDRICH and JOHN K. BRYAN.

British Patent 108,311 of Jan. 10, 1918, to HEBER M. STUART and Electrolytic Zinc Co., Ltd.

written by B. H. Jacobson for an engineer's degree from Lehigh University.

Prime Western zinc was purchased on the market, melted and cast into anodes 24 in. wide and 30 in. immersion, with the necessary lugs to rest on the bus bars. An endeavor was made to pour plates 0.75 in. thick and weighing 160 lb. each. They were placed in the tanks 5 in. center to center, resting on the anode bus bar on one side and on insulating strips on top of the cathode bus on the other side of the tank. These anodes were encased in canvas bags which were drawn tightly by strings and wood strips, as shown in Fig. 37. The purpose of these bags was not to act as diaphragms, but to keep the anode slime in electrical contact with the anode. The slime consisted of zinc, cadmium, lead and iron and would dissolve in the slightly acid electrolyte as soon as it became detached from the anodes, so that cadmium and sometimes lead would appear in the cathodes. The zinc was corroded by the electrolysis over the areas exposed to the solution, except under the wood strips where very little corrosion went on. The anode slime tending to loosen and drop to the bottom of the canvas bags was thereby caught to each of the wood strips and held more firmly in place over the whole area of the anodes.

The cathodes were of $\frac{1}{16}$ -in. aluminum sheet edged with wood strips and larger by 1 in. than the anodes all the way round in order to prevent crowding the current onto the edges of the plates. There were thirteen cathodes and fourteen anodes per cell.

The electrolyte used was a zinc sulphate solution with 4 to 10 per cent of zinc, although 8 per cent zinc was found best. It contained 1 to 5 gm. free sulphuric acid per liter, more than this being undesirable on account of the higher rate of corrosion of the cathodes and less than this being bad on account of the formation of spongy zinc cathodes. This is about the same acidity found necessary by Hoepfner for zinc chloride solutions. The presence of traces of antimony, arsenic or tin in the electrolyte spoiled the deposit, antimony

being the chief offender. Iron in the solution was always in the ferrous condition, due to the strong reducing conditions, and in amounts under 1,000 mg. per liter did no harm. In fact, one of the patents claims that it was beneficial and helped produce a reguline deposit on the cathode and did not precipitate with the zinc. The electrolyte gradually increased in both zinc and iron content and a portion of it had to be removed periodically. Sulphuric acid had to be added continually to make up for that which reacted with the zinc cathodes.

The tanks were open wooden tanks lined with asphalt and 6 ft. 6 in. long by 3 ft. wide and 3 ft. 10 in. deep, provided with flat copper bus bars, one on each side of the cell. Each tank received 4 gal. electrolyte per minute through asphalt-lined wooden launders and overflowed into similar launders. Hard-lead pumps were used to move the solution. Violent agitation of the solution within the cell was undesirable, as it shook loose the anode slime and thus caused cadmium to appear in the cathodes. In copper refining it does not matter if the anode slime falls to the bottoms of the tanks, but in this plant it was impossible to get satisfactory cathodes unless the above rule was adhered to.

Cathodes were stripped every four days (sometimes more often) and anodes were replaced every fourteen days. The slime was found in a layer about 10 mm. deep on the anodes and contained 50 to 60 per cent zinc, 2 to 5 per cent iron, and the remainder was cadmium and lead in varying proportions, depending on the analysis of the original zinc. This slime was dissolved in either sulphuric or hydrochloric acid and the cadmium and lead precipitated with zinc dust. The zinc sulphate or zinc chloride solution was evaporated and sold. The precipitated cadmium and lead were sold in the dried powder form and were not converted into finished metals.

The writer has tested the above process, using zinc chloride as the electrolyte and finds that the same conditions apply as in the sulphate solution. The acidity must vary from

1 to 4 gm. HCl per liter, as in the decomposition of zinc chloride solutions. None of the lead is converted into lead sulphate in the anode slime. Otherwise, there is little difference in the process when using the two electrolytes.

The Baltimore plant was closed down and dismantled when the end of the war diminished the margin. The inference is that the cost of operation, plus losses, was larger than the normal margin between Prime Western and electrolytic zinc.

CHAPTER IX

MELTING ELECTROLYTIC ZINC

Zinc cathodes are rarely more than 1 or 2 mm. thick, and often it is necessary to make them thinner when sponginess starts or re-solution takes place in the tankroom. This causes a great deal of surface to be exposed to oxidation while drying and melting the cathodes and on that account it is very difficult to get a high yield when melting down electrolytic zinc.

If the cathodes are melted in bunches placed in any ordinary type of furnace without flux or cover, the recovery of ingot zinc will be from 96 per cent to as low as 40 per cent. Zinc has such a high affinity for oxygen that it is practically impossible to melt cathodes under these conditions. The proper method of melting is to form a pool of molten zinc which is brought to a temperature considerably above the melting point of zinc (420° C.) and then bunches of cathodes are plunged beneath the surface of the molten metal. In this way the cathodes are not in contact with air while they are being heated and the result will be a 94 to 96 per cent recovery of metal as ingot. About the only flux which has been used with any success is ammonium chloride. This makes the globules of melted zinc coalesce more easily and dissolves the film of zinc oxide which exists on the surfaces of the cathodes. Without a flux the metal in the bath seems spongy, does not pour well and has a consistence which reminds one of mayonnaise salad dressing. Zinc chloride can also be used as a flux, but it is not vaporized like ammonium chloride and consequently must be skimmed with the dross in order to be disposed of when the melt is finished. In a plant which electrolyzes zinc chloride solutions it is possible to use zinc chloride as a flux and to use it in quite large quantities, since the dross can be put back into solu-

tion and used over again. Sodium hydroxide (caustic soda) can also be used, as it is a solvent for zinc oxide, but like zinc chloride it must be skimmed. Sponge zinc can sometimes be melted under this flux when it cannot be melted under any others. It is difficult to melt under a "heel" of molten metal when a deep layer of flux is used, as the only successful zinc melting furnaces are reverberatories and the flux is interposed between the metal and the source of heat. This is especially bad when zinc chloride is used as a flux as it boils at 730° C. Zinc melts at 420° C. and hence does not require a very high heat.

Not all of the zinc which passes into the dross is oxidized during melting. A great deal of the oxidation goes on during the drying of the cathodes. Zinc dust will slowly decompose water at ordinary temperatures, displacing hydrogen and forming zinc hydroxide. With rising temperature the reaction becomes quite violent. On that account any water on the cathodes when they are plunged into the heel of molten zinc is likely to react on the molten zinc to form zinc oxide. During drying of the cathodes any spongy portions are almost completely altered to oxide and even smooth surfaces are dimmed by a film of oxide. The action is considerably faster and more serious than the rusting of sheet iron. If damp cathodes are to be plunged into molten zinc it is best to plunge them through a layer of molten zinc chloride or caustic soda as these reagents take up water. However, if the wet flux stands long in contact with the molten zinc, all the water reacts with the zinc ultimately.

Trees are also difficult to melt down into ingots. They fall off of the cathodes in the tanks and sometimes large accumulations of them must be melted. When they are melted it is absolutely essential to maintain a heel of molten metal. A cathode covered with 10 mm. trees with sponge around their bases, will oxidize 50 per cent on standing in the open air for six months.

Crucible furnaces are not very successful for the melting of zinc cathodes. The crucibles are usually too small to take

full-sized cathodes, not a very large heel of metal can be maintained, and too much handling is necessary. Large iron pots cannot be used for melting the zinc as the iron dissolves in the zinc sufficiently to make it unmarketable as high-grade spelter. It is therefore practically necessary to use a reverberatory furnace of some kind. Fire-brick or silica bottoms are best, although they must be rammed tight and so constructed that molten zinc cannot work its way under some of the bottom and float it. The heat then passes into the zinc from the upper surface.

Fuel-fired reverberatory furnaces, using either coal, oil or gas, are satisfactory. Of course the hot gases sweeping over the surface of the molten zinc tend to further oxidize it, but fairly satisfactory melting can be had in a very simple home-made furnace. It must be so designed that molten zinc can be tapped through a tap hole at the very point of the bottom in order to drain it. When starting up the furnace it is best to remelt some ingots in order to obtain a heel of zinc, rather than to make the first heel from cathodes. A fairly wide charging door either in the side or roof of the furnace is needed in order to charge in large bunches of cathodes.

At the Anaconda plant in Great Falls, an unsatisfactory attempt was made to melt cathodes in an electrically heated reverberatory furnace of the Baily type. It was supplied with 6,600-volt power and had two 500-kva. transformers with variable tap secondary windings allowing 231 to 445 volts to be applied to the granular carbon resistors in the furnace. The transformers were Scott connected so that two single-phase resistors were supplied. The resistors were in carborundum troughs running along the two sides of the furnace just above and parallel to the bath. The carborundum troughs were filled with granular carbon which acted as the heating element and the heat radiated directly to the bath or reflected from the roof.

When pouring, the zinc may be tapped into pouring ladles, or the ladles can be made with handles long enough to be

reached into the furnace through the door and dipped into the bath. The latter is by far the simpler method of hand-



FIG. 38.—Melting and casting electrolytic zinc (Great Falls)

ling. A photograph of the pouring floor of the Great Falls electrolytic zinc plant is given in Fig. 38. This shows the

long-handled pouring ladles supported on small trolleys overhead. A pipe railing just in front of the molds allows support for the ladles while they are being poured. One man pours while another skims the metal in the molds before it can solidify. The molds are hinged at one end and after the zinc has cooled the molds are dumped over so that the ingots fall out. Piles of 50-lb. slabs are visible in the photograph. A sketch of the design on the surface of one of these flat slabs of zinc is given in Fig. 39. Melting electrolytic zinc usually introduces a small amount of iron and silicon from the materials used in constructing the furnace and the pouring ladles. It will be noticed that the men pouring zinc wear goggles to protect their eyes from any chance splashes



FIG. 39.

of molten metal. Practically the same arrangement is used at Trail.

One of the most serious questions in electrolytic zinc work is the question of disposing of the dross formed during melting. It has usually been made while using a sal ammoniac flux (ammonium chloride) and therefore contains chlorides of zinc and ammonia. This flux cannot ordinarily be dissolved in sulphuric acid and put back into the system of the sulphate plant, although it can be dissolved in hydrochloric acid and put back into the system of a chloride electrolysis plant. Since sulphate plants predominate, the problem of disposing of the dross must be solved. It can be retorted

in the standard zinc distillation furnaces, but it is much more desirable to work it back into the leaching system if possible. Work is at present being carried on by practically every company producing zinc by electrolytic methods to find ways of getting rid of the chlorides in this dross or to otherwise treat the dross to recover its zinc content. At Great Falls the making of zinc oxide seems to offer the solution. This problem and that of disposing of the copper-cadmium sponge formed during purification of the solutions, are problems in the electrolytic extraction of zinc which have not yet received a great deal of attention. At Trail it is now the practice (May, 1920) to put the hot dross directly into a drossing furnace, whose rotation agglomerates the globules of molten zinc. The puddle of molten zinc forms in this way and the remaining dross is put in large shallow pans to be treated with sulphuric acid. This is strong acid in order that the heat of reaction on the dross will volatilize all chlorine as hydrochloric acid. This leaves a zinc sulphate which does not contain too much chlorine to allow its return to the circuit.

CHAPTER X

EXAMPLES OF PRACTICE

Many of the practical details have already been mentioned in previous chapters and therefore this chapter will contain only a catalogue of the more important details about each plant discussed.

Great Falls Plant.*—This plant was built during the latter part of 1915 and the first half of 1916. It started operation on Sept. 18, 1916. The first cost is said to have been in the neighborhood of \$3,000,000 and the daily production at first was 100 tons of zinc. Since that time this production has been increased to 150 tons daily. This means \$30,000 per ton zinc per day and compares with \$75,000 to \$100,000 per ton caustic for electrolytic caustic soda plants, the gross value of whose products is about the same as that of zinc.

The raw material treated is complex zinc-lead-copper-iron sulphide ore containing silver and gold. This material is obtained from the mines of the company (Anaconda Copper Mining Co.) at Butte, Montana, and elsewhere, as well as by purchase from other mines. This ore is treated in a concentrating mill at Anaconda, Montana, mainly by flotation, giving a concentrate of the following average analysis:

Zinc.....	30%
Lead.....	7%
Copper.....	4%
Iron.....	13%
Silver.....	15 oz. per ton

Part of the zinc concentrate is roasted at Anaconda, but most of it is shipped direct to the plant at Great Falls where a large roasting equipment is maintained. The roasters are of a modified Wedge-McDougal type called the Anaconda-

*A complete description of this plant is soon to be published by F. LAIST and J. O. ELTON.

Wedge. Each of these treat thirty to forty tons daily, the zinc ore being in the furnaces twenty to twenty-two hours. More or less zinc sulphate is formed during roasting and on decomposition in the cells this zinc sulphate becomes zinc and sulphuric acid. An endeavor is made to form enough zinc sulphate during the roasting so that no sulphuric acid will have to be added during the leaching of the ore with the dilute acid solution returned from the cells. This is easily done when ores containing marmatite are treated, but it is difficult with "yellow jack" ores.

Leaching takes place in Pachuca tanks, the operation being carried on in a complete counter-current system. (See Fig. 7a.) After the acid is nearly all used up on the ore, excess calcine is added to neutralize any remaining acidity and cause hydrolysis of the iron sulphate in the solution. The charge then passes from the Pachuca tanks through Dorr classifiers and thickeners where the solution is separated from the residue. This zinc sulphate solution then passes to Pachuca tanks where zinc dust is added to precipitate copper and cadmium and the solution is then passed to Dorr thickeners and settlers where most of the sludge metal is removed. Final clarification of the solution by the use of Shriver presses completes the purification. The pure zinc sulphate solution is then pumped to the tank house for electrolysis. In the tank house there are six cell circuits of 144 cells each arranged in cascades of six cells. The solution is divided between these cascades entering with 7 to 8 per cent zinc and leaving with 2 to 4 per cent zinc and 8 to 9 per cent sulphuric acid. The solution is supposed to pass in series through the cascade of six tanks, but some fresh solution is added to each tank. Each cell, as shown by Fig. 19, has twenty-seven cathodes 26 x 42 in. and twenty-eight anodes. The cathodes are of sheet aluminum and each weigh 17 lb. The anodes are of cast lead. The cell-bodies are of wood lined with sheet lead. The cathodes are stripped every forty-eight hours and are lifted from the tanks in gangs of nine by small overhead trolleys. The zinc is melted

in a reverberatory furnace and cast into 50 to 60-lb. slabs. A general view of the plant is given in the photograph of Fig. 39a which shows the leaching building and Fig. 40 which shows the tank house and melting room. In the electric sub-station are six 5,800 kva. rotary converters, each supplying one cell circuit with 10,000 amp. at 580 volts. This means a current density of 14.7 amp. per sq. ft. and the necessary voltage per cell is about 3.2 to 3.4, when contacts are working perfectly. The zinc recovered is 99.85 to 99.95 per cent pure and amounts to 70 to 80 per cent of the zinc present in the ore. The remaining zinc is partly recovered as zinc



FIG. 39a.—Great Falls leaching plant

oxide in the flues from the reverberatory furnaces where the residue from the electrolytic zinc plant is smelted. These fumes consist largely of zinc oxide and lead sulphate, with some silver, and are shipped to a lead smelter. The over-all recovery of zinc must therefore be about 90 per cent.

The above data has been derived from so many sources that it is difficult to give proper credit where it belongs. Many short notices in technical journals, a personal visit, and conferences with members of the company, have all contributed.



FIG. 40.—Great Falls tank house

TRAIL PLANT

Another large electrolytic plant is that of the Canadian Mining & Smelting Co. at Trail, British Columbia. This is at present the second largest electrolytic plant, though soon to be eclipsed by the plant of the Electrolytic Zinc Company of Australasia, Proprietary, Ltd., at Hobart, Tasmania.

The ore comes mainly from the Sullivan mine belonging to this company, and has the following average approximate analysis:

Lead.....	14%
Iron.....	25%
Insoluble.....	4%
Alumina.....	3%
Lime.....	2%
Magnesia.....	2%
Sulphur.....	27%
Zinc.....	16%
Cadmium.....	0.04%

It was formerly crushed in tube mills till 97 per cent would pass a 48-mesh screen and was then¹ roasted in Wedge roasters as at Great Falls. At the present time the ore is concentrated in two concentrating plants, one of them a flotation plant and the other a wet magnetic concentrating plant. Both yield a concentrate containing 27 to 30 per cent of zinc which is fed to the Wedge roasters. There are thirteen roasters, each capable of roasting up to forty tons of ore daily down to about 1.5 per cent sulphur. An effort is made to keep the roasting temperature below 600° C. The calcine is treated in the continuous leaching system described in an earlier chapter of this book. The ore and solution are so manipulated that fresh cell acid is used to complete extraction of partly leached ore and fresh ore is used to neutralize partly spent leaching solution. In this way no crushed lime rock is needed to neutralize and hydrolyze iron salts. The neutral solution, containing some finely divided ore, passes to a series of pachuca agitating tanks where it is treated with zinc dust and then filtered to

¹E. H. HAMILTON: *Trans. Am. Electrochem. Soc.* 32:317 (1917).

remove suspended particles of zinc, copper, cadmium and ore. Kelly filters are used for this step. The amount of zinc dust used varies with the purity of the spelter desired. When there is not a market for pure electrolytic zinc, only enough zinc dust is used to remove copper, the cadmium being allowed to remain in the solution and deposit with the zinc.

The purified solution is fed to each of a series of twenty-six units of thirty-two cells each. In each unit are four parallel cascades of eight tanks each, each receiving neutral solution at the head of the cascade, with a supplementary feed of solution to each tank. Each tank is 82 in. long by 27 in. wide and 42 in. deep, and contains seventeen sheet-lead anodes and sixteen sheet aluminum cathodes, the latter 24 x 30 in. in area, and about $\frac{1}{8}$ -in. thick and weighing 8 lb. each. Wood strips are placed on the edges of the cathodes to prevent the growth of trees on the edges and to prevent short circuits when the cathodes accidentally touch the anodes. The current density is about 24 amp. per sq. ft. of cathode surface and the average voltage per tank is about 3.9. Enough heat is generated in the cells to necessitate cooling of the electrolyte by cooling-water circulated through lead coils placed in the end of each cell.

The ingoing electrolyte contains about 60 gm. zinc per liter, 2 gm. manganese, 20 to 30 mg. iron and 5 mg. cobalt, while the effluent electrolyte contains 26 gm. zinc and 55 gm. sulphuric acid per liter and varies in temperature from 30 to 45° C. Part of the manganese and cobalt is deposited on the anodes forming either a dense adherent scale or a loose deposit which falls off and collects on the bottom of the cell, while a small amount floats off with the solution, giving it a tinge of color.

The current is generated by motor generator sets consisting of one large motor and two generators to each set. Each generator is capable of about 4,000 amp. at from 50 to 125 volts, the latter figure being generally used. This is enough to supply four rows of eight cells each or thirty-two cells in

all, connected in series. There are twenty-six generators, each serving thirty-two cells. The cells are spaced on the floor of the cell house in double rows of eight each, leaving a passageway between each two rows of cells for access of workmen. Fig. 41 is a view of a portion of a tank room



FIG. 41.

showing the shape of the cathodes and the method of stripping.

The zinc is stripped every forty-eight hours, stacked in piles on trucks and transported to the melting room where three melting furnaces reduce it to commercial bars. Each

furnace is a silica-lined one fired by oil. The cathodes are dropped into the bath through a hole in the roof and an effort is made to plunge them beneath the surface of the molten metal in order to prevent undue oxidation. This is difficult to do as the blanket of dross floating on the molten zinc becomes quite thick and tends to prevent the cathodes being completely submerged. About 5 per cent of the metal is lost by drossing and must be returned to the leaching plant in the form of zinc oxide. The production is about fifty to sixty tons daily and will probably be augmented to seventy-five tons in the near future.

Sulphuric acid is made at the plant in a small chamber-acid unit by burning pyrites. This acid is used for redissolving the dross from the melting furnaces. Due to the fact that ammonium chloride is used as a flux on the melting furnaces this dross is full of chlorides. Consequently it must be treated with strong sulphuric acid and the material fed in fast enough to generate plenty of heat due to the reaction. This heat drives off most of the chlorides as hydrochloric acid gas. The only sulphuric acid at present entering the zinc plant is that used in redissolving the dross.

The Judge Plant.—A very good description of the Judge plant has been written by Lloyd W. Chapman¹ which is hereby reproduced in full:

The electrolytic zinc plant of the Judge Mining & Smelting Co., at Park City, Utah, is designed to treat concentrates obtained from a sulphide ore containing zinc, lead and silver. In their concentrator a lead concentrate and a zinc concentrate are obtained. The lead concentrate is shipped and smelted. The zinc concentrate is treated in the plant for the recovery of zinc and the zinc-plant residue is shipped and smelted for the recovery of the silver and lead. This briefly is an outline of the treatment of the ore. The removal in the mill of a large portion of the zinc from the ores produces a concentrate which can be economically smelted for the recovery of the lead and the silver. Previous to the construction of the electrolytic plant a zinc concentrate had been obtained, which was sold to smelters.

Treatment of the Concentrate.—The concentrate treated in the zinc plant contains about 38 per cent Zn, 3 to 5 per cent Pb, and 9 to 10 oz. Ag

¹L. W. CHAPMAN: Electrolytic Zinc Plant of the Judge Mining & Smelting Co. *Chemical and Metallurgical Engineering* 22:537-540 (March 24, 1920).

per ton, with small amounts of copper, cadmium, antimony, manganese and arsenic. Concentrates will average about 30 per cent sulphur and 8 per cent iron. Two grades of concentrates are delivered to the zinc plant—a table product and a jig product. These are kept separate, as the jig concentrate is too coarse to give satisfactory recovery of zinc without grinding. The jig product is dried in a cylindrical drier and ground in a Hardinge ball mill to pass sixty mesh, this size being obtained without screening the product with the return of oversize to the mill. The table concentrate is somewhat coarser than the Hardinge mill product, about 20 per cent being retained on a 60-mesh screen. Fig. 46 is a flow sheet of this plant.

Concentrates are roasted in a 25-ft. seven-hearth Wedge roaster which is fired on the sixth hearth by two coal-fired combustion chambers located at opposite ends of a diameter of the roaster. The seventh hearth is used to cool the calcine somewhat before being delivered to a Baker cooler. The roasting operation produces a calcine containing a relatively small amount of insoluble zinc ferrate, most of the insoluble zinc being present as sulphide. Details of the roasting operation, together with data obtained from experiments with this roaster have been published by C. A. Hansen.¹

Method of Feeding.—The product from the Hardinge mill is elevated by a bucket elevator and fed directly onto the top or drying hearth of the Wedge roaster by means of a belt conveyor. The table concentrates are also elevated by a bucket elevator, but are transferred to a feed hopper by a belt conveyor. Below the discharge spout of the feed hopper, at a distance of approximately six inches, is a horizontal iron plate which prevents the flow of material from the hopper. Adjustable scrapers are bolted to each of the four rake arms of the drying hearth, and these scrape a definite amount of concentrates from the plate onto the hearth. This method of feeding is simple in detail and, although the amount of feed varies somewhat with the moisture content of the concentrate for a given set of scrapers, has operated satisfactorily.

Leaching Operation.—Hot calcine flows by gravity from the roaster to a 5 x 12 ft. Baker cooler and from the cooler is transferred by a belt conveyor to a 400-ton storage bin. From this storage bin the calcine is elevated by a hoist to feed bins located above pachuca tanks. There are two of these tanks, 14 ft. in diameter and 30 ft. in height, made of 3-in. redwood, each holding about one hundred tons of solution. In conducting the leaching operation, the pachucas are filled by gravity with acid electrolyte from storage tanks, together with sufficient sulphuric acid to make up for the loss sustained in neutralization and subsequent operations.

¹"Electrolytic Zinc," by C. A. HANSEN. *Trans., A. I. M. E.*, 1919, pp. 1,247-1,281.

The quantity of acid in the tank is determined from the analysis of the solution and an amount of calcine added which is calculated to reduce the acidity of the solution to about 3 g. H_2SO_4 per liter. In addition to zinc, small amounts of copper, cadmium and antimony are dissolved, and these must be removed before the solution is electrolyzed. As the first step in the purification process iron sulphate is added in the pachucas sufficient to bring the iron contents to about 0.3 g. per liter. Pulverized lime rock is then added, with further agitation, and the remaining acid completely neutralized. This effects a complete precipitation of the iron and a practically complete precipitation of the antimony and arsenic. The leaching cycle requires from eight to ten hours.

Separation of the Sand and Slime.—A centrifugal sand pump delivers the neutral pulp from the pachucas to a No. 7 drag classifier. The sand from the classifier is delivered to a storage bin, the overflow to a 30-ft. Dorr thickener. The overflow of the Dorr is clear solution and is pumped to the purifying pachucas, the spigot product from the Dorr is filtered and washed on an $11\frac{1}{2}$ x 6 ft. Oliver filter. Oliver cake is delivered to a storage bin and the filtrate pumped to the purifying pachuca containing the overflow from the Dorr.

The sand from the classifier and the filter cake contain the silver and lead from the concentrate together with the insoluble zinc and the soluble zinc which has not been removed by washing. This residue is shipped to smelters for the recovery of the silver and lead, as previously mentioned. The sand and slimes together are about half the bulk of the original concentrates. The slimes will carry 10 to 12 per cent zinc and the sand 15 to 20 per cent zinc, and together will assay about 12 per cent lead and 20 oz. silver per ton. It is not possible to wash the Oliver cake or the sands free from zinc sulphate, and a loss of both zinc and sulphuric acid results. This makes it necessary to add about seventy pounds of 50 deg. acid to the pachucas for each ton of zinc produced.

Purification of the Solution.—Purification of the solution is carried out in pachucas by agitation with zinc dust. There are three of these tanks, 10 ft. in diameter x 20 ft. in height, made of 2-in. redwood, each having a capacity of about fifteen tons of solution. The pachucas are filled with solution and the zinc dust is added in small batches. The quantity of zinc dust needed, the rate of addition and the time required for this operation are determined by the amount of impurities present in solution, but the operation is usually complete in from twenty to thirty minutes. In this operation all but minute traces of copper and cadmium and also any traces of antimony and arsenic that may have escaped precipitation simultaneously with the iron in the agitation tanks are removed.

Purified solution is filtered in either one of two Sweetland presses and the zinc-copper-cadmium sludge removed. These presses have thirty-six

leaves, each $3\frac{1}{2}$ ft. in diameter. Sweetland filter cake is stored, but a method for the recovery of the metals from the cake which contains 40 to 50 per cent Zn, 4 to 7 per cent Cu and 3 to 6 per cent Cd has recently been developed. The filtrate from the Sweetland presses is pumped to either of two 200-ton solution storage tanks, from which it is run directly to the electrolytic cells as required. The average analysis of the purified solution is as follows, in grams per liter: Zn, 60; Cd, 0.004; Cu, 0.003; Mn, 0.4; Sb, 0.001; As, trace.

Electrolytic Cell Room.—The electrolytic cell room contains 120 tanks. The tanks are arranged in cascade. Five tanks, which constitute a cascade, are placed end to end, the difference in elevation between tanks being three inches. Two cascades of tanks are placed side by side, forming a bank of ten tanks. There are six of these banks across the cell room with aisles between and between the outside banks and the walls of the cell room. There are two of these sections of sixty tanks down the cell room with a wide aisle between the two sections and below the lower section providing ample room for stripping of cathodes.

Solution from the storage tanks is run into the head tank of each cascade, the flow being parallel throughout a section, each of which is provided with separate solution supply lines. Each section of sixty tanks also forms one electric circuit, the individual tanks of the section being connected in series.

Design of the Tanks.—The tanks are of standard design and are made from 2-in. redwood, and are 7 ft. long, 3 ft. wide and $4\frac{1}{2}$ ft. deep. The overflow chute is made of chemical sheet-lead and is supported on a wooden bracket. The solution level in the tank is two inches below the top of the side walls. The chute clears the top of the next tank in the cascade by one inch and delivers the solution about two inches beyond the inner edge of this tank. Each tank is provided with a cooling coil installed in an upright position at the inlet end. The coil is made from forty-five feet of 1-in. chemical lead pipe, there being five 4-ft. loops to a coil. The solution is delivered to the head tank of the cascade from the storage tanks through iron pipes and the amount of flow controlled by gate valves. Provision is also made to run fresh solution to each tank if desired. The acid electrolyte from the lowest tank in the cascade flows into a lead pipe and thence by gravity to either of two 200-ton storage tanks located outside the building. From these tanks the solution is pumped by a centrifugal pump, with a closed bronze runner, to the supply tanks located above the agitating pachucas and runs from these supply tanks to the pachucas by gravity, thus completing the cycle.

Anode and cathode busbars are both put on the side of the tank next to the aisle and are supported free from the tank by three 6 x 6 in. wooden posts carried down to separate concrete piers. Advantage is taken of the

fact that the amount of current carried by the busbars decreases with each anode contact and increases with each cathode contact to effect a considerable saving of copper; the busbars are therefore tapered from $\frac{1}{2}$ in. at the free end to 4 in. at the other, where connections are made to

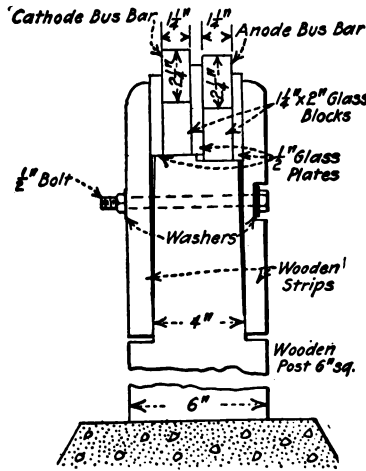

FIG. 42.

the bus of the next tank. The maximum cross-section of the busbars is $1\frac{1}{4} \times 4$ in. They are made from rolled copper and supported with the long dimension of the cross-section vertical, the anode bus being on the inside next to the tank and $\frac{1}{4}$ in. lower than the cathode bus. The busbars are insulated from each other and from the guides of the wooden support by means of glass insulators $\frac{1}{2}$ in. in thickness. The weight of the bus is carried upon glass blocks $1\frac{1}{4}$ in. in thickness, as shown in Fig. 42.

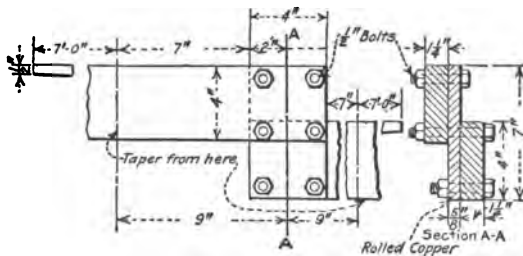

FIG. 43.

The connection between busbars is made by means of a plate of rolled copper $\frac{5}{8} \times 4$ in. in cross-section (see Fig. 43). This plate is bolted to the

inside of the cathode bus and to the outside of the anode bus. The difference in elevation of the tanks of 3 in. makes it possible to have the top bolt holes of the lower or anode bus register with the bottom bolt holes of the top or cathode bus, the two bars and the connecting strip being bolted together with two $\frac{1}{2}$ -in. bolts. Two bolts secure the connecting strip to the cathode bus at the top of this strip and two bolts secure the connecting strip to the anode bus at the bottom.

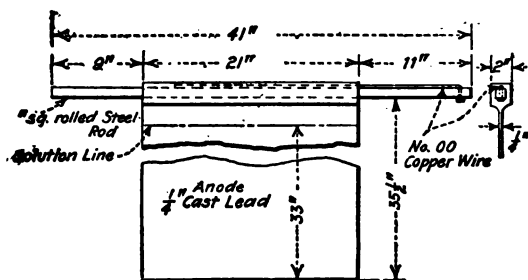

FIG. 44.

The Anodes.—Anodes are made of chemical sheet lead $\frac{1}{4}$ -in. thick, the area immersed being 21 in. wide x 33 in. deep. The anodes hang vertically in the tank, and are supported by 1-in. square rolled steel rods and weigh about one hundred pounds complete. (See Fig. 44). The supporting rod is 41 in. long and extends 9 in. beyond the edge of the anode on one side, being supported by a wood strip resting on the top of the inner wall of the tank and 11 in. on the other in order to clear the top of the outer wall of the tank and rest on the anode bus. The anode was originally supported by being cast around the rod. Electrical contact was provided by sweating the lead to the rod. This method has not proved satisfactory in operation, due to the fact that zinc sulphate will creep in between the lead and the rod, causing a poor contact. This resulted in a very decided increase in electrical resistance which caused heating and further disintegration. The defect has been overcome by burning into the lead above the steel rod a length of tinned No. 00 copper wire. A hole is drilled through the iron bar where contact is made with the anode bus and the copper wire passed through this hole and riveted on the under side. This provides a copper circuit from the anode bus to the lead plate.

The Cathodes.—Cathodes are made of best rolled sheet aluminum, $\frac{1}{8}$ in. in thickness. The immersed area is 22 in. wide x 34 in. deep. (See Fig. 45.) The cathode rod is made from two strips of rolled copper, $\frac{1}{8}$ in. thick x $1\frac{1}{2}$ in. wide x 44 in. long. These are riveted together with the aluminum sheet between. The rod extends 9 in. beyond the aluminum

sheet on one side, being supported on the same wood strip on which the anode rod rests, and 13 in. on the other so as to clear the top of the outer wall of the tank and the anode bus and rest on the cathode bus. An iron lug is riveted between the copper strips at each edge of the aluminum sheet, forming a hook by which the cathodes are removed from the tank for stripping. The remaining space between the copper strips at each end is filled with an iron strip and the three strips are riveted together.

In each tank are nineteen anodes and eighteen cathodes which are spaced 2 in. center to center. The immersed cathode area is 203.5 sq. ft. and the effective immersed anode area is 173.25 sq. ft. per tank. With a current of 5,000 amp. the density per sq. ft. of cathode area is therefore 24.5 amp. This current density was chosen as the most economical under operating conditions. The higher the current density the greater the cathode production per kw.-hr., since the resistance of the solution is practically constant for all densities. Too high a current density will, however, produce a poor cathode deposit with a resulting decrease in the current efficiency due to re-solution of the deposited zinc by the acid in the

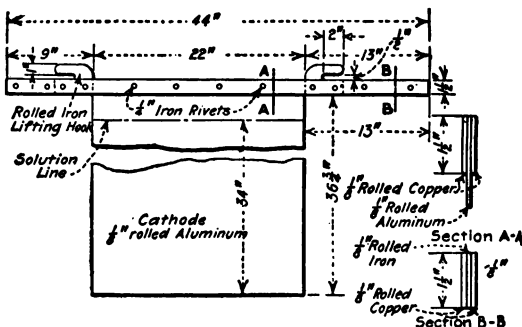

FIG. 45.

electrolyte. The amount of zinc redissolved is increased by rough and non-coherent deposits. The rate of flow of solution through the tanks is such that the acidity of the electrolyte leaving the last tank in the cascade is about 60 g. per liter. This acidity was also chosen as the most economical under operating conditions. The higher the acidity of the solution the greater the amount of deposited zinc dissolved, with the result that there is a decrease in the current efficiency. There are other factors, of course, to be taken into consideration in determining the most economical current density to use in relation to the amount of free acid and zinc sulphate in the effluent solution; such as the cost of cooling the solutions, the cost of power, the market price of zinc, the problem being complicated because these factors are interdependent. The voltage drop per cell will

vary from about 3.7 volts in the head cell to 3.3 volts in the last cell in the cascade, the average being about 3.5 volts.

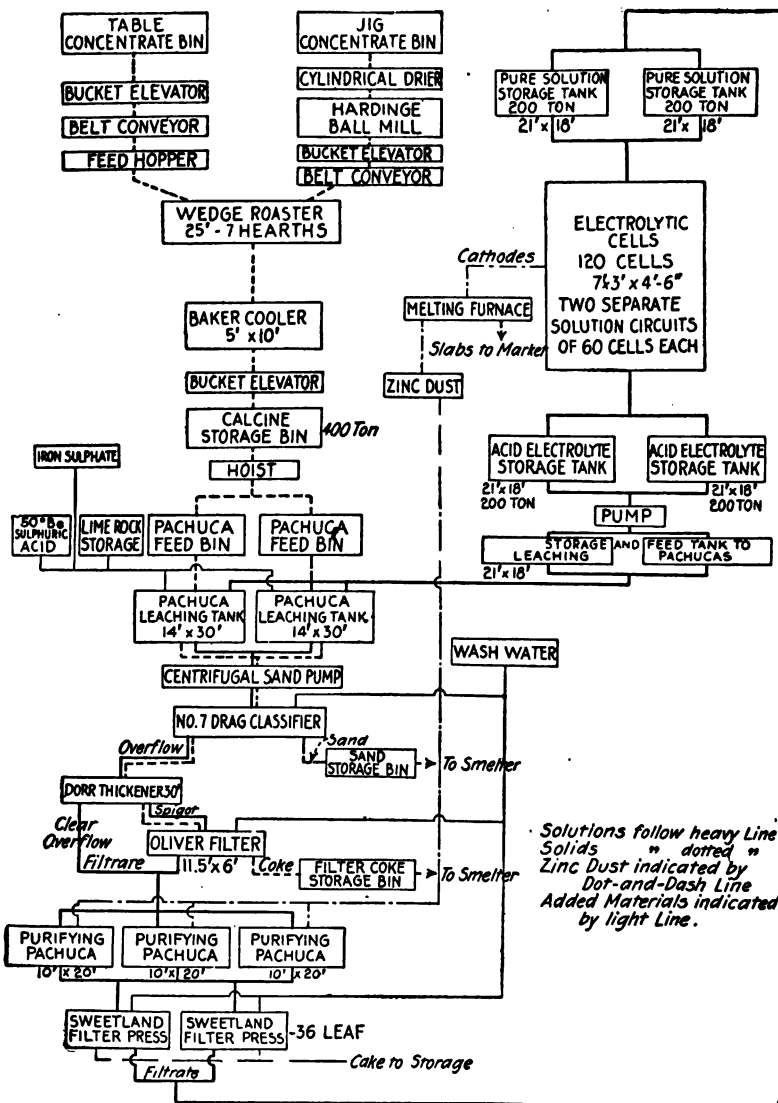

Fig. 46.

The effect of the electrolysis upon the solution is shown in Table I. It is to be noted that about 20 g. per liter of Zn remains in solution, this amount being carried through the cycle.

TABLE I. EFFECT OF ELECTROLYSIS

	Grams per Liter					
	Zn	H ₂ SO ₄	Cd	Cu	Sb	Mn
Feed to head cell.....	59.5	0.2	0.003	0.0006	0.0010	0.415
Overflow from tail cell...	21.7	58.1	Trace	0.0003	0.0007	0.035

Manganese is deposited at the anodes as dioxide. The deposit is, however, non-coherent and all but a thin film which adheres to the anode settles to the bottom of the tanks. The tanks are cleaned of this mud about once a month; at present no use is made of this product. The solution flows directly through the tanks. It is not necessary to admit the solution near the bottom at one end of the tank with the overflow from the top at the other, or vice versa, since evolution of gas from the anode suffices to prevent stratification of the solution.

The cathodes are removed from the tanks and stripped of the deposited zinc every forty-eight hours, the average weight deposited per tank being about 515 lb. The smooth crystalline deposit on the cathode sheets is about 1/8 in. in thickness. The cathodes are lifted from the tanks by means of a lifting frame attached to a 1-ton chain fall which runs on an overhead trolley. The lifting frame has two side pieces made from 1 1/2-in. angle iron and cross-braced, the toes of the angle iron being horizontal and directed inward. V-shaped notches are cut in the toe, spaced 4 in. center to center; when the frame is lowered these notches permit the toe of the angle iron to be slipped endwise under the lugs on the cathodes. The lifting frame removes six cathodes at one time. The cathodes are conveyed by the trolley to the aisle at the end of the section and deposited in a portable stripping frame, where the wooden side strips are removed and the deposited zinc is stripped from the aluminum sheet. The cathodes are thoroughly cleaned, dry wooden side strips are put on each edge and are then replaced in the tank. These side strips are made from a 3/4-in. square strip of wood, 36 in. long, with an 1/8-in. slot 1/4-in. deep cut along one side. The wooden strips extend the full length of the cathode sheet and slip tightly over the aluminum sheet and are thus held in place. Side strips are necessary for the convenient removal of the deposit, and also prevent the formation of irregular deposits at the edge of the sheets.

Cathodes are then melted in a coal-fired reverberatory melting furnace and cast into standard sized slabs for the market. The average analysis of the refined zinc is Zn, 99.930; Fe, 0.005; Pb, 0.038, and Cd, 0.027 per cent.

Power.—The power for operating the plant is purchased from the Utah Light & Power Co. and is delivered to an outdoor transformer station at 40,000 volts, there being three independent sources of supply. The voltage is transformed to 2,300 volts for the synchronous motors and to 440 volts for miscellaneous power uses about the plant, such as operating the air compressors which supply air to the pachucas, operating the sand and solution pumps and calcine elevators.

Direct current is generated for the tank room by two motor generator sets driven by synchronous motors, the generators being rated at 5,000 amp. at 215 volts. The switchboard installation is arranged so that either generator can be used to supply current to either section of sixty tanks. Provision is made for forced ventilation of the motor generator room by washed air.

Production.—The plant was one of the first electrolytic zinc plants to be put into operation and was designed to produce fifteen tons of zinc per day, but under operating conditions that have developed the plant will require enlargement in some departments to attain this tonnage. The Wedge roaster will supply sufficient calcine for not more than nine tons of zinc and additional agitating pachucas will also be needed in order to obtain the rated capacity. It is interesting to note that the original cells in this plant were designed to use the rotating cathodes that were developed at Bully Hill, but that with the development of the process, particularly in the purification of the solution for electrolysis, it was found to be advantageous to install new tanks and to use stationary cathodes.

Acknowledgments.—Thanks are due to G. W. Lambourne, of the Judge Mining & Smelting Co., for permission to publish these notes, and to John T. Ellsworth for courteously assisting in the collection of the material at Park City.

Ducktown Plant.—During the war a very interesting test plant was built and operated by the Ducktown Sulphur, Copper & Iron Co., of Isabella, Tennessee. This company is engaged in the mining of a cupriferous pyrite which is burned in roasters and the sulphur dioxide used in the manufacture of sulphuric acid. The pyrite cinder has been smelted for its copper content for years. In fact, the original plant had been a copper smelter which was forced by sur-

rounding agricultural interests to utilize the sulphur fumes from the smelter in the manufacture of sulphuric acid. This latter product soon became the primary product of the plant, due to the demands for fertilizer made from the acid.

More zinc than copper is found in the pyrite, but it has been wasted for years in the slag and flue-dust of the smelter. The fume coming from the blast furnaces is said to contain over 40 per cent zinc. Most of this fume passes into sulphuric acid chambers where it is converted into zinc sulphate which collects in the sludge with the lead sulphate usually found in the bottom of sulphuric acid chambers. It was proposed that the zinc sulphate in this sludge should be recovered by leaching and electrolysis.

The sludge averaged over 50 per cent zinc sulphate, 15 per cent lead sulphate, 14 per cent sulphuric acid, 16 per cent water and small amounts of copper, cadmium and iron sulphates, together with some silica dust, carbon, etc. It was found quite easy to leach out the zinc sulphate with water, obtaining an acid solution of zinc sulphate. The acidity of the zinc sulphate solution was neutralized with finely ground marble, which also served to throw out the iron which was in solution.

Copper and cadmium were thrown out by the use of scrap zinc in two small pachuca tanks operating in series. The solution was immediately filtered to remove any suspended sponge metal and was then ready for electrolysis. It was found that a solution with 70 gm. zinc per liter (about 7 per cent zinc) and 3 per cent sulphuric acid was best adapted to the needs of the plant.

The cell-room contained thirty lead-lined wooden tanks with ten cathodes and eleven anodes per cell. Aluminum cathodes and lead anodes were used as in standard sulphate practice, but they were suspended from aluminum bars in place of copper bars. The bus bars on the sides of the cells were also of aluminum. The voltage per tank at 17 amp. per sq. ft. was 3.83 volts, of which 0.4 was due to the resistance of the aluminum contact on the aluminum busbar.

The circulation¹ was about one hundred gallons per hour, each tank receiving a separate feed from a distributing tank and discharging to an air-lift which returned the solution to the distributing tank. Part of the solution from the cells was diverted to the leaching plant and replaced by fresh, neutral liquor from that plant. It was possible to get 72-hour plates with very few defects. The power consumption per pound of zinc was about 2.5 to 2.8 kw. hr. It was determined that one man could strip 240 cathodes, each containing 20 lb. of zinc, in ten hours.

This small plant is not now in operation. The writer has been unable to learn whether a large plant will be built although it would seem that there is everything to favor such action except the cost of electric power.

Keokuk Plant.—At the Keokuk, Iowa, hydraulic power plant, which uses water from the Mississippi River, one of the large lead companies built an experimental plant for making 10-tons electrolytic zinc daily, during the war. The raw material was zinc oxide fume made in an igneous concentration plant located at Florence, Colorado, together with similar fume from other plants, and a small amount of roasted ore from the Joplin district. The fume was made from complex zinc sulphide ores, mainly from the Leadville district, by roasting and then mixing with fuel and blowing in a blast furnace provided with dust flues and a bag-house. An effort was made to blow as much zinc and lead into the fume as possible, catching it in the bag-house. Of course, the volatile impurities were concentrated into the fume along with the zinc and made necessary special treatment of the solutions in the leaching plant at Keokuk. Tanks with aluminum cathodes and lead anodes were used as in other standard sulphate practice and a current density of 25 amp. per sq. ft. This made it necessary to cool the electrolyte in the cells in order to keep down corrosion, the cooling taking place by means of lead coils fed with river water and placed

¹H. E. BROUGHTON: *Electrolytic Deposition of Zinc*. Chem. and Met. Eng. 20-155 (1919).

at the inlet to each tank. The site of the plant was chosen too far from the river to allow a convenient supply of cooling water, especially if a large plant was to be built. It was found that electrolytic zinc could be produced with profit if the size of the plant were fifty to one hundred tons daily, but that a 10-ton plant was too small. This plant is therefore to be dismantled and sold, since the financiers behind it are not interested in so large an installation at the present time.

The Kennett Plant.—The United States Smelting Co. built a small plant at Kennett, California, to treat an arsenical zinc oxide fume made in a copper smelter operated at Kennett by that company. This was also operated during the war, but was closed down to be dismantled when the armistice put an end to the demand for high-grade zinc. This fume comes from a zinciferous copper pyrite ore in which the zinc has always been a curse, rather than a blessing, and where the zinc is counted as being worth nothing. An analysis of the fume is as follows:

Zinc.....	27.3%
Iron.....	25.3%
Copper.....	11.0%
Cadmium.....	0.93%
Arsenic.....	9.0%
Lead.....	10.0%
Sulphur.....	7.6%
Se and Te.....	1.23%
Bismuth.....	0.40%

The high analysis of arsenic is especially worthy of note as well as the amounts of selenium, tellurium and bismuth. These impurities made necessary a special purification system to remove the arsenic. A strong sulphuric acid was mixed with the flue-dust and the mixture fed into the roasting furnace. This fumed off most of the arsenic, selenium and tellurium. After taking the calcine into solution it was necessary to treat it with hydrogen sulphide gas to remove the remaining arsenic and bismuth from the solution. The

hydrogen sulphide was generated from copper matte and sulphuric acid.

The cells used contained the regular sheet aluminum cathodes, but in place of sheet lead anodes, lead pipe anodes were used. These were connected to a common header at the top of the tank and served to supply compressed air to the bottom of the tank for purposes of agitating the solution during electrolysis. This allowed further depletion of the solution in zinc than would normally be possible. If desired, the remaining solution, containing only a small amount of zinc sulphate, and quite a little sulphuric acid, could then be evaporated for obtaining strong sulphuric acid to use in roasting the flue-dust. These innovations are due to H. R. Hanley, the designer and operator of the plant.

Hobart Plant.—The Electrolytic Zinc Co. of Australasia, Proprietary, Ltd., also built a 10-ton test plant during the war at Hobart, Tasmania, to treat zinc sulphide ore from the Broken Hill mines in Australia. This plant was quite successful in developing its process and operated at the rate of fifteen tons daily before it was closed down to be enlarged to a 100-ton plant, next in size to the Great Falls plant. Very little information is as yet available about the details of this plant except that it follows standard practice of lead anodes and aluminum cathodes and pure solutions made by methods already described. Fortunately, the patent literature describes quite well the methods developed there for removing cobalt, an element which entered the solution from the Broken Hill ore and which had not been encountered in any previous work. Glue is added to the electrolyte in increasing proportions as the cobalt increases, restraining the effects of the cobalt on the cathodes until 200 or 250 mg. of cobalt have accumulated. It is then removed by any one of the methods described under the chapter on purifying sulphate solutions.

Their roasting practice has also been described in an earlier chapter. The ore is roasted without much care until it reaches 6 per cent sulphur, from which point it is carefully

adjusted to convert the remaining zinc sulphide to zinc sulphate, since it was found that the amount of available zinc oxide and iron oxide are then enough to cause the transformation of 60 to 70 per cent of the remaining sulphur into sulphate of zinc. This leaves enough zinc sulphate in the ore to make unnecessary the addition of sulphuric acid to the cell acid.

In place of using wood strips on the edges of the aluminum cathodes a groove is cut into the edge of the aluminum plate and when stripping the zinc a sharp-edged tool can be run down this groove to loosen the edge of the zinc deposit. Aluminum plates $\frac{3}{16}$ -in. thick are used in order to allow room for these grooves and to make cathodes which will have a long life. A current density of 25 amp. per sq. ft. is used, and this necessitates artificial cooling of the solution in the cell by coils placed at the inlet similar to the practice at Keokuk.

CHAPTER XI

ZINC CHEMICALS

Hydrometallurgic methods are used for preparing a number of zinc compounds from ores. Some of these are sold as zinc chemicals and some of them as concentrated ores. As an instance, zinc oxide prepared by hydrometallurgic methods may be sold for any of the uses to which zinc oxide is suited, or it may be sold as a concentrated ore, especially if it is slightly impure. Beside the various forms of zinc oxide, zinc sulphate and zinc chloride are prepared and sold in large quantities.

Ammoniacal Leaching.—Zinc oxide can be dissolved in ammonia and many ammoniacal solutions like ammoniacal ammonium chloride solution, ammonium carbonate or ammonium sulphite solution, and can be reprecipitated by various methods. The end product is almost invariably zinc oxide. Supposedly, the soluble compound of zinc formed under these conditions is ammonium zincate, $(\text{NH}_4)_2\text{ZnO}_2$, which is soluble in water and can be broken up by boiling off the ammonia, leaving zinc oxide. Almost since the idea of leaching zinc from its ores originated in the dim and dark past there have been various proposed methods of removing zinc from its ores by ammoniacal solutions. A review of them is hardly worth while since none of them ever met with commercial success, and few even attracted enough attention to receive commercial test, and besides, the list of these proposals is very long.

Alkaline Leaching Agents.—A similar condition is found among the alkaline leaching agents, especially caustic soda solutions. It is stated that coherent deposits of zinc can be obtained under right conditions from sodium zincate, Na_2ZnO_2 , solutions, but the writer has never seen such deposits.

Electrolytic Zinc Dust.—The writer's whole experience with caustic soda solutions of zinc oxide made from ores is that nothing but sponge zinc¹ is deposited. The physical properties of this sponge metal are markedly different from those of sponge made in zinc sulphate solution or zinc chloride solutions. It can be dried with safety in the open air with only slight oxidation, whereas sponge made from other solutions will often take fire spontaneously in the open air, due to its rapid oxidation and the consequent evolution of heat. For precipitating silver from its cyanide solution, this dust is about 70 per cent efficient, meaning that 30 per cent of the zinc has either oxidized or becomes coated over with silver so that it cannot precipitate silver any further. The ordinary zinc dusts on the market for this purpose are often nearly all metallic zinc, but they contain large pieces of zinc which coat over with silver in such a way that they are only 35 to 50 per cent efficient. In spite of this, electrolytic zinc dust has not yet found favor among "cyanide men."

Bisulphite Leaching.—Like the alkaline processes, this method of leaching has been tested and patented for thirty or forty years. It has received semi-commercial tests both in England and in Australia, and has failed, due to mechanical difficulties. The chemistry is somewhat as follows: Zinc oxide in an ore, when treated with a solution of sulphurous acid first forms an insoluble mono-sulphite of zinc, $ZnSO_3$. On further treatment with sulphurous acid or sulphur dioxide gas in the presence of excess water, zinc bisulphite, $ZnH_2(SO_3)_2$, is formed and this compound is quite soluble in water. This solution can be filtered away from the insoluble residue of the ore and on heating the solution gives off sulphur dioxide, so that the insoluble mono-sulphite of zinc precipitates. On filtering this away from the remaining solution and drying, it can be further heated to give zinc oxide and sulphur dioxide. Theoretically none

¹H. J. MORGAN and O. C. RALSTON: Electrolytic Zinc Dust. *Trans. Am. Electrochem. Soc.*, 30-231 (1916).

of the sulphur dioxide is used up and it should be capable of reuse indefinitely. Actually, a considerable loss of sulphur dioxide is sustained by its combining with other elements in the ore and due to the fact that zinc sulphites oxidize to zinc sulphate, which can be decomposed thermally only at $1,000^{\circ}$ C. Further, the zinc oxide made by this method always contains impurities which discolor it and hence render it unfit for any use except as an ore. The result is that the bisulphite processes are regarded as impractical.

Chemical Precipitation of Chloride and Sulphate Solutions.—Numberless proposals have been made for chemical precipitation of zinc compounds from the sulphate or chloride solutions, in order to avoid the necessity of electrolytic recovery of the zinc. However, most of them involve the loss of the sulphate or the chloride radical that is combined with the zinc and usually prove uneconomical. Such reagents as ammonia undoubtedly throw out the zinc as hydroxide, which can be calcined to oxide, but ammonium sulphate or ammonium chloride are less valuable forms of ammonia than the hydroxide, unless the latter is an ammonia from a gas-house or coke oven works. Where crude ammonia from the carbonization of coal is available it might be possible to use it on zinc sulphate or zinc chloride solutions, but the resulting zinc hydroxide would be contaminated with tar. It is possible that where the zinc already exists as a soluble salt, as it does in the sludge from the Ducktown sulphuric acid plant, chemical precipitation of the zinc from these solutions would give a marketable product without having to go to the expense of an electrolytic installation.

Lithopone and Zinc Pigments.—Zinc sulphide in various forms is the basis of a number of white pigments which are used extensively in place of white lead for paint mixing. The most important pigment prepared by wet methods is lithopone, a mixture of precipitated barium sulphate and zinc sulphide. There is quite a large tonnage of lithopone made in the eastern and central states at places where zinc sulphate can be made cheaply.

Without attempting to give the technique of lithopone making, it is sufficient to say that zinc sulphate solution is made by any method which happens to be adapted to the materials available, and a solution of this is mixed with a solution of barium sulphide made by reducing barium sulphate (barite), with coal in a reverberatory furnace and leaching out the barium sulphide with water. The reaction is as follows:

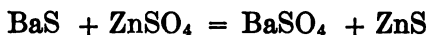

Both the products of the reaction are insoluble white solids which are of great value as pigments, the barium sulphate for its white color and the zinc sulphide for its covering power. The conditions of precipitation, like concentration of solutions and temperature, affect the size of particles and appearance of the precipitate and there are certain trade secrets involved in preparing the best grades of lithopone. A poor grade of lithopone tends to discolor when subjected to the action of chemicals or sunlight.

Zinc Sulphate.—Several commercial methods of making zinc sulphate are in use. The raw materials usually consist of low-grade oxidized zinciferous materials from various metallurgic operations with zinc ores.

At Langeloth, Pennsylvania, in the plant of the American Zinc & Chemical Co., is an installation for making four tons of zinc sulphate crystals daily. The raw materials are "reject" zinc oxide from the zinc oxide plant of this company and sulphuric acid from the acid plant operated in connection with the zinc ore roasters. The zinc oxide and the acid are fed simultaneously to a lead-lined cylindrical tank 10 x 20 ft., provided with wooden paddle agitators, but the mixture is always kept basic and never allowed to become acid. Toward the end of the reaction chloride of lime is added to oxidize the iron completely, so that it will be hydrolyzed by the excess of zinc oxide present. The sludge is then filtered out in a filter press, using canvas as the filtering medium. This sludge consists of zinc oxide, zinc sulphide,

zinc sulphate, lead sulphate and iron hydroxide and oxide, as well as minor amounts of other impurities. It is returned to the zinc oxide plant where the zinc and lead are volatilized on Weatherill grates. This sludge contains 30 per cent of the original zinc fed to the zinc sulphate plant. The filtrate of pure zinc sulphate solution is crystallized in shallow lead tanks to give crystals of $\text{ZnSO}_4 \cdot 7\text{H}_2\text{O}$ which are then dried to about $\text{ZnSO}_4 \cdot 5\text{H}_2\text{O}$ and contain 0.01 per cent iron.

Kirby Thomas¹ describes a method of using flue-dust from the standard Mathiessen-Hegeler roaster used by many zinc smelters in the United States. This flue-dust amounts to 2 or 3 per cent of the weight of the ore roasted and consists largely of zinc sulphate with sulphates of lead, iron, calcium, etc., as well as some unroasted ore. Although Thomas does not mention it, cadmium sulphate often concentrates into such dusts. This dust is leached with hot water in lead-lined agitator tanks and then bleaching powder and zinc oxide added to throw out iron and manganese. Soda ash (Na_2CO_3) is used to neutralize acidity before the bleaching powder is used. Sodium sulphide solution in about theoretical proportion will precipitate copper (and cadmium) leaving the solution ready to be filtered in a wooden press with lead connections. The filtered liquor is concentrated in lead tanks with lead steam coils to a density of 52-53° Bé. On standing in lead tanks this solution gives a mush of zinc sulphate crystals. These can be centrifuged for twenty minutes in a brass or copper centrifuge basket and this gives a product pure enough for the lithopone manufacturers.

The residue from the filter press contains all the silver, gold, copper and lead and can be sold to lead smelters. The manufacturing cost of making zinc sulphate crystals, making no charge for the flue-dust, but allowing maintenance of plant and all other items, is said by Thomas to be \$20 to \$25 per ton.

Zinc Chloride.—Zinc chloride is used in the United States to the extent of sixty tons daily, the greater portion going

¹*Mining and Scientific Press*, 115:724 (1917).

to the timber preservation plants where wood is impregnated with a zinc chloride solution. The zinc chloride acts as an antiseptic and prevents rot. Zinc chloride solutions are also used in the hard-fibre industry, utilizing the property of concentrated zinc chlorides which dissolve cellulose. Hard fibre finds many applications such as in gaskets, chair bottoms, waste-baskets, electrical machinery parts, etc. Zinc chloride also is a component of many fluxes for tinning, soldering, galvanizing and similar operations. A further quantity of zinc chloride enters some makes of dry cells together with ammonium chloride, and there are many minor uses of this chemical.

As described in the chapter on chlorinating zinc ores, most of the zinc chloride made in the United States comes from various forms of scrap zinc like galvanizers' dross, zinc skimmings, sal ammoniac skimmings, and brass melters' flue-dusts. These are dissolved in muriatic acid. The acid used is often the off-color or other second-grade acid from a muriatic acid plant. Zinc chloride solutions are so easily purified that the zinc chloride plant gives an opportunity to get rid of products which would otherwise be somewhat embarrassing to dispose of. The purification of the solutions has already been described. The evaporation of the zinc chloride solutions is usually done in enameled iron pans or pots, although lead pans can be used for the first stage of the evaporation. Much of the zinc chloride intended for use in preserving railroad ties is sold as a 50 per cent solution and shipped in iron tank cars. The problem of purifying this liquor, as well as concentrating it slightly to bring it up to the proper strength, is very simple. In fact, a skillful operator can make most of his zinc chloride solution without having to evaporate more than 10 per cent of the total solution made and without having to filter the solution to recover some of it from the sludge accumulating from a number of runs. Zinc chloride is also sold in the solid "fused" form, cast into iron drums or granulated and shipped loose in iron drums. Evaporation to dryness is attended with difficulties

as the zinc chloride starts to hydrolyze at about 180° C. and from there on to the melting point of dry zinc chloride, 262° C., trouble is experienced with the hydrochloric acid fumes given off. It is at this stage of evaporation that enameled iron apparatus is needed. The mass goes through a mealy stage at 230° C., because most of the water is gone from the mass and until the melting point of zinc chloride is reached, 262° C., the mealy consistence is quite marked. Below 230° C., the liquor is a solution of zinc chloride in water and above 262° C., the liquor is molten zinc chloride containing a small amount of dissolved water. Just before tapping the molten zinc chloride it is best to add a small amount of hydrochloric acid to replace the hydrochloric acid lost during evaporation and prevent the zinc chloride being cast in "basic" condition.

CHAPTER XII

ECONOMICS OF ZINC HYDROMETALLURGY

A single chapter will not suffice to adequately discuss the economics involved in choosing a wet method of zinc extraction in place of the standard fuel smelting process or the electric smelting process. It will only be possible to point out a few of the main facts.

Standard zinc smelting in the United States has never been in the hands of monopoly so that the most severe competition conditions have been maintained and a chronic condition of over-production. This narrowed down the profits to a vanishing point for any except to most fortunately situated and best equipped operators. At the pre-war figure of 5c. per lb., only those smelters located in coal or gas fields and equipped to make or sell sulphuric acid, and to recover lead and silver from the zinc smelter residues, could make a profit. At the present time the same condition obtains when zinc sells at 7.5 to 8c. per lb. Only during the occasional swings of the market above these prices, due to fluctuating demands, is it possible to smelt zinc at a profit. The recent formation of the American Zinc Institute, while it has not yet brought about agreements between smelters as to prices to be paid for ore and demanded for metal, will undoubtedly reduce competition to some extent, although present efforts are being expended in broadening the demand for zinc.

Installation costs of smelters as compared to electrolytic zinc plants are not very much different. A plant capable of producing two hundred tons of zinc daily would cost at present about \$5,000,000 by either method. Smaller plants would cost more per ton of zinc and it is doubtful if plants operated on twenty-five tons zinc daily could be built for less than \$750,000.

Operation costs of both processes are probably in favor of the electrolytic method for large plants and of the smelting method for small plants. However, so many other factors enter into the cost of delivering finished zinc to the consuming market that operation cost of the two processes is not the most important consideration to be taken into account.

While several excellent estimates on the cost of producing electrolytic zinc are available in the literature,¹ the new conditions brought about by the war have raised the cost of producing zinc to such an extent that it is not thought advisable to incorporate them here. Instead, the writer has prepared two estimates which more nearly represent present conditions (July, 1920).

The first of these estimates of operation cost is intended to apply to a small mine with a zinc-iron sulphide ore containing 30 per cent zinc, in an isolated locality which does not have the advantage of cheap power and where first cost of a 10-ton zinc plant amounts to \$30,000 per ton per day. The further assumption is made that the plant will have about a 10-year life and that other uncertainties make it advisable to count on only ten years' operation of the enterprise before possible improvement may make desirable a complete change of plant.

Power, 3,300 kw.-hr. at 1c.	\$33.00
Labor, 4 man-days at \$5.	20.00
Acid.	5.00
Coal, one-half ton.	3.00
Purification chemicals.	2.00
Repairs.	7.00
Miscellaneous.	2.00
Insurance and normal taxes, 5 per cent on \$30,000.	5.00
Interest, 6 per cent on first cost and on operating capital.	12.00
Depreciation, 10 per cent.	9.00
Contingency fund, 4%.	3.00
Sales expense, 2 per cent on gross sales.	2.00
Total metallurgic cost.	\$103.00

¹C. A. HANSEN: Metallurgical and Chemical Engineering, 14:120-122 (1916).
THOS. FRENCH, *Trans. Am. Electrochem. Soc.* 32:321 (1917).

In addition to the above there is the expense of mining the ore, preparing it for the electrolytic plant and delivering it to the plant. This will amount to \$5 to \$7 per ton of 30 per cent zinc ore, making \$25 to \$35 per ton of recoverable zinc. Then the cost of delivering the zinc to the consuming market will vary from \$7 in the middle-western mining fields, to \$15 per ton for the intermountain mining districts. This makes a total of \$32 to \$50 to be added to the metallurgic cost, or a total cost of a ton of zinc, delivered at East St. Louis or New York, about \$135 to \$150. This corresponds to 6.8c. to 7.5c. per pound and allows any price above these figures as profit, providing none of the assumptions made in the estimate are too low.

The second estimate is intended to apply to localities favored with respect to cheap water power, sufficiently near to the mines that complex sulphide concentrates can be shipped to a large centrally-located metallurgic establishment, and with a 20-year supply of ore in sight, although the new condition of the art makes it advisable to charge 10 per cent depreciation on the plant. A plant capable of making one hundred tons of zinc daily will cost at least \$20,000 per ton zinc per day.

Power, 3,300 kw.-hr. at 0.33c.	\$10.90
Labor, 2 man-days at \$5.	10.00
Acid.	5.00
Coal.	2.50
Purification chemicals.	2.00
Repairs.	5.00
Miscellaneous.	2.00
Insurance and normal taxes, 5 per cent.	4.00
Interest, 6 per cent on first cost and operating capital.	7.10
Depreciation, 10 per cent.	6.00
Sales, 2 per cent.	2.00
<hr/>	
Total metallurgic cost, per ton zinc.	\$56.00

In this case, the cost of mining and concentrating will make a ton of 30 per cent zinc concentrate, delivered at the zinc plant, worth \$25 to \$35, which makes a ton of recoverable zinc cost \$100 to \$150, unless part of the expense

is borne by silver, lead or copper in the zinc concentrate. This is practically always the case so that only two-thirds of the ore cost is here assumed as charged to the zinc. This means \$67 to \$100 per ton for purchasing zinc in the ore.

Adding on freight charges, as in the first estimate, the total cost of zinc delivered in the consuming markets will vary from \$130 to \$160 per ton of zinc, or 6.5 to 8.0c. per pound of zinc recovered. The reason the large plant has production costs as large as the small plant, in spite of the lower power costs is that in one case the small plant is located at the mine and owned by the same company as that operating the mine and no concentrating is necessary. In the second case the plant more distant from many different mines pays the expense of mining, milling and freight to the large custom smelter, together with reasonable profits on each operation.

These two cases represent the two extremes of the hydrometallurgy of zinc which can be operated with any hope of profit. The discussion of the various important factors given below will suggest important modifications of the above figures to suit various conditions.

Recoveries of zinc in hydrometallurgical methods have thus far averaged only about 70 per cent, although certain ores can be treated with a yield of as much as 90 per cent of the total zinc. In the standard smelting methods the recovery of zinc on a 60 per cent ore is about 85 or 88 per cent, whereas the recovery from a 30 per cent ore is probably no higher than 70 per cent. In the case of the 30 per cent zinc ore, there is usually a considerable amount of lead and silver present which must be recovered from the residue of either a smelter or an electrolytic zinc plant. The present established practice of the zinc smelters is to pay for only 60 per cent of the lead and silver in the zinc ores consigned to them, since large losses take place and the expense of recovery is high. In the case of electrolytic zinc plants, except for its fineness of division, the residue is easily smelted and a recovery of at least 80 per cent and even 90 per cent of the

lead and silver is attained. It can be seen that on mixed sulphide ores of this character the electrolytic zinc plant will have the advantage in metal recoveries over a smelter. With higher-grade or straight zinc concentrate the advantage diminished and might even be reversed, depending on the other factors involved, such as cost of power, fuel, etc.

The question of transportation lines available and freight rates is very important in considering the economics of zinc metallurgy in the United States. Practically all of the consumption is east of the Mississippi River and most of the ore is mined west of it. Also the coal and gas fields where cheap fuel is available for smelting, are located in the Mississippi valley or east of it. There are freight hauls varying from \$2 to \$20 in shipping zinc ore from the mines to the smelting centers. The higher freight costs are involved in those localities which are found in the Rocky Mountains, Montana, Idaho, Colorado, Utah, Nevada, Arizona, New Mexico and California. In most of these latter localities water power is available at reasonable rates and the question is one of whether to ship ore to distant smelters or to treat locally by electrolytic methods and ship only finished zinc weighing one-third to one-half the ore. A somewhat higher freight rate is demanded for metal than for ore, but it does not wipe out the difference.

The analysis of the ore has a further effect on the economics of the question, outside of the metallurgic differences already mentioned. For instance, the sulphur in a zinc ore has a value of 0.75c. per lb., provided the roaster gases from the ore are converted into sulphuric acid. This makes the sulphur pay its own freight from most of the localities from which zinc ores are shipped. If the other constituents of the ore consist mainly of zinc, lead and copper, with low iron or silica content, it is easily seen how it would be possible to ship complex zinc ores from distant points in the Rocky Mountains as far east as Niagara Falls for electrolytic treatment. The reason is that the normal market for every constituent of the ore exists in the eastern states and it is there-

fore not necessary to ship only zinc metal in order to economize on freight for a complex sulphide ore containing over 45 per cent of zinc and low iron and silicon content.

The present state of advancement in the art makes it economical to use electrolytic recovery of zinc only on the more complex sulphide ores and both technical and economic advantage seems to lie in the treatment of finely ground concentrates rather than coarse ores containing more gangue. It is not certain but that electrolytic methods could be used to advantage in treating relatively pure zinc ores like those of the Joplin district, but the great surplus of smelter capacity in proximity to these ore deposits makes it inadvisable to construct electrolytic zinc plants for their treatment.

INDEX

- Acidity of chloride solutions, 142, 143
 of solutions in electrolytic refining, 152, 154
 of sulphate solutions, 76, 79, 88, 92, 94, 97, 174
- Addition agents, 19, 56, 81, 95
- Air volume in zinc roasters, 30
- Agitators, 43, 44, 73
- Aldrich, C. H., 23, 151
- Alkaline leaching agents, 182
- Aluminum in leaching solutions, 52, 124
 in electrolysis, 52, 97
- American Smelting & Refining Co., 22, 149
- American Zinc & Chemical Co., 186
- Ammonium chloride flux, 155, 159
- Ammoniacal leaching processes, 182
- Anaconda Copper Mining Co. plant, 21, 22, 52, 62
- Anaconda-Wedge zinc roaster, 29, 161
- Anode disintegration in sulphate solutions, 62
 slime in zinc refining, 153
- Anodes, depolarization, 13
 in chloride solutions, 126, 127
 in sulphate solutions, 76, 85, 88, 102, 108, 109, 173
 in zinc refining, 152, 153
- Antimony in electrolysis, 53, 152
 in leaching solutions, 52, 53, 54, 55, 58, 97, 124
- Arsenic in electrolysis, 53, 97
- Asbestos diaphragms, 131
- Ashcroft, Edgar A., 16, 117, 118, 119, 143
- Avery, D., 56
-
- Baltimore, Md., plant, 23, 151
- Besley, Chas., 11
- Bibliographies, 13
- Bisulphite process, 18, 183
- Blaylock, S. G., 21, 69
- British Castner-Kellner Co., tests, 17, 118
- British Electrolytic Zinc Co., 19
- British Metals Extraction Co., plant, 19
- Broughton, H. E., 179
- Brunner Mond and Co. plant, 16, 39, 112, 125
- Bryan, J. K., 23, 151
- Bully Hill plant, 20, 55
- Bus bars, 110, 141, 171, 172

- Cadmium, effects on, on electrolysis, 99, 124
 - in electrolytic zinc refining, 145, 147
 - in roaster fumes, 28
 - in zinc, 9, 145
- Calamine, 6
- Calcium chloride, 122
 - plumbate, 56, 59
- Capacity of plants for electrolytic zinc, 7, 8
- Caples, R. B., 54, 60
- Cathodes in chloride solutions, 131, 139
 - in sulphate solutions, 76, 88, 103, 104, 105, 106, 107, 108, 152, 174
- Chapman, Lloyd W., 168
- Chloride methods of extracting zinc, 2, 5, 39, 112, 113
- Chlorides in sulphate solutions, 62, 63, 99, 109
- Chlorine gas, 116, 126, 130, 141
- Circulation of electrolyte, 77, 81, 94, 101, 138
- Classifiers, 45, 74
- Classification of grades of zinc, 9
- Clevenger, G. H., 56, 57
- Cobalt as an impurity, 23, 55, 56, 57, 58, 98, 124, 181
- Cobeldick, Prof. W. Morley, 118, 119
- Cockle Creek, N. S. W., plant, 17, 117
- Complex sulphide ores, treatment of, 4, 192, 194
- Consolidated Mining and Smelting Co., 21, 69
- Copper in solutions, 61, 98, 111, 124
 - in zinc ores during roasting, 28
- Corbin, Montana, plant, 20, 121
- Corrosion of cathodes, 79, 80, 81, 95, 96
- Cost of producing zinc, 191, 192, 193
- Cottrell precipitator, 34
- Counter-current leaching, 42, 162
- Current density, 78, 93, 96, 134, 182
- Current efficiency, 78, 82, 89, 93, 135

- Denver, Colo., plant, 23
- Diaphragms, electrolytic, 126, 130, 131, 134, 135, 136, 144, 152
- Dorr classifiers, 45, 162
 - thickeners, 45, 46, 74, 162
- Dry chlorination, 117, 118, 119, 120, 121
- Ducktown Sulphur, Copper and Iron Co., 177
- Durant, H. T., 18

- Edwards, 18
- Electric furnace extraction of zinc, 3
- Electrode spacing, 101, 138
- Electrolysis of chloride solutions, 125, 139, 141
 - of fused zinc chloride, 143
 - of sulphate solutions, 75
- Electrolytic Zinc Co., Inc., 23, 151

- Electrolytic Zinc Co. of Australasia, 23, 55, 56, 63, 181
Electrolytic zinc dust, 183
Electrolyte for zinc refining, 152
Electroplating with zinc, 1, 11
Elkington, 11
Elton, J. O., 21, 53, 62
Energy efficiency, 90, 93, 136, 137
Evaporation of zinc chloride solutions, 143, 188, 189
- Ferrite of zinc, 26, 32, 33, 38, 39
Field, Samuel, 56
Filtering zinc chloride solutions, 123, 124
Filters, 45, 46, 67, 70, 74
Florance, Colo., plant, 23, 179
Flux for melting cathodes, 155
French, A. G., 19
Frick, F. F., 21, 54, 60
Fry, H. G., 18
Fuel consumption in roasting, 30
Fürfurt plant, 15, 16, 114, 126, 127, 139
Furnaces for melting zinc, 156, 157, 158
- Galena, effect of, in roasting, 26
Galvanizers hard dross, 15, 145, 146, 150
Galvanizing, wet, 1, 11
General Electric Co., 20, 55
Georgetown, Colo., plant, 20, 121
Gepp, H. W., 23, 56
Glue as addition agent, 56, 59, 95, 142, 181
Grades of zinc, 9
Graphite anodes, 127, 128
Great Falls plant, 31, 63, 64, 65, 72, 73, 104, 107, 157, 161, 163
Guernsey, F. W., 21
Gülcher Co., 15, 147
Günther, Emil, 13
- Hall, A. E., 22
Hall, R. G., 23
Hamburg Guld and Silber Scheideanstalt, 15, 149
Hamilton, E. H., 32, 70
Hanley, H. R., 23, 55, 102, 184
Hansen, C. A., 20, 23, 30, 33, 52, 58, 59, 62, 79, 82, 85, 96
Hasse, 149
Hermann, R. P., 14, 147
High grade zinc, 9, 10, 145
History of zinc hydrometallurgy, 11
Hobart, Tasmania, plant, 23, 36, 39, 56, 58, 106, 181
Hoepfner, Carl, 15, 16, 18, 112, 114, 125, 126, 128
Holes in zinc deposits, 95

- Hommel, 18
Hyde, R. W., 22
Hydrogen during electrolysis, 81, 88
Hydrometallurgy, definition of, 1
 of zinc, limitations of, 4, 6
Hydrolysis of iron salts, 49, 50, 115, 124
Hydrozincite, 5
- Illawarra, N. S. W., plant, 18
Impurities in zinc solutions, 42, 43, 46, 47, 75, 79, 94, 95, 97, 115, 142, 166,
 176
Iron compounds during electrolysis, 48, 97, 135, 153
 during leaching and purification, 48, 49, 50, 51, 52, 124
Isherwood, P. C. C., process, 19
- Jacobson, B. H., 133, 152
Judge Mining and Smelting Co., 23, 30, 33, 103, 104, 166-177
- Keating, J. B., 20
Kellogg, Idaho, plant, 20, 121, 144
Kelly filter, 45, 72, 165
Kennett, Calif., plant and ores, 21, 23, 55, 102, 180, 181
Keokuk, Iowa, test plant, 23, 179
- Laist, F., 21, 53, 60, 62
Langeloth, Pa., zinc sulphate plant, 186
Leaching with sulphuric acid solutions, 41, 43, 162, 169
Lead in zinc, 9
 in solutions, 61, 99, 124
 peroxide, 56, 59
Lee, F. E., 21, 38
Lérange, Leon, 12, 18
Lithopone, 185, 186
Llansamlet, Wales, plant, 19
Lorenz, R., 17
Luckow, C., 12
Lyon, D. A., 116
Lyte, F. M., 17
- Machinery used in leaching, 43
Malm, J. L., 20, 117, 120, 121, 144
Manganese dioxide, 55, 56, 59, 60, 69, 89, 98
 in solutions, 58, 59, 60, 98, 124, 143, 176
Marmatite, 26
Materials of construction, 46, 65, 99, 123, 126, 136, 153
Mathewson, E. P., 13
McCallom, A. L., 38
McDougall Roasters for zinc ores, 29
McIntosh, 32

- Melting electrolytic zinc, 155-160, 166, 177
Morgan, H. J., 183
Muriatic acid, 112
Murray, G., 32
Murray, Utah, test plant, 22
- Nahnsen, G., 17
Niagara Falls tests, 20, 119, 144
Nickel, 55, 56, 124
Nitroso-beta-naphthol, 57
- Oliver filter, 45, 47, 162
Omaha, Neb., test plant, 22, 149
Operation of cell room, 110, 111
Overvoltage of hydrogen, 80, 90
 of oxygen, 85
Oxidized ores of zinc, 5, 61
Oxidizers for purifying zinc solutions, 49, 53, 55, 56, 57, 58, 116
- Pachuca agitator, 43, 44, 162
Palo Alto, Calif., test plant, 21
Park City, Utah, plant, 23
Parks process zinc crusts, 14, 15
Pennsylvania Salt Co., 116
Pfleger, Johannes, 148
Phoenix process, 17, 140
Plants, table of hydrometallurgic zinc, 7
Portland filter, 45
Pouring molten zinc, 157, 158, 159
Power for electrolytic zinc, 4, 5, 11, 92, 177
Prime Western zinc, 9, 10, 23, 145, 152
Production of electrolytic zinc in the U. S., 7, 8
 of smelter zinc in the U. S., 8
Purifying zinc chloride solutions, 115-123
- Ralston, O. C., 116, 183
Recovery of zinc by leaching, 72, 193
Reed, C. J., 21
Rees, H., 18
Refining of zinc, electrolytic, 1, 14, 23, 145-154
Resistance of zinc sulphate cells, 88
Re-solution, *see* Corrosion.
Richards, J. W., 150
River Smelting and Refining Co., 23
Roasting zinc ores for smelting, 25
Roesing, B., 14, 148
Roessler & Edelmann, 15, 148
- Salt chlorination of ores, 113-116
Schnabel, 149

- Schol, F. G., 23
Schultze, H., 17
Selenium in roaster fume, 27, 55
Siemens, Werner von, 11
Siemens and Halske, 18
Silicic acid, trouble due to, 56, 60
Silver, volatilization from zinc ores, 28
Size of particles, effect on roasting, 34, 37, 71
Skinner, Lewis, 23
Slimes from anodes in refining, 153
Smelting Company of Australia, 18
Smelting of zinc, 3, 8, 190
Smithsonite, 6
Solution ratio, 73
Solutions used in leaching, 42, 43
Sphalerite, 5
Spongy zinc, 94, 141, 142, 184
Steinhart, O. F., 17
Stimmel, B. A., 21
Stevens, R. H., 56, 57, 59
Sulman, H. L., 18
Sulphate leaching and electrolysis process, 2, 41
Sulphide Corporation plant, 17
Sulphur, effect on distillation of zinc, 25
 dioxide, action on ferrites, 38, 39
 percentage in flue gases, 33
Swinburn, James, 17, 117

Tainton, U. C., 19
Tanks for electrolysis, 99, 100, 101, 171
Temperature during electrolysis, 80, 88, 96
Time for leaching, 45
Thallium, 115, 124
Thickeners, 45, 46, 74
Thickness of deposited zinc, 82, 83
Thomas, Kirby, 187
Tragacanth, gum, 19
Trail, B. C., plant, 21, 32, 52, 69, 72, 73, 150, 165-168
Trees, 78, 81, 94, 95, 156

United States Smelting, Refining and Mining Co., 23, 55

Vanadium as an impurity, 62
Vapor condensation, zinc, 3
Venture Trust, 19
Vogel, J. F. L., 18
Voltage of chloride cells, 133, 134, 144
 of refining cells, 150
 of sulphate cells, 84, 85, 86, 87, 93, 174, 178
 of zinc cells, lowering, 13, 89

- Water for cooling roasters, 31
 - of zinc plants, 62
- Watt, A., 147
- Wedge zinc roaster, 29, 32, 33, 161
- Weedon Mining Co., 22
- Welland, Ont., 22
- Western Chemical Co., 23, 62
- Wet chlorination, 116, 121
- Wheeler, H. L., 13
- Willamite, 6
- Winnington, Eng., plant, 125

- Zinc chloride, 112, 115, 143, 187-189
 - crusts, recovery of zinc from, 14, 22, 145, 146
 - dross, 155, 156, 159, 160, 166
 - dust, 62, 68, 73, 166, 183
 - oxide, 160, 185
 - scrap, 123
 - skimmings, 123
 - sulphate formed in roasting, 35, 181, 182
 - manufacture, 186, 187
- Zincite, 6

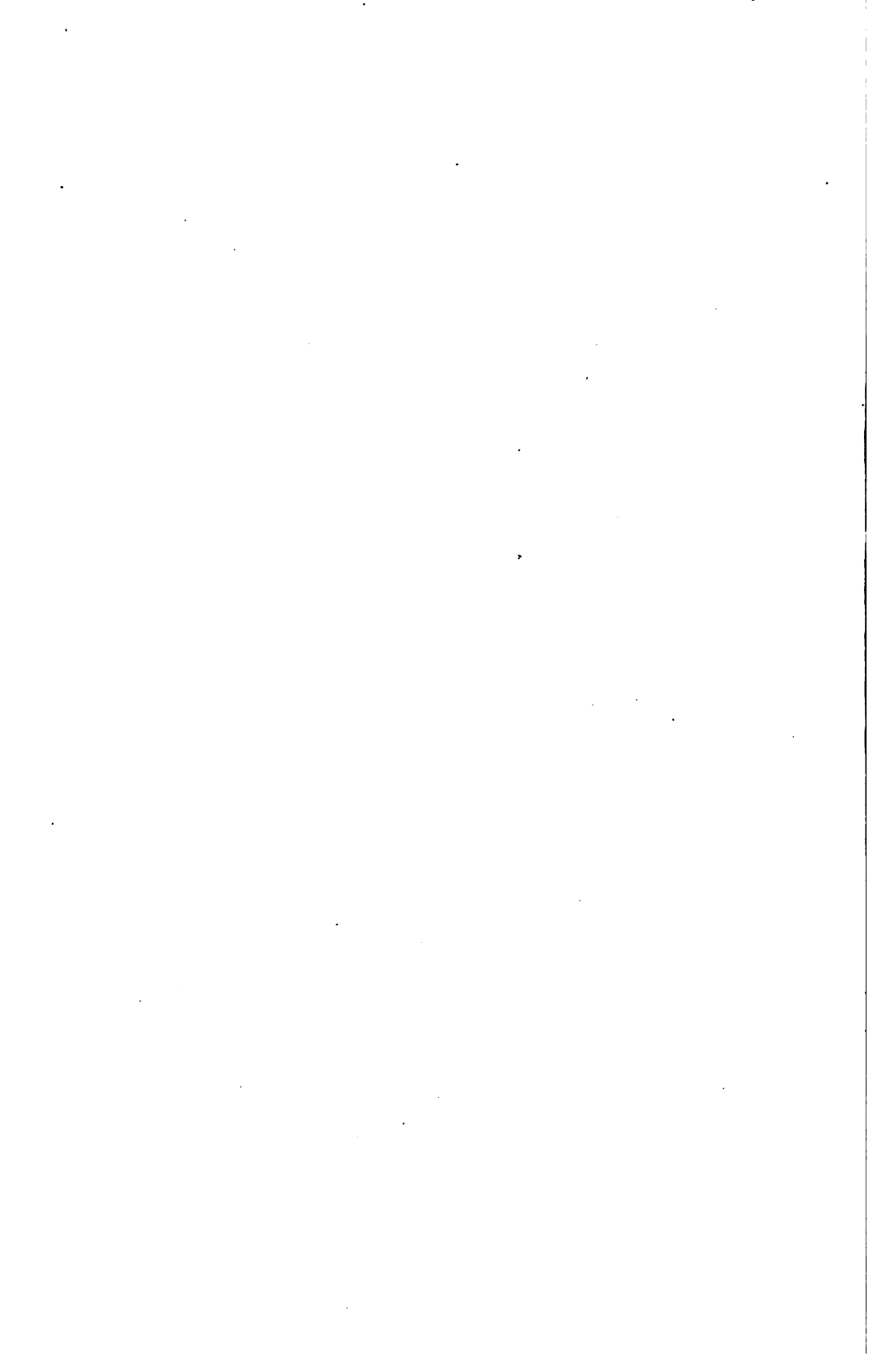

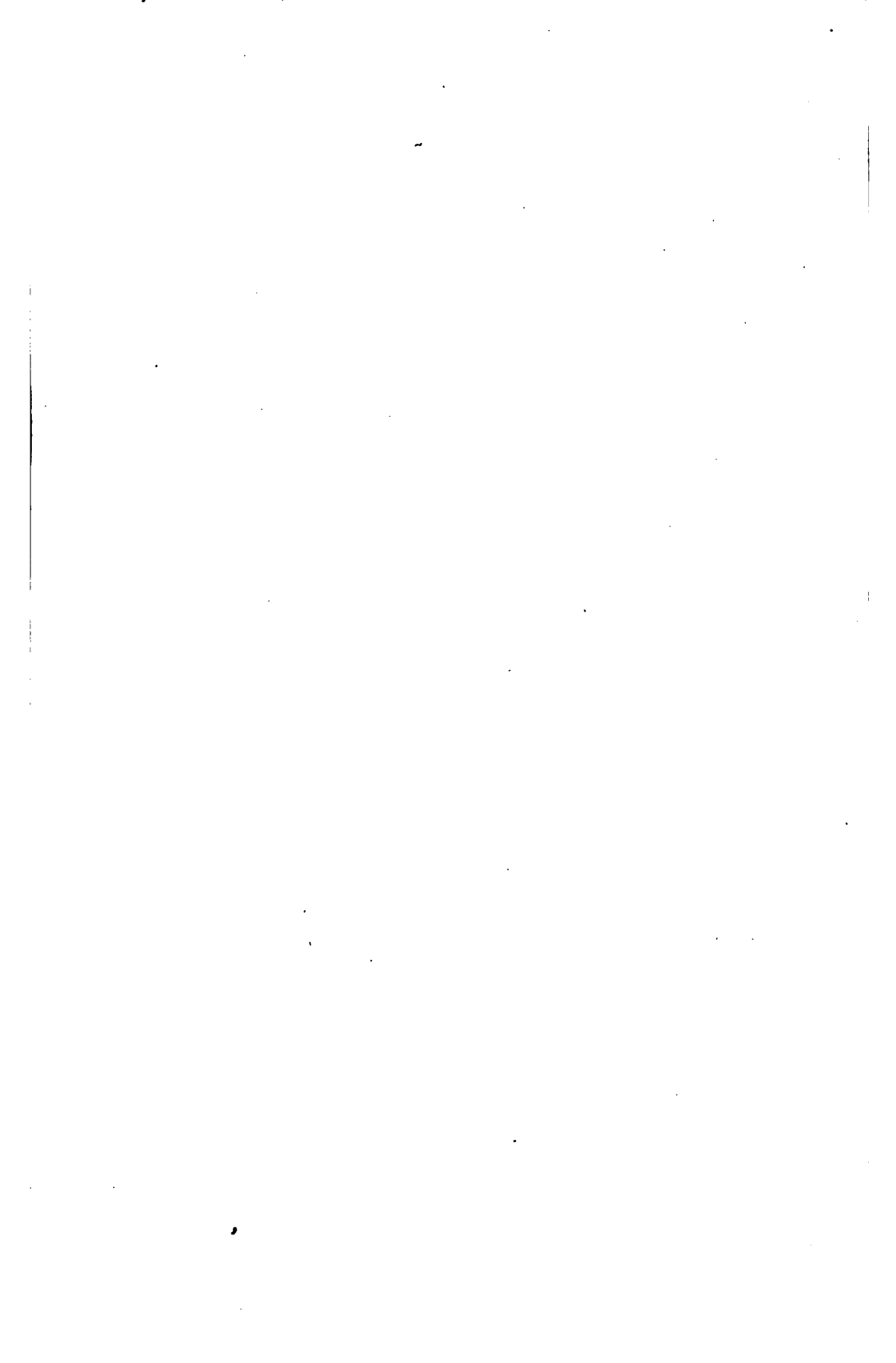

89083895565



B89083895565A

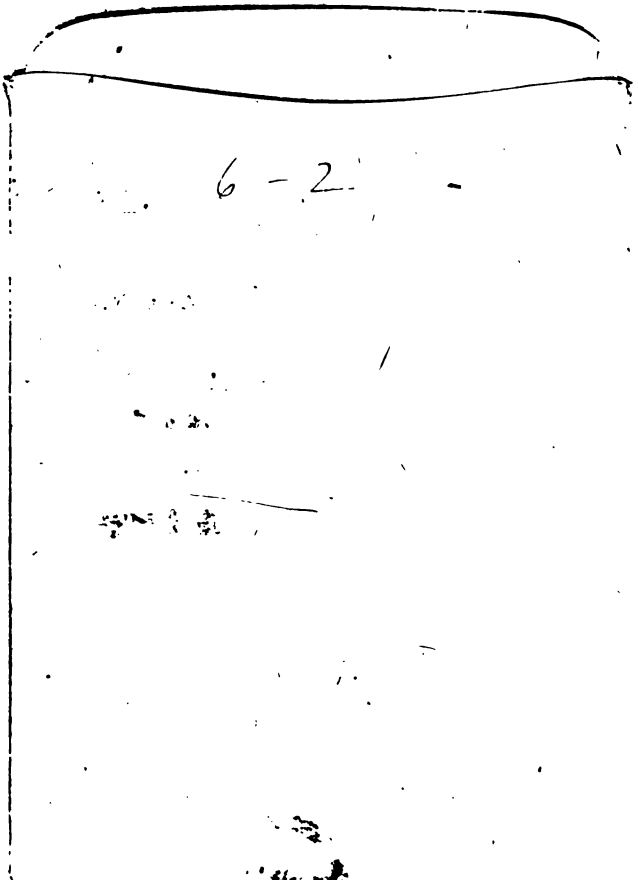

6-2

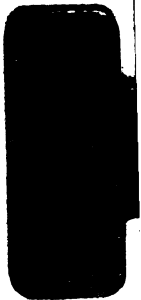

ENGINEERING
LIBRARY

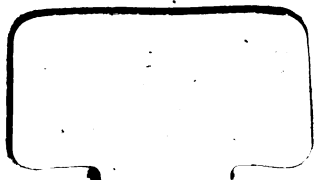

89083895565



b89083895565a