

Mining dept.

LIBRARY
OF THE
UNIVERSITY OF CALIFORNIA.

Class

ELECTRO-MAGNETIC ORE SEPARATION

BY

C. GODFREY GUNTHER



WITH ILLUSTRATIONS

1909

HILL PUBLISHING COMPANY

505 PEARL STREET, NEW YORK

6 BOUVERIE STREET, LONDON, E. C.

The Engineering and Mining Journal—Power—American Machinist

G 8
Mining
dept.

Mining Dept Budget
MCC

COPYRIGHT, 1909, BY THE HILL PUBLISHING COMPANY

ENTERED AT STATIONERS' HALL, LONDON, ENGLAND

All rights reserved

Hill Publishing Company, New York, U. S. A.

PREFACE

THIS book has been prepared to gather into convenient form the published information on the magnetic separation of ores. The compilation has been supplemented by data from the writer's observations and an extensive correspondence with mill managers and manufacturers. It has been attempted to include only that which is of present commercial importance.

The writer wishes to express his thanks to the many who have aided him in the collection of data for this work, and especially to Messrs. W. R. Ingalls, W. L. Austin, Erminio Ferraris, C. Q. Payne, Adriano Contreras, S. Norton, James Hebbard, and Benjamin Hodge, and also to the Humboldt Engineering Works Co., Elektro-Magnetische Gesellschaft, Marchegger Maschinenfabrik, United Iron Works Co., and the Dings Electromagnetic Separator Co.

EL PASO, TEXAS, September, 1908.

INTRODUCTION

THE magnetic properties of certain minerals have long been recognized, and their concentration through magnetism can lay no claim to novelty. A patent was awarded in England on a process for separating iron minerals by means of a magnet in 1792, and in this country a separator having a conveyor belt for presenting ore beneath electro-magnets excited by cells was employed in separating magnetite from apatite in New York State in 1852.

The earlier attempts at magnetic separation naturally were directed toward the separation of the most strongly magnetic substances. The first separators were employed in separating iron from brass filings and turnings, metallic iron from furnace products, and magnetite, the most strongly magnetic of minerals, from gangue. The next step in the process was in roasting, or calcining, certain iron minerals which might by such means be transformed into strongly magnetic compounds and separated from their admixtures. The steady development of improved apparatus and more intense fields has constantly broadened the field of magnetic separation until minerals previously considered nonmagnetic are separated commercially.

Beginning with the crude machines which employed permanent magnets to attract the magnetic particles and brushes to detach the material so collected, a great variety of separators has been devised and patented, and many of them have been placed in commercial operation. The magnetic separator has been developed, in most instances, for the exploitation of individual ore deposits, and the different types and modifications so produced might well form subject matter for a book. In the United States alone over three hundred patents have been granted.

In view of the above facts the broad practice of magnetic separation is incapable of monopoly and its application is not determined by any one machine. The process suitable to the treatment of the ore under consideration having been carefully chosen,

it will be found that any one of several machines will perform the functions of the actual separation.

In its own field, which will be hereinafter outlined, magnetic separation is a useful adjunct to the specific-gravity processes, but it is in no sense a competitor with these processes except in the concentration of magnetite iron ores, and in this application is a success backed up by many years of profitable operation.

CONTENTS

CHAPTER	PAGE
INTRODUCTION	v
I. MAGNETISM APPLIED TO ORE DRESSING	3
II. PRINCIPLES OF MAGNETIC SEPARATION AND PREPARATION OF THE ORE FOR TREATMENT	9
III. SEPARATORS FOR STRONGLY MAGNETIC MINERALS	22
IV. SEPARATORS FOR FEEBLY MAGNETIC MINERALS	61
V. THE CONCENTRATION OF MAGNETITE ORES	79
VI. THE SEPARATION OF PYRITE AND BLENDE	115
VII. THE SEPARATION OF SIDERITE FROM BLENDE	138
VIII. SEPARATION OF MISCELLANEOUS ORES AND MINERALS	153

ELECTRO-MAGNETIC ORE SEPARATION



I

MAGNETISM APPLIED TO ORE DRESSING

ALL substances—solid, liquid, and gaseous—are either attracted or repelled by a magnet, though in most cases this influence is too feeble to be apparent except with delicately adjusted apparatus. The atmosphere has a definite magnetic attractability and the magnetic behavior of solids may be said to be controlled by the magnetic qualities of the surrounding medium; if a substance is more permeable to magnetism than air, it is attracted; if less permeable, it is repelled. The permeability of air (air being the most common medium) is taken as 1, and the permeabilities of all other substances are referred to it as unity. The permeabilities of substances more strongly attracted than air are therefore represented by values greater than 1, and are called paramagnetics; substances less permeable than air are represented by values less than 1, and are called diamagnetics. The permeability of the diamagnetics is so nearly unity that the phenomenon of magnetic repulsion is not a familiar one.

The lines of force of a magnetic circuit pass along the path of least resistance; in other words, they pass through the most permeable substance available. Paramagnetic particles, introduced into a magnetic field, tend to aline themselves in the direction of the lines of force in precisely the same manner that a compass needle alines itself with the magnetic meridian. Paramagnetics concentrate the lines of force, while diamagnetics cause the lines of force to go around them. The passage of lines of force through particles induces magnetic polarity in them, and they gather in tufts or chains, North pole to South pole, and are all held by the energizing magnet. The force with which these particles are attracted is a function of their permeability, the intensity of the field, and the time they are subjected to its influence.

The paramagnetic minerals have been divided for convenience

into two classes: those which are attracted and held by a common permanent magnet, called ferromagnetic minerals, and those not so attracted, referred to as feebly magnetic minerals. The ferromagnetic minerals are magnetite, pyrrhotite, ilmenite, chromite, and franklinite in typical specimens.

Various investigators have made attempts to determine the specific magnetic permeabilities of minerals, but without uniformly reliable results. This is due to two causes: the variable magnetic permeability of the same mineral from different localities (and even of different specimens from the same locality) and the unreliability of the available methods for determining the permeability of minerals. The rod method, employed in testing the permeability of iron, is not applicable to minerals, as rods of sufficient length of pure minerals are not available. The methods employed are based on a comparison of the permeabilities of crushed and sized minerals with crushed and sized cast iron, or filings. The figures so obtained are affected by the size and shape of the particles tested, the amount tested, whether the charge is packed tight or loose, etc., which makes the results of comparative value only.

In view of the above facts the permeabilities of various minerals, as determined, do not form a reliable guide in the consideration of ores, and a preliminary test of the ore in question must be made to determine the applicability of magnetic separation, unless the ore be magnetite or one capable of transformation into magnetic oxide.

While chemically pure minerals possess magnetic permeability independently of any iron they may carry, in practice it is almost always the effect of a trace or more of iron, either chemically combined or present as an impurity, that is utilized for separation. In minerals which combined iron renders separable the magnetic permeability varies more or less regularly with the amount of iron combined; but minerals which depend for their separation upon the presence of iron as an impurity are subject to wide variations in permeability, and are therefore more unreliable subjects for magnetic separation.

The paramagnetic metals are iron, nickel, cobalt, manganese, chromium, cerium, titanium, palladium, platinum, and osmium. Oxygen is paramagnetic (liquid air is attracted and held by a magnet) and sulphur is diamagnetic; the oxides are therefore

more likely to be magnetic than the sulphides of the same metals, and in like manner the oxides are usually more strongly magnetic than the carbonates. That the chemical composition of a substance does not determine its magnetic properties, however, is strikingly shown in the mineral pyrite (FeS_2 , 46.7 per cent. iron) which is too feebly magnetic to be separated by the most intense field yet produced; and also in the bromide of copper, a compound of two diamagnetic elements, which is paramagnetic. The occurrence of strongly magnetic galena at Gem, Idaho, is another striking instance of the variable magnetic behavior of minerals.

The crystalline form of a compound has an effect on its magnetic properties, as has also water of crystallization. The temperature at which separation takes place also exercises an influence: Langguth ("Elektromagnetische Aufbereitung," p. 5) separated readily a zinc blende, warm, which was with difficulty effected when cold.

Much has been written concerning the magnetic properties of various salts and alloys, in the investigation of which peculiar manifestations of magnetism have been observed. While throwing light, perhaps, on the magnetic behavior of matter, these results are hardly of importance in the practical subject of magnetic separation. (For the theories regarding the magnetic properties of matter the reader is referred to the writings of Poisson, Coulomb, Ampere, Becquerel, Weber, Burgman, Kohlrausch, Plucker, Tyndall, Faraday, Delcasse, Dolter, Wiedman and others.)

THE FIELD OF MAGNETIC SEPARATION

The applications of magnetism to ore dressing fall naturally under two heads: the concentration of magnetic minerals from their gangues, and the separation of two or more minerals of similar specific gravity in the products of a preliminary water concentration.

Magnetic concentration has been applied principally to the treatment of magnetic iron ores, eliminating the gangue, and at the same time effecting a partial separation of phosphorus and sulphur minerals which are frequent and objectionable contaminations. The concentration of these magnetite ores is the oldest, and to-day one of the most important applications of magnetism to ore dressing. A plant for the concentration of siderite from

gangué has been in operation in France for a number of years, and another is now being constructed in Hungary. Magnetic concentration has also been applied to the treatment of ores carrying chalcopyrite. This mineral has a tendency to slime, when crushed, which gives rise to an important loss in subsequent wet concentration; but after roasting it is readily saved by magnetic attraction, even if in a fine state of division. There are other minor applications of magnetic concentration such as leucite from lava, manganese ores, garnetiferous schists, etc.

In magnetic separation, as distinct from concentration, the applications are more numerous and complex. There occur in nature many combinations of minerals whose specific gravities are too similar to permit of their separation by any of the usual concentrating devices. In such combinations where one of the minerals is magnetic, or may be rendered magnetic by the application of heat, magnetism offers an efficient, and often the only, method of separation.

For reasons connected with the subsequent reduction of zinc ores the presence of iron is highly objectionable, and ores which carry more than a small percentage of iron are severely penalized. This, together with the similarity of the specific gravities of the iron and zinc minerals often found together, gives rise to one of the most important applications of magnetic separation. Zinc blende frequently occurs with pyrite, marcasite or siderite, all minerals of specific gravities too similar to permit a separation by specific-gravity methods. Pyrite and marcasite are not capable of separation in their raw state, but become magnetic on roasting; siderite is separable by magnetic fields of high intensity, and may also be transformed into a strongly magnetic compound by calcination. Oxidized zinc minerals also occur in important ore bodies with limonite, and here again the difference in the specific gravities of the minerals is too slight to permit a separation by milling methods. Limonite is slightly magnetic and may be removed in its raw state by fields of high intensity, and may also be calcined to the strongly magnetic oxide of iron and removed as such. Zinc blende carrying sufficient combined iron to be magnetic occurs in many localities in Colorado and elsewhere in conjunction with pyrite, from which it may be separated by magnetism without preliminary treatment.

At Broken Hill, N. S. W., immense ore bodies carry blende to-

gether with rhodonite and garnet, minerals of similar specific gravity. The middling products from water concentration of ores carrying these minerals are separated by magnetism. The peculiar ore bodies at Franklin Furnace, N. J., are treated exclusively by magnetic separation.

Magnetic separation has found application in the treatment of monazite sands, in the separation of tin-tungsten concentrate, for the removal of magnetic contaminations from corundum, in heavy sulphide concentrates, in the separation of chalcopyrite-blende-siderite concentrates, and in other cases.

The principal applications of magnetism to ore dressing as represented by successful installations have been stated above, but there are many other separations which are entirely practicable but not at present in commercial use. The low prices and high standards of iron ores obtaining in the United States do not permit of the exploitation of ore fields which in another country would be of great value. As our purer ores are exhausted, and prices rise, there will be a steady increase in application of magnetism to the concentration of iron ores, not alone in the treatment of natural magnetite, but also for the lean hematites and limonites which cannot now be worked at a profit.

MAGNETIC SEPARATION AS A PROCESS

Where applicable, this process possesses all the advantages held by other separation processes, and, in addition, is independent of gravity. A prerequisite of success in any separation process is the existence of the minerals to be separated as free particles, and in this magnetic separation constitutes no exception. Furthermore, all separating devices work better on sized material than on a mixture of coarse and fine particles. While sizing is necessary in many specific-gravity methods, it is desirable, but not imperative, in magnetic separation. The preparation of the ore for treatment by crushing and sizing represents, in any case, a large proportion of the total cost of the process, whether the final separation be made by jigs and tables or by magnetic separators.

The magnetic separator has been developed into an efficient machine which is economical of power, both for operation and excitation of the magnets, not liable to break down or get out of adjustment, is easily operated by anyone with the intelligence neces-

sary to operate any of the usual concentrating machines, and is not a source of large expense bills for repairs and renewals.

To sum the matter up, the only difference between specific-gravity and magnetic-separation processes is that one utilizes differences in the specific gravities of the minerals to be separated, and the other utilizes the differences in their magnetic permeabilities. Where, however, the ore must be roasted or dried before separation, this item must be charged against the magnetic treatment of which it is a prerequisite.

II

PRINCIPLES OF MAGNETIC SEPARATION AND PREPARATION OF THE ORE FOR TREATMENT

To separate successfully a mixture of magnetic and nonmagnetic particles a separator must fulfill the following requirements: It must make a proper presentation to the magnetic field of the mixture to be separated; it must bring about the attraction of the magnetic particles by a uniform field of suitable intensity; it must remove the magnetic particles so attracted from the field and cause their discharge from the separator.

PRESENTATION OF THE ORE MIXTURE TO THE MAGNETIC FIELD

A proper presentation of the mixture to be separated to the magnetic field is of primary importance. The ore must enter the field in such a manner that the individual particles will be free to be attracted according to their permeabilities. The ore must, therefore, be fed in a thin, even layer or sheet in order that the magnetic particles may not be hindered in their attraction toward the separating pole by intervening nonmagnetic particles. Theoretically, this layer should be but one particle deep, and in the separation of very feebly magnetic minerals this is carried out in practice. In the separation of magnetite, either natural or artificial, and the ferromagnetic minerals, a deeper feed is permissible, and consequently a greater capacity for the separator. When the feed is more than one particle deep the upward rush of magnetic particles toward the pole is apt to entrain nonmagnetic particles and carry them into the magnetic product. This loss is not a serious one with fields of suitable intensity; that is, with fields just sufficiently strong to attract the magnetic particles. In many separators provision is made for the removal of entrained particles from the magnetic concentrate by a blast of air or a jet of water while it is still under the influence of the field, or by the turning over

of the magnetic concentrate by causing it to pass from one pole to another of opposite polarity, which operation causes the magnetic particles to reverse their individual positions as they pass from one pole to the opposite sign.

The above considerations apply more particularly to the presentation of the ore mixture by conveyor belts, shaking plates, drums, and rolls. When the ore is presented to the magnets as a thin sheet falling past the poles, or when the separation is carried out under water, the feed being introduced in suspension in a stream of water, entrainment is a less serious difficulty.

It is also essential to good work that the feed be constant in amount and presented at a uniform distance from the separating pole, that all parts of it may be acted upon equally by the field, the intensity of which varies with the distance from the separating pole. As the intensity of the field is greatest, and the attraction consequently strongest, at the poles, decreasing directly with distance from them, it follows that the ore mixture should be introduced into the field as near the separating pole as is practicable.

The speed at which the ore is presented to the magnets, or the time the ore is under the influence of the field, is also a factor of prime importance. A definite length of time is necessary for the induction of magnetism, the time required for induction, and consequent attraction, varying inversely with the permeability of the mineral treated. That the speed of passage of the ore through the magnetic field must be regulated according to the permeability of the mineral separated is well illustrated by the following experiment.¹

A Mechernich separator was fitted with a thin conveyor belt passing between the poles of the magnets and so arranged that its speed might be varied at will. A mixture of minerals crushed to pass a 0.75 millimeter aperture was fed upon the belt and passed through the field at different speeds, the intensity of the field remaining constant. With the belt traveling 100 meters per minute only magnetite was removed by the magnet; at 70 meters rhodonite was partially removed, but ferruginous blende was quite unaffected; at 50 meters the rhodonite was completely removed but the blende still remained unaffected; at 40 meters per minute the blende was partially removed, and at 30 meters completely removed, the intensity of the field remaining constant throughout the test.

¹ "Elektromagnetische Aufbereitung," E. Langguth, p. 16.

Separators whose feed is presented to the magnets as a thin sheet falling in front of the separating poles are limited in their application to minerals of high permeability by the speed of the passage of the ore through the field.

ATTRACTION OF THE MAGNETIC PARTICLES

Magnetic attraction in performing a separation is opposed by some other force, usually gravity, the magnetic particles being lifted from the mixture under separation, or prevented from falling when fed, for instance, upon a revolving drum or cylinder. Gravity is often supplemented by some other agency, as centrifugal force, a blast of air or a stream of water acting against the magnetic attraction. The opposing forces of magnetic attraction and gravity, or centrifugal force, may be delicately adjusted, and separations effected between minerals having but slight differences in permeability.

The intensity of a magnetic field should be adjusted to the permeabilities of the minerals it is to be called upon to separate, and the field should be uniform throughout its separating zone in order that all portions of the ore fed may be equally acted upon. The air gap between the poles should be as narrow as is permitted by the conveying device and the ore sheet passing between them. The intensity of the field is determined by the ampere-turns of the exciting coils, the cross section, the length and the material forming the magnetic circuit, the distance between the poles and the shape of the pole pieces. The intensity of the field is controlled in practice by the current allowed to flow through the exciting coils and the distance between the poles, which in most separators is adjustable.

In magnetic separators, for minerals of feeble permeability especially, it is desirable to produce a dense field, or concentration of the lines of force along the separating zone. This may be obtained by beveling the pole pieces, by the device of two parallel magnetized cylinders, by a series of sharp projections on the separating pole or armature placed between the poles, by a laminated construction of pole pieces, or by an armature made up of alternate disks of magnetic and nonmagnetic material. The reason for this concentration is that the lines of force, in their passage across the gap of the separating field between the poles, seek to travel as

far as possible through the iron of the pole pieces or armature, as offering less resistance to their passage than air, resulting in a concentration of these lines of force where the air gap is shortest.

In separators employing but one separating field it is usual in order that no magnetic particle may escape attraction to introduce the feed at the strongest part of the field. Where more than one separating field is employed the ore should be passed through fields of gradually increasing strength. The effect of this is to remove minerals of different permeabilities as separate products, the most strongly magnetic by the first and weakest field, and the most feebly magnetic by the last and strongest field, and to prevent entrainment by avoiding the rush of strongly magnetic particles in a field of greater intensity than is necessary for their attraction. If separators having only one separating field are employed it is usually necessary to operate two or more machines tandem, with fields of progressively increasing intensity.

REMOVAL OF THE ATTRACTED PARTICLES FROM THE MAGNETS

The removal of the attracted particles from the magnets may be accomplished in several ways, depending upon the form and kind of magnet employed.

With separators which draw the magnetic particles against the magnet itself, these particles must be removed either by force or by interrupting the attraction by breaking the current on the exciting coils. With the old permanent-magnet separators, and with separators employing revolving magnets which do not change their polarity during revolution, scrapers or brushes must be resorted to in order to effect the removal of the attracted particles. With wet separators a jet of water may be employed. With electromagnets the exciting current may be automatically interrupted and the attracted particles allowed to fall; this is only possible with certain constructions and has not been in general use.

With separators which employ secondarily induced magnets to effect the separation these may be caused to pass beyond the field of the primaries and the attracted particles so dropped. A construction which has found extensive application employs a rotating cylinder, or armature, revolving between the primary poles to effect the separation. Here any point on the cylinder changes its polarity during revolution, and, at a position 90 degrees from the

separating zone, passes from one sign to the opposite, where the attracted particles are dropped. The cylinder may retain sufficient residual magnetism to hold strongly magnetic particles, even at the neutral point, in which case brushes or scrapers may be necessary to overcome the feeble attraction due to this cause.

In another construction advantage is taken of a property of the lines of force emanating from a magnet pole to concentrate upon points of magnetic material—in other words, employing secondarily induced magnetic points to remove the particles attracted by the primary magnet. Here the secondary magnet points are caused to pass out of the influence of the primary magnet, and, upon losing their magnetism, drop the attracted particles.

With separators which act by deflecting the magnetic particles from a falling sheet of ore adjustable diaphragms are used to divide the particles according to their degree of deflection from the verticle: any particles which may have become attached to the magnet poles may be dropped by breaking the current for an instant.

In separators which employ but one separating zone, the magnet, and means of removing the particles attracted by the same, should be so arranged that at least three different products are obtained—a concentrate, a middling and a tailing. This may be accomplished by gradually decreasing the strength of the field at the discharge and employing adjustable diaphragms to separate the products, the most weakly magnetic falling first and the most strongly magnetic last.

NECESSITY OF MAKING A MIDDLING PRODUCT

In the crushed ore submitted to any process for separation or concentration there is always a certain proportion of composite particles containing both the valuable mineral and waste, and this may not be avoided, even by excessively fine crushing, which is usually undesirable on account of the quantity of dust or slime produced. These particles are too rich to be allowed to go into the tailing, and too lean to be included in the concentrate; in any scheme of treatment, therefore, provision should be made for the recovery of such particles as a middling product. With magnetic separators it is usually advisable to carry on the first magnet encountered by the ore the lowest current which will separate the

pure magnetic particles, and a sufficient current on the last magnet to remove all the particles carrying a portion of the magnetic mineral. The result of this is a clean magnetic concentrate from the first magnet and a clean nonmagnetic product, with a middling product, for the retreatment of which provision should be made. Where separators are used which do not yield a middling product two machines should be operated tandem, the first delivering the magnetic product and the second a middling product and nonmagnetic discharge. The retreatment of middlings should, of course, be preceded by crushing, and where the ore is roasted for magnetism, a re-roast may also be necessary.

CLEANING MAGNETITE CONCENTRATE

In the separation of strongly magnetic minerals, especially on separators of large capacity, some provision should be made for cleaning the magnetic concentrate from entrained particles of waste. Such cleaning is accomplished in some separators by subjecting the concentrate to the repeated action of magnets of alternate polarity, the magnetic particles forming loops between the poles, which loops are broken and remade in passing from one pole to the next, and the nonmagnetic particles allowed to fall. In some other constructions a blast of air or jet of water is directed against the concentrate while held by the magnets and the entrained particles blown or washed out. Repeated treatment of the magnetic product as exemplified by the Edison deviation separator accomplishes the same result.

TREATMENT OF FINE MATERIAL

In crushing ore a variable amount of dust or slime is produced which may not be separated advantageously in conjunction with the coarser sizes. No especial difficulty is met in the separation of strongly magnetic minerals in a state of fine division either wet or dry; several wet separators are designed to treat ore which has been reduced to slime. The separation of feebly magnetic minerals in a state of fine division is a more difficult problem, as the capacity of the separator is cut down by the thinness of the ore layer which may be treated.

In dry-crushing plants the several crushing and separating

machines are usually housed in, and the flying dust removed from within the casings by exhaust fans and settled in a dust chamber. Dust is a source of danger to the workmen employed about the machines, and is a hindrance to the separation as well.

Electric machinery should be installed in a separate building, or dust-tight room, as magnetic dust collecting on magnetized bearings, etc., and on motors and dynamos is troublesome.

Nonmagnetic dust has a tendency to adhere to magnetic concentrate, which may be a source of loss, notably in the separation of magnetite and apatite. The dust may be removed by an air blast, or if the trouble be aggravated, resort may be had to wet separation.

If the separator is capable of fine adjustment and the ore is accurately sized, fine material may be separated readily, the capacity of the separator becoming less the lower the permeability of the magnetic mineral and the finer the material treated.

FEEDING DEVICES

A usual origin of separator feed is some form of roller or reciprocating feeding device placed beneath a feed hopper. Such feeder should be absolutely automatic, and so connected with the separator mechanism that, should the separator stop, the feeder will stop also. The feeder should spread a thin, even layer of ore upon the conveyor belt, shaking plate, drum or cylinder employed to transport the ore to the separating zones, and the rate of feed should be capable of regulation. The feeder should be so constructed that if a large piece of ore or other material should find its way past the screening apparatus the feeder will not stop, or necessitate stoppage, for cleaning out. It is usual to place a screen at the feeder, either above or below it, which will eliminate from the feed any oversize particles. In separators which employ conveyor belts to present the ore to the magnet the feeder should spread a uniform layer across the width of the belt, a couple of brushes being set at the edges of the belt to turn back toward the center any particles which might be shaken off and lost. If a feeder works poorly and does not distribute a uniform ore layer, a piece of canvas so fastened that its lower end will drag on the conveyor belt will be found useful to distribute the feed properly.

ADJUSTMENTS

A magnetic separator should be capable of easy adjustment to suit different ores. A rheostat should be provided to regulate the current on each magnet, and in separators in which the ore is introduced between the poles, the distance between the poles should be capable of adjustment. The amount of feed, the speed at which the ore is presented to the magnets, and the distance of the ore sheet from the separating poles should be capable of regulation, as well as the positions of diaphragms for dividing the separated products.

REQUIREMENTS A MAGNETIC SEPARATOR SHOULD FULFILL

Besides the ordinary requirements for any steadily operating machine—such as automatic operation, economy of power, durability and simplicity of construction, and visibility of working parts—a magnetic separator should be provided with a thin, even, regular feed that will present the ore at proper speed as close as may be to the separating poles of the magnets, which should have a concentrated and homogeneous field. The separator should make at least three products: magnetic concentrate, middling, and nonmagnetic tailing; should embody some provision for the cleaning of the magnetic concentrate from entrained nonmagnetic particles, if of high permeability, and should be capable of complete and accurate adjustment.

CAPACITY

The capacity of a magnetic separator is controlled by the kind of ore treated, by the percentage of magnetic product removed, and by the size to which the ore has been crushed. The effect of the size of the particles treated upon the separator capacity is well illustrated by the results obtained at Ems, Germany, in the removal of raw siderite from blende, where the average capacity of a Humboldt-Wetherill separator is 12 metric tons per 10 hours on material between $\frac{1}{2}$ and 4 millimeters, but only 3.5 metric tons per 10 hours on the fines passing a $\frac{1}{2}$ -millimeter aperture. In general, the more strongly magnetic the mineral removed the greater the capacity of the separator. The Ball-Norton belt sepa-

rator, operating on magnetite ore crushed through 6 mesh, has a capacity of about 20 tons per 10 hours. The capacity of the Dings or the Cleveland-Knowles separator may be taken as 1 ton per hour on roasted pyrite-blende concentrate of average grade. The above figures are taken from representative plants and are generalizations only; the capacities of the several separators are given, when it is possible to do so, in the descriptions of mills in the following chapters.

COST OF MAGNETIC SEPARATION

The cost of magnetic separation consists of the cost of preparing the ore for treatment plus a few cents per ton for supervision, excitation, and repairs. When the ore must be roasted the cost of this should, of course, be charged against the separation of which it is a prerequisite; the cost of roasting pyrite or siderite to the magnetic oxide should not, under average conditions, exceed 50 cents per ton in a well-equipped plant operated at capacity. Wherever it has been possible to do so, the cost of treatment has been given in the descriptions of mills in the following chapters.

TESTING

Where it is intended to employ magnetic separation a preliminary test of the ore is even more important than with other processes, on account of the difference in the magnetic behavior of the same mineral from different localities. Most manufacturers of magnetic separators maintain testing establishments, and will make small scale tests without charge except for any assaying that may be desired. Such tests, if yielding satisfactory results, should be followed by a large scale test under working conditions and personal supervision. While it is impossible to standardize schemes of testing to suit all ores, the following points should be covered: (1) An accurate sample should be used, sufficient in amount to partake of the nature of a mill run; in other words, to be indicative of the results which may be expected from commercial operation. (2) Determination should be made of the size to which the ore should be crushed to yield the best results. (3) If there is a choice between direct separation of the raw ore and separation after roasting for magnetism, both methods should be

tried and results compared; which might, perhaps, end in a decision to employ a combination of the two methods. (4) Separation of the ore with different amperages on the magnets, different belt or drum speeds, etc., should be made to determine the adjustments necessary to attain the greatest efficiency and capacity. (5) Determination should be made of the amounts and grades of all products separately, from which data any desired combination of results may be computed. (6) Accounting for all the values in the feed and determination of the sources of loss.

PREPARATION OF THE ORE FOR TREATMENT

The proper preparation of the ore for separation is as important as the selection of the best method of treatment. No machine should be called upon to treat material for whose separation it was not intended. The cost of crushing, sizing, and, where necessary, the cost of roasting the ore in preparation for magnetic treatment is many times as great as that of the actual separation, and the original outlay required for equipment is usually in the same proportion. These subjects are, with the exception of roasting for magnetism, fully treated in all the standard works on ore dressing, but a discussion of some of their features must be considered before entering upon the subject of the methods of treatment of the different ores amenable to magnetic separation. The subject of roasting for magnetism is taken up in the chapters describing the treatment of the ores to which it is applied.

CRUSHING

The object of crushing is to free the individual minerals in the ore, the ideal result aimed at being the production of a mixture of particles, each of which is composed of one mineral and nothing else. Such a result is never attained in practice, there remaining always, even after the finest comminution, mixed particles consisting of two or more distinct minerals.

Ores vary widely in the average size of the particles or crystals of their component minerals, and while one may liberate the bulk of its valuable constituent when crushed to 8 mesh, another ore, of precisely the same mineralogical composition, may require to be crushed to 30 mesh, or even finer. As illustration, at Herrang

the ore liberates the magnetite when crushed to 8 millimeters, while at Pitkaranta the ore is slimed before separation, which preparation yields but 44 per cent. of the magnetite as particles free from waste. It is apparent therefore that the fineness to which an ore should be crushed should be determined carefully in each individual case.

The best way to arrive at the size to which any particular ore should be reduced is to crush and test a sufficiently large sample of it to be indicative of the results which may be expected from treatment on a commercial scale. The ore should be crushed to a size determined by inspection, or by actual measurement, of the particles of the valuable mineral and objectionable impurities to be eliminated, and should be sized, separated, and the several products from each size assayed separately. The coarsest size from which a considerable proportion of clean concentrate may be separated and a clean tailing refused, will be, in general, the size to which the preliminary crushing should be carried, all further crushing being carried out upon the middling product.

Graded crushing is employed to minimize the amount of undersized particles produced in reducing the ore to pass a given aperture, the ore being broken in two or more stages, and the particles already fine enough screened out after passing each crushing machine, and not subjected to further comminution. The simplex method of crushing the ore in one operation to pass a given aperture is employed where the production of a large amount of undersized material is not counted a source of loss.

In mills where the ore is to be separated dry the question arises whether the ore shall be crushed wet and then dried, or dried before crushing. In the latter method, which is extensively employed, the machines should be housed in to prevent the escape of dust into the atmosphere, and an exhaust fan should be provided, with connections to the various machines and a settling chamber, or bag house, where the dust may be collected. The dust from crushing ore is extremely injurious to the workmen exposed to it, and every precaution must be taken to prevent its escape into the atmosphere of the mill. The workmen are required to wear respirators at many plants where there is danger from so-called lead poisoning, and also are shifted from one position to another in order to reduce the danger to any one man.

SIZING

While, theoretically, the size of a particle of magnetic material should have no effect upon the attraction of a magnet for it, results from practice indicate that small particles are more easily influenced than large particles. It is difficult, for instance, to separate magnetic minerals from each other when the more weakly magnetic mineral is present as the smaller particles. Where there is a wide difference between the magnetic permeabilities of two minerals in a mixture, sizing is usually unnecessary. The more closely the permeabilities of the minerals in a mixture approach each other the closer must the sizing be carried out, and the greater the number of sizes treated separately. A further reason for the close sizing of such mixtures is that with an ore layer of evenly sized particles closer adjustment may be made in the distance of a magnet from the ore stream. In most instances, with the exception of the separation of two or more minerals of similar permeability, a reasonably close sizing before separation gives the best results. Sizing of the finer particles produced by crushing is easily effected by water classification, but as the ores separated wet usually carry magnetite or artificial magnetite as their magnetic constituent such classification is rarely necessary. An analogous method of classification has been extensively adopted in Europe, where a current of air is employed as a classifying medium in the place of water.

SPECIFIC-GRAVITY CONCENTRATION

The concentration of ores by specific-gravity methods is a usual preliminary to magnetic separation. With mixtures which require roasting or calcination to render them magnetic, the advantages of such preliminary treatment are too obvious to require mention.

DRYING, COOLING, ETC.

In dry magnetic separation it is essential that the ore be quite dry, as any appreciable moisture causes the particles to adhere to one another and precludes good work. Ore, as it comes from the mine, can rarely be separated without drying, still less the products

of wet concentration, even after drying in the air. It is usual to dry the ore after the coarse crushing and before the fine classification, as moist ore clogs the screens. Abroad, a scheme for drying the ore during classification has been successfully carried out: trommels are fitted with jackets through which waste steam is passed, and the ore dried as it passes through.

Care must be taken in drying ores not to subject them to sufficient heat to render magnetic any minerals which are not intended to go into the magnetic product; in the case, for example, of some magnetic-blende ores carrying pyrite, a quite low heat is sufficient to form a film of magnetic oxide on the pyrite and render it sufficiently magnetic to be attracted by the intense fields employed for the separation of magnetic blende.

Among the usual forms of drying furnaces are: (a) The revolving cylinder with inclined axis, through which gases from a combustion chamber are passed; (b) modifications of the shaft furnace; (c) troughs heated from without by steam or by hot gases flowing through them, and fitted with a chain or other conveyor to transport the ore. The several types of furnace will be taken up in connection with the plants with which they are employed.

Provision should be made for cooling roasted ore, and in some cases ore from drying furnaces, before allowing it to come into contact with belts, etc., as even a low heat, if sufficiently prolonged, will cause a deterioration in the materials of which they are made. Expedients resorted to for cooling ore comprise transportation by conveyors in which the ore is stirred and exposed to the air until it is cool, cooling floors upon which the ore is spread, contact with cooled surfaces, water-jacketed revolving cylinders and others.

With separators which employ high-intensity fields it is advisable, and often imperative, to pass the ore through a field of low intensity to remove any strongly magnetic particles it may contain before feeding it to the separator proper. Strongly magnetic particles introduced into a field of high intensity will be so strongly attracted as to tear belts, and, if in sufficient amount, to bridge across between the poles and stop the separator.



III

SEPARATORS FOR STRONGLY MAGNETIC MINERALS

MANY classifications based on the method of treatment, on differences in construction, etc., have been suggested to include the different types of magnetic separators; separators with stationary magnets, and those whose magnets revolve; separators in which the ore is attracted directly against the magnet, and those which interpose a nonmagnetic belt or drum between the magnet and the particles attracted; separators which lift the magnetic particles from the mixture, and those which deflect the magnetic particles from a falling sheet of ore, and various others. The classification of most value is that based upon the types of material the different separators are suited to treat. For this reason the only classification attempted here is to distinguish between the separators designed to remove ferromagnetic minerals and those designed to treat such feebly magnetic minerals as raw siderite, limonite, etc. A number of separators have been designed to treat a finely divided feed only, and others for use as cobbing machines. The sizes of feed to which the several machines are suited will appear in the descriptions of the individual separators.

Descriptions have been published of a large number of separators whose principal claim to interest is an historical one; the only machines here described are those which are at present of commercial importance.

THE BALL-NORTON BELT SEPARATOR

This machine employs the principle of a series of magnets of alternate polarity to effect a thorough turning over of the ore while in the influence of the magnetic field, thus permitting entrained particles of waste to fall from the concentrate.

The ore is fed from a hopper by a feed roll upon a horizontal belt which serves to present it to the magnets from beneath. The

magnetic particles are lifted from this feed belt by the magnets and held against a take-off belt running in the same direction and interposed between the ore stream and the magnet poles. The take-off belt is run at a greater speed than the feed belt in order to carry the ore past the magnets in a thinner layer. The belts are made of rubber-covered canvas, and means are provided to

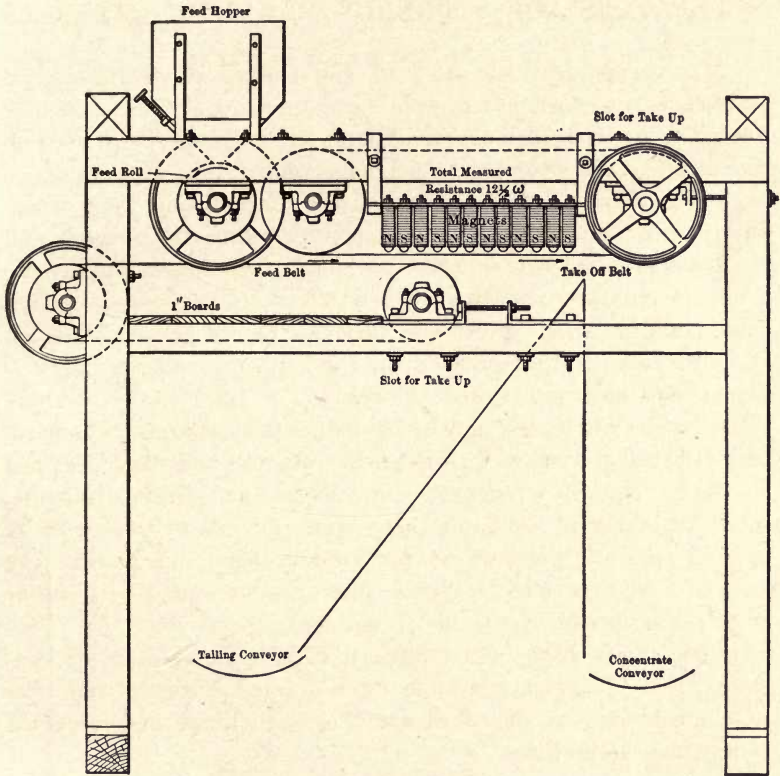

FIG. 1.—BALL-NORTON BELT SEPARATOR.

alter the speed of belt-travel to suit different ores. As the magnetic particles are held against the take-off belt, and by its motion carried past the poles alternately opposite in sign, the loops of magnetic particles are broken and reformed as they pass from one pole to the next, permitting entrained particles to fall from the concentrate into a tailing compartment, into which the non-magnetic material remaining on the feed belt also falls. The

magnetic concentrate is carried past a partition and is dropped from the last magnet into a separate compartment.

The series of magnets is made up of 12 poles, those of opposite sign being adjacent, all controlled, in the type machine, by one rheostat. By dividing the poles into two series by suitable connections, and employing an additional rheostat, two sections of the field of different intensity may be obtained.

The capacity of this machine is from 20 to 35 tons per hour of magnetite ore crushed to pass a $\frac{1}{4}$ -in. aperture.

THE "MONARCH," OR BALL-NORTON DOUBLE-DRUM SEPARATOR

This machine embodies the same principle of magnet construction as the Ball-Norton belt separator. It consists of two revol-

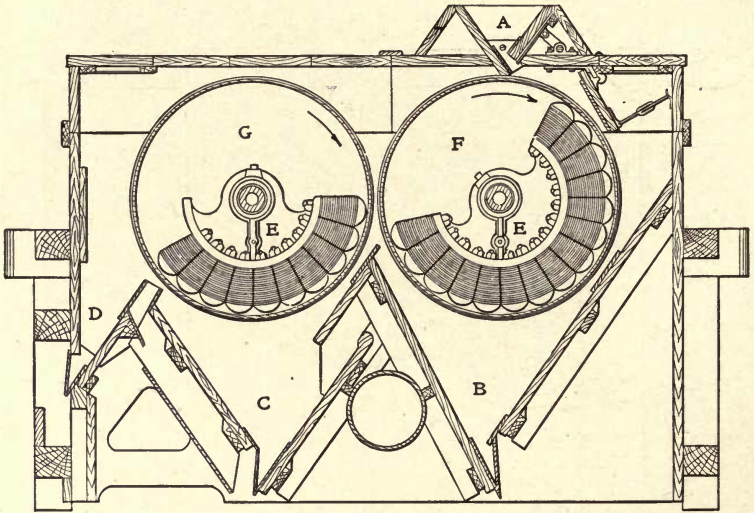

FIG. 2.—THE BALL-NORTON DOUBLE-DRUM SEPARATOR.

A, Feed hopper; B, tailing compartment; C, middling compartment; D, concentrate chute; E, magnets of which the adjacent poles are of opposite sign; F, rougher drum; G, cleaner drum.

ing drums with nonmagnetic surfaces placed parallel and close together, within each of which is fixed a composite electro-magnet made up of adjacent poles of opposite sign.

The ore is fed at the top of what may be termed the rougher drum, in passing around which the nonmagnetic particles are

thoroughly eliminated, falling into a hopper below. The magnetic particles are held against the drum by the magnets within, and while passing the poles of opposite sign the loops of magnetic particles are broken and reformed, freeing the nonmagnetic particles, which are removed by a combination of gravity, centrifugal force, and the effect of a blast of air impinging upon the surface of the drum in a direction opposite to its rotation. At a point just below the horizontal diameter of this drum the ore passes beyond the influence of the magnets and is thrown, by centrifugal force, against the face of the adjacent cleaner drum where it is caught and held by the magnets. The cleaner drum revolves at a greater speed than the first drum encountered by the ore and is furnished with weaker magnets; particles of inferior permeability, which were held by the rougher drum, are here thrown off into a middling hopper; the concentrate is carried farther and thrown into a chute after passing beyond the influence of the last magnet pole. The rougher drum makes 40 revolutions per minute and the cleaner drum 50; the magnets in the rougher drum take 10.5 amperes and those in the cleaner drum 13 amperes.

The capacity of this separator, with drums 24 ins. in diameter by 24 ins. face, is from 15 to 20 tons per hour of magnetite ore, crushed to pass 16 or 20 mesh. The power required is from $\frac{1}{2}$ to $\frac{3}{4}$ H. P. for operation, and from 1 to 1.5 E. H. P. for excitation.

THE DELLVIK-GRONDAL SEPARATOR

This type of separator was designed for the treatment of fine material. It consists of a composite electro-magnet of cylindrical form which revolves about a vertical axis. This cylinder, of cast iron, carries a series of six exciting coils, wound in circular grooves cut around its circumference. These coils are separated from each other 60 mm., and are so wound as to give fields of progressively increasing strength from top to bottom opposite the iron spaces between the coils, which form the separating surfaces.

The ore, in suspension in water, is fed from a launder against the topmost magnetic ring. This launder, which is curved to cover about 90 degrees of the magnetic cylinder, is supplemented by four other similar launders below it, which serve to catch and return against the drum any material thrown off by its revolution.

The magnetic particles stick to the rings between the coils, those not held by the first ring being caught and held by one of the lower rings, each of which has a field of greater strength than the ring next above it. Nonmagnetic particles are washed from the concentrate by a stream of water which plays against the cylinder. By the revolution of the cylinder the magnetic particles adhering to it are carried opposite a wooden cylinder, carrying secondary magnets, which is mounted parallel to the magnetic cylinder, and which revolves in the opposite direction. This wooden cylinder is studded with a number of iron pegs so placed

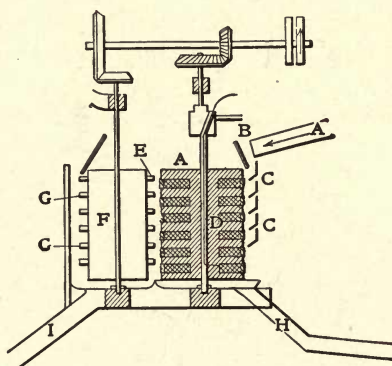

FIG. 3.—THE DELLVIK-GRONDAL SEPARATOR.

A, Feed launder; *B*, splash board; *CC*, circular launders serving to present the ore in suspension in a stream of water against the magnetized cylinder; *D*, the separating cylinder; *E*, exciting coils; *F*, wooden take-off cylinder; *GG*, secondarily induced take-off magnets; *H*, tailing launder; *I*, concentrate launder.

as to come opposite the magnetic rings of the separating cylinder. These pegs, distant 5 mm. from the magnetic rings, concentrate the lines of force from these rings upon their points, giving rise to local fields of greater intensity than the primaries, and so cause the magnetic particles to leap across the gap and attach themselves to the pegs. By the revolution of the wooden cylinder these pegs are carried beyond the influence of the primaries, lose their secondarily induced magnetism, and drop their burden of magnetic particles, which removal is aided by a stream of water.

The capacity of this machine is from 30 to 45 metric tons per 24 hours of magnetite ore, crushed to pass a 1-mm. aperture. The magnets require 6 amperes at 31 volts. The separating cylinder makes 25 R.P.M. and the take-off cylinder 225 R.P.M.

THE GRONDAL TYPE II SEPARATOR

This separator consists of two iron disks fastened, 60 mm. apart, to a vertical standard, the space between the disks being occupied by the exciting coils. The disks and coils are stationary. This circular magnet is covered with a brass ring, around

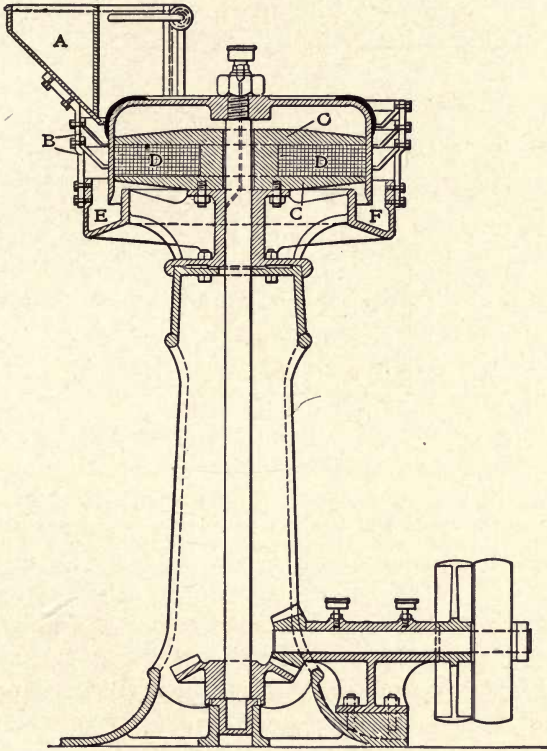

FIG. 4.—THE GRONDAL TYPE II SEPARATOR.

A, Feed hopper; *B*, feed launders; *CC*, soft iron disks; *D*, exciting coils; *E*, tailing discharge; *F*, concentrate discharge.

the periphery of which a series of iron strips are mounted; and which are magnetized from the disks as long as they are adjacent to them. The distance between the disks and the brass ring is so varied that the iron strips are magnetized during one half of the revolution only. The ore is slimed and fed, in suspension

in water, against the brass ring through launders similar to those employed in the Dellvik-Grondal separator. The magnetic particles stick to the iron strips during half the revolution, are thoroughly washed with a jet of water, and, on passing beyond the influence of the magnetic disks, are washed off the strips by a jet of water. The iron strips are coated at the top with a layer of lead and antimony. This layer is thickest at the top of the strip, gradually shading off until at the bottom of each strip the ore comes into direct contact with the iron; this is done to give a field of steadily increasing strength on each strip in the direction of passage of the ore.

THE GRONDAL TYPE III SEPARATOR

This separator consists of a fixed electro-magnet with hatchet-shaped pole pieces enclosed in brass drums which revolve at 80 revolutions per minute. The surfaces of the drums are fitted with strips of iron which form secondary poles, and against which the magnetic particles are attracted. The ore is introduced into a tank beneath the revolving drum, which is suspended just above the level of the water; the sharp edges of the pole pieces give rise to a concentration of the lines of force which serves to lift the particles of pure magnetite out of the water and against the drum, where they stick to the secondary magnets and are carried by the revolution of the drum out of the field and discharged into a launder. The particles forming the middling product are not lifted from the water, but are sufficiently attracted to separate them from the waste and are discharged through an overflow at the side of the tank. The nonmagnetic particles fall to the bottom of the tank and are discharged through pipes. Generally two drums are combined in a twin machine which requires 2 H.P. for operation, and 3.5 amperes at 110 volts for excitation of the magnets. The capacity of this machine is 50 tons in 24 hours.

THE GRONDAL TYPE IV SEPARATOR

This type of separator was designed to deliver magnetite concentrate as dry as possible from a wet separation. It consists of a brass disk revolving at 1450 R.P.M. beneath an electro-magnet whose pole pieces taper to an edge at their lower extremities. The

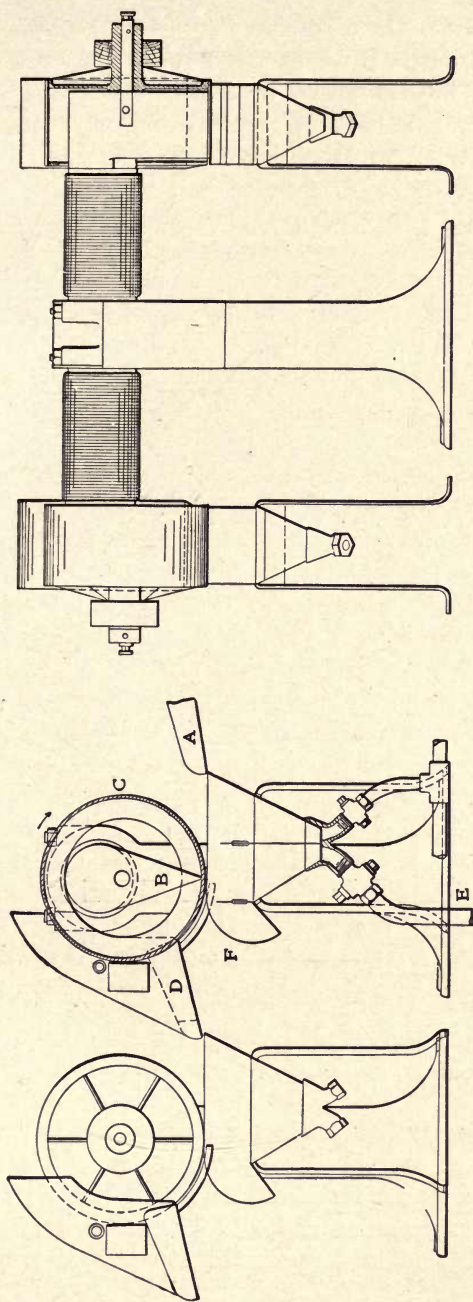

FIG. 5. — GRONDAL TYPE III SEPARATOR; TWO MACHINES PLACED TANDEM.

A, Feed launder; *B* magnet pole; *C*, revolving brass drums; *D*, concentrate discharge; *E*, tailing discharge; *F*, middling discharge.

slimed ore is delivered by a launder into a tank beneath the brass disk, and the magnetic particles are drawn up against the disk, from which they are thrown off by centrifugal force in a nearly dry state. About 1 H.P. is required for operation, and 3.5 amperes at 110 volts for excitation of the magnet.

THE GRONDAL TYPE V SEPARATOR

This machine consists of a brass drum which revolves on a horizontal axis and encloses a series of magnets of alternate polarity of the Ball-Norton type. The difference between the working of this machine and that of the Ball-Norton consists in

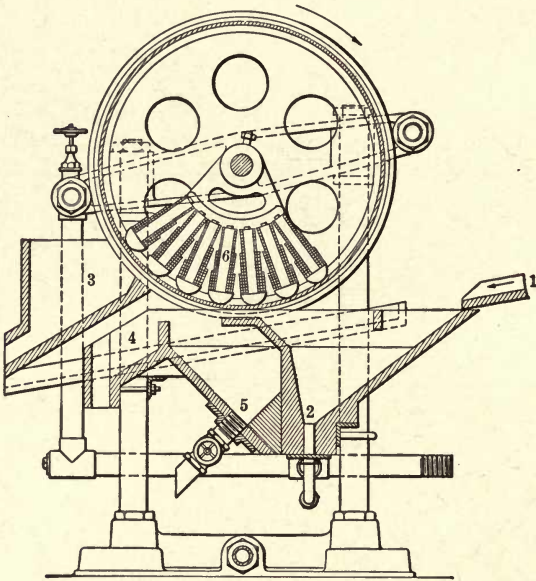

FIG. 6.—THE GRONDAL TYPE V SEPARATOR.

1, Feed; 2, wash water; 3, concentrate; 4, middling; 5, tailing; 6, magnets.

feeding the finely crushed ore in the former case, in a stream of water into a tank beneath the separating drum, from which it is raised by the magnets against the drum. This machine requires 1 H.P. for operation and 4 to 5 amperes at 110 volts for excitation. It is said to have treated 100 tons of crude ore in 24 hours.

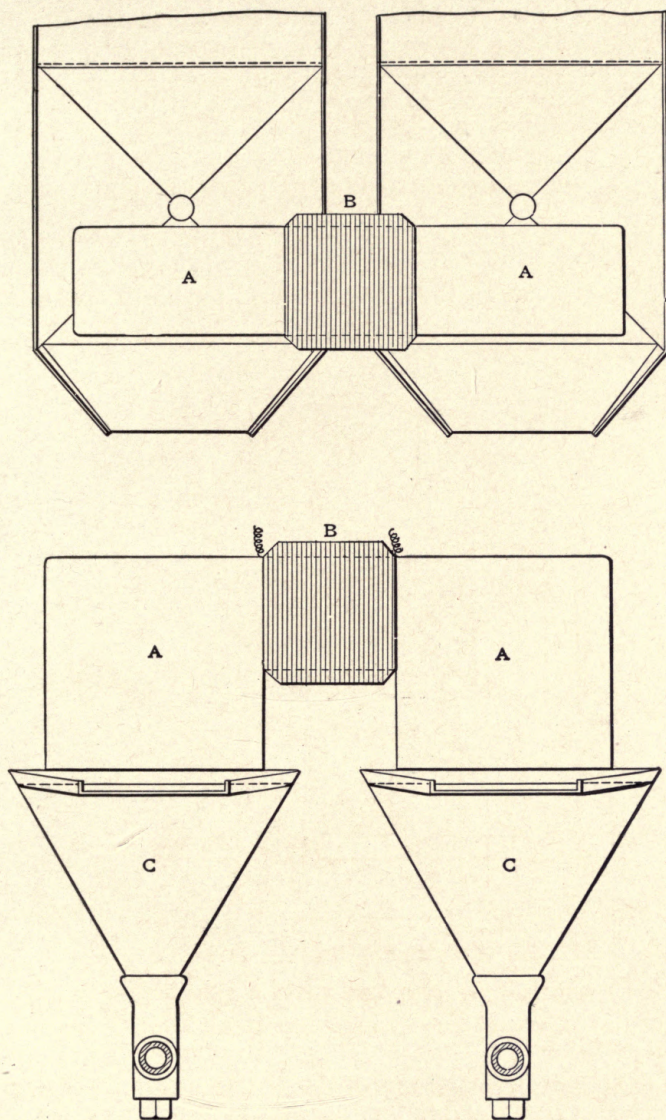

FIG. 7.—THE GRONDAL SLIME SEPARATOR.

A, Magnets; B, coils; C, settling tanks.

THE GRONDAL SLIME SEPARATOR

This is a stationary electro-magnet with two beveled-edge pole pieces which are suspended above V-shaped settling tanks. The slime, in suspension in water, is introduced at one side of the tank in a shallow stream which flows beneath the pole pieces to a similar discharge at the opposite side. The current on the magnet, which is suspended close to the water level, but not dipping into the water, is regulated so as to be just too weak to lift magnetic particles out of the water. The magnetic particles form

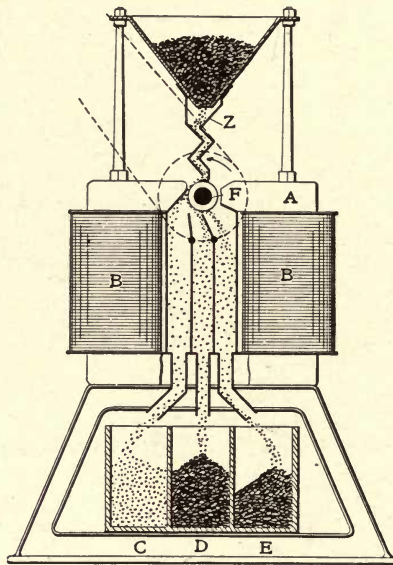

FIG. 8.—THE WETHERILL TYPE F SEPARATOR.

A, Magnet poles; B, coils; C, tailing; D, middling; E, concentrate; F, rotating armature; Z, feeding device.

bunches in the water beneath the pole pieces and fall to the bottom of the tank, from which they are discharged through a pipe. This apparatus is frequently employed for dewatering the pulp from ball mills, in which case a stream of clear water is introduced into the tank at the bottom; the sand falls to the bottom and is discharged through a pipe along with the bunches of magnetic slime collected beneath the magnets. By regulation of the

velocity of the stream of pulp and the amount of clear water added, the size of particles carried over the waste discharge may be adjusted to suit the ore under treatment.

THE WETHERILL TYPE F SEPARATOR

This machine comprises a separating armature, built up of alternate disks of magnetic and nonmagnetic material. Upon revolution between the primary magnets secondary poles are set up at

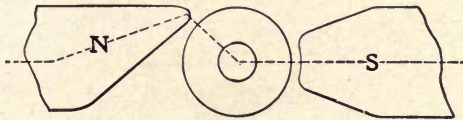

FIG. 4

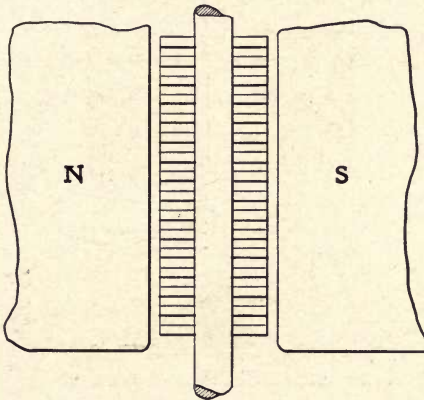

FIG. 9.—DETAILS OF MAGNET ROLLER, WETHERILL TYPE F SEPARATOR.

the edges of the magnetic plates, or disks, of the armature, focusing the lines of force from the primaries and causing magnetic particles to stick to the armature until carried beyond the influence of the primary poles. The waste drops off the armature into a receptacle, while the magnetic particles are held until the neutral point is reached, where the magnetism of the disks changes from plus to minus, when they fall into a receptacle. The change in magnetism is gradual, so that by means of suitable partitions, sev-

eral products may be made on the same separator, the strongly magnetic being the last to fall from the armature.

The machine is built in one size only, with 30-in. poles, but the magnets are wound for various strengths of current. The capacity of the machine is large: the makers claim that 400 tons are put through these machines at Mineville, N. Y., in 24 hours.

THE FROEDING SEPARATOR

This separator consists of a round table of brass 3 mm. thick, and 1.45 meters in diameter, which slopes from center to circumference. Beneath this separating surface, which revolves, there is a system of 12 stationary magnets, arranged radially to cover $\frac{6}{7}$

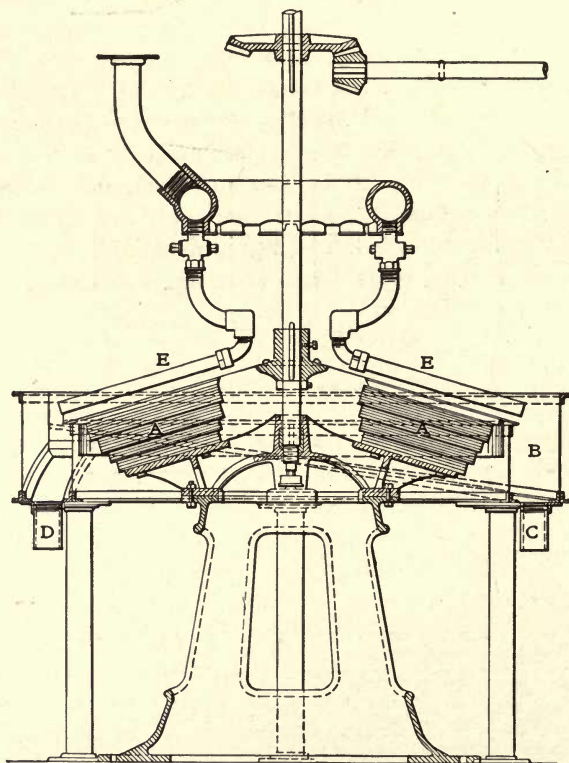

FIG. 10.—THE FROEDING SEPARATOR.

A, Magnets; B, revolving table; C, tailing discharge; D, concentrate discharge; E, wash water pipes.

of the surface of the table; beneath the sector, representing $\frac{1}{4}$ of the area, there is a gap without magnetic attraction. The magnets are of alternate polarity and have their corners beveled to concentrate the lines of force at the periphery, and are spaced 50 mm. apart. Above the table is a series of movable perforated pipes, which deliver a spray of wash water on the ore under separation. The ore is delivered in a stream of water at the center of the table, and spreads out in a layer of decreasing thickness toward the periphery. The magnetic particles are held against the surface of the table and carried by its revolution to the sector where there is no magnet and here washed off. The nonmagnetic particles are washed off the table by the wash water from the pipes. The alternate polarity of the magnets causes the magnetic particles to turn over in passing from one magnet to another, the entrained waste liberated during this process being washed off by the sprays from the pipes, which are hung 40 mm. above the table. The two products are caught in separate launders at the periphery of the table. Magnetic particles are prevented from being washed off the table by the concentration of the magnetic field due to the beveling of the magnets mentioned before. The capacity of the machine is 2 metric tons per hour, at 10 R.P.M.; 150 liters of wash water are used per minute; $\frac{1}{2}$ H.P. is sufficient to operate the moving parts, while the magnets require 8 amperes at 100 volts for excitation.

THE ERICKSSON SEPARATOR

The construction of this machine is best understood from the accompanying figures. The magnets *A* and the coils *C* revolve about the shaft *B*. The magnet wheels are divided into 21 spokes, the spokes on each side being opposite one another. Between the two halves of the magnet is an annular slot, extending completely around the circle; the walls of this slot are thin sheets of nonmagnetic metal, and this space is filled with water to the height of the axle. The ore is fed by a stream of water at *E*; the magnetic particles form bridges in the fields between the opposite spokes, and are carried around by the revolution of the magnets. At *K* a launder is introduced into the slot, receiving the bridges of magnetic particles, which are washed out of the machine through this launder by a strong jet of water. The magnetic

material is washed, and waste particles removed, by sprays of water playing on the bridges across the slot between the time it is lifted above the water level and the time of its encountering the discharge launder. The nonmagnetic particles fall to the bottom of the tank and are discharged at *H*. A float, *J*, is connected with the discharge opening, *H*, by a rod; when the water rises above the proper level, because of the introduction of the

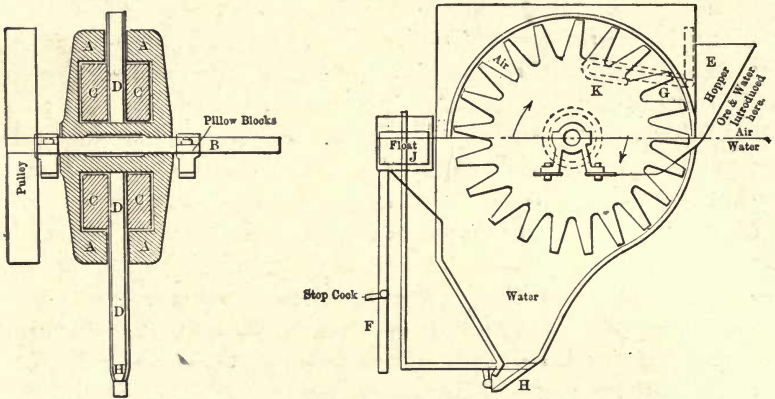

FIG. 11.—THE ERICKSSON SEPARATOR.

A, Revolving magnet spokes; *B*, axle; *C*, coils; *D*, separation chamber; *E*, feed launder; *F*, slime discharge; *G-K*, concentrate discharge; *H*, tailing discharge; *J*, automatic discharge to maintain constant water level.

feed, the discharge gate at *H* is opened and the surplus water, along with the waste, flows from the machine. The capacity of this separator is about 2 metric tons per hour; the magnets take 20 amperes at 110 volts. Nonmagnetic slimes which do not settle readily are drawn off from time to time through the pipe *F*.

THE FORSGREN SEPARATOR

This separator comprises five independent separating zones which may be employed, if desired, on different ores and with different strengths of field. This machine consists of two concentric brass rings mounted with soft-iron secondary poles attached to a spider which, by revolution about a vertical axis, causes the rings to pass between the poles of five fixed electromagnets spaced 72 degrees apart. The ore is fed in the annular

space between the brass rings at points opposite the primary magnets; the magnetic particles in the ore attach themselves to the secondary magnets, while the nonmagnetic particles fall past them into a tailing chute. As the rotation of the brass rings carries the secondarily induced magnets past the fixed primaries they lose their magnetism and the attracted particles fall, first the feebly magnetic particles, which drop into a middling chute, and finally the strongly magnetic particles which drop into a concentrate chute.

From $\frac{1}{2}$ to 3 H.P. is required for operation, and from 3 to 3.5 amperes for the excitation of each primary magnet. The capacity

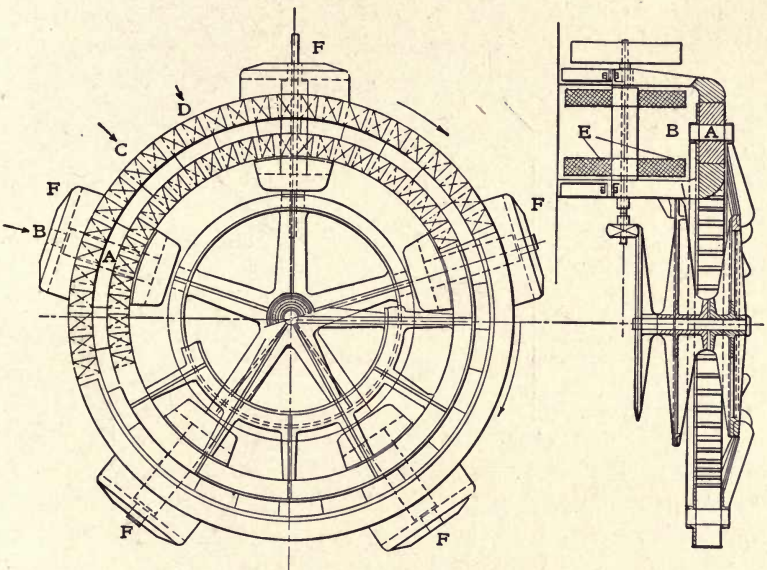

FIG. 12.—THE FORSGREN SEPARATOR.

A, The annular space in which the separation takes place; B, tailing discharge; C, middling discharge; D, concentrate discharge; E, coils; F, fixed primary magnets.

of this machine varies with the size of the material treated: operating on magnetite ore crushed to 1.2 mm. it handles $1\frac{2}{3}$ metric tons per separating zone per hour; arranged for cobbing, it handles 2.5 metric tons per separating zone per hour for sizes up to $1\frac{3}{8}$ ins. The brass rings rotate at a speed of from 5 to 10 R.P.M.

THE EDISON SEPARATOR

This machine consists of a series of bar magnets in front of which the ore is allowed to fall in a thin sheet. The magnetic particles are attracted sufficiently to alter their trajectory but

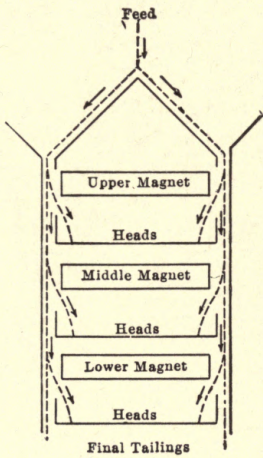

FIG. 13.—PRELIMINARY MAGNETS,
EDISON SEPARATOR.

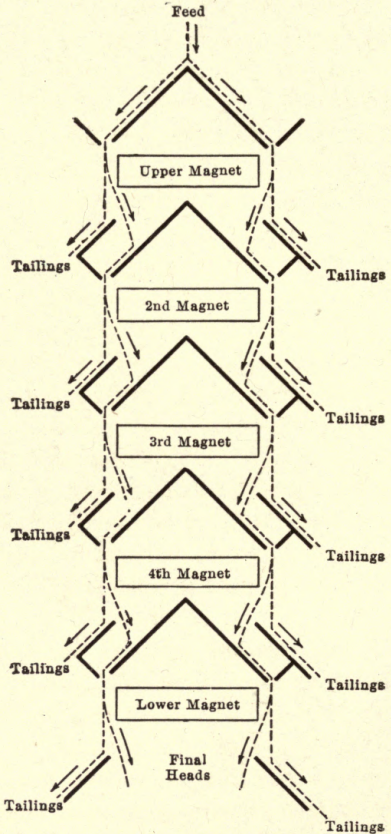

FIG. 14.—CLEANING MAGNETS,
EDISON SEPARATOR.

not enough to draw them against the magnets. The falling sheet thus divided is caught in separate chutes or hoppers. The current on the magnets and the distance from the falling ore sheet to the face of the magnet are capable of adjustment to suit different ores.

A single magnet may be employed to effect the separation, or a number of units in series. In the mill at Edison, N. J., two systems were employed, the first to produce a clean tailing product and a second for the cleaning of the concentrate from the first magnets.

The *preliminary magnets* are arranged as shown in Fig. 13. The ore is fed past each end of the magnets, the magnetic product passing from the machine from each magnet, while the nonmagnetic particles are successively re-treated. This arrangement produces a clean tailing with very little loss in magnetic material. The magnets are 12 ins. long, 4 ins. thick and have a separating face 4 ft. 6 ins. wide. The cores are of cast iron (as the magnets are never saturated) and are wound with No. 4 copper wire. The three magnets are wired in series, and each has a different winding, the upper with the fewest and the lower with the greatest number of turns, giving separating fields of constantly increasing strength in the direction of travel of the ore. The magnets are excited by 15 amperes at 80 volts. The capacity of the series is 16 tons per hour of ore crushed to pass 0.06 in. A second series of magnets is used to re-treat the magnetic product from the above-described machine after drying and re-crushing. The arrangement is the same, but the magnets are 8 ins. long, and are wound with No. 6 wire: the capacity is 2.25 tons per hour on material crushed to pass 0.02 in.; tailings from the last magnet are waste. These magnets take 10 amperes at 120 volts.

The *cleaning magnets* are arranged in a series of five units, and treat the concentrate from the preliminary magnets after the removal of dust. With this machine the object is the production of a clean magnetic product, and the magnets are arranged as shown above to repeatedly re-treat the magnetite, the tailing being discharged after passing each unit. The magnets are 4 ins. long, 2 ins. thick and have a separating face 4 ft. 6 ins. wide. They all have the same winding of No. 6 wire, are connected in series and take 17 amperes at 100 volts. The tailing from the upper magnet in this series is run to waste, while the tailing from the four lower magnets is regarded as middling and sent back for re-treatment. The capacity of this machine is about 0.9 ton per hour.

THE EDISON BELT SEPARATOR

This machine consists of a belt 7 ft. wide which travels over two pulleys revolving about horizontal axes in the same vertical plane. Behind the side of the belt which travels upward are placed several electro-magnets staggered across the belt, adjacent magnets being of opposite polarity. The ore is fed against the belt opposite the lowest magnet, the magnetic material adheres to the belt and is carried upward and across it as a result of the arrangement of the poles of the magnets; the nonmagnetic particles fall from the belt. The material fed is in a fine state of division and forms tufts on the surface of the belt which turn over and over in their passage across and up the belt, liberating any particles of entrained waste. The upper magnet extends

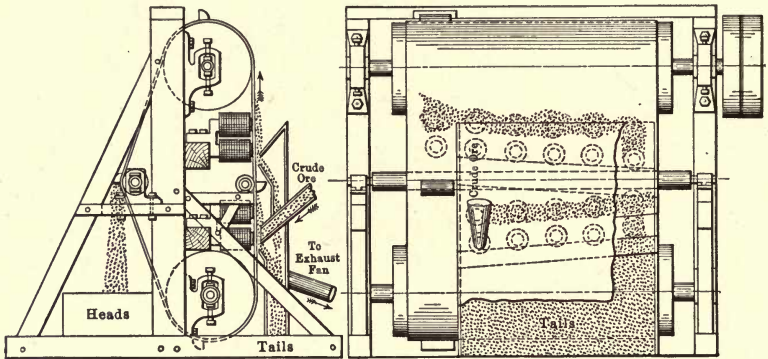

FIG. 15.—THE EDISON BELT SEPARATOR.

further toward the edge of the belt than the lower magnets, and the magnetic particles are dropped from it into a series of small buckets riveted to the edge of the belt, and so discharged from the machine. This separator is designed for the removal of non-magnetic particles from a finely divided feed.

BALL-NORTON SINGLE-DRUM COBBING SEPARATOR

This machine is used for cobbing ores which are not necessarily dry; the ore fed is coarse ($1\frac{1}{2}$ ins.) and the separator puts through a large tonnage with the idea of making a clean concen-

trate of the pure magnetite pieces, while the tailing is re-treated on other separators after crushing. The separator consists of a drum with nonmagnetic surface which revolves about a composite magnet in the form of a sector of a circle. The attraction is exerted by 16 electro-magnets attached to a spider and mounted

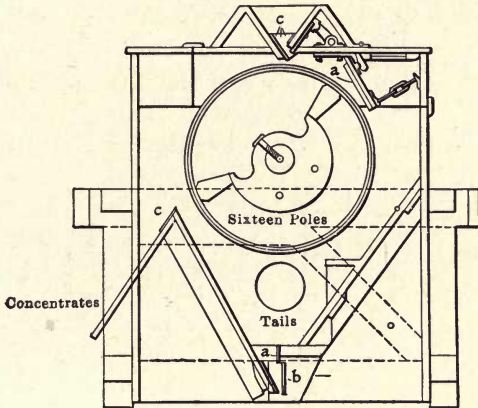

FIG. 16.—THE BALL-NORTON SINGLE-DRUM SEPARATOR.

on the shaft of the drum. The magnets are stationary and cover a little more than 180 degrees of the circumference of the drum. They are of alternate polarity, which causes the ore to turn over as it is carried past each of the 16 poles by the revolution of the drum. This turning over permits the nonmagnetic particles to drop off the drum into the tailing hopper. The ore is fed near the top of the drum, and the strongly magnetic pieces are carried past the tailing hopper and thrown off by centrifugal force as they pass beyond the influence of the last magnet, falling into a concentrate chute. The amperage is regulated so as to pick out the pure pieces of mineral only, allowing composite pieces of ore and waste to go into the tailing to be separated after crushing.

THE WENSTROM SEPARATOR

This machine consists of a drum made up of alternately magnetic and nonmagnetic bars, which revolves about a horizontal axis and encloses a stationary magnet. The stationary magnet is cylindrical in form and is placed eccentrically within the revolving

drum; it carries four circular projections, or ridges, between which are wound the exciting coils, so connected that adjacent projections have opposite polarity. The surface of the drum is made up of soft iron bars with nonmagnetic spaces between them usually filled with strips of wood. The bars have projections from the inner surface of the drum which engage the projections from the magnet, making them practically prolongations of the poles of

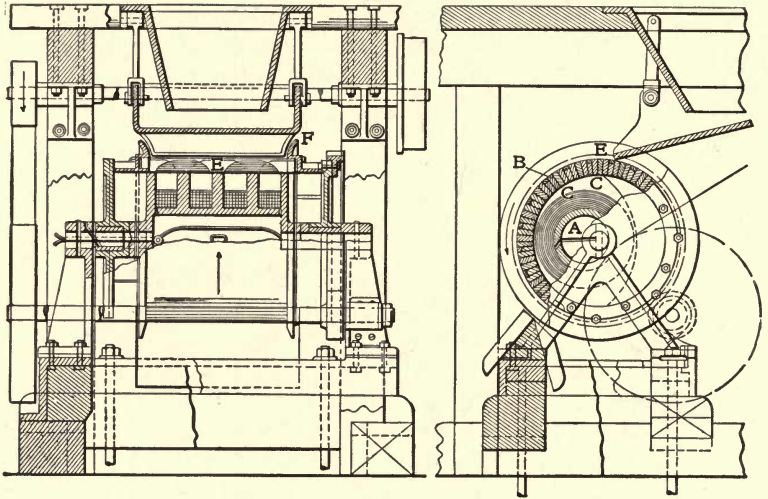

FIG. 17.—THE WENSTROM SEPARATOR.

A, Fixed electro-magnet; *B*, separating surface made up of alternate strips of iron and wood; *C*, projections of magnet which engage the iron strips on the surface of the drum; *D*, exciting coils; *E*, revolving drum carrying the magnetic strips; *F*, feeding chute.

the magnet. The projections on alternate bars engage alternately the north and south poles of the stationary magnet, giving adjacent bars opposite polarity. The projections from the magnet are cut away on one side of a vertical diameter of the drum. The ore is fed at the top of the drum and is carried forward by its revolution; the magnetic pieces are held by the magnetic bars until the vertical diameter is passed, when they fall into a hopper upon the bars becoming demagnetized. The waste falls into a hopper in front on the drum. This machine is designed to treat lump ores which need not necessarily be dry. It is made in two sizes: the larger size is capable of separating 4-in. lumps, is 27 ins. in diameter and 24 ins. across the face, takes 15 amperes at 110

volts and has a capacity of from 5 to 7 tons per hour. A smaller size has a capacity of 3 tons per hour on ore 1.5 ins. maximum size.

THE NEW WENSTROM COBBING SEPARATOR

This is a modification of the machine above described. The distance between the ribs making up the surface of the drum of this separator is varied to suit the size of the ore to be treated. For the finer sizes, from $\frac{1}{8}$ to $1\frac{1}{8}$ ins., the drum is covered with a sheath of German silver. For treating coarse ores the drum is made in diameters from 2 ft. 10 ins. to 3 ft. 4 ins.; the length

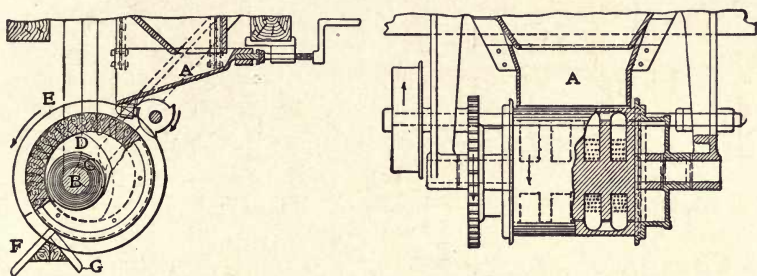

FIG. 18.—THE NEW WENSTROM COBBING SEPARATOR.

A, Feeding device; B, magnet core; C, coils; D, projections of magnet which engage iron strips on the drum; E, revolving surface of drum; F, tailing discharge; G, concentrate discharge.

of the drum face is 2 ft. Recently some of these machines have been built with twice this width and divided into two sections, one side for coarse and the other for fine material. The drums make from 16 to 20 revolutions per minute; the electro-magnet requires from 15 to 20 amperes at 110 volts for excitation. The capacity of this separator varies from 5 to 10 tons of crude ore per hour.

THE GRONDAL COBBING SEPARATOR

resembles the Wenstrom machine, the drum being made up of ribs alternately iron and brass. The former are $\frac{1}{2}$ in. wide and the latter $\frac{3}{8}$ in. wide. The drum is operated at a speed of 30 revolutions per minute.

THE DINGS SEPARATOR

This separator consists of an inclined shaking conveyor which serves to carry the material to be separated beneath two wheels, each studded with secondarily induced magnets and revolving about vertical axes. The ore is fed from a hopper at the head of the inclined conveyor, and is transported by the shaking movement through four zones of separation, due to the magnet wheels. The first magnet encountered by the ore carries the less current and separates the strongly magnetic particles only; the second magnet carries a greater current and separates a middling product; the nonmagnetic tailing passes off the end of the shaking conveyor.

The conveyor is a tray made up of a sheet of $\frac{3}{16}$ in. steel covered with asbestos and mounted upon hangers. A shaking movement is imparted to the conveyor by an eccentric, the movement being upward at the feed end and also in the direction of the travel of the ore. The usual speed is 440 strokes per minute. While passing over this conveyor the ore is kept constantly in agitation, thus lessening the chance of entrainment. The conveyor is 18 ins. wide and 7 ft. long, and may be raised or lowered by means of hand wheels on the hangers, thereby altering its distance from the magnets. By raising one end only, a different and gradually increasing distance from the plate to the magnet wheels may be obtained at each of the four zones of separation. This separator is also built with a conveyor belt in the place of the shaking conveyor.

The primary magnets are fixed, and consist of two steel cores, which carry the windings and connect the pole pieces. These pole pieces are made in the form of circular arcs to correspond with the secondary magnets revolving below. The secondary magnets are made of laminated steel and are disposed around the periphery of a bronze carrying wheel 30 ins. in diameter; they project as cylindrical knobs about 1 in. below the carrier, and their upper ends are U-shaped to engage closely, but not to touch, the pole pieces of the primary magnets. The magnetic circuit is completed through the steel plate beneath the asbestos covering of the conveyor. As the individual secondarily-induced magnets are carried by the revolution of the carrying wheel beyond the fields of the

primaries, they lose their magnetism and allow the attracted particles to drop off. These magnets reverse their polarity before entering the field of the opposite pole of the primary, causing a thorough discharge of their burden of magnetic particles. Troughs are provided to carry away the magnetic particles dropped, and may be so arranged as to deliver four distinct products, if it is desired.

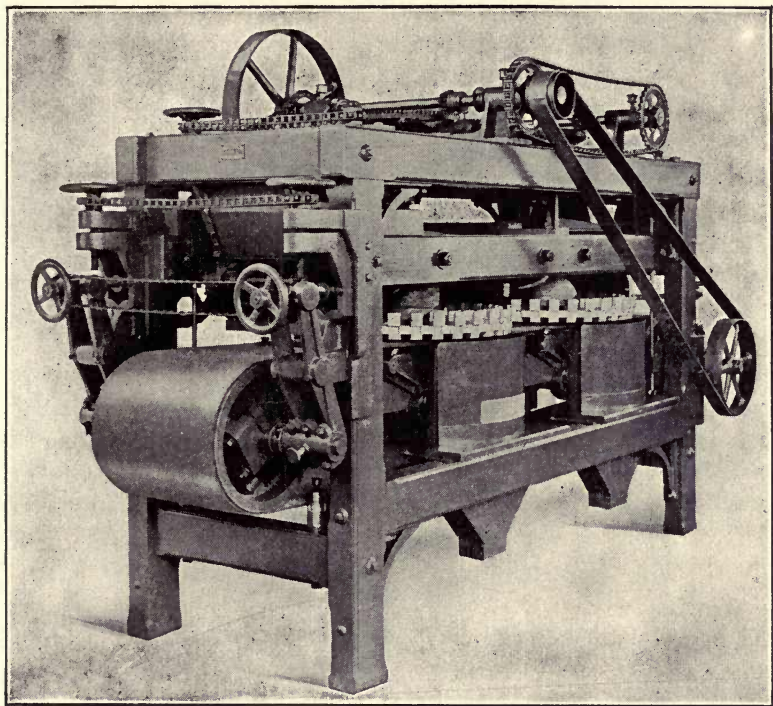

FIG. 19.—THE DINGS BELT TYPE SEPARATOR.

In operation, a variety of adjustments may be made, to suit different ores, by altering the amperage on the primary magnets, by changing the distance from the conveyor to the secondary magnets, and by altering the inclination of the conveyor. The capacity of the machine may be taken at 1 ton per hour of properly roasted blende-pyrite concentrate. About one mechanical horse power is required for operation, and from $\frac{1}{2}$ to 2 electrical horse power for excitation.

THE HUMBOLDT-WETHERILL TANDEM SEPARATOR, TYPE VII

In this a broad conveyor feed belt transports the ore to be separated beneath highly magnetized rollers. These rollers, which revolve in the same direction as the travel of the belt beneath them, pick up the magnetic particles from the ore stream and deposit them on cross belts which remove them to one side. At the end of each cross belt is another magnet which acts upon the magnetic particles as they are thrown off the cross belt, diverting them into suitable receptacles, according to their permeabilities, giving a double separation of the magnetic particles. These separators may be operated at high speed and are said to have a large capacity on strongly magnetic ore or artificial magnetite.

THE CLEVELAND-KNOWLES SEPARATOR

This machine comprises a conveyor belt which serves to transport the material to be separated beneath two cylindrical electro-magnets which revolve about vertical axes at a height of approximately 1 in. above the belt. The first magnet encountered by the ore, usually called the rougher magnet, is the weaker of the two and attracts the more strongly magnetic particles of the ore only; the second, or cleaner, magnet carries a higher amperage on a greater number of turns, and removes such magnetic particles as were not attracted by the first magnet, making a middling product; the nonmagnetic particles pass off the end of the belt. This machine is made in two sizes, with 12-in. and 21-in. belts respectively; a description of the 21-in. belt machine will serve for both.

The belt of seamless rubber on a heavy canvas base is carried on two 18-in. pulleys and driven from a line shaft through the pulley at the feed end; provision for taking up stretch in the belt is made by capstan bolts working against the sliding bearing of the pulley at the discharge end. The belt is kept level beneath the magnets by three liner pulleys which are capable of adjustment to permit the regulation of the distance between the magnets and the surface of the ore stream.

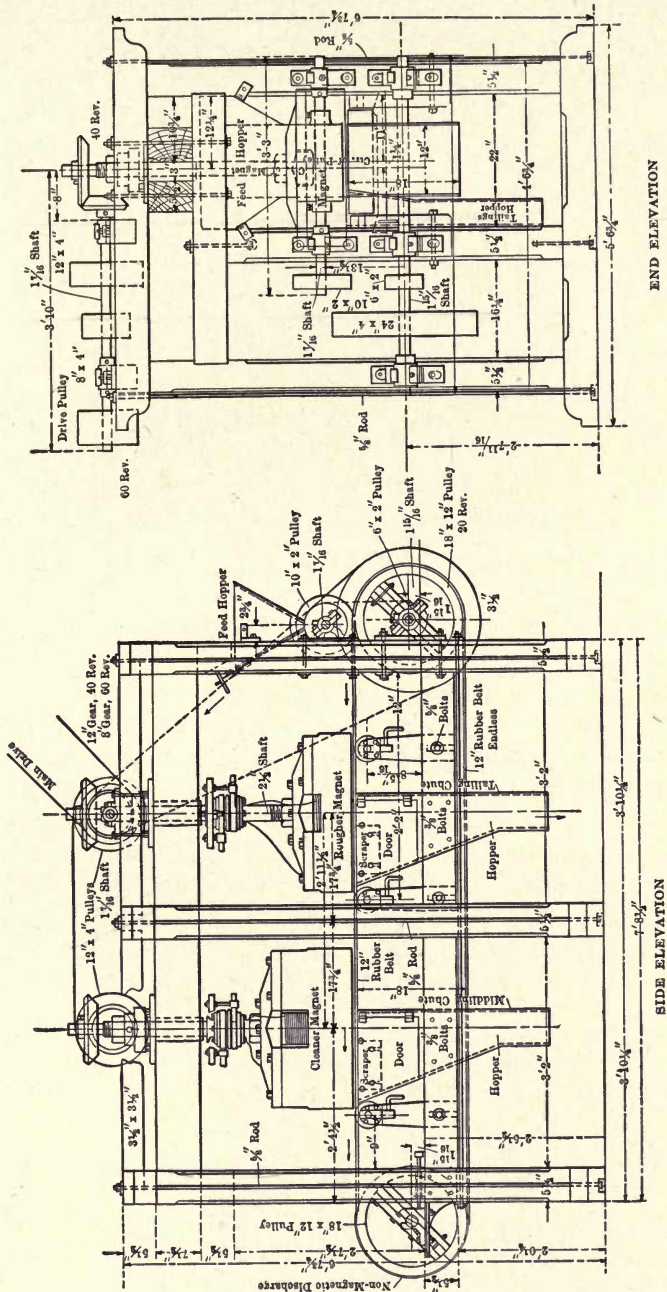

FIG. 20.—THE CLEVELAND-KNOWLES SEPARATOR.

The magnets are cylinders 26.5 ins. in diameter, the rougher of cast iron and the cleaner of cast steel and are set to overhang the belt at one side. An annular space $\frac{1}{2}$ in. in width is turned out of the bottom of the magnets $1\frac{3}{8}$ ins. from the periphery and is filled with spelter; the magnetic circuit is from the outside shell across the spelter gap to the inner core of the magnet about which the coils are wound. The magnetic particles are attracted and form a bridge across the spelter ring, and, by the revolution of the magnets, are carried to one side where they are scraped off by a brass scraper.

The normal speed of the conveyor belt when treating artificial magnetite is 100 feet per minute, and the speed of the magnets is 40 R.P.M. At this speed the operator is capable of treating 1 ton per hour of properly roasted blende-pyrite concentrate of average grade and crushed to pass 4 mesh. The capacity of the 12-in. machine is about one half that amount. The amperage employed varies with the ore and the quality of the roast from $\frac{1}{2}$ to 2 amperes on the rougher magnet and from 3.5 to 10 amperes on the cleaner magnet.

THE STERN-TYPE WET SEPARATOR

This separator is built to separate wet concentrates and finely divided material. It is said not to require a preliminary classification of the feed, and to work well on very finely divided ore. This machine consists of a number of electro-magnets mounted on a spider which revolves in a tank partly filled with water. The ends of the revolving magnets are connected by the shaft with the walls of the tank, which form the opposite poles; the separation is accomplished in this space, between the ends of the moving magnets and the cylindrical wall of the tank. The ore is fed into the machine at one side, the moving magnets pick up the magnetic particles and carry them above the water level, where they are washed off into a launder by a strong jet of water: the non-magnetic particles are drawn off through the bottom of the tank. The movement of the magnets through the water stirs up the ore thoroughly and permits a thorough separation. The machine operates on a 0.5 H.P. and requires 10 amperes for excitation of the magnets.

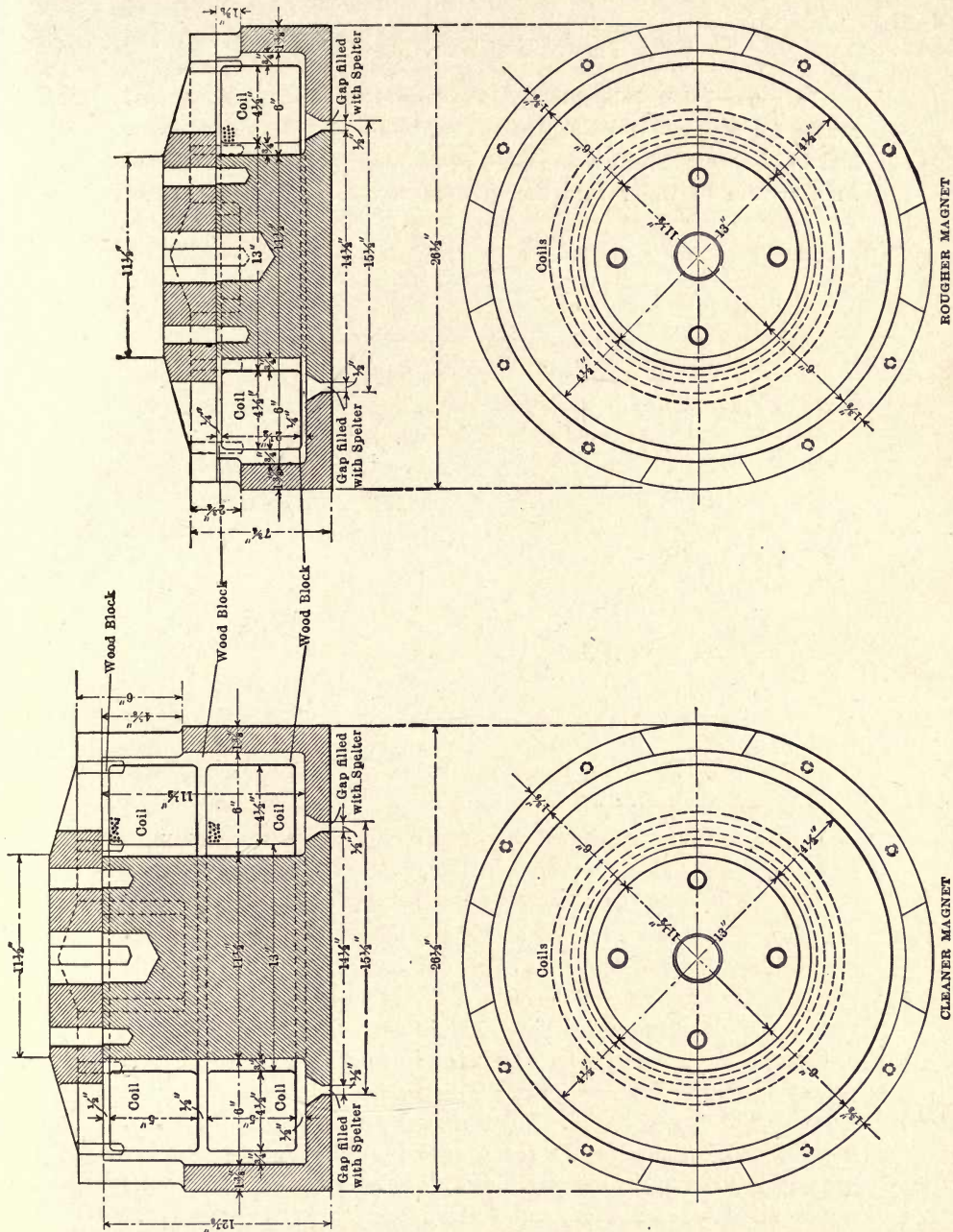

FIG. 21. — DETAIL OF MAGNETS, CLEVELAND-KNOWLES SEPARATOR.

THE PRIMOSIGH WET SEPARATOR

In general principle this machine resembles the Primosigh separator for dry ores described in the following chapter. The material to be separated, in a fine state of division, is fed in suspension in a stream of water into the grooves at the top of the magnet

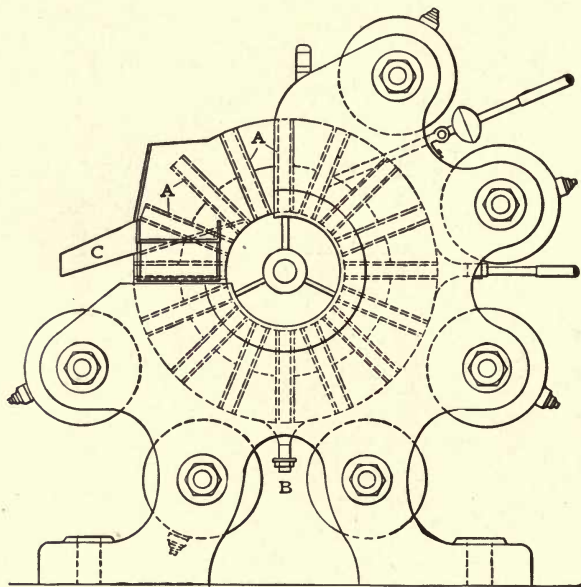

FIG. 22.—THE STERN-TYPE WET SEPARATOR. SIDE ELEVATION.

A, Revolving magnets; B, tailing discharge; C, concentrate discharge.

cylinder, which is suspended above a spitzkasten so as to be immersed in water during a part of its revolution. The nonmagnetic particles drop away from the pole pieces as soon as they reach the water, while the magnetic particles are carried above the surface of the water and removed by a series of secondarily induced magnet points as in the dry separator. This machine is adapted to the treatment of fine material. Upon a feed ranging from 0.25 mm. down to dust the capacity for a machine with four separating grooves is 0.4 metric ton per hour. Twelve amperes at 80 volts are required for excitation, and $\frac{1}{4}$ H.P. for revolution.

THE LEUSCHNER TABLE SEPARATOR

This separator is designed to treat slime. It consists of a round table with flat surface which rotates above a series of fixed electro-magnets. The magnetic particles are held against the surface of the table by the magnets beneath, while the nonmagnetic

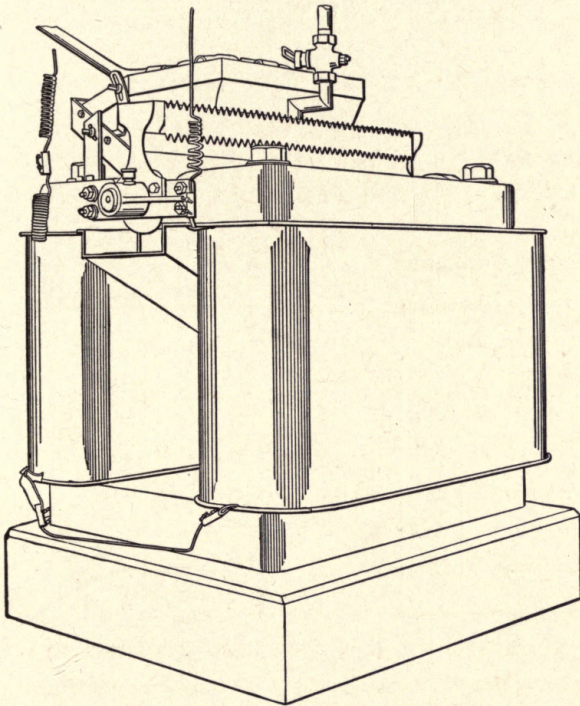

FIG. 23.—THE HUMBOLDT WET SEPARATOR.

slime is washed off by jets of water. Beneath one sector of the table there is no magnet and here the magnetic particles are washed off into a separate launder.

THE HUMBOLDT SINGLE-ROLLER SEPARATOR: FOR WET SEPARATION

This is similar to the above-described separator for the treatment of dry ores. The drum revolves partly in water, and the material to be separated is fed against it, near the lower vertical

diameter. The nonmagnetic particles sink to the bottom while the magnetic particles are carried farther by the revolution of the drum and washed off by a stream of water. A stream of wash water is directed against the magnetic particles while held against the drum, to remove nonmagnetic dust and entrained particles. The drum is protected by a water-tight mantle of sheet copper. The capacity of these machines varies, with the kind of ore and the size treated, from 500 to 4000 pounds per hour.

THE HERBELE WET SEPARATOR

In this separator a series of electro-magnets is enclosed in a water-tight casing. An endless belt travels around pulleys at top and bottom of the case containing the magnets, the belt mov-

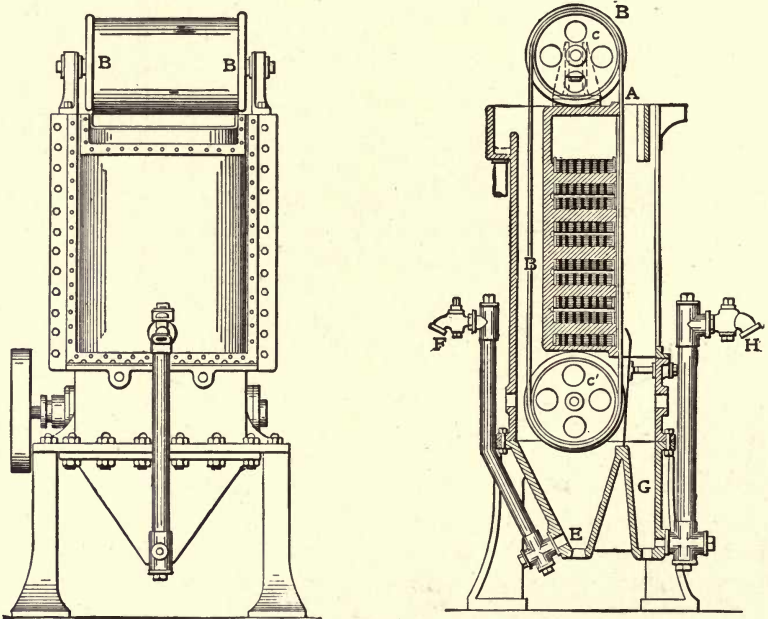

FIG. 24.—THE HERBELE WET SEPARATOR.

ing downward close to the casing on the side of the ore feed. This apparatus is set vertically in a tank filled with water to a point above the top of the magnets. The ore, best below 30 mesh, as the machine is intended to treat fine material, is fed at the

top of the belt in a stream of water; the nonmagnetic particles fall and are carried straight down by the flow of water, while the magnetic particles, held against the belt by the magnets, are carried around the lower pulley and dropped into a separate hopper. The construction is best understood from the above figure where *A* is the point at which the ore is fed, in suspension in water; *B*, the belt which conveys the magnetic particles past the magnets; *c-c'*, the pulleys about which the belt runs; *E*, the concentrate hopper; *F*, the concentrate discharge; *G*, the tailing hopper; *H*, the tailing discharge. The actual separation of the nonmagnetic particles from the magnetic takes place at the end of the shield shown close to and opposite the lowest magnet. The feed and discharge of both concentrate and tailing are continuous. The belt is 2 ft. 6 ins. wide. The capacity of the machine reaches 35 tons per 24 hours.

THE ODLING SEPARATOR

In this machine a conveyor belt serves to carry the ore beneath an electro-magnet whose poles extend across, and just above, the conveyor belt. A cross belt running beneath the poles carries the magnetic particles attracted against it to one side, where they are discharged into a chute. The nonmagnetic particles are discharged off the end of the conveyor belt.

THE HUMBOLDT SINGLE-ROLLER SEPARATOR: FOR DRY SEPARATION

This machine consists of a drum whose face is made up of alternately magnetic and nonmagnetic bars, revolving about fixed internal electro-magnets. The primary magnets are placed to cover a part of the lower diameter of the drum; the secondary magnets, carried on the face of the drum, become magnetized by induction while passing the primaries, and pick up the magnetic particles from the stream of ore which is fed beneath the drum. The magnetic particles drop off the drum as the secondary magnets become demagnetized on passing out of the field of the primaries. The whole machine is covered with a dust-tight hood. The capacity varies, with the kind of ore and the size to which it is reduced, from 700 to 3000 pounds per hour.

THE FERRARIS CROSS-BELT SEPARATOR

This machine comprises a series of six inverted horseshoe magnets placed in line, with a single take-off belt running immediately beneath the poles of all the magnets, and six feed belts running

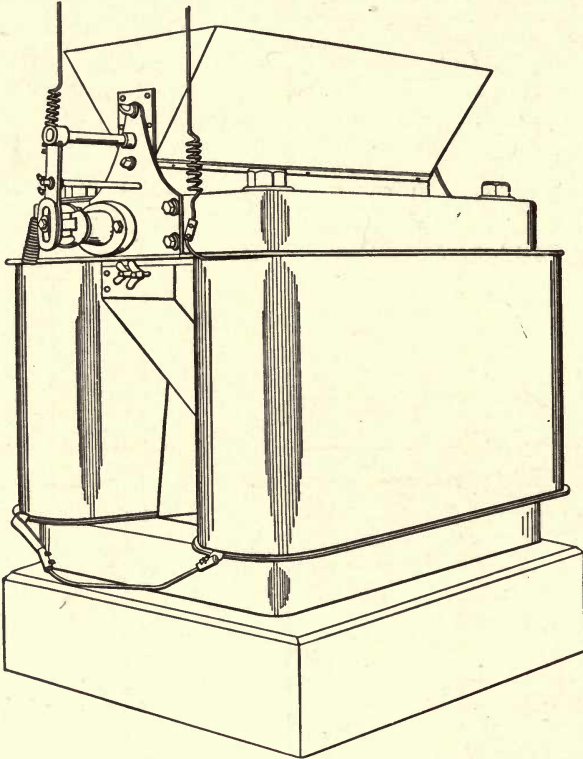

FIG. 25.—THE HUMBOLDT DRY SEPARATOR.

below the take-off belt and at right angles to it, each feed belt supplying a magnet. The poles of the horseshoe magnets are bent in toward each other, giving a concentrated field at right angles to the feed belts. The magnets are fitted with an iron projection extending a few inches beyond the ends of the poles in the direction of travel of the take-off belt, permitting the magnetic particles to be carried to one side and dropped past the feed belts into separate hoppers. Each magnet is fed with a different size of ore

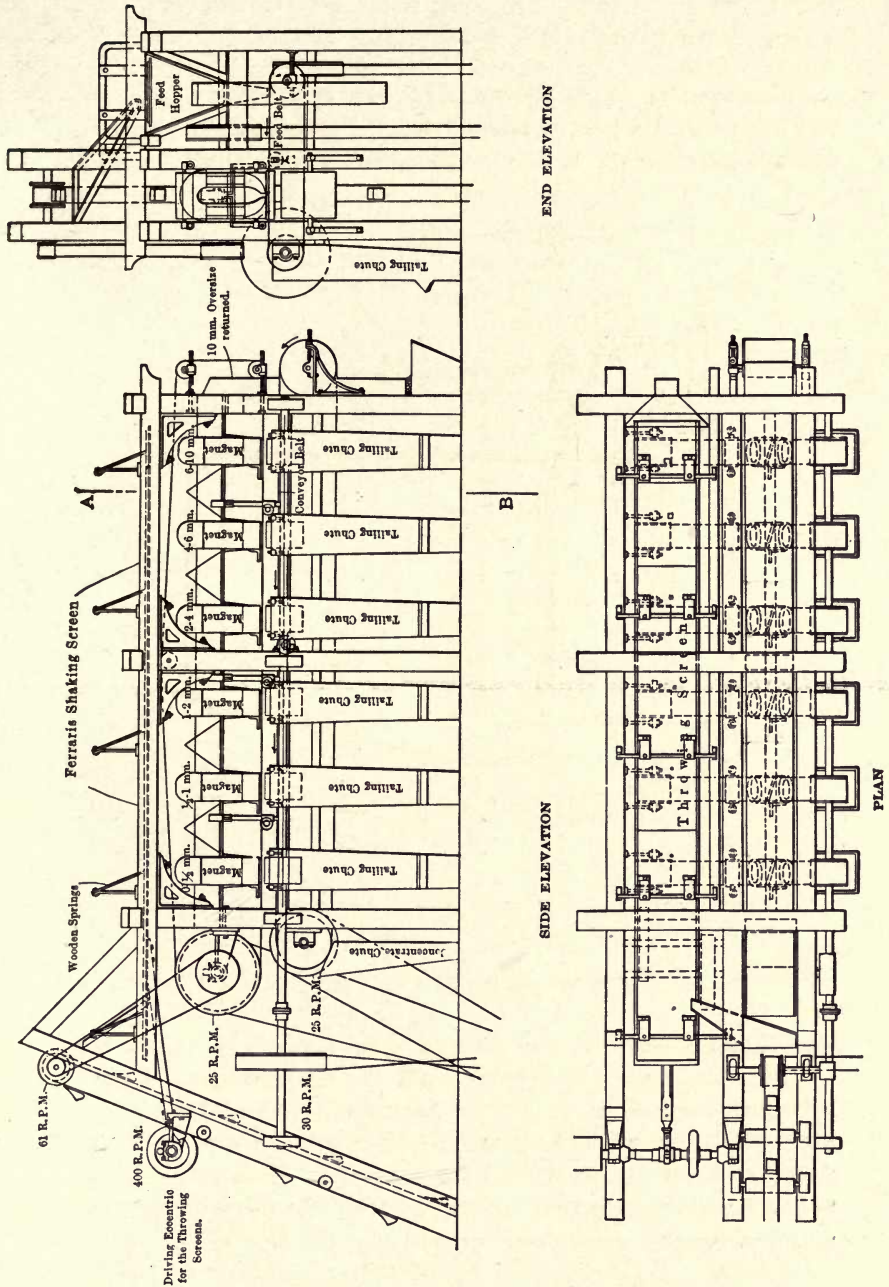

FIG. 26. — THE FERRARIS CROSS BELT SEPARATOR.

except two magnets, which both treat ore passing through a 1 mm. screen, as this size preponderates. Mounted on the separator frame are shaking screens, which deliver sized products into separate hoppers, which in turn deliver on to the feed belts. The feed belts are 12 ins. wide and travel 1.5 ft. per second. The height between these belts and the magnets is capable of adjustment through the small guide rollers shown just below the magnets. The distance through which the magnetic particles are lifted varies from 30 to 40 mm. Each magnet requires 2 amperes at 50 volts. The capacity of the apparatus is slightly over 1 metric ton per hour.

THE FERRARIS DRUM SEPARATOR

This machine comprises a shaking conveyor which feeds the material to be separated from a hopper upon a conveyor belt, which in turn presents it to a magnetic drum, fitted with a belt serving to remove the particles attracted. The magnetic drum is

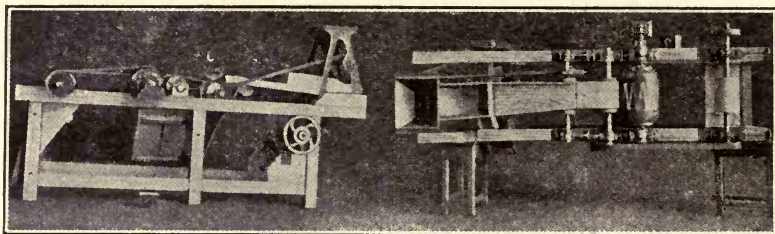

FIG. 27.—THE FERRARIS DRUM SEPARATOR.

composed of a series of composite pole pieces which dovetail into one another in a manner best understood from an inspection of the accompanying illustrations. The poles are insulated by a filling of zinc, the whole forming a smooth surface. The exciting coils are placed within the drum, connections with the dynamo being made through disks which dip into cups containing mercury. This machine, fitted with a belt 16 ins. wide, treats about 500 kgm. of calcined limonite-calamine ore per hour. The magnets require 1.5 amperes at 110 volts for excitation.

THE VIAL SEPARATOR

The deviation of magnetic particles from a falling sheet of finely divided ore is the principle upon which this separator operates. The attraction is exerted by six horseshoe magnets separated by bronze rings. These magnets, which are arranged horizontally, are enclosed in a brass cylinder which revolves at from 8 to 10 R.P.M. The ore is fed in a thin sheet at a distance of from 5 to 25 mm. from the brass cylinder. The magnetic particles are drawn toward the magnets but are prevented from adhering to them by the brass cylinder; the magnetic and nonmagnetic products are divided by an adjustable diaphragm and fall into separate hoppers. The capacity of the machine is 500 kgm. per hour. The entire apparatus is enclosed in a sheet-iron housing to prevent air currents, which would interfere with the separation. The machine treats material passing a screen with 1.5 mm. holes.

THE HEBERLE DRY SEPARATOR

This machine consists of a brass drum revolving about a series of fixed electro-magnets. The ore is fed against the drum at a horizontal diameter. The nonmagnetic particles fall past

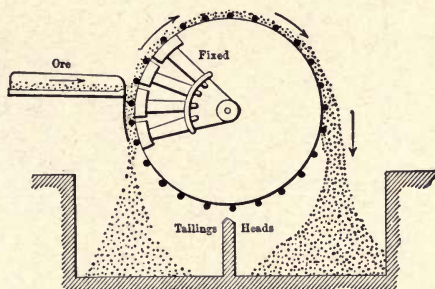

FIG. 28.—THE HEBERLE DRY SEPARATOR.

the drum into a hopper, while the magnetic particles are held against the surface of the drum by the magnets and are carried, by its revolution over the top of the drum to fall into a separate hopper. The drum makes 36 R.P.M., 6 to 7 amperes at 65 volts are required for excitation, and $\frac{1}{3}$ H.P. for revolution.

THE HUMBOLDT RING SEPARATOR

This consists of an annular magnet suspended in a horizontal plane within a circular casing. The ore is guided to the magnet by a conical shield, and, passing between the magnet and the casing, the magnetic particles are drawn inward, while the nonmagnetic particles fall past the magnet unaffected. The two products are gathered in two concentric inverted cones, the inner receiving the magnetic portion and delivering it from the separator by means of a spout through the lower, or outer, cone. The separator contains no moving parts. In lieu of an air gap between poles the separation is effected in a zone of dispersion caused by

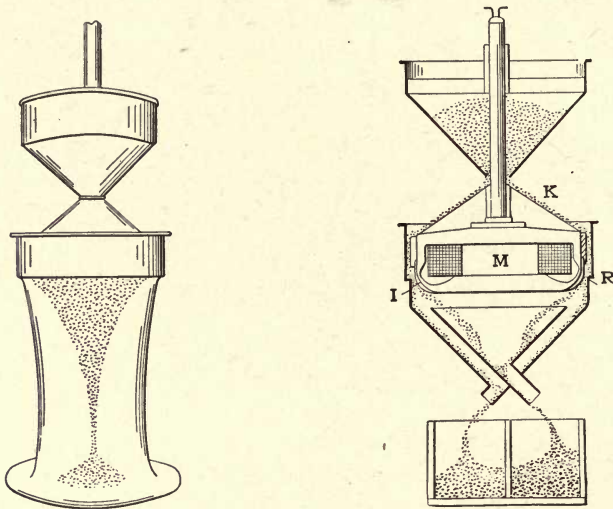

FIG. 29.—THE HUMBOLDT RING SEPARATOR.

K, Feed cone; *M*, annular magnet; *I*, shield to prevent magnetic particles from adhering to magnet; *R*, the space in which the separation takes place.

a narrowing of the enclosing casing, which induces a magnetic resistance. The operation of the separator is best understood by inspection of the figure given above. The magnetic ring has a diameter of 40 cm., or a separating periphery of about 1.25 meters. The separator is said to have a capacity of 1 metric ton per hour.¹

¹ "La Separation Electromagnetique et Electrostatique," D. Korda, p. 38.

THE KNOWLES MAGNETIC SEPARATOR

This separator consists of a stationary primary magnet between the poles of which a belt, which is studded with small secondary magnets, is caused to travel. The construction is made clear in the accompanying illustration. The ore is fed from a

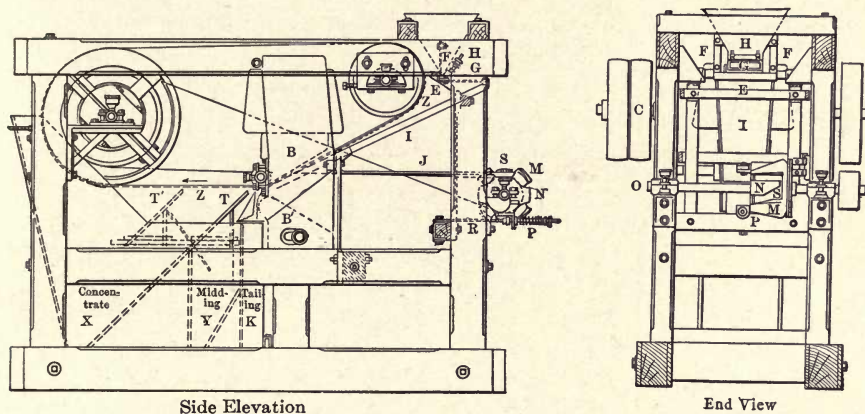

FIG. 30. — THE KNOWLES SEPARATOR.

A, Guide roller; *B B*, poles of the primary magnet; *C*, driving pulley; *F*, feed hopper; *E*, feed plate; *I*, shaking conveyor; *Z*, belt studded with secondary magnets; *S-P*, magnetic oscillator for vibrating feed and conveyor plates; *T T*, discharge guide plates.

hopper upon a reciprocating feed plate, which in turn delivers it upon a reciprocating conveyor plate; this conveyor plate brings the ore close to the belt carrying the secondary magnets; the plate and belt gradually approach each other, causing the ore particles to move in a magnetic field of constantly increasing strength. The magnetic particles are picked up by the secondary magnets and held until carried past the primary magnet, when they are gradually dropped off in inverse order to their magnetic permeabilities by the gradually decreasing strength of the secondary magnets. The nonmagnetic material falls from the end of the conveyor plate into a separate hopper. The upper pole of the primary magnet is beveled, coming to an edge at its lower end, thus giving a concentrated field at this point: the lower pole is rounded, and being movable, an adjustment of the concentration of the magnetic field is obtainable. The secondary magnets are

soft-steel rivets, with serrated washers on the lower side of the belt, there are about 200 of these rivets per square foot of belt,

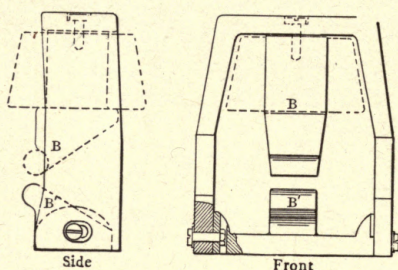

FIG. 31.—DETAIL OF PRIMARY MAGNET, KNOWLES SEPARATOR.

copper plated to prevent rusting. The speed of belt travel is 250 ft. per minute. The machine is designed for sizes from 6 to 36-in. belt width, having capacities from 7 to 46 tons per 24 hours.

IV

SEPARATORS FOR FEEBLY MAGNETIC MINERALS

WETHERILL-ROWAND SEPARATOR OR WETHERILL TYPE "E" SEPARATOR

THE machine consists essentially of a belt which conveys the ore between the poles of a series of magnets, so arranged that the belt traverses the air gap between opposite poles; the above figure illustrates the principle of this separator. The lower pole of the magnet is flat, the upper pole beveled. This arrangement causes an intense concentration of the lines of force along the lower edge of the upper magnet, and the direction of attraction

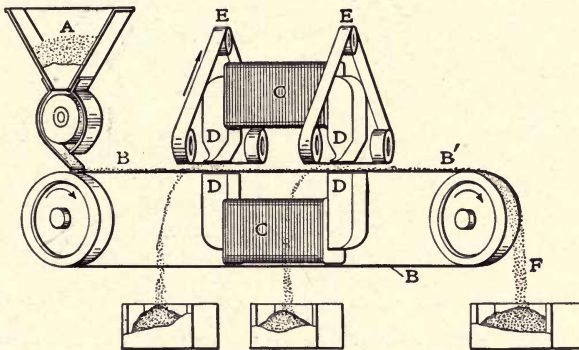

FIG. 32.—SKETCH SHOWING PRINCIPLE OF WETHERILL-ROWAND SEPARATOR.

A, Feed hopper; B-B', conveyor belt; C, coils; D, magnet poles; E, cross belts; F, nonmagnetic discharge.

of a magnetic particle presented to the magnet by the conveyor belt directly above the lower pole, is upward to the beveled edge of the upper pole. A cross belt traveling beneath the upper pole prevents the magnetic particles from sticking to it, and carries them to one side, out of the field. In order to free the mag-

netic particles at the discharge the upper pole is furnished with a tapering iron projection in the direction of travel of the cross belts; this causes a gradual reduction in the strength of the magnetic field and permits the magnetic particles to be removed from the field and drop away from the cross belt into a hopper. Each magnet in this construction has two separating zones; the machine is built with one, two, and three magnets having respectively two, four, and six separating zones, the same conveyor belt serving all of them. The conveyor belt is 18 ins. wide and the cross belts 2 ins. wide. The capacity of the separator depends upon

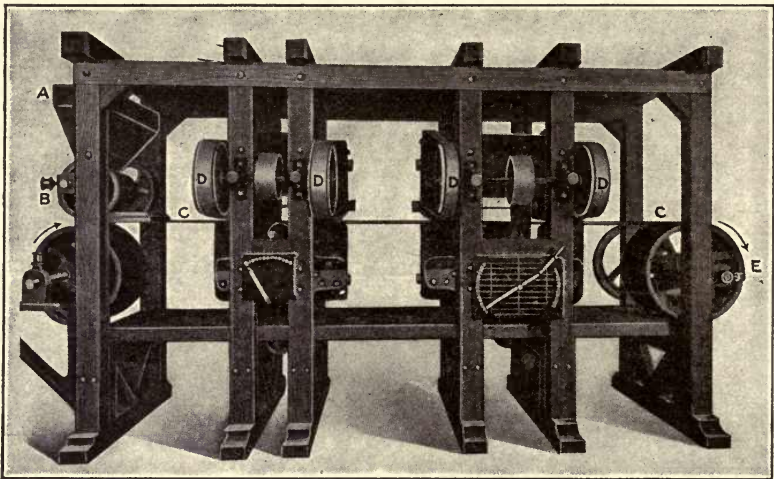

FIG. 33.—WETHERILL-ROWAND SEPARATOR.

A, Feed hopper; B, feed roller; C, conveyor belt; D, cross belts; E, nonmagnetic discharge.

the depth of ore feed on the conveyor belt (which must be very thin to prevent entrainment), and upon the speed of the conveyor belt, which must be slow enough to give the feebly magnetic particles time to be influenced and picked up by the magnets. The speed of the cross belts is adjusted to take care of the magnetic material picked up by the magnets. The ore is fed onto the conveyor belt from a hopper by means of a feed roller turning inside a cylindrical casing. It is well to introduce a coarse screen at this point (or before) to remove large pieces of ore, nails, or other foreign matter which may have passed through a leak in the sizing tromeels, as any large piece of magnetic

material will tear the delicate and rapidly moving cross belts by pressing against them under the attractive force of the magnets.

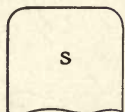

FIG. 34.—CROSS SECTION OF MAGNET POLES, WETHERILL-ROWAND SEPARATOR.

The windings on the magnets are such that the second magnet encountered by the ore is stronger than the first and the third stronger than the second, permitting the recovery of products of different degrees of magnetic permeability. The ore stream, in passing the magnets, has a tendency to gather in ridges, similar to beach sands under the action of waves. These ridges may be smoothed out and the ore layer prepared for the next magnet by means of a strip of heavy canvas placed so as to trail on the conveyor belt. Each magnet is provided with a rheostat to control the exciting currents. The machine is capable of delicate adjustment suitable to variations in the ore fed. The

capacity of the E3 machine, having 6 poles, varies from $\frac{1}{2}$ to 4 tons per hour, depending on the ore treated.

THE HUMBOLDT-WETHERILL CROSS-BELT SEPARATOR

This is practically the same as the Wetherill-Rowand separator as built in the United States, differing only in details as to the feeding device, construction of frame, etc.

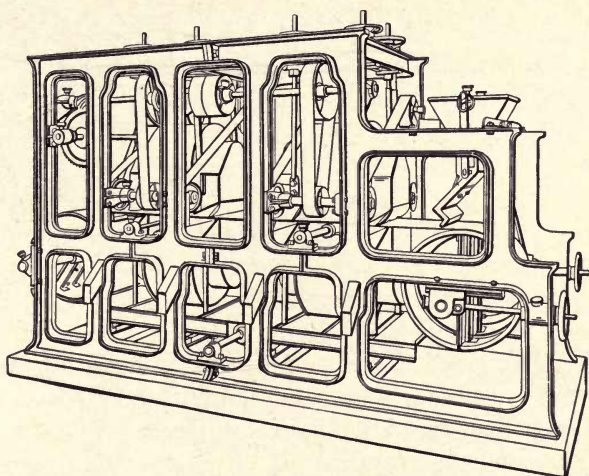

FIG. 35.—HUMBOLDT-WETHERILL CROSS-BELT SEPARATOR.

THE MECHERNICH SEPARATOR

In this machine the separation is accomplished in a field between two cylindrical poles, of which the upper revolves in the direction of the feed introduced between them. The arrangement of the poles is shown in cross section in the figure above. In the earlier type both poles were cylindrical and both revolved; in the later machines the upper is the separating member and the lower pole is stationary and covered with a nonmagnetic shell which, revolving in the direction of the ore feed, serves to discharge the nonmagnetic particles falling upon it. The feed is introduced against the upper pole as shown above; the feed plate is arranged to deliver ore automatically by means of a bumping device; the ore is pressed against the pole by a weak spring beneath the feed plate, insuring a close contact between the ore stream and the pole. The lines of force are concentrated along a plane

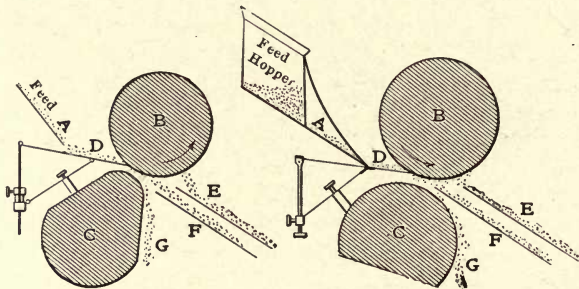

FIG. 36.—CROSS-SECTIONS OF MAGNETS, MECHERNICH SEPARATOR.

A, Feed; B, separating pole; C, stationary pole; D, feed plate; E, magnetic concentrate; F, middling; G, nonmagnetic discharge.

passing through the axes of both poles; in other words, along the line where they are nearest together. The field gradually decreases in strength as this position is left, and the magnetic particles drop off the upper pole in reverse order to their permeability, as by its revolution they are carried out of the concentrated field toward the neutral point, 90 degrees away. The nonmagnetic particles fall from the upper pole immediately upon leaving the feed plate. By a suitable arrangement of plates beneath the upper pole several middling products may be made, as well as the magnetic and nonmagnetic products. Any magnetic

material that may still adhere to the pole is removed near the neutral point by means of a revolving brush of steel wires. The exciting coils are wound on the cylinders themselves. The pear-shaped lower pole produces a greater concentration of the lines of force than the circular section. The principal function of the

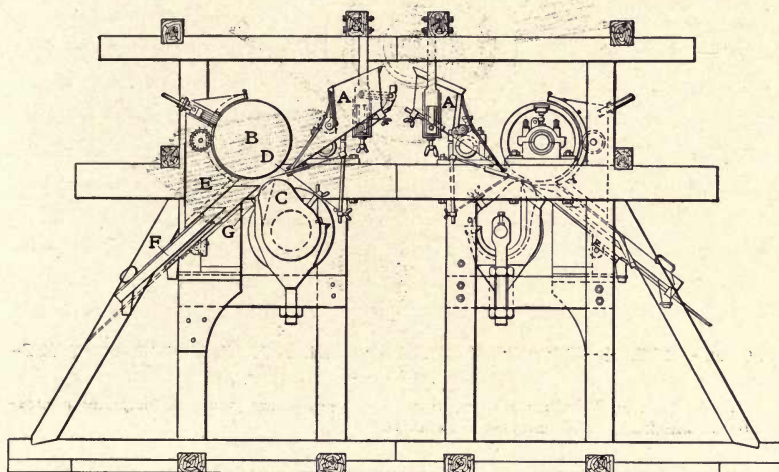

FIG. 37.—MECHERNICH SEPARATOR.

A, Feed hoppers; B, separating pole; C, stationary pole; D, feed plate; E, magnetic concentrate; F, middling; G, nonmagnetic discharge.

lower pole is as a return for the magnetic flux. The machines are usually built double, with two sets of poles. The whole is enclosed in a sheet-zinc housing to prevent the escape of dust.

The machine develops a field of high intensity, and the feed being brought into close contact with the separating cylinder (which is bare), it is capable of separating feebly magnetic minerals. The mechanical and magnetic efficiencies are high. The machine is built in two sizes, classified according to the length of the separating poles, respectively, 60 and 80 cm.

THE MOTOR-TYPE SEPARATOR

This separator consists essentially of an armature revolving between two fixed magnet poles. The ore is fed against the separating roller by means of a feed plate as shown in the above figure; the nonmagnetic particles fall away from the roller, while

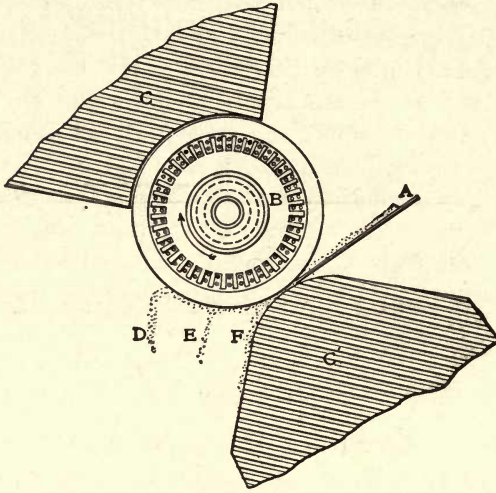

FIG. 38.—DETAIL OF MAGNET POLES AND ARMATURE, MOTOR-TYPE SEPARATOR.

A, Feed plate; *B*, separating armature; *C-C'*, stationary poles; *D*, magnetic concentrate; *E*, middling; *F*, nonmagnetic discharge.

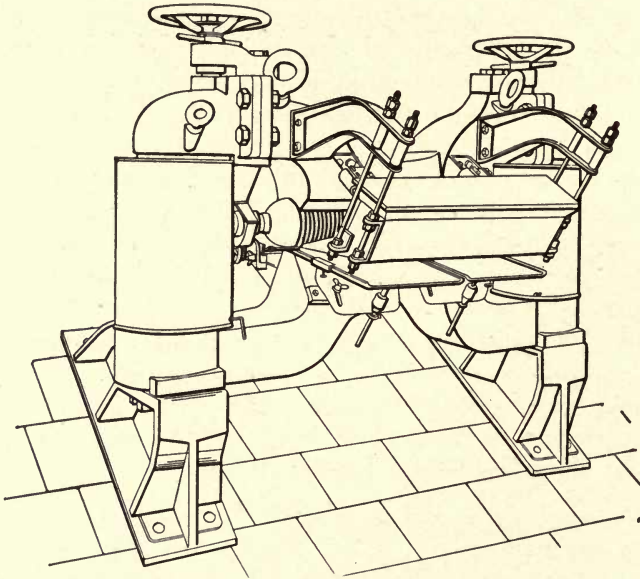

FIG. 39.—MOTOR-TYPE SEPARATOR,

the magnetic particles are carried farther, dropping off in order inverse to their permeabilities. The roller, or armature, is protected by a copper shell which revolves with it. The peculiarity of this separator is that the separating roller, or armature, is set in motion by the current supplied to the magnets, independent of any other source of power. The length of the separating roller is 800 mm.; the power consumption is from 60 to 100 watts. The only wearing parts of this machine are the separating surface and the automatic feed plate. The machine is completely closed in to prevent the escape of dust into the atmosphere of the separating room.

THE PRIMOSIGH SEPARATOR FOR DRY ORES

This machine consists of an iron core or shaft, *B*, upon which six sets of exciting coils, *A*, are mounted. These coils are protected by the brass rings, *O*, which are the separating surfaces. The pole pieces, *C*, are connected with the core, *B*, by iron disks, and it is in the groove between these pole pieces that the separation takes place. The ore to be separated is fed from hoppers through chutes, *E*, into the grooves between the pole pieces at the top of the rotating magnets, there being six individual separating zones, each equipped with its own feeding device and take-off brush. The speed of the rotating magnet cylinder is so regulated in conjunction with the current passing through the coils that the nonmagnetic particles are thrown out of the grooves as soon as they acquire the peripheral speed of the rotating cylinder; the weakly magnetic particles are carried a little farther, when centrifugal force, assisted by gravity, causes them to fall into suitable receptacles placed beneath the magnet cylinder; the strongly magnetic particles adhering to the poles are removed by a series of secondary poles consisting of soft-iron points mounted upon brass disks, *L*, the whole revolving in the direction of the magnet cylinder. The separator requires one half horse power for revolution, and from 14 to 15 amperes at 80 volts for excitation. The capacity of this separator is about 1 metric ton per hour.

THE ULRICH SEPARATOR

A pair of electro-magnets, between the wedged-shaped poles of which a separating armature is revolved, is the essential feature

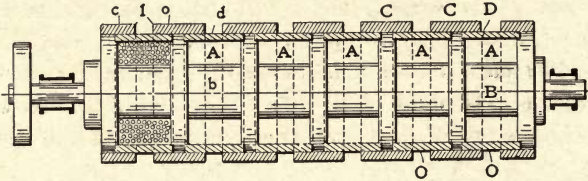

FIG. 1. Longitudinal Section

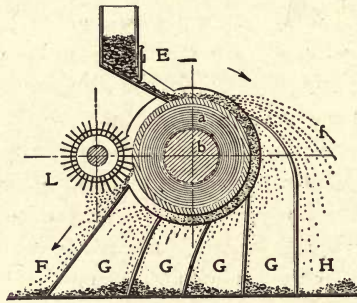

FIG. 2. Cross Section

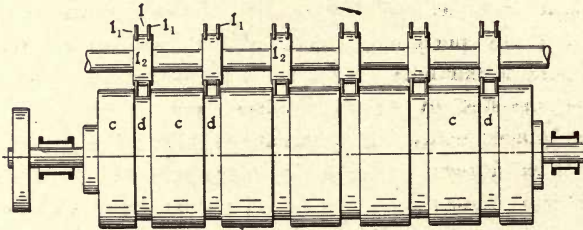

FIG. 3. Top View

FIG. 40.—PRIMOSIGH SEPARATOR.

A, Coils; B, core; C C, pole pieces; D, separating gap; E, feed; L, disk carrying secondary take-off magnets; O, brass rings covering coils; F, magnetic concentrate; GG, middling products; H, nonmagnetic discharge.

of this machine. This armature is a hollow brass cylinder carrying alternate rings of iron and brass $\frac{1}{4}$ in. wide and held close together. This cylinder, or armature, is three ft. long and makes

50 R.P.M. about a horizontal axis. Each machine carries four separating cylinders, two above (on the same axis) and two below, the upper magnets carrying a weaker current than the lower. The ore is fed from a hopper by a distributing arrangement having a feed plate, with zigzag channels cast in it, upon the top of the upper cylinders. Here the strongly magnetic particles are held by the concentrated fields at the edges of the iron rings, and deflected into a receptacle; the material passing unaffected over the first cylinder, falls upon the top of the lower cylinder which is revolving in a stronger field, and the more weakly magnetic particles are removed from the nonmagnetic portion of the feed, which is here discharged from the separator. The capacity of these machines is 25 tons per 24 hours; they require 1.5 E.H.P. and 1.5 M.H.P. for excitation and revolution, respectively.

THE PAYNE MAGNETIC SEPARATOR

This separator consists of two drums which revolve toward each other in the direction of the passage of the ore, which is fed between them. The upper drum is the separating member; it con-

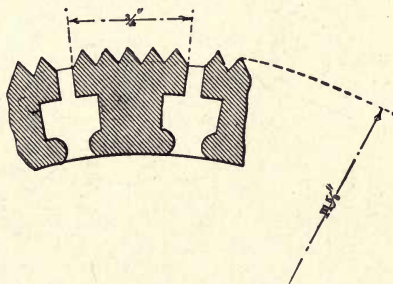

FIG. 41. — DETAIL OF SEPARATING SHELL, UPPER DRUM, PAYNE SEPARATOR.

tains a stationary electro-magnet, placed to give a strong field between the two drums along the line where they are closest together. The revolving shell is furnished with longitudinal strips of soft steel with a toothed cross section as shown in the above figure. The magnetic lines of force are concentrated along the ridges of these teeth, and give rise to a field of sufficient strength to separate weakly magnetic minerals. The lower drum is also encased with a revolving shell, and serves as a return for the lines

of force. The ore is fed from a hopper by means of a feed roller upon the shell of the lower drum, which, by its revolution, presents it to the separating drum; the nonmagnetic particles are discharged by the lower drum, while the magnetic particles are picked up and held on the ridges of the upper drum until carried past the influence of the magnet, when they drop off into a hopper.

THE INTERNATIONAL SEPARATOR

This machine comprises a cylindrical armature, made up of thin laminated disks of annealed wrought iron, which revolves about a horizontal axis between the poles of an inverted horseshoe magnet. The disks of the armature have saw-tooth edges, the teeth being staggered on adjoining disks, the surface of the armature presenting a great number of sharp points. The pole pieces of the magnet are recessed, and only sufficient space is left between

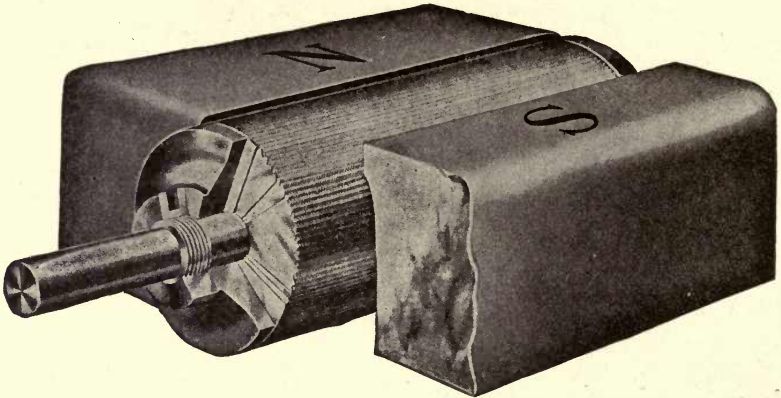

FIG. 42.—DETAIL OF SEPARATING ARMATURE, INTERNATIONAL SEPARATOR.

them and the armature for the passage of a thin layer of the ore to be separated.

The lines of force from the magnet are concentrated upon the points of the armature, giving a strong field capable of attracting weakly magnetic minerals. The magnetic attraction is strongest at a point on the horizontal diameter of the armature, and steadily decreases from this point around to the vertical diameter. The ore is fed at the top of the armature, and, upon being carried

into the field by the rotation of the armature, the magnetic particles adhere to the points of the saw teeth, the nonmagnetic particles sliding off into a hopper. The magnetic particles are carried around underneath the armature and drop off in an order

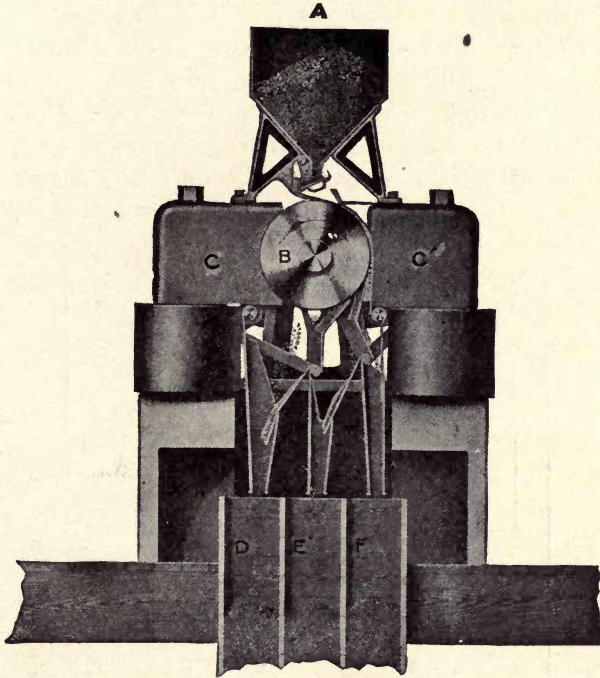

FIG. 43.—INTERNATIONAL SEPARATOR.

A, Feed hopper; *B*, separating armature; *C*, magnet poles; *D*, magnetic concentrate; *E*, middling; *F*, nonmagnetic discharge.

inverse to their degrees of permeability. At the vertical diameter, where the magnetism of the armature changes polarity, even strongly magnetic particles are thrown off by centrifugal force. By a suitable arrangement of dividing planes a middling product may be made as well as concentrate and tailing. The hoppers receiving the products of separation are adjustable, and may be moved according to the products it is wished to obtain. The position of each hopper is shown by indicators, and when they are set at the desired points, may be clamped in place by set screws. The field magnet of this separator weighs 9000 lbs., the whole machine

10,000 lbs. One horse power is used for excitation of the magnet, and one horse power for mechanical operation. The capacity of the separator is from 2 to 4 tons per hour.

THE UBALDI SEPARATOR

This machine consists of an iron core, in the shape of a ring, carrying exciting coils and having two gaps in which are placed separating armatures. The upper pole pieces are recessed to admit the armatures and the lower pole pieces are tapered to concentrate the fields at the separating zones. The armatures are

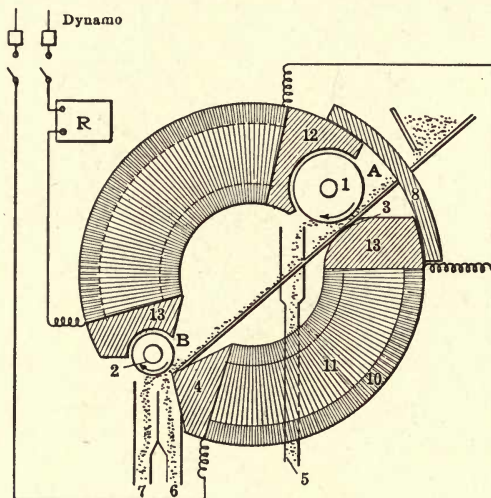

FIG. 44. — THE UBALDI SEPARATOR.

1 and 2, Separating armatures; 3, rounded pole piece; 4, beveled pole piece; 5, chute for magnetic particles; 6, chute for nonmagnetic particles; 7, middling chute; 8, yoke to control relative strength of fields; 10, coils; 11, core; 12 and 13, pole pieces.

fitted with helical ridges which serve to concentrate further the lines of force, and also, by revolution, to transport the attracted particles to one side, where they are dropped into chutes. The second separating zone encountered by the ore is stronger than the first, permitting the machine to deliver a middling product. The lower pole piece of the first separating zone is rounded, causing a partial concentration of the lines of force, while the lower pole piece of the second separating zone is beveled, giving rise to a more complete concentration of the lines of force; the pole

pieces and the separating faces of the armatures are 80 cm. in length. These machines require 1 H.P. for operation and have a capacity of 1200 kgm. per hour on leucite-bearing lava.

THE HUMBOLDT-WETHERILL TYPE VI SEPARATOR

The construction of this machine, which operates on the principle of deviation of falling particles, is best understood from the above illustrations. One pole of the magnet is tapered down

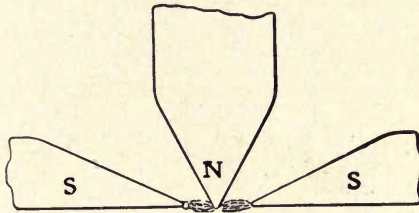

FIG. 45. — SHOWING CONCENTRATION OF MAGNETIC FIELD.

to a fine edge, the other is split and the two halves carried around the coils to almost meet close to the opposite pole, giving an intense field (280 mm. long). The ore is fed from a hopper by means of a roller upon a conveyor belt which passes around a small pul-

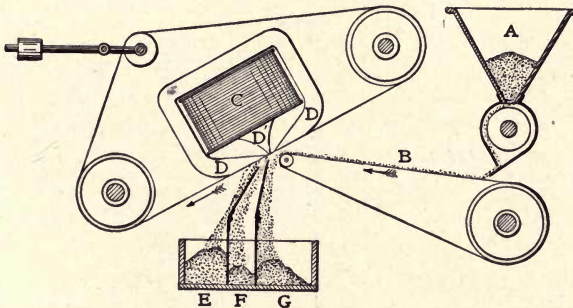

FIG. 46. — HUMBOLDT-WETHERILL TYPE VI SEPARATOR.

A, Feed hopper; *B*, feed belt; *C*, coils; *DD*, magnet poles; *E*, magnetic concentrate; *F*, middling; *G*, nonmagnetic discharge.

ley close to the field of separation. A second belt travels about the magnet close to the poles, preventing magnetic particles from adhering to them. The ore, as discharged over the end of the conveyor belt, passes into the magnetic field; the nonmagnetic

particles fall straight down, while the magnetic particles are deflected according to their magnetic permeability into different trajectories and are caught in suitable receptacles. This machine, removing raw siderite from a feed ranging from $\frac{1}{2}$ to 4 mm. in size of grain, fed separately, puts through 0.6 metric ton per hour; it requires from 8 to 9 amperes at 90 volts.

THE WETHERILL PARALLEL SEPARATOR

This consists of a flat conveyor belt, 12 ins. wide and 15 ft. 4 ins. long, between the centers of the pulleys. This belt runs horizontally, at a speed of 100 ft. per minute, and the ore is fed on it in an even layer about $\frac{1}{4}$ in. thick. At a distance of $\frac{3}{8}$ in.

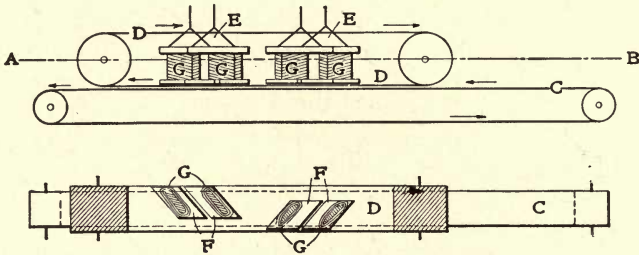

FIG. 47.—WETHERILL PARALLEL SEPARATOR.

above the top of the belt is a second belt, parallel to the former and running in the same direction. This second belt is 16 ins. wide, extending 2 ins. beyond the lower belt on each side; it runs at a speed of 125 ft. per minute. Above the upper belt are two magnets with flattened poles, placed close together with the line of their adjacent edges slanting 40 degrees with the edges of two moving belts. The magnetic particles are lifted from the lower belt against the upper, and travel with it and across it, as a result of the diagonal placing of the magnets, and on reaching the edge of the upper belt and passing beyond the magnets, they fall past the narrower lower belt into hoppers. The magnets are wound to carry 6 to 8 amperes at 52 volts. The machine is built to treat material passing a 16-in. screen. The capacity is about 30 tons per 24 hours.

THE WETHERILL HORIZONTAL SEPARATOR

This machine is built double, with two magnets and four pole pieces, giving two separating zones. The pole pieces are beveled and rounded at the ends to a $\frac{1}{8}$ in. radius; the belts pass

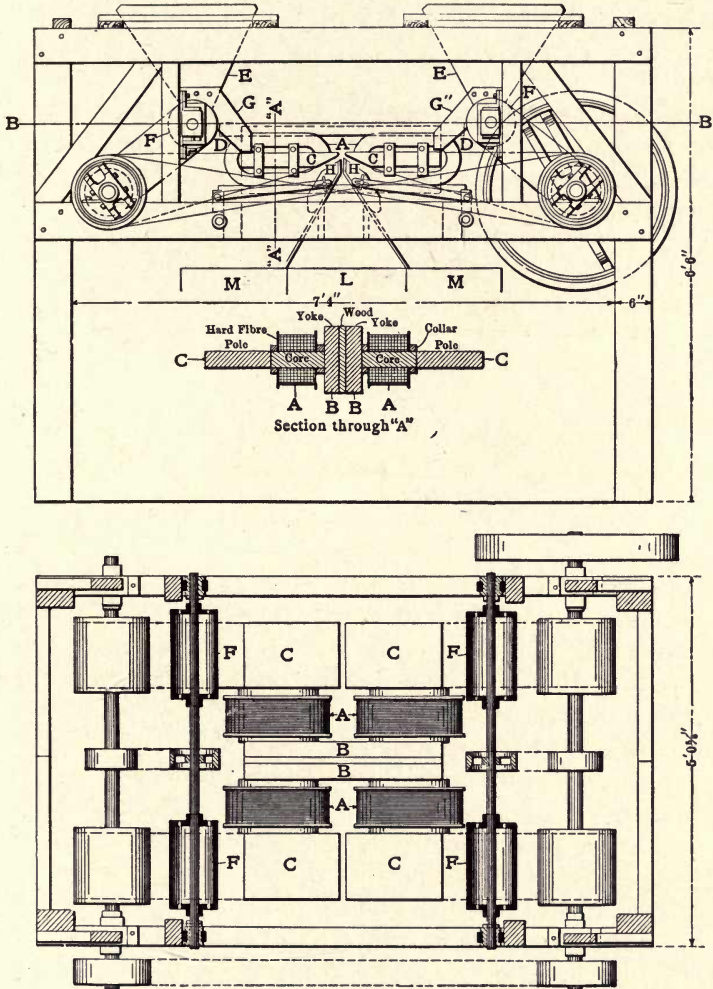

FIG. 48.—WETHERILL HORIZONTAL SEPARATOR.

A, Coils; B, yokes; C, pole pieces; D, canvas feed belts; E, hoppers; F, feeders; G, chutes; H, guide plates for discharge; L, tailing hopper; M, concentrate (magnetic particles) hopper.

around a pulley at one end and around the beveled pole piece at the other, being in direct contact with it. The poles are brought up close together in pairs, the beveled edges parallel. The construction is made clear in the accompanying plates. The ore is fed upon the belts from the hoppers in a sheet from $\frac{1}{8}$ in. to $\frac{5}{32}$ in. thick, and is carried around the beveled pole pieces, at which place the nonmagnetic particles fall into a hopper, and the magnetic particles are carried a little farther and fall into other receptacles. The pole pieces are 10.75 ins. wide and the bevel is at an angle of 27 degrees; the opposite pole pieces are 0.92 in. apart normally. This arrangement gives an intense field, and the ore is presented to it at its point of greatest intensity. The adjustments are made between the speed of belt travel, the current on the magnets, and the distance apart of the pole pieces. This machine was used to treat franklinite ore passing 0.058 in. apertures and retained on a screen with 0.01 in. apertures: it treated from 1.5 to 3 tons per hour, three machines in series. The first two machines took 6 to 8 amperes and the third 22 amperes at 52 volts. Two adjustable guide plates below and a little to the side of each separating gap are used to divert the magnetic and nonmagnetic particles into their respective hoppers.

THE WETHERILL INCLINED SEPARATOR

In this machine the ore is fed upon a conveyor belt which presents it to a magnetic field between two pole pieces similar to those used in the horizontal separator. The pole pieces in this machine, however, are set at an angle of 27 degrees from the horizontal, the plane of the upper pole piece being 1.2 ins. above that of the lower. The construction is made clear by the accompanying illustrations. The ore is brought by the conveyor belt as close as possible to the gap between the pole pieces; the magnetic particles are here lifted off the conveyor belt against belts running around the ends of the pole pieces; the belt of the lower pole is the discharge belt for the concentrate, which is carried along and dropped into a hopper; the magnetic particles drawn against the upper pole are carried up on a 54-degree incline until past the influence of the separating zone, when they fall back, and by their momentum are carried past the gap to join the concentrates on the

lower belt. The magnets are wound to carry from 6 to 8 amperes at 52 volts. The adjustments are made between the distance of

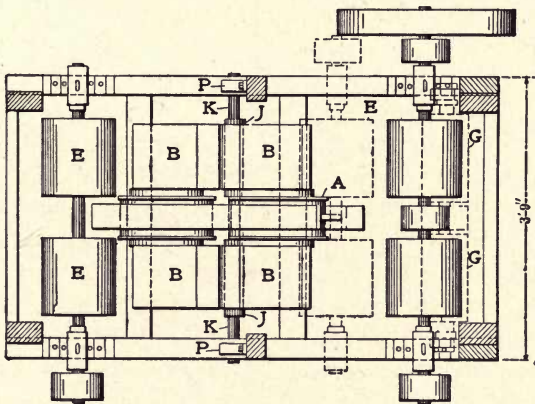
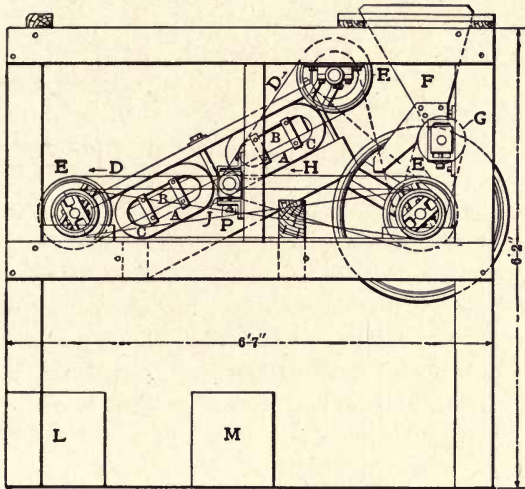

FIG. 49.—WETHERILL INCLINED SEPARATOR.

A, The coils; B, the pole pieces; D, discharge belts; E, pulleys; F, feed hoppers; G, feeders; H, conveyor belt; J, adjustable pulley to bring conveyor belt close to separating gap; L, concentrate hopper; M, tailing hopper; X, beveled edges of pole pieces.

the conveyor belt from the gap, in the width of the gap between the poles, and in the current on the magnets. These machines, used three in series in the separation of franklinite ores passing a

screen with 0.01 in. holes, have a capacity of 3.5 tons per hour. This separator is built double: if a stronger field is desired a yoke is substituted for one set of the pole pieces, leaving but one air gap in the magnetic series. The magnets of this separator are wound the same as those of the horizontal type.¹

¹“Richards Ore Dressing,” p. 808.

V

THE CONCENTRATION OF MAGNETITE ORES

MAGNETITE is the most strongly magnetic of all minerals, and it is therefore natural that the earliest application of magnetism to ore dressing was for its concentration from gangue. Magnetite ores occur in large bodies in almost all countries, and on account of the high iron tenor of the pure mineral, and the ease with which it is concentrated, its treatment forms one of the most important fields of magnetic separation.

Magnetite (composition Fe_3O_4) has a specific gravity ranging from 5.0 to 5.1, and is sufficiently heavy to permit of its concentration from gangue by specific-gravity methods, which have had an extensive application. The object of the separation, however, is twofold: the concentration of the mineral in the raw ore to a product of sufficient richness for the blast furnace, and the elimination of phosphorous and sulphur, elements which frequently occur with magnetite in nature and which enter into combination with the iron in the furnaces with the production of an inferior metal. The specific gravities of the minerals carrying these objectionable impurities do not permit their complete separation from the magnetite by water concentration. The high magnetic permeability of magnetite, which is 65 per cent. of that of tempered steel, is much greater than the permeabilities of these minerals and permits a separation to be made in magnetic fields of low intensity.

The results from the several separators must not be judged on the basis of the percentage of iron in the tailing product, as this figure is controlled largely by factors other than the efficiency of the separator. Iron ores, to be commercially profitable, must carry a high percentage of iron, the low limit being, apparently, between 20 and 25 per cent. iron present as magnetite. This results in a low ratio of concentration and a comparatively small quantity of tailing, and a large percentage of iron in the tailing may represent but a small loss when compared with the total iron

in the ore. The coarseness of the crystallization of the individual minerals, the presence of iron in nonmagnetic form, such as hematite, pyrite, ferruginous silicates, etc., must also be taken into account, while the grade of the concentrate aimed at is also an important factor in determining the efficiency of the separation in terms of the percentage of the iron in the original ore recovered as concentrate.

The American practise tends toward the production of the coarsest size concentrate consistent with a clean separation and reasonable recovery, employing separators which treat the ore dry. In Sweden it is customary to grind the ore to 1 mm., or even finer, and separate on machines which treat the ore wet, resorting to briquetting to transform the concentrate into a product suitable for the blast furnace. These differences in practise are largely due to the coarser crystallization of the American ores, the Swedish ores being more often made up of minerals in a fine state of division. Magnetic cobbing has been successfully applied in both countries, and produces excellent results with ores which carry magnetite in large pieces, and in which apatite and pyrite do not interfere. In Sweden, lump ore from 4 to 5 ins. in size has been cobbled on the Wenstrom separator with the production of a good concentrate, and the separation of lumps 1.5 to 2 ins. in size is regularly carried on in America on the Ball-Norton single-drum separator, and in Sweden on the Wenstrom and Grondal cobbing machines.

In the dry concentration of magnetite ores the fine dust formed by crushing is often a source of loss, but is not so counted when some of the newer wet separators are used; in Sweden it is not unusual for over 40 per cent. of the ore fed to the separators to be fine enough to pass a $\frac{1}{8}$ -mm. opening.

The following table is representative of the best practise in the magnetic concentration of magnetite ores in the United States and Sweden.

THE ELIMINATION OF IMPURITIES

The objectionable elements occurring with magnetite which are wholly or partially eliminated by magnetic concentration, are, in the order of their importance, phosphorus as apatite, sulphur as pyrite, etc., and titanium as menaccanite or ilmenite

Apatite (calcium phosphate, sp. gr. 3.18 to 3.25) is usually

RESULTS FROM THE SEPARATION OF MAGNETITE ORES AT REPRESENTATIVE MILLS

LOCATION	Separator	Size ¹	CRUDE ORE				CONCENTRATE				Tailing Per cent. Fe
			Per ct. Fe	Per cent. S	Per cent. P	Per ct. Fe	Per cent. S	Per cent. P	Per cent. Fe		
Mineville, N. Y.	Ball-Norton	1.5 in.	45.0	61.0	Re-treated
Mineville, N. Y.	Ball-Norton	$\frac{3}{8}$ in.	50.3	trace	0.292	64.1	trace	0.133	14.0
Mineville, N. Y.	Ball-Norton	$\frac{3}{8}$ in.	59.6	1.740	67.3	0.675	12.1
Lyon Mountain, N. Y.	Monarch	$\frac{1}{4}$ to $\frac{3}{4}$ in.	36.5	0.019	64.7	0.010	9.7
Port Orem, N. J.	Ball-Norton	$\frac{1}{4}$ in.	25.0	1.0	61.0	0.3 to 0.045	11 to 17
Hibernia, N. J.	Ball-Norton	$\frac{1}{4}$ in.	39.0	0.04	63.5	0.008	5 to 6
Herrang, Sweden	Gronal 3 and 5	1 mm.	40.2	1.20	0.003	67.3	0.17	0.0025	6.4
Svarto	Monarch & Herbele	1 mm.	58.0	1.00	70.0	0.127	25.5
Bredsjo	Gronal No. 2	1.5 mm.	35.0	0.15	0.010	67.2	0.08	0.004	6.9
Strassa	Gronal 1 and 2	1 mm.	46.8	0.03	0.015	69.2	0.015	0.003	6.1
Pitkaranta	Gronal No. 1	1 mm.	28.4	2.6	0.260	69.6	0.132	0.008	²

¹ Size of preliminary crushing. ² From $\frac{1}{4}$ to 1 per cent. as magnetite.

feebly magnetic, though not sufficiently so to be picked up by magnetic fields of low intensity; a red variety, found at Mineville, N. Y., is sufficiently magnetic to be sometimes drawn into the heads by the Ball-Norton separator. This mineral is a common accessory in magnetite ores; it is quite brittle, and, on being crushed, forms a fine powder which has a tendency to stick to the magnetite grains and so find its way into the concentrate. This tendency is less marked when the concentration is carried out in water, and may be quite thoroughly overcome by the use of a spray of wash water while the magnetite is held by the magnets. In dry concentration the use of a blast of air directed against the minerals held by the magnets is beneficial, or the employment of a separator which turns the concentrate over and over as it is passed from pole to pole of opposite sign.

Apatite, when present in quantity in the ore, may form a valuable by-product, as it may be worked up into soluble form and sold as fertilizer. At Mineville, N. Y., the Old Bed ores carry from 1.35 to 2.25 per cent. phosphorus, and the tailing products find a market for their phosphorus content. Two grades of tailing are made: the first called first grade apatite, carries 3.55 per cent. iron and 12.71 per cent. phosphorus, equivalent to 63.55 per cent. bone phosphorus. The second grade apatite carries 8.06 per cent. phosphorus and 12.14 per cent. iron, or an equivalent of 40.30 per cent. bone phosphate. At Svarto, near Lulea, Sweden, the ore carries up to 3 per cent. phosphorus as apatite, averaging 1 per cent., and the tailing product from the separators carries 13.7 per cent. phosphorus. This tailing product is concentrated by jigging, and after fine grinding, is treated chemically for the removal of remaining magnetite, calcined with soda ash and sold as fertilizer containing 30 per cent. phosphoric acid in soluble form.

Concentrates, to be acceptable at furnaces which turn out the best grades of iron, should not carry more than .01 per cent. phosphorus; ores which are below this limit command a premium. As the apatite is present principally in the waste particles, the higher the grade of concentrate produced the lower will the percentage of phosphorus be, and tests should be made on the ore under consideration to determine the economical limit of concentration and elimination of impurities, where the advantage from these ceases to offset the increased loss of iron in the tailing due to the increasing ratio of concentration.

Pyrite (FeS_2 , sp. gr. 4.8 to 5.2) is a common accessory mineral in magnetite ores. It is nonmagnetic and is not influenced by the most intense magnetic fields; it is easily eliminated in the tailing product when not in an excessively fine state of division.

Pyrrhotite (Fe_7S_8 , sp. gr. 4.5 to 4.65) is, on the other hand, usually ferromagnetic, and is drawn into the magnetite concentrate. It is not so strongly magnetic as magnetite, and sometimes a partial elimination is accomplished; but, generally speaking, it may not be removed from magnetite by magnetic separation. In the case of some complex ores carrying pyrrhotite, blende in a fine state of division, etc., the sulphur is eliminated by roasting. Magnetite does not lose its magnetism except when exposed to a red heat for a protracted period, and such roasting may be carried out either before or after separation. Roasting for the removal of sulphur is practised on some concentrates produced in Sweden; the heat employed in briquetting fine concentrate accomplishes at the same time an elimination of the sulphur.

Another objectionable element occurring with magnetite is titanium in the form of *menaccanite* (sp. gr. 4.5 to 5.0, composition the same as hematite but with varying proportions of iron replaced by titanium). This mineral is magnetic, but not to so great a degree as magnetite; a separation of magnetite and menaccanite may be accomplished, but only at the expense of a serious loss of iron in the tailing product. Titanium is an objectionable constituent in iron ores on account of its tendency to form accretions in the blast furnace. Results of tests made to eliminate menaccanite from magnetite will be found in the following table of beach sands, in which the minerals occur as free particles, forming the raw material for separation:

SEPARATION OF BEACH SANDS¹

LOCALITY		Per cent. Fe	Per cent. Ti
Cumberland, R. I.	Crude sand.....	32.4	6.25
	Concentrate.....	63.3	2.36
	Tailing.....	11.7	8.76
Moisie, Quebec.....	Crude sand.....	58.25	8.46
	Concentrate.....	68.45	2.13
	Tailing.....	33.3	11.16
Long Island, N. Y.	Crude sand.....	48.49	6.78
	Concentrate.....	69.77	trace
	Tailing.....	36.22	11.4

¹ Axel Sahlin, *E. & M. J.*, vol. liii, p. 664.

MAGNETIC SANDS

Many attempts have been made to exploit beds of magnetite sands concentrated by waves and streams along ocean beaches and banks of rivers. Such deposits are abundant at Moisie, on the St. Lawrence, and in smaller developments in the United States at Block Island, on Long Island, along the Great Lakes and on the Pacific Coast; abroad, deposits in Brazil and New Zealand have attracted attention. The writer is not informed of any present commercial operation on such deposits; magnetic impurities in the sands (menaccanite, etc.) and the unreliability of the deposits due to their mode of formation have probably been the chief causes of failure.

BRIQUETTING

With ores which require fine comminution for the liberation of the magnetite the concentrate produced is usually briquetted, as fine concentrate is not acceptable at the furnaces. While the mill at Edison, N. J., was in operation the ore was crushed to pass $\frac{1}{16}$ -in. \times $\frac{1}{2}$ in. openings, and the concentrate briquetted. In Sweden the briquetting of concentrate is usual.

In Sweden the plants installed by The Grondal Kjellin Co. have been very successful. The fine concentrate is pressed into briquettes without the use of binding material, the moisture in the concentrate being regulated to obtain briquettes sufficiently firm to be removed from the press and loaded onto the cars used in the furnace. These cars are made of a frame covered with fire-brick and have a tongue cast in the frame at the front end and a groove at the rear end, and along the sides are fitted with a flange which dips into a groove filled with sand in the furnace, a string of these cars thus forming an air-tight platform. The furnace is in the form of a tunnel, with track running down the center, and in the middle has a combustion chamber gas-fired. The air needed for combustion is admitted beneath the gas-tight platform at the feed end of the furnace, and, passing the discharge end, returns above the platforms of the cars with their loads of briquettes, enters the combustion chamber, whence the products of combustion continue above the platform to an outlet near the feed end of the furnace. The cool air circulating beneath the platform keeps the wheels and

framework of the cars cool, becomes heated as it at the same time cools the burned briquettes, and enters the combustion chamber hot; the hot gases in turn heat the briquettes and are themselves cooled before they are liberated from the furnace. Owing to this application of the regenerative principle the thermal efficiency of the furnace is good, the gases escaping at a temperature of less than 100° C. and the consumption of coal averaging 7 per cent. of the weight of briquettes burnt, the principal loss in heat is the

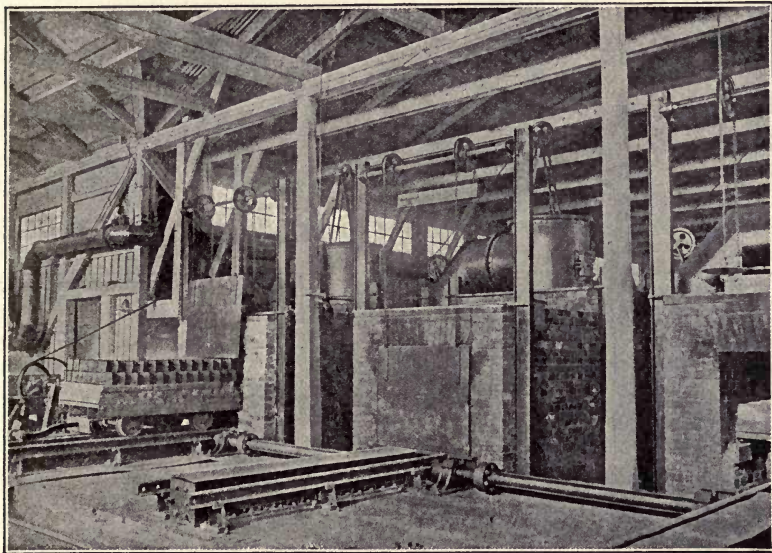

FIG. 50.—GRONDAL BRIQUETTING PLANT, SWEDEN.

evaporation of the water in the briquettes. The temperature in the combustion chamber reaches $1,300^{\circ}$ or $1,400^{\circ}$ C., and at this heat the particles agglutinate sufficiently to make a firm, hard briquette which will stand rough usage. The time consumed by the operation varies with the ore treated and the degree of desulphurization required; any sulphur in the concentrate is readily eliminated.

Briquettes may be made at a lower temperature through the use of various binding materials: at Pitkaranta, Finland, 3 to 5 per cent. lime is added to the concentrate which is then briquetted, and, after being allowed to set for two weeks, heated to 800° C.; at Edison, N. J., briquettes were made with a resinous binder. Where no

binder is used the only requirements are a proper proportion of coarse and fine particles to avoid excessively large interstitial spaces, and a sufficiently high heat to sinter the magnetic particles. It has been estimated (P. McN. Bennie) that the cost of briquetting under conditions obtaining in the Eastern United States would be 45 cents per ton.

At *Mineville, New York*,¹ there are extensive magnetic concentration works built by Messrs. Witherbee, Sherman & Co. for the treatment of ores from their mines. The ores are of two classes: the New Bed and the Harmony ores carry from 40 to 69 per cent. iron as magnetite and are low in phosphorus; the Old Bed ores are high in phosphorus, carrying from 1.35 to 2.25 per cent. The apatite varies in color and in the size of crystals; that with a deep red color develops magnetic qualities of sufficient strength to carry some free crystals into the concentrate; it also adheres to the crystals of magnetite in a more marked degree than the green or yellow varieties. The yellow crystals break away freely from the magnetic material. When the magnetite is in large pieces in the crude ore, or in large crystals, it is readily handled by cobbing; when the ore is massive, or when the magnetite and apatite crystals are small and intimately associated, finer crushing is necessary for the same degree of concentration. The ore from the Harmony Mines is cobbled on a Ball-Norton single-drum separator, and magnetite recovered in large pieces, the waste going for finer crushing and further magnetic treatment to Mill No. 1.

The cobbing plant is near the "B" shaft of the Harmony Mines, the skips dumping into a chute which feeds a 30- × 18-in. Blake crusher weighing 29 tons. The crusher is driven from a jack shaft which is belted to a General Electric induction motor of 100 H.P. operating at 440 volts. The ore is crushed to 1½ ins. and is conveyed from the crusher by a 20-in. Robins belt conveyor to a bin over a Ball-Norton single-drum separator. After passing through the separator the cobbled material and tailing fall on separate 20-in. belt conveyors and are transported up an incline to storage bins. These two conveyors are operated by a rope drive. The cobbled product and the tailing storage bins are placed over and alongside, respectively, two tracks upon which standard-gauge hopper-bottom cars run, connecting with mill, railroad and wharves. The cobbled product is called "Harmony cobbled"; it is a coarse

¹J. H. Granberry, *E. & M. J.*, vol. lxxxi, p. 1082.

magnetite with little gangue, and carries about 61 per cent. iron; it is used to mix with lower-grade ores at the furnaces, where it is desirable on account of its coarseness and uniform grade. The tailing carries sufficient magnetite to be crushed and concentrated in Mill No. 1.

Mill No. 1 treats crude ores from the "A" shaft of the Harmony Mine and the tailing from the cobbing plant. The ore is weighed and dumped into a storage bin which feeds a 30- × 18-in. Blake crusher working at 250 R.P.M. After passing through the

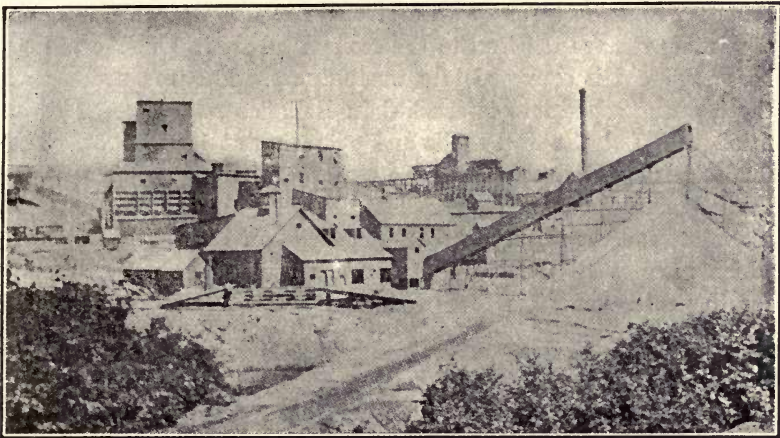

FIG. 51.—MILL NO. 1, MINEVILLE, NEW YORK.

crusher the ore is screened to $\frac{3}{4}$ -in., the fines going directly to a dryer, while the oversize is passed through a size H Gates crusher, after which it also goes to the dryers.

The dryer is built of 4- × 6- × 12-in. furnace-brick. The material slides over cast-iron tees 5 ins. wide on top and with a shallow stem arranged in horizontal rows, six in a row, with the rows 6 ins. apart, vertically. The bars, in vertically adjacent rows, are staggered. Six rows parallel to and underneath each other are followed by six similar rows at right angles to the first; this arrangement obtains from the top to the bottom of the stack. The dryer is made with a bridge wall and an outside furnace. The gases from the furnace divide at the bridge wall, part passing up the chimney and part into the shaft. There are two openings from the shaft into the chimney, which serve to permit the gases

to pass from one to the other, which tends to raise the capacity of the dryer by reason of the eddy effect set up.

From the dryer the material is fed to a Ball-Norton single-drum separator. The concentrate from this machine goes to a shipping bin and the tailing through a set of Anaconda rolls, 40 × 15 ins., with Latrobe steel shells, operating at 50 R.P.M. Thence the ore is elevated and passed over a $\frac{3}{8}$ -in. tower screen from which it is fed to two Ball-Norton belt-type separators which make concentrate, a shipping product carried to bins on a Robins belt conveyor, and tailing which passes to two other separators of the same type but operating with a stronger current. These cleaning separators remove the iron to the economical limit, and the tailing here produced is conveyed to a waste dump. The iron product of the cleaning separators is crushed in Reliance rolls 36 × 14 ins. fitted with Latrobe steel shells and operating at 100 R.P.M. The final cleaning is effected on two other separators of the same type, the magnetite product is carried to shipping bins by a 20-in. belt conveyor, and the tailing to the dump upon an 11-in. belt conveyor, which handles all the tailing from this mill. The power supply for this mill comprises four Crocker-Wheeler 50 H.P. direct-current motors, operating at 220 volts, and a 75 H.P. General Electric motor also employed.

Mill No. 1 has a capacity of 800 tons of crude Old Bed ore per day, or of 600 tons of Harmony or New Bed ore; both figures are for 10 hours. Of the feed 77 per cent. is recovered as concentrate. A table of average results follows:

MATERIAL	Iron Per cent.	Phosphorus Per cent.
Lean Harmony ore.....	50.26	0.292
Harmony concentrate.....	64.10	0.133
Harmony tailing.....	13.97	0.877

Mill No. 2 treats the Old Bed ore, which is high in phosphorus. The treatment here is similar in many points to that in Mill No. 1, and the points of difference only will be described. The power is furnished by three 60 H.P. General Electric motors, form K, operating on 440 volts. A 10 H.P. motor of the same type is used to drive the conveyors to the shipping bins. The mill

is divided into the crushing, the separating, and the re-treating plants, each of which divisions is independent as to power supply; each motor is arranged to control the machinery and con-

FLOW SHEET FOR MILL NO. 1

Ore from mine and cobbing plant

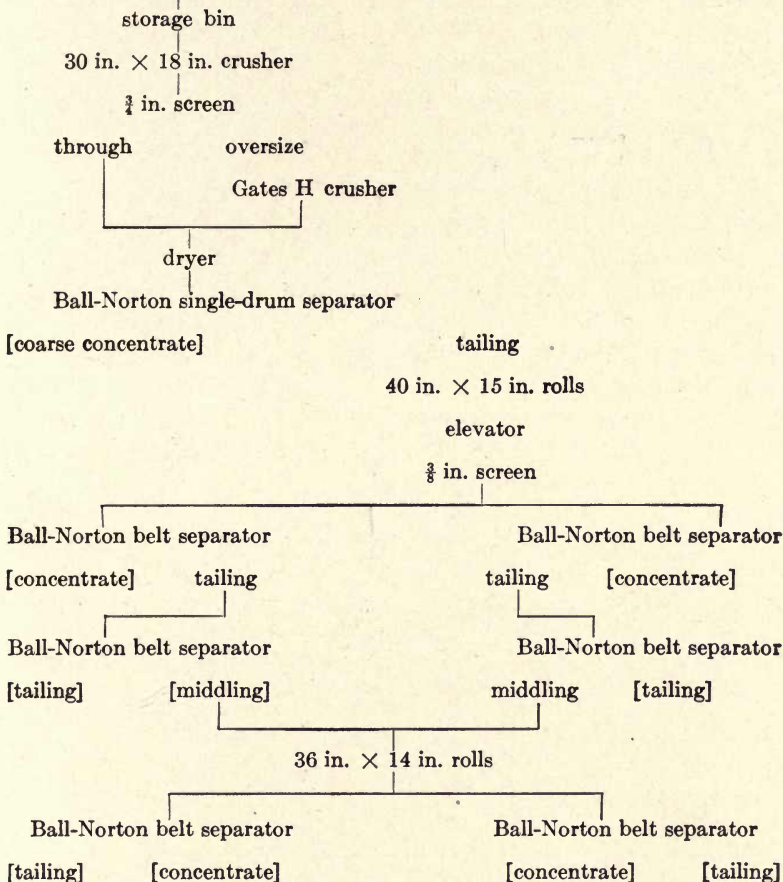

veyors without reference to the others. Between each two divisions bins are installed having storage capacity for a two-hours' run.

The Wetherill Type F separator is working on the same material as the Ball-Norton belt separators. The Wetherill Type E separators treat the tailing crushed to 10 and 16 mesh, from the

main battery of separators and make three products. The first belt removes any magnetite liberated by the secondary crushing, which

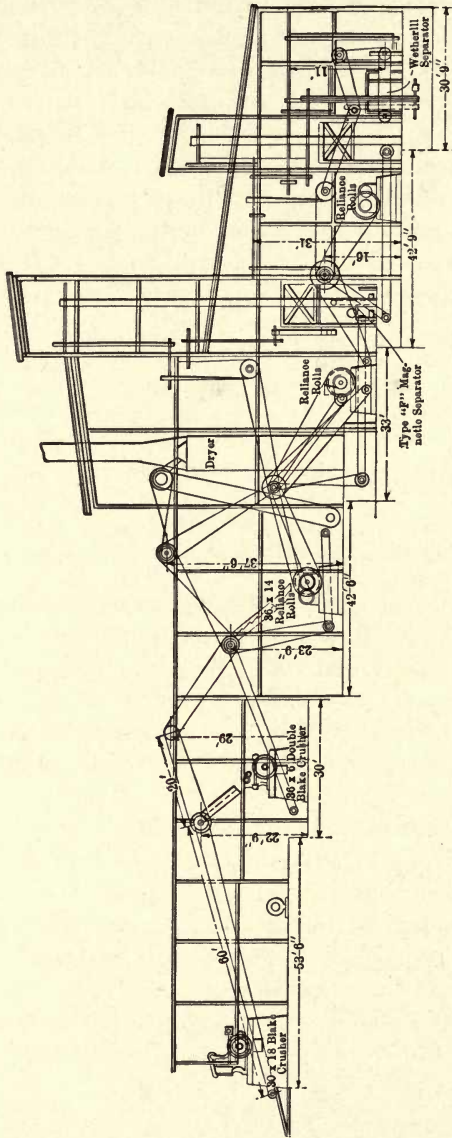

FIG. 52.—SECTION OF MILL NO. 2, MINEVILLE, NEW YORK.

is re-treated on a Ball-Norton belt separator, which makes a shipping concentrate and tailing. The second, third and fourth belts

make a hornblende product, which also carries the magnetic apatite mentioned as sometimes being found in these ores. The nonmagnetic discharge from these separators is called first grade apatite, consisting of apatite with pure white silica. The magnetite product from Mill No. 2 averages 65 per cent. iron and higher. The plant is arranged to re-treat this concentrate and produce a magnetite carrying in excess of 71 per cent. iron, which is sometimes made to supply the demand for the manufacture of the so-called "magnetite" electric lamps. The mill has a capacity of 800 tons of Old Bed ore in 10 hours. A table showing the average analyses of the crude ore and products of this mill for a year's run, together with the approximate amounts of the several products, follows:

MATERIAL	Amount daily. tons	Iron Per cent.	Phosphorus Per cent.	Bone Phosphate, per ct.
Crude ore, Old Bed	800	59.59	1.74
Old Bed Concentrate	680	67.34	0.675
First-grade apatite	60	3.55	12.71	63.55
Second-grade apatite	60	12.14	8.06	40.30

The other elements in the Old Bed concentrate are, silica, 2.2 per cent.; manganese, 0.08 per cent.; alumina, 0.90 per cent.; lime, 3.14 per cent.; magnesia, 0.31 per cent.; sulphur, trace. The first-grade apatite is the material passing off unaffected by the magnets of the Type E Wetherill separators; the second-grade apatite is the discharge from the last three belts of the same separators.

At *Lyon Mountain*¹ or *Chateaugay Mines, New York*, the ores carry from 25 to 40 per cent. iron, though richer bodies are occasionally found which run from 50 to 55 per cent. iron; the average iron content of the ores treated may be given as 35 per cent. The ore consists of magnetite with orthoclase, quartz, and pyroxene; accessory minerals are titanite, zircon and apatite, all present in small amounts. The magnetite is distributed through the mass, and also occurs in aggregates and stringers. The mill flow sheet follows:

The concentrate bins are of 600-ton capacity; there are two tailing bins; one for fine and one for coarse material, each of

¹ D. H. Newland and N. V. Hansell, *Eng. and Min. Journ.*, vol. lxxxii, p. 916.

FLOW SHEET FOR MILL NO. 2

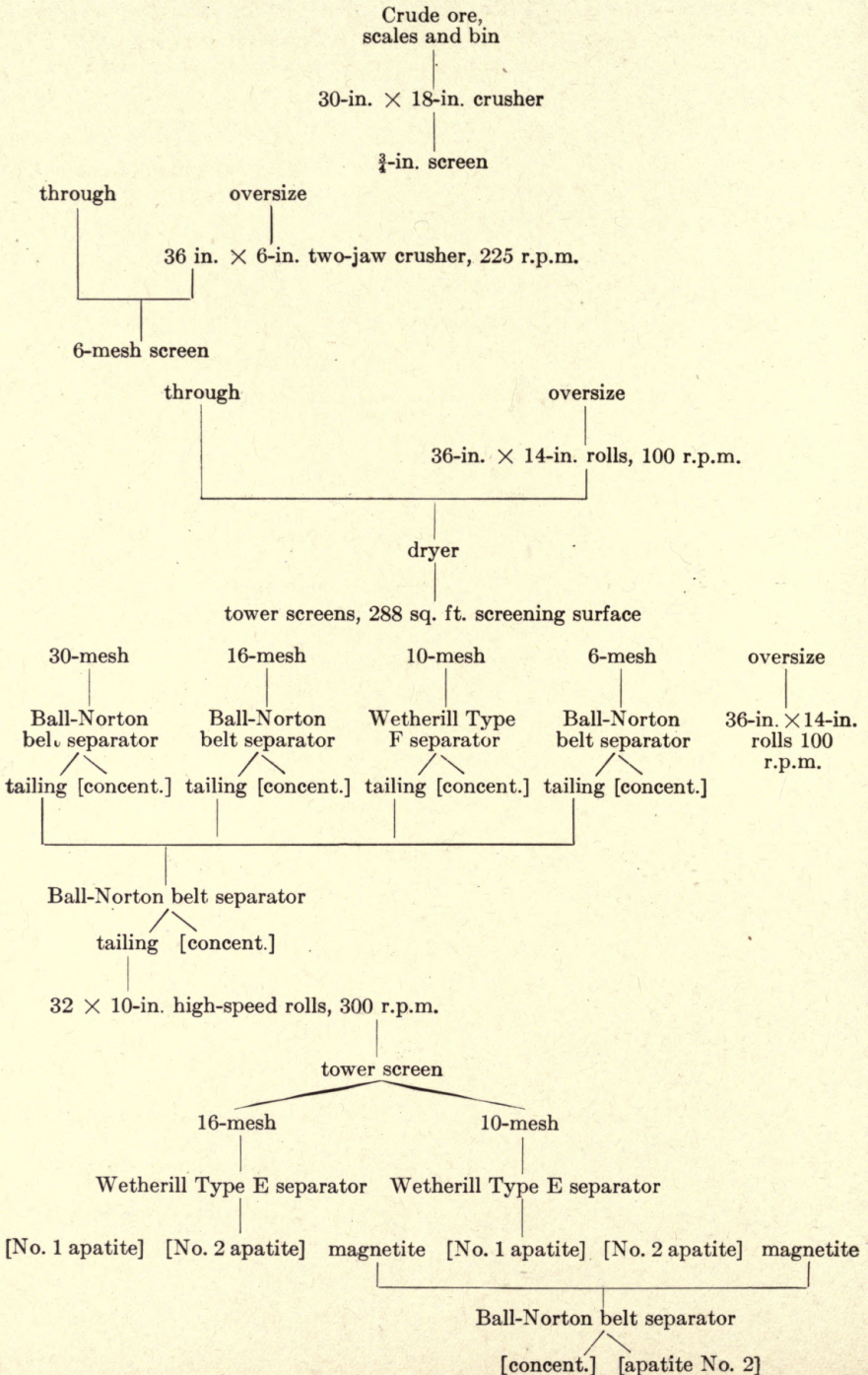

FLOW SHEET FOR LYON MOUNTAIN MILL.

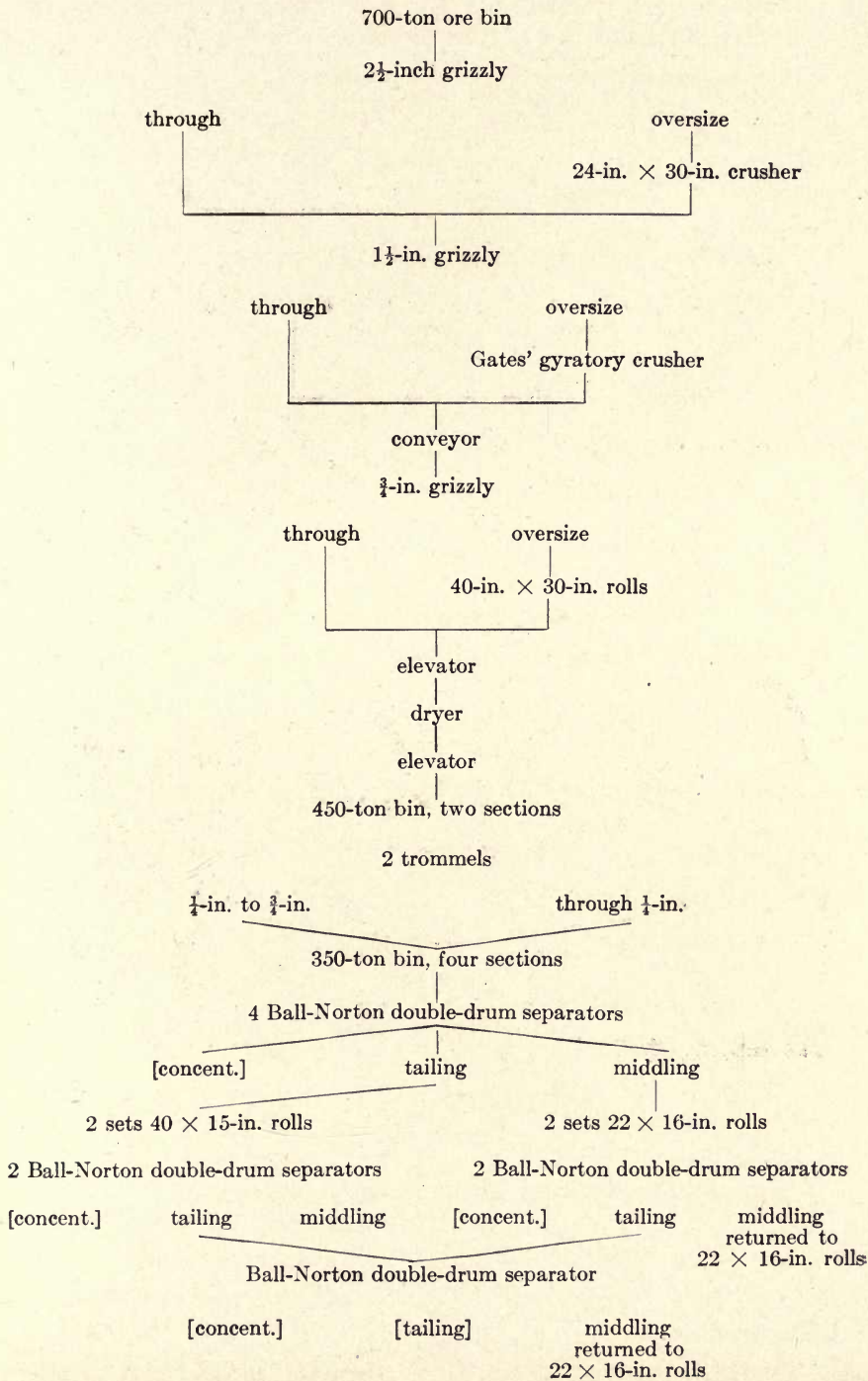

200 tons capacity. The dryer is vertical and 40 ft. in height; the ore drops between cross-laid T-bars coming into thorough contact with the heated gases. The furnace is situated 10 ft. above

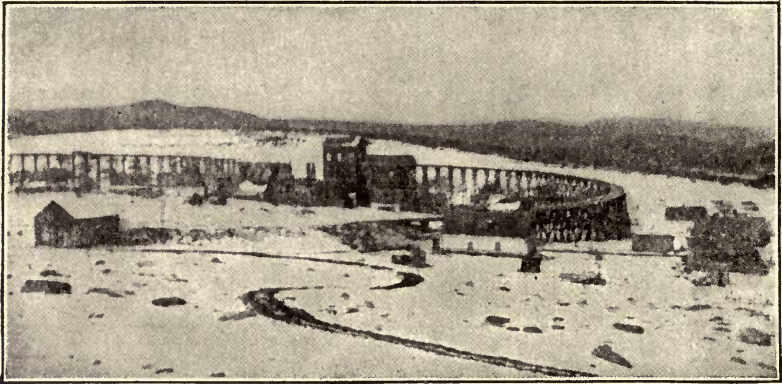

FIG. 53.—MINE AND TRESTLE AT LYON MOUNTAIN.

the bottom of the dryer, and the cold air feeding the furnace passes through the discharge outlet of the dryer, serving to cool the ore and heat the air before entering the fire-box. The tail-



FIG. 54.—MILL AT LYON MOUNTAIN.

ings are screened in a $\frac{1}{8}$ -in. trommel, and after grinding, used for locomotive sand; the coarse tailings have found a market as railroad ballast and material for concrete work. Power is furnished

by two 225 H. P. 3-phase induction motors; the actual running of the mill requires 250 KW. The capacity of the mill is in excess of 50 tons per hour. Sixteen men on each shift operate the mill; of these four attend to the crushers and rolls, three are required on the separators, one man fires the dryer, another is employed as oiler, one works in the motor room, and there is one foreman; the remainder of the shift dump, weigh, load, and sample the ore. Analyses of the crude ore and products follow:

	Crude Ore, Per cent.	Concentrate Per cent.	Tailing, Per cent.
Total iron.....	36.50	64.72	9.70
Iron as magnetite.....	34.30	64.53	6.00
Phosphorus.....	0.019	0.01	0.028
Titanium.....	0.089	0.083	0.096
Manganese.....	0.256	0.250	0.274

The average concentrate is said now to carry 63 per cent. iron and 0.01 per cent. phosphorus; the tailing being reduced to 4 per cent. iron. The Chateaugay ore commands a premium for the manufacture of low phosphorus iron.

At *Port Orem, New Jersey*, the New Jersey Iron Mining Co. is operating a magnetic-concentration plant on magnetite ores. The ore carries magnetite in stringers and grains in a gangue of quartz and some finely disseminated apatite. It is crushed in breakers and rolls to a size varying from 20 mesh to $\frac{1}{4}$ in., depending upon the ore treated. A modification of the Ball-Norton separator is employed. The ore carries about 25 per cent. iron and 1 per cent. phosphorus; the concentrate carries 61 per cent. iron and from 0.045 to 0.3 per cent. phosphorus; the tailing carries from 11 to 17 per cent. iron.

At *Hibernia, New Jersey*, the Joseph Wharton Mining Co. is operating a magnetic-concentrating plant on magnetite ores which carry from 38 to 40 per cent. iron, 0.04 per cent. phosphorus, and no sulphur. The ore is crushed by Buchanan breakers and rolls to $\frac{1}{4}$ in., and is separated upon a Ball-Norton double-drum separator. One hundred tons of ore yield 40 tons of concentrate, 20 tons of middling, and 40 tons of tailing. The middling is recrushed in tight rolls and repassed. The concentrate carries from 63 to 64

per cent. iron and 0.008 per cent. phosphorus; the middling product carries 40 per cent. iron, and the tailing from 5 to 6 per cent. iron. Dust is withdrawn from the separator by a fan, and after settling in a dust chamber, is sent to the waste dump.

At *Lebanon, Pennsylvania*, the Pennsylvania Steel Co. is operating a plant equipped with Grondal Type V separators. The capacity of the plant is 300 long tons of 60 per cent. iron concentrate per twelve-hour shift, from a raw ore carrying 40 per cent. iron.

At *Solsbury, New York*, the Solsbury Iron Co.¹ is completing a magnetic-concentration mill equipped with Ball-Norton single-drum and Ball-Norton belt separators, having a capacity of 500 tons in 20 hours. The ore is passed through gyratory crushers, screened, and the oversize on 1.5-in. screens passed over cobbing separators; the undersize, reduced to 30 mesh, is passed through a drying tower and separated on the belt-type separators. It is expected to ship a product carrying 69 per cent. iron from the 30-mesh material and a 60 per cent. coarse concentrate from the cobbing separators.

At *Mount Hope, New Jersey*, the Empire Steel & Iron Co. is completing a magnetic cobbing plant equipped with Ball-Norton separators and having a capacity of 600 tons daily.

At *Benson Mines, New York*, the Benson Iron Ore Co. is building a magnetic-separation mill with an estimated capacity of 3000 tons daily. Steam shovels are used to mine the ore, which is crushed in Edison giant rolls and separated on Ball-Norton separators.

At *Port Henry, New York*, the Cheaver Iron Ore Co. is building a magnetic-concentration mill equipped with Ball-Norton separators.

At *Herrang, Sweden*,² the Herrangs Grufaktiebolag is operating a magnetic-concentration and briquetting plant of 50,000 metric tons yearly capacity. The ore carries about 40 per cent. iron with 1.2 per cent. sulphur and 0.003 per cent. phosphorus. The gangue consists partly of pyroxene and garnet. The ore is broken to $\frac{1}{2}$ in. in breakers and ground in Grondal ball mills to 1 mm.

This mill consists of a horizontal cylinder built up of longitud-

¹ Communicated by F. R. Switzer, Asst. Treas., Utica, N. Y.

² Communicated by the Grondal-Kjellin Company, Ltd., London, England.

inal steel ribs, with cast-iron end-plates. Through one end of the cylinder the ore is introduced with water over a roller feeder. The crushing is done by chilled cast-iron balls ranging in size from 6 ins. in diameter downward. No screens are required, the degree of fineness to which the ore is ground being regulated by the speed of the water current passing through the cylinder. The wear of the balls is about 2 lbs. for each ton of ore ground. The

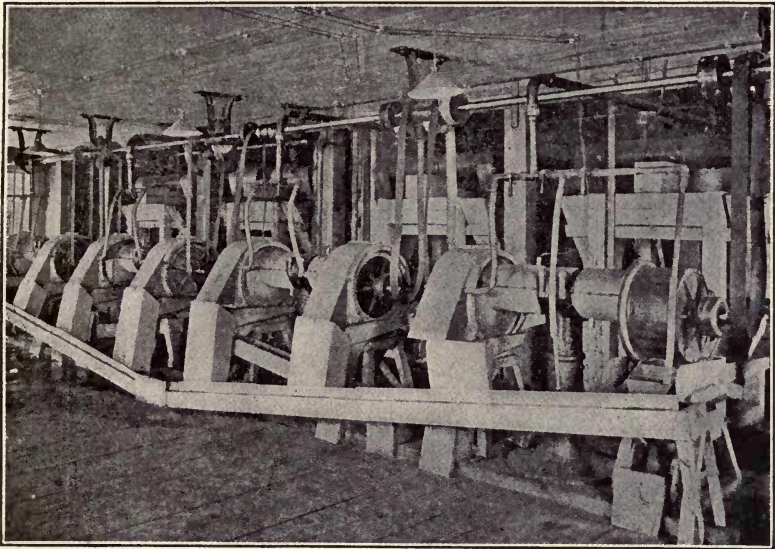

FIG. 55.—GRONDAL SEPARATORS AT HERRANG.

force required for each mill is from 20 to 25 H.P.: the capacity is from 50 to 100 tons per 24 hours, varying with the hardness of the ore and the fineness to which it is reduced.

The pulp from the ball mills is passed through two V-shaped settling boxes from which the sand is drawn off through a pipe at the bottom; the slime remaining in suspension in the water is subjected to magnetic treatment by a pair of Grondal slime magnets. The sand and magnetic slime are treated on Grondal Type III and Type V separators. The concentrate carries from 60 to 65 per cent. iron with 0.17 per cent. sulphur and 0.0025 per cent. phosphorus. The tailing product carries from 5 to 15 per cent. iron, and the waste slime 9.6 per cent. iron.

The powdered concentrate is pressed into briquettes without

the use of binding material, the moisture in the concentrate being regulated to give a briquette sufficiently firm to bear handling from the press to the car used in the furnaces. The finished briquettes carry 63 per cent. iron with 0.003 per cent. sulphur and 0.0025 per cent. phosphorus; they are hard but porous, the percentage of porosity being 23.9 per cent. Such a plant as is described above costs in the neighborhood of \$50,000 to erect, and requires 20 men, 200 H.P. and 465 gallons of water per minute to

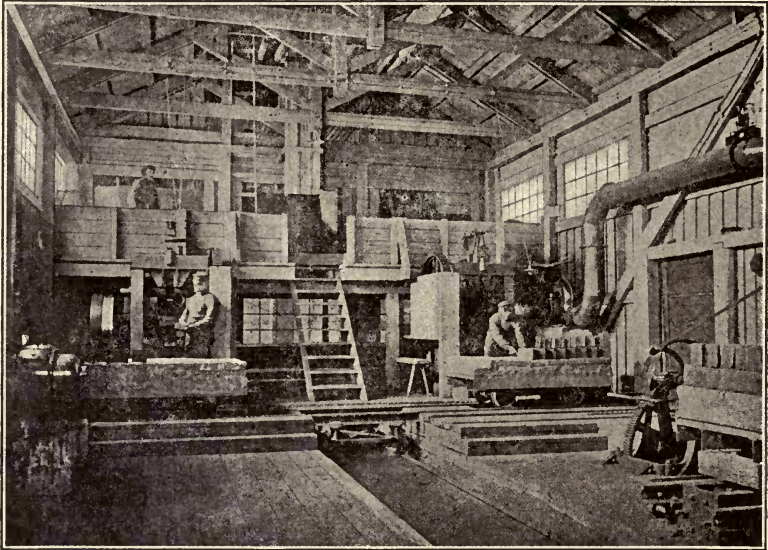

FIG. 56.—BRIQUETTING PLANT AT HERRANG.

operate.¹ It is probable that where a higher scale of wages obtains economical operation would demand labor-saving appliances and permit a reduction in the working force.

At *Edison, New Jersey*,² there is a large installation for the treatment of magnetite ores, designed by Mr. Thomas A. Edison and erected by the New Jersey and Pennsylvania Concentrating Co. Between the time of the design of this mill and its completion a severe drop was experienced in the iron-ore market, due to the discovery of the Mesabi ore beds; the mill in consequence has never been operated except in an experimental way. The mill

¹ Professor Petersson, *E. & M. J.*, May 11, 1907.

² Richard's "Ore Dressing," p. 1057.

contains so many valuable ideas and is on such a large scale that it merits description. The plant was designed for 4000 tons capacity per 24 hours, but has put through 300 tons per hour, which is at the rate of 6000 tons per 20 hours. The ore consists of magnetite in a gangue of feldspar with a little quartz and apatite. The ore is mined in open quarries and contains lumps up to 5 tons in weight. It is loaded by steam shovels and dumped on skips holding 6.5 tons each, which are hauled to the mill on cars by locomotive. The skips are of the open, flat form used in quarry work and are suspended by two chains and hooks at the front end and by one chain and hook at the rear; they are lifted at the mill by two electric traveling cranes and then, by unhooking the two front hooks, they are dumped to (1).

1. One No. 1 roller feeder, 3 ft. diameter and 6 ft. long. To hopper 6 ft. square and thence to (2).

2. One pair of No. 1 giant rolls, 72 ins. \times 72 ins., set 14 ins. apart. To (3).

3. One pair No. 2, or intermediate rolls, 48 ins. \times 60 ins., set 7 ins. apart. By No. 1 bucket elevator to (4).

4. One pair No. 3 or first corrugated rolls, 36 ins. \times 36 ins., set 3.5 ins. apart. To (5).

5. One pair No. 4 or second corrugated rolls, 36 ins. \times 36 ins., set 1.5 ins. apart. To (6).

6. One pair No. 5 or third corrugated rolls, 24 ins. \times 20 ins., set $\frac{1}{2}$ in. apart. By No. 1 belt conveyor and thence by No. 2 bucket elevator to (7).

7. Three No. 1 fixed screens in series, the upper one having $1\frac{1}{2}$ \times 3-in. slots and the two lower $1\frac{1}{4}$ -in. \times $2\frac{1}{2}$ -in. slots. Oversize, bolts, roots, etc., to dump; undersize to (8).

8. One No. 1 dryer in the form of a drying kiln with a distributor at the top. By No. 2 belt conveyor, and thence by No. 3 bucket elevator, followed by Edison distributing conveyor to (9).

9. No. 1 stock house, holding 16,000 tons. By No. 4 bucket conveyor to (10).

10. Bin holding 25 tons. By two No. 2 corrugated roller feeders to (11).

11. From (10) and (12). Two sets of No. 6 or three high rolls, 36 ins. \times 30 ins., set close together, but the feed opens them to about $1\frac{1}{2}$ ins. Only one set is run at a time. The crushed ore is carried in succession by two No. 5 belt conveyors, one No. 6

bucket conveyor, one No. 5 bucket elevator, one No. 7 Edison distributing conveyor, and twenty No. 3 roller feeders to (12).

12. Two hundred and forty No. 2 fixed inclined screens arranged in sixty sets, with four screens in series in each set, having $\frac{1}{16}$ -in. \times $\frac{1}{2}$ -in. slots. Oversize to (11); undersize to (13).

13. Sixty No. 1 Edison magnetic separators. These are 12-in. magnets and are arranged in twenty sets, with three magnets in series in each set. Heads by two No. 8 belt conveyors to (14); tailings by No. 9 belt conveyor to (22).

14. One No. 2 dryer in the form of a drying kiln with a distributor at the top. To (15).

15. From (14), (16), and (19). Two sets No. 7 or three-high rolls, 36 ins. \times 30 ins., set close together, but the feed opens them to about $\frac{1}{2}$ in. Only one set is run at a time. The crushed ore is carried in succession by two No. 10 belt conveyors, one No. 11 bucket conveyor, one No. 6 bucket elevator, one No. 12 Edison distributing conveyor, and twenty No. 4 roller feeders to (16).

16. Two hundred and forty fixed inclined screens, No. 3, arranged in sixty sets, with four screens in series in each set, having $\frac{1}{16}$ -in. \times $\frac{1}{2}$ -in. slots. Oversize to (15); undersize to (17).

17. Ninety-six Edison magnetic separators. They are 8-in. magnets and are arranged in thirty-two sets, with three magnets in series in each set. Heads to (18); tailings to (22).

18. Eight dusting chambers. Heavy material to (19); light material to (20).

19. Three hundred and twenty No. 3 Edison magnetic separators. They are 4-in. magnets and are arranged in sixty-four sets with five in series in each set. Heads to (21); tailings from first or upper magnets to (22); tailings from second, third, fourth, and fifth magnets to (15).

20. From (18). One No. 4 Edison magnetic separator for fine material. Heads to (21); tailings are sold for paint.

21. From (19) and (20). No. 2 and No. 3 stock houses with a total capacity of 35,000 tons. From these the concentrates pass in succession through the mixers, the briquetting machines and the baking ovens.

22. From (13), (17), and (19), sand house. Tailings are here sized and sold for mortar sand, etc.; on account of proximity to large cities this material is in demand.

The labor required for mining, milling, and briquetting is 311

men per 24 hours, divided into two shifts of 10 hours each, 46 men and boys mining by day and 46 by night; 24 men by day and 24 by night in the coarse-crushing house—to and including (9); 32 men by day and 32 by night in the fine-crushing and separating house; and 66 men by day and 41 by night doing general work.

Power is furnished by steam. A single Corliss engine of 300 H.P. runs the dynamos for the magnets, for lighting, and for the two electric cranes, which require 50 to 80 H.P. each. A cross-compound engine of 700 H.P. runs the coarse-crushing plant. A triple-expansion vertical engine of 500 H.P. runs the three-high rolls, elevators, conveyors and fans of the fine-crushing and separating plant.

The ore contains about 20 per cent. iron and 0.7 per cent. to 0.8 per cent. phosphorus; the heads of No. 1 magnets (13) contain 40 per cent. iron and the tailings 0.8 per cent. iron; the heads from No. 2 magnets (17) contain 60 per cent. iron; the heads from the dusting chambers (18) contain 64 per cent. iron; the heads from the No. 3 magnets (19) contain from 67 to 68 per cent. iron, the mill tailing carries 1.12 per cent. iron. Analysis of the briquettes show 67 to 68 per cent. iron, 2 to 3 per cent. silica, 0.4 to 0.8 per cent. alumina, 0.05 to 0.10 per cent. manganese, a trace each of lime, magnesia and sulphur, 0.028 to 0.033 per cent. phosphorus, 0.75 per cent. resinous binder, and no moisture. One hundred tons of ore yield about 24 tons of concentrate and 76 tons of tailing. The tailing from No. 1 magnets amounts to 55 per cent. of the ore fed to the mill.

An especially noticeable feature of the mill is the absence of graded crushing and sizing; this is allowable because fine ore is not considered a source of loss in the magnetic treatment.

At *Guldsmédshyttan, Sweden*, the *Guldsmédshytte Aktiebolag* is operating a concentrating and briquetting plant of 60,000 tons yearly capacity similar to the Herrang installation above described. Grondal No. V separators are employed.

At *Svarto, near Lulea*,¹ a magnetite ore rich in phosphorus is being separated for the value of the apatite as well as the cleaned iron concentrate. This plant was erected in 1897 by the Norbotom Ore Improvement Co. to treat ores from the Gellivara Mines. The ore carries from 0.01 to 3 per cent. phosphorus, averaging 1

¹T. Beckert, *Zeit. Ver. D. Ing.*, vol. xli, p. 1307; E. Langguth, "Electromagnetische Aufbereitung," p. 61; *E. & M. J.*, vol. lxx, p. 645.

per cent.; the average iron content is 58 per cent. The texture of the ore materially aids in the saving of the apatite, as it consists of sharply defined crystals of the different minerals whose cohesion is low.

The run of mine ore is subjected to a rough hand picking and then crushed in a Blake crusher and Swensen rolls to pass a 14 mm. screen. The ore is then dried in a cylindrical dryer 10 meters long by 1.4 meters diameter, inclined at an angle of 5 degrees. The cyl-

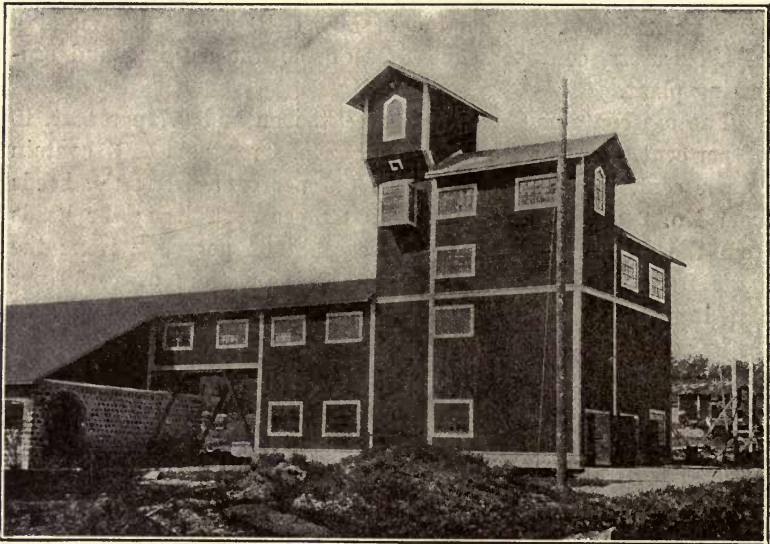

FIG. 57.—MAGNETIC CONCENTRATION MILL AT GULDSMEDSHYTTAN.

inder rotates once in 5 seconds and is heated by a stream of hot gases from a fire box at the lower end. The ore is fed to the cylinder by revolving feed plates and at the discharge falls into rolls which reduce it to pass a 1-mm. screen.

The separation is accomplished by four Monarch separators, arranged in two independent units, two machines tandem. The first separator of each unit makes a clean magnetite product, a tailing rich in phosphorus, and a middling product which is re-treated on the second separator, which makes two products only, tailing rich in phosphorus, and a concentrate. The dust is removed from the Monarch separators by an exhaust fan and treated on a Herbele wet-type separator. The iron product amounts to 85 per cent.

of the feed and carries 70 per cent. iron, and 0.127 per cent. phosphorus. The tailing from the separators carries 25.5 per cent. iron and 13.7 per cent. phosphorus.

The tailing is jigged and the apatite removed as far as possible from the magnetite by water concentration. The apatite product is then treated chemically for the removal of remaining magnetite and ground to an impalpable powder in a ball mill using flint grinding balls. The powdered apatite is mixed with calcined soda ash and heated to a dull-red heat in a two-stage calcining furnace. The product is finely ground, and as shipped contains 30 per cent. phosphoric acid in soluble form; it is used as a fertilizer. The mill flow sheet follows on page 104.

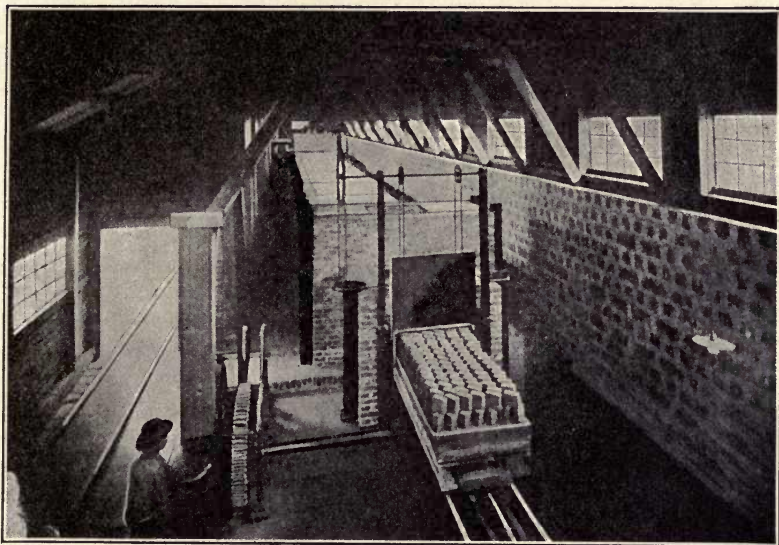

FIG. 58.—BRIQUETTING FURNACE AT GULDSMEDSHYTTAN.

The capacity of the plant is from 2000 to 2500 metric tons per week. The separators take 7 amperes at 100 volts.

At *Grangesberg, Sweden*, a magnetic concentration plant, equipped with Eriksson, Forsgren and Wenstrom separators, is treating ores carrying magnetite and hematite in a quartz gangue. The mill flow sheet follows on page 105.¹

At *Dannemora, Sweden*, a magnetic cobbing plant constructed

¹ Professor Petersson, *E. & M. J.*, vol. lxxxiii, p. 889.

FLOW SHEET FOR THE SVARTO MILL

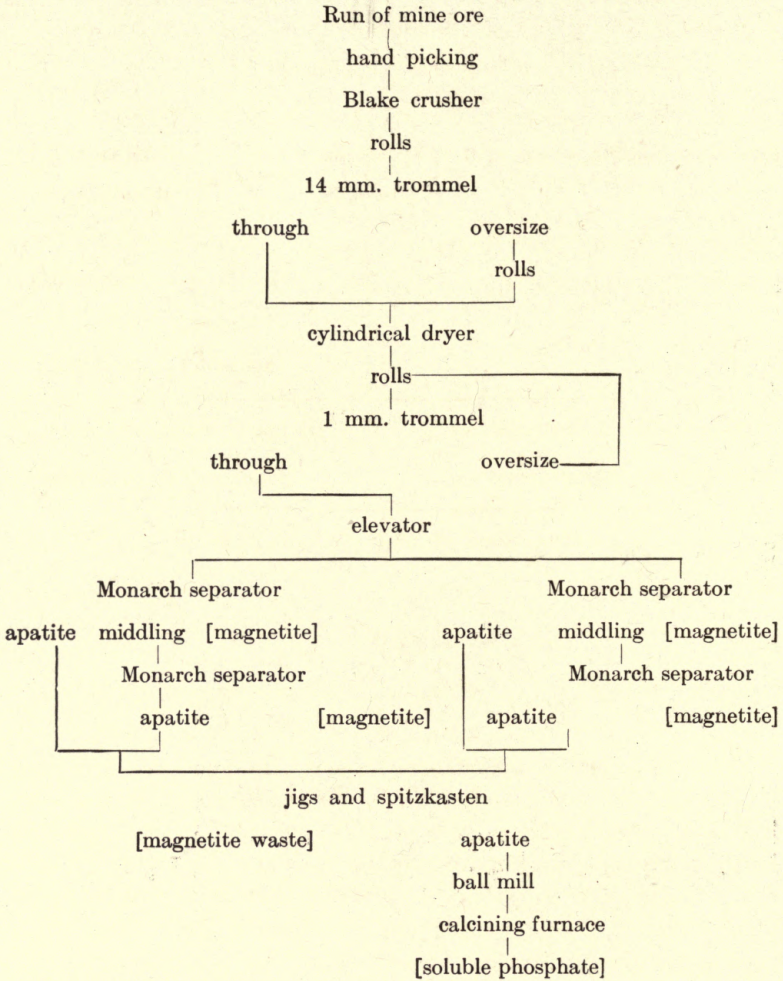

in 1903 is in operation on small ores; the Wenstrom separator is employed. The run of mine ore is subjected to hand picking, a clean magnetite product carrying up to 60 per cent. being thrown out and sent directly to the furnaces. The ore is lifted by elevator to the top floor of the mill and dumped into a bin of 1.5 cu. yds. capacity. The mill flow sheet follows on page 106.¹

¹ Professor Petersson, *E. & M. J.*, vol. lxxxiii, p. 890.

FLOW SHEET FOR THE GRANGESBERG MILL

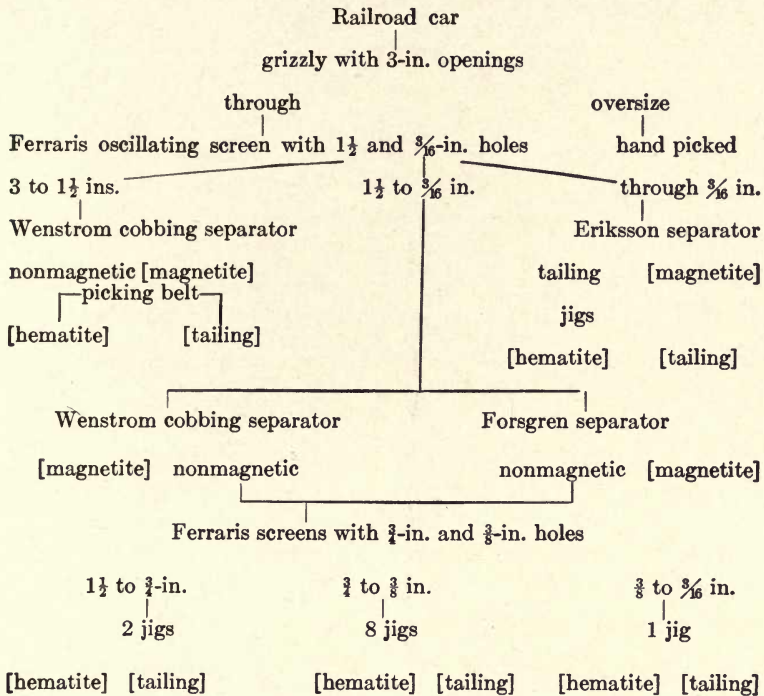

The crude ore carries magnetite, hematite, and pyrites in pegmatite and schistose material. The ore carries about 40 per cent. iron and the concentrate from 60 to 61 per cent. iron. The concentrate is roasted to remove sulphur.

At *Flogbeget*,¹ near *Ludvika, Sweden*, magnetic concentration plant built in 1906 and employing the Grondal Type V separator is in operation on magnetic ores.

At *Klacka, Sweden*, the *Klacka-Lerbergs Grufvebolag* is operating a magnetic concentration plant equipped with Wenstrom cobbing separators for the sizes coarser than $\frac{3}{4}$ in. and the Grondal Types I and II for the fine sizes.

After passing the ball mills 77 per cent. of the pulp passes 0.15 mm. The ore carries from 38 to 39 per cent. iron, and the concentrate, amounting to 45.9 per cent. of the feed, 58 to 59 per

¹ Professor Petersson, *E. & M. J.*, vol. lxxxiii, p. 889.

FLOW SHEET FOR THE DANNEMORA MILL

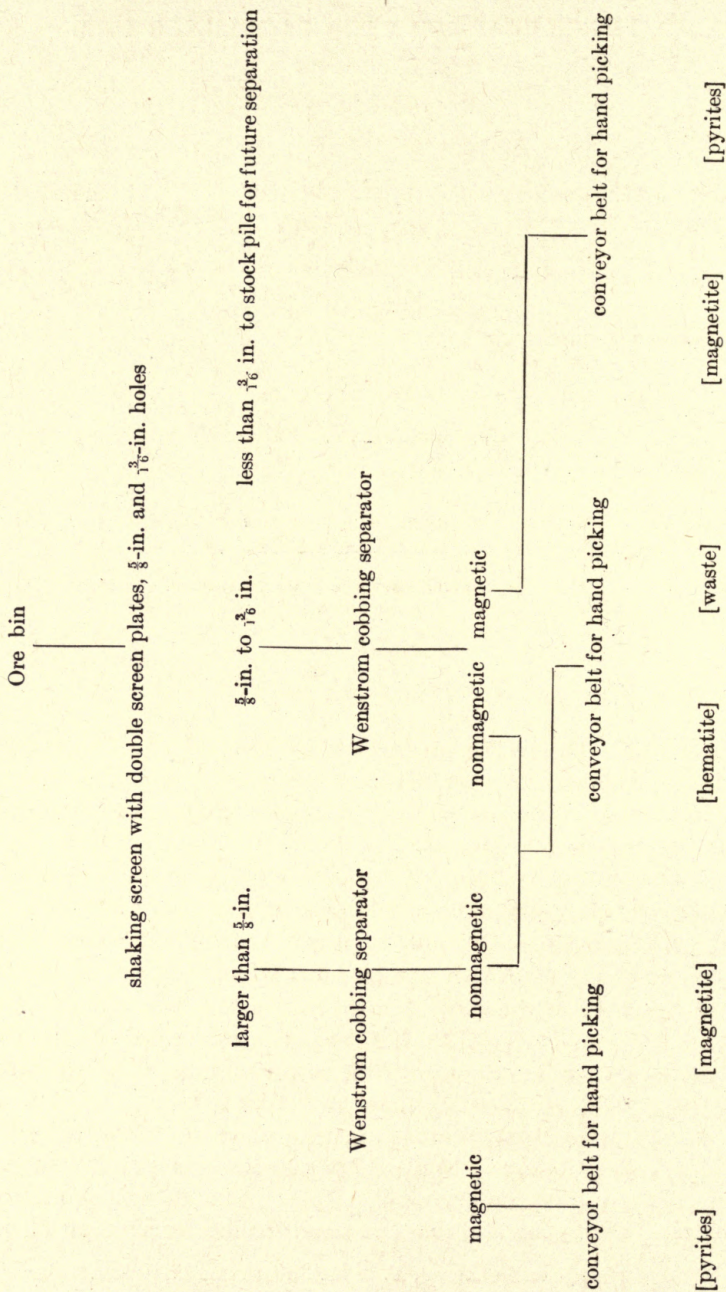

FLOW SHEET FOR THE FLOGBEGET MILL

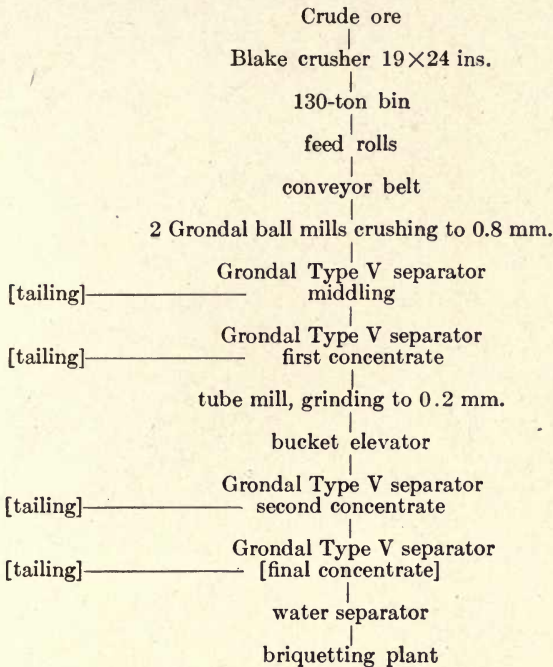

cent. iron. The tailing product carries from 12.7 to 14.6 per cent. iron.¹ The plant is operated by 6 men, and requires 20 H.P. and 200 liters of water per minute. The mill produces 20 metric tons of concentrate per day.

At *Persberg, Sweden*,¹ a Grondal Type I separator is treating low-grade magnetite ore carrying from 15 to 20 per cent. iron. The ore is crushed in a ball mill to pass 5 mm. The finished product carries 57 per cent. iron and amounts to 21 per cent. of the feed. The capacity of the plant is 2500 metric tons per annum. Eight men are employed and 55 H.P. are required to operate the plant. The water consumption is 200 liters per minute. The separator is excited by from 5 to 7 amperes at 30 volts.

At *Romme, Sweden*, a lean magnetite ore carrying 22 to 25 per cent. iron is separated by Grondal Type II separators. The ore is crushed in a ball mill to pass 1.5 mm. The finished product carries from 60 to 64 per cent. iron and the tailing averages 10.6 per

¹ Dr. Weiskopf, "Stahl und Eisen," vol. xxv, p. 532.

FLOW SHEET FOR THE KLACKA MILL

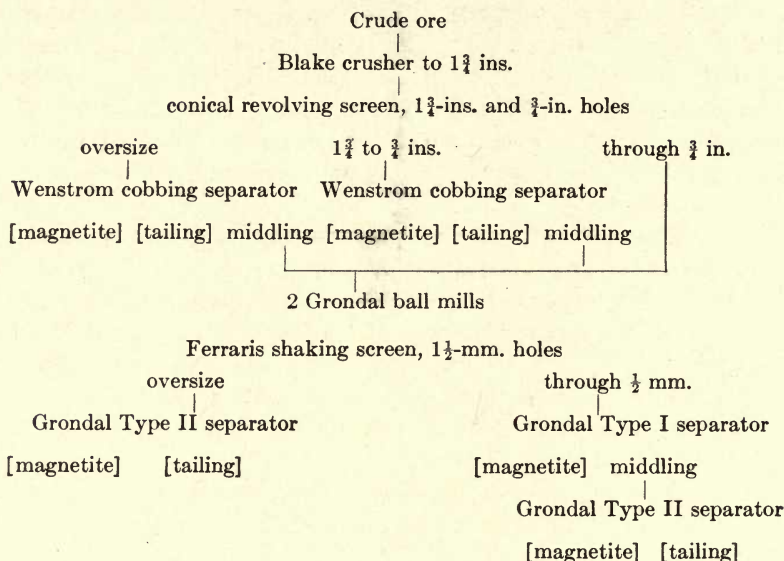

cent. iron. Each separator puts through ¼ metric ton per hour; the magnets are excited by 3 amperes at 90 volts. Fourteen men and 60 H.P. are required to operate the plant. The water used amounts to 600 liters per minute.¹

At *Strassa, Sweden*, Grondal Type I and Type II separators are treating ore carrying 36.8 per cent. iron, 0.014 per cent. phosphorus, and 0.11 per cent. sulphur. The ore is crushed to pass 1 mm. in ball mills. The finished product carries 61.58 per cent. iron, 0.006 per cent. phosphorus, and 0.045 per cent. sulphur; it amounts to 45.5 per cent. of the raw ore. The tailing carries 12 per cent. iron. The mill has a capacity of from 30 to 40 metric tons daily and employs 17 men. From 30 to 35 H.P. are required to operate the plant, and from 150 to 200 liters of water are used per minute. The separator is excited by 1.7 amperes at 30 volts.¹ A Grondal Type V separator and a briquetting plant has been added to this installation.

At *Bredsjo, Sweden*, a Grondal Type II separator is treating a magnetite ore carrying 45.3 per cent. iron, 0.0083 per cent. phosphorus, and 0.198 per cent. sulphur. The ore is crushed to pass

¹ Dr. Weiskopf, "Stahl und Eisen," vol. xxv, p. 532.

1.5 mm. The finished product amounts to 48.6 per cent. of the feed and carries 64 per cent. iron, 0.0023 per cent. phosphorus, and 0.082 per cent. sulphur. The tailing carries 7 per cent. iron. 40 H.P. are required to operate the plant, which employs 4 men and has a capacity of 30 metric tons per day.¹ A Grondal Type V separator has recently been added to this plant. The concentrate is briquetted. The present capacity of the plant is 40,000 metric tons per annum.

At *Norberg, Sweden*, an Ericksson separator is used at the Kallmora Separating Works, treating magnetite ores.

At *Bagga, Sweden*, a Grondal Type I separator is working on an ore carrying magnetite, hematite, amphibole and quartz. It averages from 30 to 40 per cent. iron. The finished product amounts to 63.7 per cent. of the raw ore and carries from 60 to 62 per cent. iron. Ball mills are used for fine grinding. The magnets are excited by from 8 to 10 amperes at 35 volts.¹

At *Lomberget, Sweden*, a magnetic-concentration mill employing the Forsgren separator has been in operation on magnetite ores since 1903.

At *Bjornberget, Sweden*, a magnetic-concentration mill employing the Ericksson separator has been in operation on magnetite ores since 1904.

At *Kungsgrufvan, Sweden*, a magnetic-concentration mill employing the Froeding separator has been in operation on magnetite ores since 1905.

At *Langgrufvan, Sweden*, a magnetic-concentration mill employing the Froeding separator has been in operation on magnetite ores since 1905. A Morgardshammer separator has recently been added to this plant.

At *Vintjarn, Sweden*, a magnetic-concentration mill erected in 1906 is in operation on magnetite ores employing the Hallberg separator.

At *Hjulsjo, Sweden*, a magnetic-concentration mill erected in 1906 is in operation on magnetite ores. The Grondal Type V separator is employed. The concentrate is briquetted.

At *Lulea, Sweden*, the Karlsvik Mill, built in 1906, is treating magnetite ores on Grondal Types IV and V separators. The concentrate is briquetted. The crude ore carries 1 per cent. phosphorus, which is reduced to 0.005 per cent. in the concentrate.

¹ Dr. Weiskopf, "Stahl und Eisen," vol. xxv, p. 532.

At *Uttersberg, Sweden*, the *Uttersberg Bruks Aktiebolag* is operating a magnetic-concentration mill on magnetite ores. The plant was built in 1906 and has a yearly capacity of 12,000 metric tons. The *Grondal Type V* separator is employed. The concentrate is briquetted.

At *Syd Varanger, Norway*,¹ a magnetic-separation plant having a yearly capacity of 1,200,000 tons of crude ore is being installed. It will contain 56 *Grondal* ball mills, 200 *Grondal No. 5* separators, and 20 *Grondal* briquetting kilns. The ore will be mined by steam shovels. The test runs on this ore give the following results:

	Per cent. Iron	Per cent. Sulphur	Per cent. Phosphorus
Crude ore.....	38.0	0.066	0.030
Concentrate.....	68.3	0.026	0.014
Tailing.....	5.5
Briquette.....	68.0	0.006	0.014

It is expected to produce 600,000 tons of briquettes yearly, which will be shipped to Germany.

At *Salangen, Norway*, a *Grondal* concentrating and briquetting plant having a yearly capacity of 300,000 tons of ore is being installed. The test runs on this ore give the following results:

	Per cent. Iron	Per cent. Sulphur	Per cent. Phosphorus
Crude ore.....	35.7	0.039	0.23
Concentrate.....	69.3	0.019	0.009
Tailing.....	4.9

It is expected to produce 100,000 tons of briquettes yearly, which will be shipped to Germany.

At *Langbau Risberg, Kantorp*, and *Striberg, Sweden*,² the following type of mill is used for the separation of magnetite and hematite from waste:

¹ *Jour. Can. Mining Inst.*, vol. xi, p. 153. P. McN. Bennie.

² Dr. Weiskopf, "Stahl und Eisen," vol. xxv, p. 532.

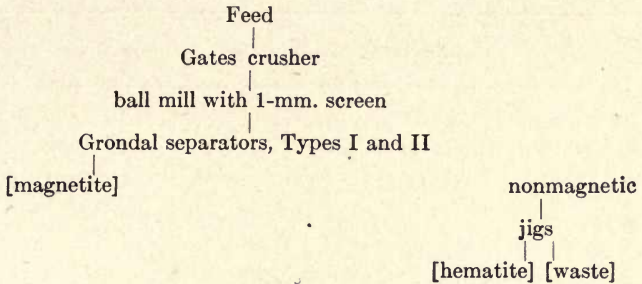

At *Pitkaranta, Finland*, a plant equipped with Dellvik-Grondal separators has been in operation since 1894, treating a low-grade magnetite ore. The ore carries magnetite in tough serpentine accompanied by small amounts of blende, pyrite, chalcopyrite, and pyrrhotite. The ore, which is intimately mixed, is crushed with difficulty; the average size of grain is somewhat less than $\frac{1}{2}$ mm. The ore carries on an average 30 per cent. iron, of which 80 per cent. only is in the form of magnetite, the balance being chemically combined as sulphides and silicates; it carries from 4 to 5 per cent. sulphur. The first mill was built in 1894 and was enlarged to 350 metric tons daily capacity in 1898; it is situated at Ladogasse 3.5 to 7 km. from the mines, with which it is connected by rail.

The tracks from the mines deliver ore into bins 10 meters above the sill floor of the mill, from which the crushers are fed direct. There are four rock breakers which handle ore up to 250 mm. size. From the breakers the ore is delivered in egg size to eight Grondal ball mills. The ball mills are cast-iron cylinders lined with armor plate; there are two sizes employed. Four of the mills are 1.75 meters in diameter by 0.8 meter long, and four are 2 meters diameter by 1 meter long. The cylinders are turned on an inclined axis, the crushing being accomplished by cast-steel balls. The smaller mills are employed on the more easily crushed ores and put through from 8 to 50 tons in 24 hours; the larger mills were designed especially for the hardest ore and treat 30 tons per 24 hours. The linings are renewed once in 15 months, and fresh balls are introduced from time to time. The ore is crushed to pass 1 mm., but a large percentage is much finer; a screen analysis of the discharge of ball mills follows:

Size in millimeters	Per cent. of Total
Over 1 mm.....	1.7
1.0 to 0.5.....	1.2
0.5 to 0.33.....	3.8
0.33 to 0.25.....	7.5
0.25 to 0.16.....	22.4
0.16 to 0.125.....	19.6
Through 0.125.....	43.8
	100.0

Tests on the discharge of the mills show but 44 per cent. of the magnetite to exist as free particles, and as a result the concentrate rarely exceeds 61 per cent. iron; a higher-grade concentrate could be made, but it would be at the expense of such a loss in the tailing as to eliminate profit on this low-grade ore. The products from the old mill carried from 65 to 71 per cent. iron in the concentrate and 1 to $1\frac{1}{2}$ per cent. iron present as magnetite in the tailing; the new mill concentrate carries from 59 to 61 per cent. iron, and the tailing from $\frac{1}{2}$ to 1 per cent. iron present as magnetite. The raw ore contains from 0.08 to 1 per cent. phosphorus; the concentrates average 0.042 per cent. phosphorus; the sulphur in the concentrate is 0.6 per cent., mostly as blende, which mineral is intimately associated with the magnetite.

The separators take 8 amperes at 35 volts and put through from 25 to 50 tons of ore per day, according to the iron content. The ball mills deliver by gravity to the separators which are 2 meters above the working floor and 5 meters above the highest waste discharge.

The fine concentrate is allowed to drain for a few days and is then pressed into briquettes which are sintered into a firm mass by exposure to a heat of 800° C., which also largely eliminates the sulphur.

In 1900 425-kgm. of 61 per cent. concentrate were made from one ton of raw ore. One metric ton of 61 per cent. concentrate cost \$3.40 during the same period.

Power is derived from a waterfall 7 km. from the mill and transmitted by electricity: the ball mills, crushers, and separators take 160 E.H.P. and the elevator, pumps, and railroad respectively

8, 6, and 25 E.H.P. In winter the feed water is warmed to 7 or 8° C.¹

SEPARATION OF MAGNETITE AS AN IMPURITY

Certain ores of zinc and lead, corundum, etc., carry magnetite where this mineral is regarded as an objectionable impurity and from which it is eliminated by magnetic separation.

At *Santa Olalla, Huelva, Spain*,² the Sociedad Minas de Cala is operating a magnetic separating plant on magnetite ores carrying chalcopyrite, and also experimenting on a mixture carrying the same minerals with hematite and silica.

The ore is reduced by jaw crusher to 3 to 5 cm. and delivered by bucket elevator to hopper bins having capacity for 10 hours' run. From these bins the ore is fed to a Smidt ball mill by an Eriksson automatic feeder, and reduced to pass 1 mm. This pulp is sent by launder to an Eriksson magnetic separator. The results of the separation follow:

SEPARATION OF MAGNETITE AND QUARTZ

	Fe Per Cent.	SiO ₂ Per Cent.
Feed.....	39.33	26.86
Concentrate (1 mm.).....	55.20	15.06
Concentrate (½ mm.).....	61.02	9.26
Waste.....	6.21	54.50

SEPARATION OF CHALCOPYRITE FROM MAGNETITE

	Fe Per Cent.	Cu Per Cent.
Feed.....	61.55	0.27
Magnetic product.....	65.47	0.06
Nonmagnetic product.....	50.00	1.18

¹ Gustav Grondal, "Oest. Zeit. B., H.- und S.-Wesen," vol. xlix, p. 429; Edouard Primosigh, *ibid.*, vol. xlvii, p. 51; "Revista Minera," vol. liii, p. 109.

² Communicated by Don Mariano Augustin, Ingeniero de Minas, Santa Olalla, Spain.

The re-separation of the magnetite concentrates is made to remove the copper with its combined sulphur; what disposal is made of this iron-copper-sulphur product could not be learned.

At the *Ryllshytans Zinc Mines, Sweden*, a Grondal Type I separator¹ is employed to separate magnetite from blende.

In *Raglan Township, Ontario*, the Canada Corundum Co.² employs a magnetic separator in cleaning corundum concentrates. The ore carries corundum associated with magnetite and mica in a feldspathic gangue. The ore is crushed with breaker and rolls and concentrated with jigs and tables. The concentrates passing 8 mesh are dried and the magnetite removed by the separator. The output is about three tons of cleaned concentrates per day.

¹ Dr. Weiskopf, "Stahl und Eisen," vol. xxv, p. 532.

² Richards, "Ore Dressing," p. 1078.

VI

THE SEPARATION OF PYRITE AND BLENDE

THE co-occurrence of the sulphides of zinc and iron is frequent; blende and pyrite, or marcasite, are found together in important ore bodies which are worked for the value of the contained zinc, and many lead deposits in their lower horizons carry zinc and iron sulphides. Galena may be separated in the wet way from both of the lighter sulphides, but the specific gravities of the latter are too similar to permit their separation from each other by any method depending upon specific gravity.

The presence of iron in zinc ores is very undesirable for metallurgical reasons connected with the reduction of zinc, and this fact, together with the similar specific gravities of the sulphides of these metals, gives rise to one of the most important fields of magnetic separation.

The middling products from mills treating galena-blende-pyrite ores frequently carry an important value in gold and silver locked up in the pyrite. The presence of any considerable amount of zinc in such middling renders it unsalable at the lead smelters, or involves the payment of a heavy penalty for each unit of zinc above a certain standard, usually 10 per cent., and their iron content renders them unsalable at the zinc smelters. If, however, the pyrite and blende are separated, two valuable products result.

Pyrite (FeS_2 , sp. gr. 4.8 to 5.2) is almost nonmagnetic; in some specimens it has been reported as diamagnetic, and in others as possessing a feeble paramagnetism; it is not attracted by the fields of the most powerful separators. On roasting it is readily transformed into the magnetic sulphide, and on the continuation of the roast, into a strongly magnetic oxide analogous to the mineral magnetite. Pyrite, in some specimens, on being heated at a quite low temperature for a minute or two, develops an iridescent film of magnetic sulphide, which imparts sufficient permeability to cause it to be attracted by fields of low intensity. The varying magnetic

behavior of pyrite may be in some way connected with its several crystalline forms.

Marcasite (FeS_2 sp. gr. 4.6 to 4.85) is similar to pyrite in its magnetic qualities.

Sphalerite or *blende* (ZnS , sp. gr. 3.9 to 4.2) varies in permeability according to the percentage of isomorphous iron and manganese sulphides contained by it. The pure sulphide of zinc, as represented in the light-straw colored varieties, is diamagnetic, while the highly ferrous variety, called *marmatite* and "black jack," in which the combined iron may reach 12 or 14 per cent., may be even ferromagnetic. Pure *blende*, or "rosin jack," carries 67 per cent. zinc, while "marmatite" rarely carries over 51 or 52 per cent. zinc. *Blende* carrying as low as $\frac{1}{2}$ per cent. isomorphous iron becomes appreciably magnetic upon roasting. *Blende* is being separated as a magnetic product at several mills in Colorado, in Europe and in Australia. The degree of magnetism appears to depend upon the ratio of the two sulphides contained, which varies from 3 parts ZnS to 1 of FeS_2 , to 5 parts ZnS to 1 of FeS_2 , and in any given ore the individual crystals of *sphalerite* may vary from the nonmagnetic straw-colored *blende* to strongly magnetic *marmatite*. A dark color is not necessarily indicative of high iron content.

SEPARATION OF ROASTED PYRITE AND MARCASITE FROM NONMAGNETIC BLENDE

As neither pyrite nor *marcasite* possesses sufficient permeability to be attracted by even the most intense magnetic fields, a preliminary roast is necessary before they may be separated from the *blende*. There are two methods for rendering iron sulphide magnetic: a slight roast with the formation of the magnetic sulphide, or a more complete roast with the formation of a magnetic oxide of iron.

The magnetic compounds of iron formed by roasting the sulphide are strongly magnetic and are attracted by fields of low intensity, but, as the quality of the separation made depends entirely upon the uniform magnetic quality of the material presented to the separators, the roasting is the most important step in the whole process. Almost any separator can make clean products

when fed with properly roasted material, but no separator can do satisfactory work upon a poorly roasted feed.

Upon roasting pyrite or marcasite with access of air a portion of the sulphur is driven off as SO_2 and the nonmagnetic FeS_2 (pyrite) is transformed, superficially at least, to Fe_7S_8 (analogous to pyrrhotite) which is strongly magnetic. This operation is a difficult one to control in most furnaces, however, as it is easy to oxidize some of the iron, making a product of uneven permeability.

If the sulphur is completely driven off by the roast Fe_3O_4 results, which is strongly magnetic. Should the roast be carried farther, another atom of oxygen is taken up by the iron and Fe_2O_3 results, which is quite feebly magnetic, being analogous to the mineral hematite. These two oxides of iron pass from one to the other, according as the atmosphere of the furnace is reducing or oxidizing. The artificial magnetite, the black oxide produced by the roast, loses its magnetism more readily than the natural magnetite, and is converted into the feebly magnetic red oxide. This may in turn be converted back to the black oxide by exposing it to a reducing atmosphere at the end of the roast.

Pyrite and marcasite begin to loose their sulphur and change over into the magnetic sulphide, and finally into the oxides, at a temperature of 370°C ., and the roast must be conducted between this point and the ignition point of blende, which is about 600°C . Below 400 to 460 degrees the pyrite does not become thoroughly magnetic and the usual temperature employed is just below the ignition point of blende. If this temperature be slightly exceeded the only result is a superficial oxidation of the blende; a temperature of 620 degrees was attained without harmful results in some experiments carried out by Messrs. Hofman and Norton.¹ Should this heat be maintained, however, a serious loss would result through the oxidation of the fine particles of blende.

In plants where the quantity of material treated is sufficient to make it feasible, the ore, or concentrate, should be sized before roasting. Roasting and magnetization take place from the surface inward, and in a mass of ore composed of coarse and fine particles the finer sizes will have been overroasted before the lumps have been affected to their centers. If a medium roast is given the mixture the larger lumps will have centers of unchanged pyrite, while the fine particles may have been converted

¹ *Trans. A. I. M. E.*, September, 1904.

into the nonmagnetic sesquioxide, and it is evident that a clean separation of such a product is out of the question. If a quick, light roast is carried out with a view to the formation of a film of magnetic sulphide on the surfaces of the particles, a fairly uniform product may result from the treatment of unsized material; the same is true when the roast is carried to the complete formation of the magnetic oxide in a reducing atmosphere. With large lump ore it is difficult to tell when the roast has penetrated to the centers of the lumps, and the process requires too much time. With very fine material the interstitial spaces are small, and, the material having a tendency to pack, the reducing gases reach all the particles with difficulty; also, very fine particles of blende may be converted into the oxide of zinc and pass out of the furnace with the gases, and dust chambers must be provided to save as much of this material as possible. While it may not be definitely stated, certain experimenters have given 8 mesh as the best size for blende-pyrite concentrate for good results in roasting.

If the roast be conducted with too free an access of air, the particles will be made up of concentric rings of different magnetic permeability, the surface will consist of a layer of nonmagnetic sesquioxide beneath which will be found a layer of black magnetic oxide, enclosing, perhaps, a core of unchanged sulphide, the division between the two being marked by a layer of the magnetic sulphide. Unless the roast has been carried too far the magnetic oxide will impart sufficient permeability to the whole particle to cause it to be taken up by the magnet, unless decrepitation breaks these layers apart, in which case each behaves according to its individual permeability, and nonmagnetic iron finds its way into the blende concentrate. Separation should be carried out upon ore as it comes from the furnace, cooled in such a manner as not to induce decrepitation, and no part of the separator feed should be crushed after roasting. Particles which have been fritted together should be recrushed, but also reroasted before separation.

Much of the concentrate roasted ranges in size from $\frac{1}{16}$ to $\frac{1}{4}$ in., but after roasting, all but a small percentage of the iron in this concentrate will pass a 20-mesh screen. This is due to the breaking up of the particles under the influence of the roast. If a partially roasted particle of iron sulphide is broken, a network of fine black lines of the oxide will be seen, reaching perhaps the center of the particle, the spaces between them being composed

of unchanged sulphide. This seems to indicate that the roast proceeds more rapidly along the boundaries of the crystals (forming an aggregate of the mineral) than through the individual crystals, causing these aggregates to split up. The tendency of pyrite and marcasite to decrepitate at a lower temperature than blende has been employed to separate these minerals, screening following the roast.

There are many types of roasting furnaces on the market which, with proper management, may be made to do efficient work. The principal requirement is that the admission of air shall be under complete control. Several forms of mechanical furnaces are in extensive use, and the old shaft furnaces may be made to do good work; for the finer sizes, hearth furnaces do good work. The time required for a good roast may be said to vary from $\frac{1}{2}$ hour to 2 hours for fine concentrate, up to 3 or $3\frac{1}{2}$ hours for coarse material, roasting for the magnetic oxide. The roasted pyrite or marcasite should be dark-brown in color, almost black; a decided reddish tinge indicates overroasting. The magnetic sulphide is black, and requires little time for its formation.

If there is tendency toward overroasting, the air inlets should be sealed up, and all entering the furnace should be made to pass through the fire box, where such is used. The addition of a little coke or hard coal may be resorted to at the end of the roast to reconvert to the black oxide any nonmagnetic red oxide which may have been formed. Subjecting the roasting ore to the action of reducing gases is successfully employed in Europe for this purpose.

It is probable that in many American plants whose output is not sufficient to warrant the installation of the more expensive types of furnace a small hearth would be advantageous for the re-treatment of the middling product from the separators.

The roast may be considered satisfactory when the separators make a recovery of from 85 to 90 per cent. of the total zinc in the raw concentrate, and yield a clean blende product carrying 1.5 to 2.5 per cent. iron due to pyrite. The iron content may, after the best work, reach a much higher figure, due to the presence of combined iron in the blende. The Joplin and Wisconsin ores usually do not carry to exceed $\frac{1}{2}$ per cent. combined iron. The Leadville ores offer a more difficult problem, owing to the presence of blende of all degrees of permeability: an extraction of 75 to 85 per cent. in a product carrying 40 to 50 per cent. zinc is good work. Direct

separation of these ores yields a lower grade product and a less extraction.

SEPARATION OF MAGNETIC BLENDE FROM PYRITE

Magnetic blende is of frequent occurrence at Leadville, Colorado, and other parts of the Rocky Mountain region, and is also found in important ore bodies in Europe and Australia. The Colorado ores of this type usually carry galena, sphalerite, and pyrite with subordinate amounts of pyrrhotite; the galena is usually argentiferous and the pyrite may or may not carry the precious metals. The sulphide of zinc in these ores varies from straw-colored blende to marmatite—in other words, from a nonmagnetic mineral to one possessing sufficient permeability to be removed magnetically in its raw state.

The determination of a process for the treatment of any ore carrying magnetic blende should be done by actual test on sufficiently large samples to indicate commercial results. If the blende is wholly or in large part magnetic, then a direct separation on high-intensity separators is in order. Individual particles of marmatite may show ferromagnetism, but the bulk of the mineral in an ore is usually less strongly magnetic, and a field of high intensity is necessary to obtain a satisfactory recovery. The value of the pyrite in gold and silver plays an important part in the determination of the process to be followed; if its value is negligible, then any loss of blende in the nonmagnetic tailing merely results in a decrease in the percentage recovery of the zinc; but if the pyrite is valuable for contained gold and silver, this nonmagnetic tailing should be kept below the zinc penalty limit set by the lead smelters to which this product is destined. In choosing between direct separation and separation after roasting, the higher value at the smelter of roasted pyrite over the raw sulphide should be considered.

At one plant treating marmatite ores, the nonmagnetic blende remaining in the pyrite tailing is removed by electrostatic separators. When there is much of this nonmagnetic blende in an ore, and the value of the pyrite in gold and silver is sufficient, the nonmagnetic tailing may be roasted, and the iron and blende recovered separately as clean products. With ores which require roasting, a preliminary treatment of the raw ore on magnetic sep-

arators to remove the strongly magnetic marmatite is advisable, as the actual passing of the ore over a separator represents but a very small proportion of the total cost of preparing the ore for magnetic treatment, and this magnetic blende would otherwise find its way into the roasted iron tailing.

At *Kokomo, Colorado*, the Kimberly-Wilfley Mines Co. is separating pyrite from galena and blende after roasting to the mag-

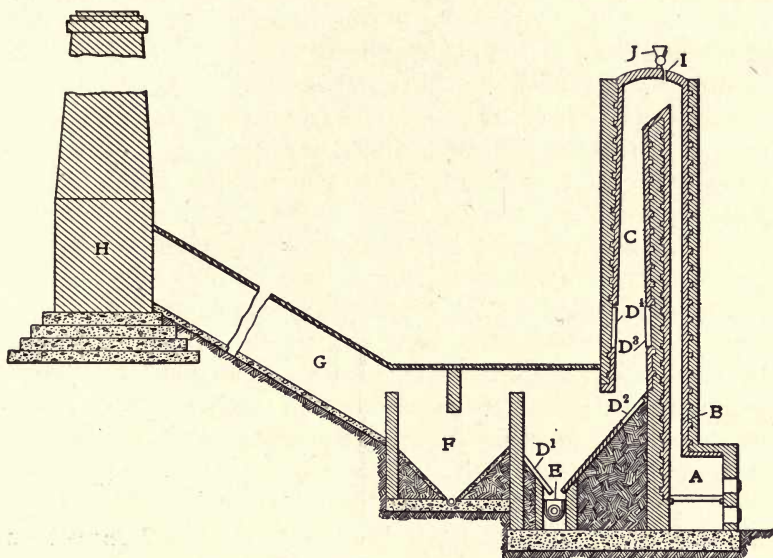

FIG. 59.—WILFLEY ROASTING FURNACE.

A, Fire box; *B*, up-cast flue; *C*, down-cast or roasting flue; *D*¹, *D*², *D*³, *D*⁴, water-jackets; *E*, water-jacket screw conveyor; *F*, dust chamber; *G*, dust flue; *H*, stack; *I*, feed opening; *J*, ore feeder.

netic sulphide. The ore carries galena, slightly magnetic blende, and pyrite containing gold and silver values. The ore from the mine, after passing through a breaker, is crushed by 16 × 42-in. rolls to $\frac{3}{8}$ in. and is then sized and gradually reduced to 14 mesh by three sets of 12 × 36-in. rolls. The crushed ore is transported by a conveyor belt to a Wilfley roasting furnace, a cross section of which is shown in the accompanying figure.

The ore fed at the top of the furnace falls upon a plate set at an angle of 50 degrees, thence through the down-cast flue, striking upon water-cooled plates, and finally into a water-jacketed screw

conveyor which discharges it from the furnace. The roasting is carried out by the hot gases from the fire box together with the heat generated by the oxidizing pyrite upon individual particles, which are cooled to a certain extent before coming into contact with other particles, preventing fritting, and gives a uniform roast to the small and large particles alike. The ore is cooled sufficiently before passing out of the furnace to prevent a continuance of the oxidation when it comes into contact with the atmosphere. The dust

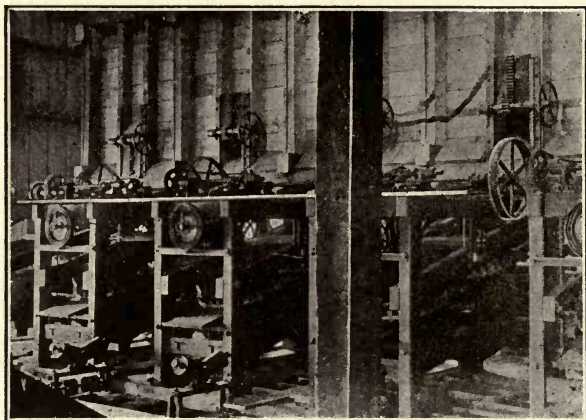

FIG. 60.—DINGS SEPARATORS AT KOKOMO, COLORADO.

is collected in *F* and *G*, and is discharged from the furnace by a screw conveyor.

The fuel consumption is low, most of the heat necessary for the roasting being generated by the oxidation of the pyrite, the coal being used to regulate the temperature of the roast. It is said that during steady operation the temperature of the roasting flue does not vary more than 10 degrees, and a variation in the feed does not cause a variation of more than 100 degrees. The temperature is indicated by a pyrometer, the thermal couple being placed in the roasting flue above the water jackets.

The ore, as delivered from the furnace, is elevated and passed through a water-jacketed revolving cylindrical cooler, in which the temperature of the ore is reduced to 60° F., and sent to the separator bins. Ten Dings separators are employed to effect the separation of the roasted ore. The magnetic iron product from these separators falls upon a belt conveyor which delivers to ship-

ping bins, whence it is shipped to the lead smelters. The nonmagnetic product falls upon another belt conveyor delivering to an elevator, is mixed with water and passed to two Richards classifiers, making four sizes; thence it is fed to eight Wilfley roughing tables. The pulp and middlings are sent to eight other Wilfley tables placed on the floor below and directly beneath the roughing tables. The tabling plant is operated in two units of eight tables each: one lower table receives all the zinc middlings, one all the lead middlings, one all the iron middlings not rendered magnetic in the roast, and one all the silica middlings from four of the roughing tables above. The overflow from the classifiers, the crosswash from the feed end of the Wilfley tables, and the dust from the furnace go to a Buckingham filter tank, which classifies and dewateres the fines and makes a thick pulp that is fed to a Wilfley table and to a Frue vanner fitted with egg-shell belt. It is stated that the roasting of the ore so changes the galena and blende that even the finest particles will not float, and renders easy an otherwise difficult separation.¹

The plant has a capacity of 250 tons per day.

At *Denver, Colorado*,² the Colorado Zinc Co. is operating a plant of 100 tons daily capacity, equipped with a Wilfley furnace and Dings separators, with Wilfley tables for the separation of the nonmagnetic product. The ore is crushed dry to 16 mesh, passed through the furnace where from 10 to 15 per cent. sulphur is driven off, transforming the pyrite to the magnetic sulphide. After cooling in a water-jacketed cylindrical cooler, the ore is passed over 4 Dings separators which remove the iron, amounting to from 40 to 50 per cent. of the ore, while the nonmagnetic product is sent to the tables. The furnace is 8 × 8 ft. in section and 30 ft. high, and has a capacity of 100 tons per 24 hours. With ore carrying 25 per cent. iron as pyrite the furnace requires 1 ton of coal per day when operated at capacity. The separators deliver a finished iron product and a silica-zinc-lead middling which is sent, after sizing, to four Wilfley tables; these tables are operated to make finished zinc concentrate, while the lead-zinc middling and the silica-zinc middling are re-treated on three other tables. It is stated that, due to the action of the roast, the galena and blende

¹ Communicated by F. W. Gregory, Kokomo, Colorado, and from *E. & M. J.*, vol. lxxxv, p. 453. J. M. McClave.

² *E. & M. J.*, vol. lxxxv, p. 453. J. M. McClave.

do not, in the finest particles, float, and that the wash-water from the tables runs clear, while when the ore is tabled without roasting the wash water contains from 10 to 15 per cent. of lead-zinc slime.

At *Galena, Illinois*, the Joplin Separating Co. is operating a custom plant whose raw material is derived from the adjacent Wisconsin zinc field. Zinc-iron concentrate from mills not equipped with separating plants forms the greater part of the material treated; raw ores carrying zinc, iron, and lead sulphides are also purchased and, after water concentration, magnetically cleaned.

This plant is well managed and, although running on all grades and classes of material, probably represents the best practise of the district. The mill includes a roasting furnace of 40 tons capacity per 24 hours, three Cleveland-Knowles 12-in. belt separators, and a complete equipment of jigs, tables, etc., for the concentration of raw ores preliminary to roasting and magnetic separation.

The Wisconsin ores carry blende, galena and marcasite in a limestone gangue. The ore is easily crushed and yields the bulk of its component minerals when crushed to 4 mesh, although a finer comminution is carried out on the middling products from the jigs. The blende is of the variety known as "rosin jack," and rarely carries to exceed $\frac{1}{2}$ per cent. combined iron: some darker-colored blende is produced in the district, but none that came under the writer's observation was sufficiently magnetic to be affected by the low-intensity magnetic fields employed in the separation of these ores. The purity of the ores is well illustrated by the fact that 60 per cent. concentrate is the standard grade from which prices are figured, and iron in excess of 2 per cent. is penalized at the rate of \$1 per unit.

In this mill the blende-marcasite concentrate is delivered to the feed hopper above the roasting furnace by a 6-in. bucket elevator. The feed hopper is 36 ins. square and slopes from two sides to a point. The feeder, of the stirrup type, delivers into a sheet-iron spout which extends well into the neck of the furnace.

The furnace is of the revolving-cylinder type, built by the Galena Iron Works, and is 32 ft. long by 5 ft. in diameter. It is built of boiler plate and lined with fire brick. This shell is fitted with two tires which rest upon two sets of rollers, the distance apart of which may be adjusted to give any desired inclination from the horizontal to the axis of the cylinder, so accelerating

or retarding the passage of the ore through it. Revolution is imparted to the cylinder by gearing. At either end the furnace is narrowed by fire-brick walls to 2 ft. 6 ins. for connection with the fire box at the discharge end, and with the dust chamber, which also serves as foundation for the stack, at the feed end. These connections are made through cast-iron necks projecting into the openings at each end of the cylinder. The fire box is fitted with a grate 4×5 ft. in area, which burns about two tons of soft coal in 24 hours. The roasted ore is discharged through the annular opening between the projecting neck of the fire box and the end of the cylinder. A fire-brick wall reaching the horizontal diameter of the fire-box neck causes the hot gases to impinge on the roof of the cylinder and not to strike the hot ore.

A 24-in. rotary blower is mounted alongside the furnace and suitably connected to furnish air under pressure beneath the grate. This is useful in raising the temperature of the charge quickly should it fall below normal and an imperfectly roasted product be likely to result.

The roasted ore discharged from the furnace falls upon a cast-iron plate, and is conveyed to one side by scrapers mounted upon a traveling chain, and falls into wheelbarrows.

The furnace makes two revolutions in three minutes, the ore remaining in it for approximately two and one half hours.

The hot ore is wheeled to a cooling floor 26 ft. wide by 60 ft. long; here it is spread a few inches deep and allowed to remain 12 hours. The ore was formerly cooled by means of a spray of water, but this gave rise to an excessive amount of fines, produced by the sudden cooling, so that it was abandoned in favor of the cooling floor, in spite of the increased cost of handling entailed.

The cooled roasted material is raised to the top of the mill by a bucket elevator and fed into a trommel 36 ins. in diameter. This trommel is fitted with two screens, each delivering its undersize to a separate bin, while the oversize from both is crushed in tight rolls and returned. The first screen has $\frac{3}{8}$ -in. and the second $\frac{1}{16}$ -in. round punched holes.

The roasted concentrate passing $\frac{3}{8}$ -in. is treated on separator No. 1, which carries $\frac{3}{4}$ ampere on the first magnet and 6.5 amperes on the second, making a clean iron tailing product and a clean nonmagnetic zinc product. The material between $\frac{3}{8}$ and $\frac{1}{16}$ in. is treated on separator No. 2, which carries the same current, re-

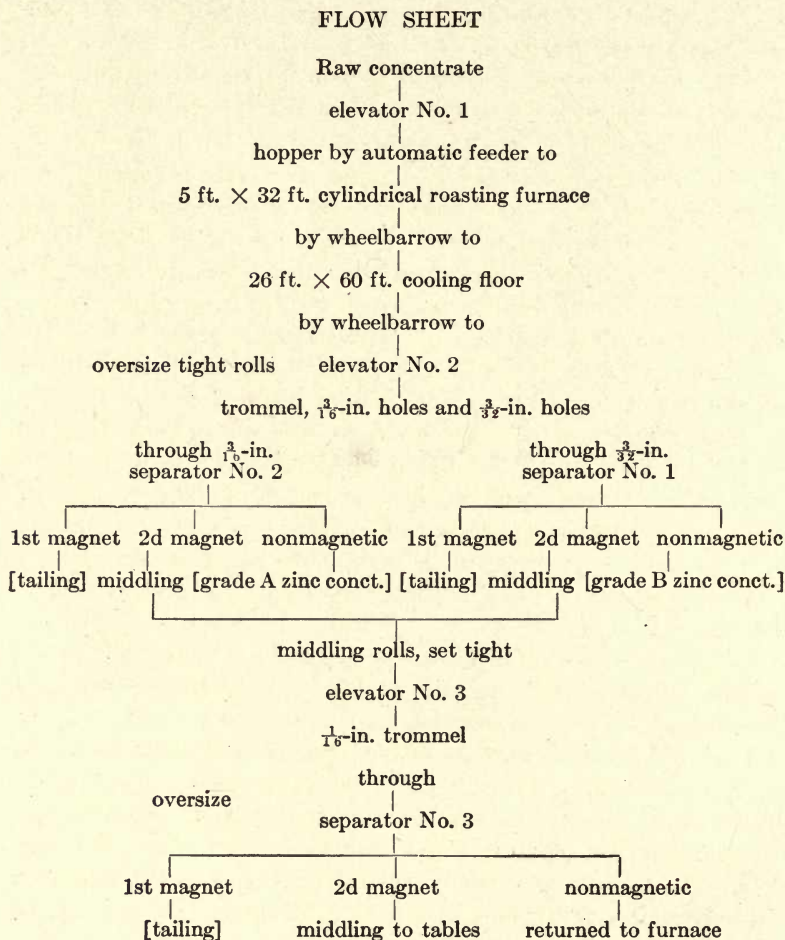

spectively, on the two magnets. The middling product from both these machines is crushed in tight rolls to $\frac{1}{8}$ in., and fed to separator No. 3, which also makes three products. The tailing from the first magnet is discarded while the middling from the second magnet is sent to the tables in the concentration mill. The nonmagnetic product from this separator carries most of its iron as unchanged pyrite, liberated by the recrushing of the middling from separators Nos. 1 and 2, and is, therefore, fed back to the roasting furnace.

The speeds of the separator belts are adjusted to suit each class of material treated.

The magnetic tailing is run to waste through a launder in which a stream of water is kept flowing, and the cleaned blende is delivered to shipping bins through chutes.

The finished product is sold under two grades: grade "A" is the product from the separator treating the coarser size and grade "B" from that treating the finer size; it has been found here that the coarser the size of the concentrate the higher the grade. The average selling assays on 33 car loads gave grade A 60.49 per cent. zinc and 2.11 per cent. iron, and grade B 57.07 per cent. zinc and 2.19 per cent. iron. The total amount shipped was in the proportion of two cars of B to each car of A.

The raw concentrate purchased by this mill carries from 11 to 33 per cent. zinc. The tailing produced averages below 5 per cent., which figure is said to be never exceeded. The efficiency of the plant is given as 85 per cent. of the zinc in the raw concentrate.

The mill is equipped with a complete series of rheostats to control the currents on all magnets from the central switch-board.

At *Hazel Green, Wisconsin*, the Kennedy Mining Co. employs a Cleveland-Knowles separator to clean roasted blende-marcasite concentrate. The concentration mill treats 100 tons of ore daily for a production of 25 tons of concentrate, carrying from 41 to 42 per cent. zinc. From the mill the concentrate is delivered to the roaster building by a self-dumping skip and drops into the boot of a bucket elevator, which delivers to the furnace feed hopper. The furnace is of the cylindrical type usual in the Wisconsin district and is 28 ft. long and 5 ft. in diameter. It is set at an inclination of 4 ins. in 28 ft. and makes two revolutions in 3 minutes. The ore remains in the furnace from $3\frac{1}{2}$ to 4 hours. The cylinder is lined with 8-in. fire brick between which are set at intervals projections of refractory material in the form of equilateral triangles with an altitude of 3 ins., which serve to lift the ore by the revolution of the furnace and allow it to fall through the hot gases from the fire box. About two tons of soft coal are burned in 24 hours. The roasted concentrate falls from the furnace into a paddle conveyor, where it is sprayed with water, which is evaporated immediately by the hot material, which it serves to cool. This conveyor delivers to a bucket elevator delivering into

a trommel above the separator bins. The roasted concentrate is here sized into two products, through $\frac{1}{16}$ in. and between $\frac{1}{16}$ in. and $\frac{1}{4}$ in.; these two sizes are treated at different times by the separator and the oversize is recrushed. The first magnet of the separator, which is a 21-in. Cleveland-Knowles machine, takes 1.5 amperes and the second magnet 3.5 amperes. The separator belt travels at a speed of about 175 ft. per minute. The magnets revolve at 75 R.P.M. at a height of 1 in. above the belt. The separator treats from 20 to 22 tons of roasted concentrate in 24 hours, which indicates a burden of from 1.25 to 1.5 lbs. of material on the belt at any one time; this quantity is carried as an even layer one particle deep. The first magnet takes out an iron-tailing product which is run to waste in a launder; the second magnet removes a middling product which is fed to the middling rolls in the concentration mill—a procedure of doubtful economy. The nonmagnetic material remaining on the belt is almost clean blende, with a little limestone and galena which were not eliminated in the concentration mill, and not being magnetic, these are concentrated by the separation in the same proportion as the blende. The cleaned zinc product amounts to about 16.5 tons in 24 hours and assays 60 per cent. zinc with 2 per cent. iron. The tailing carries about 5 per cent. zinc.

At *Platteville, Wisconsin*, the Enterprise Mining Co. is separating about 15 tons of blende-marcasite concentrate daily. The concentrate is delivered from the mill to the roaster bin by a skip running on an incline. The Galena cylindrical roasting furnace is employed, the concentrate remaining in the furnace three hours. The roasted concentrate is sized in a trommel into three products: through $\frac{1}{8}$ in., between $\frac{1}{8}$ in. and $\frac{1}{4}$ in., and oversize. The first two are fed to a 21-in. Cleveland-Knowles separator separately, the bin being provided with a partition to keep them apart; the $\frac{1}{4}$ -in. oversize is crushed and refeed to the furnace. The separator carries 3 amperes on the first magnet and 5 amperes on the second. The tailing from the first magnet is run to waste in a wet launder and the middling from the second magnet sent to the jigs in the concentrating mill; a falling off in the average grade of the cleaned zinc product from 61 to 59 per cent. is said to have resulted from so treating the middling. The cleaned zinc concentrate carries from 58 to 62 per cent. zinc and averages about 2 per cent. iron. The raw concentrate fed to the furnace carries from 40

to 45 per cent. zinc. The tailing from the separator is said to carry 4.5 per cent. zinc.

The Empire Mining Co., of Platteville, is operating a plant similarly equipped. From 18 to 20 tons of raw blende-marcasite concentrate is treated daily for a recovery of from 10 to 15 tons of cleaned zinc. The cleaned zinc concentrate carries from 60 to 63 per cent. zinc and from 1 to 3 per cent. iron. Hocking Valley Coal is burned by the furnace, costing \$5 per ton delivered; the furnace uses from 1500 to 2000 lbs. in 24 hours.

At *Mineral Point, Wisconsin*, the Mineral Point Zinc Co. operates a custom magnetic-separating plant in conjunction with a zinc-reduction works. The raw material is gathered from all parts of the district and consists chiefly of the products of water concentration ranging in size from $\frac{1}{4}$ in. downward; crude ore is occasionally treated. The concentrate fed to the furnace ranges from 28 to 34 per cent. zinc.

The roasting plant is equipped with two cylindrical furnaces of the Galena type, only one of which is at present in use. This is 20 ft. long by 5 ft. in diameter. The lining of this furnace is of 8-in. special-arch fire brick in which are set four rows of 10-in. brick spaced 90 degrees apart; these elongated brick serve to lift the ore by revolution of the furnace and allow it to fall through the hot gases; the substitution of 14-in. brick in place of the 10-in. is contemplated. This furnace is equipped with a dust chamber 5 ft. 4 in. wide by 14 ft. in length, is divided horizontally by a plate of heavy sheet iron. The gases from the furnace pass into the lower compartment of the dust chamber, along beneath the plate to the farther end, where a 2-ft. space is left between the end of the plate and the wall of the dust chamber, and thence back over their course, but above the plate, to the stack, which is 30 ins. in diameter and 50 ft. high. The dust is removed through three doors, two on the upper level, and one on the lower, each 12 ins. wide by 2 ft. high. The fire-box grate is 4 \times 5 ft. in area, and burns from 1.5 to 2 tons of soft coal, costing \$3 per ton, daily. The cylinder makes one revolution in 50 seconds, the ore remaining in the furnace from 3 to 3.5 hours. The temperature of the roast is just sufficient to start a slight fritting at the discharge neck of the furnace; that this action is incipient is shown by the fact that little trouble is experienced from overroasting or from particles of zinc and iron which have been cemented together.

The slight deposit which forms at the discharge neck is removed from time to time with a long chisel. Paddle-and-chain conveyors are used to convey the roasted ore from the furnace, and a small stream of water is sprayed upon the hot material to lay the dust and assist in cooling it; the water used is regulated so that it may be completely evaporated by the heat of the ore before it



FIG. 61.—MILL OF THE TRIPOLI MINING CO., MINERAL POINT, WIS.

reaches the separator bins. The furnace treats about twenty tons of raw concentrate in 24 hours.

The roasted concentrate is separated on a Cleveland-Knowles 21-in. separator and upon a Dings separator, set up side by side and working on the same material. Either machine is capable of treating the output from one surface. The Cleveland-Knowles carries 3 amperes on the first magnet and 6 amperes on the second: the Dings separator carries 3 amperes on either magnet. The roasted concentrate is sized before separation into two products, between $\frac{1}{8}$ and $\frac{1}{4}$ in., and through $\frac{1}{8}$ in. The concentrate averages 59 per cent. zinc and 2.5 per cent. iron; the middling amounts to

OTHER PLANTS OPERATING IN THE WISCONSIN ZINC FIELD ON BLENDE-MARCASITE CONCENTRATES

LOCATION	Name of Company	Separator	Capacity, Tons, 24 Hours
Hazel Green	Hazel Green Mining Company	21-in. Cleveland-Knowles. . .	20
Hazel Green	Murphy Mining and Development Company.	21-in. Cleveland-Knowles. . .	20
Buncombe	Rowley Mining Company	12-in. Cleveland-Knowles. . .	12
Buncombe	Winnabago Mining Company	21-in. Cleveland-Knowles. . .	20
Benton	Amalgamated Zinc Mines Company	Dings.	35
Benton	Dawson Mining Company	21-in. Cleveland-Knowles. . .	20
Big Patch	Blackhawk Mining Company	21-in. Cleveland-Knowles. . .	20
Cuba City	Gritty Six Mining Company	21-in. Cleveland-Knowles. . .	20
Cuba City	Reliable Mining Company.	21-in. Cleveland-Knowles. . .	20
Cuba City	Dall Lead and Zinc Company	21-in. Cleveland-Knowles. . .	20
Schullsburg	Morrison Mining and Development Company	21-in. Cleveland-Knowles. . .	20
Schullsburg	Union Zinc and Lead Company	21-in. Cleveland-Knowles. . .	20
Schullsburg	Brown & Croft Mining Co.	21-in. Cleveland-Knowles. . .	20
Mineral Point	Hazel Patch Mining Company	Dings.	20

from 7 to 10 per cent. of the feed and carries 17 per cent. zinc; it is stacked awaiting a process. The tailing product averages from 2 to 2.25 per cent. zinc. An efficiency of from 85 to 86 per cent. of the zinc in the raw concentrate recovered in the cleaned zinc product is claimed for the plant.

Power for the furnace and separators is supplied by a 15 H.P. motor.

The mill of the Tripoli Mining Co., situate three miles north-west of Mineral Point, is separating blende-marcasite concentrate on Dings separators. The concentrate from the mill is trammed to the roaster building, some 200 ft. away, in mine cars, and dumped at the foot of a bucket elevator delivering to the furnace feed hopper. The furnace, of the cylindrical type, makes one revolution in 1 minute and 40 seconds and roasts from 18 to 20 tons of concentrate in 24 hours. The roasted ore from the furnace falls into a screw conveyor 15 ins. in diameter and making 24 R.P.M., and from this into a chain conveyor running at a speed of 2 ft. per second; there are 23 ft. of screw conveyor and 15 ft. of chain conveyor, and in this distance the roasted material is sufficiently cooled to be fed into the separator bins. A noticeable grinding action is set up in these conveyors.

The roasted concentrate is separated on a Dings separator. The raw concentrate carries from 30 to 35 per cent. zinc, and the cleaned zinc product from the separator from 57 to 59 per cent. zinc with from 2.5 to 5 per cent. iron.

A motor taking 44 amperes at 125 volts drives the furnace, conveyors, elevators, separator, etc.

At *Joplin, Missouri*, the Joplin Separating Co. is operating a custom separating plant on blende concentrate. The iron content of the raw concentrate averages 15 per cent., which is reduced to an average of 1.06 per cent. in the cleaned zinc product. The roasting is done in kilns, and the separation on two Cleveland-Knowles separators.

At *Kaslo, British Columbia*, the Kootenay Ore Works operates a custom works on concentrate carrying galena, blende and pyrite carrying from 15 to 20 per cent. iron and rarely exceeding 37 per cent. zinc. The ore is delivered from railroad cars to bins at the top of the mill and after passing a sampler is fed to a White-Howell roasting furnace. The roasted ore is cooled in a revolving cylinder through which a current of cold air is passed. After

cooling, the ore is crushed to pass 20 mesh and classified into eight sizes, and the iron removed on four Dings separators. The final zinc product carries from 7 to 8 per cent. iron.

At *Huanchaca, Bolivia*, "Stern" type separators are employed to separate blende-pyrite ores after roasting. There are five of these machines in operation; three of them treat original ore, and two others are used to clean the concentrates from the first machines. The capacity of the plant is 2 metric tons per hour.

The ore from the mine is crushed to 30 mm. in a breaker,

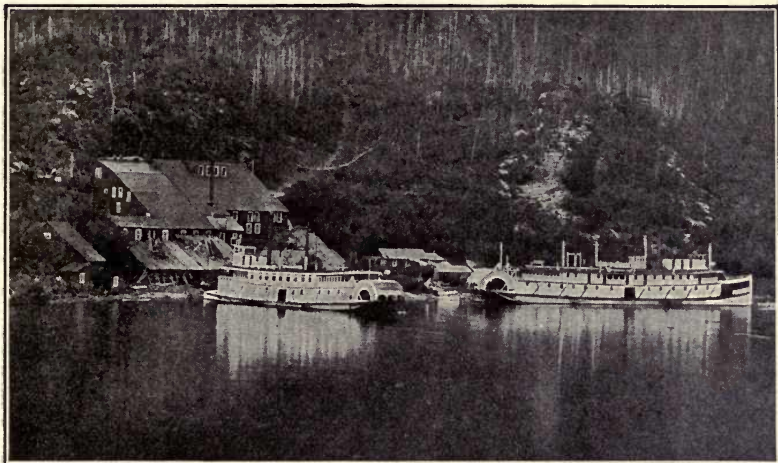

FIG. 62.—KOOTENAY ORE WORKS, KASLO, B. C.

which is followed by rolls, further reducing the ore to pass a 4-mm. screen.

From the rolls the ore is lifted by a bucket elevator and fed to a roasting furnace of the revolving-cylinder type. The roast drives off sulphur from the pyrite, forming the magnetic oxide of iron. The roasted ore is let fall into a conveyor, where it is cooled by the action of a stream of cold water, and thence is carried to a trommel with 4-mm. screens. The oversize, due to swelling in the roast, is returned to the rolls, while the material which passes the screen is delivered to feed hoppers supplying the separators. The ore at this point is mixed with the proper quantity of water in a specially constructed funnel mixer, and next fed to the roughing separators, three of the Stern-type wet machines.

The nonmagnetic blende is caught in a trough beneath the separators and after settling is drawn off, constituting a finished product. The magnetic roasted iron is delivered to a tube mill and reduced to 2 mm., and from thence is elevated by a centrifugal pump to settling tanks from which it is tapped to the cleaning separators, two in number, of the same type as the machines working on raw ore.

The final results of the magnetic separation are a concentrate carrying 50.81 per cent. zinc and tailing averaging 3.98 per cent. zinc; the feed averages 30.81 per cent. and the extraction in terms of total zinc in the feed is 98 per cent. On a somewhat lower grade of ore the following results are obtained: concentrate, 40.10 per cent. zinc; tailing 4.80 per cent. zinc; the feed averaging 24.22 per cent. and the extraction 91.3 per cent.

At *Pueblo, Colorado*, the Mechernich separator is employed by the United States Zinc Co. for the separation of blende from pyrites, and the other mixed sulphides. The ore is given a roast preliminary to separation.

At *Ravalo*,¹ *Sweden*, Herbele separators are employed to separate zinc-iron-lead ores.

At *Munsterbusch*, near *Stolberg, Germany*, the Aktien-Gesellschaft für Bergbau-Blei und Zinkfabrikation is separating roasted blende-pyrite concentrate on an 80-cm. Mechernich separator.

At *Hamborn, Germany*, the Aktien-Gesellschaft für Zink-Industrie is operating a plant equipped with Humboldt-Wetherill separators on blende-pyrite concentrate.

At *Lipine, Upper Silesia, Germany*, the Schlesiischen Aktien-Gesellschaft is separating roasted blende-pyrite concentrate on Mechernich separators. The raw material carries from 25 to 26 per cent. zinc, which, after a slight roast, is passed over a Mechernich double-pole separator. This machine treats an average of 1.5 metric tons per hour from which is produced 0.9 ton of zinc product assaying about 40 per cent. and 0.6 ton iron product assaying 15 per cent. zinc, indicating an extraction of 80 per cent.

At *Carlshof, Germany*, Henckel von Donnersmark is operating a plant of 20 metric tons capacity in 10 hours on roasted blende-pyrite concentrate, employing the Humboldt separator.

At *Peyrebrune, Germany*, the Peyrebrune Co. is operating a separating plant equipped with Humboldt separators on blende-

¹ *B., H.- und S.-Wesen*, vol. xxv, p. 474.

pyrite concentrate; the capacity of the plant is 8 metric tons in 10 hours.

At *Kattowitz, Germany*, there is a magnetic separation plant equipped with twelve Stern wet-type separators treating roasted blende-pyrite ore and concentrate. The capacity of the plant is from 5 to 7.5 metric tons per hour.

At *Torrelavega, Santander, Spain*, the Real Compania Asturiana de Minas is operating a magnetic separation plant on blende-pyrite concentrate.

SEPARATION OF MAGNETIC BLENDE FROM PYRITE

At *The Yak Mill, Leadville, Colorado*,¹ International separators are employed to separate magnetic blende. The ores treated at this mill carry blende, pyrite and pyrrhotite and, as nearly as can be learned, carry from 20 to 30 per cent. zinc. The ore is treated raw, the blende being recovered as a magnetic product. There are eighteen of these machines installed here, four of which receive the initial ore; the others treat the products of the original machines. The daily capacity of the mill is from 200 to 250 tons, making the amount handled by the primary separators upward of 50 tons each. The capacity of one of these machines on 20 per cent. ore is stated at 2.5 tons per hour, and 3 tons per hour on 30 per cent. ore. The ore is reduced dry to pass a 0.043-in. screen aperture. The eighteen machines use 64 amperes at 250 volts for excitation, or less than 1 kwt. per machine. One horse power is ample for the mechanical operation of the separator. No data as to the results obtained are available. Experiments are now being carried on with the Cleveland-Knowles separator, the ore being given a preliminary roast.

At *Denver, Colorado*, the Colorado Zinc Co. is treating magnetic blende ores on Wetherill-Rowand separators and Blake-Morscher electrostatic separators. The ores treated come from Georgetown, Black Hawk, Breckinridge, and Leadville, and carry magnetic and nonmagnetic blende, galena, pyrite, and a little pyrrhotite. The ore varies in size down to classifier products, and carries from 22 to 30 per cent. zinc.

The plant is equipped with three Type E Wetherill-Rowand

¹ "Report of the Zinc Commission, British Columbia," p. 112.

separators and three double Blake-Morscher electrostatic separators, together with Wilfley tables, crushers, rolls, etc., for the preliminary concentration of such raw ores as are purchased. At the time of the writer's visit the material treated by the separators was the middling product from the Wilfley tables, crushed to 30 mesh before concentration, and carrying from 20 to 25 per cent. zinc with 25 to 28 per cent. iron as pyrite.

The middling from the tables is raised to a hopper by a skip, and fed into the upper end of a cylindrical drier revolving on an inclined axis, and from this is transferred to the separator bins, being cooled on the way.

The separators are standard size, 18-in. belt with six separating zones, operated at the rate of 17 tons of feed per machine per 24 hours, which appeared to be somewhat above their capacity, which is said to average 700 to 1000 lbs. per hour, at which rate each machine requires 7.5 H.P. for excitation and operation. The belt speeds for this tonnage were: conveyor belt, 45 ft. per minute; take-off belts, about 7 ft. per second; feeder, 6 R.P.M. The current employed on the several magnets could not be ascertained. The separators make four products, as follows:

(1) From the first pole of the first magnet, carrying least current, a rather strongly magnetic product consisting of pyrrhotite, small particles of pyrite which have been rendered magnetic in the drying furnace, etc. This material forms tufts or bunches which do not lose their magnetism for some seconds after leaving the magnets; it carries from 7 to 11 per cent. zinc, and is trammed to the waste dump.

(2) From the second pole of the first magnet, a light-colored product carrying from 12 to 15 per cent. zinc; it is repressed.

(3) From the four poles of the second and third magnets, finished zinc concentrate carrying from 41 to 43 per cent. zinc and 10 to 12 per cent. iron; the iron in this product is mostly in combination with the blende, but a small percentage is due to pyrite.

(4) Discharge from the conveyor belt, consisting of pyrite and nonmagnetic blende, and carrying from 10 to 14 per cent. zinc; it is sent to the electrostatic separators.

The zinc content of the products from the several poles increases directly with the current employed on the magnets; is lowest from the first magnet, which receives the least current and highest from the last, which receives the strongest current, and

which apparently removes a greater quantity of product than any of the others.

The grade of the tailing product depends almost entirely upon the condition of the zinc in the feed; the more nonmagnetic zinc there is in the feed the higher the zinc content of this product. The tailing also carries a small amount of feebly magnetic blende, which would be taken up by the magnets were the capacity of the separators cut down and the speed of belt travel reduced.

At *Canyon City, Colorado*, the Empire Zinc Co. is operating a plant equipped with ten Wetherill-Rowand separators and one Wetherill Type F separator, on magnetic-blende ores.

At *Ille et Vilaine, France*, the La Touche Mining Co. is operating a plant of 12 metric tons capacity in 10 hours on magnetic blende ores. The Humboldt-Wetherill separator is employed.

The *Société des Mines de Balia Karaidin, Constantinople, Turkey*, is operating a plant of 4 metric tons hourly capacity on unroasted blende-pyrite ores. The Humboldt-Wetherill separator is employed.

At *Minaca, Chihuahua, Mexico*, the Calera Mining Co. is operating Wetherill-Rowand separators for the recovery of blende from the tailing from an ore carrying galena, blende, and pyrite in a garnet gangue, which is concentrated on Sutton-Steele pneumatic tables. The concentrate obtained carries from 40 to 45 per cent. zinc.

VII

THE SEPARATION OF SIDERITE FROM BLENDE

THE specific gravities of blende (3.9 to 4.2) and siderite (3.7 to 3.9) are almost identical, and they may not be separated by any method based on this property. The most important application of magnetic separation in Europe has been the separation of siderite, or carbonate of iron, from blende. Many important ore bodies carrying galena and blende have siderite as their chief gangue mineral. The method followed in the treatment of these ores consists of the removal of the galena by water concentration, followed by magnetic separation of the middling products containing the blende and siderite. Formerly the siderite was removed after calcination to the oxide, but since the advent of the separators with intense magnetic fields direct separation of the raw siderite as a magnetic product has superseded the older process. Examples of the separation of siderite after calcination are given, as this method possesses advantages over the direct separation in the treatment of certain ores. Siderite has been separated magnetically after calcination for its value as iron ore: the separation of siderite from chalcopyrite will be taken up in a later chapter. The magnetic tailing from most European mills finds a market as iron ore.

Siderite, sp. gr. 3.7 to 3.9, FeCO_3 , is slightly magnetic. Delesse states that if the magnetic permeability of steel be taken at 100,000, that of siderite is 120. Crane obtained a permeability for a specimen from Roxbury, Conn., of 1.0234, and for a specimen from Allevard, France, of 1.0213. Siderite is readily transformed into the magnetic oxide of iron by calcination.

Ores in which the blende is in part magnetic, or the siderite accompanied by pyrite, should be roasted before separation. Important deposits of such ores are found in British Columbia,¹ in

¹ "Report of the Commission Appointed to Investigate the Zinc Resources of British Columbia." W. R. Ingalls.

the treatment of which magnetic separation would seem to be destined to play an important part.

Ores carrying important amounts of strongly magnetic blende, or marmatite, may demand treatment in two stages: preliminary separation of the strongly magnetic blende on a high-intensity separator, followed by roasting and separation on low-intensity machines. The current on the magnets of the primary separator may be regulated to remove the blende down to a point where its permeability approaches that of siderite, then after calcination, the magnetic oxide may be removed by the low-intensity separators without affecting the remaining blende, as the increase in permeability on the part of the ferruginous blende, due to the roast, is slight as compared with the difference between raw siderite and the magnetic oxide into which it is transformed. This treatment, while requiring an additional separator, has the advantage of producing two clean zinc concentrates which may be marketed separately, the first product removed carrying the higher percentage of combined iron, and therefore being of lower zinc tenor.

CALCINING SIDERITE TO THE MAGNETIC OXIDE

Siderite heated to 800° C. breaks up into ferrous oxide and carbonic acid gas. If the roasting is carried out in a neutral atmosphere the ferrous oxide is transformed into the ignition oxide Fe_6O_7 , or, if the atmosphere is moderately oxidizing, Fe_3O_4 results; both of these oxides are strongly magnetic. If, however, there is free access of air the nonmagnetic Fe_2O_3 is quickly formed. The whole success of the operation lies in the complete control of the air entering the furnace. If air is absent, the ferrous oxide reacts with the CO_2 with the formation of Fe_3O_4 , and the liberation of carbon-monoxide; this reaction does not take place, however, unless the air is completely excluded. After the CO_2 is completely driven off, it is very easy to overroast the charge to the nonmagnetic red oxide, but if the operation is so controlled as to leave a small percentage combined the tendency to overroast is much reduced, without appreciably affecting the magnetic qualities of the product. Siderite, when pure, contains 37.9 per cent. CO_2 , and a large loss in weight results from the calcination. Siderite is usually mixed with from 3 to 5 per cent. of fine coal, or coke, before calcination, to aid in its decomposition and to insure a reducing, or

neutral, atmosphere in the furnace: if coal is used it must be of a noncoking variety. In the treatment of ores which carry both siderite and pyrite a roast suitable to convert the carbonate into the oxide also suffices to transform the sulphide into the magnetic sulphide, in which state it is removed from the blende by the separators.

The calcined siderite is always very strongly magnetic, which may partially be due to the reduction of a small amount of metallic iron by the coal mixed with the charge. The roast is usually conducted at 850° C., at which temperature but 15 minutes is required for the production of magnetic oxide. The duration of the roast is also governed by the size of the particles treated: from 20 to 35 minutes is usually employed with fine material. Prolonged heating at the temperature of calcination affects the blende. With a properly conducted roast of normal duration the blende is covered by a white film due to incipient oxidation, which does not indicate a significant loss.

The temperature of the roast must be carefully regulated, as the ferrous oxide has a strong tendency to slag with any siliceous particles of waste there may be in the material treated, forming aggregates of the several minerals. Calcination gives rise to marked decrepitation. The calcined ore is classified before separation.

Many types of shaft, reverberatory and cylindrical furnaces have been used for the calcination of siderite; almost any furnace in which the access of air may be completely controlled is suitable.

SEPARATION OF RAW SIDERITE

At *Neunkirchen, Siegerland, Germany*, the Lohmannsfeld Co. is operating a magnetic-separation plant on raw siderite-blende ores. The ores treated carry galena and blende, with rarely a little chalcopyrite, in a gangue of siderite and quartz; occasional accessory gangue minerals are calcite and barite. The siderite carries a varying quantity of manganese, which sometimes reaches 12 per cent. The blende is quite diamagnetic.

The material for separation consists of the middle products from water concentration, by which process the galena and the 2 or 3 per cent. of quartzose gangue which the ore carries are removed.

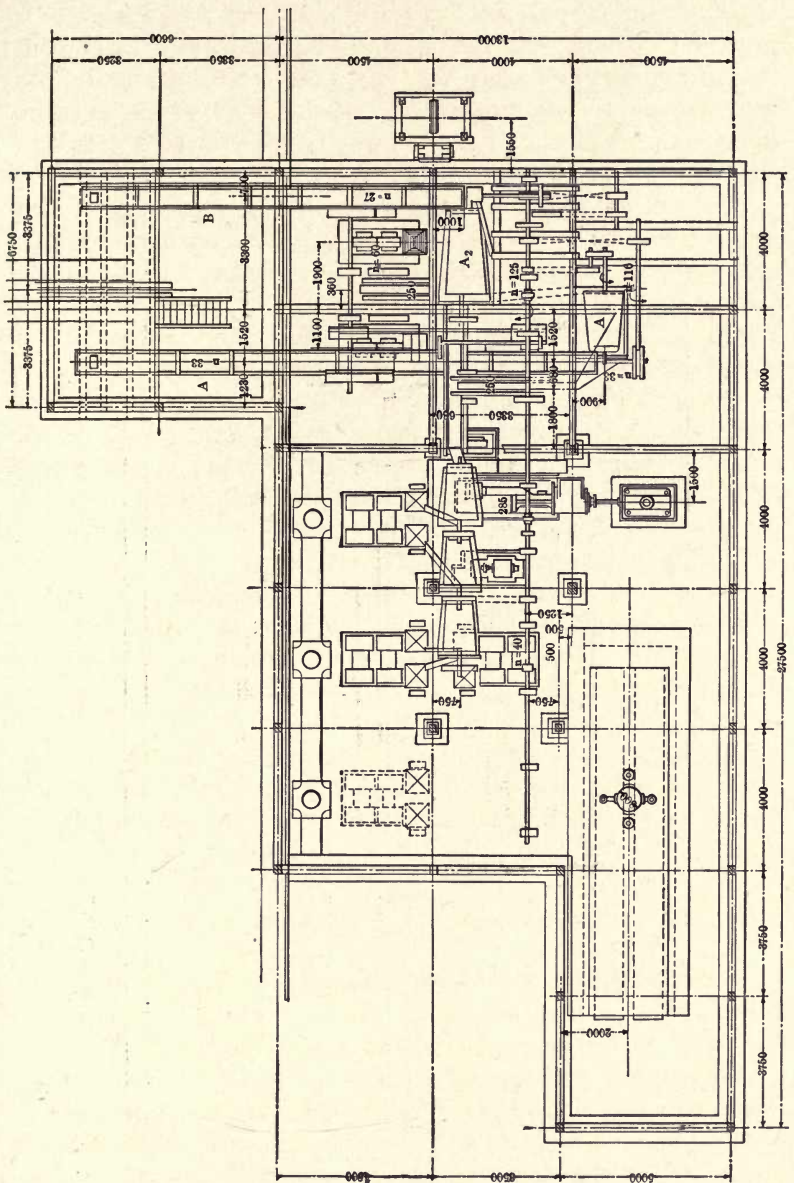

FIG. 63. — PLAN OF SEPARATION WORKS, NEUNKIRCHEN, GERMANY.

These middle products vary in size from 1 to 10 mm. and carry from 15 to 22 per cent. zinc.

The plant, which comprises six Humboldt-Wetherill separators,

pass a 3-mm. screen, it having been determined that these ores free their component minerals at that size.

The wet material from the concentrator is dried upon two endless belts which transport it through kilns heated by waste steam from the engines; it remains in the kilns from 25 to 30 minutes and arrives at the first trommels quite dry.

The dried ore is delivered from the belts to a trommel with 3-mm. screens, the fines are thence transported by elevator to the

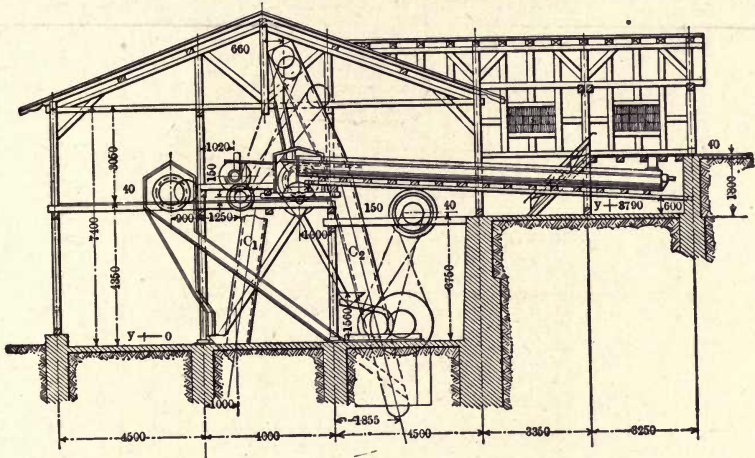

FIG. 65. — TRANSVERSE SECTION OF SEPARATION WORKS, NEUNKIRCHEN, GERMANY.

classifying trommels, while the oversize is crushed in rolls and returned to the trommel. Before reaching the classifying trommels the ore is carried upon a conveyor belt beneath an electromagnet which attracts and removes any strongly magnetic particles it may contain.

The classifying trommels divide the ore stream into the following sizes, which are fed separately to the separators: through 0.75 mm., from 0.75 to 1.4 mm., from 1.4 to 2.0 mm., from 2.0 to 3.0 mm. The separators are six in number, arranged in three series. The first separator of each series is a two-pole machine, while the second is of the three-pole type. The magnets of the first separator take 12 amperes at 65 volts and separate a clean siderite product; the belt speed on these separators is 40 meters per minute. The material passing unaffected from the two-pole sep-

arator is re-treated on the three-pole machines. Here the current is 5 amperes on the first magnet and 8 on the second; two middling products carrying blende and siderite are here removed, and the stream passing off the separator constitutes a finished blende concentrate. The belt speed on the three-pole separators is 25 meters per minute. The plant treats from 3 to 3.5 metric tons of crude ore

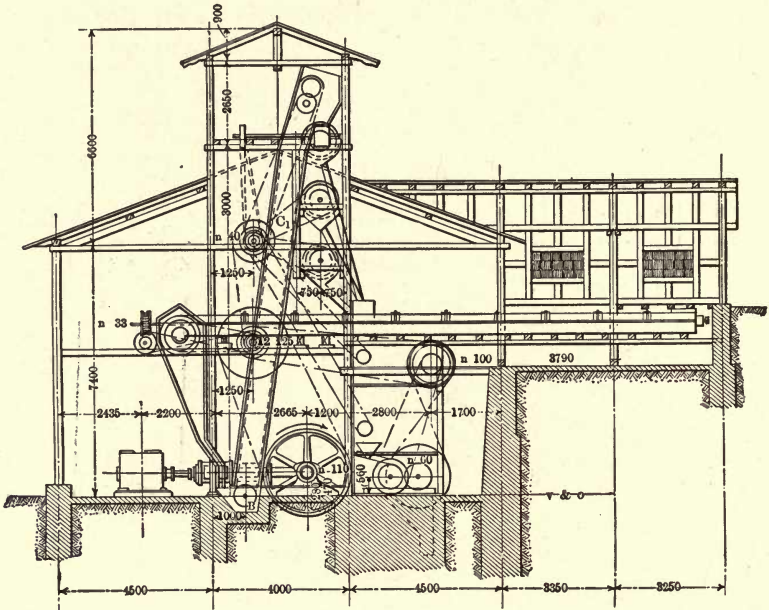

FIG. 66.—TRANSVERSE SECTION OF SEPARATION WORKS, NEUNKIRCHEN, GERMANY.

per hour. The crew required is one foreman, five boys, one engineer, and one stoker. The cost of treatment (a year's average) is 1.40 marks (33½c.) per ton of crude material; no amortization is reckoned in this figure. The plant cost about 100,000 marks.¹

At *Ems, Germany*, the *Emser Blei & Silberwerk Gesellschaft*² has been employing two Humboldt-Wetherill separators on blende-siderite concentrate since 1900. These machines are fitted with 280-mm. belts and each has two magnets. The feed is received from the concentration mill in the following sizes, which are

¹ *Iron and Coal Trades Review*, July 15, 1904.

² Communicated by the company.

treated separately on the machines: 3 to 4 mm., 2 to 3 mm., 1 to 2 mm., $\frac{1}{2}$ to 1 mm., and two classes of fines. The average capacity of each machine per ten hours is, of the coarser sizes, 12 metric tons, and of the fines, 3.5 metric tons. The average material treated of all sizes is 6.25 metric tons. The feed carries 18.5 per cent. zinc and the finished zinc product 42.5 per cent.; the siderite tailing carries 2.4 per cent. zinc. The cost of separation foots up to 2.24 marks (average of a year's run). This total, which does not include royalty or amortization of plant, is made up as follows:

	Marks
Supervision.....	0.09
Labor.....	1.38
Supplies, including the coal used in drying.....	0.49
Maintenance.....	0.07
Power.....	0.03
Miscellaneous.....	0.18
	2.24

The separators are fed from bins and deliver their products into cars. The current used on the magnets is from 8 to 9 amperes at 90 volts.

At *Musen bei Creuzthal, Germany*, the Gewerkschaft Grube Staalberg is operating Humboldt-Wetherill separators on blende-siderite concentrate. The capacity of the plant is 1.23 metric tons per hour. Two men and two boys constitute the total working force. The cost of separation varies from 1.50 to 2.50 marks and averages 2.20 marks per ton of feed. This figure includes labor, coal, lubricants, repairs, and supervision, but does not include royalty.

At *Lauenburg, Germany*, The Rheinische-Nassauische Aktien-Gesellschaft is operating a plant on blende-siderite ores, employing the Mechernich separator. The ore, pulverized to pass a screen with 4-mm. openings, is dried in a revolving kiln, with the expenditure of 1 lb. of coal per 15 lbs. moisture evaporated. The dry ore is passed through a dry-screening apparatus which removes all material below 50 mesh. The coarse product is passed through a trommel with 2-mm. and $\frac{1}{2}$ -mm. screens. The fines are treated

in a dust trommel, and everything passing 120 mesh is removed. The larger sizes are separated on motortype separators and the fines on the Mechernich separator. The machines are enclosed in dust-tight housings and the dust exhausted by fans.

RESULTS OF SEPARATION

	Per Cent. Zinc	Per Cent. Iron
Feed.....	19.5	21.02
Concentrate.....	43.81	5.47
Middling.....	7.9	27.6
Tailing.....	2.6	45.27

The average recovery of zinc in the concentrate is given at 85.72 per cent. of the total zinc in the feed.

EUROPEAN PLANTS TREATING RAW SIDERITE ORES

NAME OF COMPANY	Location	Make of Separator	Capacity, Metric Tons per 10 Hours
Berzelius, A.-G.....	Bensberg, Germany	Humboldt-Wetherill	..
Gesellschaft Friedrichsseggen	Friedrichsseggen....	Humboldt-Wetherill	30
Gesellschaft Peterszeche....	Neunkirchen.....	Mechernich.....	..
B.-G. Bendisberg.....	Bendisberg.....	Humboldt-Wetherill	10
Victoria Mining Co.....	Littfeld.....	Humboldt-Wetherill	10
A.-G. Vielle Montagne.....	Unter Eschbach....	Humboldt-Wetherill	10
Bergamt Marienhutte.....	Marienhutte.....	Humboldt-Wetherill	50
Gewerkschaft Bliesenbach..	Bliesenbach.....	Mechernich.....	..
Basterra y Hejos.....	Bilboa, Spain.....	Humboldt-Wetherill	8
Ste. des Zincs de la Campine,	Budel, Spain.....	Humboldt-Wetherill	6
Ste. Pertusola.....	Genumari, Italy...	Primosigh.....	..

SEPARATION OF CALCINED SIDERITE FROM BLENDE

Friedrichsseggen, Germany. The ore from the Friedrichsseggen mines has been treated by magnetic separation for some 25 years. Up to within a few years ago the method followed included calcination and separation on low-intensity separators; the ores are

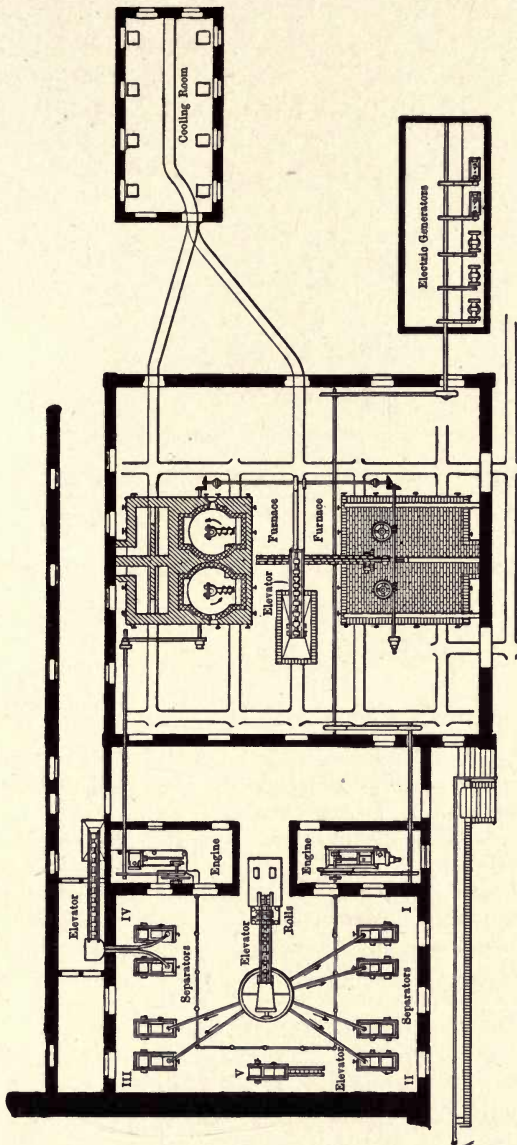

FIG. 67. — PLAN OF SEPARATION WORKS, FRIEDRICHSEGEN, GERMANY.

now separated direct on Humboldt-Wetherill machines. The description of the old process is included, as it is a standard method for the treatment of blende-siderite ores, the direct separation of which is not always advisable.

The ore treated at Friedrichsseggen was a mill product, assaying from 11 to 15 per cent. zinc (as blende) and 18 to 23 per cent. iron (as siderite). This was heated to redness in a furnace of the McDougal type, which put through from 20 to 25 metric tons per 24 hours, according to the size of particles; the coal consumption was 1.2 metric tons. The plant comprised two furnaces, each of which required the attention of one man, who also trammed the calcined ore to the cooling floor. When the ore had cooled to 50° C., or lower, it was elevated to a trommel which di-

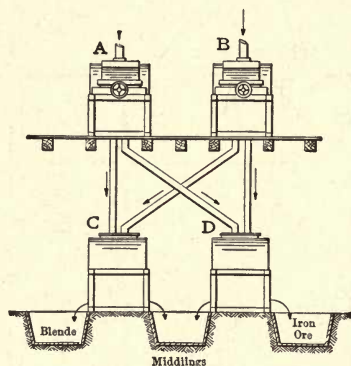

FIG. 68. — ARRANGEMENT OF SEPARATORS, FRIEDRICHSSEGGEN, GERMANY.

vided it into sizes as follows: over 4 mm.; between 2 and 4 mm.; and through 2 mm. The material which was refused by a 4-mm. screen was sent to a set of rolls and reduced to 4-mm. and elevated again to the trommel. The two sizes passing the screens dropped into separate bins from which they were fed to the primary separators. There were twelve primary separators, arranged in three groups of four each; the four machines of each group were set up in pairs, tandem. The arrangement of the separators in each group is shown in the above figure. The ore diverted to a group was divided equally between machines *A* and *B*, which made two products, one enriched in zinc and one enriched in iron. The iron product of both machines was led to *D* and the zinc product to *C*. The two lower machines made a zinc product with 38 to 42 per cent. zinc and 6 per cent. iron at the most, a mixed product, and an iron product which still retained 6 to 8 per cent. zinc. The mixed product was re-treated by a group of two machines and the iron product by another group of four machines, which yielded a

finished iron product containing 40 per cent. iron and 3 to 4 per cent. zinc, representing the entire loss of the process. Out of a total of eighteen separators, twelve were employed on original ore, while six were used cleaning the products of the primary machines; the general arrangement of the plant is shown in the accompanying figure.¹

At *Maiern, Austria*, there is a magnetic separation mill separating siderite from blende after calcination.

FLOW SHEET OF MAGNETIC SEPARATION PLANT, MAIERN, AUSTRIA

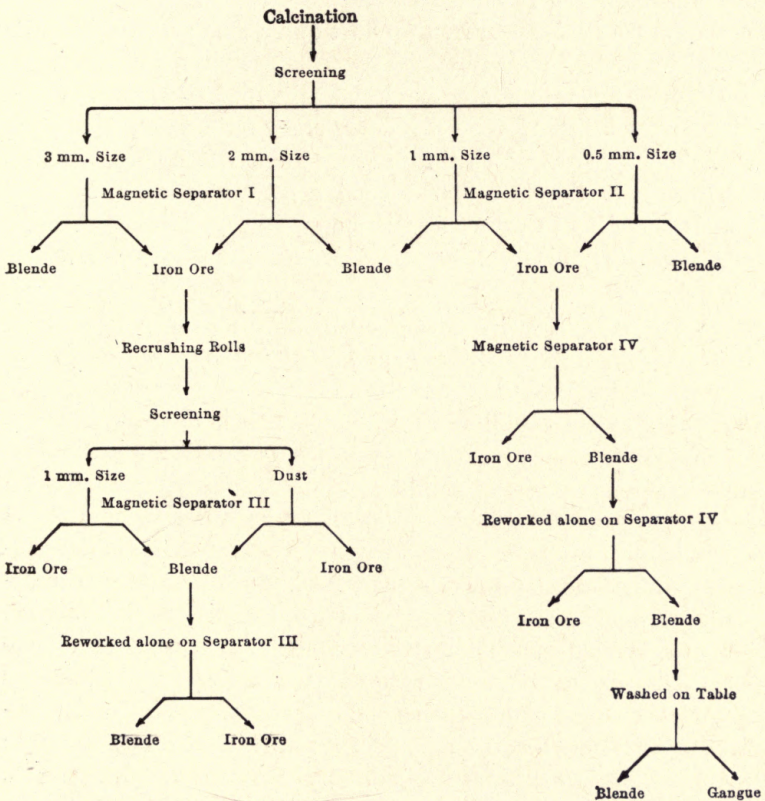

The ore, after calcination, is crushed to pass 4 mm. and then classified into the following sizes: on 3 mm.; on 2 mm.; on 1 mm.; and through $\frac{1}{2}$ mm. The two larger sizes are treated upon Sep-

¹ Report of the Zinc Commission, British Columbia," W. R. Ingalls, p. 85.

arator No. 1, and the smaller on Separator No. 2. These separators make clean blende and a middling product taken out by the magnets. The middling from Separator No. 1 is recrushed and classified upon a 1-mm. screen; the sand and finer sizes from this classification are treated at different times upon Separator No. 3, which produces a clean iron product and a blende product which is subjected to a repassage over the same machine; the products from this second passage are a clean blende and a finished iron product. The middling from Separator No. 2 is passed over Separator No. 4; from this a clean iron product is obtained and a zinc product which is repassed over the same machine, giving on the second pass a finished iron product and a zinc product which is cleaned by tables.¹

Heberle separators are employed, the capacity on the two coarser sizes being $1\frac{1}{2}$ tons per hour, and of the fines, 1 ton per hour. The speed at which these separators may be operated is limited, owing to the fact that beyond a certain point centrifugal force is sufficient to overcome the magnetism and throw off magnetic particles; this limiting speed is, for the 60-cm. drum, 45 R.P.M.²

At *Alleverd*,³ *France*, there is an installation for calcining and magnetic separation of siderite for its value as an iron ore. The ore consists of siderite in a gangue of sandstone, slate, and quartz. The raw ores are screened on a grizzly with bars spaced $1\frac{1}{2}$ ins. The coarse ore is hand picked, the waste thrown out, and the balance calcined in shaft furnaces. After calcination the lumps are broken up and the pieces of waste which have not been rendered friable in the furnaces are thrown out. The coarse ore is not subjected to magnetic separation. The final product from this material carries in excess of 50 per cent. iron and manganese. The fines are screened, and material passing $\frac{1}{4}$ in. is sent directly to shelf-calcining furnaces, the material between $\frac{1}{4}$ and $1\frac{1}{2}$ ins. is sized and jigged and the concentrate calcined in reverberatory furnaces and separated. The calcining is conducted at a temperature of 1000° C. The loss of weight in the furnaces is 28 per cent., and the calcined charge still retains 2 per cent. CO_2 . The sep-

¹ "La Separation Electromagnetique et Electrostatique," D. Korda, p. 127.

² Richards's "Ore Dressing," p. 798.

³ M. G. Gromier, "Bull. de la Société de l'Industrie Mineral," Series III, vol. vii, p. 465.

arators used consist of wooden drums upon which a number of small magnets are mounted. The fines, after separation, are briquetted after addition of 5 per cent. slaked lime. The capacity of the plant is from 210 to 220 metric tons in 10 hours.

At *Krompach, Austria*,¹ the Hernadthal Ungarische Eisenindustrie Aktien-Gesellschaft has been operating a magnetic-separating plant of 10 metric tons daily capacity since 1901. This plant was installed to try out a method for treating the Szlovinka ore bodies, and has also been operated as a custom plant. On the basis of the results obtained a mill of 500 metric tons daily capacity is now being built.

The Szlovinka ores consist of siderite occurring with quartz and schist, and lesser amounts of finely divided chalcopyrite, pyrite, and tetrahedrite; the latter mineral occurs finely disseminated. The high copper and sulphur content has hitherto rendered this class of ore unworkable, and the object of the enterprise is to produce a commercial iron concentrate through the elimination of these impurities, while also obtaining a marketable copper concentrate as a by-product.

The run of mine ore after hand picking is crushed to 2.5 mm. in breakers and rolls, and is then passed through a revolving dryer before classification. The dry ore is next divided by shaking-screens into the following sizes: 2.5 mm. to 2 mm., 2 mm. to 1.5 mm., 1.5 mm. to 1 mm., 1 mm. to 0.5 mm., 0.5 mm. to 0.25 mm. and through 0.25 mm. The coarser sizes from 2.5 mm. down to 0.25 mm. are treated separately on 24 Primosigh dry separators, while the material passing 0.25 mm. is treated on four wet separators of the same make.

The magnetic product from these machines is sent to a battery of revolving furnaces where it is calcined and sintered, removing all but traces of sulphur, and preparing the product for the iron furnaces. The middling product from the dry separators is re-crushed dry in a ball mill to 0.25 mm. and fed to the wet separators; it amounts to less than one half on one per cent. of the feed. The nonmagnetic product from the dry separators is concentrated on tables which deliver a copper concentrate and tailing; the nonmagnetic product from the wet separators is similarly treated after dewatering and classification in spitzkasten, etc.

¹ Communicated by the Marchegger Maschinenfabrik und Eisengiesserei, Marchegg bei Wien, Austria.

ANALYSIS OF PRODUCTS

Raw ore.....	27.37 % Fe	0.911 % Cu	1.511 % S.
Magnetic concentrate....	33.5 % Fe	0.17 % Cu	(70 % of feed).
Same after sintering.....	50 % Fe	0.23 % Cu	and trace S.

The low iron content of the magnetic concentrate is due to the fact that the siderite is contaminated by magnesia.

The separators are fed and their products removed by a system of belt conveyors, thus avoiding manual labor and rendering the passage of the ore through the mill automatic.

VIII

SEPARATION OF MISCELLANEOUS ORES AND MINERALS

SEPARATION OF COPPER-IRON SULPHIDES

Chalcopyrite, sp. gr. 4.15 to 4.3, is too feebly magnetic to be separated raw, and must be roasted to either the magnetic sulphide or the magnetic oxide, these changes taking place in a manner similar to the behavior of pyrite. A one-minute roast at a red heat is sufficient to impart magnetism to chalcopyrite through the formation of the magnetic sulphide; the magnetic oxide requires a longer roast for its formation. Both of these compounds are very strongly magnetic. Chalcopyrite is extensively concentrated by magnetism in Europe, and the application is growing. This is due to the fact that chalcopyrite slimes readily on crushing, resulting in a low-percentage recovery by water concentration. The fine, strongly magnetic particles of chalcopyrite are easily saved by magnetic separation in a product representing a high ratio of concentration. The separation of chalcopyrite from garnet (sp. gr. 3.1 to 4.3) and epidote (sp. gr. 3.25 to 3.5) and other heavy gangue minerals constitutes a further important application of magnetic separation, these silicates being feebly magnetic as compared with roasted chalcopyrite.

Cupriferous Pyrites. — Cupriferous pyritic ores have been the subject of numerous tests which indicate a good percentage recovery from even very low-grade material. Except in special instances, however, such ores may be more cheaply treated by other methods, and the writer is not informed of any installation in operation upon them.

At *Corinth, Vermont*,¹ the Pike Hills Mines Co. is employing the Wetherill-Rowand separator in separating pyrrhotite and chalcopyrite from gangue and from each other. The ore carries pyr-

¹ Communicated by Mr. H. G. Hunter, Supt.

rhottite and chalcopyrite in a quartz and mica schist gangue; the run of mine ore is cobbled to run 3 per cent. copper before going to the mill. The cobbled ore is dry-crushed through 10 mesh, and screened into two sizes, through 20 mesh, and through 10 on 20 mesh. The two sizes are run separately through the separators as they require different adjustments in the height of magnets and intensity of the field. The crushed ore is fed to a Wetherill-Rowand separator, which removes the pyrrhotite; the pyrrhotite carries 0.5 per cent. copper, and is stacked for future use in smelting silicious ores. The residue passing from the separator, consisting of chalcopyrite and gangue, is passed through a revolving-cylinder furnace, and given a slight roast, sufficient to form a film of magnetic sulphide on the chalcopyrite particles. The ore passing from the furnace is cooled and fed to a second Wetherill-Rowand separator which removes the chalcopyrite as a magnetic product; the concentrate from this machine carries from 12 to 20 per cent. copper, and the tailing from 0.2 to 0.5 per cent. copper, varying with the quality of the ore and the amount put through.

At *Fredricktown, Missouri*, the North American Lead Co. is operating four Dings separators on copper, iron, and nickel sulphides. The ore is roasted in a McDougal furnace. The roasted chalcopyrite is removed by the first magnet of the separator, and this product is smelted directly to black copper. The product from the second magnet carries cobalt and nickel, and is treated electrolytically. The percentage saving of copper is said to be high, and the separation efficient. The management is unwilling to make public the details of the process.

At *Ain-Barbar, Algeria*,¹ there are magnetic-separation works treating chalcopyrite-blende ores.

The mines at Ain-Barbar have been worked for many years for the copper values of their ores. These ores also carry blende, and it was for the separation of this mineral from the copper concentrates that the magnetic plant was installed. The ores average 5 per cent. copper and 12 per cent. zinc. A preliminary concentration (hand picking and jigging) raises the grade of the material destined for magnetic treatment to 12 per cent. copper and 28 per cent. zinc. About 25 metric tons of this concentrate are produced daily.

¹ "La Separation Electromagnetique et Electrostatique," D. Korda, pp. 114-119.

The plant is equipped with a cylindrical roasting furnace, two Humboldt-Wetherill separators of four poles each, which treat the coarser sizes, and one double-pole Mechernich separator for the treatment of the finer sizes. The capacity of the Wetherill machines is 8 metric tons in 10 hours.

The ore is given a preliminary roast and classified into four sizes. One Humboldt-Wetherill treats two sizes above 1 mm. and the other two sizes below 1 mm., the dust going to the Mechernich.

While it is not definitely so stated in the description of this plant by the engineer in charge (M. D. Korda), it is inferred that the actual working results are along the lines of those obtained on large-scale tests made in Germany on concentrate shipped from Algeria. These results follow:

TEST ON MECHERNICH SEPARATOR

	Weight kilo- grammes	Per cent. Copper	Per cent. Zinc	Per cent. Iron
Feed.....	2,825	5.4	23.0	15.8
Copper concentrate.....	861	13.5	8.16	33.5
Middling.....	123	12.05	14.05	22.21
Cleaned blende.....	1,841	1.78	40.55	12.87

The feed was classified into the following sizes before separation: 4 mm.—2 mm., 2 mm.— $\frac{1}{2}$ mm., $\frac{1}{2}$ mm.— $\frac{1}{10}$ mm., and dust. The separate products afterwards were combined under the names given in the above table.

TEST ON HUMBOLDT-WETHERILL SEPARATOR

	Weight kilo- grammes	Per cent. Copper	Per cent. Zinc
Feed.....	80.00	6.7	25.4
Feed after roasting.....	8.4	28.2
No. 1 concentrate.....	24.82	18.57	8.49
No. 2 concentrate.....	8.20	11.5	13.60
Middling.....	5.39	5.65	23.38
Nonmagnetic product.....	41.63	1.95	41.05

A farther test on 15 metric tons sensibly confirmed the results on the above preliminary test.

At *Yerington, Nevada*, the Bluestone Mining & Smelting Co. is operating an experimental plant on an ore carrying chalcopyrite in an epidote and garnet gangue. The ore is crushed to 8 mesh and given a slight roast in a tower-roasting furnace and passed over a Wetherill-Rowand separator. The concentrate obtained carries 15 per cent. copper.

RESULTS OF A TEST ON A CHALCOPYRITE-GARNET ORE ¹

The ore for the test carried 2.33 per cent. copper, present as chalcopyrite, in a gangue of lime-alumina garnet. The ore was crushed to pass 10 mesh, roasted, and passed over a Wetherill-Rowand separator excited by 2.5 amperes. The results follow:

	Per cent. of Feed	Per cent. Copper
First belt concentrate.....	9.3	17.6
Second belt concentrate.....	7.2	6.0
Nonmagnetic tailing.....	83.5	0.25

The ratio of concentration was approximately 6 into 1, and the saving 88.5 per cent. in the combined concentrates assaying 12.5 per cent. On other tests savings as high as 96 per cent. were recorded and repeated results obtained between these two limits.

MAGNETIC SEPARATION PLANTS TREATING CHALCOPYRITE ORES ON THE HUMBOLDT-WETHERILL SEPARATOR

COMPANY	Location	Hourly capacity Metric Tons
Mitterberger Kupfer-Gewerkschaft.....	Innsbruck, Austria ...	1.0
Mazzurana Company.....	Predazzo	0.4
Caucasus Copper Company.....	Caucasia, Russia	40.0
Cerre Muriano Mines Company.....	Cordova, Spain	4.0
Aramo Copper Mines.....	Pola de Lena, Spain ..	1.5
Oresund Chemical Works.....	Stockholm, Sweden ..	1.0
Hill & Stewart.....	London, England	1.2
Schuctermann & Kremer.....	Dortmund, Germany

¹ Communicated by Mr. John B. Keating, Bully Hill, California.

At *San Pedro, New Mexico*, the Santa Fé Gold and Copper Company is constructing a magnetic-separation plant equipped with roasting furnace and Wetherill-Rowand separators to treat an ore carrying chalcopyrite in a garnet gangue. Tests have indicated an 80 per cent. recovery with the production of a concentrate carrying 15 per cent. copper.

SEPARATION OF COPPER CARBONATES

The carbonates of copper, sp. gr. 3.5 to 4.0, are feebly magnetic: attempts made to separate them from their gangues commercially have not, however, been successful. The following results are reported as having been obtained on an ore carrying malachite and azurite in a dolomitic gangue.¹ The ore contained 2.9 per cent. copper, and was passed over a Humboldt-Wetherill separator excited by 18 amperes at 90 volts, and re-passed at 14 amperes. Of the total feed, 12.6 per cent. was recovered as a concentrate assaying 17.2 per cent. copper, and 85.4 per cent. of the total feed as tailing assaying 0.75 per cent. copper, indicating an extraction of 75.5 per cent.

SEPARATION OF GARNET

Most varieties of garnet, sp. gr. 3.1 to 4.3, are sufficiently magnetic to be capable of separation in high-intensity magnetic fields. Garnet is separated as a magnetic product at Franklin Furnace, N. J., and at Broken Hill, N. S. W. It has been proposed to remove garnet magnetically from garnetiferous schists for use as an abrasive. An application which is likely to become of importance is the removal of garnet from copper ore and concentrate, garnet and chalcopyrite together being of common occurrence in contact metamorphic deposits. The high specific gravity of the garnet and the tendency on the part of the chalcopyrite to slime, and so cause loss in concentration, often prevent recourse to specific-gravity methods.

SEPARATION OF PYRRHOTITE

Pyrrhotite, sp. gr. 4.5 to 4.65, is in most specimens strongly magnetic, but from some localities, as South Strafford, Vt., and

¹ "La Separation Electromagnetique et Electrostatique," D. Korda, p. 134.

certain places in Virginia, it is too feebly magnetic to be affected by intense magnetic fields. Crane gives the permeability of pyrrhotite from the Stobie Mine, Sudbury, Ontario, as 1.0782, and of a specimen from the Gap Mine, Lancaster Co., Penn., as 1.0775. Pyrrhotite is separated raw as a magnetic product at Corinth, Vt., at Broken Hill, N. S. W., and in Sweden. The feebly magnetic or nonmagnetic varieties of pyrrhotite become strongly magnetic on being subjected to a slight roast at a low heat; only sufficient heat to cause a superficial tarnish appears to be necessary. This procedure was followed in the treatment of pyrrhotite-chalcopyrite ore at South Strafford, Vt.

Numerous experiments have been carried out in the attempt to separate pentlandite, a compound of nickel, from pyrrhotite, with which mineral it is frequently associated, notably at Sudbury, Ontario. This method is successful in the treatment of clean particles, but is not applied commercially, as in most ores the pyrrhotite, even when finely comminuted, carries sufficient pentlandite to give rise to a prohibitive loss in the magnetic tailing.

At *Saxburget, Sweden*,¹ there is an installation employing a Herbele separator to remove pyrrhotite and magnetite from a lead-zinc sulphide ore. The ore assays 11 per cent. lead (as galena), 22 per cent. zinc (as blende) with 14 per cent. magnetite, 2 to 5 per cent. pyrrhotite and 15 to 20 per cent. quartz. The mill flow sheet follows:

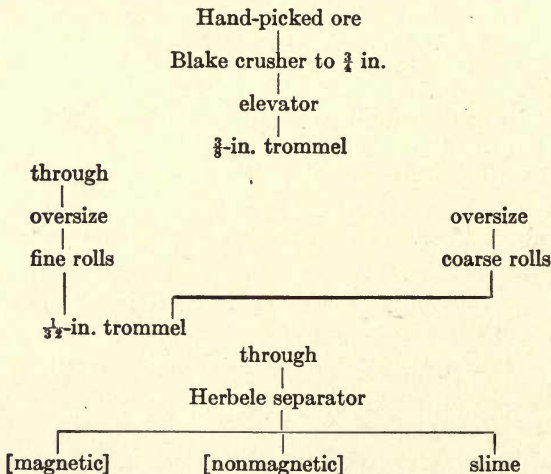

¹ H. C. McNeill, *Jour. Iron and Steel Inst.*, August, 1899.

The magnetic product contains the magnetite and pyrrhotite and but little galena and blende. The nonmagnetic product of the separator is concentrated on jigs, tables, etc., and the quartz removed. The overflow from the separator is allowed to settle and the slime, consisting mostly of blende and silica, is treated for zinc.

At *The Pinnacles Mine, Broken Hill, N. S. W.*, tailing from water concentration carrying argentiferous pyrrhotite associated with garnet and quartz is treated on an Odling separator. The pyrrhotite is removed raw as a magnetic product, leaving the garnet and quartz as a nonmagnetic tailing.

SEPARATION OF LIMONITE

Limonite frequently accompanies cerusite, calamine, and smithsonite, all being the products of oxidation of iron, lead, and zinc sulphides. Cerusite may be separated from the other minerals of such a mixture by concentration, but the specific gravities of the limonite and the zinc minerals are too similar to permit of separation by any method depending upon specific gravity.

Limonite, sp. gr. 3.6 to 4.0, is feebly magnetic; Crane gives 1.0099 as the permeability of a specimen from Nova Scotia and 1.0098 for a specimen from Pennsylvania. Calamine has a specific gravity of from 3.16 to 3.49, while smithsonite varies from 4.3 to 4.45. Limonite may be rendered strongly magnetic by roasting, to which it is usually subjected before separation, although the mineral has been commercially separated raw.

CALCINING LIMONITE FOR MAGNETISM

Limonite is composed of 2 parts Fe_2O_3 and 3 parts water; upon heating this water, which amounts to 14.4 per cent., is driven off, leaving the nonmagnetic sesquioxide, which must be reduced to the magnetic Fe_3O_4 before being capable of separation. The expulsion of the water leaves the mineral porous, and therefore susceptible to the action of the furnace gases. The roasting may be done in two ways, by heating at a comparatively low temperature in the presence of reducing gases, or by heating strongly in the absence of air, by which process one atom of oxygen is driven off. The former method is the one in commercial use, as, if the ore treated contains any silica, a slag is easily formed at the

temperature necessary to drive off the oxygen. At Monteponi the ore is mixed with 2 per cent. fine coal and calcined for 6 hours in revolving cylindrical furnaces; 200 kgm. of lignite is consumed in the fire box per metric ton of ore treated. At Mercadel, Spain, the ore is mixed with from 1 to 5 per cent. of fine coal, according to the amount of iron present in the ore, and ore above 14 mm. is roasted in shaft furnaces while the finer material is roasted in reverberatories. At Austinville, Va., the ore was mixed with 10 per

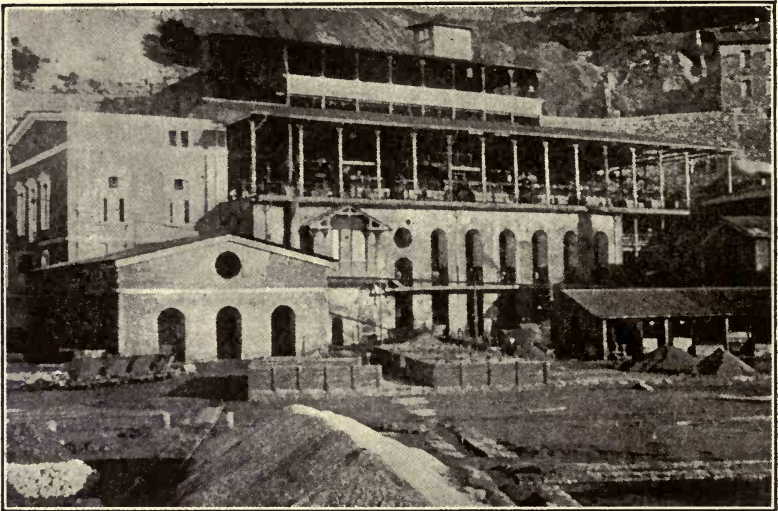

FIG. 69A.—CALAMINE DRESSING PLANT, MONTEPONI, SARDINIA.

cent. coal and roasted in reverberatory furnaces 7×9 ft. with 20×84 -in. fire boxes. The ore remained in the furnaces 2 hours, 1 hour being required to bring the charge up to a red heat, and 1 hour at this heat to magnetize; the furnace charge was 6 tons. Experiments conducted on limonite, in which it was heated to bright redness and producer gas passed over it, gave good results.

At *Monteponi, Sardinia*,¹ there are extensive magnetic separation works separating limonite from oxidized zinc minerals. The valuable minerals are calamine, smithsonite, galena, and cerussite; the lead minerals are in subordinate amount. The gangue is princi-

¹ "Oestr. Zeit. für B. und H.-Wesen," vol. xl, pp. 233 and 347, E. Ferraris; and communicated by E. Ferraris.

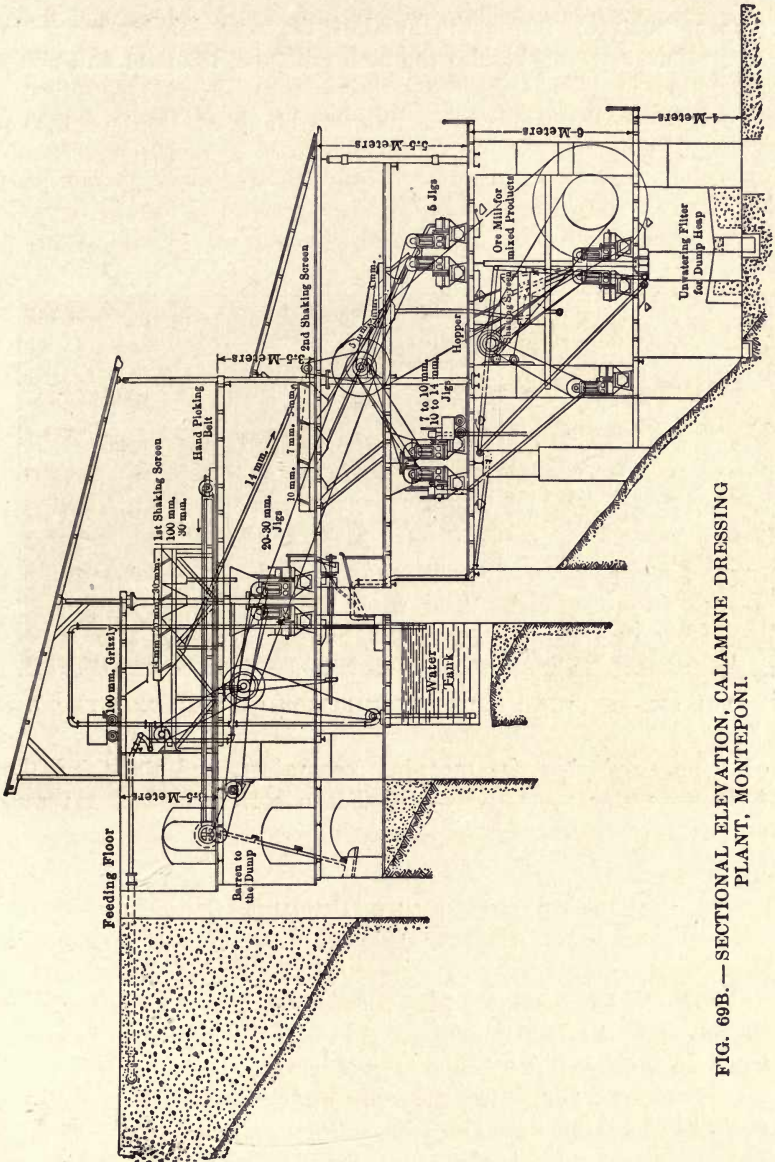

FIG. 69B. — SECTIONAL ELEVATION, CALAMINE DRESSING PLANT, MONTEPONI.

pally limonite and dolomitic limestone, but it also carries a little barite.

The lead minerals are separated by concentration when the light gangue is also eliminated; the middling product, or

zinc concentrate, forms the bulk of the material for magnetic separation, carrying besides the zinc minerals, limonite and zincy dolomite.

There are three magnetic-separation plants at Monteponi, two

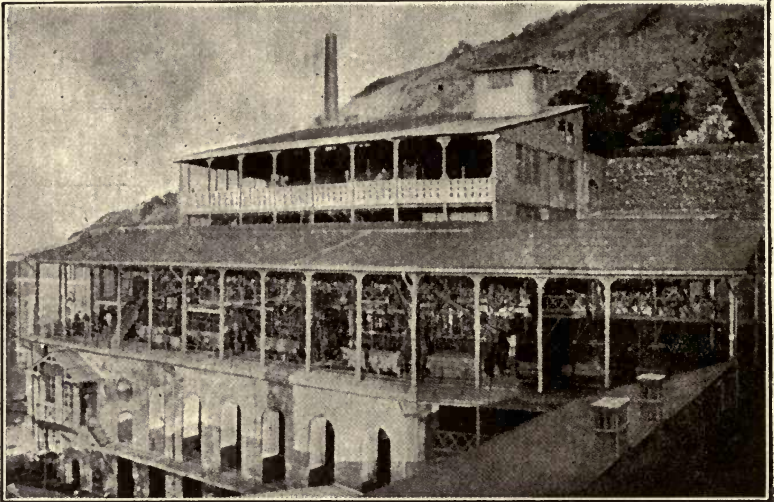

FIG. 69C.—SHOWING OPEN CONSTRUCTION OF MILL, MONTEPONI.

of them employing the cross-belt separators, and the third the drum separator respectively—the Ferraris Nos. II and III separators.

PLANTS EMPLOYING THE FERRARIS CROSS-BELT SEPARATORS

The raw material for separation, crushed to pass a 6-mm. screen, is mixed with from 2 to 3 per cent. of fine coal and calcined in three revolving cylindrical furnaces. These furnaces are 10 meters long and 1 meter in diameter, inside, and slope at an angle of $3^{\circ} 35'$ from the horizontal. They make 15 revolutions per hour. The grate has an area of 1 square meter and burns 3.1 tons of high-ash lignite in 24 hours. The ore remains in the furnace about 6 hours. The capacity of each furnace is 16 tons of calcined ore per 24 hours. The results of a year's operation of these furnaces follow:

	Tons
Working hours, 15,800	
Weight of raw material calcined.....	15,137.6 tons
Weight of calcined product.....	12,184.8 tons
Lignite consumed.....	2,296.9 tons

	Cost, Francs
Fuel.....	3.25
Labor.....	.7376
Power.....	.5000
Oil and repairs.....	.2651
Cost per ton of product.....	4.7527
Cost per ton of raw material.....	3.8250

New revolving furnaces are in course of installation which will be fitted with tubular boilers, and it is expected, through fuel economy, to reduce the cost of calcination below francs 3.50 per ton of raw material treated.

The calcined ore, after cooling, is delivered by a bucket elevator to a series of Ferraris throwing-screens, making the following sizes: through 1 mm., 1 to 2 mm., 2 to 3 mm., 3 to 4 mm., 4 to 5 mm., and 5 to 6 mm., which sizes are treated separately by the six units comprising each magnetic installation. In Plant No. 2 the screen sizes run up to 10 mm., the oversize from which is recrushed; the increase in size of a certain proportion of the particles is due to swelling in the furnaces. The operation of the separators is controlled by raising and lowering the conveyor belts beneath the magnets, this distance being capable of adjustment between 20 and 40 mm. The color of the ore, as it comes from the furnaces, is watched and the distance between the ore stream upon the conveyor belts and the magnets is varied to suit the degree of magnetism imparted to the ore by the calcination as indicated by the color. The combined capacity of the six units is about 1 metric ton per hour; the separators require 6 amperes at 110 volts for excitation, and 2 E.H.P. for operation.

The raw ore carries 22 per cent. zinc, which is increased to

28 per cent. by the roast. Of the material delivered to the magnets one third is removed carrying about 10 per cent. zinc, and two thirds is delivered as zinc concentrate carrying 40 per cent. zinc. The zinc concentrate carries a considerable amount of zincy dolomite which has been disintegrated by the calcination, and is jigged to remove this waste and also any fine coal remaining from the furnaces. The jigging of the calcined zincy dolomite yields a zinc oxide slime which assays from 40 to 48 per cent zinc.

In 1906 this plant treated 6,374 tons of calcined material, assaying 25.98 per cent. zinc and produced 2,264 tons of concentrate assaying 40.87 per cent. zinc, representing a saving of 66.47 per cent. of the zinc. About 10 per cent. of zinc is contained by the calcined iron which may not be separated from it without resort to chemical means.

To enrich still further some of the calcined products single separators are employed, as is also a high-intensity separator.

At *Mercadel, Santander, Spain*,¹ there is a magnetic-separation plant treating oxidized zinc ores. The ores carry calamine in a gangue of limestone and limonite, and assay from 12 to 30 per cent. zinc. The object of the treatment is to raise the zinc content to 50 per cent. The ore is rather clayey in character and a preliminary treatment is necessary before calcination. The ore is washed, the clayey material and the light gangue removed, and the remainder from these operations is calcined. Ore above 14 mm. is hand picked and a considerable amount of limonite thrown out; all below this size is calcined separately. The coarse (above 14 mm.) is calcined in shaft furnaces, and the finer material in reverberatories. The following sizes are made: 14 to 10 mm., 10 to 7½ mm., 7½ to 4 mm., 4 to 1¾ mm., and through 1¾ mm.

The ore is mixed with from 1 to 5 per cent. of fine coal according to the percentage of iron present, and calcined in reverberatory furnaces. The calcined material carries from 20 to 40 per cent. zinc oxide and from 20 to 60 per cent. magnetic oxide. The preliminary operations give rise to fines which interfere with the magnetic separation. After calcining the material is run through a trommel with 1½-mm. holes; the coarse goes to a Herbele-type separator and the fines to a deviation separator.

The coarser sizes, from 1¾ mm. (after the fines are removed by the trommel) are treated on a trommel separator and two products

¹ C. Vial, "Le Genie Civil," vol. xvii, p. 337.

are obtained: a clean zinc product, and a middling product carrying all the iron and much calamine as attached particles. This separator is operated to remove all the iron and make a large middling product. In treating this middling product advantage is taken of the extreme friability of the oxide of zinc; the middling is crushed in a Vapert crusher so regulated that the zinc is powdered while the magnetic oxide of iron is but slightly affected. The separator is operated at 15 R.P.M. and uses a current, varying with the sizes treated, as follows:

Screen Size, Millimeters	Current, Amperes
14 to 10.....	27.85
10 to 7½.....	26.50
7½ to 4.....	23.04
4 to 1½.....	21.40

Mineral is treated carrying as much as 60 per cent. magnetic oxide and as low as 22 per cent. zinc; after passage over the trommel separator the finished product assays 50 per cent. zinc and from 8 to 12 per cent. oxide of iron. The iron tailing carries from 4 to 8 per cent. zinc, mostly combined with the iron. With sizes over 14 mm. hand picking was found more efficient than the separator, though it will separate material as coarse as 20 mm. On fines below 1½ mm. the separator works poorly. The capacity is about 1000 kgm. per hour, and the extraction from 60 to 75 per cent. of the contained iron.

The fines passing a 1½-mm. screen are treated upon a deviation separator perfected by M. Vial and described on another page as the Vial separator. The attraction of the stationary magnets is varied, according to the material fed, by changing the distance of the magnet from the falling sheet of ore; the distance varies from 5 to 25 mm. The material fed to the separator assays from 15 to 35 per cent. zinc, and carries from 20 to 40 per cent. iron; the concentrate carries from 45 to 53 per cent. zinc and the tailing from 8 to 15 per cent. zinc. The capacity is 500 kgm. per hour. A certain amount of powder is entrained by the iron which is screened out by a ¼-mm. screen; this powder assays from 35 to 40 per cent. zinc. The following typical results are given:

Rich feed, 39.87 per cent. zinc and 22.46 per cent. iron, gave a

concentrate with 51.56 per cent. zinc and 10.84 per cent. iron, removing 200 kgm. of waste per metric ton of feed. Lean feed, 30.50 per cent. zinc and 31.87 per cent. iron, gave a concentrate with 48.73 per cent. zinc and 11.80 per cent. iron, removing 350 kgm. of waste per metric ton of feed. The total treatment cost is given as 4 francs per metric ton, consisting of labor 1.25 francs, coal 1.20 francs, general expense and amortization 1.55 francs.

PLANTS SEPARATING LIMONITE FROM OXIDIZED ZINC MINERALS

PLANT	Location	Separator	Capacity Metric Tons per 10 Hours
Societa delle miniere de Montevecchio	Sardinia ...	Humboldt.....	15
San Benedetto Mines.....	Sardinia ...	Ferraris No. 2.....	..
Acquarese Mines.....	Sardinia ...	Ferraris No. 2.....	..
Bertha Mineral Company.....	Pulaski, Va.	{ Wetherill-Rowand { Wetherill Type F	..

SEPARATION OF HEMATITE

Hematite, sp. gr. 4.5 to 5.3, is in most occurrences feebly magnetic, but may be ferromagnetic. It is separable raw in high-intensity magnetic fields. Martite, of the composition of hematite, but probably isomorphic after magnetite, is usually more strongly magnetic than hematite. Extensive experiments¹ have been carried out in the roasting of hematite for magnetism and in the separation of the magnetic oxide so formed, and also in the direct separation of the mineral on high-intensity separators.² That these processes are technically feasible has been amply proved, but, with the present ruling prices for iron ores, the value of the products of magnetic separation is insufficient to pay the cost of preparing the ore for treatment.

¹ Wm. B. Phillips, *T. A. I. M. E.*, October, 1895.

² H. A. J. Wilkins and H. B. C. Nitze, *T. A. I. M. E.*, February, 1896.

SEPARATION OF THE OXIDES OF MANGANESE

Manganite and pyrolusite are sufficiently magnetic to be capable of concentration on separators with high-intensity fields. To be commercially valuable a manganese ore should carry at least 40 per cent. manganese, although, if accompanied by much iron, a lower grade is suitable for spiegel. The following results are reported as having been obtained on a Wetherill separator on culls from a waste heap at Cave Springs, Ga., consisting of particles of chert in a matrix of silicious pyrolusite¹:

	Per Cent. of Total	Per Cent. Manganese	Per Cent. Quartz
Feed.....	100	28.78	43.00
Concentrate.....	52	40.91	20.85
Tailing.....	48	15.54	67.20

Results are reported² as having been obtained on an International separator showing the production of a 41.8 per cent. manganese product from an ore carrying 15 per cent. manganese.

SEPARATION OF THE FRANKLIN FURNACE ORES

At *Franklin Furnace, New Jersey*, the New Jersey Zinc Co. is operating a magnetic-separation mill of 1400 tons daily capacity. Three plants have been erected by this company, a description of which may be found in Richards's "Ore Dressing," pages 1060-1065; the present mill was erected at a cost of about \$600,000, or about \$1.75 per ton of annual capacity.³ The ore consists of franklinite, fowlerite, tephroite and garnet, magnetic minerals, with willemite, zincite, quartz, mica, and calcite. The magnetic minerals are removed from the mixture by twenty-two Wetherill-Rowand separators, the garnet being delivered as a separate product, and run to waste. This magnetic concentrate is treated in zinc-oxide furnaces and the residue, high in manganese, is sent to

¹ H. A. J. Wilkins and H. B. C. Nitze, *T. A. I. M. E.*, February, 1896.

² *Jour. Canadian Mining Institute*, F. T. Snyder, March, 1904.

³ "Report of the Zinc Commission Appointed to Investigate the Zinc Resources of British Columbia," W. R. Ingalls, p. 88.

spiegel furnaces. The nonmagnetic product of the separators is jiggled to separate the willemite and zincite from the quartz, calcite and mica, and sent to the spelter furnaces.

The preliminary crushing of the ore is done by Edison giant rolls and is followed by corrugated and smooth rolls. The ore is reduced to pass a No. 10 slot screen; the sizing is done on Edison fixed inclined screens. The ore is dried in an Edison drying furnace. This consists of a stack 3 ft square and 24 ft. high, made of cast-iron plates. The interior is fitted with cast-iron slats 6 ins. wide and inclined at 45°; these slats dip alternately to the right and to the left, causing the ore to drop from one to the other and exposing each particle to the drying action of a current of hot gases from a combustion chamber outside the building. The results of the magnetic separation follow:

	Per Cent. of Feed	Per Cent. Iron	Per Cent. Manganese	Per Cent. Zinc
Ore.....	100.00
Franklinite concentrate.....	67.48	29.47	13.57	22.94
Zincite and willemite concentrate	23.99	2.20	5.15	48.96
Tailing.....	8.53	4.19

It is stated that the cost of separation, exclusive of taxes, amortization, and interest is 40c. per ton of ore.

SEPARATION OF WOLFRAMITE

Wolframite, sp. gr. 7.1 to 7.5, tungstate of iron and manganese, is feebly magnetic; specimens from some localities are reported to be strongly magnetic. Wolframite frequently accompanies cassiterite in tin ores, and on account of their similar specific gravities (cassiterite 6.4 to 7.02) these minerals may not be separated from each other by specific-gravity methods. The method usually followed in treating crude ore or concentrate of this class is to convert any iron, or copper-iron, sulphides which may be present into magnetic compounds by roasting, and separate these from the mixture by low-intensity magnets, then to pass the remainder through a stronger field which takes out the wolframite as a magnetic product and leaves a nonmagnetic tailing carrying

the tin. Numerous tests on large quantities of tin-tungsten concentrates made preliminary to the installation of separation plants have yielded high extractions, and a number of these plants are at present in operation in Europe and elsewhere. Most of these installations treat the product of preliminary water concentration, but at least one of them is operating on raw ore. Difficulty has been experienced in the separation of wolframite from cassiterite through a tendency of magnetic particles to adhere to the cassiterite, thereby causing it to be drawn into the magnetic product when a strong field is used for separation; this tendency may be overcome by treating the concentrate with sulphuric acid and drying before passing it to the separator. Arsenopyrite (sp. gr. 5.67 to 6.3) is of frequent occurrence in ores carrying wolframite: upon roasting this mineral the arsenic is driven off and the resulting magnetic oxide of iron separated from the wolframite by low-intensity magnets. Care must be taken in the roasting of concentrates carrying cassiterite that the heat does not rise to such a degree as to cause particles of magnetic oxide to become attached to the cassiterite particles, and so cause them to be drawn into the wolframite product.

At *Gunnislake Clitters*,¹ *England*, tin-tungsten concentrate is being separated on Humboldt-Wetherill separators. The ore from the mine is crushed in breakers and rolls, sized, and the sands concentrated on tables and the slimes with Luhrig classifiers. The concentrate is roasted in a Brückner furnace having a capacity of 10 tons daily; this material carries, raw, 12 per cent. sulphur and arsenic, principally the former, and the iron with which these elements are combined is rendered strongly magnetic in the roast. The roasted concentrate, after cooling, is fed to a Humboldt-Wetherill separator which carries 4 amperes on the first magnet and 12 amperes on the second. The first magnet removes the strongly magnetic iron compounds and the second the wolframite, while the tin is contained in the nonmagnetic tailing. The tungsten concentrate and the tin product from the separator are both reconcentrated to eliminate waste. The raw ore yields 0.378 per cent. tin and 0.72 per cent. tungsten. The tungsten concentrate carries from 60 to 64 per cent. tungstate of iron, equal to 46 to 49 per cent. WO_3 . The separator treats 6 tons of concentrate in 10 hours.

¹ *E. & M. J.*, vol. lxxvi, p. 424, Edward Skewes.

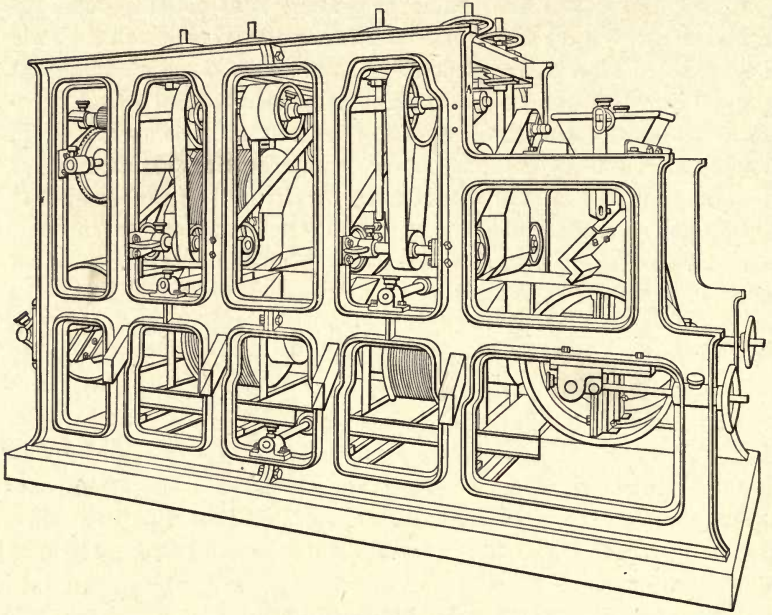

FIG. 70.

At Redruth,¹ Cornwall, England, the East Pool & Agar United Mines Co. is operating a magnetic-separation plant on concentrates containing wolframite, cassiterite, arsenical pyrites, and chalcopyrite. The ore is crushed by stamps, classified, and con-

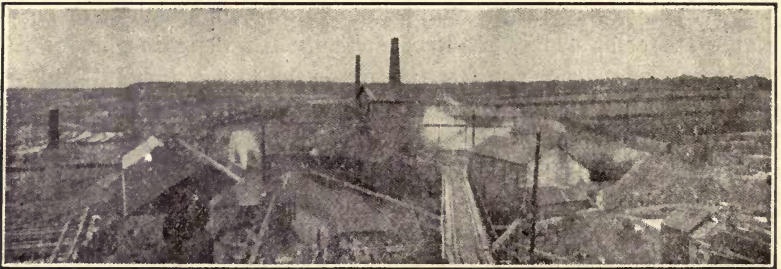

FIG. 71.

centrated on Wilfley tables and Frue vanners, which deliver a concentrate carrying cassiterite, wolframite, and arsenical pyrites, the

¹ *E. & M. J.*, vol. lxxxiii, p. 941, Edward Walker.

gangue minerals and the chalcopyrite being eliminated by the concentration. These concentrates are roasted and the arsenic driven off, to be recovered in the flues, while the residue is again passed over Wilfley tables, yielding a product consisting of about three parts oxide of tin to one part wolframite, and carrying about 5 per cent. magnetic oxide of iron. After drying, this product is passed over a Humboldt-Wetherill separator, which delivers three products: magnetic oxide taken out by the first and weaker magnet, wolframite taken out by the second and stronger magnet, and a nonmagnetic product carrying the tin.

SEPARATION OF MONAZITE SANDS

Monazite sands are natural accumulations or concentrations which carry thorium and cerium oxides as their valuable constituents, together with garnet, menaccanite, rutile, zircon, and other heavy minerals as contaminations. The sand is usually concentrated by washing and the concentrate separated on magnetic separators.

Monazite, sp. gr. 4.8 to 5.1, is feebly magnetic, and is removed from mixtures as a magnetic product in South Carolina, Brazil, and elsewhere. The above-mentioned contaminating minerals are all magnetic in different degrees; menaccanite the most strongly magnetic, followed by zircon, and rutile being the most feebly magnetic; garnet varies considerably in its magnetic properties; all are more strongly magnetic than monazite, which mineral is removed from any nonmagnetic constituents of the sand by the last magnet encountered by the ore, which carries the most current.

At *Ellenboro, South Carolina*, C. P. Meiser is operating Wetherill-Rowand separators on monazite sands. Menaccanite is removed by the first magnet, garnet by the second, and the monazite separated from nonmagnetic impurities by the third.

At *Sapucaia, Brazil*, J. L. Weiler is treating monazite sands on a Humboldt-Wetherill separator. The sands carry monazite, menaccanite, wolframite, cassiterite, and quartz. The capacity of the installation is 2 metric tons per hour.

At *Rio de Janeiro*, Charles Rau & Co. are treating monazite sands on Humboldt-Wetherill separators, the installation having a capacity of 3 metric tons per hour.

The following results are reported from an installation of the Mechernich separator in Brazil working on monazite sands carrying cassiterite, monazite, and menaccanite:

	Per Cent. Tin	Per Cent. ThO ₂
Feed.....	20.59	0.78
Tin concentrate.....	68.30	0.29
Thorium product.....	3.32	1.45
Menaccanite tailing.....	0.14

The tin recovered in the tin concentrate amounts to 93.61 per cent. of the total tin in the feed, and 93.75 per cent. of the ThO₂ is recovered in the thorium product.

SEPARATION OF LEUCITE FROM LAVA

In Italy there are solidified lava streams which average 20 per cent. leucite, which is valuable for its potassium content. Leucite is feebly magnetic and usually carries sufficient iron as an impurity to be susceptible to magnetic separation.

The *Societa Romana dei solfati e chimici, of Rome*, is operating two plants for the recovery of leucite from lava. The leucite is accompanied by hornblende, augite, and ferruginous material, which are removed magnetically. Humboldt-Wetherill separators are employed and the plants have a capacity of 90 metric tons per day. The leucite concentrate obtained carries 80 per cent. leucite, and is treated chemically for its potassium. This company is operating a plant equipped with Ubaldi separators producing a 95 per cent. concentrate from lava containing 25 per cent. leucite.

At *Civita Castellana, Italy*, the Mechernich separator is employed for the separation of leucite. The concentrate obtained is said to contain 95 per cent. leucite. The leucite here is capable of direct separation.

CORUNDUM

Corundum, sp. gr. 4.0, is feebly magnetic, and may be strongly magnetic, through its included magnetite; emery, a variety of corundum, is of a dark gray color, due to magnetite. Corundum

concentrate is cleaned by magnetic separation from associated magnetite.

HORNBLLENDE

Hornblende, sp. gr. 2.9 to 3.4, is feebly magnetic. It may be separated as a magnetic product by the more intense separators. Occurring in a magnetite ore, this mineral may be responsible for a loss of iron in the tailing, as it carries iron but is not sufficiently magnetic to be removed with the magnetite by the separators usually employed on these ores.

CHROMITE

Chromite, sp. gr. 4.32 to 4.6, is usually ferromagnetic; its general formula is the same as for magnetite, with part of the iron replaced by chromium; analysis, iron protoxide, 32 per cent. chromium sesquioxide 68 per cent.

DIAMONDS

At *The De Beers Consolidated Mines, Kimberly, South Africa*, the Humboldt-Wetherill separator is employed to remove magnetic minerals from concentrate carrying diamonds. This concentrate carries magnetite, menaccanite, chromite, and pyrrhotite.

GALENA

At *Gem*,¹ *Idaho*, the Frisco Mining Co. is employing three Dings separators (belt type) for removing lead ore from zinc ore and gangue. The lead is recovered as a magnetic product.

If a piece of apparently pure galena be presented to the magnet in the hand it is attracted apparently as strongly as if it were a piece of iron. This phenomenon may be due to included grains of magnetite.

SEPARATION OF BROKEN HILL ORES

At *Broken Hill, New South Wales*, argentiferous galena occurs with blende in a gangue composed of quartz, rhodonite, and garnet. Upon concentration these ores yield a middling product consisting of blende, rhodonite, and garnet, with a little galena.

¹ Communicated by Mr. W. R. Ingalls.

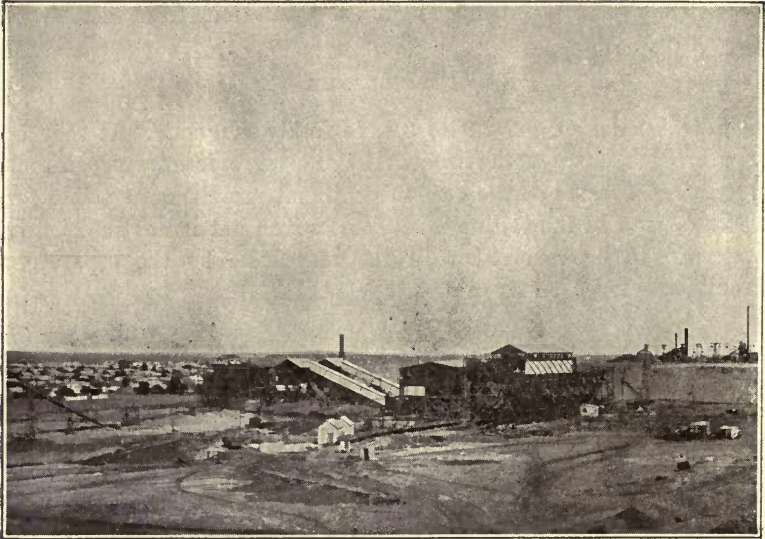

FIG. 72.—BROKEN HILL, N. S. W.



FIG. 73.—BROKEN HILL, N. S. W.

The re-treatment of this product, an immense quantity of which has accumulated from past operations and which is still being added to, is successfully accomplished by magnetic separation. The blende is feebly magnetic, carrying about 7 per cent. iron and 2 per cent. manganese in combination, and is separated as a magnetic product.

Rhodonite, sp. gr. 3.4 to 3.7 (manganese protoxide, 54.1 per cent.; silica, 45.9 per cent), is feebly magnetic. Crane reports a permeability of 1.0176 for a specimen from Franklin Furnace, N. J. It is separated as a magnetic product at Franklin Furnace and at Broken Hill.

Garnet, sp. gr. 3.1 to 4.3, is in most varieties feebly magnetic. The permeability of this mineral depends upon its composition and specimens of the same variety from different localities exhibit widely differing magnetic qualities. It is separated as a magnetic product at Broken Hill and at Franklin Furnace.

The blende is more feebly magnetic than the rhodonite and garnet, which minerals are removed together as a tailing product. The rhodonite occasionally carries silver, in which case it is sent to the lead furnaces and smelted with the galena. The nonmagnetic discharge from the separators, consisting of galena and quartz with a little feebly magnetic blende, is concentrated on jigs and tables.

SEPARATION OF BROKEN HILL TAILING AT THE PLANTS OF THE SULPHIDE CORPORATION

*Plant No. 1.*¹ This plant has a capacity of 150 tons per day on tailing and middling carrying argentiferous galena and blende with rhodonite, garnet, and quartz. Double-pole Mechernich separators are employed for the separation and make three products: garnet and rhodonite tailing, which is sent underground and used for stope filling; magnetic blende, a finished product; nonmagnetic residue, consisting of galena and quartz with a little blende, which is further treated on jigs and tables for the production of a lead and a zinc concentrate and final tailing.

The tailing, or middling from the wet concentration mills, is loaded into trucks from the dumps, hauled up an incline and delivered to a belt conveyor which feeds the drying furnace. This

¹ "Australian Mining and Metallurgy," Donald Clark, p. 414.

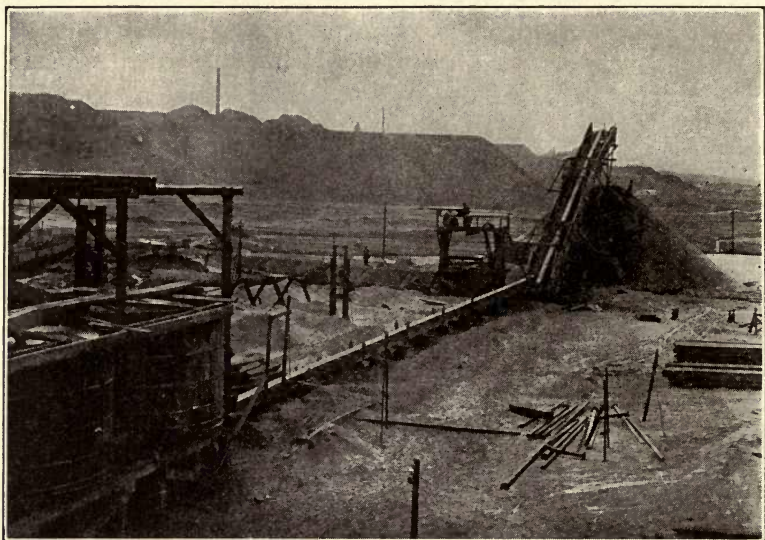

FIG. 74. — TAILING HEAPS, BROKEN HILL, N. S. W.

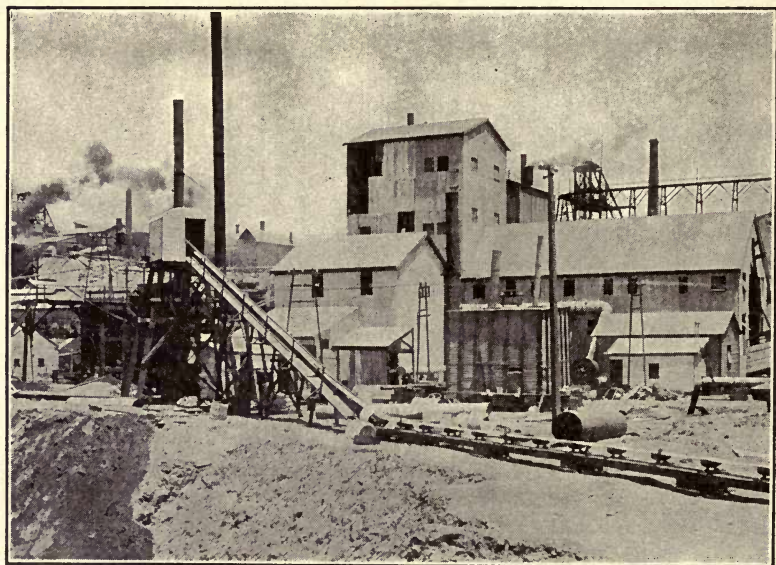

FIG. 75. — CONVEYOR FROM DUMP, PLANT NO. 2, SULPHIDE CORPORATION.

drying furnace consists of a conical shell revolving about a horizontal axis; the material is fed at the apex of the cone, and is carried, by the revolution of the shell, slowly toward the discharge end, where it falls into a conveyor and is transported to the trommels and screens. The dryer is heated by gases from a fire box located at the feed end, the gases traversing the furnace in the same direction as the ore. The heat employed is just sufficient

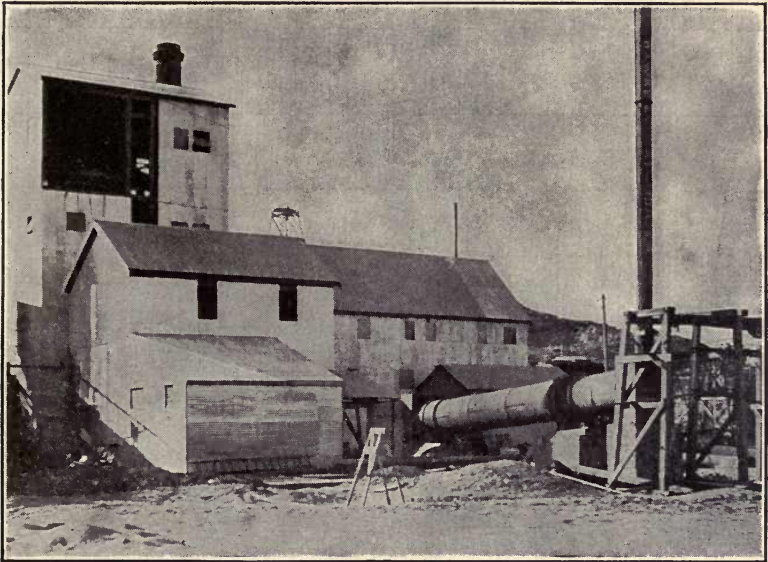

FIG. 76. — DRYING FURNACE, PLANT NO. 2, SULPHIDE CORPORATION.

to dissipate the surface moisture, the sand, as it is discharged, being just too warm to hold in the hand.

The dried ore is classified into three sizes: through $\frac{1}{2}$ mm., between $\frac{1}{2}$ mm. and 1 mm., and from 1 mm. to 3 mm., the oversize at 3 mm. being recrushed and returned to the system. These sized products are treated separately on five double-pole Mechernich separators which yield two magnetic products, garnet and rhodonite, and magnetic blende, and a nonmagnetic product consisting of galena and quartz with a little blende.

Dust is withdrawn from each machine by exhaust fans and in addition the men are required to wear respirators for protection against the dust.

TABLE OF RESULTS ¹

	Per Cent. Zinc	Per Cent. Lead
Feed.....	24.7	4.01
Rhodonite middling.....	19.00	1.80
Blende concentrate.....	45.41	5.75
Nonmagnetic.....	5.13	5.25

Rhodonite middling re-treated gives:

	Per Cent. Zinc	Per Cent. Lead
Zinc concentrate.....	38.00	5.2
Rhodonite tailing.....	5.50

*Plant No. 2.*² This plant is equipped with Motortype separators and has a capacity of 200 tons per day on the tailing product of the wet-concentration mills working on ore from the Central Mine. This material carries galena and blende with quartz and rhodonite, the latter changing to rhodochrosite in the lower levels. It averages, approximately, 7 ozs. silver, 5 per cent. lead, and 19 per cent. zinc. The various stages in the treatment of this material are:

- (1) Drying the crude tailing.
- (2) Preliminary sizing and crushing.
- (3) Final classification.
- (4) Magnetic separation.
- (5) Wet treatment of the nonmagnetic product.

The tailing is removed from the dumps in the following manner: A horizontal belt conveyor is laid along the toe of the dump from which the tailing is to be drawn off; this conveyor is so constructed as to be free to turn about a pivot at the delivery end of

¹ Communicated by the *Electromagnetische Gesellschaft*, Frankfort-a.-M., Germany.

² Communicated by Mr. James Hebbard, manager of the Sulphide Corporation, Broken Hill, N. S. W.

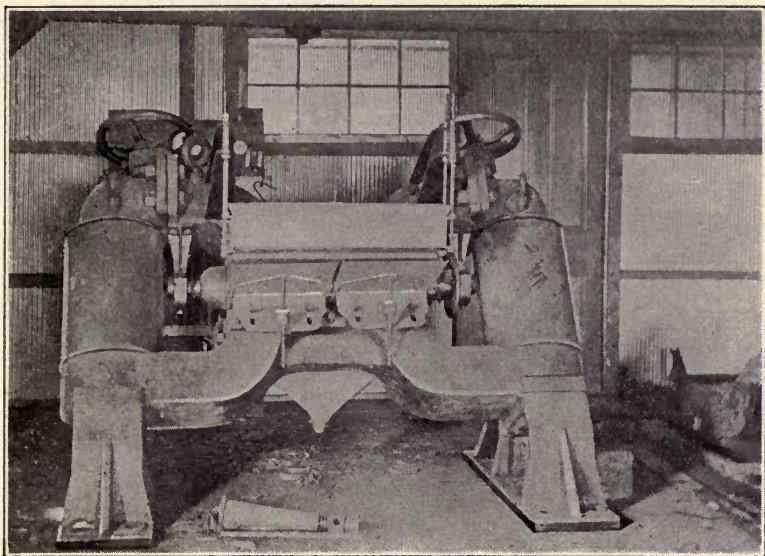

FIG. 77.—MOTORTYPE SEPARATOR, PLANT NO. 2, SULPHIDE CORPORATION.

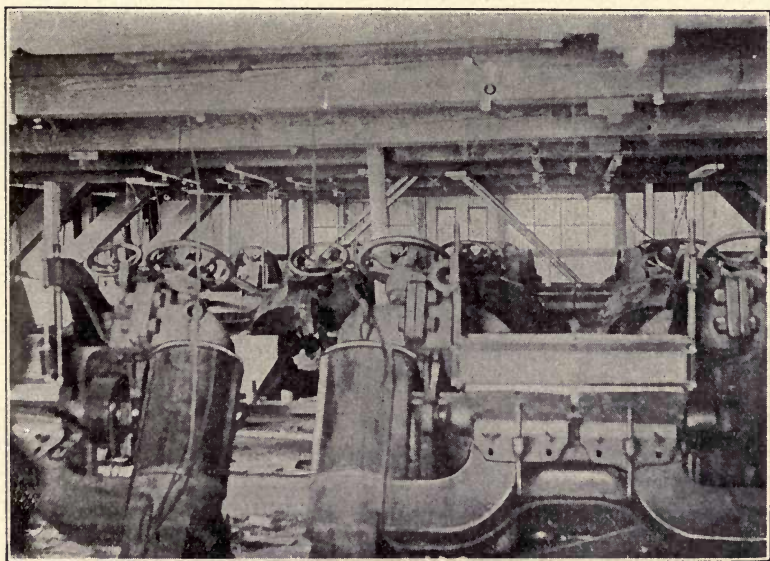

FIG. 78.—SEPARATORS, PLANT NO. 2, SULPHIDE CORPORATION.

the belt, and the whole frame carrying the 200 ft. of conveyor is free to traverse a complete circle in azimuth but for the obstruction offered by the dump. A hopper is mounted on rails on this conveyor frame and can be placed at any required position along the conveyor. The tailing is shoveled from the dump into this hopper. When the dump has been removed to a distance of 5 ft. back from the belt, along its entire length, the framework is grad-

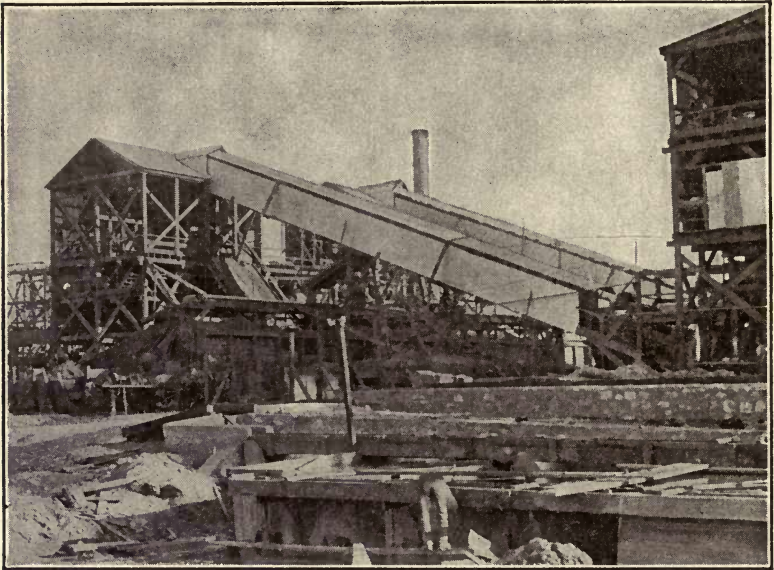

FIG. 79.—SEPARATION MILL, SULPHIDE CORPORATION.

ually moved in toward the dump, turning about the pivot at the delivery end, and shoveling resumed. If necessary, the feed may be maintained while the belt is being moved. This movable horizontal conveyor discharges onto a fixed inclined conveyor, which in its turn delivers to a revolving dryer which drives off the 2 or 3 per cent. moisture contained by the tailing.

The dryer is a revolving cylinder 4 ft. in diameter and 35 ft. long, set at an angle of $6\frac{1}{2}$ degrees, and having internal longitudinal ribs which serve to elevate and drop the tailing repeatedly through the heated air as it gravitates toward the lower end of the cylinder. The tailing is fed from a hopper at the upper end of the cylinder; the fire box is placed at the lower end of the cylinder

into which it discharges its gases through a wrought-iron box with a sloping bottom. The dried tailing falls from the cylinder into this box and is discharged from it into a scraper conveyor leading to an elevator which delivers to the trommel. Here the dried tailing is sized on $2\frac{1}{2}$ -mm. screens, the oversize being passed through a pair of 30-in. Cornish rolls and returned by the same elevator to the same trommel. The undersize is transported to the separation mill by a bucket elevator which delivers to a nest of four wind separators. The wind separators remove the finest particles (approximately from 180 mesh to dust) which are sent to one group of separators; the coarser product of the wind separators is sent to a series of trommels fitted with screens with $\frac{3}{4}$ -mm. holes. The classification thus yields three sizes, coarse, medium, and fine, respectively, from $\frac{3}{4}$ mm. to $2\frac{1}{2}$ mm., from $\frac{3}{4}$ mm. to 180 mesh, and from 180 mesh to dust. These sized products are delivered by conveyors to storage bins which supply the separators.

The separation is accomplished on Motortype separators. The relatively strongly magnetic rhodonite is separated directly as a tailing product carrying little zinc. The feebly magnetic blende is removed as a second product, and the remaining galena and quartz, with a little blende, form the nonmagnetic discharge from the separators. The machines are arranged on two floors, each floor having a separate group of magnetic separators for the treatment of each of the three sizes produced by the classification. The machines on the upper floor yield rhodonite tailing, zinc concentrate, and a galena-quartz product. The machines on the lower floor re-treat the galena-quartz product from the primary machines, group for group, and yield a blende concentrate which is mixed with the blende product from the primary separators, and a final nonmagnetic product which is sent to an auxiliary wet-concentration plant. The rhodonite product and the quartz tailing from the wet-concentration plant are sent underground and there used to fill depleted stopes.

The several products from the separators are discharged through rubber pipes which deliver to conveyors running beneath the machines; these conveyors deliver their products to the shipping bins alongside the railway track.

Two 6-ft. fans and several smaller auxiliary fans are kept continually at work withdrawing the dust from various parts of the

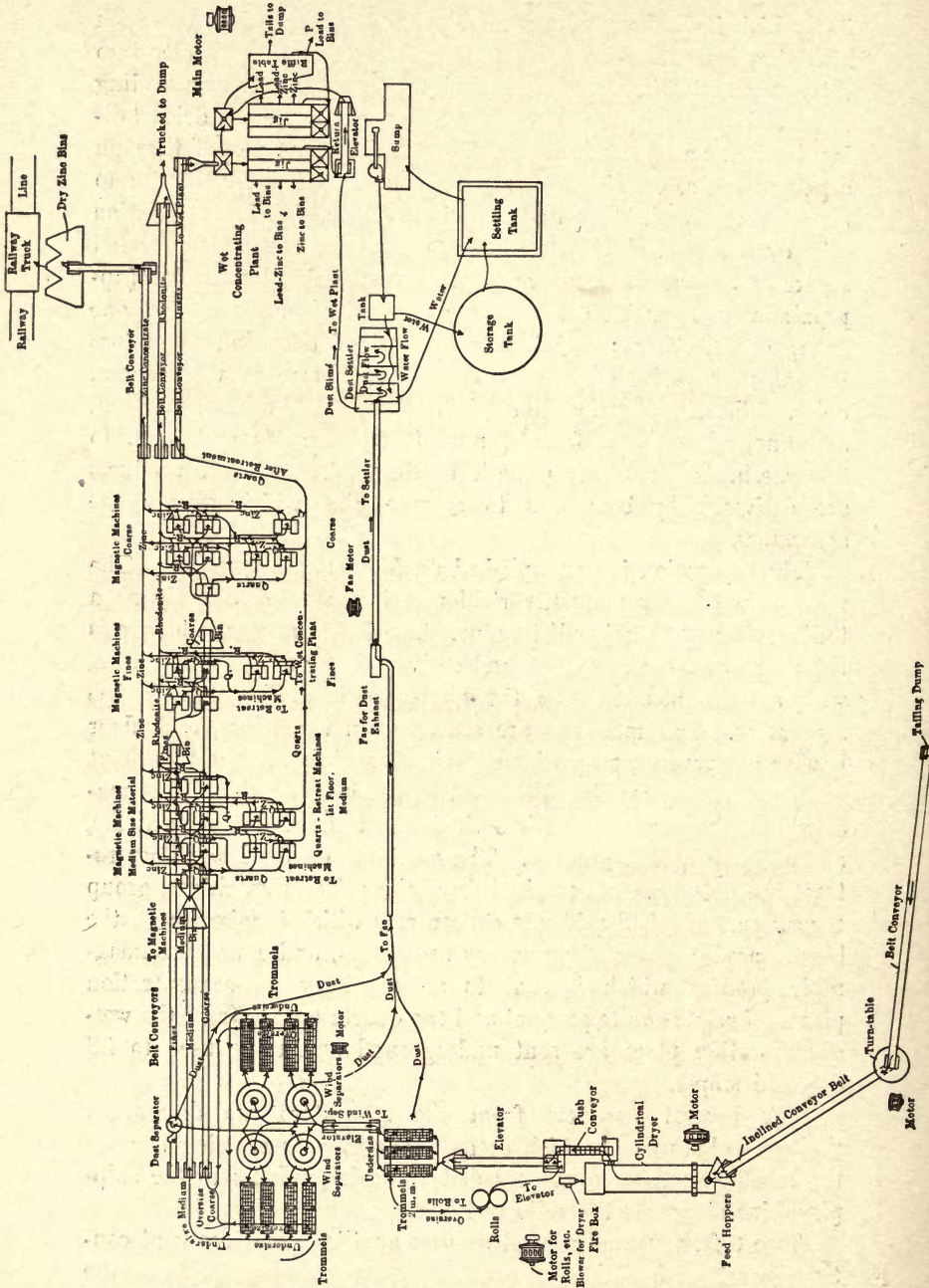

FIG. 80. — ARRANGEMENT OF PLANT NO. 2, SULPHIDE CORPORATION.

plant. The dust so collected is driven into a wooden tower, fitted with suitable baffles, where it rises through a shower of water, by which it is settled and carried to tanks from which it is discharged periodically.

All the machinery in the plant is operated by individual motors which receive their current from a central power station.

In 1906 this plant treated 47,326 tons of tailing assaying 6 ozs. silver, 5.2 per cent. lead, 21.8 per cent. zinc, and recovered 17,753 tons of zinc concentrate assaying 39.6 per cent. zinc, a saving of 68.1 per cent.

SEPARATION AT THE WORKS OF THE AUSTRALIAN METAL COMPANY, BROKEN HILL, N. S. W.¹

The material treated is tailing from water concentration, carrying galena and blende with rhodonite, garnet, and quartz. First the garnet and rhodonite are removed as a magnetic product, and finally the blende, leaving the galena with the quartz as a nonmagnetic product, from which the galena is finally removed by water concentration. About 130,000 tons had already been treated at the time of writing.

The tailing from the piles is trucked to a hopper which delivers an even feed onto a Robins belt conveyor, elevated and passed into a revolving dryer running on friction rolls. The heat is just sufficient to dissipate the moisture, which amounts to from 2 to 3 per cent.

From the dryers the tailing passes to a shaking screen, a hood being placed above the screen to draw off any dust. The material which does not pass through the coarse screen (9 mesh), which is only about 2 per cent. of the total, passes to rolls for crushing. The screened material goes to the boot of an elevator and is carried to the top of the building. It is then distributed between two double trommels, with screens giving three products—2, 3, and 4—No. 1 being reduced.

- No. 1 retained on a sieve having 9 holes per linear inch.
- No. 2 passes No. 1 but is retained on a 20-mesh screen.
- No. 3 passes No. 2 but is retained on a 40-mesh screen.
- No. 4 passes through the 40-mesh screen.

¹ "Australian Mining and Metallurgy," Donald Clark, p. 415.

The last product contains everything below 40 mesh except dust, which is drawn away through steeply sloping pipes connected with a fan, and sent to a dust chamber. The fines are treated by four Ullrich separators and the coarse by four machines of the same type. Each machine contains four separating armatures set

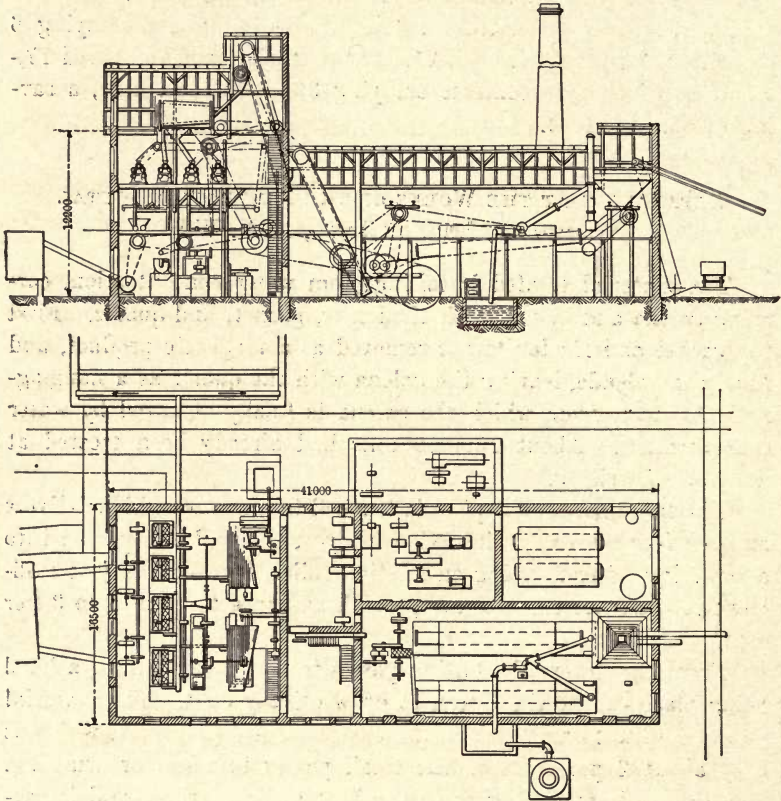

FIG. 81.—PLAN AND SECTION OF THE SEPARATION PLANT, AUSTRALIAN METAL CO.

above and below in pairs. The ore is fed in a steady stream through a hopper having a distributing arrangement consisting of inclined shaker-plates, and falls on the upper armatures. The current is so adjusted on the upper armatures that only garnet and rhodonite adhere and are removed. The balance of the ore drops on to the lower armatures and a stronger current here removes the blende, practically clean.

The final products from the separators are garnet and rhodonite from the upper armatures, and blende from the lower; the nonmagnetic material escaping the attraction of the magnets consists mainly of quartz and galena, with a little blende. There are eight Ullrich separators on the top floor, four treating coarse sizes and four working on fines. The blende remaining with the galena and quartz is removed on two half-machines placed on a lower floor; the tailing from these machines consists almost entirely of galena and quartz; this goes to an ordinary wet-dressing plant, the coarse being concentrated on jigs and the fines on Wilfley tables.

At present about 200 tons of tailing are being treated per day, and about 100 tons of zinc concentrates are recovered; from 50 to 60 tons of lead concentrate are recovered per fortnight.

From 75 to 80 H.P. are required to operate the plant. Each machine requires about $1\frac{1}{2}$ M. and E.H.P. The current indicators show 120 amperes at 110 volts. Steam is generated in two multitubular boilers at 120 lbs. per square inch and utilized in a compound engine; the power installation is about double the present requirements.

The zinc concentrate from the fines assays 46 per cent. Zn.

The zinc concentrate from the medium assays 43 per cent. Zn.

The zinc concentrate from the coarse assays 41 per cent. Zn.

The recovery of zinc by the first machines is from 82 to 86 per cent.

The lead concentrate from the fines assays 45 to 47 per cent.

The lead concentrate from the medium assays 42.5 to 48.6 per cent.

The lead concentrate from the coarse assays 40 to 42 per cent.

The recovery of lead is 80 per cent. The lead concentrates are rich in silver; the zinc concentrates run from 15 to 18 ozs. per ton.

Ten men are required per shift to run the plant. The dust problem is a serious one, but an effort has been made to minimize the evil by the use of exhaust pipes with powerful fans connected with every appliance. The dust is finally collected in a chamber, is wetted down, and sold as slime. It amounts to about $2\frac{1}{2}$ per cent. of the material treated.

SEPARATION AT THE JUNCTION NORTH MINE ¹

The ore treated carries argentiferous galena and blende in a gangue of rhodonite and garnet sandstone; it assays 12.6 ozs. silver, 17.9 per cent. lead, and 9.1 per cent. zinc. Ullrich separators are employed.

The ore is crushed in rock breakers, from which it is carried on a shaking conveyor to a revolving dryer, and thence to a bin. It is next crushed in a ball mill to 1 mm. and sent to trommels; here the ore is classed into the following sizes: between 1 mm. and 50 mesh, between 50 and 25 mesh, and through 50 mesh. The first two sizes are fed separately to the separators while the fines through 50 mesh are treated on Wilfley tables and vanners.

The separators make the following products: (1) Low grade tailing, sent below for use as stope filling, consisting of rhodonite and garnet; (2) a middling product which is further separated into (a) zincy high-grade lead, and (b) zinc concentrates; (3) lead concentrate.

Dust is collected by centrifugal fans and after wetting down treated on vanners.

¹ *E. & M. J.*, vol. lxxx, p. 385.

INDEX

- Adjustments of separators, 16.
Agustin, M. G., 113.
Ain Barbar, Algeria, 154.
Air gap, 11.
 liquid, 4.
 permeability of, 3.
Apatite, 80, 82.
 dust, 15.
Arsenopyrite, 169.
Attraction, magnetic, 3, 11.
Augite, 172.
Austinville, Va., 160.
- Balia Karaidin, Turkey, 137.
Ball Mills, Grondal, 105, 111.
Ball-Norton belt separator, 16, 22, 89, 92, 95, 96.
 cobbing separator, 40, 86, 88.
 double-drum separator, 24, 93, 95, 102, 105.
Beach sands, 83.
Beckert, T., 101.
Bennie, P. McN., 86.
Benson Mines, N. Y., 96.
Bendisberg, Germany, 146.
Bensberg, Germany, 146.
Bilboa, Spain, 146.
Blake-Morscher Electrostatic Separators, 135.
Blende, 116.
 effect of heat on, 117.
 magnetic, 10, 120.
Bliesenbach, Germany, 146.
Bredsjo, Sweden, 81, 108.
Briquetting magnetite concentrate, 84, 85, 98, 101.
Broken Hill, N. S. W., 7, 159, 173, 183.
Bromide of copper, 5.
Budel, Spain, 146.
- Calamine, 159.
Calcination of siderite, 138, 139.

- Canon City, Colo., 136.
Capacity of magnetic separators, 16.
Carlshof, Germany, 134.
Cassiterite, 168, 169, 170, 172.
Caucasia, Russia, 156.
Chalcopyrite, 6, 153, 154, 156, 157.
Chateaugay, N. Y., 91.
Chromite, 4, 173.
Civita Castellana, Italy, 172.
Clarke, Donald, 175, 183.
Cleveland-Knowles Separator, 46, 124, 127, 128; 129, 131, 171.
Cobbing, magnetic, 80.
 separators, 41, 42, 43.
Concentration, magnetic, 5.
Cooling ores after roasting, 21, 125, 127.
Copper carbonate, 157.
Cost of magnetic separation, 17.
Crane, Prof., 138, 158, 159.
Cordova, Spain, 156.
Corinth, Vt., 153.
Crushing ores, 18.
Cumberland, R. I., 83.
Cupiferous pyrites, 153.
- Dannemora, Sweden, 103.
Dellvik-Grondal separators, 25, 105, 107, 108.
Denver, Colo., 121, 135.
Diamagnetics, 3.
Dings separator, 17, 44, 122, 123, 130, 131, 132, 173.
Dortmund, Germany, 156.
Dry crushing, 14, 19.
Drying ores, 20, 87, 143, 145, 168, 177, 180.
Dust, elimination of, 181.
 magnetic, 15.
- Edison, N. J., 84, 98.
Edison belt separator, 40.
 separator, 14, 38, 100.
Ellenboro, S. C., 171.
Ems, Germany, 16, 144.
Entrainment, 9, 14.
Ericksson Separator, 35, 103, 113.
- Feed, depth of, 9.
Feeding devices, 15.
Ferraris, E., 160.
 crossbelt separator, 54, 162, 166.
 drum separator, 56.

- Ferromagnetic minerals, 4.
Field, behavior of substances in magnetic, 3.
 intensity of magnetic, 11.
 of magnetic separation, 5.
 production of a dense, 11.
Fines, separation of, 14.
Floberget, Sweden, 105.
Forsgren separator, 36, 103, 105.
Fowlerite, 167.
Franklin Furnace, N. J., 7, 167.
Franklinite, 4, 167.
Fredricktown, Mo., 154.
Friedrichsseggen, Germany, 146.
Froeding separator, 34.
Furnaces, roasting, 121, 123, 124, 127, 128, 129, 132, 154.
- Galena, effect of heat on, 121.
 magnetic, 5, 173.
 roasting furnace, 124, 127, 128, 129.
Garnet, 156, 157, 167, 171, 173, 175.
Gem, Idaho, 5, 173.
Genumari, Italy, 146.
Granberry, J. H., 86.
Grangesberg, Sweden, 103.
Gregory, F. W., 123.
Gromier, M. G., 150.
Grondal ball mills, 105, 111.
 cobbing separator, 43.
 slime separator, 32, 97.
 Type I Separator (see Dellvik-Grondal Separator).
 Type II Separator, 27, 105, 107.
 Type III Separator, 28, 97.
 Type IV Separator, 28.
 Type V Separator, 30, 96, 97, 101.
Guldsmedsyttan, Sweden, 101.
Gunnislake Clitters, England, 169.
- Hamborn, Germany, 134.
Hansel, N. V., 91.
Hazel Green, Wis., 127.
Hebbard, James, 178.
Hematite, 7, 166.
Herbele dry separator, 57, 150, 158, 164.
 wet separator, 52, 102, 134.
Herrang, Sweden, 19, 81, 96.
Hibernia, N. J., 81, 95.
Hoffman, H. O., 117.

- Hornblende, 172, 173.
Huanchaca, Bolivia, 132.
Humboldt, ring separator 58.
 single roller separator, 53, 134.
 wet separator, 51.
 Wetherill Separator, 16, 63, 134, 137, 141, 144, 145, 146, 155, 156,
 166, 169, 170, 172.
 Wetherill tandem separator, 46.
Hunter, H. G., 153.
- Ilmenite, 4, 83, 171.
Ille et Vilaine, France, 137.
Induction, magnetic, 3, 10.
Ingalls, W. R., 138, 149, 167, 173.
Innsbruck, Austria, 156.
International separator, 70, 135.
Iron ores, separation of lean, 7.
- Joplin, Mo., 132.
- Kaslo, B. C., 132.
Kattowitz, Germany, 134.
Keating, J. B., 156.
Kimberley, South Africa, 173.
Klacka, Sweden, 105.
Knowles Separator, 59.
Kokomo, Colo., 120.
Korda, D., 58, 150, 154, 155, 157.
Krompach, Austria, 151.
- Langguth, E., 5, 10, 101.
Lauenberg, Germany, 145.
Leadville, Colo., 119, 135.
Lebanon, Pa., 96.
Leucite, 172.
Leuschner table separator, 51.
Limonite, 7, 159.
 calcination of, 159, 162, 164.
- Lipine, Germany, 134.
Littlefeld, Germany, 146.
Long Island, N. Y., magnetic sands, 83.
Lulea, Sweden, 82.
Lyon Mountain, N. Y., 81, 91.
- Magnetic attraction, 3, 11.
 cobbing, 80.
 induction, 3, 10.
- Magnetic ores, briquetting of, 84, 85, 98, 101.
Magnetic sands, 84.

- Magnetic separation, 3.
as a process, 7.
cost of, 7.
principles of, 9.
- Magnetic separators, capacity of, 16.
classification of, 22.
cost of, 17.
requirements of, 16.
- Magnetism, residual, 13.
- Magnetite 4, 10, 79.
- Maiern, Austria, 149.
- Manganese, oxides of, 167.
- Marcosite, 116.
roasting of, 116.
- Marienhuetten, Germany, 146.
- Marmetite, 116, 120.
- Martite, 166.
- McClave, J. M., 123.
- McNeill, H. C., 158.
- Mechernich separator, 64, 134, 145, 146, 155, 172, 175, 177.
- Meiser, C. P., 171.
- Menaccanite, 4, 83, 171.
- Mercadel, Spain, 160, 164.
- Meusen, Germany, 145.
- Middling product, necessity of, 13.
- Mineral Point, Wis., 129.
- Mineville, N. Y., 81, 82, 86.
- Minaca, Chihuahua, Mexico, 137.
- Moisie, Quebec, 83.
- Monarch separator, 24, 93, 95, 102, 105.
- Monazite sands, 171.
- Monteponi, Sardinia, 160.
- Motortype separator, 65, 178, 181, 185.
- Mount Hope, N. J., 96.
- Munsterbusch, Germany, 134.
- Neunkirchen, Germany, 140, 146.
- Newland, D. H., 91.
- Nitze, H. B. C., 166, 167.
- Norton, D. H., 91.
- Odling separator, 53, 159.
- Oxygen, paramagnetism of, 4.
- Paramagnetics, 3, 4.
- Payne separator, 69.
- Permeability, methods of determining, 4.
specific magnetic, 4.
unit of, 3.

- Pentlandite, 158.
Persberg, Sweden, 107.
Petersson, Prof., 98, 103, 104, 105.
Peyrebrune, Germany, 134.
Phillips, W. B., 166.
Pitkaranta, Finland, 19, 81, 85.
Platteville, Wis., 128.
Pola de Leña, Spain, 156.
Polarity, induction of, 3.
Port Henry, N. Y., 96.
Port Orem, N. J., 81, 95.
Preparation of the ore for treatment, 18.
Presentation of ore to magnets, 9, 10, 12.
Primosigh dry separator, 67, 151.
 wet separator, 50.
Pueblo, Colo., 134.
Pulaski, Va., 166.
Pyrite, 115.
 cost of roasting, 17.
 cupriferous, 153.
 diamagnetism of, 5.
 elimination of, 83.
 roasting for magnetism, 116.
Pyrrhotite, 4, 157, 158.
 elimination of, 83, 173.
Raglan, Ont., 114.
Ravalo, Sweden, 134.
Removal of attracted particles, 12.
Repulsion, magnetic, 3.
Rhodonite, 10, 173, 175.
Richards, R. H., 98, 119, 150, 167.
Rio de Janeiro, Brazil, 171.
Roasting, cost of, 17.
 furnaces, Galena, 124, 127, 128.
 McDougal, 154.
 White Howell, 132.
 Wilfley, 121, 123, 129.
Rome, Italy, 172.
Romne, Sweden, 107.
Rutile, 171.
Ryllshytans, Sweden, 114.
Sahlin, A., 83.
San Pedro, N. M., 157.
Santa Eulalia, Spain, 113.
Sapucaia, Brazil, 171.
Sardinia, 160, 166.
Saxburget, Sweden, 158.

- Separation, preliminary, 21.
Siderite, 138.
 calcining, 139, 150.
 cost of calcining, 17.
 concentration of, 5, 150, 151.
 separation raw, 140.
Sizing, necessity of, 7, 20.
Skewes, Edward, 169.
Smithsonite, 159.
Snyder, F. T., 167.
Solsbury, N. Y., 96.
Sphalerite, 116.
Stern type separator, 48, 132, 134.
Stockholm, Sweden, 156.
Strassa, Sweden, 81, 108.
Sudbury, Ont., 158.
Sulphur, diamagnetism of, 4.
 elimination of, 83.
Svarto, Sweden, 81, 82.
Switzer, F. R., 96.

Temperature, effect of, on magnetic attraction, 5.
Tephroite, 167.
Testing ores, 17.
Torrelavega, Spain, 134.

Ubaldi separator, 72, 172.
Ullrich separator, 185.
Unter Eschbach, Germany, 146.

Vial, M. C., 164.
 separator, 57.

Walker, Edward, 170.
Weiler, J. L., 171.
Weiskopf, Dr., 107, 108, 119.
Wenstrom cobbing separator, 43, 105, 106.
 separator, 41, 103.
Wetherill-Rowand separator, 61, 89, 135, 137, 153, 157, 166, 167.
Wetherill horizontal separator, 75.
 inclined separator, 76.
 Type F separator, 33, 89, 136, 166.
Wilfley roasting furnace, 121, 123.
Wilkins, H. A. J., 166, 167.
Wolframite, 168.

Yerington, Nev., 156.

Zinc ores, separation of, 6.
Zircon, 171.

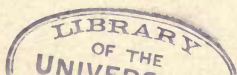

RETURN ENGINEERING LIBRARY

TO →

642-3366

LOAN PERIOD 1	2	3
4	5	6

ALL BOOKS MAY BE RECALLED AFTER 7 DAYS
Overdues subject to replacement charges

DUE AS STAMPED BELOW

MAR 10 1992		

YC 33874

juvel
also see

U.C. BERKELEY LIBRARIES



C035692478

7N
530
G8

Gunther

193292

Mining debt

