

**ELEMENTARY
BIOLOGY
GRUENBERG**

MBL/WHOI

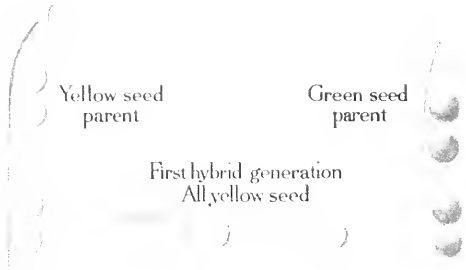

0 0301 0010640 7



The Colorado Potato Beetle
Leptinotarsa decemlineata

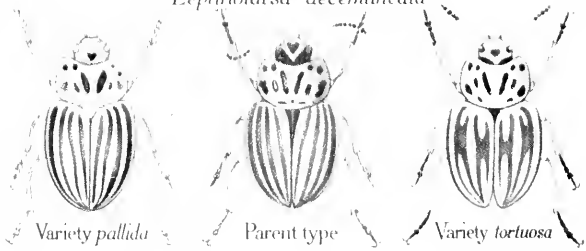

Potato Beetle
Leptinotarsa multicolor

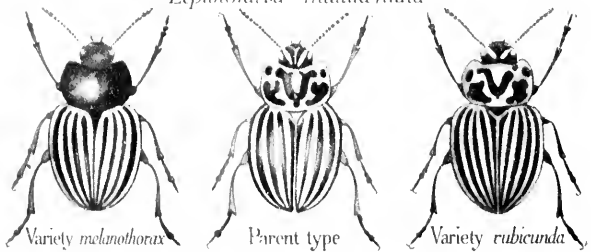

EXPERIMENTS IN EVOLUTION

Mendel found that when pure-bred green-seeded peas were crossed with pure-bred yellow-seeded peas, the offspring were all yellow-seeded. When these hybrid plants were crossed with one another, the following generation produced three yellow-seeded plants to one green-seeded plant. (Illustration about half natural size.)

Tower found that exposing the young stages of potato beetles to extreme conditions of moisture and temperature produced *in the following generations* modifications that were inherited. The results of high temperature and low humidity are illustrated at the left of the parent type; the results of low temperature and high humidity are illustrated at the right. (Illustration about twice natural size.)

ELEMENTARY BIOLOGY

AN INTRODUCTION TO THE SCIENCE OF LIFE

BY

BENJAMIN C. GRUENBERG

FORMERLY HEAD OF BIOLOGY DEPARTMENT, IN THE
JULIA RICHMAN HIGH SCHOOL, NEW YORK

GINN AND COMPANY

BOSTON • NEW YORK • CHICAGO • LONDON
ATLANTA • DALLAS • COLUMBUS • SAN FRANCISCO

COPYRIGHT, 1919, 1924, BY BENJAMIN C. GRUENBERG
ALL RIGHTS RESERVED

724.8

The Athenæum Press
GINN AND COMPANY • PRO-
PRIETORS • BOSTON • U.S.A.

PREFACE

The material in this book, its arrangement, and the method of instruction that it implies are the outcome of some seventeen years of work and thought devoted to the teaching of science to adolescents and to adults. They represent what seems to me at present the kind of knowledge and the kind of attitude that are both wanted and needed, and the kind that it is desirable, from a social point of view, that all of our citizens should acquire sooner or later.

The point of view throughout is the fact that we have to do with constant changes that need to be understood and that need to be controlled. On the one hand, I have tried to eliminate the anthropomorphism that seeks to answer the questions about living things in the form of "Why?"—implying a purposefulness in organisms that is a hindrance rather than an aid to analysis and understanding. On the other hand, I have sought to develop an anthropocentric interest that should humanize the study of living things in terms of appreciation and purpose. The understanding of *how things work* and the solution of problems by means of such understanding are preëminently human achievements; and this view is constantly emphasized from every angle. Man's conquest of his surroundings, through the application of more and more knowledge, through the making of his knowledge more and more trustworthy, furnishes a leading motif.

In the selection and arrangement of the material I have tried to avoid the specialists' divisions into botany, zoölogy, etc.; to the student these are arbitrary and seem to me to confuse rather than to illumine. I have tried to stress the dynamic by speaking of what plants and animals do, and how they do these things, rather than by speaking of the various kinds of organisms that there are, and how to know them apart. So far as possible each main division deals with plants *and* animals, including man, except where the topic is specifically related to one or another group. So far as possible, each unit of the text is related to something that has been previously learned, or to some outside experience of the reader. I have attempted to suggest

the vastness of the living world, and the multiplicity of its interrelations, without discouraging the aspiration to become acquainted with it. I have selected types of problems that best illustrate man's method of adapting himself or his surroundings to his needs, and by means of historical references I have sought to develop a recognition of the interdependence of workers of all nations both in thought and in productive labor, as well as our dependence upon the accumulations of the past. Finally, the idea of progressive change in the organic world is not only explicitly discussed in a special section, but is indirectly suggested in the discussion of various processes and relations.

As to quantity, I have assumed that there must be more material in a textbook than can be comfortably used by any class of students. This is in order to give the teacher an opportunity to select according to individual preferences, according to local and temporary conditions, and according to the interests of the students; and in order to give individual pupils an opportunity to find things of interest that are not "in the lesson." While the work of a class can never be completed in any sense, it is desirable that the text give some suggestion of scope, and that it project the imagination beyond what is actually studied. Moreover, the more thoughtful student should have before him, in connection with the topics discussed, supplementary matter that will point out relations and applications in other fields of interest.

As to method, I have assumed the correlation of textbook with laboratory work, with field excursions, with special topic assignments, and with the study of museum material. But while constantly referring to experiments and to objective data, the text is not interrupted with laboratory directions. I have sought here not merely to keep the reading continuous; I have meant to indicate that there is no one best experiment, no one set of facts, no one type specimen, to support a principle. Truth may be approached by many paths, and I have tried to avoid dogma both as to the approach and as to the conclusions. The relation of science to human welfare is illustrated by the introduction of an unusual amount of quantitative material, chiefly in the form of graphs. This is on the theory that it is not sufficient to show that a scientific principle is reasonable or helpful; it is necessary to show that there is a *measurable* difference in results when various principles are applied. There is no better way of insinuating into the thought of our students the real meaning of the pragmatic sanction.

As to the sequence of topics, I believe that since there is no end to the subject, one point is as good for beginning as any other. For practical administration of instruction it is of course desirable to have a plan of some kind, and the experienced teacher will make up a new plan each year only to find it desirable to make changes in it before the year is over. There is no best sequence; the order in this book has been followed with classes that had to be taught according to a syllabus with a totally different arrangement, and the material can be studied quite as satisfactorily without following the chapters and sections in order. It has been repeatedly demonstrated that the material is usable for beginners in the subject, and that the text is adjustable to a variety of syllabuses; and these are the two important considerations from the viewpoint of course of instruction.

So far as possible, structural details are presented by means of diagrams and pictures rather than by means of elaborate descriptions. All the diagrams designed to clear up complex relations in space or time have been drawn especially for this book, as well as all the figures for which special credit has not been given. In this connection I wish to acknowledge my obligations to those who have been good enough to lend me photographs and other illustrative material, as well as to the artists who have so patiently collaborated in developing the drawings,—Mr. F. Schuyler Mathews, Mr. Frank M. Wheat, Mr. Mateoto Nishimura, and Mr. Edward Taubele.

In the course of my work I have had valuable assistance and criticism from many colleagues and associates in the Commercial High School (Brooklyn), the De Witt Clinton High School and the Julia Richman High School (New York), the American Museum of Natural History, Columbia University, and other institutions. To mention any of these would be to slight others; and while some have given me more time and more direct aid than others, I am too keenly aware of the influence of even passing and casual suggestion to know where to draw the line between those who have helped me and those who have not. I am the lens through which is focused here and now a fragmentary and fleeting view of the biological thoughts of a hundred men and women; and it is this cross section of biology that I offer to my fellow workers, with gratitude for what I have myself received, and with the hope that it will be of help to them.

CONTENTS

PART I. THE WORLD IN WHICH WE LIVE

CHAPTER	PAGE
I. INTRODUCTION	3
II. WHAT GOES ON IN THE WORLD	7
III. FIRE	11

PART II. LIFE PROCESSES OF THE ORGANISM

IV. LIVING THINGS AND NON-LIVING THINGS	15
V. THE LIVING STUFF	20
VI. THE CONDITIONS OF LIFE	25
VII. AIR AND SOIL IN RELATION TO SPROUTING	29
VIII. SEEDS AND SEEDLINGS	32
IX. EXTERNAL FORCES AND PLANTS	37
X. ABSORPTION FROM THE ENVIRONMENT	40
XI. ROOTS OF PLANTS	42
XII. WHAT FOOD IS	50
XIII. THE ORIGIN OF FOOD	53
XIV. THE CHEMICAL CYCLE OF LIFE	57
XV. THE SOIL AS THE SOURCE OF OUR MATERIALS	65
XVI. THE LEAF AS STARCH FACTORY	70
XVII. OUR DEPENDENCE UPON LEAVES AND CHLOROPHYL	73
XVIII. STARCH-MAKING AND DIGESTION	78
XIX. DIGESTIVE SYSTEM IN MAN	81
XX. HEALTH AND FOOD STANDARDS	89
XXI. FOOD REQUIREMENTS	94
XXII. FOOD AND DIETARIES	105
XXIII. FOOD HABITS	114
XXIV. THE SOCIAL SIDE OF THE FOOD PROBLEM	122

CHAPTER	PAGE
XXV. STIMULANTS, NARCOTICS, AND POISONS	131
XXVI. ALCOHOL AND HEALTH	133
XXVII. ALCOHOL AND SOCIETY	137
XXVIII. AIR AND LIFE	143
XXIX. BREATHING IN MAN	148
XXX. VENTILATION	154
XXXI. CONTAMINATED AIR	158
XXXII. FIRST AID AND HYGIENE IN RELATION TO BREATHING	169
XXXIII. TRANSFER OF MATERIALS IN PLANTS	174
XXXIV. THE BLOOD	179
XXXV. THE CIRCULATION OF THE BLOOD	185
XXXVI. HYGIENE OF THE CIRCULATORY SYSTEM	190
XXXVII. THE BLOOD AS A LIVING TISSUE	193
XXXVIII. WASTES AND BY-PRODUCTS OF ORGANISMS	201
XXXIX. HYGIENE OF EXCRETION	205
XL. EXCRETION AND FATIGUE	208
XLI. FATIGUE AND THE WORKER	213
XLII. NERVES AND THE REACTIONS OF ORGANISMS	217
XLIII. TROPISMS AND THE BEGINNINGS OF SENSE	224
XLIV. EYES AND LIGHT	229
XLV. HYGIENE OF THE EYES	235
XLVI. SOUND SENSATIONS	238
XLVII. RESPONSES TO GRAVITY	241
XLVIII. INSTINCTS	244
XLIX. HABIT	248
L. CHEMICAL INJURY TO THE NERVOUS SYSTEM	253
LI. UNITY OF LIFE	260
PART III. THE CONTINUITY OF LIFE	
LII. GROWTH AND REGENERATION	265
LIII. DEVELOPMENT	274
LIV. CONDITIONS FOR DEVELOPMENT	285
LV. NEW ORGANISMS	291

CONTENTS

ix

CHAPTER	PAGE
LVI. SEX	296
LVII. FLOWERS	300
LVIII. POLLENATION	304
LIX. ADAPTATIONS OF FLOWERS	310
LX. FRUIT AND SEED DISTRIBUTION	315
LXI. ALTERNATION OF GENERATIONS	320
LXII. REPRODUCTION IN ANIMALS	327
LXIII. INFANCY AND PARENTAL CARE	331
PART IV. ORGANISMS IN THEIR EXTERNAL RELATIONS	
LXIV. OBSTACLES TO LIFE	337
LXV. THE CONFLICT OF LIFE WITH LIFE	341
LXVI. PROTECTIVE ARMORS OF ORGANISMS	345
LXVII. PROTECTIVE PIGMENTS AND APPEARANCES	351
LXVIII. PROTECTIVE MOVEMENTS	360
LXIX. PROTECTIVE ACTIVITIES	368
LXX. THE FOREST IN RELATION TO MAN	377
LXXI. BACTERIA AND HEALTH	386
LXXII. CONTROL AND USE OF BACTERIA	394
LXXIII. INSECTS AS SPREADERS OF DISEASE	398
LXXIV. INSECTS AS INTERMEDIATE HOSTS	404
LXXV. INSECTS AND HUMAN WEALTH	412
LXXVI. INSECTS AND OTHER ORGANISMS	417
LXXVII. BIRDS IN RELATION TO MAN	425
LXXVIII. SOCIAL LIFE OF ORGANISMS	430
PART V. HEREDITY AND EVOLUTION	
LXXIX. VARIATION	437
LXXX. HEREDITY	443
LXXXI. APPLICATIONS OF THE PRINCIPLES OF HEREDITY	450
LXXXII. HEREDITY AND PROTOPLASM	457
LXXXIII. EVOLUTION	463
LXXXIV. APPLICATIONS AND THEORIES OF EVOLUTION	471

PART VI. MAN AND OTHER ORGANISMS

CHAPTER	PAGE
LXXXV. THE CLASSIFICATION OF ORGANISMS	475
LXXXVI. KINDS OF PLANTS	477
LXXXVII. KINDS OF ANIMALS	482
LXXXVIII. MAN AND HIS RELATIVES	490
LXXXIX. MAN'S BRAIN	497
XC. MAN'S CONQUEST OF NATURE	504
XCI. SCIENCE AND CIVILIZATION	509
INDEX	515



ELEMENTARY BIOLOGY



PART I

THE WORLD IN WHICH WE LIVE

CHAPTER I

INTRODUCTION

1. A new science. At the time of the American Revolution the name *biology*, which means the "science of life," or the "science of living things," had not been invented. And at the time of the Civil War only a few men were engaged in the study of the subject. At the present time, however, the subject of biology has already come to be so important that everyone should know something about it, for a variety of reasons.

2. Biology related to health. In the first place, the people of civilized countries have come to live in larger and larger towns and cities and in closer and closer neighborhoods, so that it is necessary to regulate our lives in many ways that were not necessary when most people lived on farms or in villages. Each person may now be a source of assistance and comfort to more people than formerly; but he may also, quite unintentionally, become a source of danger to many people. When each farm was all by itself, it did not matter very much what became of the barnyard wastes, and most of the kitchen refuse was eaten by the pigs and chickens. In a city the garbage may furnish materials of great practical value, but it may also breed flies and other insects that carry germs, if proper disposition is not made of it. The water supply of a city is a more difficult problem than that of a rural community, and the health of the city depends very largely upon an abundant supply of the right kind of water. We have

found out also that there is an added danger in the greater amount of handling that all food materials receive in passing from the places where they originate to the places where they are finally used up. Again, every time a person suffering from any one of certain diseases comes in contact with another person, there is danger of passing the sickness on. Many of these things were not known fifty years ago, and very many of the regulations which have been adopted depend upon principles derived from a study of living things.

3. Biology related to wealth. In the second place, it has been found that many of the natural possessions or resources of the country have been so wastefully handled in the past that our growing population is likely to run out of things that are absolutely necessary for comfortable living, unless we find some better ways of using our forests, our streams, our soil, and so on. And we must be guided in our use of these resources by an understanding of the principles that can be learned only from a study of living things. The same is true with regard to the protection of various wild animals and plants against extermination, where these happen to be of value to mankind directly or indirectly. And, on the other hand, it is an understanding of biology that makes possible the most effective fight against those plants and animals which happen to be injurious to the living things that are useful to us. In this connection, too, we have learned that it is possible to get a much larger return for our labor, in the way of raising plants and animals for human use, by applying the principles of biology to agriculture, horticulture, poultry farming, dairying, cattle raising, and other industries, so that one needs to understand something of these principles if he is to keep in touch with what is being done by the producers of our food and clothing and shelter materials.

4. Biology related to efficient living. In the third place, it has been observed that much of the unhappiness and weakness and inefficiency of human beings is caused by ignorance of

those matters that have to do with the workings of the living body. A study of living things should give us useful ideas about eating and drinking, about breathing and bathing, about rest and sleep, about exercise and study, about work and play, and so on. These things are important not only to doctors and nurses, who have to do with sick persons, but also to everyone who cares for health and happiness—and who of us does not? Moreover, a systematic study of living things should help us to understand the behavior of the men and women and children with whom we have dealings every day. Much that seems to us queer or unreasonable in other people's conduct, much that seems to us wrong, can be understood from a biological point of view. And it is surely worth while to avoid misunderstandings, false judgments, and ill feelings so far as possible.

5. Biology related to enjoyment of life. Finally, the more time we have away from our work, the more opportunity may we have to become acquainted with the wonderful varieties of living plants and animals that fill the world about us. And if our minds are alert, most of us will be curious to understand not only the habits and ways of these living things, but also their relationships to their surroundings, to one another, and to us. In this way we may get from our acquaintance with nature a large share of enjoyment in life, just as we get much from paintings and music, from natural scenery and travel, from drama and literature, and from intercourse with other living beings like ourselves.

As we become more civilized we shall have more opportunities to enjoy life through our understanding of the things of nature, as well as through appreciation of the doings of human beings.

6. All life related. We might begin our study of biology by capturing the first plant or animal that comes within reach and trying to find out all about it. If we did this in a thorough-going manner, we should find out a great deal about many

other plants and animals, for it is an important truth of life that no being lives by or for itself alone. The life of every plant and of every animal is tied up closely with the lives of many other living beings. The life of man, which is to us so important and so interesting, is most closely bound up with the lives of other beings. *Indeed, that is just the reason why we cannot understand human life without a study of biology.* So it is possible to study this subject from the point of view of man, and that should be the most interesting.

We could take up, one after another, the important activities of a human being that have to do with maintaining life and with enjoying life, and learn the relations of these activities to one another and to the world about us. Or we could begin by inquiring as to the *causes* of the various events that we find making up our lives. One way of studying would be just as good biology as the other. We must select, however, the way that has been found to be most convenient and profitable, all things considered.

CHAPTER II

WHAT GOES ON IN THE WORLD

7. Things change. The world that we know is made up of things that are constantly becoming different, or *changing*. The weather changes from hour to hour, from day to day, from season to season. Non-living objects are constantly changing — moving, burning, rusting, fading, crumbling. Living objects change from day to day, from season to season; they move about, they fight, they build up, and they destroy — that is, they are themselves constantly changing, and they are constantly bringing about alterations in other objects.

8. Physical changes. In the course of these various changes we see materials take on new *forms*, as when clay is pressed into bricks, or when bricks are assembled into houses. We see substances change their *state*, as when solid butter melts to a liquid, or when liquid water evaporates into a gas or freezes into solid ice. We see solids *dissolve*, and we see their conditions change in other ways, as when an electric current, passing through a platinum wire, makes it hot, or when an electric current passes around a piece of iron and makes it magnetic.

In all these changes, and in many others, the material appears to remain essentially the same stuff. These are examples of *physical* changes.

9. Chemical changes. In the course of other changes, certain of the substances involved seem to disappear entirely, while new materials make their appearance. For example, in a fire that destroys a house or a forest, much that formerly existed ceases to exist, and smoke and ashes appear as new substances. In the souring of milk, or in the cooking of food, or in the

making of soap, certain kinds of substance disappear and new substances seem to arise. Changes of this character are called *chemical* changes.

10. Conservation of matter. Whether a change is chemical or physical, the total *amount* of substance remains the same. A pound of ice melts to a pound of water and evaporates to a pound of steam. A quantity of fat plus lye plus water will produce the same total of soap plus glycerin plus water. The total of the materials involved in a fire remains the same. Modern science has been able to demonstrate this in many cases. But whether it can be demonstrated in all cases or not, this principle is assumed in all scientific reasoning about what happens in the world; indeed, it is the very foundation of scientific thinking.

The first law of matter is this: *Matter can neither be destroyed nor created.* Or, stated differently, the quantity of matter remains constant.

11. Complexity of matter. If we examine a piece of granite carefully, we see that it is clearly made up of several different kinds of particles. In a piece of marble, however, all the particles seem to be of the same kind. Alcohol, or chloroform, or water seems to be of the same kind of stuff all the way through; but it is easy to convince ourselves that milk, which may appear to be one kind of stuff, is really made up of several different kinds of matter.

We see that we cannot always tell from the appearance of a body whether it is made up of one kind of stuff or of several kinds. Thus, if we took a piece of rock candy, a piece of clean ice, a piece of clear glass, a crystal of quartz, and a diamond, we should find that they all look very much alike. Yet these five substances are quite different from each other in many ways. The chemist is able to get from the glass certain substances; some of these are present also in quartz, and one of them is present in the ice (water) and in the rock candy (sugar). From the water he can separate out two different

substances, both of which are present also in sugar. But from the diamond he can get only one kind of stuff, no matter what he does with it; and that stuff, called *carbon*, is present also in sugar.

12. Elements and compounds. The chemical changes that take place when a substance is separated into simpler stuffs is called *analysis*, which means a separation, or putting asunder. The breaking up of water into oxygen and hydrogen, by means of an electric current, is a kind of analysis. The chemical change that takes place when two or more substances are combined into a new substance is called a *synthesis*, which means a placing together, or *com-posing*. When hydrogen is burned it combines with oxygen, and the two together form water.

The substances which the chemists have not been able to break up into simpler kinds of matter are called *elements*. A combination of two or more elements is called a *compound*. Many of the elements combine with one another very readily; as a consequence, most of the substances with which we are familiar are compounds. A given set of elements may form a large number of different compounds. Thus, hydrogen, oxygen, and carbon can form an unlimited number of compounds, depending not only upon the *proportions* in which they are combined, but also upon the *arrangement* of the elements. This we can readily understand when we think how a few letters can make many different words, or how a given lot of brick and mortar and wood can be combined into many different kinds of structures.

13. Energy. All the changes that we experience seem to be brought about by the action of some kind of force. For example, *gravitation* changes the positions of the earth and the moon and so on; *heat* changes the states of matter; *light* causes chemical changes in a photographic plate or in wall paper. It is proper to speak of the force of gravity, of heat, of light, of electricity, of magnetism. Each of these forces is considered a form of *energy*, and any one of them can be

changed into some other. Chemical energy and X-rays and motion are other forms of energy.

We may think of energy as that which brings about changes in matter, or that which does work.

14. Energy and matter. If we fix our attention upon any happening or change, we can see that matter undergoes some change, and that at the same time energy undergoes some change. Moreover, we can see that whatever happens has not only been started by some previous change, but also starts some other changes in its turn. Thus we may get the idea not only that energy causes changes in matter, but also that matter causes changes in energy. One statement is just as true as the other. We may get the further idea that every event is a link in an endless chain of events, and that these many links may connect up in every possible direction.

15. Conservation of energy. One kind of energy can be converted into other kinds of energy, but the total amount of energy always remains the same. There is no way of getting energy except from other energy. *Energy, like matter, can neither be created nor destroyed.*

CHAPTER III

FIRE



16. Sources of energy. If we wish to make a machine work, we must apply energy to it, from any one of several sources. We might use the heat of the sun or the movement of the tides, the energy of the wind or of falling water. Another source of energy commonly employed, especially in modern industrial cities, is the chemical energy of fuel. The burning fuel yields heat. This is then transformed into motion or into electricity by means of suitable machinery, and is thus used for doing much of our necessary work. The process of burning is so common, is so much employed as a convenient source of energy, and is so closely related to the liberation of energy in living bodies, that it is necessary for us to know something more about it.

17. Burning. When something burns we may notice three peculiar changes :

1. The fire gives off heat.
2. The fire gives off light.
3. The fuel seems to be destroyed.

From cold fuel we get heat and light — two kinds of energy. How does this happen?

On closer study we find that the heat and light are not created by the fire out of nothing; they are transformed out of other energy which has been present in the fuel all the time. This latent, or resting, energy is *chemical* energy, and represents the power to produce chemical changes in matter. As to the disappearance of the fuel, we can find, on making suitable experiments, that the total amount of stuff is the same after

the fire as it was before, although it now exists in different forms and in different chemical combinations.

18. Air and fire. We know from experience that most substances will not burn unless there is a supply of air. The dependence of the fire upon the air may be due to the fact that burning uses up air (or something in the air) just as it uses up the combustible. Or it may be that in the course of the burning the fuel is changed into a new substance (probably invisible) that interferes with further burning unless it is carried off in the air. We can find out by means of a simple experiment that the fire takes from the air certain materials, and that it also discharges into the air certain other substances. We should also feel confident that the "new substances" are merely rearrangements of the particles of the original fuel and the stuff taken from the air.

19. Burning a synthesis. We have already learned that compounds are substances consisting of two or more elements, and that the formation of compounds is called *synthesis*, or "putting together." Experiments can be made to show that although the burning process may result in *breaking up* compounds—the compounds of the tallow, for example—it also results in the formation of new compounds. Accordingly the *products* of combustion represent more matter than is present in the fuel. The ashes and smoke and the invisible substances resulting from a fire together weigh as much as the original combustible plus the amount of material taken from the air.

20. The gases in the air. The ordinary air is a mixture of gases. Three of these are well known. In addition to the dust and the water vapor, and some gases which are not easily reached through our ordinary experiences and laboratory methods, the atmosphere may be said to have approximately this composition :

Nitrogen	about 79%
Oxygen	about 20%
Carbon dioxid	less than $\frac{1}{25}\%$

Which of these three gases is it that is used up in a fire? Or are two of them, or are all, necessary for fire?

Each of these gases can easily be prepared in the laboratory, and we may try each in turn, to see how it behaves in relation to fire. From these tests we discover the importance of oxygen in relation to burning.

21. Oxidation. The chemist describes the facts of burning by the statement that some substance combines with oxygen, producing new compounds. The heat and light energy that are set free are the equivalent of the *combining force*, or chemical energy, that the fuel has in relation to oxygen—the *attraction* between the two substances. The new compound that is formed when a simple substance (an element) burns is called an *oxid*. Thus, when magnesium is burned, magnesium oxid is produced; when sulfur is burned, sulfur oxid is produced; when phosphorus is burned, phosphorus oxid is produced; and so on. The carbon dioxide which is found in the air is a compound of oxygen and carbon. Water is a compound of oxygen and hydrogen.

When a compound, or mixture (like sugar or wood), is burned, several oxids may be formed at the same time. When sugar burns, the carbon of the sugar goes to form carbon dioxide and the hydrogen of the sugar goes to form water. The carbon and the hydrogen of the wood behave in a similar manner when wood burns.

22. Oxidation in living things. In living bodies the energy transformed in the various activities is derived from food. This food is not burned directly, like the gasoline in an engine; it first undergoes many changes and becomes part of the living body. And the burning, or oxidation, takes place in all the several parts of the body instead of in one central furnace. Another difference between the oxidation in the living body and in our ordinary engines is this: In the living plant or animal there is no flame. Indeed, the oxidation always takes place in the presence of water, whereas the fires with which

we are most familiar cannot be kept up under water. Yet we know that rusting of iron can go on under water, and this rusting is really a roundabout oxidation process.

In the common animals, including ourselves, a large part of the activities which we usually notice have to do with getting materials that can be oxidized. And a large part of the internal activities, which we do not notice, have to do with bringing the fuel and oxygen together and with removing the oxids resulting from oxidation.

The conclusion of this matter is that living beings do their work through energy set free from fuel by oxidation, which requires oxygen in addition to food, and that we can understand the organism's need for food and air in the same way that we understand the requirements of an engine for fuel and draft.

PART II

LIFE PROCESSES OF THE ORGANISM

CHAPTER IV

LIVING THINGS AND NON-LIVING THINGS

23. Living bodies formed. A comparison of living and non-living objects brings to our attention the fact that, whereas the non-living objects of nature are, as a rule, indefinitely shaped masses of matter, the plants and animals with which we are acquainted generally have rather definite shapes, or forms. It is true that crystals of various substances have definite, characteristic forms, and it is true also that no two trees or no two animals have *exactly* the same form. Nevertheless we have no difficulty in distinguishing different kinds of plants or animals by their forms, whereas, besides crystals, we do not find many non-living (natural) objects that show distinct forms.

24. Living bodies organized. Living bodies are like machines in being made up of several fairly distinct parts. Each of these parts acts not usually by itself, but with the coöperation of others and toward some result that concerns the body as a whole. Each part of a living body that carries on some distinct share of the total work is called an *organ*. The arms and legs and wings of animals are organs of locomotion. The eyes and feelers and ears are organs of sensation. The stomach and liver are organs of digestion. The body of a plant or an animal is often spoken of as an *organism* — something made up of organs.

Functions. The special work performed by an organ is called its *function*; and the study of functions constitutes a large part of biology, called *physiology*. Thus, we may say that the function of

the leg is locomotion; the function of the ear, to perceive certain disturbances of the air which we call sounds; the function of a root, to absorb certain materials from the earth; and so on. In studying the behavior of an organ we usually have in mind what it does *in relation to the life of the organism as a whole*. For there are many structures in living bodies that have no special functions, as the vermiform appendix in our own bodies, or the wing of an ostrich. Or an organ may do something that really has no significance in the working of a living machine, as the wagging of a dog's tail or the movement of a boy's ear.

25. Chemical composition. On comparing the chemical composition of living bodies with that of non-living bodies we

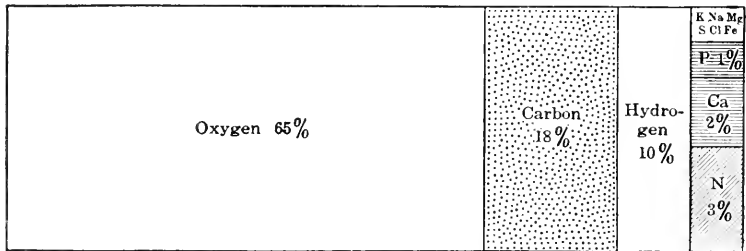

FIG. 1. The chemical composition of the human body

In addition to the elements named there are nitrogen (N), calcium (Ca), phosphorus (P), potassium (K), sodium (Na), magnesium (Mg), sulfur (S), chlorine (Cl), iron (Fe), and traces of iodine, fluorine, and silicon

shall find that, of the seventy-five or eighty elements that have been described by the chemists (see p. 9), from twelve to fifteen are found in the bodies of very nearly all plants and all animals.

There is nothing in this list of elements that distinguishes living bodies. Each of these elements occurs in the soil; some of them occur in the waters of the oceans and lakes; and a few are found in the air.

Organic and inorganic. Yet there is an important difference between living and non-living things on the chemical side. Although the elements of the living body are the same as the elements of the

environment, they are *combined* in ways that are peculiar to living things. Certain compounds are found in nature *only in the bodies of plants and animals*. Some of the more common of these are sugars, starches, fats, albumins, certain pigments, and woody and horny substances. These substances are not themselves *alive*, for we find them also in the dead bodies of organisms.

Formerly substances that could be obtained only from organisms were called *organic* and were distinguished from other substances occurring in nature, which were called *inorganic*. The chemists have succeeded, however, in producing large numbers of compounds that naturally occur only in plants or animals, so that this distinction is not used so much to-day.

Since the forms and the structures of organisms remain about the same after death, and since probably most of the compounds remain the same, we must find other distinctions between living and non-living.

26. Growth. The fact of *growth* is universal for living things. This does not mean that every living body is constantly growing; it means that every organism is capable of growth at some time during its life, or that parts of the body are capable of growth. Yet the crystals of many substances also grow, some of them very rapidly, so that we can actually see them grow. Most of us have seen icicles grow. If by growing we mean becoming larger, then crystals and icicles grow just as truly as caterpillars or babies. What, then, is the real difference between the two kinds of growth?

When an icicle becomes larger it does so through the addition of new layers of ice-stuff (water) on the outside. The growth of a crystal proceeds in the same way. A baby, however, does not grow in this manner. (1) The baby grows not by the addition of baby-stuff from the outside, but by the addition of different kinds of stuff — such as cow-stuff (milk), or hen-stuff (eggs), or wheat-stuff (bread). (2) The growth material is not added on the surface, but is taken in. (3) The new material does not remain the same kind of stuff, but undergoes chemical changes and becomes at last baby-stuff.

(4) The growth of the body goes on not merely by the extension of the surface; it takes place in all parts at once, inside parts as well as outside parts growing.

27. Assimilation. These differences between the two kinds of growth may be summarized by saying that the icicle grows by *accretion*, that is, by the adding of material to the outside, whereas the baby and other living things grow by *assimilation*, that is, through the conversion of foreign material into materials of the body — the "making alike" of stuff that is different.

28. Movement. Most of the animals that we know are capable of moving about and of moving their parts. Many non-living objects also move, as the clouds and the waves. But these objects do not move because of anything that takes place inside; we recognize that they are being pushed about by outside forces. An examination of living plants and animals shows us that there are movements going on inside the organism, and we can see that some of these inside movements result in the movements outwardly visible.

29. Irritability. A very striking and interesting characteristic of living things is their apparent sensitiveness to outward changes, or *irritability*. We ourselves perceive lights and colors, sounds, odors, tastes. The movements of the familiar animals show that they are disturbed by much of what happens about them, in a way that is different from the disturbance caused to a cup when it is dropped. A dog does something when he is hurt; your eye does something when a sudden flash of light is presented; even a geranium plant changes its behavior when placed in a sunny window. This sensitiveness of living things is in some ways the most remarkable fact about them.

Yet we shall find that sensitiveness is not altogether confined to living things. There are certain chemical compounds that are in some ways even more sensitive than plants and animals. Some compounds are so sensitive to mechanical disturbance that they will produce a violent reaction when they are dropped — as in the case of dynamite. This substance is

sensitive also to heat; if a hot poker is applied to a stick of dynamite, the results are said to be more disastrous than the consequences of poking a vicious dog.

30. Fitness. There is one respect, however, in which the sensitiveness of living things differs from the sensitiveness of non-living things. In most cases the living body responds to a disturbance by doing something that will probably save it from further injury. The non-living body, when sufficiently disturbed to do anything, does something that generally results in its further injury or destruction. Thus, when a dog's tail is pulled, he will try to run away, or he will bark or snap at the "thing-holding-tail." These responses are, on the whole, of a kind that will save him from further damage. Indeed, we cannot imagine how living beings would continue to live generation after generation if they had the habit of doing things that tended to injure or destroy them. In contrast to this kind of behavior, think of what the stick of dynamite would do if touched with a red-hot poker. There is nothing here that looks in the least like "trying-to-save-itself."

31. Origin. We do not know anything about the first appearance of life upon the earth. But we do know that every plant and animal now living had its origin in the body of some other plant or animal. In general, non-living bodies do not reproduce each other, but, so far as we know, living things can be produced only by other, similar, living things.

32. Summary. We have seen that growth, movement, and irritability of a certain kind may be present in non-living bodies, but in no case have we found any non-living thing that has all of these properties. Some have one, some another. Living things are characterized by having all three. We may say that it is the *combination* of these properties that distinguishes living bodies from the non-living and from the dead.

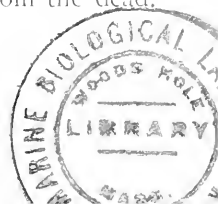

CHAPTER V

THE LIVING STUFF

33. Plants and animals. We have spoken of plants and animals as "living things"; yet animals seem to most people to differ from plants about as much as they do from non-living things. Plants are just as much alive as animals are. They are just like animals in those very points that distinguish living things from non-living. That is to say, they are capable of growth, they are capable of movement, and they are irritable, or sensitive to various kinds of disturbances — just as animals are. And each organism originates from some other organism.

Yet it is true that there are differences between plants and animals. In the matter of growth, plants are even better growers than animals, taking both classes as a whole. This means that generally a ten-pound plant can grow into a twenty-pound plant more quickly than a ten-pound animal can grow into a twenty-pound animal. But there are great variations in the rate of growth among animals as well as among plants. We may also say that in general the plants use up a larger share of their total income for growth, while animals use up a larger proportion of their income as fuel; that is, more of an animal's income is oxidized, releasing energy in the form of heat or of motion.

In the matter of sensitiveness, also, the animals seem, in general, to be ahead of the plants, although we shall find that there are some extremely sensitive plants and some extremely unresponsive animals.

It is difficult to see why, in spite of all the differences, plants and animals should still be so much alike. How is it

that bodies organized in such very different ways come to be so much alike in those three points that are said to distinguish living things from non-living?

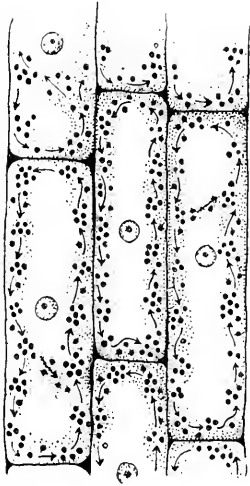

FIG. 2. Protoplasm moves
The arrows indicate the streaming of the protoplasm within the cells

34. Protoplasm. The answer to this question is to be found in the fact that in the bodies of all organisms there is a peculiar substance (or rather a *mixture* of substances) which seems to have all the qualities of living bodies. This seems to be the stuff that can grow; this is the stuff that moves; this is the stuff that is irritable. When seen under the microscope this living stuff seems to be a slimy, or jellylike, substance — something like the white of egg in appearance. Under a more powerful microscope it sometimes appears to have many minute bubbles in it, or to consist of an extremely fine network. This stuff is called *protoplasm*, and in all essential respects it seems to be alike in all plants as well as in all animals.

It is the protoplasm of a plant or of a kitten that grows. It is protoplasm in the body of the Venus's flytrap or of a snake that moves when

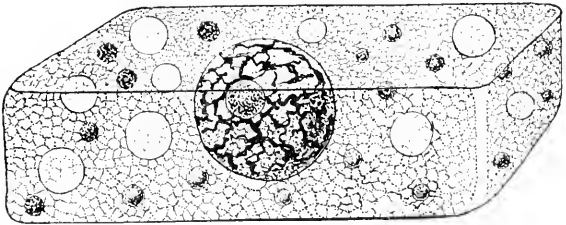

FIG. 3. Diagram of a cell

The mass of the cell content consists of the protoplasmic network, with the coarser-grained nucleus. Within the protoplasm are more solid bodies, and droplets of more liquid substances

the organism springs upon its victim. It is the protoplasm of the geranium or of the worm that is sensitive to the light.

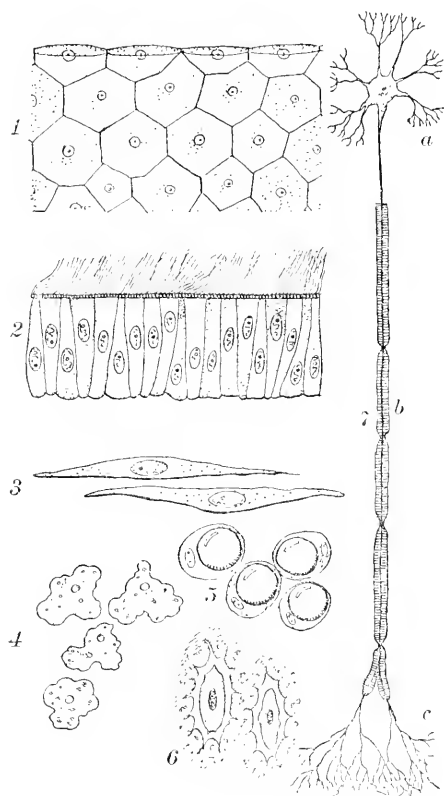

FIG. 4. Various kinds of animal cells

1, flat epithelial cells, like those lining the cavity of the abdomen in man and other animals; 2, columnar epithelial cells, like those lining the air passages, with hairlike projections of protoplasm, called *cilia*; 3, muscle cells, unstriped, like those in the walls of the intestine and of blood vessels; 4, shapeless cells of naked protoplasm, like those of *Amoeba* or of white blood corpuscles; 5, cells containing fat globules, like those in adipose tissue; 6, bone cells surrounded by hard deposits of limy material; 7, a nerve cell, or *neuron* (*a*, the cell body with its branching outgrowths, or *dendrites*; *b*, the longest outgrowth, the *axon*, ending in *c*, the terminal branches)

35. Cells. It has been known for a long time that the body of every plant and every animal is made up of a large number of tiny lumps of protoplasm, each of which is shut off from its neighbors by a more or less definite membrane, or *wall*. A single bit of protoplasm with its wall is known as a *cell*. This name suggested itself to those who first studied the structure under the microscope, because of its resemblance to the cells of a honeycomb. When we look at a living organism, we do not see the protoplasm; we see the walls of thousands of these cells. In the larger plants and animals the outer layers of cells are usually quite dead—that is, the protoplasm is no longer present, only the dead wall remaining. This is true of our own skin, of the bark of trees, and of the hide of the horse.

With the aid of a microscope we can easily make out the forms of many kinds of cells taken from the bodies of plants and animals. We may note that cells of different kinds differ from each other not merely in size but in shape as well. Some cells have thicker walls, some thinner walls. Some seem to have various kinds of solid bodies floating about within the covering; others have few or none of these. Some have smaller and some larger bubbles of clearer liquid.

In some plant cells the protoplasm can be seen to move about. The cells of certain water plants are especially favorable for showing this movement (Fig. 2).

36. Nucleus. There is one special portion of the protoplasm that deserves particular notice. Near the center, or off to one side, we can generally find a portion of the protoplasm

that seems to be denser than the rest. This is called the kernel, or *nucleus*. Because of the transparency of the protoplasm it

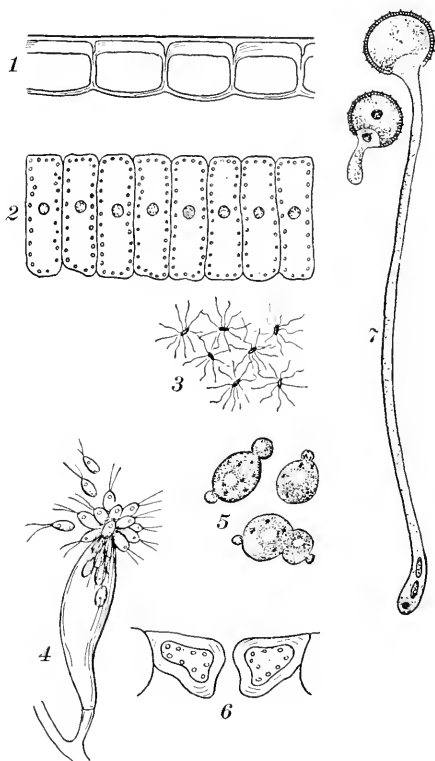

FIG. 5. Various kinds of plant cells

1, epidermal, or skin, cells of a leaf, showing the outer wall greatly thickened, and the *cuticle*; 2, columnar cells, like those of the palisade layer of a leaf pulp; 3, moving ciliated cells, like those of typhoid bacilli; 4, swimming spores of a water mold; 5, budding cells, like those of the yeast plant; 6, guard cells inclosing a breathing hole, or *stomate*, on the surface of a leaf; 7, a pollen tube growing out of a pollen grain

may be difficult to distinguish the parts in many plant and animal cells. It has been found convenient to stain masses of cells with various kinds of pigments or dyes, to make the structure stand out more distinctly under the microscope. When certain dyes are used, the nucleus becomes particularly distinct, since it absorbs these dyes more readily than do other parts of the cell. And within the nucleus we can sometimes see fine little rods or strands (Fig. 3).

37. Numbers of cells. The cells that you have seen under the microscope may have suggested the question whether a body has a definite number of cells. Most plants and animals that you have seen probably have indefinite numbers, and these run into the countless millions. There are some living things, however, that have a very definite and limited number of cells.

One of the simplest animals is the one-celled *ameba*, which lives in stagnant pools and other wet situations. Under the microscope it appears to be an irregular lump of jellylike matter, in which various granules and bubbles can be made out. There is a nucleus, and all around it movements are constantly taking place. The shape of the mass of naked protoplasm is constantly changing, resulting in sluggish movements of the animal. The slimy mass swallows particles that may serve as food, and it crawls away from contained particles that are no longer of service. The animal is sensitive to physical and chemical forces in the environment, and responds to disturbances by contractions of the protoplasm.

38. Tissues. In the bodies of the plants and animals large enough to be seen without a microscope, there are usually many different kinds of cells. Masses of similar cells together constitute what is called a *tissue*. Thus, in our own bodies there are muscle tissue, bone tissue, brain tissue, gland tissue, connective tissue, and other tissues. In the body of an ordinary plant we may recognize bark cells, wood cells, pith cells, skin cells, and other cells (see Figs. 4, 5).

CHAPTER VI

THE CONDITIONS OF LIFE

39. All activities dependent. We may imagine objects of all kinds *existing* by themselves, but we cannot imagine them *doing* anything except in relation to other things. The stars in space influence each other in their movements, and everything that human beings do depends upon the conditions under which they live.

In order to discover the relations of the outside conditions to the activities of a living being, particularly of a plant, we may begin with the characteristic changes that take place in passing from winter to spring. In the winter most of the plants of the preceding season are dead, and those that are not dead are, with comparatively few exceptions, either bare of all foliage or reduced to one of several kinds of "resting states." There are roots and stems lying dormant underground, and there are millions of seeds that look as lifeless as pebbles — until circumstances favorable to life activity appear.

40. Sprouting of seeds. How is it that the seed sprouts in some cases, and not in others? Seeds of many different kinds are kept in boxes or jars for months at a stretch, or even for years, and there is no sign that any of them has sprouted; yet if some of the seeds are placed in the earth, many of them will sprout in a few days.

Just because the gardener or farmer places his seeds in the ground, and they then sprout, we are likely to jump at the conclusion that the soil somehow causes the seeds to begin their active growth after their long rest. But this is not a sound conclusion. The soil is a mixture of many kinds of stuff, some of which may have something to do with the sprouting, and

others of which may have nothing at all to do with it. In order to find out just what it is that causes the sprouting, we must consider the effect of each of the various factors of the seed's surroundings by itself.

41. The environment. Now, in what ways do the conditions surrounding a seed in the ground differ from the conditions in a box or a jar? There may be a difference as to temperature, or as to the air, or as to the amount of water, or as to the light, or as to some of the chemical substances present in the soil. Experiments have been made with every one of these factors, and we also have a great deal of experience that will help us to answer this question in part.

Most of us know that seeds kept in jars will not sprout, whether they are kept in the dark or exposed to light. It is therefore safe to conclude that putting seeds in the ground brings about their germination *not* on account of darkness, but on account of some other factor. We also know that seeds kept in a warm place and seeds kept in a cool place will both fail to sprout, as long as they are in our jars or boxes. The soil may be cooler than our storeroom, or it may be warmer; but it is not *this* that makes them sprout in the ground. Perhaps the soil keeps some of the air away from the seed; but filling a jar with seeds and closing it up tight will not make them sprout. So it cannot be the absence of air by itself, nor the presence of air by itself, that causes the seeds in the ground to germinate.

If we consider the chemical substances present in the soil, our usual experience tells us nothing at all. Perhaps there are certain substances there that cause the sprouting. We might find out by trying some of them. The chemist can tell us what there is in the soil, and he can also prepare the different kinds of stuff in a pure condition. But if we place the seeds in boxes containing the various ingredients of the soil, such as sand, clay, and various salts, we shall find that none of the seeds sprout. The failure of the seeds to sprout under these

conditions may suggest that the one or many substances that perhaps *can* cause sprouting would fail under the conditions of the experiment because the dry substances cannot get *into* the seeds. We should therefore try these substances in connection with water. That, however, at once raises the question whether water by itself has any effect on the sprouting of seeds.

42. Relation of water to sprouting. We should therefore proceed to experiment with pure water. An experiment in which some seeds are placed with various amounts of water, while other seeds from the same lot are kept under similar conditions of air, light, and temperature, but without water, will easily convince us that one of the conditions necessary for starting the germination of the seeds is the presence of a certain amount of water.

We shall find also that some kinds of seeds will fail to sprout if they are completely covered with water, although other kinds will sprout under water. The seeds in the first class are not injured by water; the liquid simply prevents them from absorbing sufficient quantities of air.

43. Relation of temperature. It may be that other factors also play a part. For example, seeds in the presence of water may sprout at one temperature but not at another. From actual experience with seeds of different species of plants we know that some kinds may be safely sown earlier in the spring than others, and that some seeds will fail to sprout when it is too cold or too warm. By means of a systematic experiment in which groups of seeds with water are placed in a number of different places having different temperatures, we may satisfy ourselves that there is a limit in the range of temperature for the sprouting of every species of seed, and that there is a point at which the sprouting proceeds most quickly.

44. Relation of air. It may also be that the presence of water at a favorable temperature is not enough to cause the seeds to sprout. The air may perhaps influence the activity of the young plant after water is absorbed. Experiments may

be planned to show whether, in addition to water, air also is necessary for sprouting. In the same way we can go on and try out the possible influence of light.

45. Summary. Since it is possible to get seeds to sprout without any soil at all, and without any of the ingredients of the soil other than water, it is safe to say that none of these ingredients is *essential* to germination. They may indeed be essential to the later growth of the young plant; but that is another story.

We may learn from these experiments that the sprouting of a seed depends upon an adequate supply of water, upon a supply of air, and upon the temperature remaining within certain limits. We may learn that the soil, in which most seeds do actually sprout, is not itself necessary for sprouting; and that the light, which is really of great importance to life, has nothing to do with sprouting.

CHAPTER VII

AIR AND SOIL IN RELATION TO SPROUTING

46. Sprouting and transformation of energy. The fact that air is in some way necessary for sprouting suggests that the activity of the plant is in some way similar to the process of burning. Further experiments show closer resemblance — for example, the fact that it is the oxygen of the air that is concerned in both processes, and the fact that in both processes the transformation of energy results in the liberation of heat. Moreover, in both cases there is set free a quantity of an oxid — in this case carbon dioxid, as in the case of fires using carbon or carbon-containing materials as the fuel. When we compare these three conditions with what we find in familiar animals, — our own bodies, for example, — we see a similarity that suggests the possibility of all living things carrying on the same fundamental process. And, indeed, it is proper to speak of the young plants in the sprouting seeds as "breathing," and to speak of the chemical changes going on inside the living matter of plants and of animals as "oxidation."

There are very many different chemical processes going on in living things. Oxidation is only one of them. But it seems to be nearly universal, and it seems to be the one that makes available to living matter the energy for its various other activities.

47. The soil and the young plant. We saw that seeds can sprout without depending upon the soil. Yet we know that the soil is essential to the growth of plants. This means that although the young plant in the seed is for a time independent of any soil materials, there comes a time in the course of its development when further growth is possible only on condition of receiving various substances from the soil.

From experiments in which the various materials that make up soil (such as sand, clay, and the various salts) are used separately and in combinations, we learn that it is not the sandiness of the soil, or the color, or merely the water in it that makes the growth of plants possible. We find that it is *something in the soil that can dissolve in water*.

48. The salts of the soil. These soluble substances in the soil are the *salts*, of which there are many different kinds. Are all these salts related to plant growth, or only a certain few—or perhaps only one? These questions have been answered by means of carefully planned and carefully conducted experiments. In these experiments plants were grown in solutions of soil minerals from which now one element and now another was omitted.

It is found that the omission of some elements will absolutely prevent the further growth of the plants, whereas the omission of others will make no perceptible difference. From the results of such experiments the following table has been constructed:

ELEMENT	OCCURRENCE IN PLANTS	SPECIAL FUNCTION
Aluminum	In lower parts	No function.
Calcium	In leaves and stem	Related to the formation of plant cells; "makes plants hardy."
Chlorin	In lower parts	No function, so far as known, although present universally.
Iron	In leaves and stem	Related to the formation of chlorophyll (see p. 54).
Magnesium	In seeds and leaves	Related to the formation of seeds.
Manganese	In lower parts	No function.
Phosphorus	In seeds	Related to the activities of leaves; takes part in the formation of proteins (see p. 56).
Potassium	In actively growing parts	Related to the formation of starch and sugar, and to the growing process.
Silicon	In stems and leaves	No special function.
Sodium	In stems and roots	No function, although present almost universally.
Sulfur	In all growing parts	Necessary to the formation of proteins.

This shows not only whether a given element is found to be necessary or not, but also in what particular way it is related to the life of the plant.

49. The composition of plants. Another method used for determining what there is in the soil that the plant depends upon for its activities is that of analyzing the plant to find out of what it is composed. Such an analysis shows that certain elements are present in the plant body, and we know that some of these elements are present also in the soil. It is therefore reasonable to suppose that the plant derives these elements from the soil. It does not follow, however, that everything taken by the plant from the soil is of use to the plant. The most common elements found in plants are the following :

Carbon	Sulfur	Potassium
Oxygen	Phosphorus	Sodium
Hydrogen	Calcium	Iron
Nitrogen	Magnesium	Chlorin

(Compare with the composition of the human body, Fig. 1, p. 16, to see how much we are like the plants.)

Other elements may also be found in some plants, as silicon and iodine; but it is doubtful whether these are essential to the life of the plant. Indeed, not all of those given in the above list may be absolutely necessary, but most of them certainly are. Since a large part of the plant's life consists of growing activity, the material for growth or for building up the body must be a first condition of life.

The materials taken from the soil by the growing plant are sometimes called *plant food*. Strictly speaking, these are not food, as we shall see later (see p. 50); they are merely some of the materials out of which plants manufacture their food.

CHAPTER VIII

SEEDS AND SEEDLINGS

50. The structure of seeds. On examining the outside of any seed we can usually find a scar that was left when the seed broke away from the little stalk by which it was fastened inside the *fruit*. Very often we can also find a tiny hole through the seed coat. This hole is called the *micropyle*. The seed may absorb water through this hole, but it does not seem to be of any importance in the mature seed. (See p. 302 and Fig. 134.)

The coat of the seed, which sometimes has more than one layer, is apparently a protective covering, although in some species of plants the protection is furnished by the fruit in which the seed is borne. When the coat of a seed is removed, we find the part of the seed that is really important in the life of the plant. In fact, we may say that the seed contains a young plant. The embryo is really a small, young plant; and we may consider the seed as a young plant (embryo) plus its protective covering.

51. The embryo. That the embryo is a plant can be seen from a careful comparison with the parts of any ordinary plant. Now, what are the parts of a plant? Ordinarily we see above the ground only the stem and the leaves, but most of us know that under the ground is the *root*. In most plants the stem and the root are *branching* organs; in some plants the leaves also divide or branch. All of the stem system, together with the leaves, we sometimes call the *shoot*. So we may say that the plant consists of *root* and *shoot*. But sometimes we find flowers on a plant, or fruit. The flower is really a special kind of shoot (see pp. 300 ff.), consisting of a very short stem with many special kinds of leaves crowded closely together, and with

certain other special organs that have to do with the making of seeds. One of these organs, when ripened, becomes the fruit.

Now, in the embryo of a bean or a peanut or a pumpkin seed, it is very easy to find the parts corresponding to the root and the parts corresponding to the shoot. The two fleshy parts that make up the bulk of the embryo are really special kinds of leaves. If we bend them aside carefully in the embryo of a seed that has been soaked in water, without breaking them off, we can see that they are attached to a short stalklike piece. One end of this rod tapers to a point; this tip corresponds

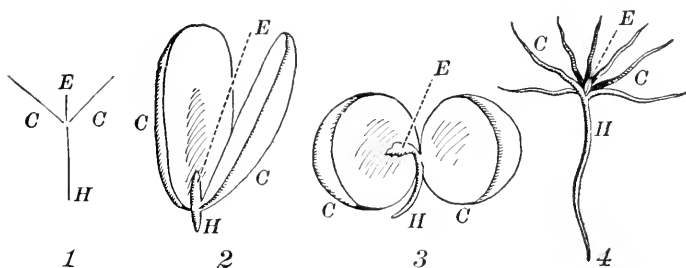

FIG. 6. Embryos of plants

1, diagram showing relative positions of the parts of the embryo; 2, embryo of peanut; 3, embryo of pea; 4, embryo of pine; C, C, cotyledons; E, epicotyl; H, hypocotyl

to the root. The rest of the main stalk, with its outgrowths, corresponds to the shoot. The upper end may be enlarged at the tip into a tiny knob or bud; in the bean embryo we can make out two little leaves folded neatly over each other.

The two fleshy leaves are called seed leaves, or *cotyledons*. The part below the meeting point, sometimes called the radicle, is the *hypocotyl*, which means "below the cotyledon." The part above is called the first bud, or the plumule, or the *epicotyl*, which means "above the cotyledon" (Fig. 6).

Although the cotyledons are considered to be leaves, they do not in all plants become flat and green like the more familiar leaves. In many cases they do not even come above the ground during the young plant's development, as in the pea plant.

The function of the cotyledons seems to be confined in most cases to the holding of reserve food, which is drawn upon by the baby plant until it is developed far enough to get food for itself.

In some kinds of seeds the cotyledons are very thin; in such cases we usually find that there is a mass of food material packed in all around the embryo. A mass of food thus placed about the embryo is called the *endosperm*, which means "within the seed." The grains and the castor seed are good examples of seeds that contain endosperm (Fig. 7).

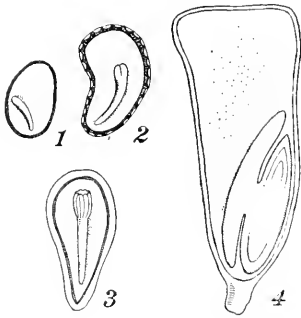

FIG. 7. Seeds with endosperms
1, asparagus; 2, poppy; 3, pine;
4, maize, or Indian corn. (All shown
in longitudinal section)

When we compare the embryo of a grain, such as the corn, with the other embryos that have been mentioned, we find one great difference in the structure. The grain has but a single cotyledon. This is rather large, though not fleshy, and only the tip comes out of the seed covering as the first leaf. The base remains in contact with the endosperm and serves as an "absorbing organ," withdrawing food material from endosperm and transferring it to the growing plant.

There are many plants, besides the grains, that have but one cotyledon in the seed. This fact would not seem to be of any great importance by itself, but it is connected with so many other characters, such as the veins in the leaves, the structure of the stem, the structure of the flower, and general habits of life, that we sometimes designate one of the main divisions of seed-bearing plants as the *monocotyls*, meaning the "one-cotyls," and another as the *dicotyls*, or "two-cotyledon" plants. Among the dicotyls are included most common weeds and cultivated plants, outside of grains.

The seeds of the plants belonging to the pine family (fir, spruce, hemlock, etc.) have usually several cotyledons, and this family is accordingly designated as the *polycotyls* in some books, this name meaning "many cotyledons" (see Fig. 6).

52. Food in seeds. The concentrated food found in seeds of common plants is of interest to us in three ways: First of all, we may infer that this food is actually used by the young plant until such time as it is able to provide for itself. That this is a sound inference may be tested by separating from several seedlings the "food reserve." Next, we can observe that the cotyledons in such plants as the beans and peas do actually shrivel away as the plant becomes larger; and that the

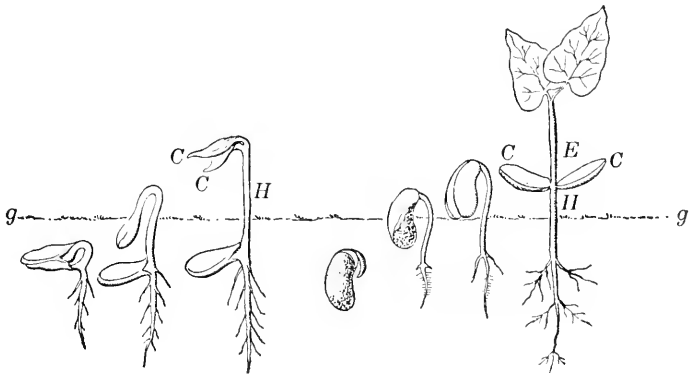

FIG. 8. Young plants emerging from seeds

On the left, squash; on the right, bean. In the squash a little outgrowth on the hypocotyl keeps the seed coat in place while the cotyledons are carried aloft. *C, C*, cotyledons; *E*, epicotyl; *H*, hypocotyl; *gg*, ground line

contents of the corn grain also disappear as the seedling develops. Finally, by means of chemical experiments we can see that the changes taking place in the "food masses" of the seedlings are of the kind we should expect to find if the food were actually being transported to the growing portions. (See p. 79.)

A second question that may arise is that of the origin of the food which we find in the seeds. It is enough for the present to consider that, as the developing seed obtained the materials for its growth from the parent plant upon which it originated, the reserve food that we find within the coat of the seed was probably also obtained from the

parent plant. How the parent plant makes its food we shall learn in the lessons on food-making (see p. 53).

Another point of interest in regard to the food in the seed is that of its availability for human use. This will be discussed later (see Chapter XXII).

53. Seedlings. If we examine a few seeds that have been planted two or three days, we may see that the hypocotyl has emerged and is assuming the appearance of a root. At the other end of the embryo we may see the unfolding epicotyl. If we examine different stages of peas, squash, oats, corn, bean, and so on, we shall be able to see a great variety of methods by which the young plant crawls out of its covering and establishes itself in the soil (Fig. 8).

Large seeds, containing a large amount of reserve food, are apparently at an advantage, since they may develop more root and more shoot before they are overtaken by the necessity of providing themselves with food. We should therefore expect that plants with large seeds would be, on the whole, more successful in establishing themselves in a new territory than plants with small seeds. We shall find, however, that the best spreaders in the plant world are those with rather small seeds. The speedy and secure establishment of the individual plant is of great advantage, but even more important is it that seeds be well scattered. And in this respect the small-seed plants with very numerous seeds have a decided advantage.

CHAPTER IX

EXTERNAL FORCES AND PLANTS

54. Gravity and growth. The force that acts most continuously upon living things is doubtless gravity. Temperature varies constantly, and the light is intermittent as well as variable. We do not know much about the relation of electrical conditions of the atmosphere to living things, and chemical conditions we can consider only as they arise in connection with particular kinds of substances. But gravity seems to be constant without regard to hours or seasons. It is therefore interesting to find how living things, and especially plants, behave in relation to this force.

The question often occurs to people who have planted seeds, or who have watched others do so, Does it make any difference which side of the seed falls uppermost? We know that the lower end of the hypocotyl becomes root, and that roots usually live in the earth. What would happen if a seed were placed in the ground with its hypocotyl pointing skyward?

We can easily find out by means of experiments that permit us to watch the development of the young plant under conditions that make gravity act upon hypocotyls from different directions. Incidentally we can discover that the shoot of a plant is also sensitive to gravity, but that it responds in quite the opposite way from the root. That is to say, the shoot tends to grow *away from* the earth, whereas the root tends to grow *toward* the earth.

55. Tropisms. To many of us this sensitiveness of the plant will come as something unexpected, for we do not commonly think of plants as sensitive beings. The turnings that a plant or an animal shows in response to the one-sided action of

some external force is called a *tropism*, from a Greek word meaning "to turn." The response to gravity is called *geotropism*, or "earth-turning." We may distinguish the behavior of the root and the shoot by calling the former *positive* geotropism, and the turning away from the earth, *negative* geotropism.

56. How the plant moves. The plant has no muscles, nor any structures that may be compared to muscles. The turning of the root or of the stem is not the same kind of movement as that which takes place when you turn your head or bend your body. The curvature is brought about by a *growth*. The shoot or the root grows more rapidly on one side, or the growth is stopped on one side, so that it grows in a curved line.

57. Light. That plants are sensitive to light is well known to all who have had an opportunity to observe either house plants or garden plants. A careful measurement of the growth of plants left in the dark, and of similar plants exposed to daylight, shows very definitely that withholding light from a plant accelerates its growth. But since darkness is a purely negative condition, it would seem that *light actually restrains the plant's growth*. This is so different from what we commonly believe, that it is worth studying more closely.

58. Phototropism. Another response of plants to difference of illumination is shown when we leave them exposed to a one-sided illumination. Such an experiment will convince us that a plant is sensitive to light just as it is to gravity.

The turning of a plant axis in accordance with the direction of the illumination is called *phototropism*. Most of our common plants are *positively* phototropic in the shoot, and somewhat *negatively* phototropic in the root.

59. The influence of water. The turning of leaves and stems toward the light and the turning of roots and stems according to the direction of the "earth's pull" are evidences of the living organism's irritability. It has been shown that the plant is also sensitive to various chemicals, and we can determine for ourselves that it responds to water.

These experiments must not be interpreted to mean that the roots somehow know that there is more water on one side, or that they have any way of choosing to go toward the water. We may say merely that the plants are influenced in their behavior by these various external conditions.

60. Fitness. In the three sets of responses studied — namely, the responses to gravity, to light, and to water — we can see an advantage to the plant in behaving as it does. The tendency of the root to grow downward will, on the whole, bring the roots of the plants into the soil, where the conditions for getting water are more favorable than they are on the surface of the soil. We can see that the responses of the shoot to gravity and light are, in the long run, likely to bring the plant into situations favorable to its further development. But it does not follow that everything that the plant does is of advantage.

We saw that light actually interferes with the growth of the plant, and yet, on the whole, the plant turns toward the light. Is not this response injurious and suicidal? But we shall find later (p. 73) that the light is of great importance in the life of the plant in ways connected not with growth but with *the making of food*.

Many of the responses of animals — even of higher animals, including ourselves — are just as mechanical as some of these simpler responses of plants. They are mechanical in the sense that they result from the structure of the organism, and do not involve anything in the nature of thinking or desiring or choosing. Like the responses of the plants, most of the animal responses that we are likely to notice are of a kind that help the organism in keeping alive — for example, by preventing injury or by helping in the obtaining of food. But among animals, as among plants, we can find responses that seem to be of no value whatever to the life of the organism, and some that are even injurious under certain circumstances.

CHAPTER X

ABSORPTION FROM THE ENVIRONMENT

61. All cells absorb. The surface of a young root is made up of cells packed so close together that even with the most powerful microscopes we are unable to see any breaks through which water can pass. Yet it cannot be doubted that water does pass through, and we may be sure that materials pass through the walls of the cells.

62. Diffusion. Illuminating gas and the vapors of odorous substances spread through the air very rapidly, by a process called *diffusion*. Diffusion takes place also in liquids. Diffusion represents a form of energy, since it is capable of overcoming gravity, as we can see in the fact that sugar or salt diffusing in water is actually lifted from the bottom of a vessel and distributed to all parts. This attraction between water and certain kinds of soluble substances helps us to understand what happens in roots as well as in other parts of living things.

The substance of which the root's cell walls are made up is called *cellulose*. This substance cannot dissolve in water, but it can absorb water in much the same way as glue or gelatin does. Now water can diffuse through cellulose, although the cellulose cannot dissolve or diffuse in water. Substances that can dissolve in water can thus diffuse through the cell wall.

63. Diffusion through a membrane. When different substances dissolved in water are separated by a layer of cellulose or gelatin, they may diffuse through the separating membrane. Such diffusion is called *osmosis*. This process takes place in the walls of cells, since the watery liquid on one side of such a membrane is not the same as that on the other side. Thus

there is always a double current: some materials are always passing out of a live cell and other substances are passing in. In this way protoplasm receives from the outside its supply of water, salts, and food. And it is by this process that materials in the cell pass out. Gases as well as liquids diffuse through the cell walls.

64. Osmosis in living things. The cell wall of a root cell is seen to separate the protoplasm from the surrounding soil water. Income through the root hair is therefore by diffusion through the cell wall, or by osmosis. But the protoplasm within the cell wall is not a uniform mass of substance. The surface layer of protoplasm, the "protoplasmic membrane," also offers obstacles to the free diffusion of liquids and gases in solution, so that osmosis takes place here also. Indeed, there are many substances that can pass through ordinary cell walls of plants, but that cannot pass through the protoplasmic membrane. Common sugar is an example of such a substance.

Some substances diffuse in water more easily than others. Some of the solids with which we are acquainted do not dissolve at all. Of the substances that dissolve in water and can diffuse, some will diffuse more quickly through cell walls than others — and some may not pass through at all. Of the substances that can diffuse through cellulose, some can diffuse through protoplasmic membranes more quickly than others — and some cannot diffuse through such membranes at all. As a result of these differences, cells exposed to the same material surroundings may not be equally affected.

Not only do living things absorb materials from the outside world by osmosis, but within the body of every plant and every animal consisting of many cells, materials may pass from cell to cell, or between cells and various body juices, by this process.

CHAPTER XI

ROOTS OF PLANTS

65. Structure of roots. We have already seen the general appearance of roots, in the seedlings of the plants we used for our earlier experiments, in the carrots, beets, and turnips

used at home, in the roots of trees that have been pulled up to clear the ground, etc.

The root hair is a single cell formed by the outward prolongation of one of the skin cells (Fig. 9). The root hairs are the actual absorbing organs. Each root hair lives but a short time, and then shrivels up. As the tip of the root grows on, new root hairs are formed. The older skin cells of the root die, and their contents dry out. Together with the shriveled root hairs, these skin cells form a protective covering through which water does not pass very readily. As

the plant becomes older and uses up more water, the absorbing area of the root is increased by the formation of many side roots and by the branching of the roots. But it is always in the region near the growing tip of the main root and of the many branch rootlets that absorption takes place.

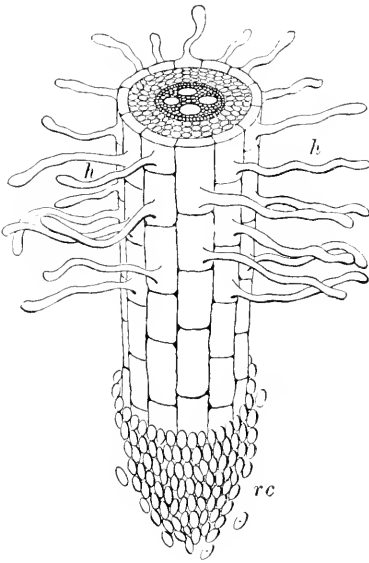
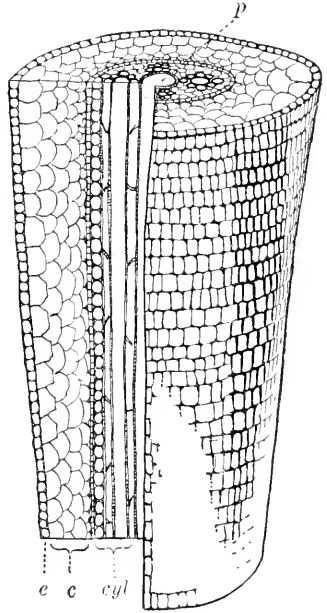

FIG. 9. The tip of a young root
rc, root cap; *h*, *h*, root hairs

66. The tissues of a root. If we examine the root of a plant freshly removed from the ground, we shall find that there is a soft, easily broken outer layer covering a tougher central portion. This central portion, running lengthwise in the root, is called the *central cylinder*, and corresponds in position to the wood of a stem. In a cross or longitudinal section of a fleshy root, like a carrot or parsnip, we may distinguish the central cylinder from the *cortex*. In very thin slices cut lengthwise through young root-lets we are able, with the help of a microscope, to see the character of the cells (Fig. 10). The cortical layer can be distinguished from the central cylinder by the fact that the cells of the former have about the same diameter in one direction as in another, whereas the cells of the central cylinder are considerably longer than they are wide, and their long diameter is parallel with the long diameter of the root.



67. Vessels and fibers. In the cortex, transportation of material probably takes place by diffusion from cell to cell. In the central cylinder, however, we can find that liquids are moved bodily through the long tubes or vessels that act as the main channels in the transportation of materials taken in by the root hairs. Other vessels in the central cylinder carry food materials from the leaves and stems down into the growing parts of the root. In addition to the cells which form ducts there are others with thickened walls. These fibers add to

FIG. 10. Diagram of root structure
e, epidermis, or skin layer; *c*, cortex;
cyl, central cylinder, consisting of conducting vessels and supporting fibers and the pith, *p*

the toughness and rigidity of the cylinder. Bundles of fibers with water-conducting vessels or of fibers with food-conducting vessels are called *fibro-vascular* bundles, the term *fibro* meaning "of fibers" and *vascular* meaning "of vessels," or tubes.

68. Growth of roots. The fiber and vessel cells are capable of growth, but they are not capable of cell division. In the young root there appear layers of cells which separate the water-carrying bundles from the food-carrying bundles. These *cambium* cells are capable of producing new fiber and duct cells of the two kinds — the water-carrying, or *wood*, and the food-carrying, or *bast*, systems (see pp. 174–177). Growth in length results from the formation of new cells by a special growing layer near the tip of the root.

69. Forms of roots. The structure of roots is fairly uniform for different kinds of plants. But roots nevertheless appear in very many different forms, from the thin, stringy roots of grains to the massive fleshy or woody roots of beets or trees. These differences are found to be closely related, in many cases, to the conditions under which the plants live. Thus, fleshy roots are often associated with the *biennial* habit. In such plants as beets, carrots, and parsnips the first season of the plant's growth is spent in manufacturing food and depositing it in the root. The next year comparatively little foliage is produced, but a stalk bearing flowers (which in turn develop into fruit, bearing seeds) uses up practically all the food that has been left over from the previous season. In contrast with this habit of life we find the plants that sprout, grow up into maturity, and die, all within one season. These *annual* plants have, as a rule, rather delicate, or fibrous, roots.

Trees and woody shrubs, which continue to live year after year, develop massive shoots. Corresponding to this fact we may note that such plants also develop elaborate, strong roots. From this we may see that the structure of the root and its functions are closely related to each other and to the character of the plant. There is a connection, on the one hand, between

the structure of the root and the size of the plant that it anchors, and, on the other hand, between the size of the root and its food-accumulating, or its absorbing, activity (Fig. 11).

70. Tap-roots. In many plants the main root continues to grow downward into the soil as long as the plant lives and as long as the tip of the root remains uninjured. Such a main descending root is called a *tap-root*. The fleshy roots that have

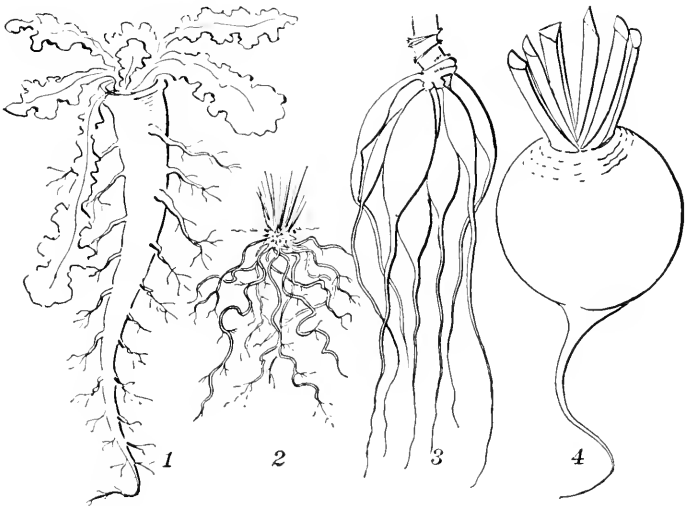

FIG. 11. Forms of roots

1, tap-root of dandelion; 2, fibrous root of buttercup; 3, bundle (or "fascicled") root of dahlia; 4, fleshy root of beet

been mentioned are all tap-roots; and a number of trees, as certain kinds of maples, also produce tap-roots. When a tap-root is injured or cut off, some of the side roots turn and grow downwards, although in a few cases the tip of the tap-root, when not too much injured, can regrow a new tip and continue the main line of growth.

71. Root pressure. We have found that when osmosis takes place in a root there is likely to be an excess of movement in one direction. We should expect more to come into the

root than goes out, since, on the one hand, we know that the growth of a living thing depends upon an excess of income over outgo; and, on the other hand, we know that the soil water is less concentrated than the juices of the root. The stream of incoming material actually sets up a current of liquid that is forced from the root into the upper parts of the plant.



FIG. 12. Sand dunes at Pine, Indiana

The roots and underground stems of the grass *Calamovilfa longifolia* bind together the grains of sand, gradually leading to the formation of larger and larger soil masses. Barren sand is blown about by the winds. (From photograph by Dr. George D. Fuller)

This can be seen in the flow of sap, as when the sugar maples are tapped for sirup in the spring, and it can also be shown experimentally.

72. Uses of roots. It is because of the habit of depositing food in their roots that many plants are of especial interest to us. Our common vegetable roots can be shown to contain a great deal of food, such as starch, sugar, and proteins. Although our fleshy vegetables contain from about 80 per cent to 90 per cent of water after the skin is removed, they are still worth

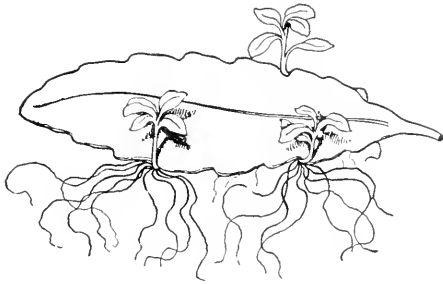

FIG. 13. Adventitious roots

A leaf of bryophyllum removed from the stem will put forth adventitious roots and shoots from the notches on the edge, thus giving rise to new plants

fodder for cattle. To some extent roots are also used as sources of drugs and flavoring materials. Among the latter the most important are the extracts of the licorice root, the sassafras root, and the sarsaparilla root.

Because of the close adhesion of the root hairs to the grains of sand in the soil, roots are very effective agents in binding the soil, enabling the latter to withstand the eroding effects of water as well as of wind. For this reason certain kinds of grasses are sometimes planted on sandy strips, to prevent the complete removal of the sand by the winds. The hillocks formed by clumps of such plants may continue to enlarge for

using for their other contents. In addition to the organic substances and the useful mineral salts that they contain, these vegetables have a relatively large bulk of cellulose, which is helpful in stimulating the activities of the intestines (see p. 117).

Fleshy roots are used in large quantities as



FIG. 14. Prop roots

Near the base of the trunk the screw pine (*Pandanus*) sends out prop roots in a manner similar to that of the Indian corn. (From photograph loaned by New York Botanical Garden)

years, and to give protection to other kinds of plants until the earth has become compact (Fig. 12).

Although roots do not generally put forth buds or shoots, the roots of some shrubs and trees—as certain willows, poplars, and hawthorns—do so, and can be used for propagating the species. In some plants the roots will form new shoots if the old shoot is completely removed or destroyed.

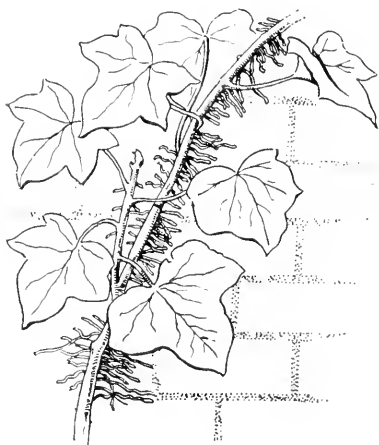

FIG. 15. Climbing roots

The English ivy, like many other climbing plants, clings to its support by means of adventitious roots that grow out all along the stem

roots will be seen growing from various points along the edge in the course of a few days. In these species buds will also be produced, so that after a while we can separate small but complete plants from the leaf, and get these to grow into full-sized individuals (Fig. 13).

Blackberry and raspberry bushes are frequently propagated by layering, which consists in bending the flexible stems out and burying the tips in the ground. Adventitious roots are formed on the covered portions, and, later, buds form new shoots. The old connecting stem is then cut away. A similar

On the other hand, roots frequently arise from stems or leaves, thus making possible the propagation of plants by means of cuttings. Roots that originate in this manner are called *adventitious* roots. Most of our common house plants, and willows and other trees, can be propagated by keeping twigs in water or wet sand until roots appear, and then transplanting them into soil. If the leaf (or even a piece of leaf) of a begonia or of a bryophyllum be placed on damp earth or sand, tiny

process takes place naturally in the strawberry plant, whose creeping stems produce new roots and new tufts of leaves, so that in the course of a season a single plant may spread out and cover a large area.

73. Adventitious roots. At the lower joints of the stalk of Indian corn adventitious roots are formed very early in the life of the plant

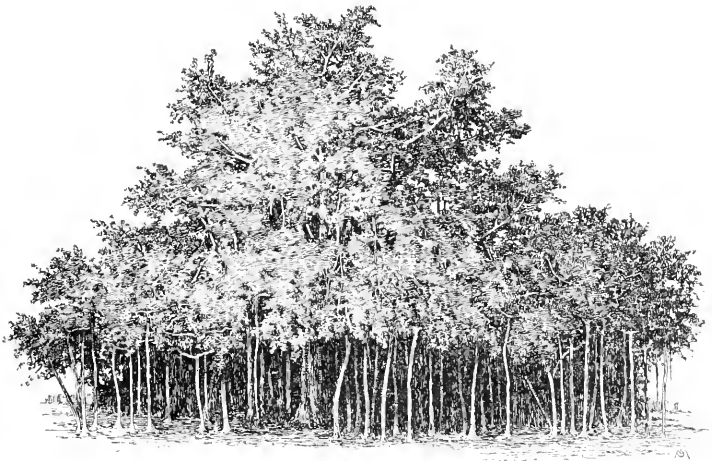

FIG. 16. The banyan tree (*Ficus bengalensis*)

The adventitious roots from the horizontal branches finally attach themselves to the soil. By means of these roots the tree is able to spread over a large area, a single tree sometimes extending over several acres of ground

(Fig. 14). Adventitious roots usually grow from the stem (though sometimes from leaves), and are most frequently in the nature of supporting or anchoring organs. The climbing organs of the English ivy as well as of the poison ivy are adventitious roots (Fig. 15), and in some of the tropical tree-climbing plants the roots are very fully developed as holdfast organs. The banyan tree of Asia puts forth adventitious roots from the horizontal branches (Fig. 16).

CHAPTER XII

WHAT FOOD IS

74. The material needs of protoplasm. Several classes of materials seem to be necessary to keep protoplasm working. Water, for example, which we have seen to be necessary for the sprouting of seeds as well as for the absorption of mineral matters by the roots of a plant, is a constant and necessary factor in the activity of live protoplasm. It is thus a necessary part of the income of every plant and every animal. Within the cells, too, water makes possible the movements of the various substances, and their chemical action and reaction with one another. In the larger plants and animals the transfer of materials between various parts of the organism takes place through liquid media, — as blood, sap, bile, milk, — and these consist very largely of water.

Certain minerals seem to be necessary parts of the income of living things. Some of these salts, through their chemical actions, appear to start other chemical processes, and are therefore called *activators*. Other salts, or elements, appear to modify certain chemical processes (just as the bromide used by the photographer makes the development proceed more slowly), and are called *regulators*.

We have already seen that living things generally use oxygen in the course of their activities.

75. What food is. In addition to the water, oxygen, and various mineral salts, every living thing uses various substances as material out of which protoplasm is constructed by the process of *assimilation*, and it uses substances that can be oxidized within the cells and thus yield energy.

Whether everything that an organism takes in from the outside is to be called *food* or not is altogether a matter of

convenience. It is found less confusing to restrict the use of the word *food* to such substances as can serve as building material for protoplasm or as sources of energy through oxidation.

76. Food organic. Using the word *food* in this sense, then, we must notice first of all that food materials are found in nature only in the bodies of living things ; that is to say, they are *organic*, to use the older term. From a chemical point of view we may divide the foods into two main classes : those that contain nitrogen and those that do not. The foods of the first class are called *proteins* and are represented in our familiar supplies by such substances as *albumen*, or white of egg ; the curd or *casein* that is formed when milk sours ; and the *gluten*, or pasty substance, in wheat flour or bread. Similar nitrogen-containing substances are found in the cells of muscles and are called *myosin* ; others, found in the seeds of the plants belonging to the bean family, the Leguminosae, are called *legumin*.

Of the non-nitrogenous foods there are two main divisions, the *fats* and the *carbohydrates*. The fats are familiar to us in such substances as butter, suet, lard, tallow, olive oil, cotton-seed oil, peanut oil, and others. The carbohydrates comprise all the sugars and all the starches.

77. Food functions. In dividing the foods into the two classes, nitrogenous and non-nitrogenous, we have at the same time separated them in accordance with their true relations to protoplasm. For the proteins are the foods that are necessary for the building of protoplasm ; the protoplasm may be said to consist fundamentally of protein. The fats and carbohydrates are important in living cells as fuel, or oxidizable material.

We find accordingly that all seeds contain protein, some in larger proportions (beans, peas, lentils, for example) and some in smaller proportions. In addition to this, all seeds contain either fat (as the castor bean, peanut, cotton seed, flax seed) or some carbohydrate (as the bean, cereals, date).

78. Summary. We may summarize the materials required by a living cell in this way:

1. *Water.* The chemical changes that distinguish living protoplasm can take place only in the presence of water.
2. *Protein.* Out of this, new protoplasm is constructed, resulting either in the growth of the cell or in the replacement of protoplasm that may have been destroyed.
3. *Fuel foods.* In addition to the protein oxidized in the cell there is usually some other material that is oxidized. Two classes of compounds commonly furnish this fuel: namely, (a) *carbohydrates*; (b) *fats*.
4. *Salts.* Various mineral, or inorganic, compounds are necessary for maintaining the activities of protoplasm. These are of many kinds, although certain of the elements contained in these salts are used by all living protoplasm (see p. 31).
5. *Hormones.* In the bodies of human beings and of other animals (and possibly also of certain plants) peculiar substances are produced that have a direct influence upon the activities of cells. These substances, which are called *hormones*, are just coming to be understood through experiments. It is sufficient for the present to note that they do affect protoplasm activity, and that some of them are necessary for the life of certain kinds of cells in the body.
6. *Oxygen.* Although this is not usually regarded as part of the food, it is an essential part of the income of every cell. It is the chemical union of oxygen with other substances that sets free the energy by which the protoplasm does all of its work.

CHAPTER XIII

THE ORIGIN OF FOOD

79. Organic foods destroyed. When proteins, fats, and carbohydrates become assimilated, they are still available as food for other living beings. But when any of this material becomes oxidized, it is thrown out of the world of living things. The question may then be raised, If living matter can continue to live only at the expense of other living matter, and if living matter is constantly being destroyed (oxidized), how can the total amount of protoplasm be maintained, to say nothing of the amount of live matter being increased?

80. The making of organic food. It is obvious that somewhere in the circle of feeding, new foods must be admitted into the world of living things from the world of non-living things. The answer to the question was found in the discovery that the green parts of plants are active in the manufacture of new organic foods.

81. A manufacturing process. The process by which organic materials are built up (chemically) out of inorganic materials may be compared to a manufacturing process. In every such process certain factors are essential. There must be (1) raw material, (2) tools or machines for working on the material, and (3) energy for driving the tools or machines.

In addition to these factors, we can understand that there is (4) a main product and sometimes material left over, called "waste," or, better, (5) the *by-product*.

82. Factors in starch-making. What are the factors in the process of starch-making?

The raw materials used by the plant are found to be *water* and *carbon dioxid*.

The machines or instruments directly involved are different from the machines with which we are familiar. Instead of having wheels or levers or other moving parts, these machines are *chemical* engines, each consisting of a lump of protein with some of the *chlorophyl* that gives the familiar plants their distinctive color. This chlorophyl is the tool, or transformer of energy, in the food-making process (see Fig. 17, and Fig. 23, p. 70). The chlorophyl-bearing particle is called a *chloroplast*.

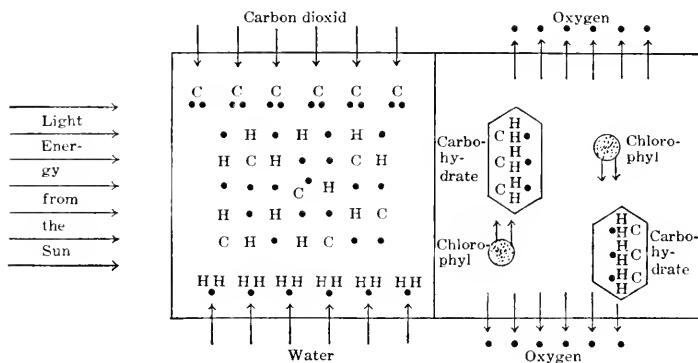

FIG. 17. Starch-making by chlorophyl

We may think of photosynthesis as taking place in two stages: in the first the raw materials, water and carbon dioxide, are broken up into their constituents—carbon, hydrogen, and oxygen; in the second these elements are recombined into carbohydrates, and the surplus oxygen is set free. The energy for this chemical process is sunlight; the transformations are brought about through the action of chlorophyll

The energy for doing this work is the light from the sun. Although the work cannot go on at too low a temperature, it is the *light* that is used in the process, and not the *heat*.

83. Oxygen a by-product. The starch that is formed from water and carbon dioxide by the action of sunlight through chlorophyll contains the elements found in the raw materials—namely, carbon, hydrogen, and oxygen. In starch, as in most carbohydrates, hydrogen and oxygen occur in the same proportions as they do in water. The raw materials taken in by the plant therefore contain an excess of oxygen. This

element is given off in a free, or uncombined, state during the process of starch-making.

84. Sunlight and life. The process which we have called starch-making is really a group of processes. In some green plants starch is never found, and yet the transformation of carbon-hydrogen-oxygen materials by the sunlight, acting through chlorophyl, goes on in these plants. The common fact in all these processes is that some kind of carbohydrate (usually some kind of sugar) is produced. This process of carbohydrate formation is called *photosynthesis*, from Greek words meaning "light" (compare *photo-graph*) and "put together." In addition to forming sugar, some plants have a way of condensing the sugar, shortly after it is formed, into starch grains (Fig. 17).

Without going deeply into the chemistry of photosynthesis we may note that in the making of carbohydrate the energy of the sunlight has practically broken up a combination (CO_2) that is ordinarily formed with the liberation of energy. That is to say, through the action of light, carbon and oxygen have become separated so that they are capable of again combining and liberating energy. Carbohydrate may thus serve as a source of energy by becoming oxidized, either in the bodies of living things or in a flame. We may thus see that all the energy that plants or animals use as a result of the oxidation of carbohydrates is derived from the sun's energy. There is more than poetry in the statement that every human act is a transformed sunbeam.

85. Origin of fats. All organic materials appear to be derived directly or indirectly from carbohydrates. It has been found that fats originate in the cells of animals as well as of plants, by a modification of starches or sugars. Fats are characterized by containing a large proportion of carbon and a small proportion of oxygen. The chemical process by which carbohydrates are changed into fats is not understood.

86. Origin of proteins. The foods of the third group, the proteins, consist of very complex substances. They all contain nitrogen, in addition to carbon, hydrogen, and oxygen. Some

also contain sulfur, and some phosphorus. From careful studies of plants it is supposed that proteins are manufactured by certain cells when these are supplied with carbohydrates and salts containing the necessary elements. For example, nitrates contain nitrogen, which the plant can use, phosphates contain phosphorus, sulfates contain sulfur, and so on. A green plant is therefore capable of manufacturing its own food if it receives, in addition to the water and carbon dioxide, a suitable supply of minerals from the soil. Many plants without chlorophyll, as certain kinds of molds, have also been shown to be capable of manufacturing proteins when supplied with carbohydrates and suitable minerals.

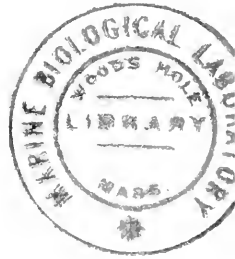

CHAPTER XIV

THE CHEMICAL CYCLE OF LIFE

87. The carbon cycle. An understanding of the behavior of green plants in relation to food-making shows us how closely the living things in the world depend upon each other. Let us take the case of carbon, which is an essential constituent of all living matter. The carbon in our bodies came from the proteins, fats, and carbohydrates which we ate. We obtained these either from the bodies of plants or from the bodies of animals. In the latter case they were still derived from plants, for the cows or pigs or chickens that we used as food got the carbon in their bodies from the plant food which they in turn ate.

Now the plant gets its carbon from the carbon dioxide in the air. (Water plants can get carbon from the carbon dioxide dissolved in the water.) But what is the source of the carbon dioxide? We saw (p. 12) that the proportion in the air is very small. A few warm, sunny days in August would enable the plants of this country to use it all up, and that would be the end of everything. But the winds are all the time stirring up the atmosphere, so that new supplies of this important material are brought to the plants; and there are certain rocks — limestone and marble especially — that are capable of yielding a small quantity of this gas when they decompose. But this amount is very small indeed when we consider what is being used up by the plants from hour to hour. There is, however, still another source.

We have seen (p. 29) that all living things, while using up oxygen from the air, are at the same time throwing off carbon dioxide. Moreover, every fire throws off quantities of carbon

dioxid. This carbon dioxid then becomes available as a source of raw material for food in the leaves of plants. Now we must

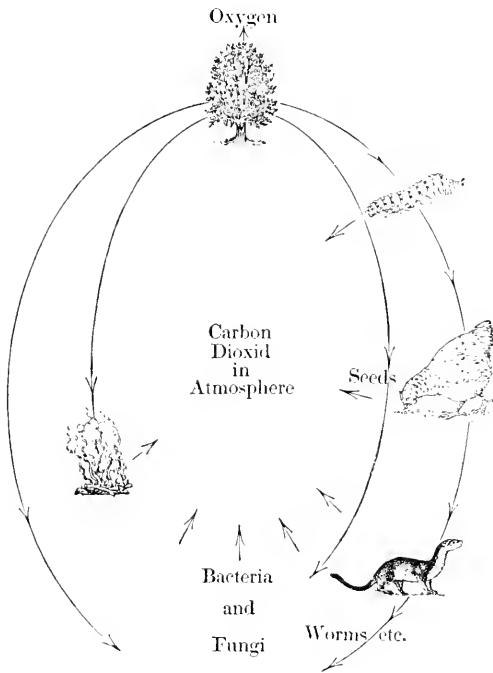

FIG. 18. The carbon cycle

Fires and all kinds of living things are constantly throwing carbon dioxid into the air. Green plants, represented by the tree in the diagram, withdraw carbon dioxid from the atmosphere and return oxygen. The material of the green plant is made up in part of the carbon derived from the carbon dioxid. This material serves as food for animals and as fuel for fires. The animals oxidize this material; or they are eaten by other animals. Finally, the carbon of larger plants and animals is oxidized by simple organisms, such as bacteria and fungi, and is returned to the atmosphere

remember that the carbon dioxid from fires and from animals is limited in amount by the work of plants, for the only burnable material that is available is the organic material manufactured in the first instance by the green plants.

Whichever way we go at it, we see that our lives are dependent upon the activities of the green plants; and on the other hand, the continued existence of *new* green plants is made possible by the oxidation of their organic substances in the bodies of animals or in fires. There is, then, a certain balance, or limited relation, between

the total quantity of plant life in the world and the total quantity of animal life. If the amount of animal life should diminish very greatly, there would come a time when the growth of

plants would be affected by the lack of carbon dioxide. Should the amount of plant life decrease greatly, a limit to the growth of animals would soon be reached for lack of food (Fig. 18).

88. The oxygen cycle. In the matter of oxygen we can see a similar relation between plants and animals. The amount of oxygen in the atmosphere is very much greater than the amount of carbon dioxide, but it is a limited amount, and all living things are constantly drawing upon it to enable them to set free the energy that they use up in the course of their activities.

After oxygen has once been used in the oxidation of organic material, it is no longer available for similar use. If all green plants should suddenly stop their activities, the amount of carbon dioxide in the atmosphere would steadily increase, but the amount of

oxygen would just as rapidly diminish. A point would soon be reached at which the maintenance of animal life would be no longer possible. Through photosynthesis oxygen is liberated, thus becoming again available for the breathing of animals and plants (Fig. 19).

89. The nitrogen cycle. In the matter of nitrogen our dependence upon living things of various orders is still more marked. The plants growing in a given area take from it

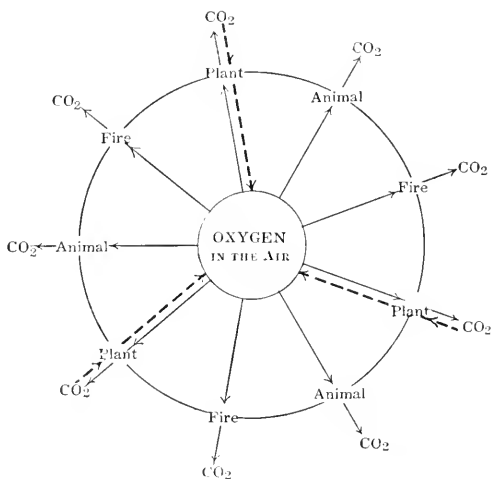

FIG. 19. The oxygen cycle

Oxygen from the atmosphere is taken up by plants, by animals, and by fires. All of these return carbon dioxide to the atmosphere. The green plants take carbon dioxide from the atmosphere and return oxygen

water and minerals. The water is replaced by the rains, but the minerals are limited in amount. Although the movements of water in the soil may distribute salts and make new quantities available, the exhaustion of certain minerals from soils under cultivation is an established fact. To take the nitrates alone, we find that the plants can manufacture proteins only if they have a supply of nitrogen in a combined form; that is to say, they cannot utilize free nitrogen, such as is found in the atmosphere, but must have nitrogen compounds.

In the course of the vital processes in the bodies of plants and animals, proteins are broken down into simpler compounds of nitrogen. Some of these can be used again by plants in the making of proteins, but others disappear in the air, and so the nitrogen is lost from the cycle of life. As a matter of national economy, people are finding it worth while to save the manure of the barnyard and even the sewage of cities for the combined nitrogen that these substances contain. But in spite of all our saving, vast quantities of nitrogen are washed out to sea or thrown into the air beyond the reach of our common plants.

Resort has been made to deposits of nitrates found in the soil, but the quantity of these nitrates is limited and they are relatively expensive. On certain islands off the coast of South America there are extensive deposits of guano, or bird refuse, left there by countless birds that have built their nests upon these islands for hundreds of years. This guano contains nitrogen and other elements usable for food-making by plants, and has been imported and sold as a fertilizer. But the amount of guano is limited and constantly diminishing. Indeed, of all the elements, nitrogen seems to be the one that does not come back into the life cycle by an automatic process. From the point of view of a nation that can look ahead more years than the length of an individual's life, this is a serious problem. The nitrogen supply will probably last as long as you and I are likely to live. But society expects to outlive us, and it is the business of the statesman to look ahead for those not yet born (Fig. 20).

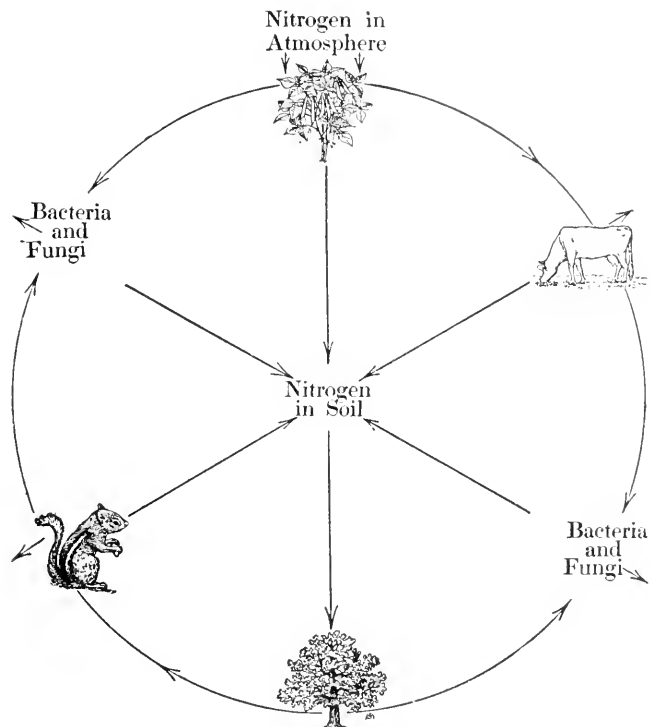

FIG. 20. The nitrogen cycle

Nitrogen compounds are withdrawn from the soil by plants, represented by the tree in the diagram. The nitrogen material feeds animals (as the squirrel) and also other plants (as bacteria and fungi). Some of the waste products of life activity are returned to the soil; other nitrogen compounds are scattered and lost in the air. The only way by which nitrogen from the atmosphere is regularly returned to the soil is through the action of bacteria found on the roots of plants of the bean family, represented by a bean plant in the diagram. Bacteria of decay bring about a return of the nitrogen in the bodies of dead plants and animals

90. The nitrogen problem. In comparatively recent years two solutions of the "nitrogen problem" have been presented. One of them rests upon a better understanding of living things; the other is an application of chemical knowledge. It has been found that there are present in many soils tiny one-celled plants called *bacteria*. They are related to the germs that are known

to cause certain diseases. Some of these germs, when supplied with carbohydrates, are capable of fixing the nitrogen of the atmosphere by combining it into proteins and other nitrogen compounds.

91. Nitrogen-fixing bacteria. On the roots of bean plants, peas, clover, alfalfa, and other plants of this family there are tiny swellings, or *tubercles*. Some of the nitrogen-fixing bacteria

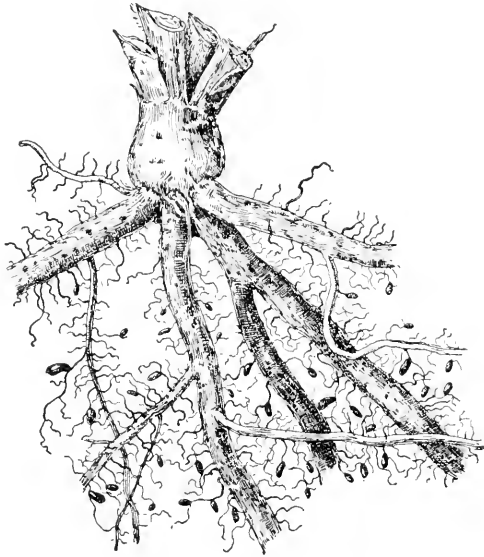

FIG. 21. Tubercles on the roots of red clover

are found in all of these tubercles. The bacteria can make much more protein than they can use, just as most green plants can manufacture much more sugars or starches than they can use. The plants of the *legume* family contain, as a result, a much larger proportion of nitrogenous compounds than any other plants (Fig. 21).

92. Rotation of crops. If we grow several crops of grain on a farm, and find that the size of the crop tends to diminish through lack of nitrogen, we do not have to abandon the farm, nor do we have to import expensive nitrogen fertilizer. We have only to plant a crop of peas or clover, and to see to it that there is a plentiful supply of the special kinds of bacteria that form the *tubercles* on the roots of our plants. It is now possible to buy *cultures* of the species of bacteria that are known to thrive best on any particular legume plant.

In the course of the summer the bacteria in the tubercles will take in a large quantity of nitrogen from the air. Part of this they will use in making proteins for immediate consumption; another part will be taken from them by the roots of the plant upon which they grow; and at the end of the season there will be present in the soil and *on* the soil a great deal more nitrogen in combined form than there was at the beginning. The crop can be plowed under, and the nitrogen compounds in the plants will thus be added to the soil. After another season of this kind of crop there will be enough nitrogen added to the soil to support several crops of grain.

This rotation of crops has been practiced by experienced farmers for many

centuries, but it is only within the last thirty or forty years that the significance of rotation has been understood.

For the chemical solution of the nitrogen problem we are indebted to the Swedish chemist Svante Arrhenius, who worked out a process for making nitrogen combine with other elements under the influence of electric currents. This method is economical only if electricity can be obtained at a low cost, as from waterfalls. To burn fuel for this purpose would cost more than the value of the nitrogen compounds produced.

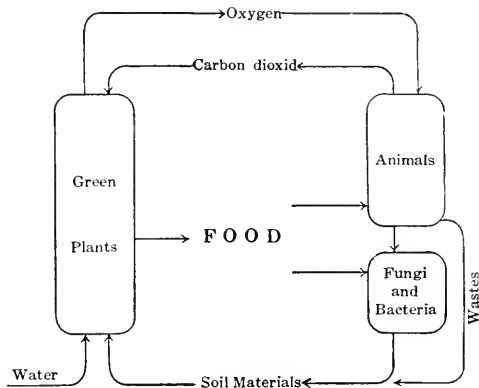

FIG. 22. The interrelations of organisms

The green plants, using water and carbon dioxide and salts from the soil, are the source of all food and the source of much oxygen derived from the decomposition of carbon dioxide (during photosynthesis). The food is used by animals and by lower plants (fungi and bacteria), and in the end the substance of the animals is also used by the fungi and bacteria. The carbon dioxide given off by the animals and by the fungi and bacteria sooner or later finds its way back to the green plants through the air or water. The wastes given off by these organisms also become in time raw material for the food of green plants, through the soil

The interdependence of living things in the matter of food manufacture has been shown from the point of view of the oxygen cycle, of the carbon cycle, and of the nitrogen cycle. This idea may be more clearly perceived from the diagram on page 63 (Fig. 22).

With the outbreak of the Great War the nitrogen problem took on a new aspect, for nitrogen compounds are as necessary for the manufacture of explosives as they are for the manufacture of protoplasm, that is, the raising of crops. The leading nations have established chemical factories for the production of nitrogen compounds out of atmospheric nitrogen by means of electricity obtained from waterfalls. The ability of a nation to obtain its needed food from the soil may thus come to depend upon a continuous supply of cheap energy, such as is furnished by waterfalls. It has been found that under certain conditions some green plants are able to make use of atmospheric nitrogen, but it is not likely that we shall be able to get our farm crops to grow without suitable nitrogen fertilizers.



CHAPTER XV

THE SOIL AS THE SOURCE OF OUR MATERIALS

93. The soil. Just as the sun-light and sun-heat are the sources of our energy, so the materials in the soil, water, and air are the sources of our physical constitutions. We have seen that water is necessary for all life processes, and that the carbon dioxide in the air supplies material for the making of carbohydrates. All the other materials found in the bodies of plants and animals are derived from the soil.¹ Those who live in the country usually appreciate our dependence upon the soil for our life, but most young people in the cities come to think of the land as merely the place or surface upon which we live. The crowding of a population may mean not simply that people live too close together for comfort or for health; it may mean also a shortage of food supply due to insufficient soil for growing crops.

As the population of a nation grows, the second kind of crowding is likely to become serious. There was a time when thoughtful people looked forward to such overcrowding with a feeling that it must result in great destruction of human life or in great suffering through general poverty. Indeed, in past times much of the poverty and famine was due to the inability to secure from the soil adequate supplies of food. At the present time, however, we are rapidly learning to increase the yield of our cultivated land out of proportion to the increase in population.

¹ This is apparently not true of the plants that float in ponds or rivers or oceans, and of the animals that feed upon such plants. But in reality the salts dissolved in the waters have been washed out of the rocks and soils along which the brooks and rivers flowed on their way to the sea.

94. Exhaustion of soil. One of the dangers of the past was the fact that after many crops of plants had been taken from a soil, there was a lack of the mineral salts required for plant growth. In addition to nitrogen, plants need phosphorus, potash, calcium, and iron. There is no danger of ever exhausting the iron in a soil, for this element is used in such small quantities that plants will have stopped growing for lack of some of the other elements (for example, phosphorus or nitrogen) long before the iron supply is considerably reduced. In many kinds of soil the same thing is true of calcium. But the other elements are used in such large quantities (in proportion to the amounts present in most soils) that they practically limit the use of soil for crop raising. It is chiefly for this reason that so many farms in the eastern parts of this country have been abandoned; the farmers found that they could not raise crops on the old soil.

95. Fertilizers. To make up for the withdrawal of materials by crops, it has for ages been customary to put various substances on or into the soil. These substances are called *fertilizers* and include limestone or gypsum, barnyard manure and guano, crushed bones and ground phosphate rock, and many other substances. In this country the farmers spend about \$125,000,000 annually for commercial fertilizers, besides what they use from their own dungheaps.

The first thought in the use of fertilizers is to replace in the soil materials that are lacking for plant growth. Some fertilizers, however, are sometimes added not so much to supply material that the plants may use as to produce chemical changes in the soil, to make the latter more suitable for the growth of plants. For example, gypsum is sometimes used to supply calcium, but it may also be used in some cases to make the phosphorus in the soil more easily available for the plants.

96. Biology of soil. The soil is more than a mixture of substances having physical and chemical properties. It contains many different kinds of very small plants and animals

(most of them too small to be seen without a microscope) whose activities have an important bearing upon the life of the green plants that interest us. We have seen that some of these *microbes* are useful, as in the case of the bacteria living in the tubercles of clover and alfalfa etc. (see p. 62). Others, however, are injurious. Some of the latter may be destroyed by the addition of sulfur to the soil, with the result that the size of the crop is increased. Strictly speaking, the sulfur is not a fertilizer, although it helps to increase the yield.

Another effect of fertilizers has been shown in relation to the fact that growing plants, like other living things, throw off waste matters. Some of the waste matters thus thrown into the soil are poisonous. Certain materials added to soil containing these poisons have been found helpful, not because they add anything usable, but because they counteract the poisonous substances. In a similar way certain materials may help by counteracting the poisons or acids produced by the usual inhabitants of the soil that we do not often see.

97. Intensive cultivation. But even if, by using fertilizers and other substances, we are able to keep the soil under cultivation indefinitely, the pressure of the population must appear as soon as all the suitable farm land is settled. Modern science has anticipated this emergency by teaching us how to get more food out of every acre of land, through what is called *intensive farming*. This includes a thorough use of the soil throughout the year. By forcing plants to grow more rapidly than they would ordinarily, — by selecting rapidly maturing varieties, by covering against cold weather, by artificial watering, by more thorough tilling, and so on, — the cultivator is enabled to produce from two to seven crops a year on a given piece of land. This makes possible the support of a larger population on the same territory.

98. More soil. In addition to making the soil under cultivation yield more, a civilized people is able to extend its resources in other ways. In this country, for example, nearly

half the land area, outside of mountain and rock, which cannot be cultivated, consists either of swamp land or of desert land. Soil that is too wet is just as useless for farming as soil that is too dry. But through the coöperation of farmers and engineers and workers of all kinds it has been possible to reclaim millions of acres of swamp land and millions of acres of desert land, and to make it all usable for raising valuable crops. By draining the swamps and by bringing water to the arid regions, through miles of canals and ditches and pipes, soil containing vast amounts of food-making salts has been added to the national wealth. There is, of course, a limit to what man may be able to accomplish in the way of reclaiming land, — for example, in some of the Western dry regions the bringing of water may not be practicable if the distance is too great. But when we consider that at the present time more than half of the great staple food crops of the world are raised on land that is artificially irrigated, — in China, India, Egypt, Canada, and other countries, — we can see that the possibilities in this direction will probably not be exhausted in many generations.

99. Soil waste. The fertility of the Nile valley seems to be inexhaustible. This is not due to the higher concentration of usable salts in this soil than is found elsewhere ; indeed, if the mineral matter were too highly concentrated, the plants could not grow, as we can see when we try to water garden plants with sea water. The richness of this soil is due to the fact that the river is constantly bringing down into the valley more and more material from the rocks in the mountains where the river has its sources. In our own country every river that empties into the sea carries away tons of usable minerals which thus go to waste. In connection with some of the irrigation projects in the Southwest, much water is lost during the spring, and with the water a great quantity of valuable mineral salts. Plans are being developed for saving this water in huge reservoirs, some of which are already completed. In this way it will be possible not only to irrigate larger areas but also to

save from waste the soil materials out of which our food supply can eventually be greatly increased.

So far as the soil is concerned, we need not fear that the earth will become uninhabitable for many centuries. The pressure of the population, even if it becomes several times as great as it has been in China or India, can be met by the application of science and coöperative effort to the resources now in sight. If there is to be starvation, it will *not* be because the earth and the sun and the green plants fail us.

CHAPTER XVI

THE LEAF AS STARCH FACTORY

100. Leaf characters. The most common fact about a leaf is that it is flat and comparatively thin. Many kinds of leaves

have stalks, or *petioles*, and all leaves have *veins* running through the flat portion, or blade. There is no shape that is common to all leaves. They differ as to the character of the edge. Some are smooth, whereas others have wrinkled, uneven surfaces. Some kinds are hairy, while others are quite bald. Even the color of leaves is not uniform, though there is more or less of the green chlorophyll present in the leaves of all plants.

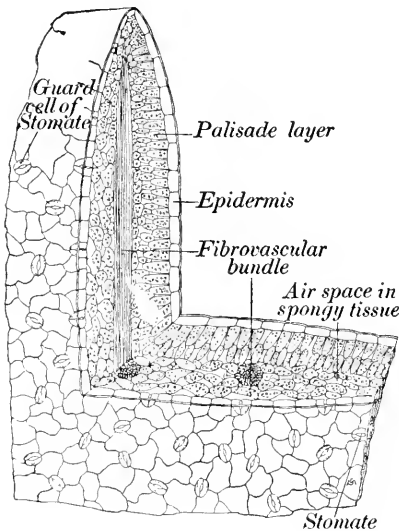

FIG. 23. Structure of leaf

This diagram shows the tip of a leaf with a piece removed by two cuts at right angles to each other, as it might appear under the microscope. Note the different kinds of cells and tissues

101. Unusual forms of leaves. Most familiar leaves are flat, spread-out structures. Some plants, however, have leaves that depart considerably

from this model. There are leaves that are nothing more than fine hairs, as on certain cactuses, others have extensions that behave like tendrils, and some are spines. Certain plants have leaves that are more or less active in getting animal food.

102. Work of the leaf. The work of food-making in the leaf has already been described (see p. 53), and we may now show the relation between the structure of the leaf and the details of this work. The cells containing the chlorophyll must get their income from the surrounding cells or from the surrounding air spaces. The water is brought up through the vessels of the wood (Fig. 23), and it passes through the cell walls by osmosis. The carbon dioxide is absorbed by osmosis from the air inside the leaf, and this air is in direct communication with the outer air by way of the stomates. The oxygen given off by the cells passes into the air spaces and diffuses from these to the exterior by way of the stomates.

The skin cells are not directly concerned in the work of starch-making; their function may be described as protective. In addition to protecting the delicate pulp cells against mechanical injury, they are even more useful in protecting the plant against the loss of

water. That a great deal of water is lost by the plant through evaporation may be inferred from what we know about the evaporation of water from other wet surfaces (Fig. 24).

103. Transpiration. The loss of water is perhaps the most serious danger to which most plants are exposed, since more plants die from the results of wilting than from any other one

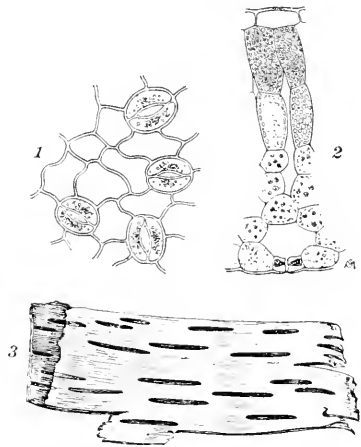

FIG. 24. Breathing holes of plants

1, stomates, or breathing pores, on the surface of a leaf, inclosed by the "guard cells." 2, section through a leaf, showing an air space just inside the guard cells. Stomates are found in the epidermis of twigs as well as on leaves. As the stem grows tougher the breathing holes become larger and more irregular patches connecting the spaces between the cells and the outside atmosphere. The roughened breathing spaces on the bark are *lenticels*. 3, lenticels on the bark of birch. (Microscopic views about $\times 200$)

cause. And yet *transpiration*, as this evaporation from the leaves is called, may be of use to the plants indirectly.

This rapid evaporation of water results in lowering the temperature of the plant. The sunlight is rapidly absorbed by the chlorophyl bodies, but only a small portion of this energy is transformed in the making of carbohydrates. Much of the energy is passed through the leaf, but a great deal of it becomes converted into *heat*. Under conditions that interfere with transpiration, the temperature of leaves exposed to sunshine increases so rapidly that the protoplasm is sometimes killed—the leaves are actually scorched, although the temperature of the surrounding air may not be very high. This may be observed in the summer time, when the sun comes out quickly after a shower that has left a great deal of moisture in the air. The moisture in the air prevents transpiration; the sunshine is largely converted into heat inside the leaves, and the protoplasm is injured as a consequence.

104. The guard cells. While there can be no doubt that the guard cells are extremely sensitive to changes in surrounding conditions, it is by no means certain just *how* their movements are related to the work of the leaf, or whether, indeed, these movements have any practical significance in the life of the plant. The movements of the guard cells were formerly supposed to be related to the work of transpiration.

CHAPTER XVII

OUR DEPENDENCE UPON LEAVES AND CHLOROPHYL

105. Light and leaves. We have learned that in the absence of light the chlorophyll is inactive and the process of starch-making is suspended. Moreover, if a plant is kept in darkness for a longer period, the chlorophyll begins to disappear, and in the end the leaf will be quite white. This fact is used in the blanching of celery. The earth is dug up about the bases of the plants to exclude the light. When we compare the outer leaves of a head of lettuce or cabbage with the inner leaves, we see a difference as to the amount of green pigment which illustrates the same principle.

Experiments on light in relation to photosynthesis show that it is quite possible for plants to carry on this work under artificial light. The light that we usually have in a living room in the evening is hardly strong enough to affect most house plants, but by the use of strong electric lights it has been found possible to hasten the growth and development of lettuce so as to get it on the market at least two weeks earlier than could otherwise have been done. This means that the plants were given daylight while there was any, and were then supplied with artificial light during the night. In this way plants can be kept working continuously, as they apparently have no need for rest or sleep.

Experiments have been made to find out whether the different kinds of light that together make up white light have any special relation to photosynthesis. It seems that the light toward the red end of the spectrum is more effective in starch-making than that toward the violet end. But species of plants differ from one another in this respect.

106. Breathing and leaves. It is sometimes said that "plants breathe in what animals breathe out, while animals breathe in what plants breathe out." This statement is heard so often that many people accept it as true without taking the trouble to consider just what it means. The statement is true only if we are careless enough to jumble up the meaning of the word *breathe*. The fact is that plants and animals both *breathe in* oxygen and *breathe out* carbon dioxide. This oxygen is used in the same way in both plants and animals, and the carbon dioxide originates in the same way. In addition to the breathing, green plants carry on another process in which gases are involved. In the process of starch-making, plants use up carbon dioxide, which they *take in* from outside, and they *give off* oxygen, which is separated out in the course of the starch-making. Now breathing has to do with the gas exchange concerned in oxidation and the release of energy. The gas exchange concerned in photosynthesis is not breathing. The statement that the breathing of plants differs from the breathing of animals is therefore misleading and not true.

107. Uses of leaves. Aside from the fact that it is in the leaves of plants that our food supplies are originally worked up, the leaves of many plants are of use to us directly. Some are eaten, as, for example, cabbage, lettuce, spinach, watercress, dandelion. The leafstalks of some plants, as the rhubarb and celery, are also used as food, although they do not contain very much protein, fat, or carbohydrates.

The tea and tobacco industries are founded upon peculiar substances found in certain leaves. It is not the food value, but the presence of an *alkaloid*,¹ that makes the leaves of these plants interesting to human beings.

The fact that in the course of its activities a plant throws into the air large quantities of oxygen makes the plants valuable neighbors, especially in the cities, where oxygen is used

¹ An alkaloid (that is, "like an alkali") is an organic compound containing nitrogen, capable of combining with acids.

up relatively faster, on account of the crowding of population and on account of the many fires kept going.

The food of our domestic animals is in large part the leaves of plants, — grass, beet tops, and the greater part of hay, alfalfa, clover, and corn fodder; these furnish the principal green food of cattle and horses.

The dead leaves of plants, whether those that have dropped in the autumn or those that reach the ground through the death of herbs etc., form the basis of the *humus* of the soil. Humus is a mass of decaying vegetable matter, with some animal matter and soil. This forms a soil covering that is very helpful from the point of view of retaining moisture in the soil, and to a certain extent in returning nitrogen and other elements to the soil.

108. Our dependence upon chlorophyl. The parts of a plant that have no chlorophyl (for example, the root or stem of a tree) are unable to make food substances out of inorganic materials; they are nourished by materials obtained from the leaves. But animals and such plants as mushrooms, having no chlorophyl, must get their food from the bodies of other living things, and in the end all food comes from green plants.

The value of the food materials taken from our farms in the form of various crops amounts to over \$3,000,000,000 a year. This does not take into account the grass eaten by horses, sheep, and cattle, nor the vast quantities that are destroyed by insects and fungi. All of this food results from the work of leaves. It has been estimated that to make a pound of starch it takes a leaf area of about fifty square yards, the leaves working through ten hours of daylight.

109. Simple food-makers. There were living things upon the earth long before there were any leaf-bearing plants. There must, therefore, have been some way of making food out of simpler substances. Some of the species of plants that are still living and that are capable of manufacturing food are so simple that the whole body of one of them consists of but a single cell. Some of the commoner representatives of these

species are the green slime (*pleurococcus*) that we find growing on the bark of trees, on the shingles of houses, and on damp rocks, and the pond scum, or "frog spit" (*spirogyra*), that we find floating on the surface of ponds.

110. Green slime. The green-slime cell is a spherical cell (Fig. 25) consisting of a mass of protoplasm with its nucleus, a cell wall, and a quantity of chlorophyl. On the moist surface of the tree it is in a position to absorb water, carbon

dioxid, and various salts that either are washed down by the rains from the dust that strikes the tree or are dissolved from the bark. Supplied with these materials, and containing chlorophyl, the plant is able to manufacture, during the daytime, first carbohydrates and then proteins. The cell wall also permits the diffusion of oxygen from the outside air, and thus the plant breathes. Oxidation takes place in the protoplasm, releasing energy and producing carbon dioxid. This gas is excreted by osmosis through the cell wall. It is possible that some of this is used, in the daytime, in the process of photosynthesis.

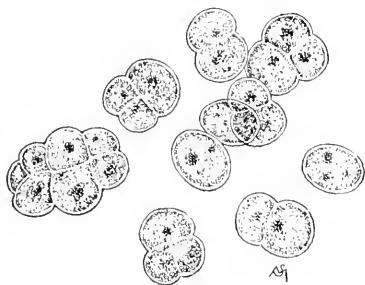

FIG. 25. Green slime. ($\times 500$)

This plant consists of a single cell. When the cell divides into two, the daughter cells may cling together or they may be separated. Sometimes a cluster, or "colony," is formed, containing many cells; in such a cluster each cell is independent of the others, since each is capable of making its own food as well as of absorbing the raw materials from the environment

The food manufactured by the cell is used almost immediately in the construction of more protoplasm, and thus the cell grows. When a certain size is reached, the nucleus divides, and presently there are two cells in place of one. These two cells may remain adhering to each other or they may soon separate. In any case they are quite independent of each other in every way — that is to say, each cell can keep on taking in substances from the outside, manufacturing food, growing,

and thus the plant breathes. Oxidation takes place in the protoplasm, releasing energy and producing carbon dioxid. This gas is excreted by osmosis through the cell wall. It is possible that some of this is used, in the daytime, in the process of photosynthesis.

throwing off waste oxygen from photosynthesis or waste carbon dioxide from oxidation, without regard to what its neighbor is doing. And each cell may also divide itself into two new cells independently of what its neighbor is doing. It thus comes about that we often find groups of cells in which some are seen to have grown faster than others, or to have divided more quickly, as is shown in the illustration.

In plants like this each cell carries on all *the activities that together make up being alive* — all the activities that in larger and more complex plants are carried on by different special parts or organs. But even in the most complex plants there are *some* activities that are carried on by *every* cell. Only certain processes are specialized.

CHAPTER XVIII

STARCH-MAKING AND DIGESTION

111. Digestion. We have learned that the simplest food resulting from photosynthesis is probably sugar. Experiments have shown that in many plants only sugar is formed. Most of our common plants, however, contain starch. In our own experiments we found starch in the leaves that had been exposed to the light, and none in the leaves that had been kept in the dark. Now, what became of the starch that must have been present in the leaves before we began our experiments?

The study of osmosis shows that starch, like many other substances, cannot diffuse through a cell wall. Such substances are called *colloids* (meaning "like glue"), to distinguish them from sugars and salts and other substances (called *crystalloids*) that diffuse through membranes more or less readily. Experiments show us that these colloids are changed into crystalloids and then pass through cell walls by osmosis. The process is called *digestion* and can be easily demonstrated.

In the grains and in other seeds containing starch the absorption of water leads to the development of a substance called *diastase*, which is capable of converting starch into sugar in the presence of plenty of water. Diastase has been extracted from malted barley (that is, barley that has been kept moist until the grains sprouted), from rice, and from many other seeds. It can be bought in the stores. A substance that behaves in many ways like diastase is found in human saliva and in the digestive juices of many other animals.

The change from starch to sugar makes it possible for carbohydrates to pass through cell walls by osmosis.

112. Ferments. Substances like diastase and the active part of the saliva are called *ferments*, or *enzymes*, and many

different kinds are known. They are peculiar in that *they seem to induce chemical changes in other substances, without, however, undergoing any changes themselves.* As a result of this peculiarity a comparatively large amount of material may be made to undergo chemical change through the activity of a very small amount of enzym.

113. Food transportation. The cells of the chlorophyll-bearing tissues contain diastase and other ferments. In the light, some of the sugar that is formed passes out of the pulp cells and is carried down in the *bast*, or *phloëm* tubes (see p. 176). But under favorable conditions for food-making the sugar is manufactured faster than it can be carried away. Most of it is then converted into starch, which is insoluble. In this way it accumulates in the cells during the day. When darkness sets in, a diastatic action converts the starch into sugar, and this is then carried down into the stem or roots (see diagram, Fig. 26).

This explains why leaves that are full of starch in the late afternoon show no signs of starch very early in the morning. As the morning light increases in intensity, starch is accumulated, and in the afternoon the cells are again full. From this we can also understand the presence of starch in potato tubers and in other organs that do not contain chlorophyll. The starch is formed in the cells of the tuber by the action of a ferment upon sugar. The sugar is brought from the leaves, passing at first from cell to cell by osmosis, then in the sap by way of the bast tubes. In the root or tuber the sugar passes from the vessels to the wood or bark cells by osmosis, and is then converted into starch.

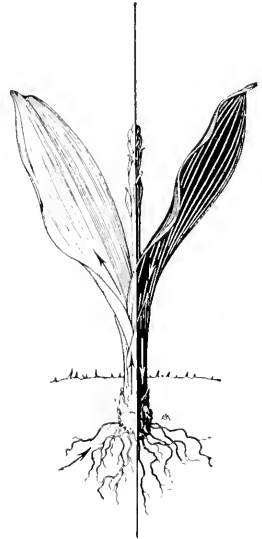

FIG. 26. Starch in light and darkness

During the daytime the plant manufactures carbohydrate in the leaves, receiving a steady supply of water from the soil. In the dark the starch is changed into sugar and there is a stream of sap running downward into the roots or underground stems, where the surplus is accumulated as starch

114. Digestion universal. The process of digestion seems to go on in nearly all living things. In the case of the ameba, which consists of a single unit of naked protoplasm (see p. 24), a solid particle of food can be swallowed by the naked protoplasm and then digested inside the cell. Among the bacteria, which are the smallest living things known, each individual is a single cell consisting of protoplasm and cell wall. These tiny plants can get food only in a liquid state; yet many of them live on solid food that is not soluble in water. Under suitable external conditions each cell throws out through the

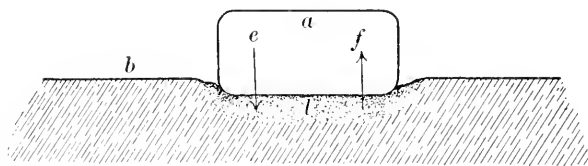

FIG. 27. Digestion by bacteria

The organism *a* lying on a solid *b*, which may serve as food, secretes an enzym. or ferment, which passes out of the cell *e* and changes the material to a liquid *l*. This is absorbed into the cell by osmosis, *f*

cell wall, by osmosis, a liquid containing a ferment capable of digesting the solid or insoluble food material. The liquid resulting from the digestion is absorbed by osmosis. This may account for the fact that when meat or cheese rots, it becomes fluid. The rotting in such cases is the work of the ferments contained in the digestive juices secreted by the bacteria (Fig. 27).

In higher animals like ourselves a similar process of digestion takes place. But instead of every cell pouring out digestive juices into its immediate neighborhood, only certain portions of the body produce and throw out such juices.

CHAPTER XIX

DIGESTIVE SYSTEM IN MAN

115. The human food tube. We receive our food and drink into our mouths. The mouth is the beginning of a long tube inside of which all the digestion takes place. This tube is called the *food tube* or the *alimentary canal* or the *digestive tract*. This tract consists of several fairly distinct regions; in an adult it is about ten or eleven yards long. It manages to keep inside the much shorter body by being coiled and twisted in parts (see Fig. 28, *j*, *k*).

116. Mouth digestion. Since what we eat is important to us on account of its proteins, fats, and carbohydrates, we may consider the digestive processes in relation to these substances.

After the food enters the mouth, it is crushed and ground by the teeth. During the process of chewing, however, something else happens. The taste of the food, the movement of the jaws, and the rubbing of the food against the inside of the mouth stimulate the action of the *saliva* glands (see Fig. 29) so that a quantity of saliva is poured into the mouth and this becomes mixed with the food. The more the food is chewed, the smaller are the particles into which it is broken, and the more thoroughly is the saliva mixed with the particles. As we have already learned (p. 78), the action of the saliva upon the starch in the food changes it into sugar. The other materials in the food are probably not changed, except that salts and sugars are dissolved by the water, of which the saliva contains over 99 per cent. As the amount of ferment is very small, the effectiveness of saliva as a digester of starch depends upon the ferment's reaching every particle of starch, and upon its having sufficient time to bring about the change.

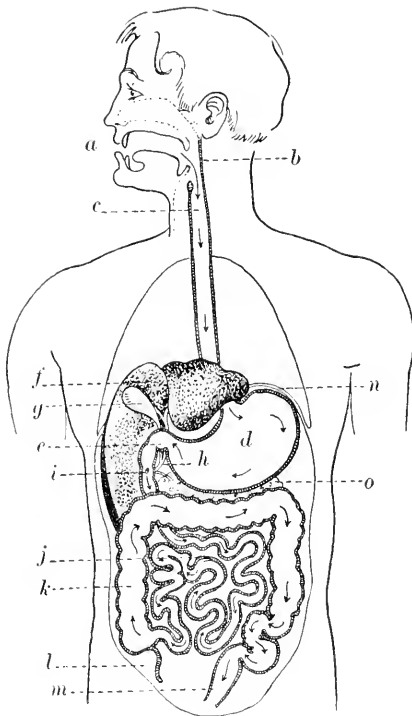

FIG. 28. The digestive organs in man

a, entrance to mouth; *b*, the pharynx, — a sort of vestibule with seven passages leading out of it, two to the nostrils, one to the mouth, one to the gullet, one to the windpipe, and one to each ear (the Eustachian tubes, see p. 240); *c*, the gullet, or *esophagus*; *d*, the stomach; *e*, the *pylorus*, opening from the stomach to the small intestine; *f*, the liver; *g*, the gall bladder; *h*, duct from the gall bladder and the liver to the small intestine; *i*, duct from the pancreas to the small intestine; *j*, small intestine; *k*, large intestine; *l*, vermiform appendix; *m*, rectum; *n*, the diaphragm, separating the chest cavity from the abdominal cavity; *o*, the pancreas. The arrows indicate the course taken by food in passing from the mouth through the alimentary canal

The thorough mixing of saliva with the food makes it easier for the whole mass to slide along into the throat, and later into the gullet, since the surface of the mass is thus coated with the slippery *muco* of the saliva.

117. Swallowing. After the mouthful of food has been thoroughly chewed, it is pushed back by the tongue and passed into the throat chamber, or *pharynx* (see Fig. 28, *b*), from which it passes directly into the gullet, or *esophagus*. The swallowing is not merely a falling down of the food from the pharynx into the stomach.

It is an active carrying brought about by the successive contraction of rings of muscles that lie in a series in the wall of the gullet. If you watch a horse drinking water from a pond or from a pail set on the ground, you can see him swallow the water *up*, and you can see, showing

through the skin, one wave of contraction after another pass along the gullet, from the head to the trunk.

118. The stomach. Whatever fermentation has been started by the saliva in the mouth continues in the mass of food until this reaches the stomach. Here, however, it stops the moment the acid, or sour, stomach juice comes in contact with the saliva. It seems that the saliva ferment cannot act in the presence of acid.

The stomach juice contains a special ferment known as *pepsin*. Pepsin, in the presence of acid, acts upon the proteins in the food, changing them into soluble compounds of similar composition, known as *peptones*. Peptones differ from proteins chiefly in this one fact, that the former are soluble in water and are capable of diffusing through membranes, while the proteins are generally not capable of such diffusion.

In the stomach the swallowed substances are thoroughly mixed with the *gastric*, or stomach, juice by the action of the muscles in the stomach wall. The

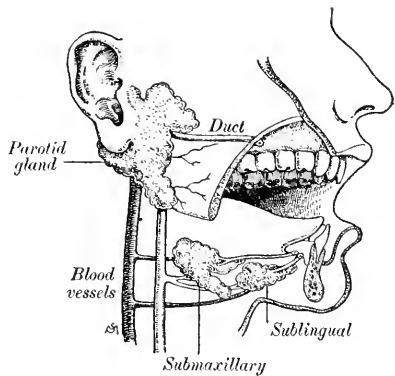

FIG. 29. The salivary glands

There are three sets of glands which produce saliva: the parotid, in the cheek, just in front of the ears; the submaxillary, under the angles of the jaw; and the sublingual, under the tongue

The stomach wall contains layers of muscle cells running in different directions, as well as gland cells in which are produced the particular substances found in the gastric juice (see Fig. 30).

As the changing of proteins to peptones goes on, the mixture in the stomach becomes more and more liquid and more and more acid. From time to time a quantity of the liquid in the stomach is squirted out into the beginning of the intestine by the opening of the connection (Fig. 28, *c*) and the contraction of the stomach at the same time. After a while most of the contents of the stomach has been changed to a mixture

having the consistency of a rather thick pea soup, and all of it has passed on into the intestine.

119. The intestines. There are two distinct parts, or divisions, of the gut among the highest animals. The first part is called the *small intestine*, and in human beings it is about one inch in diameter and about twenty-four or twenty-five feet long. The small intestine opens rather abruptly into the *large intestine*, which is about two inches in diameter and about five feet long (see Fig. 28, *j*, *k*).

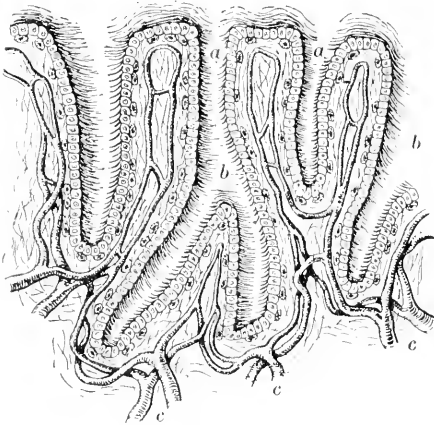

FIG. 30. Glands of the stomach

The gastric juice is poured into the stomach through tubes, *a*, which are lined by a layer of delicate cells; it is produced by special gland cells, *b*, from materials brought by the blood in fine vessels, *c*. ($\times 200$)

The wall of the intestine is rather thin and soft. You have probably handled a piece of pig gut or calf gut, which is used as sausage casing.

In the living animal the wall of the intestine is not so hard and stiff as we sometimes find it in the sausage casing. This wall is made up of several layers of tissue. The inner lining carries very small glands, and the outer layers contain

muscle cells. To this extent the wall of the intestine is like the wall of the stomach. The muscle cells of the gut are arranged in rings, so that when they contract they simply reduce the diameter of the intestine at any given point. The contraction starts at the forward end—that is, the end nearest the stomach—and passes backward along the whole length of the small intestine, aided by longitudinal muscles. As a result of this wave of contraction some of the thick mixture of food and digestive juices is moved along, a short distance

at a time. This movement is called *peristalsis* and is very similar to the swallowing movement of the gullet.

When a food mixture passes from the stomach, it contains all of the fat that it contained when it first entered the mouth, since neither the saliva ferments nor the gastric ferments have any effect upon fats. It contains all the sugar that was there to begin with, together with all the sugar that was formed by the digestion of starch in the mouth. It contains whatever starch was not digested. It contains the peptones formed by the gastric digestion (in solution), and particles of proteins that were not digested. In addition there is a quantity of water, mineral salts, the remains of the gastric and salivary juices, and the fibers and cell walls of the food material, which have not been acted upon in the mouth or in the stomach. In the intestines many changes take place in the character and composition of this mixture.

Near the beginning of the intestine (Fig. 28, *h, i*) there is a small opening connected with two small tubes, or *ducts*. One of these is connected with the largest gland in the body, the *liver*; the other is connected with another very important gland, the *pancreas* (Fig. 28, *o*).

120. The pancreas. The juice secreted by the pancreas contains three important kinds of ferments:

1. A ferment that converts starch into sugar.
2. A ferment that digests proteins into simpler compounds.

Any starch that has been swallowed before the saliva has had time to transform it into sugar, and any protein that has passed from the stomach without being digested by the pepsin, will now be digested by the action of the pancreatic ferments.

3. A ferment that acts upon the fats in the food, breaking them up into glycerin and *fatty acids*, which latter combine with other substances to form *soaps*.

The soaps and the glycerin dissolve in water and diffuse through cell membranes.

The pancreatic juice thus contains all the kinds of ferments necessary for digesting a whole meal.

121. The liver. The juice produced by the liver is called the *bile*, or *gall*.

1. It does not contain any ferments that seem to be important in digestion, but it does have an influence on the absorption of the fatty acids and soaps by the cells of the intestine.

2. The bile seems further to have some effect upon the activity of the pancreatic ferments. When the contents of the stomach pass into the intestine, the mixture is acid; the bile neutralizes the acid and makes possible the activity of the other ferments.

3. The bile is made up chiefly of materials that are of no further use to the body — materials that have been converted in the liver and are then thrown into the intestine, from which they are removed from the body. The liver is thus also an excretory organ.

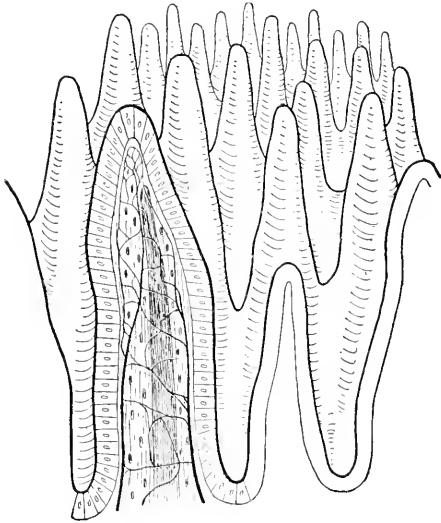

FIG. 31. The lining of the intestine. ($\times 150$)

The tiny projections from the lining of the small intestine, the *villi*, give the appearance of very fine velvet. Absorption takes place through the outer layer of cells. Within each villus are fine blood vessels and lymph spaces; from these the absorbed food is transferred to circulation system

122. The intestinal juices. The juices secreted by the glands of the intestine contain no ferments that are of great importance in digestion, although they do contain a great deal of sodium carbonate, which neutralizes the acids resulting from the digestion of fats by the pancreatic juice, and probably also other acids resulting from other

chemical changes in the gut. There is a ferment in the intestinal juice which converts cane sugar into simpler sugars, but this change may also be brought about by the acids of the stomach, and possibly also by the alkali in the intestine.

123. Absorption. The lining of the small intestine is like delicate velvet. Very small out-growths project into the cavity, so that the surface exposed to contact with the food mixture is increased several hundred times. Each of these tiny projections, called a *villus* (plural, *villi*), has a rather complex structure, as is shown in the diagram (Fig. 31).

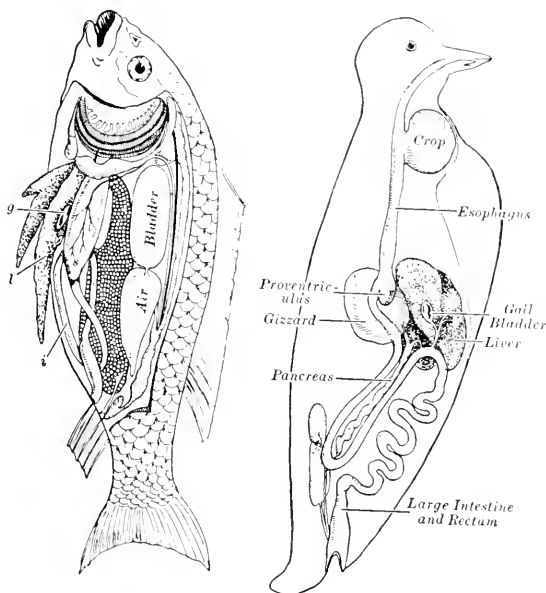

FIG. 32. Digestive system in fish and in bird

The main features of the digestive system are alike in all backboneed animals. In the birds there is a curious pouch connected with the gullet, — the crop, — in which food may be retained indefinitely and later either swallowed or regurgitated through the mouth. The glandular portion of the stomach, or proventriculus, is distinct from the grinding part, or gizzard

The villus seems to be a special absorbing and transforming organ. The mixture in the intestine we now know to consist of many crystalloids in solution, many colloids in the process of being converted into crystalloids, and solid substances that are not capable of changing under the conditions that exist in the gut.

The crystalloids are absorbed into the cells of the villi, so that as the mass moves along in the intestine, more and more

of the digested matter is withdrawn into the villi. From the surface cells of the villi the absorbed material is passed on, by osmosis, to the blood vessels and to the lymph vessels. Chemical changes take place in the course of the transfer, so that the material taken into the blood is not in exactly the same state as the material absorbed from the intestine, although, of course, it is made up of the same elements.

By the time the dinner you have eaten has reached the end of the small intestine, most of the proteins, fats, and carbohydrates that it contained have been absorbed by the villi and passed on into the blood and lymph. There is left in the intestines at this point chiefly the undigested (for the most part indigestible) fibrous and cell-wall material of the plant or animal tissues eaten, and the modified secretions of the various glands that have poured into the food tube all along the way. This mass of refuse now passes into the large intestine (Fig. 28, *k*).

124. The large intestine. In the large intestine the ferments of the digestive juices may still continue to act for some time. But gradually, as the mass proceeds along the canal, it becomes drier, through the continued absorption of material by the lining of the intestine (there are no villi in the large intestine), so that toward the end the only chemical changes going on are those produced by the millions of bacteria that are present in the intestines of all animals.

The mass of material that has accumulated toward the end of the large intestine is of no further use to the body, and should be removed from time to time. Birds, having no large intestine, throw off the refuse about as fast as it passes from the small intestine to the rectum (Fig. 32). Other animals and infants throw off the refuse automatically. But older children, absorbed in their games or other activities, are apt to postpone emptying the bowels, and thus become irregular. This neglect of the bowels often brings about serious consequences, so that it is important for us to acquire regular bowel habits while we are still young (see p. 118).

CHAPTER XX

HEALTH AND FOOD STANDARDS

125. Conditions of health. The normal, healthy digestion and absorption of food depend upon

- (1) the secretion of digestive juices by the glands ;
- (2) the fermentative action of the substances in these juices ;
- (3) the muscular contractions of the gullet, the stomach, and the intestines.

We can do nothing to control these processes directly, either to hasten them or to stop them. But *indirectly* we can do a great deal to control them.

First of all, we can decide *what* to eat, *how* to eat, and *when* to eat.

Then we can decide for ourselves what kind of habits we will have with regard to the behavior of the large intestine.

And, finally, we can do a number of things that are not directly connected with feeding, but that have important bearings on the healthy behavior of the digestive system.

All these controls come to us from a better understanding of the biology of nutrition and digestion.

126. What to eat. Since all living beings consist essentially of proteins, fats, and carbohydrates, it would seem that almost any plant or animal stuff would be suitable for food. But we know from experience that some of these things are not pleasant to the taste, or are even disagreeable, and that others are *poisonous*. Some substances, while neither unpleasant nor injurious, contain so little usable or digestible material that they are not worth eating. In the course of ages human customs have selected the plant and animal materials in any given region that are most valuable for food. We are all the time

discovering useful food plants and food animals that are strangers to us but familiar to people in remote parts of the earth, and neither our instincts nor our customs tell us the best way to use them. Even in regard to the older kinds of food we are almost as ignorant; for while we know that the flesh of an ox is better for food than the hoof or the hide, and that the grain of the wheat is better than the leaf or the root, experience has not taught us what *proportions* of meat and grain and fruit are the best for maintaining efficient health, and certainly we have to learn that one combination of foods is best for one person, while another combination is best for another person.

127. Dietary studies. When the study of *dietaries* was first begun, it was assumed that what people actually eat is on the average the best thing for them to eat, both as to kind and as to quantity. Accordingly students made careful records of the meat and bread and butter and vegetables and fruits and cheese eaten by thousands of people. They calculated the amount of protein, fat, and carbohydrates contained in these dietaries, and sought thus to establish, from the averages, a standard of what healthy people require day by day. By this method Carl Voit in Germany and Professor W. O. Atwater in this country concluded that a person doing a moderate amount of work needs about four ounces of protein daily, to take the place of the proteins oxidized in the cells of the body. But later experiments, in which the amount of protein taken in and the amount of nitrogenous waste given off were carefully measured, lead to the conclusion that an adult weighing about one hundred and sixty pounds requires hardly more than two ounces of proteins in every twenty-four hours.

Since protein is the most expensive material in our food, and at the same time the one that is most severe upon the organs of the body, especially the liver and kidneys, it is a matter of great importance to know whether two ounces will suffice or whether four ounces are necessary. We should therefore try to understand the basis upon which these diverse standards are established.

128. Units of energy. To measure the energy expended by the body, or to measure anything else, we must have a *unit*. We measure length in inches or yards or miles. In a similar manner we are able to measure energy by *work done*. But as different forms of energy do different kinds of work, it is necessary to find some common unit for measuring. For example, motion can be measured by the quantity of matter moved and the distance through which it is moved, as one ton raised five inches, three pounds raised two feet. The unit of measuring this kind of work may be the foot pound, or the amount of energy it takes to raise one pound of matter one foot.

It takes a certain quantity of heat to change the temperature of a pint of water from ordinary room temperature (about 18° C. or about 65° F.) to the boiling point (212° F.). For a quart of water it would take twice as much heat to do the required *work*. As a unit of energy we might use, for example, the pint degree. Among engineers the quantity of heat needed to raise one kilogram of water (a little more than a quart) from the temperature of 0° to the temperature of 1° C. is called a *calorie*. This unit is sometimes called a "large calorie," to distinguish it from the "small calorie" (1 gram of water, one degree Centigrade), which is used in very delicate measurements.

In dealing with fuel or the conversion of fuel energy into other forms, it is customary to record energy in terms of calories. In dealing with mechanical work it is customary to record energy in terms of foot pounds, or horse-power hours.¹

¹ The fuel values of proteins, fats, and carbohydrates are as follows:

	CALORIES PER GRAM	CALORIES PER POUND
Proteins	4.1	1860
Carbohydrates	4.1	1860
Fats	9.3	4219

From these figures it will be seen that a given quantity of fat contains more than twice as much latent energy as the same quantity of protein or carbohydrate, and that the latter two classes of compounds have the same fuel value.

129. Respiration calorimeter. The work of the human body or any other animal body can be measured in terms of calories by means of very delicate apparatus that has been developed in recent years. In a large chamber that is completely inclosed so

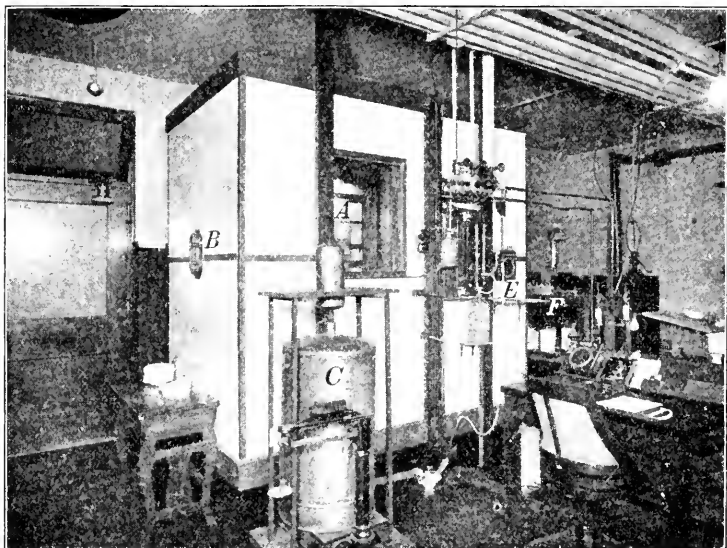

FIG. 33. The respiration calorimeter

In the large chamber a man can live for several days or weeks under conditions that give an accurate account of his body's income and expenditure, in the way of matter as well as in the way of energy. *A*, door and window; *B*, door for food etc.; *C*, tank for catching water circulating through the walls of the chamber; *D*, observer's table, with devices for measuring and regulating temperature etc.; *E*, rubber bag to equalize the air pressure within the chamber; *F*, apparatus for circulation and purification of air in the chamber. From photograph furnished by Office of Home Economics, United States Department of Agriculture

as to prevent the escape of heat, a person may live for several days or weeks at a time under conditions that allow us to measure every particle of material that goes in or that comes out, as well as the amount of heat that is given off by the body (Fig. 33).

With this apparatus exact records are made of the work a human being does in the course of a day, measured physically

as calories or foot pounds instead of in terms of useful product, as words written, nails driven, or yards of carpet woven.

130. Our daily needs. From experiments with the respiration calorimeter it has been determined that a person weighing about one hundred and fifty to one hundred and sixty pounds and doing a moderate amount of physical work expends about 2800 calories a day, whereas a person engaged in a sedentary occupation, as a clerk or bookkeeper, would not use up more than 2400 calories. The higher of these figures is considerably less than the standard set by Atwater, which was over 4000 calories for the moderate worker and 4500 for the hard worker.¹

These experiments have been supplemented by others made by college professors on themselves and their colleagues, on college athletes and other students, and on soldiers. We thus learn that most people eat too much food, and especially too much proteins.

The protein standard established by Professor Chittenden at Yale, for adults doing various kinds of work, is just one half that announced by Voit, namely, about two ounces in twenty-four hours. In the experiments, students, professors, and soldiers not only kept up their weight on this basis but really did more and better work, and were in better health generally, than under the larger protein allowance.

The amount of protein used up in the course of a day depends not upon the amount of muscular work done but upon the rate of growth and upon the weight of the body (not counting the fat). A stonemason or miner does not need more protein than a shoemaker or stenographer of the same weight, but he does need more fat or carbohydrates.

¹ Even Voit's standard gave 3000 calories for the moderate worker and 3500 for the hard worker. A comparison of Voit's figures with Atwater's leads one to suspect that the American workers ate more food than the German workers, probably because food was at that time cheaper in this country, or wages relatively higher. In the end we shall have to depend upon *experiments* to tell us just what is the wisest thing to do in regard to eating.

CHAPTER XXI

FOOD REQUIREMENTS

131. Selection of food. When we go marketing, or when we look over the bill of fare at a restaurant or hotel, we do not select proteins and calories; we select cuts of meat, vegetables, fruits, cheese, bread, and so on. Suppose that you had for breakfast a large banana, a glass of milk, two slices of bread and butter, and an egg. How much protein is there in such a breakfast, and what is the total fuel or heat value of the food?

We should have some means of translating the products of the food factories and the kitchen into terms of proteins and calories. This is furnished by tables that have been prepared by experts working for the government, for hospitals, and for manufacturers. We can make use of some of these results to guide us in our own selection of food.

132. Food composition. From the table of food composition on page 95 we can get an idea that some of the food materials which we use contain more nutrients than others, and that some contain a larger proportion of proteins, or of fats, or of carbohydrates. We can get these ideas more readily from charts and diagrams. The United States Department of Agriculture has issued a series of charts in which the composition and fuel value of a large number of articles of food are shown in colors. A few of these are reproduced in Fig. 34.

133. Fisher's table. Professor Irving Fisher of Yale University has prepared a list of common articles of food, with a statement of how much it takes of each kind to give approximately one hundred calories, and the proportion of this furnished by the protein. A portion of this table is reproduced on page 96.

COMPOSITION OF VARIOUS FOOD ARTICLES

	PER CENT OF PROTEIN	PER CENT OF FATS	PER CENT OF CARBO- HYDRATE	PER CENT OF WATER	CALORIES PER POUND
Milk, whole	3.6	4.0	4.7	87.0	325
Buttermilk	3.0	0.5	4.8	91.0	165
Butter	1.0	85.0		11.0	3615
Cheese, full cream	25.9	33.7	2.4	34.2	1950
Eggs, edible portion	14.8	10.5		73.7	700
Beef, porterhouse, edible portion	20.0	20.0		60.0	1270
Beef, dried	30.0	6.5		54.3	840
Bacon, smoked	9.4	67.4		18.8	3030
Ham, lean, edible portion	25.0	14.4		60.0	1075
Lamb, leg, roast	19.5	12.7		67.1	900
Chicken, broiled, edible portion	21.5	2.5		74.8	505
Salmon, California, edible por- tion	17.8	17.8		63.6	1080
Brook trout	19.0	2.1		77.8	445
Oysters, solids	6.2	1.2	3.7	87.0	235
Bread, homemade	9.0	1.3	54.9	33.2	1245
Bread, brown	5.4	1.8	47.1	43.6	1050
Corn meal, granular	9.2	1.9	75.4	12.5	1655
Oatmeal, boiled	2.8	0.5	11.5	84.5	285
Rice, boiled	2.8	0.1	24.4	72.5	510
Macaroni, cooked	3.0	1.5	15.8	78.4	415
Beans, string, cooked	0.8	1.9	29.1	95.3	95
Beans, baked, canned	6.9	2.5	19.6	68.9	600
Cabbage, edible part	1.6	0.3	5.6	91.5	145
Potato, boiled	2.5	0.1	20.9	75.5	440
Apple, as purchased	0.3	0.3	10.8	63.3	290
Banana, edible part	1.3	0.6	22.0	75.3	460
Figs, fresh	1.5		18.8	79.1	380
Figs, dried	4.3	0.3	74.2	18.8	1475
Dates, dried, edible portion . . .	2.1	2.8	78.4	15.4	1615
Orange, whole	0.6	0.1	8.5	63.4	170
Watermelon, whole	0.2	0.1	2.7	37.5	60
Peanut, edible part	25.8	38.6	22.4	9.2	2580
Walnut, California soft shell, edible portion	16.6	63.4	16.1	2.5	3285
Sugar, granulated			100.0		1860

SELECTIONS FROM DR. IRVING FISHER'S 100-CALORIE
PORTIONS TABLE

	SIZE OF PORTION	WEIGHT OF PORTION (OUNCES)	CALORIES FROM PROTEIN	CALORIES FROM FATS	CALORIES FROM CARBOHY- DRATES
Milk, whole	Small glass	4.9	19	52	29
Buttermilk	1½ glasses	9.7	34	12	54
Butter	One pat	.45	0.5	95.5	
Cheese, full cream .	1½ cubic inches	.82	25	73	2
Eggs	One large	2.1	32	68	
Beef, porterhouse .	Edible part, small steak	1.3	32	68	
Beef, dried	Ordinary serving	1.9	67	33	
Bacon, smoked . .	Small serving	.5	6	94	
Ham, lean	Edible portion, average serving	1.5	44	56	
Lamb, leg, roast . .	Ordinary serving	1.8	40	60	
Chicken, broiled .	Edible portion, large serving	3.2	79	21	
Salmon, California .	Edible portion, small serving	1.5	30	70	
Brook trout	2 small servings	3.6	80	20	
Oysters, half shell .	1 dozen	7.	49	22	29
Bread, homemade .	Thick slice	1.3	13	6	81
Bread, brown . . .	Thick slice	1.5	9	7	84
Corn meal, granular	2.5 level teaspoonfuls	.96	10	5	85
Oatmeal, boiled . .	1½ servings	5.6	18	7	75
Rice, boiled	Ordinary cereal dish	3.1	10	1	89
Macaroni, cooked .	Ordinary serving	3.9	14	15	71
Beans, baked, canned	Small side dish	2.7	21	18	61
Beans, string, cooked	5 servings	16.7	15	48	37
Cabbage	Edible portion	11.0	20	8	72
Potato, boiled . . .	1 large	3.6	11	1	88
Apple, as purchased	Two	7.3	3	7	90
Banana	Edible portion, 1 large	3.5	5	5	90
Figs, dried	1 large	1.1	5		95
Dates, dried, edible	3 large	1.0	2	7	91
Orange, as purchased	1 very large	9.4	6	3	91
Watermelon	Whole	27.0	6	6	88
Peanut	Edible part, 13 double	.64	20	63	17
Walnut, California soft shell	Edible part, about 6	.5	10	83	7
Sugar, granulated .	7 level teaspoonfuls, 3½ lumps	.86			100

134. Rexford's table. Instead of considering weights or the quantities necessary to make up one hundred calories, Mr. Frank A. Rexford, of the Erasmus Hall High School in Brooklyn, made up a table giving the protein and fuel values of a portion of each of a large number of food articles, together

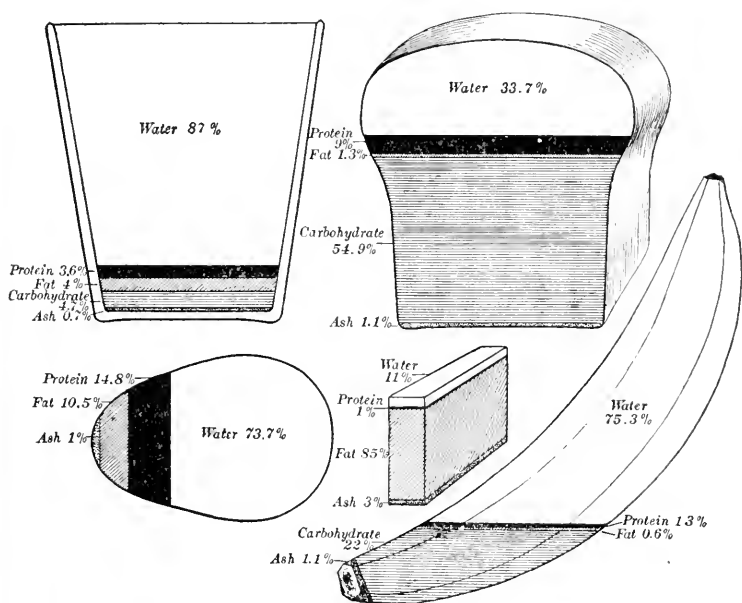

FIG. 34. Composition of food

The proportions of water, protein, fat, carbohydrate, and mineral matter (ash) in a glass of milk, an egg, two slices of bread, a pat of butter, and a banana are shown in this diagram, designed after the Langworthy charts. Such diagrams enable us to tell at a glance the relative amount of each nutrient present in our common articles of diet

with the quantity which he considers an ordinary helping. A part of this table is given on page 98 by way of illustration.

135. The nutritive ratio. Since protein yields energy on oxidation, as do the other nutrients, it would seem that one could subsist on protein alone, getting the double service (building material and power) from the one nutrient. And,

PART OF MR. REXFORD'S ONE-PORCION FOOD TABLE

	WEIGHT OF ORDINARY HELPING (OUNCES)	OUNCES OF PROTEIN	OUNCES OF FATS	OUNCES OF CARBO- HYDRATES	CALORIES FURNISHED
Milk, whole	6.0	.19	.24	.30	123.6
Buttermilk	6.0	.18	.03	.29	61.9
Butter	0.5	.05	.43		112.5
Cheese, full cream . . .	1.0	.26	.34	.02	122.4
Eggs, boiled (2)	4.75	.64	.50		227.1
Beef, sirloin	2.25	.37	.36		137.1
Beef, chuck, lean . . .	3.0	.57	.4		172.5
Beef, dried	1.0	.26	.07		49.4
Bacon	1.0	.1	.66		188.6
Ham, lean	2.25	.49	.55		203.2
Lamb, leg	3.5	.67	.44		194.3
Chicken, broiled	3.5	.75	.09		110.5
Salmon (canned)	2.0	.44	.24		114.1
Brook trout	1.75	.33	.36		135.9
Oysters	3.5	.21	.04		36.4
Bread, white, homemade	2.0	.18	.03	1.07	153.1
Oatmeal	4.25	.13	.02	.49	70.5
Macaroni, boiled	2.75	.36	.02	2.00	286.2
Beans, baked	3.25	.31	.18	1.08	182.0
Cabbage, boiled	4.00	.03	.09	.06	35.2
Potato, boiled	3.00	.08	.01	.73	82.8
Apple, fresh	5.5	.02	.02	.78	99.6
Banana	3.5	.05	.02	.77	100.8
Dates	1.75	.04	.05	.59	177.6
Figs	2.0	.00	.01	1.5	184.4
Orange	5.0	.04	.01	.58	75.0
Peanut	0.5	.13	.19	.12	80.1
Walnut, English	0.5	.08	.32	.08	103.4
Sugar	0.25			.25	27.0

indeed, there are animals and certain plants (bacteria and molds) that can get along very well on proteins alone; nor is there any reason to doubt that a human being could also live on a pure protein diet. But, as we shall see later, we cannot

afford to live exclusively on proteins when fats and carbohydrates are available; and it is really worth while to reduce the protein in the food to the lowest proportion of practical safety; that is, to find the *nutritive ratio* that serves our practical purpose. From a consideration of the dietary standards of Voit, Atwater, Chittenden, and other investigators (see p. 93) we can see that, whichever standard is adopted, the protein ratio falls within certain definite limits. This is clearly shown by the comparison given in the following table:

STANDARD	PROTEIN (OUNCES)	PROTEIN CALORIES	TOTAL CALORIES	NUTRITIVE RATIO
Voit	4	464	3000	1:6.5
Atwater	5	580	4000	1:7
Chittenden	2	240	2400	1:10

A protein ratio of from 1:7.5 to 1:9 is a good average, although a smaller person or a person doing a large amount of muscular work would need a lower protein ratio.

If we calculate the number of calories and the amount of protein in our supposed breakfast, by using either the Fisher table or the Rexford table, we shall find that the total food represents from 620 to 750 calories, with a protein ratio of from 1:6 to 1:7, according to the size of egg or banana and the size of bread slices assumed.

136. Standard diets. To make practical use of the idea of standard diet we have further to consider (1) the age of a person, (2) the amount and character of his day's work, and (3) the seasons of the year.

The age is important because (1) the digestive system of young people may not be able to tolerate what an older person can stand; (2) a young person is usually smaller and so uses up less proteins each day; and (3) a young person is growing, and so uses more proteins for building new tissues than an older person does.

The food required "per man per day" being taken as one hundred, the food requirements of children under sixteen years of age have been given as in this table :

AGE	FOR BOYS	FOR GIRLS
Under 2 years	30	30
2 to 5 years	40	40
6 to 9 years	50	50
10 to 12 years	60-70	60
13 to 14 years	80	70
15 to 16 years	90	80

The nutritive ratio is left the same for children as it is for adults, although we should expect children who are growing to require relatively more protein. The balance is probably brought about by the fact that children are relatively more active than adults, so that they use up comparatively more fats and carbohydrates.

The amount and character of work done by a person are important factors in determining his food requirements. Experiments made to show the quantity of energy used up by a man under varying conditions gave the results summarized in the following table :

CONDITION OF THE BODY	CALORIES PER HOUR
At rest, sleeping	65
At rest, awake, sitting up	100
At rest, standing	117
Engaged in light muscular exercise	170
Engaged in moderately active muscular exercise	290
Engaged in severe muscular exercise	450
Engaged in very severe muscular exercise	650-675

Since people do not ordinarily sleep all the time or work all the time, the amount of energy used up per day will depend upon one's daily program ; that is, on the distribution of sleep and rest and various degrees of activity. Thus, a person working in the steel mills twelve hours a day, seven days in the week, expends more energy

than a clerk who sits at a desk eight or nine hours; an errand boy who really runs five or six hours a day may expend more energy than a stout man playing golf seven or eight hours. On the basis of hours and kinds of work done, the following calculations¹ have been made; these are to serve merely as a basis for comparison, and not as absolute standards.

CHARACTER OF WORK	CALORIES PER DAY
According to Tigerstedt	
Lumberman	Over 5000
Excavator, miner	4100-5000
Farm hand (in busy season)	3200-4100
Carpenter	2700-3200
Weaver	2400-2700
Shoemaker	2000-2400
According to Langworthy	
Man at very hard work	6000
Farmers, mechanics, etc.	3425
Business men, students	3285
Inmates of institutions (doing little or no work)	2600
Very poor persons (usually out of work)	2100

¹ More recently, experimental studies of this subject have been made on a large scale, with the use of the respiration calorimeter, at the University of Helsingfors in Finland. The results of these experiments, made by Becker and Hämäläinen, are given in the following table:

	CALORIES PER DAY FOR MEN
Woodcutter, lumberman	5500-6000
Stonecutter, excavator, miner	4700-5200
Cabinetmaker, farm hand, painter	3500-3600
Metal worker	3400-3500
Shoemaker	3100
Bookbinder	3000
Tailor	2600-2800
	CALORIES PER DAY FOR WOMEN
Washerwoman	2900-3700
Housemaid	2500-3200
Bookbinder	2100-2300
Seamstress (on sewing machine)	2100-2300
Seamstress (on hand work)	2000

A comparison of the food requirements of men and women at different periods of life, and according to work done, is given in the following table, in which 100 represents the requirements of a man per day (cf. table on page 100):

<i>Period of full vigor</i>	FOR MEN	FOR WOMEN
Engaged in moderate work	100	80
Engaged in hard work	120	100
Engaged in light work (sedentary)	80	70
<i>In declining vigor</i>		
In old age	90	90
In extreme old age	70-80	70-80

From the discussion and the tables given above, one should be able to calculate the requirements of different people in the way of proteins, fats, and carbohydrates, and to translate these requirements into the actual food articles that make up our meals, so as to secure a balanced diet.

One other thing needs to be considered in making up a plan for a dietary, and that is the matter of climate and seasons. We have learned from our reading about different races of men that the natives of tropical countries eat very little meat, whereas the natives of cold countries eat very little fruit but a great deal of fat. We can understand why the Eskimos eat no fruit: there is no fruit to be had where they live. But the inhabitants of the tropics can get almost any kind of food they might wish. The fact is, however, that in a cold region one must provide for a larger supply of heat than in a hot region. As fat yields the largest amount of energy in proportion to weight, it is especially desirable in the diet when energy is to be increased, rather than building material or bulk. So we may increase our fuel foods in the winter and reduce them in the summer.

137. Balanced diet. Many people have supposed that there must be an ideal food, some one material that would satisfy all the needs of the body; if this were found, we should save

the thought and expense of arranging meals, and we should be safe from the danger of eating the wrong kind of food. But a glance at the table prepared by Professor Fisher (p. 96) will show us that there are really very few substances that have the required proportions of proteins and fuel foods to meet our needs. A nutritive ratio lying between 1:7.5 and 1:9 would appear on this table for any food that has between 11 and 13 calories due to protein for every 100 calories consumed. It is easy to see that if you ate enough beef to supply the protein needs of the body, and nothing else, you would have insufficient fuel; and if you ate enough to supply the necessary fuel, you would take in a great excess of proteins. On the other hand, if you tried to live on fruit, you would have to eat the equivalent of about thirty-five pounds of apples to supply the necessary protein; nine pounds would supply sufficient energy for a day for an ordinary student, but there would then be a shortage of protein. Corn, onions, baked potatoes (whole), almonds, and bread come very near to furnishing a balanced diet. Potatoes and corn would have to be consumed in large quantities to meet the day's needs; an exclusive onion diet would hardly be satisfactory; and the almond meats would not satisfy the hungry feeling, since they would not occupy enough space in the stomach and intestine. Taken by itself, good bread, made of whole grains, comes the nearest of all our food articles to furnishing a balanced diet of approximately satisfactory bulk. Of course, "bread" must be taken to include a large variety of flour preparations, such as macaroni, Vienna rolls, shredded-wheat biscuit, and various crackers and biscuits.

If we are not content to live on bread alone, as most of us are not, we shall not be able to find any other one substance that will by itself meet all the requirements of the daily diet. It is therefore necessary to combine high-protein foods with low-protein foods in the proportions that will furnish bulk as well as the proper nutritive ratio, and that will at the same time suit

the taste. Since the high-protein foods are mostly of animal origin, and the low-protein foods are mostly of vegetable origin, a balanced ration selected to meet all three requirements mentioned above (bulk, protein ratio, and taste) is likely to contain materials of both kinds. At any rate, it is only by means of a mixed diet that we are able to maintain for a long time a satisfactory ration. Milk for children less than a year old would seem to be the only exception to this statement.

Experiments with mice and guinea pigs, as well as with human beings and other animals, have shown that the various proteins in the materials used as food do not all behave alike in relation to growth, or in relation to maintaining body weight. The chemical analysis of proteins that behave in these different ways shows that certain groups of elements, called *amino acids*, which are contained in some proteins, are absolutely necessary for growth, whereas other amino acids are suitable for maintaining weight, although they cannot support growth.

The importance of having the diet balanced appears among people who are either so ignorant as to purchase food entirely on the basis of the appetite or the temptations of the market, or so poor as to be unable to buy any but the cheapest articles to be obtained. The indulgence of the appetite may lead to malnutrition through an excess of sweets, and to digestive disturbances through an excess of meats (proteins). The resort to the cheapest foods may lead to malnutrition through an excess of starches, since, generally speaking, the starchy foods are the cheapest, weight for weight. There are other matters, besides the nutritive ratio, that influence the physical condition of the body; but this is something that cannot be safely disregarded.

CHAPTER XXII

FOOD AND DIETARIES

138. Flesh or vegetable diet. The question is frequently raised whether animal material or plant material is better for human food, and there are some people who would rule out all food of animal origin, although there are probably none who argue against the use of vegetable food. Many reasons are given for the exclusion of animal matter from human diet.

One argument assumes that it is wrong to kill living beings even to maintain our own lives. We know that life can continue only with a supply of proteins and fuel foods, that these are to be found only in the bodies of living things, and that only organisms with chlorophyl can manufacture the food themselves. This argument therefore implies that it is wrong for flesh-eating animals to live at all, and that it is right to rob plants of their food stores or to kill them for food. Some vegetarians make the point that killing a plant is not wrong, because plants do not have *sensations* and *emotions* like those of the higher animals. Such persons do not object to using eggs and milk, which can be obtained without actual slaughter.

Another argument against the use of meat is based on the structure of the human body compared to the structure of animals that are naturally flesh-eaters and animals that are naturally fruit-eaters or grain-eaters. Our teeth are more like the teeth of fruit-eating and nut-eating monkeys than they are like the teeth of flesh-eating wolves or tigers. The length of the intestine is also sometimes pointed to as an argument against flesh-eating.¹

¹ The table on page 106 will show us that our intestines are relatively long, corresponding to the intestine of the non-flesh-eating animals, in which the removal of nutrients from the food takes more time than it does in the flesh-eating animals.

COMPARATIVE LENGTH OF FOOD TUBE IN DIFFERENT GROUPS OF MAMMALS

GROUP OF MAMMALS	EXAMPLES	RELATIVE LENGTH OF ALIMENTARY CANAL
Carnivora (Flesh-eaters)	Lion, wolf	Three times length of trunk and head
Omnivora (All-eaters)	Pig, boar	Ten times length of trunk and head
Frugivora (Fruit-eaters)	Monkey, ape, <i>man</i>	Twelve times length of trunk and head
Herbivora (Grass-eaters)	Horse, sheep	Thirty times length of trunk and head

This comparison proves very little, except that the relative length of man's digestive tube is most like that of monkeys and pigs. It is true that our food tube is three or four times as long as that of the exclusive flesh-eaters, but it is about a third as long as that of the exclusive vegetarians, like the cow and the camel. If the animals nearest like man do indeed subsist upon an exclusively vegetarian diet of fruit and vegetables, it may mean only that the monkeys have neither the instincts nor the cleverness to provide themselves with flesh food. The only important question to consider here is whether in actual experience, or as a result of careful experiment, man can thrive on a mixed diet.

There are two really serious objections to the use of meat. The first has to do with the chemical side. In the digestion of meat there are produced substances that may be injurious to the cells of the body. Some people can throw off these poisonous substances more easily than others, and hence do not suffer from them. Many people, however, accumulate these products until they cause real injury. Moreover, it has been found that bacteria thrive better in the intestines of flesh-eaters than in the intestines of non-flesh-eaters, and the products of the activity of these bacteria may be injurious to many people. Finally, with the use of meat we are more likely to get an excess of protein than we are with the use of exclusively vegetable food. This is a real danger, because any excess

of proteins must be eliminated from the body by the action of the liver and the kidneys, since the body has no way of storing up the surplus.

If we take in too much fat or carbohydrate, most of us are able to convert some of this excess into fat, which is deposited in cells under the skin. A small amount of this fat is not injurious, and may even be helpful. With proteins all that is not used must be oxidized, and the products of these changes are poisonous and so must be thrown off.

The second serious objection to the use of meat is connected with the effect of the practice of killing and dressing animals upon the minds and characters of the people who are engaged in these occupations. Is it true, as has been claimed, that one cannot be a butcher without being brutalized? If it is, have I a right to make use of meat that can be furnished me only at the expense of brutalizing some other human being?

It is probable, at any rate, that most of us can get along with much less meat than we use, and that we would really gain physiologically by reducing the meat in our diet. It is possible that some people depend upon meat more than others; in such cases it is likely that they derive some stimulation from certain substances in the meat rather than better nutrition from the meat itself.

In favor of meat it may be said that their proteins are more easily digested and absorbed by human beings than are most vegetable proteins.¹

139. Brain food. There has been a great deal of confusion and superstition in regard to the use of food for the benefit of special parts of the body. Just as people have recommended beef for muscle and bear fat for hair, so they have recommended fish for brain and celery for nerves. If we recognize that in the process of digestion all carbohydrates are changed to certain comparatively simple sugars, all fats to comparatively simple soaps and glycerin, and all proteins

¹ But the whole question of the relative value of different kinds of proteins is far from settled. Experiments are now under way that should throw light on this subject in the course of a few years (see p. 109).

to comparatively simple nitrogenous compounds, we shall see that it is absurd to claim a specific value for one kind of food in connection with the building of special tissues. All the products of protein, fat, and carbohydrate digestion are distributed without discrimination by the blood, and from this general store all the cells absorb their supplies.

140. Minerals in the food. The growing bones of a child or any other young mammal can be built up only if there is an abundance of lime in the food. Growing children, therefore, should have more lime than adults, just as growing chicks need to be supplied with broken oyster shells or some other form of material containing lime, and just as laying hens need more lime than roosters, since lime is used in the formation of eggshells. Indeed, many farmers and poultry raisers save eggshells to feed back to their poultry. In general, our ordinary food materials contain an abundance of salts in their natural condition, and it is comparatively rare to see a person who suffers for lack of minerals in the diet.

Vitamins. Experiments made since the beginning of the century show that the health of the body cannot be insured by supplying merely proteins, fats, and carbohydrates, with the needed salts and water. In England, Germany, Japan, and this country, animals that were fed on *pure* proteins, fats, and carbohydrates failed to grow properly, or developed abnormal conditions in the nerves or other tissues. When very small quantities of material from milk, grains, eggs, and other natural plant or animal products were added to the diet, the animals were restored to health or resumed their growth. In 1906, the name "accessory food factor" was given to some of these unknown but very important substances thus shown to be present in milk. Since then several of these "unknowns" have been shown to be present, and they have been given the collective name *vitamins*.

Very important for growing babies and children is Vitamin A, which is soluble in fat. This is found in large proportions (although the total amount is extremely small) in cod-liver oil, in fresh butter, in yolk of eggs, in many fresh vegetables, in the fatty part of milk (cream), and in various animal tissues. In a child deprived of Vitamin A, growth is interfered with, especially the formation of bones. "Rickets" is

very frequent among improperly nourished children (see Fig. 35); it can be prevented through suitable diet containing Vitamin A.

Water-soluble Vitamin B can be extracted from the outer coats of rice and other grains. It is present also in yeast, cabbage, onion, spinach, tomatoes, nuts, milk, and other foods. Animals fed upon materials lacking Vitamin B develop a very painful inflammation of the nerves, a disease found in parts of Asia and known as beriberi. It can be avoided and cured by diet containing Vitamin B.



FIG. 35. The importance of suitable diet

The child in these pictures was suffering from defective nutrition. In the first picture it weighed 14 pounds 4 ounces. The second picture was taken eleven weeks later, after expert treatment, when the child weighed 17 pounds 15 ounces. Photographs by Dr. Henry Dwight Chapin, at the Speedwell Society

As has long been known, sailors and others who go for a long time without fresh food are liable to a sick condition called "scurvy." But it is only recently that we have learned that this condition results from the absence of a second water-soluble known as Vitamin C. This is found in oranges, lemons, tomatoes, fresh lettuce, and cabbage, as well as in other fresh fruits and vegetables.

There are many unsolved problems in this field, but we already know enough to realize the importance of insuring to every person a well-balanced diet containing all the essentials.

141. Taste of food. On looking over a bill of fare the different persons in a party are likely to make different selections. And in marketing for the family the mother or housekeeper will usually order a great variety of food articles. The reason for this is that "tastes differ." It is an important practical question to consider whether people should indulge their tastes, and especially whether children should be allowed to eat what they like.

We have been told (p. 89) that it is not wise to depend altogether upon instinct as a guide in the selection of the kinds and in the determination of the amounts of food eaten. And yet we cannot ignore instinct and taste entirely. In the first place, food that is not agreeable to the taste will be of very slight value to a person. Experiments made originally by the great Russian physiologist, Professor Pawlow,¹ and since repeated and extended by others, showed that the secretion of digestive juices in higher animals depends upon the stimulation of nerves connected with the tongue and throat. We have all had the experience of the "mouth watering" when some attractive food is smelled. Stated in other words, this means that when certain nerves are stimulated (in the nasal lining and in the palate), the salivary glands begin to pour forth their special product. Now it is only when these same and certain other nerves are sufficiently stimulated that the *stomach begins to water*, that is, to pour forth the gastric juices from the glands into the stomach cavity.

Gastric juice will digest proteins, in the stomach or in a teacup, without regard to anyone's feelings. Saliva will digest starch, in the mouth or in a tin can, without regard to anyone's feelings. But the glands of the stomach and the glands of the mouth will produce and secrete juices more readily when the palate is pleasantly stimulated than when it is not stimulated. Indeed, under certain conditions the glands of the stomach will not secrete digestive juices at all, although there may be a great quantity of food in the

¹ Pronounced päv'lóf.

stomach waiting to be digested. For these reasons health and happiness require that our eating shall be a pleasure and not a disagreeable necessity.

142. The appetite. We all have a natural liking for sweets. This does not show that all sweet things are good for us, for there are some sweet substances that are actually poisons. But, on the other hand, a "sweet tooth" may indicate that there is need for more carbohydrate than one gets regularly. If the body is in good health, the appetite can usually be depended upon to tell us what to eat and how much, at the dinner table. If food has been poorly prepared and the bad taste of it concealed with sauces and spices, the appetite will become perverted and will certainly not be a safe guide in the selection of food.

Food may be attractive to the palate and yet be quite unsuitable because of its indigestibility. Or food may be suitable for one person and not for another. A little attention to the matter should enable every mother to find out what kinds of food agree with her children and what kinds do not. And a little attention should enable each one of us to find out for himself what it is safe to eat and what it is best to let alone. One person is always made sick by shrimp or fish but has no difficulty with doughnuts or cheese. With another person it is just the other way. No one can tell you whether you can digest beans or not, and you cannot find it out from a book. You have to find out for yourself, and then use your knowledge for your own benefit.

143. Digestibility. Aside from individual peculiarities of the digestive system, however, there are some foods that are more easily digested than others. For example, milk contains the protein, fats, carbohydrates, and salts in a very easily digested form. Meat proteins and fats of all kinds are digested with comparative ease. But the proteins and fats of meat are inclosed within cell walls, the material of which is not so easily digested. In cooking, much of this material is broken

down, but the manner of cooking may have an influence upon the digestion.

144. Cooking. There are three or four primary uses of cooking that can be understood from a biological point of view :

1. Cooking breaks up and softens the cell membranes, thus liberating the proteins, fats, and carbohydrates.¹

2. The chemical changes produced in meats, vegetables, eggs, cereals, etc. by the action of heat result in the formation of substances that are especially attractive to the sense of smell, and thus react favorably on the secretion of digestive juices.

3. The action of heat (with or without moisture) upon starch results in breaking up the starch grains and in making them more easily digested.

4. Cooking has the further effect of destroying any germs of bacteria or other microbes (see Chapter LXXI) that may be present in the raw food, thus lessening the danger of transmitting an infectious disease or a parasite (see p. 341), and making it easier to preserve the food against decay.

Another result of cooking that has only recently received the attention it deserves is the wastefulness involved in certain kinds of cooking. This is a matter that is not strictly biological, although it should be considered in connection with the subject of feeding. One particular kind of waste, however, has biological significance. That is the waste of mineral matters brought about by the boiling of food and then throwing away the water which contains the valuable food salts. Of course, with more scientific cooking these wastes will be avoided, and our food as served to us at the table will contain the necessary minerals, as well as the proteins, fats, and carbohydrates.

145. Food economy. Another important consideration in the selection and preparation of food is the matter of cost. For all practical purposes a few cents' worth of corn meal may

¹ To a certain extent the materials that make up the cell walls in meats become digested and thus contribute to the total food supply. The cellulose that makes up the cell walls of plant tissues cannot be digested in the human body; but it is digested into sugars by the juices of many animals, such as cows and other grass-eaters.

satisfy one's hunger as well as a dollar dinner. It is also true that in the selection of food for a family it is possible to bring about a great deal of saving by comparing the food values and the market values of the various articles, and guiding oneself accordingly.

146. The pleasures of eating. Cattle and guinea pigs and rats can be kept alive indefinitely on a monotonous minimum diet. When the same thing is tried with human beings, they gradually lose those characters that distinguish them from the cattle or the guinea pigs. One of the things that drive men to drink and to drugs is the attempt to make them live like cattle. The cheapest diet is commonly recommended to people who have little of the pleasures of life and little time or training for enjoying the more refined forms of recreation. To these people the comparatively simple pleasures of eating should not be denied. If those who are capable of high thinking on the basis of plain living wish to adopt the simpler diet, there can be no objection; these people do not depend upon the palate to help make life more interesting.

In connection with the question of economy we must consider not merely the money cost or the effort in the preparation of food but the happiness and well-being that result from the preparation and use of the food. It is in this sense that it pays to take some time in setting the table, to make it attractive to the eye, to make it a pleasant place at which to sit and eat. It is doubtless cheaper, in a money sense, to eat standing, each member of the family helping himself to what he wants from a general collection of pots and dishes in the kitchen. But it pays to be human, even in the matter of eating.

CHAPTER XXIII

FOOD HABITS

147. Water with meals. Until a few years ago it was generally considered unwise to take water with meals, because it was assumed that diluting the digestive juices would delay the process of digestion. Experiments have shown, however, that the more water there is in the stomach the more easily will the process of digestion go forward, and the more quickly will the subsequent absorption take place. Students and soldiers who took part in the experiment found that they could easily take a quart of water in the course of a meal, and they were all benefited by the practice. It is very probable that one never drinks too much water. Still there are certain things to guard against.

1. Water must not be allowed to take the place of saliva in softening the food for swallowing. Therefore, water should be taken into the mouth only when there is no food present; drink between courses rather than with the food.

2. The water should not be too cold. In this country the drinking of ice water has become almost a national vice. Water a great deal warmer than ice water can be found quite agreeable; and we shall find that we can drink larger quantities if it is not too cold.

148. How to eat. Anything that arouses unpleasant feelings, as worry, anger, or anxiety, is almost sure to interfere with the normal working of the digestive process. On the other hand, whatever arouses pleasant feelings, whatever puts us into good humor, helps to tone up the digestive organs. It is therefore a wise rule that obtains in some families, not to open letters that come just before or at mealtime; and it is another

good rule not to read the newspapers or to settle unpleasant affairs before a meal. Pleasant conversation, exchange of amusing experiences or anecdotes, are more helpful at mealtime than heated discussions.

There should never be a feeling of hurry about a meal. It is better to take two meals a day quietly and restfully than three meals in a hurry, if time is so pressing.

Rapid eating makes it impossible for sufficient saliva to mix with the food.

Then it makes impossible the breaking up of the food particles, so that the gastric digestion is interfered with.

Rapid eating makes impossible the adequate stimulation of the taste and smell nerves, necessary to bring about secretion of gastric juices.

The time saved by eating rapidly is generally more than paid for by later indigestion.

What has already been said about the use of water at meals and about rapid eating will warn us to chew our food thoroughly and to avoid washing down each mouthful with a drink.

149. When to eat. A young infant has to take food every few hours; he takes but a little at a time, the food is liquid and quickly digested and absorbed, and the child is soon hungry again. Some people have relatively small stomachs, which cannot hold much food at one time; they may have to eat at more frequent intervals. Others can get all they need for a day in two meals, and many men and women have been quite healthy and happy with but a single meal a day.

In the course of experiments made in recent years, in order to find out the best rations for human beings, many of the experimenters discovered that they were in better working condition when they had only two meals a day than when they took three meals. This improvement may have been due to the fact that they reduced the total amount of food, or it may be that by taking only two meals they gave their digestive organs longer intervals of rest.

It is impossible to lay down rules as to the number or regularity of meals. This is something that each one has to settle for himself on the basis of experience. It is probably advantageous to adopt regular hours for meals, and to avoid, so far as possible, interfering with this program either by changing the hours or by eating between meals.

In making a program that will leave a fixed time for each meal, we must consider the other things that are being done during the day. It is well to avoid hard work of any kind immediately after meals. Exertion of the muscles causes an increase of blood-flow to those muscles and a corresponding decrease in the blood-flow to the digestive system. As a result, the secretion of digestive juices is reduced, and the process of digestion is slowed down. The food remains in the stomach a very long time, overworking the muscles of that organ, sometimes to the point of actual distress. Effects of the same kind are produced whether the work done is in the nature of productive labor or merely free play. Similar consequences are found to arise from bathing too soon after a meal; in this case the flow of blood is to the skin, but the effect on the stomach is the same.

150. Health habits. We have seen that we have no direct control over the workings of the digestive system; we must therefore establish habits at the few points where we have indirect control. The first point has to do with eating, and the establishment of suitable eating habits should be our first consideration. The second point at which we have control of the digestive system is in the establishment of habits related to the behavior of the large intestine. And, finally, there are certain general habits of exercise and breathing and sleeping, which, on the one hand, are largely under our control, and which, on the other hand, have an influence on the digestive system.

We may summarize the habits that are of importance to us in this connection; for most of them the reasons have already appeared in the preceding discussion.

1. The selection of food
 - a. For nutrition and balance.
 - b. For digestibility.
 - c. For palatability.
 - d. Proper preparation.
 - e. Proportion of coarse, indigestible elements and bulk.¹
 - f. For laxative elements.
 - g. For suitable quantities.
2. The avoidance of food materials that are personally undesirable, however suitable they may be for others.
3. The avoidance of special sauces and spices as stimulants to the appetite.
4. The observance of fairly regular hours as to eating.
5. Leisurely attitude toward the meal. This would include the taking of a few minutes of rest before eating, when tired, as well as the avoidance of rushing off to work or to play after eating.
6. The establishment of a pleasant frame of mind for the meal, as well as other agreeable surroundings, whenever possible.
7. Thorough mastication of the food before swallowing. This does not mean counting the number of bites that you put into every mouthful; it means having the habit of chewing until the mass in the mouth is in a nearly fluid condition, so that it fairly "swallows itself."
8. Drinking plenty of water, — before meals, between meals, as well as at meals, and before retiring, — but never using it (or any other liquid) to "wash down" food in the mouth.
9. Where outdoor work with the large muscles is not a part of the regular program, exercising (out of doors if possible) a certain amount every day.

¹ Experiments made in a European army many years ago, with a view to finding, if possible, a concentrated ration that contained a maximum of nutrient and a minimum of indigestible and nonusable substance, resulted in showing that people cannot maintain their health on such a diet. The reason for this is that the intestines can be stimulated to do their muscular work only by the mechanical pressure of a mass of substance on the inside. When food is refined to the point where it contains no refuse, or very little, the muscles of the intestines cease their activities. We must therefore have a certain amount of *bulk* in the food, as well as the nutrients. This bulk is supplemented by the vegetables we eat, especially green vegetables, which contain a relatively small proportion of nutrient and a relatively large proportion of cell walls.

10. Deep breathing, through the nose, not a few breaths now and then, but as a regular thing, all the time (see p. 183).
11. Take plenty of sleep *every* night. This is better than sleeping a little most nights, in the hope of raising the average by sleeping later on Sundays or holidays.
12. Emptying the bowels every day, as nearly as possible at a fixed time.

151. Constipation. The importance of this last point has already been suggested (see p. 88), but it is worth emphasizing. The decomposition of the refuse in the large intestine by the action of many species of bacteria gives rise to a number of poisonous substances that are absorbed into the blood if the refuse is not thrown out with sufficient frequency. Moreover, the waste substances poured into the intestine with the bile are also injurious to the cells of the body and should be removed with the other undesirable matter. The absorption of these poisons into the blood and their distribution to the cells of the tissues bring about a real poisoning of the body. This shows itself in a variety of ways. The most common symptoms of constipation—the clogging up of the bowels with the unremoved refuse—are the following:

1. Headaches, especially the kind of headache that seems to hammer at the temples when you bend over.
2. The "blues"—a feeling of general dissatisfaction and grouch, when nothing that you know of has happened to give you cause for dissatisfaction.
3. Drowsiness, although you may have had plenty of sleep within a few hours.
4. A certain "tired feeling" when you have hardly done enough work to account for the tiredness.
5. Loss of appetite and indigestion.
6. A coated, or furred, tongue.

There are many headache powders on the market, and several fortunes have been made selling people various kinds of headache remedies. But the headache powders never cure

people of their trouble. They generally depress the action of the heart so that the circulation is lowered, and you do not feel the *pain* caused by the disturbance of these bowel poisons. But the poisons are still there, and if the bowels are not emptied, more are being manufactured, whether you have a headache or not. The thing to do is to remove the cause of the trouble, not merely hide the damage from yourself.

In the same way you might be cheered up by a stimulant or by an entertainment; but these do not remove the cause of the trouble. In the case of acute constipation one may obtain temporary relief by the use of a physic or an enema. But these should never be used as regular things. Since the chief cause of constipation is neglect of the bowels, the only real cure is the establishing of regular habits of evacuation. Mothers realize how important it is to get infants into regular habits of emptying the bowels, but many of them neglect the children when they are a little older. If regular habits are not established in youth, they are likely never to be fixed at all. It is certain that hundreds of thousands of people in this country suffer from constipation, and that there is no drug or medicine that will cure the disorder.

152. The teeth and their care. One of the commonest causes of indigestion is found in decayed teeth. A number of years ago an examination of thousands of school children showed that in nearly every case of backwardness there was also some physical defect, as of the eyes, ears, or teeth. The surprising thing was that bad condition of the teeth was found in children who were behind in their school work more often than poor eyesight or poor hearing. When we consider the relation of the teeth to digestion, and of digestion to health and vigor, we can well understand why this should be so. People with poor teeth simply get into the habit of swallowing the food without chewing it, and then blame their stomachs or the cook for their miserable feeling or for the poor work they do.

The structure of a human tooth is shown in Fig. 36. The enamel is a hard protective casing. Trouble with the teeth very frequently begins with the breaking of this enamel. The enamel can be cracked by grinding it against some hard substance, as when you try to crack a nut with your teeth; or it may be cracked by sudden changes of temperature. Drinking very cold water or very hot drinks is likely to be one of the ways of cracking the enamel. Picking the teeth with a needle

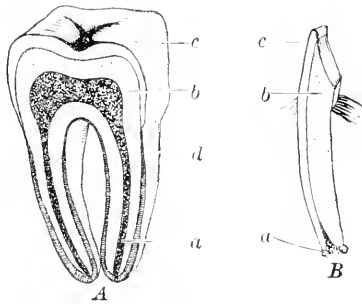

FIG. 36. Structure of mammalian teeth

A, human grinding tooth, showing central pulp cavity (*a*), containing nerves and blood vessels and surrounded by dentine (*b*). The crown is covered with enamel (*c*), and the root with cement (*d*). *B*, gnawing tooth of rabbit, which grows from below as fast as it wears away at the tip. The chisel edge is kept sharp by the dentine wearing away faster than the facing of hard enamel

or some other hard body is also likely to scratch the enamel and thus to open the way for further damage.

In the food that we put into our mouths there are many bacteria, of many kinds. In particles of food that cling to the teeth these bacteria begin their digestive activities, and some of the substances thus produced act upon the enamel, dissolving away this protective cover. Particles of food in the larger cracks, or fluids in the smaller scratches and cracks, permit the action of the bacteria to continue, and

gradually a cavity in the tooth becomes larger and deeper, until it reaches the pulp, and the nerve becomes exposed.

A thorough cleaning of the teeth thus becomes necessary at frequent intervals. The most reasonable time to clean the teeth is immediately after each meal. If you get the habit of doing this, it will postpone the rotting of the teeth a good many years. Unfortunately our business and industry are so arranged that most grown-ups cannot manage to look after their teeth after each meal. The best *one time* a day for

brushing the teeth is just before retiring, that the bacteria may not continue their destructive activities during sleep.

The best cleaning material for the teeth—as for the skin or for clothes—is a good white soap. If you buy a dollar's worth of tooth paste or powder, you get several cents' worth of soap, together with some cheap perfume and a little powder added to *scrub*. The perfume does not help to keep the teeth clean; and it has been questioned whether the powder does not do more harm than good. If we begin with the younger children, we shall find that they can quickly learn to use plain soap on the toothbrush and do not need the fancy-smelling pink addition to make tooth-brushing an agreeable habit.

In brushing the teeth, the motion of the brush should be lengthwise, so as to reach all the spaces between them. If you brush crossways, the depressions along the edges of the teeth will not be reached at all. It is well, also, in setting out to fix a toothbrush habit, to remember that the back teeth and the inner faces of the teeth need to be considered as well as the fronts of the front teeth.

Unfortunately, the use of soap or other alkaline substances causes the salivary glands to secrete *mucin*—the substance that makes the saliva glary or sticky. Now this mucin furnishes a sticky covering for the teeth, in which the bacteria can remain and do their destructive work. Experiments have shown that the use of some weak acid (as citric acid from lemons, or acetic acid from vinegar) stops the secretion of mucin. For those whose glands secrete an excessive amount of mucin, and whose teeth therefore have a sticky coating, there has been recommended the use of *very* dilute vinegar, at least in the last cleaning before going to bed. If the vinegar is used after soap, the latter must first be thoroughly rinsed out with plain water.

Some people need to use on their teeth an antiseptic, or bacteria-killing, mouth wash. Such a mouth wash, however, is to be used in addition to brushing, and not as a substitute.

CHAPTER XXIV

THE SOCIAL SIDE OF THE FOOD PROBLEM

153. Food and water in modern times. When every family lived in a house by itself, at some distance from its neighbors, the water from the well or from the spring back of the barn may have been good enough to use, and there was usually enough of it. But when people came to live in cities, close together, it became impossible to get enough for all needs in the immediate vicinity. Nor was the water they could get good enough, for the refuse of many people and households contaminated the water at its very source. It therefore became necessary for a supply of water to be brought from a distance.

When most of the people lived in the country or in small towns, it was possible for nearly everybody to know how plants and animals were raised for the market. When housekeepers made their own preserves for the winter, they knew what the jars contained.

But as manufacturing industry developed, people came to live more and more in cities; that is, away from the source of the food supplies. Gradually we have reached the point where a very large part of our food comes to us in sealed packages, made we know not where, nor of what materials. You cannot tell by the taste or by the looks of a lot of food taken from a can whether it is nutritious or not; nor can you tell whether it contains any harmful preservative or coloring matter; nor can you tell whether it contains any adulterant.

154. Public regulation. In the case of food, as in the case of water, it soon became necessary for the people of a city or state, acting together through their public officials, to regulate the wares that the buyer was offered. In the case of water even

earlier than in the case of food, definite regulations were adopted, requiring chemical and bacterial tests to be made for the protection of the public. In other words, just as soon as the public realized that the individual could not protect himself, it undertook to protect itself through a public agency.

155. Commerce and food supplies. In addition to changing conditions of manufacture and living, another fact made it necessary for the public to protect the purchaser of foods. Growing commerce has brought to us food products of foreign lands, in regard to which we have no standards and no judgment. As individuals, we know nothing of the nutritive value or the possible dangers of these imported materials. This makes it very easy for dealers and manufacturers to mix cheaper materials with those that already enjoyed a wide market, or to substitute cheaper materials for more expensive ones. Spices and coffee were thus among the first things to be adulterated.

Glucose, which is much cheaper than sugar, can be mixed with jellies, preserves, candies, and other food products containing sugar, thus increasing the bulk and at the same time reducing the cost of a given quantity of finished product.

When it was found that a pretty good imitation of butter could be made out of beef fat, at a cost much lower than the cost of butter, people substituted oleomargarine for butter in cooking and baking foods to sell, thus increasing their profits. And in a similar way cottonseed oil was substituted for, or mixed with, olive oil.

In all these cases no harm was done to the bodies of the people who ate the substitutes or admixtures. Starch and glucose and oleomargarine and cottonseed oil are perfectly harmless and very useful carbohydrates and fats. The harm done was of a commercial kind. People do not like to pay sugar or honey prices for glucose, or butter prices for oleo, or milk prices for water. And the merchant who is selling pure products does not like to compete with adulterated or substituted products; it puts him at a disadvantage in the market and may drive him out altogether.

The first regulations adopted by governments for the control of the manufacture and sale of food products had to do with commercial frauds — the selling of adulterated or misbranded foods. These regulations mean, in effect, that when a person offers to sell you sugar, you should not be obliged to carry your own chemical equipment to the market, and test the wares against substitutions or adulterations.

As the scientists' knowledge about the relation of food to bodily health and efficiency increased, and as our civilization separated people more and more from the sources of their everyday needs, it became necessary for the public, through its official agents, to extend the protection of the buyer still farther. It is not sufficient that we get full measure. It is not sufficient that we get goods correctly labeled. We must be assured that what is offered us is *suitable* for our purposes, and that it is *harmless*.

If the chemists or other scientists can discover cheap substitutes for the familiar fats and carbohydrates and proteins, they are doing mankind a service; they are reducing the cost of living. But we do not care to have the dishonest manufacturer or dealer get all the benefit of these discoveries, while the rest of us go on working as hard as ever, and getting as little out of life as before.

156. Food dangers. In more recent years a new set of problems has arisen in connection with the protection of the public food supply. This has to do with the sale of food that may be decomposed and thus unfit for food, or with the sale of food that has been made dangerous by contamination with disease-breeding bacteria. The former is illustrated in the canning and packing industries; the latter in the commerce in fresh milk, meat, fish, eggs, vegetables, and so forth.

In the canning and packing of meats, fruits, vegetables, fish, and so on, food that is not strictly fresh has often been put into the containers, with its odor concealed by the use of spices or other flavoring substances. Decomposed food is a real source of danger, for it contains, in addition to the proteins,

fats, and carbohydrates for which we buy the food, poisons produced by the rotting, or decay. Regulations concerning the sale of prepared foods in which such material is present have been adopted by the governments of nearly all the states; and the shipment of such preparations from one state to another is prohibited by federal laws. Many cities also have local regulations that enable the officials to seize and destroy any such unsuitable food which they may find, in addition to penalizing the dealers or manufacturers by means of fines or imprisonment.

157. Use of preservatives. The use of preservatives in canned or prepared foods, such as benzoate of soda, has been under discussion for a long time, and many careful experiments have been made to discover the possible injury that such materials may cause. It was found in one set of experiments that although benzoate of soda is injurious if taken in large quantities, one would have to eat a peck or more of catsup containing this preservative before he took in enough to hurt him. The objection, however, to the use of these preservatives is not that these substances are in themselves harmful. The objection is that their use makes possible the admixture of slightly decomposed vegetables into the manufactured product. Without the use of the preservatives the manufacturer would be compelled to use only clean, fresh material. At the present time our federal laws protect us in this matter only to the extent of requiring the manufacturer to state on the outside of the package what amount, if any, of preservative is present. But the buyer has to take the chance of seeing this warning on the package, and of knowing its full meaning when he does see it.

In the case of milk, preservatives are not to be tolerated, since the only kinds that can be used without the buyer's detecting them are apt to be injurious in themselves.

158. Food protection. The second class of dangers referred to above, that of infection by disease germs, is a purely local problem, since it has to do with the food brought to the

consumer day by day. Many cities have adopted regulations requiring dealers to protect their wares against exposure to dust, insects, or other sources of infection. They have regulations as to refrigeration of meats and fresh fish. And most elaborate regulations have been adopted in regard to milk. Since milk is the most easily spoiled of all our foods, and since it is at the same time so indispensable for many people, especially children and infants and sick people, it is one that calls for strict protection against contamination and against adulteration. On page 127 are given the milk standards and the milk rules of many progressive cities. You will see that there is a biological reason for every rule in the list.

159. The public educates itself. A part of the public's danger lies in its ignorance. New facts and new problems are appearing every day. While the public tries to educate all of its children through the public schools, it is impossible to teach in the schools all that the children will need to know, and it is certainly impossible to tell in advance what they will need to know of the discoveries that are still to be made. Every progressive community — whether it be a city, a state, or a nation — seeks to advance important knowledge and to spread it among its members as quickly as possible. The state and local departments of health, the experiment stations, and the schools are therefore all at work increasing the protection of the public by means of bulletins, lectures, announcements to the newspapers, and posters.

In extreme cases the government will adopt prohibitive legislation; that is, laws that prohibit the sale of articles known to be injurious. We can no longer say, "I have a right to eat or drink what I like." Of course it is no one's business but my own if I prefer ice cream to apple dumpling; and it hardly seems fair for the government to tell me that I may not eat ice cream, when I feel like it and am able to pay for it. But in the case of certain drugs and drinks, the question is rather one of protecting people against their own ignorance or against vicious habits and customs (see p. 257, on drug laws, etc.).

MILK STANDARDS

I. CHEMICAL STANDARDS

- a.* Milk must not contain more than 88.5 per cent of water.
- b.* Milk must contain not less than 11.5 per cent of milk solids.
- c.* Milk must contain not less than 3 per cent of fats.
- d.* Milk must not be drawn from cow within fifteen days before nor within five days after calving.
- e.* Milk must not be diluted with water or other liquid, or be otherwise adulterated with foreign substance.

II. BACTERIOLOGICAL STANDARDS

- a.* All cows must be in good physical condition and tested at least once a year with tuberculin, tagged, and registered with the authorities within three days.
- b.* Dairy conditions and methods must be scored and the score registered or certified.
- c.* The milk must be tested and certified from time to time.

Grade A Milk (Raw): Must not contain more than 100,000 bacteria to the cubic centimeter, and must come from dairies that score at least 75 per cent.

Grade A Milk (Pasteurized): Must not contain more than 200,000 bacteria per cubic centimeter before pasteurization, nor more than 30,000 between pasteurization and delivery to consumer, and must come from dairies that score at least 70 per cent.

Grade B Milk (Raw): Must not contain more than 300,000 bacteria per cubic centimeter, and must come from dairies that score at least 60 per cent.

Grade B Milk (Pasteurized): Must not contain more than 1,000,000 bacteria per cubic centimeter before pasteurization, nor more than 100,000 on delivery to consumer, and must come from dairies that score at least 55 per cent.

These standards, with slight variations, have been adopted by boards of health and by dairy associations in the most progressive cities all over the country.

A further step in the public use of special knowledge is illustrated by laws specifying that workers in stores and factories must be allowed at least an hour for lunch every day. Such a law means that the agents of the public have recognized the importance, for the health of the people, of an opportunity to eat the midday meal without haste. A further regulation requires the provision, in factories and large establishments, of suitable special rooms in which the workers may eat their meals in surroundings that are more pleasant than the sight of the machines or piles of goods. Another regulation requires the provision of suitable washing facilities, to enable the workers to come to their food with clean hands. Ordinarily these arrangements are not of great importance to the manufacturer or employer; if his workers get sick he can always get others. But the health of the people is important to themselves, and thus to the state. Yet it has been found that whenever the conditions for eating lunch have been greatly improved in any factory or store, there was an immediate improvement in the character of the work, so that what many employers did reluctantly under compulsion from the state has turned out to be profitable to them. However, such regulations are made in recognition of the importance of human life and health, and not in consideration of making greater profits.

As the public comes to know more and more about the relation between proper feeding and right living, it will no doubt extend its community activity in food matters farther and farther. For some time to come the food question to receive most discussion is that of the school lunch. It has been found that thousands of children in the larger cities come to school improperly or insufficiently nourished. The argument is made that the money spent in the effort to educate such children is all wasted, and that in order to save all this money it is necessary to put the children into condition to profit from the efforts of the teachers. This means that the school should supervise, or even provide the means for,

the feeding of children, at least so far as successful school work depends upon proper feeding.

160. National food resources. With the growth of population every nation comes to a point at which it must look ahead to insure supplies of food for the coming generation — or suffer in time from famine or national decay. It is for this reason that our national government devotes so much attention to the question of food resources. Scientists are constantly engaged in solving problems connected with (1) the production of more food on a given area, (2) utilizing materials to better and better advantage, (3) finding new sources for food, and (4) preventing food from being wasted.

Advances in chemical and biological knowledge have enabled us to find new methods for preserving food for long periods. This makes possible a cheapening of food supplies in two ways: (1) It is possible to send food a long distance, from regions in which it is very abundant to cities and countries where food is not so easily raised. (2) It enables us to keep the bulk of large crops for a longer period. The condensation or drying of milk, for example, makes the use of milk possible in places where cows cannot be kept, and makes the surplus of the summer's milk available in the winter. As a Frenchman once said, "The box of dried milk is a cow in the cupboard."

A good example of cheapening food by the application of chemical knowledge has already been referred to (p. 123) in connection with the extension of the use of cottonseed oil. A later advance consists in treating this oil with hydrogen under the influence of electricity, thereby producing, at less than half the cost of butter, a fine solid fat which has the same food value as butter, except that it has no flavor. This fat has the advantage over butter that it does not easily turn rancid.

Another direction in which government agencies work to improve or increase our food resources is illustrated by the production of new varieties of plants and animals having special desirable characteristics — as cows with large milk-yield,

or better wheat, or more corn to the acre, as described in the chapter on plant and animal breeding (Chapter LXXXI).

The entrance of the United States into the Great War has made us all aware of the importance of (1) more definite knowledge of national food resources and (2) more systematic control of production, distribution, and utilization of food supplies.

Arrangements were made to record every prospective bushel of grain or potatoes, of every head of cattle, of every catch of fish. Bulletins and proclamations were issued broadcast, instructing all people how to get the most out of the food materials that they had, how to save every usable scrap of organic matter, how to make every square yard of cultivated ground yield more, how to preserve the food that could not be used up immediately. Canning and drying demonstrations, as well as cooking and gardening demonstrations, were made in all parts of the country, and for the first time in history a whole nation was brought together to face the food problem as a single family.

In connection with this great national need, the problem of food distribution has come to the front as never before. We now see that it is not sufficient merely to provide warehouses and transportation for the year's production. It is necessary also to see that every child and every adult finds it possible to obtain an adequate supply of nourishment. It is more important to the nation that every living unit be kept in good living condition than that a few individuals make large profits out of speculation in the needs of the rest of us. For these reasons we may expect the regulations inaugurated under the stress of war to be continued in time of peace, to the point where our knowledge and our skill insure the people of the nation the material foundations for their well-being; namely, their "daily bread." In England it has already become a common saying that "all must have bread before any have cake."

CHAPTER XXV

STIMULANTS, NARCOTICS, AND POISONS

161. "Getting used." There are many kinds of fish that live in salt water only, and there are many kinds that live in fresh water only. There are some species, however, that can be made to live in either salt or fresh water. Still, if we took one of these fish out of the ocean and placed it in fresh water, it would soon die. Or if we took a live one from fresh water and put it into salt water, it would soon die. But if we slowly increased the amount of salt in the fresh water, we could gradually bring the water to the composition of the ocean, and the fish would remain alive. In the same way we could gradually add fresh water to a tank of sea water, until there was a very small proportion of salt in the mixture, then transfer our fish to fresh water, and it would remain alive.

In a case of this kind we say that the animal "gets used" to living in the new conditions. This illustrates a pretty general fact about protoplasm, or about living things. It is possible for living things to *get used* to new conditions of temperature, or of light, or of chemicals, or of food. This does not mean that every living thing can come to live in any kind of surroundings whatever; we know that is not true. We know that birds cannot get used to living in water, or that fish cannot get used to living in the air; we know that plants and animals cannot get used to living without proteins or without salts. We understand simply that we can change our conditions of living to a certain degree or in certain directions, and still remain alive.

Arsenic is a violent poison for all kinds of protoplasm. It is used for killing animals as well as plants, as in fighting many kinds of insects and many kinds of fungi. A very small

amount of it will kill a person or a rabbit.¹ In experiments this substance was given to rabbits in very small quantities,— a fraction of the quantity that it would take to kill. After a few days the animals were given a little more. The dose was gradually increased until the animals had become so accustomed to the substance that they could stand several times the ordinary fatal dose. The arsenic acts upon the protoplasm of the nerves or muscles in such a way as to put the animal in a state of *tonus*—that is, the way one feels when one is "all on edge," ready to jump or scream on the slightest provocation. The rabbits treated with arsenic thus became extremely sensitive to the slightest disturbance; they would jump on hearing the faintest sound, or on seeing the slightest movement, or the passing of a shadow. But the most curious result was that after animals had been treated with the poison in this way for a considerable time, *it was impossible for them to live without it*. If the drug was omitted from their daily rations, they quickly died.

162. Action of drugs. It seems that when any substance out of the ordinary gets into the protoplasm, it may behave in one of three ways. Either it remains without any effect on the protoplasm, or it combines chemically with one or more of the substances in the cell. In the latter case the partial removal of the protoplasm material either depresses the action of the living substance or makes it go faster.

163. Stimulants and narcotics. Anything that changes the condition of the protein, or removes fat, or hastens oxidation—or stops oxidation—must modify the action of the living protoplasm. A substance that makes protoplasm work harder or faster is called a *stimulant*. One that slows or depresses the activity of protoplasm is called a *narcotic*. Both stimulants and narcotics are therefore *poisons*, since the final effect of either may be to stop the action of protoplasm permanently.

¹ Strangely enough, a child can stand more arsenic than an adult.

CHAPTER XXVI

ALCOHOL AND HEALTH

164. An old acquaintance. One of the oldest stimulants known to man is alcohol. This is a compound of carbon, hydrogen, and oxygen (C_2H_5OH) commonly produced by the action of the yeast plant (see pp. 291–292) on sugars.

The ancients found that when juices of fruit, or malted grain (see p. 78) in water, were allowed to stand for some time, they developed new flavors and tastes, and that some of them also acquired the peculiar property of making the drinker feel very much elated. In time the making of alcoholic drinks developed into special trades, and in modern times into vast industries. It is only during the past forty odd years that we have come to understand just what happens in these fermenting liquids, largely on the basis of the chemical and biological investigations started by Louis Pasteur.

165. Is alcohol injurious? It is still more recently that we have come to understand what it is that happens when alcohol or alcoholic liquors are taken into the body of an animal.

The custom of drinking these beverages is so old, and the number of people who are directly or indirectly interested in keeping up their manufacture and sale is so large,¹ that it is naturally difficult to spread

¹ In this country alone there were over two million people dependent for their living upon the manufacture and sale and distribution of various kinds of alcoholic beverages when we entered the Great War. This included people who were engaged in the raising of barley and rye and corn and other plant materials that are used in the manufacture, chemists and engineers, makers of machinery, workers in the building trades, carpenters and cabinetmakers, machinists and mechanics of many kinds, who were engaged in the making and repairing of vehicles used in connection with the business, drivers and teamsters, bottle makers, and so on. Almost every line of trade had a portion of its workers dependent upon the liquor industry.

a true understanding of the known facts. On the other hand, there are large numbers of people who have seen certain evil effects of the drink habits, and these are so bitter in their attacks on the use of alcohol that they give the impression of being "cranks," so that many

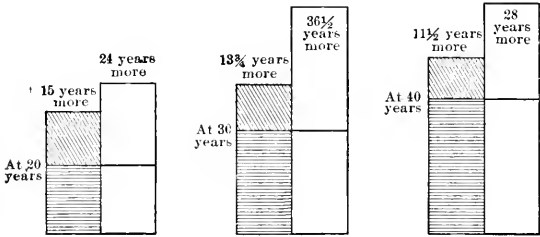

FIG. 37. Alcohol and expectation of life

At every age the abstainers (white) have the chance of longer additional life than the moderate drinkers (shaded)

reasonable people refuse to take them seriously.

Another difficulty about judging the good or harm of alcoholic drinks from ordinary observation is the fact that people differ so much in their sensitiveness and

in their resistance. We may see hundreds of people who have grown old, with the drink habit acquired many years before. You cannot show that these people have been hurt by the drink. On the other hand, a young person with great promise of future achievement is ruined in a short while by becoming addicted to drink.

Is alcohol poison or not? If it is, under what conditions or in what amounts is it a poison? Is it helpful to some kinds of people? We cannot answer

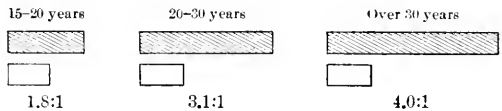

FIG. 38. Alcohol and the chances of death

The chances of dying at any given time are from 1.8 to 4 times as great for drinkers (shaded) as for non-drinkers (white)

these questions offhand, *from our ordinary every-day experience*. We must therefore do two things:

1. We must bring together the experience of thousands and thousands of people;
2. We must make special experiments.

The experiences of large numbers of people have been made available in recent years by the study of the records of

insurance companies that have kept a note of the drink habits of their policyholders for many years past. These records show that there is a *measurable* difference between those who use alcohol and those who do not, with respect to at least two things: Those who never use alcohol have (1) a measurably greater chance to survive infectious diseases and (2) a measurably greater average length of life.

Hospital records have shown again and again that non-users of alcohol have a measurable advantage over users in at least two respects:

1. They have a better chance to survive infectious diseases (Fig. 39); and

2. They have a better chance to recover from the effects of surgical operations.

Railway experience has shown that non-users of alcohol are measurably better than drinkers in the avoidance of accidents.

This naturally is of great concern to the public at large.

166. Alcohol and digestion. It has been found that small quantities of alcohol stimulate the secretion of gastric juice. But the presence of alcohol restrains the fermenting action of the pepsin. The advantages of alcohol with meals in stimulating the flow of digestive juices is therefore offset by the effect on the digestive process proper.¹ In larger quantities alcohol tends to dry up the mucus cells of the lining of the digestive tube and to make the glands less sensitive; this may lead to dyspepsia and other forms of indigestion.

¹ Experiments have shown that in the use of various liquors the alcohol is not the only constituent that may have an effect upon the stomach and the other organs. Wines and whiskies especially contain a large number of oils and vegetable extractives that give color and flavor to the drink; some of these have been shown to have a decided effect on the workings of the body.

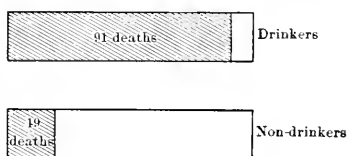

FIG. 39. Alcohol and infectious diseases

In the cholera epidemic in Glasgow (1847-1849) the hospital records showed that a larger proportion died among drinkers than among abstainers

167. Alcohol and work. Experiments made with lower animals, and with muscles taken from the bodies of animals, showed that in small quantities alcohol has a slight stimulating effect. But when the use of alcohol is continued, muscular activity is actually reduced. The results of these experiments, made on dogs and on students and soldiers, are in agreement with the observations of army officers in Germany, in this country, and in South Africa (British army), which agreed in the conclusion that while a small quantity of alcoholic drink at first stimulated the soldiers to brisker marching, the effect wore off in about three miles (less than an hour) and that they were then less able to continue the march than the soldiers who had not taken alcohol. Where dogs were used in the experiments, the total amount of muscular activity of the alcoholic dogs was considerably less than that of the non-alcoholic ones. The total work and the endurance are therefore reduced by the use of alcohol. One point worth noting here is that *although the first effect is to make the action more vigorous, the after effect more than counterbalances the gain.* This will be referred to again later.

CHAPTER XXVII

ALCOHOL AND SOCIETY

168. Why do people drink? Many find it hard to understand why it is that alcohol drinking continues in spite of all that has been done to discourage the practice. Investigations show that most of those who have the drink habit began to drink rather early in life (Fig. 40). The reasons for beginning at all are various, but a few stand out prominently.

1. There is the example of parents and associates. If all the people at home and all who come to visit take a little nip with every meal, the children will come to consider this the proper and natural thing to do. They learn just as readily to shovel food into the mouth with the knife, or to sip the soup quietly. So far as the young people are concerned, there is nothing necessarily wrong or right about any of the things they see going on at home day after day.

2. Then, some people begin by taking alcohol-containing drinks as a "medicine" and get the habit. In most of such cases the victims are not aware either of the presence of the alcohol in the medicine or of the danger of the drink. They take the medicine because a friend who "had the same trouble" recommends it, or because it has been advertised to cure all the imaginable diseases. But when they get used to it, they feel that they cannot get along without it; and indeed they do suffer without it.

3. Many people take to drink for the deliberate purpose of "drowning their sorrows." It is certain that as alcohol has the effect of weakening the attention, so it will help a person *forget* what has been on his mind for some time; and if one has had worries or sorrow on his mind, we can understand

how he might be tempted to take something that would make him stop caring, if only for a little while.

4. Many other persons are driven to resort to stimulants because of the unsatisfactory condition of their nutrition. Food that is badly cooked or otherwise improperly prepared, malnutrition, indigestion, and so on alter a person's appetite so that he is glad to try almost anything that his acquaintances recommend, and alcoholic drink is more commonly recommended by our well-meaning but ignorant friends than any other one thing, as a remedy for all sorts of ailments.

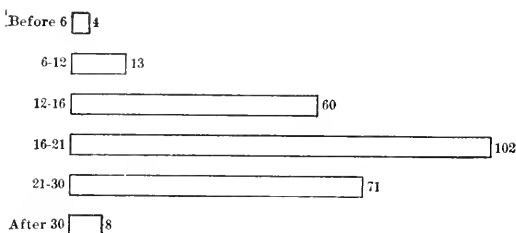

FIG. 40. When the drink habit is formed

Dr. Alexander Lambert found the ages at which 258 alcoholic patients in Bellevue Hospital, New York, acquired the drink habit

5. Many people resort to drink in order to take away the sense of tiredness after a hard day's work; it "spruces" them up a bit, and the sensations which result are gratifying for the time being.

6. By far the largest single cause of beginning the drink habit is found in man's natural sociability. Up to a certain stage of development every person has a strong impulse to do as he sees others doing. This is not simply blind imitation, but a genuine sympathy with one's fellows, and a desire to share in their activities and feelings. A young fellow may drink because it seems to him to be a manly thing to do, since he sees so many men and older boys doing it. Or he may desire to be "in with" people. No one likes to be considered "out of it." And many a young fellow who has been taught the dangers of drink has not the self-reliance and the backbone to say No! when the other fellows urge him on or even jeer at him for being a "sissy." The exaltation of

spirits that many attribute to the drink, when they have been drinking in company, is probably due in reality to the stimulation that comes from doing things together with the others, just the excitement of sociability. But since most young men have not discovered a way of getting this excitement except by drinking together, and since this excitement is certainly pleasant — why, they go and drink (Fig. 41).

7. In addition to these mental and physiological facts that lead people to drink we must mention also the economic fact that there are hundreds of thousands of people who find it to their interest to encourage others to drink. By means of alluring advertisements, by means of suggestions, by means of

53% Sociability	12% Dull Misery	9% Medic- inal Prepara- tions	5% Home Example and Influence	21% Other Causes
--------------------	-----------------------	---	-------------------------------------	---------------------

FIG. 41. Why people begin to drink

This diagram shows the result of an inquiry among a large number of people addicted to drink

attractive drinking places, they lead people on until these get the habit; after that they do not need to be encouraged. It is the *profit* that so many make out of the liquor business that makes them lead the others on.

169. Fighting the drink evil. The important things, in dealing with a large problem like the drink question, are those that go back to the *causes*.

Alcohol habits resulting from the use of medicines are being prevented in several ways. Many of the patent medicines so widely advertised in the past were not only worthless for the curing of the diseases they were bought for, but they were found in very many cases to be worse than useless, for they contained alcohol, or other habit-forming substances — that is, substances the use of which created a desire for more. People are learning the dangers of these "medicines," and the better classes

of newspapers and magazines no longer advertise them. Physicians too are warning their patients against the use of these dangerous preparations, and, when prescribing medicines, they are more careful to consider the danger of the formation of alcohol or other drug habits.

People who look to liquor as a means of "drowning their sorrows" can be helped only by teaching them a better way of meeting the difficulties of life. Liquor does not remove trouble, and most people are intelligent enough to see that. We must do what we can to diminish the causes of suffering and worry; but there will always remain some that cannot be prevented.

Better cooking, better food selection, better habits of eating, knowledge of and interest in the laws of health, and the opportunity to acquire health habits, better conditions of work, more leisure, and training for a sensible use of that leisure — these are the things that will take the place of alcoholic drink. Or, rather, they will remove much of the temptation and occasion to acquire the drink habit.

The tremendous amount of drinking that is caused by man's sociability is to be remedied not by trying to make men less sociable but by teaching people how to be sociable in a more profitable way, and by giving them opportunities to meet and enjoy each other's company outside the saloon or the drinking club. Recreation centers maintained in the public schools, clubrooms in churches and settlements, reading rooms, gymnasiums, athletic fields, and similar places furnish the best antidote to the saloon.

Finally, all the preaching against drinking will have to meet the clever urgings of those who are interested in selling liquors. So long as men can find a profit in selling alcohol, men will be induced to buy it. The only way to stop this traffic, as traffic, is to take the profit out of it. This has been done by way of experiment in Sweden and Norway; and wherever the selling of liquor has been separated from the profit, the amount of drinking has been very quickly diminished.

170. The social attitude toward alcohol. Where in former years it was considered very elegant to have wines and other liquors at dinners and banquets, more and more people are learning that we can be quite as elegant without trying to see how much we can drink before showing the effects. In former years it was considered almost indispensable to have liquors in which to drink the health of kings and presidents and brides and so on. Nowadays, when more and more people are coming to know that these drinks add to the unhealth of the drinkers (whatever the effects may be upon the person toasted), we are becoming content to abandon the custom of drinking a health with alcohol.

171. The economic side. The movement against alcohol is still more marked in industry. Many railroad companies have gradually made it impossible for drinkers to get employment with them. At first they prohibited the drinking of alcoholic liquors by employees *while on duty*. Then they made it a cause of instant dismissal for an employee to be found *drunk at any time*. Then they made it a cause for dismissal for an employee to *go into a drinking place* with his uniform on. Now they refuse to take on *workers who drink at all*. The same is true of large manufacturers, who have found that even moderate drinkers are less reliable, on the average, than total abstainers. And the insurance companies are coming either to reject the applications of people who drink or to charge them a higher rate on their insurance.

These social and economic forces are doing more to discourage drinking customs than was accomplished in all the years of preaching against the evils of drink. The reason for this we can see when we consider why people take to drink, in the first place, and why they do not stop when they have been told of the evils.

The experience of Russia in the Great War will do much toward eliminating the drink evil from modern life. Shortly after the outbreak of the war the manufacture and sale of

whisky was stopped by the Russian government, on the recommendation of the military authorities, because the drink was found to interfere with the efficiency of the soldiers. Since the government there had a monopoly of the industry, it was a comparatively simple matter to bring about the change. In spite of the many years of custom and habit, the sudden withdrawal of alcohol brought about quick adjustments in the form of better workmanship and happier living, even during the progress of the war. Restrictions were placed upon the manufacture and consumption of alcohol in the other warring countries. In this country the chief problem seemed to center at first about the wisdom of permitting so much grain and other food materials to be converted into alcoholic beverages while we were confronted with a shortage of essential food-stuffs. Later it became necessary to prohibit the manufacture of alcoholic drinks both to save the material and men for more urgent work and to protect military and civil workers from the effects of alcohol.

The war experience no doubt had an important influence upon the decision of American legislatures to adopt the prohibition amendment to the Constitution.

CHAPTER XXVIII

AIR AND LIFE

172. Energesis. The activity of protoplasm is made possible by a chemical process that sets free heat, or light, or motion, or some other form of energy. In this process oxygen is usually concerned, and it may be called *energesis*, or "energy making."

173. Life without air. In the yeast and in certain other simple plants there are ferments that bring about the breaking down of carbohydrates into simpler compounds, as alcohol and carbon dioxid, in the absence of oxygen. Such organisms are called *anaërobic*; that is, "living without air." The carbon dioxid given off by anaërobes, although not the direct result of oxidation, is still a by-product of *energesis*.¹

The German physiologist Pflüger placed a live frog in a vacuum and found that the animal continued to give off carbon dioxid. This showed that the carbon dioxid given off by a living organism is not *directly* related to the oxygen taken in. And this has been shown over and over again by means of careful experiments, in which the gas exchange was accurately measured.

174. Oxygen in *energesis*. But if the oxygen does not combine with the carbon and hydrogen of the protoplasm compounds, what has it to do with the chemical processes in a living cell? It seems that the chemical changes can take place only in the presence of water, and that under the

¹ We can perhaps form a picture of anaërobic *energesis* by comparing the chemical process to what happens when a pile of blocks is caused to break down by the removal of one or two of the supporting blocks. As the structure falls down into simpler combinations, a great deal of energy may be set free.

influence of certain ferments the fats or carbohydrates in the protoplasm break up, forming simpler compounds. But these processes can continue only to a certain point unless new oxygen is constantly supplied.

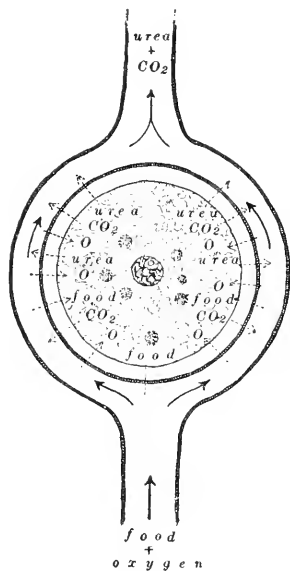

FIG. 42. Cell respiration

In one of the higher animals each cell receives oxygen, as well as food, by diffusion from the surrounding fluids, which in turn communicate with the blood stream. Each cell throws out into the blood stream carbon dioxide, urea, and other products of protoplasm activity by diffusion through the membrane

175. Breathing. Strictly speaking, *breathing* is a process of gas exchange,—the taking in of oxygen and the giving off of carbon dioxide. *Breathing*, or respiration, makes *oxidation*, or energesis, possible; but they are not the same. In the lowest plants and animals, which get their oxygen directly from the surrounding air or water by osmosis, and give off their carbon dioxide directly to the surrounding medium, respiration and oxidation are indeed closely connected in space and in time. But in higher, more complex plants and animals there is sometimes a considerable separation between the two processes, as we shall see.

176. Cell respiration. In an organism made up of very many cells the cells that are farthest from the surface must necessarily get their oxygen supply in some indirect way. In the interior of a leaf we have seen that there is a constant circulation of air among the cells, the spaces between the cells being connected with the outside air by way of the stomates (p. 71). In the young twigs the epidermis also carries stomates that connect with the intercellular spaces below the surface. In the older twigs, however, in which the bark formation has gone on for some time, the

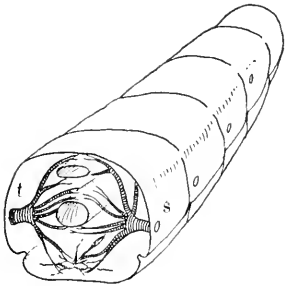

FIG. 43. Breathing tubes in insects

s, the spiracles in the side of the body, opening into the tracheæ *t*, which branch repeatedly and bring air to all the tissues

live cells beneath the bark get their oxygen supply by way of the *lenticels* (see Fig. 24), which open to the exterior and connect with passages that carry air to the cambium, or growing layer. Since the cells of the plant use comparatively small amounts of oxygen, they can get enough from the air that diffuses slowly through these openings and passages. The carbon dioxide given off by cells diffuses to the exterior along the same paths (Fig. 42).

In insects, which use relatively large amounts of oxygen, the cells in the interior of the body get their supplies from very delicate tubes that branch into all parts and connect with the outside through little openings arranged along the sides (see Fig. 43). The movements of the body, by compressing and releasing these tubes, aid in the circulation. In some insects, as the common locust, there are rhythmic movements that alternately empty and fill the air pipes, thus accelerating the diffusion of oxygen and the removal of carbon dioxide.

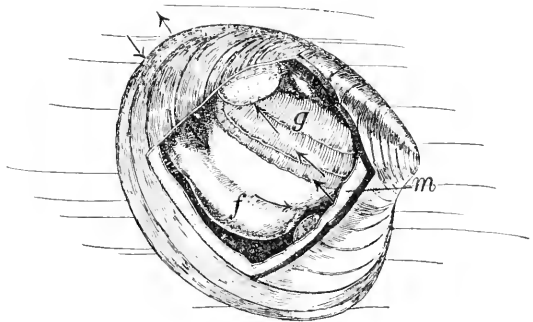

FIG. 44. How the clam breathes

The water inside the shell is kept in constant circulation by the vibration of cilia which cover the whole surface of the body and the lining of the mantle *m*. The current of water (indicated by the arrows) flows forward toward the foot *f*, up past the mouth, and backward over and between the gills *g*. In the gills an exchange of gases takes place between the blood and the flowing water

In all the animals that have blood, excepting only the insects, the respiration of the interior cells is related to the blood. That is, the cells get their oxygen from the blood, and they discharge their carbon dioxide to the blood (see Chapter XXXIV).

177. Respiration and blood. In all such animals we therefore apply the word *respiration* to the process by which the air is brought from the outside to the blood and the carbon dioxide is thrown out. The simplest kind of blood respiration

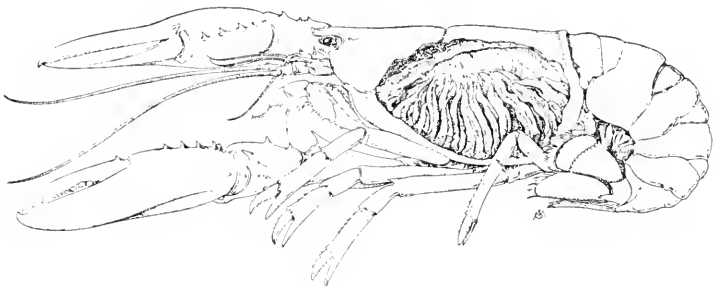

FIG. 45. How the lobster breathes

The featherlike gills of these crustaceans are protected by an extension of shell which incloses them almost completely. By the action of appendages connected with the mouth organs a constant current of water is made to pass over the gills through the space under the shield, moving from the back edge forward

is found in such animals as the earthworm. In this the respiration takes place by osmosis through the moist epidermis, or skin. In some worms there are extensions of the skin surface into little outgrowths, called *gills*. In clams and oysters there are special outgrowths that multiply the breathing surface in much the same way (Fig. 44). In the lobster, crab, crayfish, and related animals there are special structures in which there is a great deal of surface in a comparatively small space, crowded together in a particular region of the body (Fig. 45).

When we come to animals with backbones, we find that the breathing organs are connected with the food pipe, so that all of them can, and many of them do, breathe through the

mouth. In the fishes the water carrying oxygen in solution is taken into the mouth; but when it gets into the throat, instead of being swallowed into the gullet it is forced out through a series of openings in the sides of the pharynx and passes over the gills. The gills are fine, feathery structures

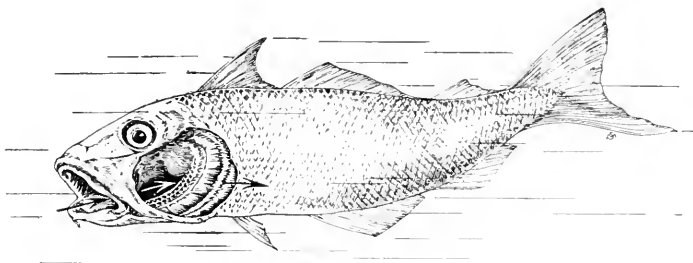

FIG. 46. How the haddock breathes

In the fishes the gills are arranged on arches along both sides of the pharynx. Water is taken through the mouth and passes over the gills and out again, as indicated by the arrows

containing many delicate blood vessels. As the water passes over the gills the oxygen in solution diffuses into the blood from the surrounding water (see Fig. 46). In the bony fishes the gill-slits and the gills are covered over by a special plate-like shield.

In the amphibians the adults breathe the air into the mouth and swallow it into the *lungs*, and all the higher vertebrates breathe by means of lungs.

CHAPTER XXIX

BREATHING IN MAN

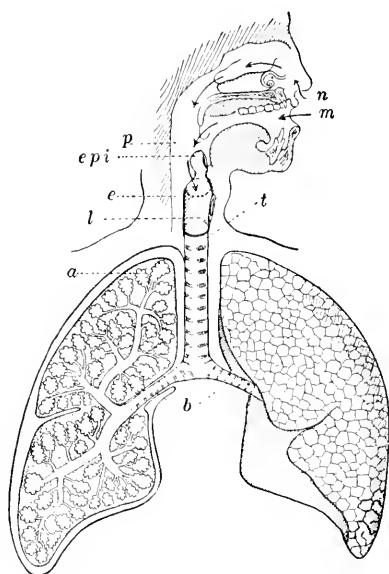

FIG. 47. The human lungs

The arrows show the course of air from the outside. *m*, mouth; *n*, nostrils; *f*, pharynx; *l*, larynx; *t*, trachea; *b*, bronchi. The right lung is shown cut open; the bronchi branch again and again, the last tubules ending in delicate expansions, *a*, the air cells, or sacs; *epi*, the epiglottis, which closes over the air pipe when food passes from the pharynx to the esophagus *e*

178. The lungs. Our lungs are two soft, rather complex bags that are suspended in the thorax, or chest cavity, and are connected with the pharynx (Fig. 28, *b*) by means of a tube called the *trachea*. This windpipe branches again and again, and ends in thousands of tiny chambers lined with a layer of thin-walled cells in contact with very fine blood vessels. The gas exchange between the outside air and the blood takes place through the lining of these small air chambers, which constitute the working surface of the lungs. The act of breathing is thus a process of ventilating or changing the gas contents of the inside of these chambers (see Fig. 47).

179. The process of breathing. The lungs, consisting as they do of air passages and air chambers, and having no muscular tissue in their structure, are incapable of carrying on any

movements. The ventilation of the lungs is brought about by the action of muscles in organs outside the lungs. There are two sets of organs that are concerned in these movements: the ribs, with their connected muscles, and the *diaphragm* (see Fig. 48).

When the muscles of the ribs and of the diaphragm relax, the chest cavity shrinks, and this forces the lungs to collapse, driving the air out. By the alternate expansion and contraction of the chest, *inspiration* and *expiration*, the two movements of air in *respiration*, are brought about.

The *external* respiration of the body consists of (1) the muscular movements of the ribs and the diaphragm; (2) the air movements into and out of the lungs; and (3) the osmotic movements of gases into and out of the blood, through the lining of the air cells.

The *internal* respiration of the body cells consists of the gas exchange between the cells and the blood or lymph. Internal and external respiration are related to the *vital* process of *energesis*.

180. Control of breathing. When you wish to do so, you may hold your breath for a minute or two; you may breathe faster or slower; you may breathe with your diaphragm, holding your chest wall nearly rigid, or you may breathe with your chest, keeping the abdomen almost immovable. Nevertheless the process of breathing, as it is carried on hour by hour and day by day

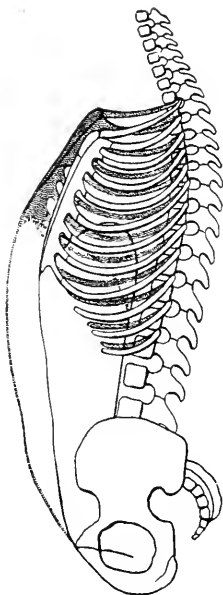

FIG. 48. The movements of breathing in man

When the muscular partition (called the *diaphragm*) between the chest cavity and the abdominal cavity is pulled down, the chest cavity is enlarged. When the ribs are raised, the chest cavity is also enlarged. The rib muscles and the diaphragm normally work in unison, alternately expanding and contracting the chest cavity. The shaded portion of the diagram shows the expanded condition — ribs raised and diaphragm lowered

is an unconscious and an involuntary process. The *way* you breathe is entirely a matter of habit and surroundings.

181. Nose-breathing and mouth-breathing. Normal breathing carries the air — out as well as in — through the nose, not the mouth. We should acquire the habit of breathing through

the nose rather than through the mouth, for the following reasons :

1. The lining of the nose secretes a layer of mucus, in which fine particles of dust are caught before getting to the windpipe.

2. Coarser particles are filtered out by the hairs that line the front nostrils.

3. The long, narrow nose passages warm the incoming air before it reaches the more delicate lining of the air pipes of the lungs.

This habit should be formed early in life ; most people are incapable of getting new



FIG. 49. Expression of face associated with adenoids

The open mouth, the sleepy eyes, the strain about the nose, are results of defective breathing due to obstructions in the rear air passages of the nose.

(From a photograph by Jessie Tarbox Beals)

habits or breaking old habits after they grow to maturity. Watch yourself, and when you catch yourself breathing through the mouth, make up your mind to stop the trick, and have your closest friend or relations help you by reminding you when you forget yourself.

Breathing through the mouth is objectionable on two other grounds besides the hygienic ones :

1. It looks hideous to other people; no one likes the appearance of a mouth-breather (see Fig. 49).

2. It sounds bad at night. That is, the mouth-breather is likely to become a snorer. Snoring is the sound produced by the vibration of the soft palate when a current of air strikes it on the way out through the mouth. You don't snore when you are awake; but when you are asleep the muscles of the mouth and palate relax, and the air sets the palate in motion.

182. Obstructions in nasal passages.

When children are seen to breathe through their mouths, and difficulty is found in making them breathe through their noses, they should be examined by a physician, as it is likely that there is some obstruction in the nasal passages. The most common obstruction is an outgrowth of the lining in the back part of the nostrils; such growths are called *adenoid* growths, and when present should be removed (see Fig. 50). Their presence is a handicap to the child, since it interferes with proper breathing

and, sometimes, with the circulation of the blood in the head. It is true that if they are not cut out, they are likely in time to disappear, being gradually absorbed. But by the time they are absorbed, the harm will have been done, for the growth and mental development of the child will have become permanently retarded by just so much.

183. Deep breathing. A second factor in breathing is that of *depth*. In ordinary breathing a man at rest takes into his lungs and throws out again with each breath about 30 cubic

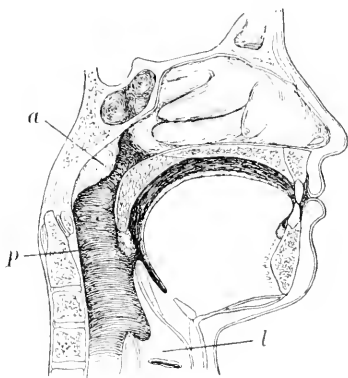

FIG. 50. Adenoid growths

In the passage between the nostrils and the pharynx (*p*) shapeless masses of tissue (*a*) sometimes grow out, obstructing the movement of air from the nose and leading to mouth-breathing. *l*, the larynx, or voice box

inches of air. If he takes a very deep breath, his lungs receive about 130 cubic inches. By forcing out of the lungs as much air as possible and then taking a deep breath, he can take in about 230 cubic inches. When the lungs have been emptied as completely as possible by a forced expiration, they still contain some 100 cubic inches of air. The lungs do not work to full capacity in regular breathing; that is, they are *never* perfectly empty, and they are *rarely* perfectly full.

The 30 cubic inches of ordinary tidal air will partially fill some of the air sacs of the lungs. The 100 cubic inches of additional air will fill more of the air sacs and distend them more. But some of the air sacs farthest away from the main air pipes will be filled only by forced breathing. This is true especially of the air sacs in the extreme upper corners of the lungs. These air sacs are never reached in the breathing of some people, and it is in these very corners that tuberculosis of the lungs most frequently begins.

For the sake of the health of the lungs it is desirable that they be thoroughly ventilated at least three or four times a day. Vigorous exercise of the large muscles of the legs, shoulders, or abdomen will automatically increase the depth of the breathing, so that the athlete or the shovel-man will ventilate his lungs without needing to think about the matter. But the book-keeper or the seamstress does need to think of the matter. A person whose occupation does not regularly compel deep breathing should acquire the habit of ventilating the lungs by means of ten to fifteen very deep breaths, taken three or four times a day, outdoors if possible, but at least at the open window. A very good habit that does not cut into one's time is to take a dozen very deep breaths on first going out in the morning, and again at noon and in the evening, or in fact whenever one passes from a house to the outdoor air.

184. Posture and clothing. You cannot give the fresh air a chance to reach all the corners of your lungs unless the shoulders are back far enough to let the chest expand freely.

The stooped position is not only bad for the spirits—for you cannot feel brave and strong with your head bowed down and the shoulders curved forward—but it is also bad for the health in general and for the health of the lungs in particular.

Clothing that cramps the ribs or the waist is a direct restraint on proper breathing. Tight corsets and belts do not cause one to suffocate; but they do prevent one from breathing deeply, with the use of the diaphragm as well as all the rib muscles.

The effect of lacing upon the liver, stomach, and intestines can be understood on a little reflection by anyone who understands the functions of these organs.

CHAPTER XXX

VENTILATION

185. Air requirements. The blood in the lungs absorbs from the air about 5 per cent of the oxygen taken in with each breath.¹ In the course of an hour an ordinary man will give off about 1000 cubic inches of carbon dioxide when at rest; with moderate work, about 1600 cubic inches; and with hard work, about 3000 cubic inches.

Ordinary Air	Expired Air
Oxygen 20.0%	Oxygen 16.4%
Carbon dioxide 0.03%	Carbon dioxide 4.1%
Nitrogen 78.09%	Nitrogen 78.09%

FIG. 51. Effect of breathing on the air

The ratio of oxygen to carbon dioxide is changed from 700:1 to 4:1

This means that in order to keep up the working power a person must be supplied with enough fresh air to keep up the oxygen requirement and to carry off the carbon dioxide excreted. Of course the air in a given room does not all have to be changed for every breath. It is safe to use air in which the amount of carbon dioxide has been increased from 4 parts in 10,000 (what it is in ordinary pure air) to 6 parts in 10,000, or even much more.

A great many studies have been made, to find out the amount of fresh air that should be supplied for each person in a room, for the purpose of establishing standards for ventilation of schools, factories, theaters, and so on. Some of the results of the experiments showed that a person needs at least 3600 cubic feet of air per hour. Others called for three times that much. It has been supposed that the change of air was

¹ A comparison of expired air with ordinary air shows that the amounts of oxygen and carbon dioxide are changed, whereas the nitrogen and other parts remain constant (Fig. 51).

necessary in order to keep up the proportion of oxygen and to keep down the proportion of carbon dioxid.

186. Ventilation problems. More recent experiments show that under ordinary conditions the air contains neither a breath poison nor a dangerous proportion of carbon dioxid, even when the ventilation is decidedly bad. Nor is there danger that the percentage of oxygen will fall below a safe limit. It seems that the chief problems in ventilation are (1) to keep the air at a suitable temperature, (2) to regulate the moisture and dust in the air, and (3) to prevent the air from stagnating.

187. Skin temperature. The body radiates heat and transpires moisture all the time. Up to a certain temperature we may remain comfortable by increasing perspiration and transpiration; that is, evaporation of water from the surface of the body keeps the temperature of the skin down. An excess of moisture in the air stops evaporation, and we become uncomfortably hot. Or if the temperature becomes too high, evaporation cannot go on fast enough to leave us comfortable. But this discomfort that the skin feels when it is hot and damp is of the same kind, only greater in degree, in the case of the lungs. A hot, stuffy room interferes with the breathing because it interferes with *the radiation of heat and the transpiration of water inside the lungs*. The oppression felt in a poorly ventilated room has apparently nothing to do with the amount of carbon dioxid or with the lack of oxygen. Bad odors are offensive and may interfere with one's breathing on that account.¹

The drowsy effects of a badly ventilated room are due to the congestion of the skin capillaries and the corresponding depletion of the blood vessels that supply the brain and the muscles, quite as much as to the influence upon the breathing.

¹ In the famous Black Hole of Calcutta, in which so many people lost their lives, the victims were supposed to have died of lack of oxygen. It seems probable that in such cases death really results from "heat-stroke," due to the excessive humidity (from the perspiration and the lung transpiration of the people) and the high temperature (from the heat radiated by the bodies and not carried off).

The new understanding of the effects of heat and dampness on the body's comfort and efficiency, and of the relative unimportance of the percentages of oxygen and carbon dioxide in the air, has not eliminated the problem of ventilation, however. On the contrary, it has made the problem more difficult, for the engineers had about solved the problem of how to supply a given quantity of new air to a room every hour. Now we have to consider the temperature and the moisture, and at the same time remove the disagreeable and sometimes distressing odors that are accumulated in a room full of people at work.

In many states the laws prescribe a minimum air space for each worker, amounting in most cases to four hundred cubic feet, exclusive of machinery or furniture. In a space of this size it is possible to change the air fast enough to remove the heat and the moisture given off by the body and the organic substances given off by the lungs without causing a draft.

188. Temperature of air. The prevailing temperature in a living room, schoolroom, or workshop should be kept as nearly as possible at 65° F. When the temperature approaches 70° it begins to be too uncomfortable and to affect the efficiency of one's work.¹

Where the character of the work requires that a lower temperature be maintained, as in packing houses and in some chemical works, the body should be provided with warmer clothing, and the humidity of the atmosphere may be higher. In mines, bakeries, tunnels, foundries, rolling mills, or other places where the temperature is necessarily high, workers should wear very light clothing, or even be stripped to the

¹ According to the studies of engineers, rooms should be warmer or cooler, according to the activities of those who occupy them. This idea is illustrated by the following table :

ROOMS FOR ACTIVE OCCUPATIONS

Shop for vigorous work, 50° - 59° F.
Gymnasium, 60° F.
Shop and room for moderate work, 61° - 66° F.

ROOMS FOR RESTING OR FOR
SEDENTARY OCCUPATIONS

Sleeping room, 54° - 59° F.
Lecture hall, 61° - 64° F.
Living room, office, school, 63° F.
Bathroom, 68° - 72° F.

waist; the humidity must be kept low and the air must be in constant circulation, to facilitate the removal of moisture.

189. Circulation of air. Natural ventilation will often suffice in dwellings that have large rooms and windows, with not too many occupants. But when many people have to be in a room, as in schools and workshops (especially in the winter, when artificial heating is necessary), there is likely to be a need of special attention to ventilation. So long as the weather permits it, ventilation should be by means of windows, open top and bottom for the freest possible circulation of air. A window board may be placed under the lower sash, as shown in Fig. 52, to prevent a direct draft; this will allow circulation of air between the sashes and at the top.

With closer occupation of rooms, forced ventilation becomes necessary. Several systems have been tried, in thousands of buildings. In some the air is pumped into the rooms; in others the air is drawn off.

Experts are not agreed as to which is better, and it is probable that neither is altogether superior to the other. Which-ever system is used, it can be combined with a plan to filter the dust from the air that comes into the rooms, with a device for adding suitable quantities of moisture, and with the heating plant for regulating the temperature.

In artificially heated houses there is often the danger of having the air too dry. In steam-heated rooms the moisture may be maintained by having a dish of water on each radiator.

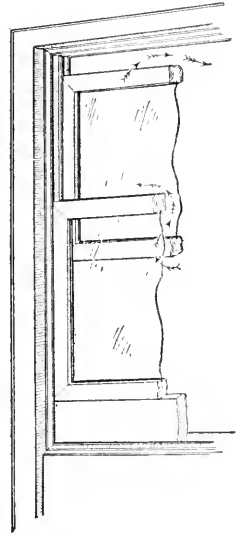

FIG. 52. Window ventilation in cold weather

A board placed edgewise under the lower sash prevents drafts. The upper sash is pulled down a few inches, permitting fresh air to come in between the panes and permitting warm expired air to pass out, as shown by the arrows

CHAPTER XXXI

CONTAMINATED AIR

190. Gases and fumes. In many industries poisonous gases and fumes are produced; these either corrode the delicate linings of the lungs or are absorbed and injure the whole system. Most acid fumes act in the former way. Alcohols used in varnishes, phosphorus fumes, lead fumes, and others poison the body. It is for these reasons that the manufacture of white phosphorus matches has been entirely prohibited in this country, and that the use of wood alcohol in varnishes and shellacs has been prohibited in some states and cities.

Where the work produces fumes or gases, these must be removed by flues connected with exhaust fans. No person should work regularly in any establishment that permits annoying or dangerous fumes to enter the air breathed in the shop.

Carbon monoxid, present in the suffocating coal gas produced when the drafts in a coal stove are closed down, is an actual poison when it gets into the lungs, being absorbed by the blood.

191. Dust. There are dozens of occupations in which the worker is constantly exposed to dust of various kinds. Dust is injurious in several ways.

1. It may form a crust over part of the lung lining, thus reducing the actual breathing surface and at the same time weakening the resistance of the cells to disease microbes.

Examples are coal dust and the fluff from fibers used in spinning and weaving.

2. Dust consisting of hard, sharp particles may scratch the delicate cells lining the air sacs, exposing them to the invasion of disease microbes.

Examples are metal and stone dust and fine sand, produced in industries in which metals are ground and polished, in which sand-blasts are used, and in which chipping of metal or stone is carried on.

3. Dust may carry with it disease germs of various kinds.

Street and house dusts are the most common source of this kind of danger.

A list of the most common occupations in which the danger from dust is an important factor is given below. It is possible in most of the industries to reduce the dust danger almost to the zero point.

SOME COMMON OCCUPATIONS IN WHICH DUST IS A SERIOUS MENACE TO THE WORKERS

Mining	Cotton textile industry
Crushing of metals and minerals	Flax and linen industries
Sifting of metals	Woolen and worsted manufacture
Molding and core-making	Silk industry
Grinding and polishing	Spinning
Brass-working	Weaving
Tool-making	Hosiery and knitting industries
File-cutting	Lace-making
Marble-cutting	Hat-making
Stone-working	Hemp and cordage industries
Glass-working	Jute and jute-goods industries
Cement-working	Shoddy manufacture
Pottery and earthenware industries	Rag-picking and rag-working
Plastering and paper-hanging	Wood-turning and wood-carving
Diamond-cutting	Cabinet-making
Engraving	Upholstery and mattress-making
Jewelry-making	Brush-making
Grain-handling	Paper-making
Flour industry	Printing industry
Starch-refining	Lithographing
Baking and confectionery work	Street-cleaning
Tobacco-working	

In the grinding of paints and of metals it is possible in many cases to use a wet process, in which water or oil is used to hold down the dust particles resulting from the grinding.

In polishing furniture powdered pumice stone and oil can be used instead of sandpaper.

In some dusty processes it has been possible to inclose the machinery and the material in such a way as to prevent the escape of dust into the air breathed by the workers, as, for example, in flour mills, in certain operations that have to do with the crushing of ores and minerals, and in the polishing of small metal objects.

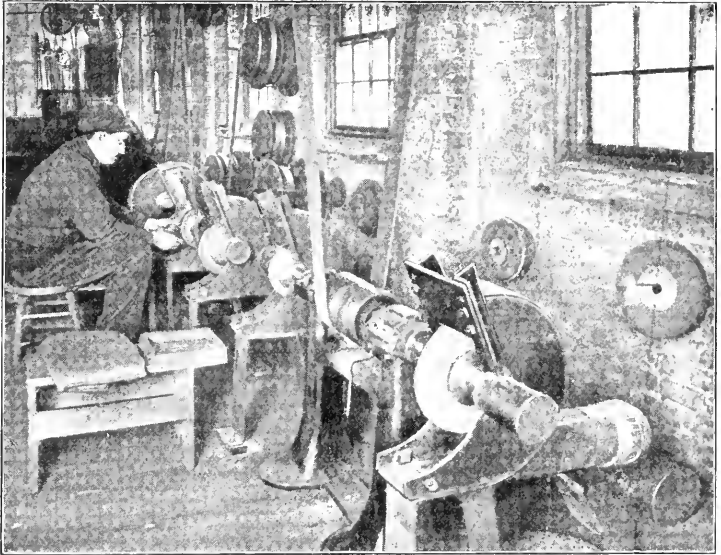

FIG. 53. Dust and safety hood

In polishing metal goods this hood protects the worker from dust and, in case the wheel bursts, from flying particles. (From photograph by New Jersey Department of Labor)

But where these methods are not possible, it is necessary to use a special form of ventilation that draws the dust away from the point at which it is generated. Special hoods connected with exhaust pipes are thus placed over grinding wheels, over rotary saw-blades, over polishing wheels, and so on (Fig. 53).

Even with all the precautions mentioned, there will be dust in many workrooms. In such cases the individual worker should carry an air-filter over his mouth and nose. This

respirator consists of a canvas cup carrying a wet sponge or cloth (see Fig. 54) through which the breathed air must pass, leaving the dust behind. The gas masks worn by our soldiers in France and by firemen serve a similar purpose.

Dust is constantly being produced in the home, on the street, in the school, etc. This dust settles on the floor, on the

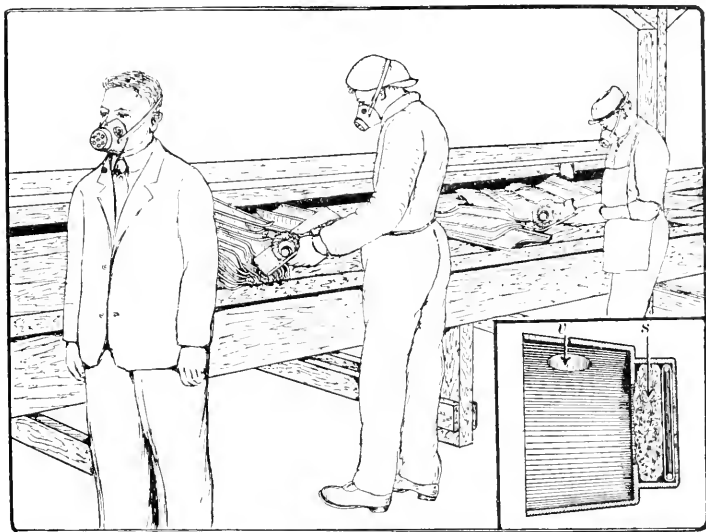

FIG. 54. Respirator

In many industrial processes it is impracticable to remove the dust by mechanical means. The respirator is worn by the worker to filter the dust out of the air which he breathes. The sectional view shows the valve, *v*, and the sponge, *s*, through which the air is filtered. (From photograph lent by the American Museum of Safety)

furniture, and on the books and utensils. Careless housekeepers or janitors sometimes try to produce the appearance of cleanliness by removing the dust in the quickest way, that is, by throwing it into the air, where it cannot be so easily noticed. From the point of view of people's health, this is a foolish way of keeping clean. Within the last few years feather dusters have gone quite out of fashion, and in some places their

use in school buildings and other public places is forbidden. From the point of view of cleanliness, as well as from the point of view of health, wet sweeping with damp or oiled sawdust or pieces of wet newspaper and the wiping off of dust with a damp or oiled cloth are more satisfactory than the old-fashioned methods of dry sweeping and dusting.



FIG. 55. Dusting for looks and dusting for health

The feather duster throws the dust into the air, where it cannot be seen, but where it can do more harm than on top of the bookcase or picture-frame. The damp or oiled cloth removes the dust not only from the furniture but from the way of doing harm.

192. Smoke. A very common source of air contamination, especially in manufacturing cities, is the smoke from furnaces of all kinds and from railway locomotives. Experiments have shown that the smoke interferes with the growth of plants, and it is certain that smoke affects the health of human beings. Progressive cities now prohibit the pollution of air by smoke.

193. Tobacco smoke. Whether we mind it or not, tobacco smoke spoils the air for us and is a real injury. Apart from possible injury to the smoker, those who do not smoke deserve

some consideration. Speaking for these, David Starr Jordan said, "We ask for a free passage through the world, *with pure air all the way.*"

194. Nicotine. The tobacco of commerce is made of the leaf and stalks of the tobacco plant (*Nicotiana tabacum*, a member of the potato family). The tissues of this plant contain a violent poison known as *nicotine*. Nicotine is a poison, either when taken internally, that is, into the food pipe, or when injected into the body through the skin. The people who are interested in tobacco, however, do not "take" it that way; they either smoke it, chew it, or snuff it. The practical question is, What is the effect of nicotine when administered in these ways?

195. Is smoking injurious? With very few exceptions the first smoke nauseates the stomach, irritates the lining of the windpipes and lungs, and irritates the eyes. Most people can, with a few trials, get used to tobacco, so that further indulgence does not produce these acute effects. Finally, after one has become used to it, tobacco has a soothing effect on the nerves, so much so that the habitual user seriously misses his supply if it is withheld for any length of time.

The effects of tobacco-using on people vary according to their sensitiveness to nicotine, their general health, and the kind of work they do. Although cases may be found in which no apparent harm has been produced by the use of tobacco, a study of the effects of smoking on large numbers of people has shown definite results, as (1) impairment of digestion, (2) chronic irritation of the linings of the nose, larynx, windpipes, and lungs, (3) effects on nerves and disturbance of heart action, (4) retardation of growth, and (5) sometimes a disturbance of the eyes.

These effects of smoking need not all appear in one smoker; and it is quite possible that these effects are not all due to the nicotine, of which only a small portion enters the system at the worst. The smoke contains some of the products of

incomplete oxidation, and it is likely that much of the irritation as well as of the stimulation is due to these rather than to the nicotine.¹

196. Effect on the heart. The evidence on hand may be taken to show that the habitual smoking of tobacco can lead to an irregularity of heart action. This may not be dangerous in itself, but probably makes the heart less reliable in an emergency. This is one of the reasons why athletic coaches do not permit those who are in training to use tobacco in any form and in any amount; when it comes to a critical test, the non-smoker is more likely to come up to the requirements of the athletic field.

197. Effect on the nerves. The smoker feels a soothing effect from his smoking, but after a while this effect wears off and he needs another smoke to soothe him again. As time goes on, the interval between smokes is shortened or the strength of the tobacco, or the size of the cigar, is increased. We may compare this to what happens in the case of the alcohol user.

Aside from the effect upon the feelings, the nicotine in many cases produces a certain *unsteadiness* in the action of the nerves. This may show itself in dimmed vision or eyestrain, in lessened precision of hand work, in weakened attention to the day's work, or in an increased tendency to absent-mindedness or day dreaming.

198. Effect on growth. The most marked effects of smoking are produced on *growing* boys.

In a large high school in Illinois an investigation was made for the purpose of finding out whether smoking made any

¹ A special objection to cigarette smoking is said to be the fact that the slow burning of the paper results in the formation of a substance, called *acrolein* by the chemists, which is highly poisonous. The effects of this are supposed to be cumulative; that is, "piling up." The carbon monoxid formed by the slow oxidation of tobacco and paper is also a source of injury, as this gas, when inhaled, is absorbed by the red corpuscles.

real difference to the abilities and development of the boys. Records were obtained for two hundred and one boys.

Of course it is not to be supposed that the grade-difference between smokers and non-smokers is due entirely to the fact of smoking. It is probable that the more scholarly boys do not take to smoking, so that if those who smoked had never done so, their marks would probably not be as high as the highest marks, on the average. Nevertheless the advantages seem to lean in favor of the non-smokers.

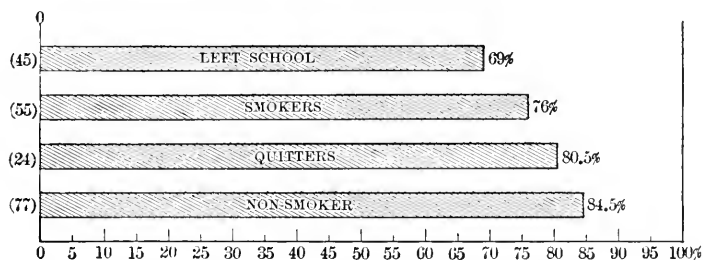

FIG. 56. Smoking and school standing

The school grades of two hundred and one Illinois high-school boys. The numbers in parentheses give the number of boys in the group. The forty-five who left school during the year were habitual smokers. Twenty-four of the boys had learned to smoke but had given up the practice. The average grade of the ten highest smokers was 78.9 per cent. The average of the ten highest in the school was 90.9 per cent; none of these smoked

The physical effects of tobacco on growing men have been shown from the records of several colleges.

At Yale the physical measurements of entering students have been taken for many years back. Physical examinations of students in college were made from time to time. At one time the *growth* of the students, as indicated by a comparison of the earlier and later measurements, was studied according to the tobacco habits. The records were divided into three groups, representing (1) students who never smoked, (2) those who smoked irregularly, and (3) those who had been smoking for a year or more before the second measurements were

taken. In every one of the measures of growth the non-smokers were ahead of the smokers, and the regular smokers were behind the irregular smokers or beginners.

It is not at all *likely* that the smaller, lighter, weaker boys were the ones to take to smoking in larger proportions. The differences shown by these records must be, at least in large part, due to the effects of smoking. When the records of physical growth for the different groups were placed alongside the records of scholarship, another striking fact was brought out. This is shown in Fig. 58.

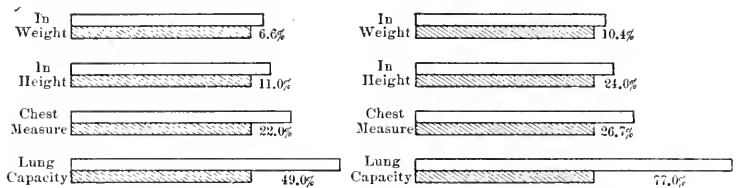

FIG. 57. Relation of smoking to physical growth

The first column shows the average advantage of non-smokers (indicated by white space) over occasional smokers (indicated by shaded space). The second column shows the average advantage of non-smokers over regular smokers. These measurements are from the physical-training department of Yale University

Similar records kept at Amherst College and at Columbia showed similar differences between smokers and non-smokers.

In some of the investigations the ages of the students in each class were also compared. It appears that in any given graduating class *the smokers are on the average older than the non-smokers*. This probably indicates the extent to which smoking — possibly in association with other unhygienic habits — retards a young person in his progress.

Whatever differences of opinion there may be as to the harmfulness of smoking for adults, *there is no difference of opinion as to its effect on the young*. For this reason the government of Japan some years ago prohibited the sale of tobacco in any form to minors, and some of our states have done the same. The United States Military Academy and the United States Naval Academy forbid the use of tobacco

by the students. Many railway companies and other large employers refuse to take on young men who smoke. In Minneapolis one hundred of the leading business men agreed not to give employment to young men who smoked.

Many officers in the army and navy and probably most of the railway officials and large employers and business men smoke. Yet they realize that they can get better service from young men who do not smoke. It is not a matter of sentiment or prejudice with them; it is strictly a matter of business.

199. Economic and social problems.

Aside from the injury that tobacco-smoking does to growing young people, the economic side of the question is simply whether, for the same expenditure of human

effort as is required to raise,¹ cure, handle, manufacture, and distribute the tobacco and various smokers' appliances, people could get more fun out of life. Certainly those who enjoy smoking, numbering into the hundreds of millions, feel that they are getting their money's worth in this form of enjoyment, and it is impossible to say to them that those of us who do not smoke are having more pleasure or satisfaction.

The social and æsthetic sides of the question can be seen more definitely.

1. The smoke of tobacco is distinctly offensive to the non-smoker. To be sure, we can get used to that, we can learn to stand it, but in and of itself it is a nuisance.

2. The perspiration of the smoker frequently becomes modified so that it is distinctly objectionable.

¹ Over a million acres of good land are worked in this country every year for raising tobacco. Over two hundred and twenty-five thousand persons are engaged in the manufacture and sale of tobacco products, besides the farmers and the makers of pipes, boxes, labels, and so on.

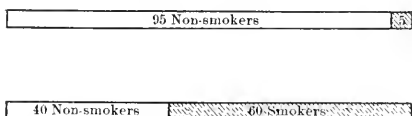

FIG. 58. Smoking and scholarship

Showing the proportion of smokers (shaded space) and of non-smokers (white space) among the students of highest rank (first bar) and among students of ordinary rank (second bar) at Yale University

3. The breath of the smoker, too, is frequently offensive.
4. The discoloration of the teeth does not add to one's attractiveness, nor does the discoloration of the fingers of cigarette smokers.

Perhaps no smoker makes himself offensive on all of these scores; but, taken together, these objections to the practice are just as real and just as serious as questions of cost or even of health.

There is a real fire risk involved by the wide practice of smoking; this can be measured by insurance experts, and can be controlled and reduced by police and educational measures.

CHAPTER XXXII

FIRST AID AND HYGIENE IN RELATION TO BREATHING

200. Air needed continuously. We can go without eating for days or even for weeks. Water has to be taken into the body more frequently. But we cannot go without breathing for more than two or three minutes or, at most, four or five minutes.

201. Suffocation and drowning. When, for any reason, the gas exchange in the lining of the air chambers in the lungs is stopped for several minutes, suffocation takes place, and death may result. Suffocation may be due to the replacement of air by some other gas, or it may be due to the exclusion of air.¹ The replacement of the air in the lungs by water is called *drowning*.

Suffocation and drowning are commonly fatal, but in very many cases life may be saved by prompt and persistent action. It is necessary (1) to empty the lungs of the water or foreign gas and (2) to reestablish the breathing movements.

When a person has been drowned, the first thing to do is to place the body, face down, in a position that will cause the water to pour out of the lungs. A child may be lifted up by the feet.

Breathing movements should be begun at once. In the Schaefer method of artificial respiration the victim is laid face down, with the arms stretched forward beyond the head; the head is turned to one side and supported on a cloth, to leave the nostrils and mouth unobstructed. The operator kneels, straddling the subject's thighs and facing his head, and with the

¹ Breathing may also be stopped by a severe electric shock, which acts on a group of nerves that control the breathing movements. The treatment should be the same, whatever the cause of the suffocation.

thumbs over the small of the back and fingers over the lowest ribs, alternately compresses and releases the chest by swinging forward and back, at the rate of from twelve to fifteen times a minute. The movements should be kept up until natural breathing begins, but should not be given up in less than an hour.



FIG. 59. Silvester method of artificial respiration, — expanding the chest

After drawing out the tongue and placing the patient on the back with a block or roll under the shoulders, to keep the chest raised and the head thrown back, kneel behind the head and grasp the arms just below the elbows. Draw the arms slowly backward over the head, and hold them there about one second

While these movements are being carried out, the victim's tongue should be pulled out and kept out, to prevent it from slipping back into the throat and obstructing the windpipe.

The Silvester method of artificial respiration is shown in Figs. 59 and 60.

In case of asphyxiation, or suffocation by gases or by electric shock, the same procedure should be followed, except that it is not then necessary to take special steps for emptying the lungs of water.

Under the supervision of the United States Bureau of Mines squads of miners are instructed in the resuscitation of people who become asphyxiated by gases or by electric shock. This bureau conducted a series of experiments to determine which of the mechanical resuscitating devices was



FIG. 60. Silvester method of artificial respiration, — contracting the chest

After the arms have been held above the head about one second, push the elbows slowly forward and downward until they are in the position shown. Press the elbows firmly against the chest and hold them there about one second, to drive all the air out of the lungs. (Photographs and instructions, Figs. 59 and 60, from United States Bureau of Mines)

best for various purposes. It was found that more reliance could be placed on quick action by men who understood how to establish respiration than on most of the machines, and it is always safer to begin work by hand than to wait for the best machine. One of the devices is illustrated in Fig. 61.

202. Summary on breathing and ventilation. Since we carry on our breathing without needing to think about it, most people have given very little attention to the subject of air and

breathing. It is only in comparatively recent times, therefore, that we have come to realize what a close connection there is between our breathing habits and breathing conditions, on

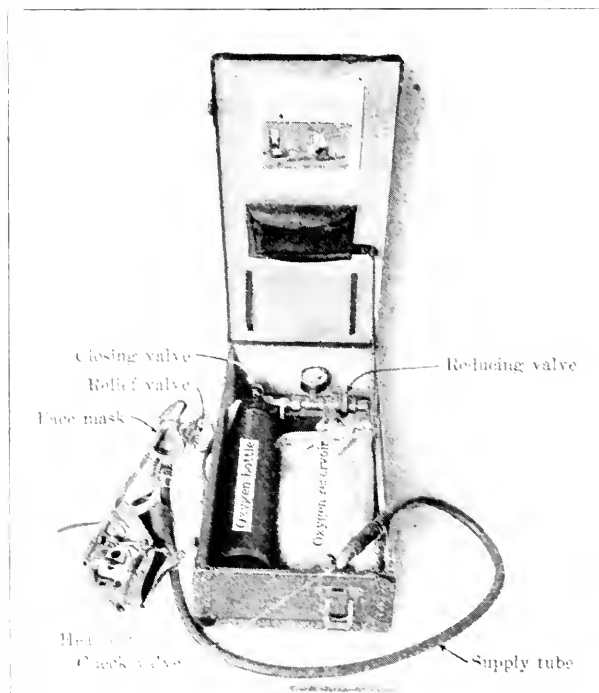

FIG. 61. Oxygen inhalator

This apparatus for the resuscitation of persons overcome by suffocating fumes or gases was developed by the United States Bureau of Mines. It is used with the Schaefer method of artificial respiration, and supplies oxygen for about thirty-five minutes, which is usually sufficient to restore normal breathing. (Photograph by United States Bureau of Mines)

the one hand, and our health, happiness, and efficiency, on the other. The most important things that have been discovered by the new attention to these details are the following:

1. Outdoor air is better than indoor air in every way.
 - a. It is better for playing, even in the cold and rain; suitable clothing will make up for these.

- b.* It is better for work, since a person can accomplish more in a given time when breathing outdoor air than when breathing indoor air.
 - c.* It is better for health, even to sleep out of doors.
2. Nose-breathing is in every way better than mouth-breathing.
 - a.* Where mouth-breathing is due to adenoids, these growths should be removed.
 - b.* Where mouth-breathing is due to bad habits, these habits should be corrected.
3. Deep breathing is better than shallow breathing.
 - a.* Where shallow breathing is due to improper clothing, the clothing should be changed.
 - b.* Where shallow breathing is due to habit, correct habits should be acquired through exercise, outdoor games, work, etc.
4. Dust is a source of danger to the health of the body and to the lungs in particular.
 - a.* Mechanical dust, soot, and smoke (including tobacco smoke) coat the lining of the air sacs and reduce the breathing surface.
 - b.* Hard dust may scratch the lining of the air sacs and thus increase exposure to infection.
 - c.* Dust carrying microbes is a direct source of danger.
 - d.* Chemical dust and fumes may poison the blood.
5. A person suffocated or drowned is not to be given up for dead before every possible effort to resuscitate him has been made in vain.
6. Ventilation is necessary not only to keep down the proportion of CO_2 and to keep up the proportion of oxygen in the air, but also to (*a*) regulate the moisture, (*b*) regulate the temperature, (*c*) keep the air moving, (*d*) remove disagreeable odors, (*e*) remove gases and fumes, (*f*) remove dust.
7. Alcohol, by congesting the capillaries, decreases the breathing efficiency of the lining of the air sacs.

CHAPTER XXXIII

TRANSFER OF MATERIALS IN PLANTS

203. Exchange of materials in living cells. One-celled plants and animals that move about in the water constantly come into a new environment, from which they get supplies of water, oxygen, minerals, and food

(or food-making materials). In larger animals and plants the life of the cells, or at least of the innermost ones, can be maintained only by means of an internal transportation system. This brings to the cells their supplies of food, water, oxygen, etc., and carries from them, to be removed to the exterior, their waste products.

204. The conducting systems of a plant. In

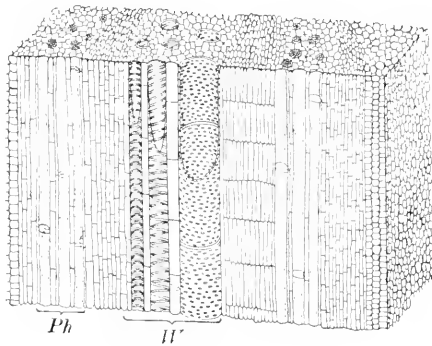

FIG. 62. Vessels in a plant

Section of squash stem, showing phloem vessels, *Ph*, which conduct food down from the leaves, and two kinds of wood vessels, *H''*, which conduct water and salts up from the roots. The two kinds of wood vessels are those with spiral thickenings in the walls and those with pitted walls

all those plants that have a body which is made up definitely of root, stem, and leaf the diffusion of water and of dissolved substances between parts of the body is supplemented by the transportation of material in mass. We have seen that water and salts absorbed by the root-hairs diffuse through the cells of the root cortex and then move bodily through special vessels (see p. 44). These sap-carrying vessels are of several kinds — some long, some short, some consisting of single

cells, some consisting of series of cells from which the end walls have disappeared, leaving long, continuous channels. Some of these vessels are illustrated in Figs. 10 and 62.

The water and salts from the roots pass through one set of tubes, and the manufactured food from the leaves through another. The fibrovascular bundles conducting water from the roots are called *xylem*, or wood; those conducting food sap are called *phloëm*, or bast. The bast vessels are characterized by the presence of pores in their end walls (Fig. 65). These end walls with their perforations are called sieve plates.

In woody plants the fibrovascular bundles of xylem are arranged in concentric cylinders and constitute the wood of the tree. The phloëm

bundles are arranged around the wood, in the inner portion of the bark. Between the outer layer of wood and the inner layer of bast is the cambium, or growing layer, from which all the new xylem and all the new phloëm cells originate.

The fibrovascular bundles branch and divide so that they reach into all the twigs and leaves. In the leaf they branch again and constitute the so-called veins, or nerves, of the leaf

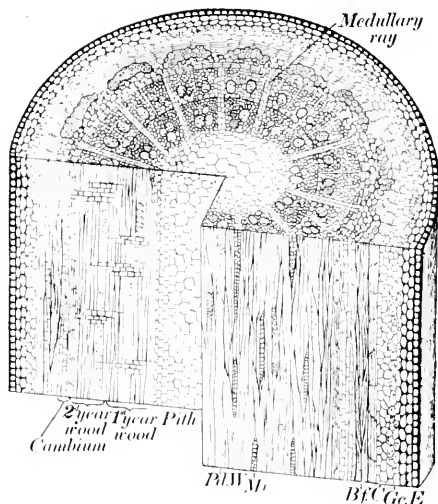

FIG. 63. Structure of a woody stem

Diagrammatic view of piece of two-year-old blackberry stem, showing the central *pith*, surrounded by the *wood* of the first and second years, the *bark*, and the *epidermis E*. The wood is made up of wood fibers, *W*, and vessels, *Pd*, representing a pitted duct. Between the wood and the bark is the growing, or *cambium*, layer, and this is connected with deeper layers by means of the *Medullary rays, Mr*. Under the skin are some green cells, *Gc*, and running through the bark cells *C* are bast fibers, *Bf*, as well as bast vessels, which are not shown

blade (Fig. 64). The sap-carrying vessels of the root are continuous with similar tubes found in the stem. In many plants the bundles of vessels and fibers are readily pulled out from among the surrounding pith cells. In celery these bundles make up the "strings," and in the plantain the so-called "nerves" that we see sticking out of the stalk when we pull up a leaf.

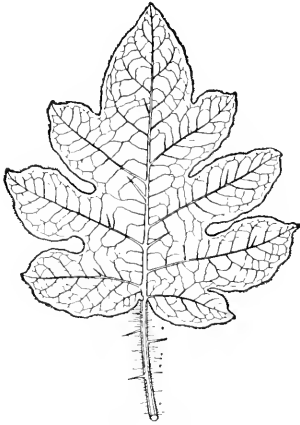

FIG. 64. Veins of a leaf

Leaf of apple of Sodom (*Solanum aculeatissimum*), of the potato family, showing network of veins

In the veins of leaves the phloëm and the xylem vessels are closely compacted. In herbaceous stems the phloëm and xylem are also united; in woody plants the phloëm is located in the bark. Bast fibers are commonly used in the form of linen, hemp, and jute fibers.

205. The ascent of sap in trees.

Investigators have long been puzzled by this problem, and we are not yet sure that we understand it. However, it is certain that the water does rise, and that it goes through the xylem vessels.

206. The descent of sap. From certain common observations and from the results of experiments we may reasonably infer that sap descends. We know that organic food is formed in the leaves, and that it is accumulated in the roots and in underground stems of many plants. There must therefore be a current of material passing downward from the leaves.

A tree that is girdled, that is, one that has a ring of bark removed, will continue to live for the rest of the season. This shows that the removal of the bark does not interfere with the ascent of water and salts from the roots to the leaves. The following spring, however, when the opening of the buds with the rapid expansion of leaves and twigs depends upon the food accumulated during the previous season, the tree will be found

dead. Although water and salts may still be able to reach the upper parts of the plant (since the channels that served during the previous season are still open), the food that should have been accumulated during the previous summer is lacking.

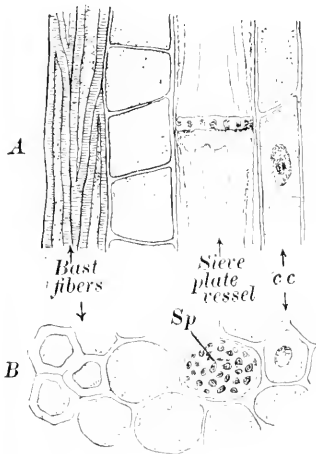

FIG. 65. Bark fibers and vessel

A, a section cut lengthwise, and *B*, one cut crosswise, showing bast fibers, sieve-plate vessel, and the so-called companion cells found next to the sieve-plate cells. ($\times 400$)

207. Circulation of sap. In plants there is no circulation of materials such as we find in the higher classes of animals. There is, it is true, a movement of liquid from the root to the leaves, and from the leaves to the roots; but the matter conducted along the two sets of vessels is not the same either in amount or in kind.

The water that moves from the roots to the leaves is several times as great in quantity as the liquid that moves

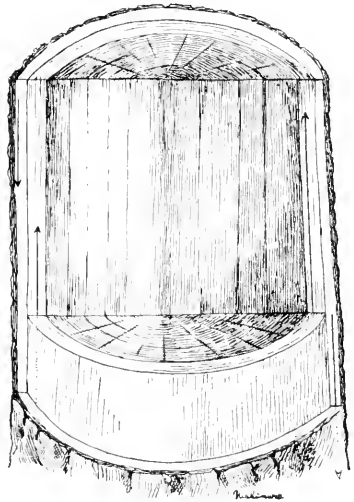

FIG. 66. Ascent and descent of sap

The arrows in the diagram are to show that materials absorbed by the roots travel upward through vessels located in the wood part of the stem, and that materials resulting from the food-making processes in the leaves travel downward through vessels located in the bark. When a complete ring of bark is removed from a tree, the plant may live on to the end of the summer; but the buds will not open the following spring, since they depend upon food accumulated in the roots

from the leaves to the roots, since by far the largest portion of it is transpired and never comes back.

The ascending current is for the most part inorganic in its composition; the descending current is in large part organic.

The two currents are nowhere continuous. They are practically independent of each other, except, of course, that the life of the plant can continue normally only when both currents are maintained; yet one may go on for a considerable time without the other being in action.

CHAPTER XXXIV

THE BLOOD

208. Blood. In all animals above the corals and sea-anemones, and certain kinds of worms, there is present a circulating mass of liquid which is commonly called *blood*, although not all kinds of blood are alike. In the clams the blood contains a bluish substance, called *hemocyanin*, which easily combines with oxygen, and thus carries oxygen obtained from the surrounding water by diffusion into the capillaries of the skin and gills. In the earthworm there is a reddish substance, called *hemoglobin*, dissolved in the blood, which behaves in much the same way as the hemocyanin of the clams.

The blood of back-boned animals has a rather complex structure, and is associated with an elaborate system of vessels and a pumping organ called the heart.

209. Composition of human blood. When examined with the microscope, human blood is seen to consist of a *colorless* liquid, called the *plasma*, and a number of small bodies floating in it. The more numerous particles are the so-called *red corpuscles*. These are very small¹ and have the shape of a disc or coin, with rounded edges and compressed towards the middle (Fig. 67). In addition to the red corpuscles, there are also white, or colorless, corpuscles, some barely larger than the red ones, others many times as large.

The fluid portion of the blood, the plasma, consists chiefly of water. In this are dissolved various salts, organic substances derived from the digested food, some oxygen, some carbon dioxide, certain ferments, and other organic substances derived

¹ On the average, about $\frac{1}{3200}$ of an inch in diameter.

from various organs and tissues of the body. It is not to be supposed that any given drop of blood will contain all of these substances, or all of them in the same proportions, for, as we shall see, the composition of the blood is constantly undergoing changes in the smallest blood vessels, through the walls of which new substances are coming in and others are passing out.

210. The lymph. The blood, consisting of plasma and corpuscles, fills a set of tubes from which there are no openings; the system is therefore called a *closed* blood system, to distinguish it from the blood system of clams and certain other animals,

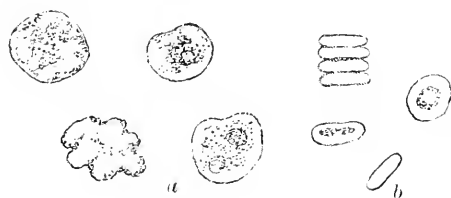

FIG. 67. Human blood corpuscles

a, fresh leucocytes (white corpuscles) in resting and in moving stage (note granulations and nuclei); *b*, red corpuscles in flat and in side view

in which many of the blood tubes have open ends connecting with various spaces in the body. Outside of the blood vessels in the human body, filling definite tracts as well as

spaces between tissue masses and cells, is a colorless liquid, called *lymph*. It is *from the lymph* that the cells obtain their food supplies, water, salts, ferments, and oxygen; and it is *to the lymph* that they discharge their carbon dioxide, urea, and other wastes. The communication between the lymph and the blood is by osmosis through the walls of the smallest blood vessels (Fig. 68), and through definite connections between lymph tubes and certain large blood vessels.

The lymph, like the plasma, consists chiefly of water, and carries practically the same kinds of substances in solution. In addition, the lymph has floating in it many white corpuscles, so that it may be compared to blood lacking the red corpuscles. The lymph has been compared to the ocean, in which life probably originated, and from which so many

one-celled organisms obtain their supplies directly. The lymph is an internal ocean from which all the cells of the many-celled animal obtain their supplies.

211. Clotting of blood. When some blood is removed from the blood vessels, whether it is taken out of the body or not, it usually becomes clotted, or thickened. This clotting is brought about by the coagulation, or solidifying, of a certain protein in the blood known as *fibrinogen*, which means "fibrin-maker." The ferment that causes the coagulation becomes active when the lining of a blood vessel is injured; or it may be that the ferment is formed only at such times. At the mouth of a small cut this clot soon stops the bleeding, and furnishes a protective covering until the wound is healed.

212. Serum. If blood is allowed to

clot in a glass vessel, we can see the mass of fibers detach themselves from the walls of the vessel, after the threads have shrunk awhile, and the clot floats at last in a clear liquid that is almost colorless or slightly yellowish. This clear liquid is called a *serum* and is practically the same as the blood plasma, but lacking the fibrinogen. Whatever is characteristic or distinctive of the plasma of an individual or of a species will be found in the serum.

213. The white corpuscles. On closer study the white corpuscles are seen to be *cells*. In many ways they are like the ameba (see p. 24). They consist of naked protoplasm, have no definite shape, are capable of free movement, are sensitive to chemical and other changes in their surroundings, and are

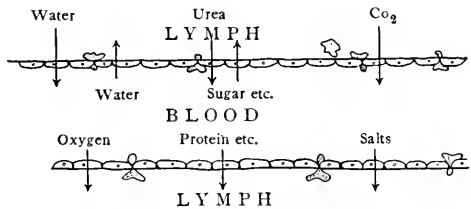

FIG. 68. What goes through the wall of a capillary

From the blood within the capillary, water, salts, food, and oxygen pass out by osmosis; from the surrounding lymph, carbon dioxide, urea, and water pass into the blood. White corpuscles work their way through the wall of the capillary, between the cells

capable of *cating* small particles by swallowing them into the protoplasm of which they consist, just like the ameba and other one-celled animals.

These ameba-like corpuscles are found in the blood not only of mammals but of all animals that have blood; and they are very much alike in all, so far as general appearance and behavior are concerned. Their function has come to be understood only in modern times, chiefly through the works of the Russian biologist Élie Metchnikoff, the late director of the Pasteur Institute in Paris.

To help us understand the functions of these cells it is well to recall that whereas the one cell of the ameba carries on *all* the functions of a living body, the various cells of a many-celled animal like a butterfly or a baby are *differentiated* in regard to function as well as in regard to structure. Now, the white corpuscles are in many ways the *least* differentiated cells in the body. They are the ones that have the *general* qualities of protoplasm in the greatest degree; they have not become specialists in any one line. They can move, like muscle cells, but not so quickly or so vigorously. They are irritable, like nerve cells, but in a slighter degree. They are chemical laboratories, like gland cells, but do not produce specialized juices. They are digesting cells, and so on.

With this view of the white corpuscles as undifferentiated, wandering cells we may try to understand just what they do in the body.

1. As eating-cells (called by Metchnikoff *phagocytes*, which means "eating-cells") they are capable of engulfing foreign particles with which they may come in contact. In this manner they may eat and digest dead particles resulting from the breaking down of tissue cells, and live cells introduced from without — that is, bacteria that may get into the body in various ways.

2. As sensitive or irritable cells they may respond to a chemical stimulation by producing substances that neutralize or counteract foreign chemicals, as various kinds of poisons.

3. As moving cells they wander about from the lymph to the blood, or vice versa, and even into the intestines, carrying with them dead matter to be eliminated, or crowding in large numbers and producing some special substances that counteract a local chemical disturbance.

Because of this peculiar behavior we have come to think of these corpuscles as perhaps the most important agents in keeping the body in health, at least in relation to certain special diseases.

White corpuscles probably originate by the division of ameboid cells in the bone-marrow and in particular portions of the lymphatic system, enlarged lymph spaces containing crowds of the white corpuscles.

214. The red corpuscles. The blood of vertebrate animals contains red corpuscles in addition to the white ones. In all except the mammals the red corpuscle has a nucleus in the center, which makes the disc somewhat thicker in the middle, and its shape is elliptical rather than circular.¹ The largest red corpuscles are found in the amphibia; and even with the lower power of the microscope we may easily see the elliptical discs in the flowing blood of a frog's web or a tadpole's tail.

The distinctive thing about the red corpuscle is the fact that it contains a substance known as *hemoglobin*, which readily combines with oxygen or with carbon dioxid, according to the chemical conditions to which it is exposed. The red corpuscle thus acts as a gas-carrier in the blood.

Recent experiments made in this country show that there is a special ferment in back-boned animals which causes the hemoglobin to combine with oxygen in the lungs (or gills), and that there is another ferment which causes the oxygen-hemoglobin combination to break up in all parts of the body.

¹ Among the mammals, the camel is exceptional in having elliptical blood corpuscles. Among the fishes, the perch and a few others have circular corpuscles.

The red corpuscles, like the white ones, are really unattached cells. They originate by successive cell divisions of special cells found in the marrow of bones. At first they have a nucleus; but this soon disappears. Lacking a nucleus, these cells cannot remain alive very long. It has been found that the older corpuscles disintegrate, and their hemoglobin is taken up by the liver and converted into bile.¹

¹ In its chemical composition hemoglobin is somewhat like the chlorophyll of plants. To form either of these pigments, protoplasm must have *iron*. Iron given as a medicine or tonic is administered to assist in the formation of hemoglobin and red corpuscles. A deficiency in the red corpuscles results in the general weakness and paleness that are characteristic of the condition of the body known as *anemia*.

CHAPTER XXXV

THE CIRCULATION OF THE BLOOD

215. The vessels. In all backboned animals the blood is entirely inclosed within a set of tubes, so that everything enters or leaves the blood only by passing through the walls of these tubes (see p. 180).

The tubes or vessels reach all parts of the body, so that if we could somehow remove all of a person except the blood vessels, we should have a pretty good imitation of the whole body.

There is a special muscular enlargement of the blood vessels known as the *heart*. Through the contractions of this organ the fluid is kept in constant and *continuous* motion — not in a back-and-forth motion, as the ancients believed.

The vessels in which the blood flows from the heart are called *arteries*; those in which the blood returns to the heart are called *veins*.

The main arteries and veins run in parallel courses and branch and subdivide until the smallest tubes are too small to be seen without a microscope. The smallest branches of the arteries connect with the smallest branches of the veins, so that the blood that has been moving into smaller and smaller vessels presently begins to flow into larger and larger ones. These smallest tubes, connecting the arteries with the veins, are called *capillaries*.

The walls of the capillaries are so thin that diffusion is constantly taking place through them; and the white corpuscles work their way through them, passing between the cells (Fig. 68). All the changes in the composition of the blood take place while the blood is in capillaries in various parts of the body.

216. The heart. In birds and mammals the heart is a double muscular organ, the right and left halves being quite distinct from each other, in the sense that blood cannot pass directly from one side to the other. Each half of the heart consists of an upper *receiving* chamber and a lower *pumping* chamber.

The *left heart* is somewhat larger and stronger than the right heart. Its *ventricle*, or pumping chamber, closes up, or contracts,

at fairly regular intervals, forcing the contained blood into the largest artery of the body (the *aorta*), by the branches of which it is carried on to the various organs and tissues.

The *auricle*, or receiving chamber, of the left heart is connected with a large vein that brings blood gathered from the capillaries of the lungs.

The receiving chamber opens directly into the left ventricle, by means of an opening which is guarded by a set of flaps that prevent the blood from flowing back when the pumping

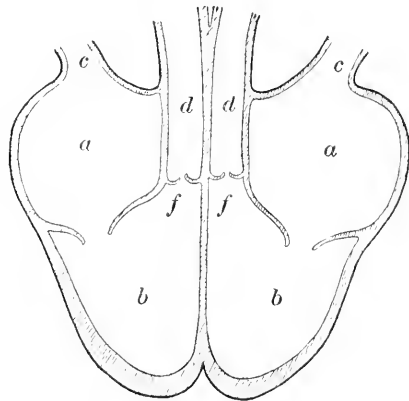

FIG. 69. Diagram of the human heart

aa, receiving chambers, or *auricles*; *bb*, pumping chambers, or *ventricles*; *cc*, main veins, bringing blood to the heart; *dd*, main arteries, carrying blood away from the heart; *ff*, valves, preventing back-flow from arteries to ventricles; between *a* and *b*, valves preventing back-flow from ventricles to auricles

chamber contracts. Another set of valves prevents the blood in the aorta from flowing back into the ventricle when the latter expands again. The left heart thus pumps blood received from the capillaries of the lungs to arteries all over the body.

The *right heart* receives blood from two large veins connected with its auricle, or receiving chamber (Fig. 69), and passes it into the ventricle, or pumping chamber. The auricle and ventricle on the right side are also connected with each

other, like the corresponding chambers on the left side, and there is a valve preventing the back-flow of blood from the ventricle to the auricle. The right ventricle pumps blood into a large artery that carries blood toward the capillaries of the lungs (*pulmonary artery*).

217. The double circulation. The blood stream may be traced from any point back again to the start only by passing through the two sides of the heart and through the pulmonary, or lung, circulation and the general body, or systemic, circulation. Thus, beginning, for example, in the capillaries of the hand, the blood flows into the veins and is gathered into larger and larger vessels, reaching the right auricle; from this it goes to the right ventricle, and when the latter contracts, it is forced into the pulmonary artery, which divides into smaller and smaller branches, the smallest being the capillaries that lie under the lining of the air sacs of the lungs. As the blood flows on, it is gathered into larger veins that unite to form the pulmonary vein, which empties into the left auricle. From the left auricle the blood goes to the left ventricle, and from this it is pumped into the aorta. An

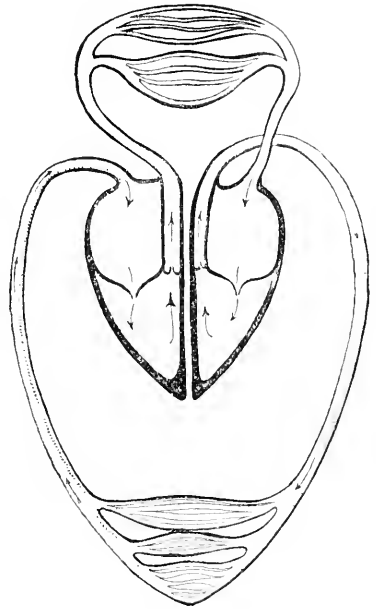

FIG. 70. The "double circulation" of the blood

The arrows indicate the direction of blood flow. The shaded portion represents blood lacking in oxygen. From the right heart (shaded) the blood passes to the lungs, from which it returns to the receiving chamber of the left heart with its carbon dioxide replaced by oxygen. From the pumping chamber of the left heart the blood passes to all parts of the system, or body, and returns to the receiving chamber of the right heart with its oxygen replaced by carbon dioxide

artery branching from the main

artery carries blood into the arm, and as the arteries divide, becoming smaller and smaller, we at last reach the capillaries in the hand, from which we started (Fig. 70).

This "double circulation" makes it possible for the carbon dioxid in the body to be completely exchanged for oxygen in a comparatively short time. In the human body all of the blood passes through the heart (and therefore through the capillaries of the lungs) once in from twenty-three to thirty seconds.

The exchange of gases in the air sacs of the lungs has already been described (see p. 148).

218. Changes in the blood. When in the capillaries of the various tissues of the body, the blood absorbs from the surrounding lymph (by osmosis) carbon dioxid, urea, and other substances that are present in relatively large proportions (that is, compared to their concentration in the blood plasma); and it loses by the same process food materials, salts, oxygen, and ferments that are relatively more abundant in the blood than in the surrounding liquids.

In certain parts of the body additional changes take place in the composition of the blood. In the intestines, for example, much of the digested food is absorbed into the blood. In the kidneys much of the urea, salts, and other waste substances are taken from the blood.

219. Ferments in the blood. In the capillaries of certain organs the blood receives, in addition to the usual waste products, various special ferments, or chemical substances, called *hormones*. For example, from the thyroid gland, which is a Y-shaped, spongy body lying in front of the larynx, the blood absorbs a substance that has an important influence on the development and working of the brain. Extracts of the thyroid from calves can be used to correct deficiencies in the production of this substance in human beings, with striking changes in the further development of the patient.

From the pancreas the blood absorbs a substance that has an important influence on the oxidation of carbohydrates in the cells. *Insulin* has been recently produced from the tiny lumps of tissue or "islands" in pancreas; and this has been used successfully in the

treatment of diabetes, which is a disease that involves defective oxidation of sugar.

From little capsules that lie just above the kidneys the blood absorbs a ferment that influences the muscles of the blood vessels, and also has some effect on the nervous system. The amount of this secretion is increased whenever strong feelings are aroused, such as fear or anger. An increase in the amount in the blood acts upon the liver, increasing the output of glycogen into the blood, and it interferes with the secretions and contractions of the stomach. The *adrenin*, as this substance is called, also hastens the clotting of blood.

In young mammals there is a soft organ lying in the front part of the chest, the *thymus*, the ferments from which have an important influence on the growth of the animal. Another ferment that affects the growth is absorbed by the blood from a little body lying at the base of the brain, the *pituitary*.

These various ferments are sometimes called *internal secretions*, because they are absorbed from inside the organ, instead of coming out of the gland through special ducts, as is the case with ordinary glands.

CHAPTER XXXVI

HYGIENE OF THE CIRCULATORY SYSTEM

220. Care of the heart. Every contraction of the ventricles (the two ventricles work together) sends a wave of pressure through the blood in the arteries. The muscular and elastic walls of the arteries "give" somewhat to this pressure, and this is the *pulse* which can be felt in any artery near the surface of the body, as at the wrist, on the temples, or immediately in front of the ear. From the character of the pulse the physician can often tell a great deal about the workings of the heart and about the condition of the blood vessels. The pulse may be regular or irregular; it may be strong or weak.

A strong heartbeat would ordinarily increase the pressure of the blood inside the arteries; but if the arteries are flabby, the additional work of the heart may fail to distribute the blood properly to all parts of the body. Cold feet and hands are an indication of inadequate circulation, but the cause of this condition may be in the heart or it may be in the blood vessels.

In examining a person the careful physician, athletic director, or insurance examiner will always listen to the beating of the heart and examine the pulse and test the blood pressure. From the sounds of the heart he can tell whether there is a defect in any of the valves. A leaky heart has to do a great deal more pumping to keep the body supplied than a sound heart, since a portion of every stroke is wasted in pumping blood that goes back into the auricles.

A weak heart usually shows itself in breathlessness. If you cannot climb stairs, or take a brisk walk, or play a lively game, without getting out of breath, the trouble is more likely with your heart than with your lungs. In training for athletics

one of the most important things is to acquire "wind"; that is, the ability to continue severe exertions without losing breath. This is in fact a training of the heart, as well as a training in correct breathing habits. Under suitable directions one can strengthen his heart considerably by means of graded exercises in walking, running, climbing, etc. Indeed,

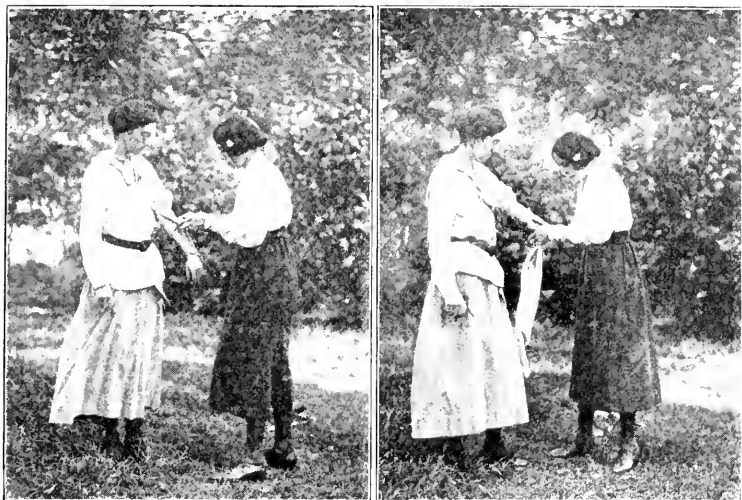

FIG. 71. Treating a cut

When the pressure of the thumb is not sufficient to compress the blood vessels and stop the flow, a tourniquet may be used, made by tying a handkerchief about the limb and twisting it tight by means of a stick slipped under the handkerchief. Of course, the tourniquet or the bandage applied in this way is to be considered an emergency measure, and steps should be taken to have the wound attended to by a physician

one of the dangers of the athletic enthusiasm is that a student will overdevelop his heart. But occasional severe strain upon the heart is not the same as training it for hard work, and a person with a weak heart should not be engaged in work that strains this organ severely.

221. Cuts and wounds. Small wounds will usually stop bleeding in a short time because of the clotting of the blood (p. 181). In view of our modern knowledge about the wide

distribution of many kinds of bacteria, however, it is wise to look after even small cuts and scratches.

The festering of sores and cuts, which was formerly looked upon as a normal and necessary condition of healing, we now know to be the result of the action of various kinds of microbes, some of which, at least, produce serious blood poisons (see p. 195). To prevent the festering of a sore, and to prevent the invasion of the body by more injurious microorganisms, it is well to treat every cut with an antiseptic, or sterilizing, solution, such as a solution of carbolic acid or bichlorid of mercury, or with tincture of iodine or alcohol. The cut should then be covered with clean cotton or gauze, to prevent the entry of microbes later.

With larger wounds it is sometimes necessary to use special means to stop the bleeding. When the flow of blood is too strong, the adhesion of the clot to the sides of the wound may be prevented. When the flow is from an artery (which may usually be recognized by the pulsation), the limb should be tied *above* the cut; that is, on the side *toward* the heart. When the flow is from a vein, the attempt to stop the flow should be made on the side *away from* the heart.

222. Nose bleeding. In very many cases nose bleeding may be stopped by snuffing cold water. The old-fashioned remedy of dropping a key down the person's back rested on the fact that the chill causes the capillaries to contract. A piece of ice applied for a few moments to the back of the neck will be more likely to have the desired effect. Where bleeding continues after such a simple treatment, it is probable that some small artery has been broken, or that the person's blood is incapable of clotting. An *astringent* is then advisable. Powdered alum, tannin, or ferric chlorid may be applied on a tuft of cotton. These substances cause the fine blood vessels to contract and thus stop the bleeding. In extreme cases a physician will use adrenin, an extract of the capsules lying above the kidneys (see p. 189).

CHAPTER XXXVII

THE BLOOD AS A LIVING TISSUE

The white corpuscles respond to the stimulation of foreign substances in several distinct ways. Some of these are significant in fighting diseases; others have been used in different ways; still others we can neither understand nor utilize in any practical way.

223. Precipitins. When the white of an egg is taken into the stomach of a backboned animal, it may be digested and eventually absorbed into the blood or lymph, and from this to the cells, where it acts as a food. But if some white of egg is *injected into* the blood (of a rabbit, for example), it will have a curious effect upon that blood. After a few such injections the blood contains a substance that is not present in normal rabbit blood. This new substance, which cannot be detected by chemical methods, can be shown to be present if a drop or two of the *serum* (see p. 181) of the treated rabbit is mixed with a drop of water containing some white of egg. Immediately there will be a visible precipitate. The substance that is present in this serum, causing the precipitation of the egg albumen, is called a *precipitin*, or precipitating substance.

The formation of the precipitin by living cells is not at all understood. An important fact about the precipitin is that it is always *specific*. That is to say, a precipitin formed in an animal under the influence of white of egg will precipitate only white of egg, but will have no effect on other proteins; a precipitin produced under the influence of a protein taken from a goat will precipitate only this goat protein; and so on.

The fact of precipitin formation has been put into practical use in several ways.

1. The proteins of different species of animals may be very much alike, so far as the tests of the chemical laboratory show, but the living protoplasm can detect specific differences. Because of the formation of precipitins it becomes possible to determine whether a given drop of blood, for example, is of human origin or from some other animal. This is often important in legal trials.

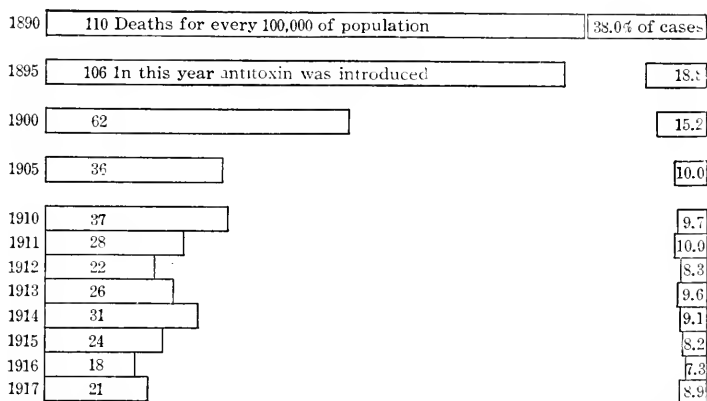

FIG. 72. Reduction in deaths from diphtheria in New York City (Manhattan and Bronx)

The numbers and rectangles on the left show the number of deaths out of every hundred thousand of the population. The numbers on the right show how many fatalities there were for every hundred cases of the disease. Note the rapid falling off in both the proportion and the number of deaths after the year 1895, when antitoxin was first used

2. In the examination of food products that contain materials from various sources, it is impossible to determine, by the usual chemical methods, from what organisms the materials were obtained. By means of the precipitin tests, however, it is possible to find out whether a given sausage, for example, contains pork or beef or horse meat.

3. Experiments now under way in laboratories and hospitals make it appear probable that this principle will have wide application in the diagnosis of disease.

224. Antitoxins. In the bodies of various plants and animals are found proteins that act in a peculiar way upon the blood of higher animals. They act as poisons that stimulate the living cells, and especially the white blood cells, to produce

specific neutralizing or counteracting substances. This class of poisons is now known by the name *toxins* (from a Greek word meaning "poison") and is illustrated by the venom of the rattlesnake and of some other snakes, by a certain protein found in the seeds of the castor-oil plant, and by one found in the bark of the black locust. The substance produced by the live cells under the influence of a toxin is called an *antitoxin*, and it is always specific; that is, it will neutralize the poison under whose stimulation it was produced, but no other.

The best-known toxins are those produced by certain bacteria, especially those that cause lockjaw and diphtheria. When a quantity of toxin, not enough to kill, is injected into the blood of an animal (for example, a horse), the cells begin to throw off antitoxin. They will produce more than enough antitoxin to neutralize the poison received. After

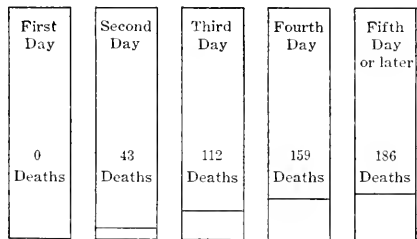

FIG. 73. Danger in delay

Each rectangle represents one thousand children suffering from diphtheria. Antitoxin was administered to all the children on the days indicated. The number of deaths in a group increases with each day's delay in the use of antitoxin

the poison has all been destroyed, there will be a quantity of antitoxin in the blood. If now a larger quantity of the poison is introduced, some of it will be at once neutralized by the free antitoxin; and if the animal is in good health, an additional quantity of antitoxin will be produced. In this way it is possible to increase the amount of antitoxin in the blood until there is several hundred times as much as would be necessary to neutralize very many fatal doses of the poison.

In preparing antitoxin for diphtheria this is practically the method followed. In two or three months the blood of the horse contains a large amount of antitoxin. Blood is drawn from a vein in the neck and is allowed to clot. The serum now contains all the antitoxin.

The use of the antitoxin is coming to be quite general in the treatment of diphtheria, and in the prevention of diphtheria in the case of people who have been exposed to infection. The efficacy of the treatment depends upon its being introduced early enough to neutralize the poison given off by the bacteria before these have gained any headway in the body of the patient.¹

Antitoxin serums have been prepared for *tetanus* (lockjaw), for snake bite, for scorpion sting, and for castor-bean poisoning.

225. Agglutinins. In the case of typhoid fever it was found that if a few drops of the serum from a patient are mixed with a few drops of liquid containing typhoid bacteria, the bacteria are all clumped together in masses, instead of floating about separately. This illustrates the formation in the blood of a substance that acts upon bacteria by *agglutinating* them, or sticking them together. Such substances are called *agglutinins*, and, like precipitins and antitoxins, they are specific. Although the agglutinins do not kill the bacteria, they probably interfere in some way with their action (see Fig. 74).²

226. Cytolysins. When the blood of a human being or other backboned animal is examined under the microscope, the red corpuscles and the various white corpuscles are seen to float or move about apparently unaffected by one another. But if some blood of a different species of animal is injected into the veins of a rabbit or mouse, the foreign red corpuscles

¹ The gain that has come through the discovery of the principle of antitoxin formation, and through its application, can be measured in terms of reduced loss of life. This may be measured in two ways:

1. Out of all the population, what is the reduction in the proportion of those that died of diphtheria?
2. Out of all the people who get the disease, what is the reduction in the proportion of those that die?

Both of these sets of facts are given in the diagrams on pages 194 and 195.

That it is always safest to use antitoxin as early in the history of a case as possible is shown by facts like those given in the diagram (Fig. 73) based on hospital records.

² After a mass of typhoid bacteria has been agglutinated by a serum it is still possible to get the same bacteria to multiply in a suitable medium.

are presently destroyed, being dissolved by a specific substance that is capable of dissolving these foreign *cells*. *This cell-dissolving substance is not constantly present in the blood, but is formed after the foreign cells are introduced.* These *cytolysins*, or "cell solvers," are formed not only in response to the foreign red corpuscles; they may be formed in the presence of other kinds of cells, as of different tissues or of various bacteria; and they are always specific. Thus, the serum of a rabbit that has been treated with human blood will dissolve the red corpuscles of human blood when the two are mixed in a glass, but not the corpuscles of any other animal. The serum of a person whose blood has been treated with dead typhoid bacteria will dissolve typhoid bacteria when the two are mixed in a glass, but not other species of bacteria.

These facts are utilized practically in vaccination against typhoid fever, and no doubt other diseases will be found susceptible to the treatment. A measured quantity of *dead* typhoid germs is injected into the body. The specific cytolysin is formed by the action of the live cells. Later, when live typhoid germs get into the body, they are dissolved by the cytolysin already present.

Recently a specific cytolysin active against the cells that cause cerebrospinal meningitis has been produced experimentally in monkeys by Dr. Simon Flexner of New York, and the serum of these animals may be successfully used in treating the disease in human beings.

The cytolysis test may also be used like the precipitin test in the differentiation of blood stains etc. (see p. 194).

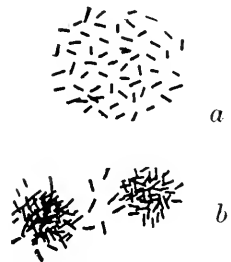

FIG. 74. Agglutination of typhoid bacilli

a, bacilli swimming about separately; *b*, the same clumped together, or agglutinated. The Widal test for typhoid fever consists in mixing a few drops of serum from the suspected person with a quantity of typhoid bacteria under the microscope. If agglutination takes place, the person is known to be infected with typhoid germs

227. Opsonins. Although the white corpuscles (or rather certain kinds of them, for there are really several kinds of colorless corpuscles in our blood) will "eat" foreign particles, including many kinds of bacteria, they will do this only under certain chemical conditions. A substance which thus makes the bacteria "attractive" to the corpuscles is called an *opsonin*, which comes from a Greek word meaning "to prepare a meal." The activity of the cell-eating corpuscles depends upon the presence of a suitable quantity of the right kind of opsonin. The production of opsonins may be stimulated by the introduction of small quantities of dead or living bacteria of various kinds.

228. Vaccines and vaccination. We have seen that the blood meets the invasion of foreign bodies or foreign substances in several different ways, all of them depending upon the vital properties of the cells of the body, and especially of the white corpuscles. In recent years various methods for increasing the resistance of the body to specific diseases have been developed by using in some cases one of the blood's reactions, in other cases another. All of these are roughly classed as *vaccination*.

In some kinds of vaccination cytolysins are produced; in other kinds, opsonins or antitoxins.

229. Immunity and susceptibility. Individuals differ so greatly that some are much more sensitive or much less sensitive to certain substances than others. Now we find that sometimes, or in some people, the blood is extremely sensitive to foreign substances of a particular kind. It is a matter of common observation that some people catch colds more easily than others; some more frequently have boils or pimples; some are more susceptible to typhoid or to diphtheria.

Not only do individuals differ one from another; there are also racial differences. Thus, the dark-skinned races are less susceptible to malaria and to hookworm than the white races; on the other hand, the white races are less susceptible to tuberculosis and measles than the dark races.

More than this, there are important specific differences. Just as hens are quite indifferent to the action of morphin, and as rabbits are insensitive to atropin, human beings are quite immune to diseases that are serious or even fatal to birds or cattle. Such immunity is called *natural immunity*, and is inherited. In many cases it probably depends upon the chemical peculiarity of the blood or the body juices; in others it depends upon the quick response of the live cells to the poisons and other products of the bacteria. But such natural immunity is not absolute; that is to say, it may be weakened or destroyed by various conditions.

We may see from these considerations how important it is to guard the natural immunity of the body against the destructive effects of undue exposure to extremes of temperature, to excessive fatigue (or insufficient rest and sleep) or overwork, and to prolonged hunger or thirst (or improper nutrition). We can also understand the importance of suitable conditions and habits of ventilation and of exercise in maintaining the resistance of the body, and the danger of using drugs, alcohol, or other substances that interfere with the action of the blood as a living tissue.

Not only the conditions that commonly affect the energy and resistance of the protoplasm, but disease itself may affect the resistance of the body. After pneumonia, for example, one is more liable to catch other diseases than he is ordinarily, and he is more liable to catch pneumonia after typhoid or measles than he is ordinarily. One cannot afford to be sick even a little; that opens the way for more serious trouble.

230. Acquired immunity. It is a well-known fact that one who recovers from certain diseases is practically immune; as the common saying goes, "You can't have measles twice." This is true of mumps, whooping cough, scarlet fever, typhoid fever, and smallpox. This acquired immunity is no doubt due to the substances produced in the blood in the course of the disease. In the case of diphtheria and of some other

diseases, the antitoxin that is formed gradually disappears, so that after some time it is possible for the recovered patient to have the disease again.

Immunity may also be acquired, as we have seen (pp. 196, 197), by artificial means. A passive immunity, lasting a comparatively short time, is acquired by the administration of an antitoxin. This is called *passive* because the blood does nothing to combat the disease; it is simply protected by the substance added to it. An *active* immunity may be acquired by the use of a *vaccine*, which stimulates the live cells to produce the substances that cause the immunity.

231. Disease and heredity. We know that certain diseases have a way of "running in families." That is, a given family may show many members that have suffered from the same disease, as tuberculosis. It was commonly believed until recent times that tuberculosis and other diseases are inherited, in the same sense as the color of the eyes or the shape of the thumb is inherited. We know that this is not true. Where tuberculosis runs in a family, two facts are to be distinguished:

1. Where one member of a family has the disease, the other members are more likely to be exposed to infection than they would be ordinarily, and so the disease spreads in that family.

2. Where a person has tuberculosis (or any other disease), the indications are that this person has not a natural immunity to the disease; in other words, that he is susceptible to it, or has a "disposition" towards it. Now it is this natural susceptibility (or immunity) that is inherited, and not the disease. *No matter how much susceptibility one had to a given disease, he would not contract the disease unless he was exposed to the infection by the specific microbes that cause that disease.*

CHAPTER XXXVIII

WASTES AND BY-PRODUCTS OF ORGANISMS

232. The origin of wastes. Every chemical process results in the formation of substances that did not exist before. In the chemical processes that take place in the cells of a living organism, substances are produced that are directly related to the protoplasm's being "alive." Other substances, which are of no direct use to the living body or to the living process, are produced incidentally. The latter are called *wastes*, and may be compared to the sawdust of a mill, or to the smoke that goes up the chimney, or to the ashes that drop through the grate.

233. Removal of wastes from cells. In our study of photosynthesis (p. 54) we found that one of the wastes or by-products is oxygen, which diffuses out of the chlorophyll-containing cells through the cell walls. In our study of energy (p. 143) we found that carbon dioxide, water, urea, and other substances may be produced. These also diffuse out of the cell.

In plants water and carbon dioxide are usually eliminated in the form of vapor. The carbon dioxide given off by the cells of the roots usually remains in solution, forming so-called *carbonic acid* (see Fig. 42, p. 144).

Plants often dispose of their waste substances in a way that seems to be beneficial to them; and the same is true of animals (see p. 203).

234. Accumulation of wastes in plants. The waste substances produced by plants (outside of water and carbon dioxide) are generally not eliminated from the body. They are usually combined into insoluble or non-diffusible compounds, and in this condition they are accumulated in dead cells in parts

of the plant where they do not interfere with the vital activities. There are many classes of such waste compounds.

1. Among the most common waste substances found in plants are various *pigments*. These are familiar to us in the autumnal colorings of leaves, in the bright colors of many flowers and fruits, and in the pigments of woods and roots. The red of the radish, of the rose, and of the maple leaf, the yellow of the buttercup, of the pumpkin, and of the carrot, and the blue of the pansy and of the huckleberry, all are examples of the waste products that are deposited in out-of-the-way cells (Fig. 75).

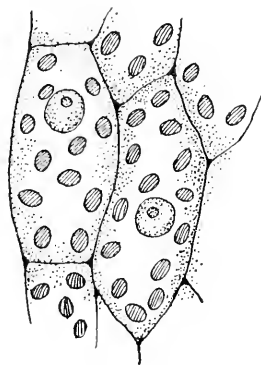

FIG. 75. Pigment bodies in plant cells

Most of the pigments found in the cells of plants are probably in the nature of waste products. Some pigments occur in solution; others are found attached to protein particles, forming definite colored granules

2. The attractive *odors* of many flowers, preserved for us in perfumes and essences, and the flavors of the many spices are due to *essential oils* deposited in out-of-the-way cells of plants. They are found in the flower, the leaf, the fruit, the bark, the wood, and even in the root.

3. *Tannins* are chemical compounds related to tannic acid which have the property of forming hard, insoluble compounds with proteins. They are commonly found in the bark of trees, but may also occur in other parts of the plant — often in unripe fruits.

4. The *acids* that we find in fruits especially, although they are present in other plant organs, are derived from substances diffused out of live cells. *Alkaloids* (see p. 74) and other poisonous substances found in plants, and the gums and resins, are also waste products.

5. The excess of *mineral matter* absorbed from the soil is separated out of the live cells by being deposited in cell walls or by being precipitated as insoluble compounds in certain of

the cells. Sand (silica) is thus found in the scouring rushes and other plants; and crystals of oxalate of lime are found in hundreds of plants—for example, in the root of the jack-in-the-pulpit and in other sharp-tasting plant parts (Fig. 76).

All these waste substances are useless to protoplasm, and many of them are even injurious. But, separated as they are from the living parts of the organism, they may nevertheless be of some value to the plant as a whole, or to the species, in some special relation. Thus, the pigments and odors of flowers may be of use in relation to insect visits (see pp. 310–314); or essential oils and tannins may be of value in protecting plants from animals and from bacteria or fungi.

235. Excretion in animals. The one-celled animals excrete their wastes just as they excrete carbon dioxide. In the higher animals, those that have blood and lymph, the wastes are diffused into these conducting fluids, and are then eliminated from the body through special organs, for the most part.¹

236. The kidneys. In the human body, which in this respect is typical of the backboneed animals, the *kidneys* are the special excretory organs. Water and carbon dioxide are, as we have already

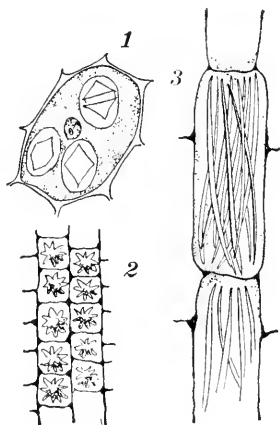

FIG. 76. Crystals found in plant cells

1, in seed of castor-oil plant; 2, in bark of a tree; 3, in bulb of squill. Crystals in plant cells often represent an accumulation, or a locking up, of superfluous mineral matter

¹ To a comparatively slight extent the waste products of animals, like the waste products of plants, are accumulated in some of the cells. Thus, many of the pigments found in animals are no doubt to be considered as in the nature of wastes deposited in the cells of the skin, or even in the interior of the body. Much of the lime found in the skin of such animals as the starfish or the sea lily, and the coral framework of the coral polyp, no doubt fall into the same class.

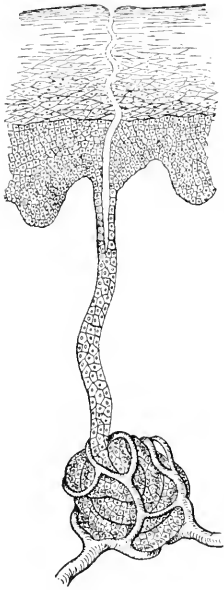

FIG. 77. A sweat gland

The sweat gland consists of a fine tubule opening to the surface of the skin at one end and coiled up in a knot at the other. The coiled portion is surrounded by blood vessels (capillaries) from which water, urea, and salts are withdrawn into the gland tube

learned (see p. 148), excreted from the lungs; small amounts of urea, and possibly other organic wastes, also leave the body through these organs. Some water, salt, and urea, with traces of other organic wastes, leave the body by way of the sweat glands, and some reach the intestines and are then thrown out. But most of the waste is eliminated by way of the kidneys.

The kidneys, of which there are two, may be considered as glands whose function is the separation from the blood of certain specific substances (as urea, salt, etc.) and water (Fig. 78).

237. The sweat glands. The sweat is excreted by special glands which consist of delicate twisted tubules surrounded by a network of capillaries (Fig. 77). Waste material, with water and salt, is constantly passing from the capillaries into the tubules, and through these out upon the surface of the skin. Ordinarily the water part of the perspiration evaporates as fast as it comes out of the glands, leaving a solid deposit of the wastes.

When perspiration is more rapid, we can see the drops of sweat on the skin. When this dries, the solid deposit is left on the outside of the skin, instead of in the mouths of the tubules.

CHAPTER XXXIX

HYGIENE OF EXCRETION

238. Hygiene of the kidneys. The kidneys work continuously. Their work can be facilitated by drinking plenty of water every day, and by emptying the bladder with sufficient frequency to prevent discomfort. Aside from maintaining the general health of the body, there is nothing else that we can do for the kidneys; and, indeed, nothing else needs to be done.

Where a generation ago workers quenched their thirst with beer and other prepared drinks, now employers and managers of factories and shops are finding it worth while to provide an abundance of clean, cool, and palatable drinking water. In some states the law requires that suitable drinking water be supplied in all workrooms. In a similar way the provision of suitable toilet rooms, from being a casual accommodation or convenience, is coming to be recognized as a real necessity not only by the opinion of the experts but by the framers of laws. The more progressive cities are also taking steps to provide suitable drinking water for all on the streets and in public places, as well as comfort stations for all who have to be abroad.

An understanding of the intimate relation between the wastes of the tissues and the secretions of the kidneys has made possible the development of special methods of diagnosis through the chemical and microscopic examination of the urine. The sugar and the albumin and the uric acid that the expert discovers in the urine are to be considered as indications of the general condition of the body, or of certain organs, and not necessarily of the condition of the kidneys.

The effect of alcohol upon the kidneys is related to the fact that it causes a congestion of capillaries. When the capillaries of the kidneys are congested, the excretion of wastes

is to that extent impeded, and the whole body suffers in consequence of the retention of urea and other poisonous by-products of protoplasmic activity.

239. Hygiene of the skin.

The skin is more than an excreting organ; indeed, the excretory work of the skin may be considered rather incidental. Other functions of the skin are as follows:

1. Protection of the body (*a*) against mechanical injury, (*b*) against drying up, and (*c*) against excessive radiation of heat.

2. Regulation of the body temperature.

3. Perception of sensations of touch, heat, etc.

But it is the secretions of the fat glands and the perspiration (see Fig. 77) that give rise to the need for special attention to the skin.

The accumulation of wastes left behind when the perspiration

evaporates and the catching of dust in the oil secreted by the oil glands, and in the pores through which the oil is secreted, call for periodic bathing. The best way to remove the accumulated wastes and dirt is by means of hot water and soap, with the help of a brush. But hot baths have a debilitating effect, forcing the blood into the capillaries of the skin and thus away from the muscles, brain, and internal organs. A warm bath once or twice a week should be enough for ordinary cleanliness if these supplement a daily cold bath.

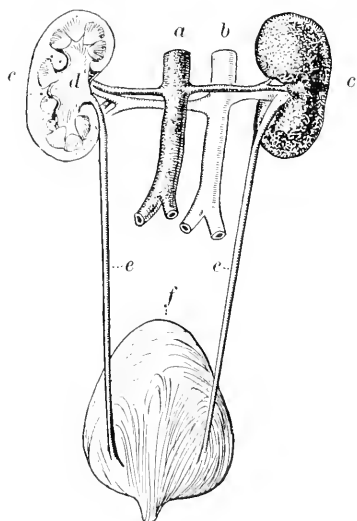

FIG. 78. Kidneys and bladder

a, the main artery, and *b*, the main vein, in the abdominal cavity, giving off branches to the kidneys, *cc*; *d*, funnel-shaped cavity in which the waste fluid is gathered by the gland action of the kidney; *ee*, tubes leading from the kidney to the bladder, *f*. The left kidney is represented as cut through lengthwise

For those who can stand it a daily cold bath is refreshing and at the same time an excellent training for the skin in adjusting itself to changes in temperature. The cold bath should never be taken when the body is exposed to cold, however. The best time is immediately upon rising, or immediately after physical work or exercise that has produced copious sweating. But since there are many people who cannot tolerate the cold bath, because of the after-effects of the shock, it is not to be generally recommended. Each one must find out for himself whether he can benefit from it. All of us can stand a splash of cold water after a warm bath or, in the morning, over the chest and back; and probably most of us can gradually learn to stand the cold bath, either by systematically lowering the temperature of the water used, day by day, or by increasing the surface to which cold water is applied with a sponge. In any case the cold bath should be followed by a brisk rub with a rough towel.

It is hardly necessary to remind anyone that bathing will not maintain cleanliness if the underclothing is not changed with sufficient frequency.

240. Exercise. The value of exercise for the muscles, for the heart, for the breathing, for the digestion, and for the work of the bowels has already been mentioned. The value of exercise for the skin and the excretion generally is worth noting. The slow, continuous perspiration, of which we are not aware, leaves deposits of wastes in the tubules of the sweat glands. More rapid perspiration washes these wastes out. Exercise that results in sweating cleans out the pores. In so far as exercise accelerates the flow of the blood, it contributes also to the more rapid removal of wastes through the kidneys.

CHAPTER XL

EXCRETION AND FATIGUE

241. Getting tired. When you "chin" yourself on a bar four, five, six times, until you can do no more, this does not mean that you will never be able to chin yourself again. After resting awhile, perhaps a day or an hour, or perhaps only ten or fifteen minutes, you can chin yourself again as well as at first. What happens in the first place to make you stop, or what happens during the rest to enable you to do the work again?

A modern explanation is that the waste substances begin to accumulate in the cells as soon as the work commences; the wastes are formed faster than they can be carried away, and the result is a poisoning of the protoplasm of the working cells. Experiments have enabled us to discover the importance of these wastes.

242. Fatigue poisons. If a muscle taken from the leg of a frog is made to work (by being stimulated with an electric current) until it is too tired to do any more, it may be restored to working power by the simple process of washing it in salt water. The salt water certainly does not supply fuel to the muscle; on the contrary, it would seem rather to take something away. Moreover, if the salt water that has been used to wash the tired muscle is now injected into a fresh muscle, one that has not been working, the latter immediately becomes too tired to work. This would show that some unknown substance has been taken away from the tired muscle to make it fresh, and that this same substance has been added to the fresh muscle to make it tired. This substance has been called *fatigue poison*.

The presence of fatigue poisons has been shown repeatedly by experiments similar to the above. For example, a dog has been kept running until he is very much fatigued; some of this dog's blood is then introduced into the veins of a dog that has been kept quiet the whole day. Immediately the resting dog shows all the signs of being a tired dog.

243. Fatigue may be general. We have all been taught that "a change of work is the best kind of rest." To a certain extent this is true. When I am reading a hard book

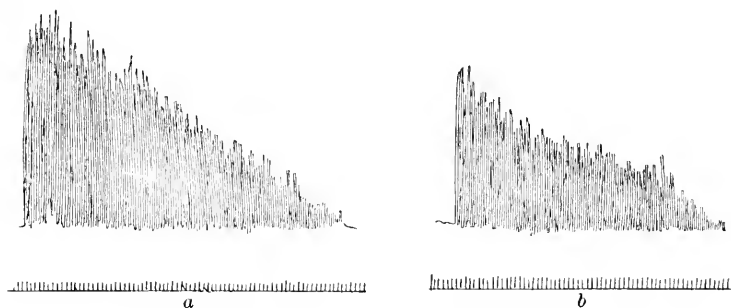

FIG. 79. General fatigue as measured by the ergograph

The ergograph records the frequency and the strength of a pull exerted by a finger, the rest of the hand being held firmly in place. These two records were made by a medical student on the same day: *a*, before beginning his day's work at college; *b*, at the end of the day's work. The height of the vertical lines shows the difference in energy, or strength, of each pull. The difference between the bases shows relative time of application

and begin to doze over it, I am not too tired to play a game of tennis or even to read an interesting novel. But beyond a certain point fatigue affects the whole body; getting tired from study unfits one for muscular work or play. This is shown by certain kinds of experiments that were first carried out in Italy.

Records made on the ergograph by any person will show great variations, according to the condition of the body. A record made early in the morning will differ from one made at the end of the day; a record made after taking a nap in the afternoon will differ from one made at the close of a game of chess (see Fig. 79). Although

the people who made these tests did not use the middle finger in their work, this finger showed different degrees of fatigue in accordance with either the physical or the mental work done before the test was made.

We have learned from these and similar experiments that exhausting physical work tires the brain and the sense organs; and we have learned that severe mental work tires the whole body.

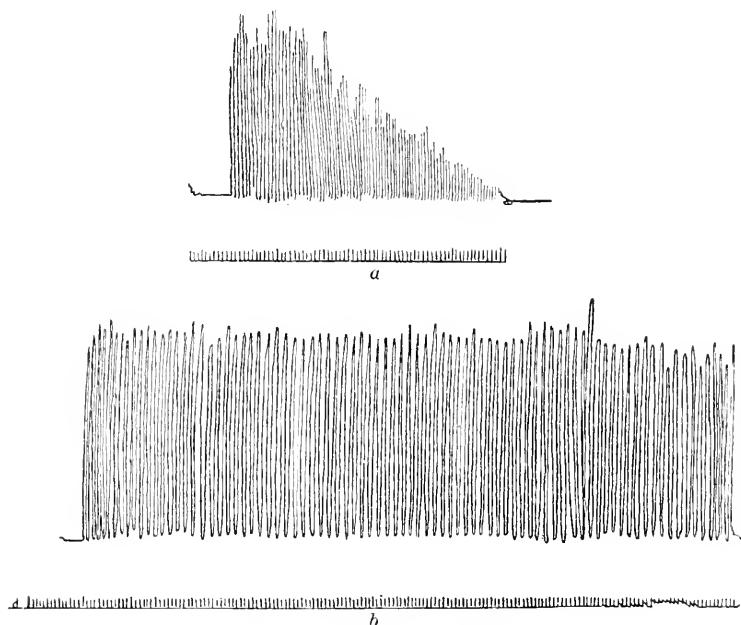

FIG. 80. The pace and fatigue

These two ergograph records were made by the same student on the same day. *a* was made by pulling as rapidly as possible, and shows rapid accumulation of fatigue; *b* was made by a slow, steady pull every two seconds, and although the time was twice as long as in *a*, and the work performed about four times as much, there is no appreciable evidence of fatigue

It is not to be concluded, however, that hard work is to be avoided. On the contrary, hard work is useful physiologically, as well as morally and economically. But we must use this knowledge to help organize our work in a more effective way.

244. Rate of work. When we come to think of it, we shall recall that getting tired is not altogether a matter of what kind of work we are doing; it is partly a matter of how fast we are doing it. "It is the *pace* that kills" (see Fig. 80). Physiologically this means that at a certain rate or speed fatigue poisons are formed faster than they can be removed by the blood, and from the blood by the kidneys, etc., and that when the work is done at a certain slower speed, the blood can remove the wastes just as fast as they are formed. When you walk very fast, you may feel tired before you have gone a mile, although you are not out of breath; if you walk slowly enough (but not too slowly), you may walk ten miles without showing any signs of fatigue.

We may therefore conclude that work can be kept up best if we take the right pace. Work that is speeded may give larger returns in a given time — but only for a short time. If the high speed is maintained, the worker will have to stop sooner or the quality of the work will fall off. This principle has its everyday applications in athletics, in play, in housework, in school work, and in industry.

245. Fatigue and efficiency. When Frederick W. Taylor, the founder of scientific management, wanted to increase the output of useful work on the part of some unskilled workers, he did not urge them to work faster. Instead, he carefully experimented to find out how fast the necessary movements could be performed without accumulating fatigue poisons during the hours of work. He actually made the men move more slowly than they had been accustomed to. And in shoveling dirt and carrying pig iron he more than doubled the day's work without increasing the day's fatigue. This principle is so well recognized among the leaders in scientific management of works that the efforts of the experts are directed to devising plans that will prevent fatigue on the part of the workers. These plans usually contain two sets of factors, one mechanical and the other biological.

The mechanical problem is to find out the fewest movements that are necessary for performing the work. The biological problem is (1) to arrange the material and the machinery and tools in such relations to the body of the worker as to put the least strain on the muscles, the attention, the sense organs, etc., and (2) to establish a pace that will result in a maximum of output with a minimum of fatigue.

In other words, the efficiency of the day's work will depend not only on the nutrition and respiration and training of the worker but also to a very large extent upon the prompt elimination of wastes from the working cells.

CHAPTER XLI

FATIGUE AND THE WORKER

246. The hours of work. No matter how slowly one works, it is impossible for him to keep on working indefinitely without rest. How many hours a day should a person work? How many hours a day may one work and play and still maintain his health? There was a time when mill workers had to be at their tasks sixteen and eighteen and even more hours a day. They lived, but they died young. The shortening of the work-day has certainly played a large share in the lengthening of the work life.

With an excessive length of working day the body never has time to catch up with the elimination of wastes. Fatigue accumulates from day to day, and sooner or later the machine is clogged beyond further use. It is, then, a question whether it is more economical to work long hours for a few years or to work short hours for a longer period. From the point of view of making the other person produce profits for me, it has often seemed best to work him for all he is worth, and then, when he is used up, to get someone else. But from the point of view of the worker and from the point of view of society this is certainly poor economy. Especially true is this when it comes to considering the work of children (see Fig. 81).

The injurious effects of long working days upon the worker is coming to be realized by the workers and by society at large. This realization shows itself in two ways :

1. The workers are constantly demanding a shorter and shorter workday.

2. Legislation is constantly readjusting the legal workday on a shorter and shorter basis.

This official demand for shorter hours rests chiefly on two considerations :

1. The human stock must be preserved from the evil effects of overwork, and the ordinary methods of bargaining about hours and wages cannot be relied upon to secure what is fair for the workers.

2. In certain occupations the fatigue of the worker is a direct menace to the public.

This is especially true in such occupations as railroading of all kinds, elevator-operating, work on boats and ferries, and the work of drivers and chauffeurs, telegraph and telephone operators, etc.

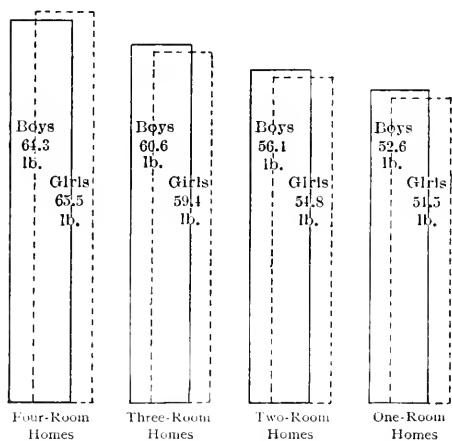

FIG. 81. Environment and physique

Dr. Leslie Mackenzie had the weights and heights taken of all the school children (73,848) of Glasgow. The diagram shows the average weights of boys (solid lines) and of girls (broken lines), divided according to the kinds of homes the children lived in. All the studies made show that poor food, disease, *overwork*, poor housing, and other conditions in the environment produce measurable deteriorations in the physique of growing children

We cannot get the best results from our work if we have fatigued ourselves with play in the morning; nor can we enjoy our play if we have worked too hard during the day.

247. Work and rest. It is important to find out what kinds of work are most fatiguing, and what arrangements of work and rest, or what alternations of work, will make possible the greatest amount of effective activity, with the least strain on the human body. Short rest periods during the day, the alternation

In planning our own programs we should keep in mind the relative amount of effort and the relative amount of fatigue connected with each kind of occupation.

of physical and mental work, the distribution of work that requires little or no active attention, are devices for achieving these ends.

In many offices and factories it is coming to be customary to introduce a "pause" of from five to fifteen minutes in the middle of the afternoon. During the pause no work is permitted, and it is found that the total output is increased rather than diminished in this way.

In schools similar ideas are being put into practice. Physical exercise for a few minutes between study or recitation periods stimulates the flow of blood and so increases cell respiration and excretion.

In spite of all the precautions that we know should be taken, many people, and even many children, suffer from chronic fatigue. This condition shows itself in restlessness and irritability, in lack of appetite, in languor and lack of concentration, in sleeplessness or disturbed sleep, in loss of weight, and in a certain drawn expression on the face. When fatigue poisons have got a little ahead of the excretory system, the best thing to do is to take as complete a rest as possible.

248. Fatigue and health. Fatigue poisons affect the gland cells as well as the nerve and muscle cells; hence the frequent indigestion from meals eaten when the body is fatigued. Fatigue poisons also affect the white corpuscles, and the chemical activity of the cells generally, so that, when fatigued, a person is more liable to catch colds, as well as other infectious diseases.

We may well conclude that it does not pay to become chronically fatigued, although there is nothing better than getting "good and tired" every day, and then getting over it again by the next morning. This means that sufficient sleep is one of the prime necessities of healthful and efficient and happy living. People whose day's tasks are too long are most likely to get their fun in time taken from sleep.

It is during sleep that the working and growing cells can make up for the losses of the day's work; it is also during sleep that the excretion can catch up with the day's accumulation of wastes.

249. Standardizing work conditions. At the outbreak of the Great War the sudden need for a rapid increase in the production of all sorts of supplies and munitions led the managers of industry to increase the number of hours of work and to "speed up" the workers in factories. They also arranged to continue work on Sundays and holidays. This was especially true in England. After some months of this intensive activity it was found that the high rate of production could not be maintained, and that there was a great deal of ill health and of physical breakdown among the workers. A commission was appointed to inquire into the health of munition workers. Among the important discoveries made by this commission were the following :

1. The increase in the number of hours of work was bad both for the health of the workers and for the effectiveness of their work.

2. The continuous work, day after day, without weekly rest days, was bad for the health of the workers as well as for the standards of production.

As a result of this and of similar investigations many factories in Europe and in this country have established new methods of determining the speed at which work shall be done. They have divided the day's work into short shifts, or "tricks," which permit fatigue products to be eliminated, instead of forcing them to be accumulated in the bodies of the workers. As a consequence, production has been increased, accidents have been reduced, and the health of the workers has been greatly improved.

CHAPTER XLII

NERVES AND THE REACTIONS OF ORGANISMS

250. What we cannot help doing. No child can keep his face composed and look unconcerned when he is properly tickled. He bursts out laughing, or he draws away the tickled part, or he does both. And when he does any of these things, *he cannot help it*. When something suddenly approaches your eyes, you wink, and you cannot help it.

251. Reflexes. Movements of the kind mentioned, which take place without any intention or desire on the part of the agent, in direct response to some disturbance or stimulation, are called *reflexes*. Some reflexes are useful, as winking, or sneezing, or coughing, or withdrawing the hand when "it hurts."

Reflexes need not result in movements. The "funny-bone" reflex carries with it a definite sensation. Indeed, that is about all that we are aware of when the funny bone is struck. This suggests that there are some reflexes that are not altogether confined to movements. We have already come across reflexes that do not involve movements at all. The increased flow of gastric juice in response to the stimulation of pleasant food, and the watering of the mouth on the mere sight of pleasant food, are examples of reflexes that let themselves out in glandular activity.

252. Using an animal's reflex. If you ever catch a fish with a hook and line, you depend upon a reflex for your success. The fish responds to the vision of certain kinds of objects by snapping at them with his mouth. You simply have to make sure that you have the right kind of bait, and that it is properly fastened to the hook, and that it is dropped into the water at a suitable depth. Your "luck" depends upon the fish *seeing* the bait, and the reflex does the rest.

253. Reflexes and tropisms. Reflex actions of animals differ from the *tropisms* which we studied in the young plants, both in the greater speed with which they are executed and in the kind of structure which brings them about. The reflexes all depend upon certain connections of *nerves*, *muscles*, and special perceiving organs, such as the eyes, ears, tongue, etc. To understand the mechanism of the reflex we must therefore know something about these three kinds of organs.

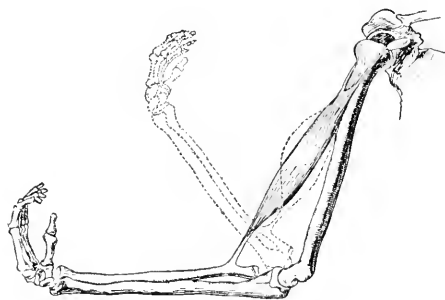

FIG. 82. Contraction of a muscle

The movement of an organ, as the forearm, is brought about by the contraction of a muscle. The mass of muscle cells becomes shorter and thicker, the parts to which its ends are attached being brought closer together

254. The muscle.

We all know in a general way that the muscle is the "thing that makes us move." We also know the appearance of a muscle from having handled and eaten the flesh of animals.

When thousands of millions of such cells contract at the same time, we can see that the whole mass will be considerably shortened. An ordinary muscle of the body, such as draws up the forearm or one of the fingers, is essentially a bundle of several masses of muscle cells, together with connective tissue, blood vessels, and nerve connections (Fig. 82).

255. Kinds of muscle. The muscles that are most familiar to us are the skeletal muscles (those attached to bones of the skeleton) of such animals as we use for food — chicken, lamb, ox, etc. We have already learned that there are other muscles, however, such as the muscles of the heart (p. 186) and of the diaphragm (p. 149). The muscles connected with the skin manifest themselves to us in the facial expressions of those we see about us, in the movement of the ears (of which

many of us are still capable), in the twitching of a horse's skin when it is annoyed by flies, and in winking. And, finally, we may recall the muscles of the esophagus, the stomach, the intestines, and the blood vessels.

Some muscles are called *voluntary* and some *involuntary*, but all muscles contract in response to a *stimulus* received from a nerve cell.

256. Nerves and nerve cells. The nerves that are found running to all organs of the body are compounded of many nerve fibers. Many such fibers, bound together by connective tissue and associated with blood vessels and lymphatics, constitute a *nerve*. For our

present purpose we are not so much concerned with the nerves as we are with the nerve cells which compose them.

The *nerve cell* consists of (1) the *cell body* and (2) certain *processes*, or outgrowths (*fibers*); together these make up a unit of the nervous system. Such a unit is called a *neuron*, and may be compared to a muscle cell as a unit of a muscle, or to a

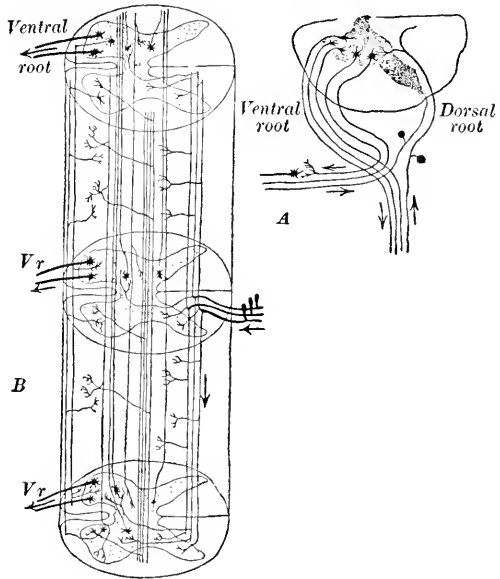

FIG. 83. Diagram of the spinal cord

A, left half of cross section, showing impulses entering the dorsal root and outgoing impulses passing out by the ventral root. B, the neurons connected with the gray matter of the cord give off branches passing up and down the cord and transmitting nervous disturbances by way of the collaterals. In the gray matter of the cord, branches of afferent neurons carry impulses up and down and pass them on, by way of the collaterals, to efferent neurons and to the brain

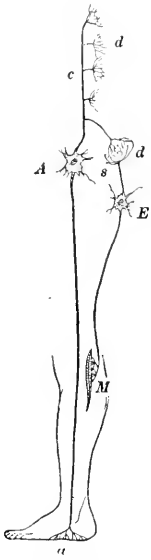

FIG. 84. Reflex arc
Stimulation of the receiving end *a* of an afferent nerve *A* leads to a discharge of energy to all parts of the neuron, including the fine terminals, or *dendrites*, *d*. The discharge passes over to connected nerves, as the *efferent* nerve *E*, by way of the interlacing dendrites, or *synapses*, *s*. The discharge in *E* leads to the stimulation of the organ with which it is connected, as a muscle *M*. The disturbance passes from *a* to the spinal cord, where it is reflected by one of the side branches, or *collaterals*, *c*, of *A*, through the synapse *s* into *E*, leading to a movement by the contraction of *M*

gland cell as a unit of a gland. It always *acts* as a unit (see 7 in Fig. 4).

The *cell bodies* are found chiefly in the cortex, or rind, of the brain, in the core of the spinal cord, and in special groups (called *ganglia*) in various parts of the body. Occasionally single cells are also found.

The *processes* are of two kinds :

1. The long, slender fiber extending, with other fibers, through the nerves, is called the *axon*.
2. Shorter processes, of which there may be several, usually branching irregularly, "like the branches of a tree," are called *dendrites* (from a Greek word meaning "tree").

In some neurons a stimulation, or disturbance, is received by the delicate branching ends of the axon and transmitted to the cell body. In other neurons the disturbance is received by the delicate endings of the dendrites and transmitted to the cell body and on through the axon.

The axon may be very short, as in the neurons of parts of

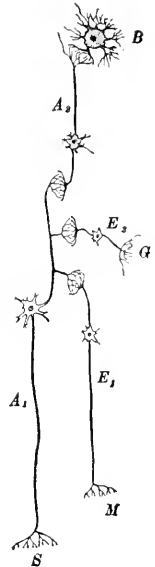

FIG. 85. Afferent and efferent nerves

Disturbance of a sense organ *S*, connected with an afferent nerve *A₁*, may set up nervous discharges in several connected nerves. There may be a muscular reflex through the efferent nerve *E₁*, connected with a muscle; there may be a gland reflex through the efferent nerve *E₂*, connected with a gland; and there may be a sensation, or feeling, through the disturbance of a brain cell *B*, by a discharge through 2 connected neuron *A₂*

the brain, or as in some neurons in the gray part of the spinal cord; or the axon may be very long, like those in the neurons extending from the lower part of the spinal cord to the ends of the toes or through the length of the arm.

257. Kinds of neurons. The following different types of neurons may be recognized.

1. Those that *bring impulses toward* the cord or brain, — the *afferent*, or sensory, neurons.

2. Those that *carry impulses from* the cord or brain, — the *efferent* neurons that may stimulate a muscle or a gland.

3. Those that *connect* afferent and efferent neurons, which we may call *associative* neurons.

4. Neurons in the brain, many of which are not directly related to reflexes but are related to knowing and feeling and the voluntary control of muscles.

258. Nerve connections in a simple reflex. Suppose that your finger touches something hot. The *nerve endings* in the skin are disturbed, and the disturbance of the protoplasm is transmitted to the rest of the neuron in a fraction of a second. The fiber of the affected cell sends off a number of branches in the spinal cord (Fig. 83), and the dendrites at the ends of these collaterals form fine networks with dendrites of other neurons.

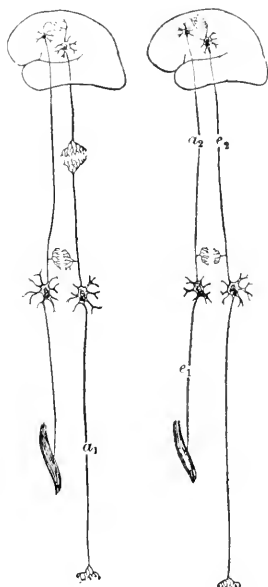

FIG. 86. Behavior limited by nerve connections

The diagram shows the nerve connections of a simple muscular reflex, with collateral connections to the brain. Such connections make possible automatic reflexes as well as voluntary movements. If the afferent nerve is cut, as at a_1 , only voluntary movement is possible, and there is no sensation. If the efferent nerve is cut, as at e_1 , neither reflex nor voluntary movement is possible, but sensation remains. If the spinal cord is cut high up, as at a_2, e_2 , neither sensation nor voluntary movement is possible, but the reflexes are not affected

These interlacing dendrites allow the nerve action to pass over from one cell (neuron) to another (Fig. 84). It is possible that in this region the protoplasm of one neuron is in touch with the protoplasm of the next one, so that a disturbance passes from one cell to the next just as it might pass from one part of a single cell to another part.

The disturbed spinal-cord cell sets up nerve action in an efferent muscle nerve, with the result that the arm or hand is drawn back. At the same time, it sets up nerve action in a fiber leading to a brain cell, with the result that you become aware of the pain. But the movement has taken place before you realize what has happened. The nerve disturbance from the finger to the spinal cord along an afferent fiber is *reflected* out through an efferent fiber, which stimulates the muscle to action (Fig. 85).

259. Afferent and efferent neurons. If a certain part of the *sciatic nerve* (which is the main nerve trunk running down the leg) were cut, destroying the *afferent* fibers (a_1 , Fig. 86), one might walk on carpet tacks or hot iron and not know it (unless he happened to be watching his feet), and accordingly one would not jump to escape the damage. Under these circumstances a person would still be able to move his legs or to jump if he wanted to. On the other hand, if another portion of this nerve were cut,—the portion carrying *efferent* fibers (e_1 , Fig. 86),—one would remain just as sensitive as ever to carpet tacks or hot iron or tickling, but he could not move his legs, no matter how hard he tried. And they certainly would not move of themselves, for the reflex arc would be broken in the part connecting the spinal cord with the muscles.

260. Reflexes without consciousness. If the brain of a frog is removed or injured, or if the spinal cord is cut near the brain (a_2 , e_2 , Fig. 86), the animal will still be able to perform a large number of reflex actions similar to the one described. Thus, a frog with its brain destroyed will scratch with its leg at a spot on the skin that has a drop of acid placed upon it.

The sense impression produced by a touch on the skin travels along the axon of an afferent nerve. This disturbance is shunted off, or *reflected*, through a synapse into one or more efferent neurons to the corresponding muscles and results in a movement more or less suitable for the occasion. But this shunting takes place in the spinal cord or in the lower parts of the brain that do not involve feeling or consciousness or willing. No matter how useful or purposeful such actions appear to be, we must understand that reflexes do *not* represent the animal's desires or intentions. In many animals, including man, these reflexes may be called forth during sleep or during unconsciousness produced by ether or chloroform. Under such circumstances it is certain that the movements are not intended, not "done on purpose."

CHAPTER XLIII

TROPISMS AND THE BEGINNINGS OF SENSE

261. Tropisms. In the absence of neurons in the simplest animals we cannot speak of their reflexes. Most of the reactions that have been studied are classed as *tropisms*. Tropisms have been explained as resulting from the unequal contraction of the protoplasm on opposite sides of the body, under the influence of unequal, or one-sided, stimulation.

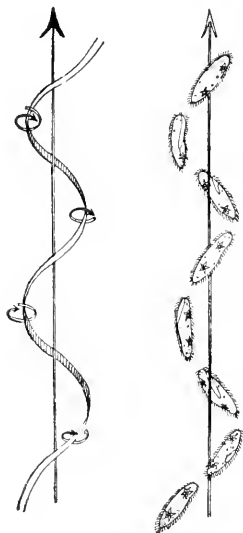

FIG. 87. Movement in Paramecium

In the Paramecium, as in many other free-swimming protozoa (one-celled animals), the organism moves forward by spinning about its own axis and at the same time swinging in a spiral path

262. The general reaction of lower animals. Many organisms are not symmetrical, and many, like the Paramecium, or *slipper animalcule*, make progress in a given direction by moving spirally around the line that represents this direction (see Fig. 87). In response to any disturbance or change in condition, such animals always make the same movement (see Fig. 88).

As a result of this "general reaction" to all kinds of stimuli, the animal manages to escape many dangers, and to get into situations that are frequently advantageous (see Fig. 89).

263. Chemical sense in lowest organisms. The simplest animals, like the roots of many plants, are sensitive to many kinds of chemical disturbance. We cannot suppose that an ameba, for example, has the feeling of *sour* or *sweet*, or

that the Paramecium has an idea of *nice* or *nasty*. But it is very plain that the protozoa are repulsed by the presence of sand grains and attracted by the presence of various kinds of bacteria. They will swallow the bacteria and pass the sand grains by. There is no doubt, however, that the difference between their reaction toward food and their reaction toward inert matter or toward injurious matter is due to a certain relation between the chemical constitution of the protoplasm and the chemical constitution of the outside substances. We should hardly be any more justified in saying that the ameba likes meat juice than we should be in saying that water dislikes oil. In one case, as in the other, the reactions depend upon certain relations between the chemical compositions of the two reacting substances. Water does not *choose* to dissolve sugar and to leave sand undissolved; neither can we be sure that a protozoan *chooses* its food, notwithstanding the fact that it does take some kinds and reject other kinds of objects or materials.

It is only when we come to the higher animals that we may begin to speak of choice in this sense; and even among the highest animals most of the selecting and rejecting depends entirely upon reflexes and instincts rather than upon thought or feeling; that is, they depend upon the structure of the organism and upon the composition of certain organs rather than upon a conscious purpose or discriminating taste.

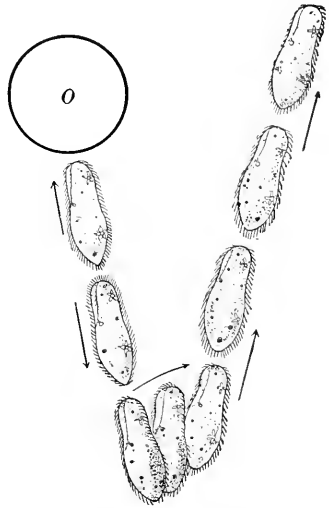

FIG. 88. General reaction

In many one-celled animals every stimulation brings about the same response. In the Paramecium the animal, when it runs into an obstacle, whether physical or chemical (*O*), immediately reverses its movements, backing off a little way, turning to one side, as shown by the arrows, and starting off along a new path

In the simple organisms the response, like the irritation, concerns the *whole cell*; that is, the whole organism. We cannot separate the part of the animal's structure that is irritable in the sense in

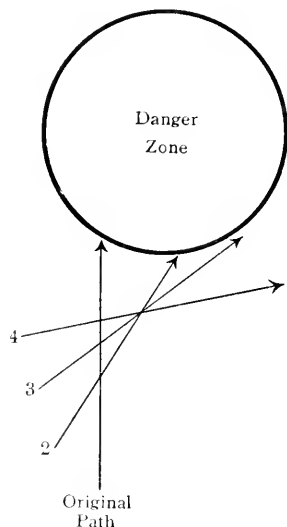

FIG. 89. "Trial and error" in lowest animals

When a simple animal, like *Paramecium*, runs into a region unfavorable to its existence, the stimulus causes a reversal of its movements, with a change of direction. On moving forward in the new path, 2, it may again meet the same obstacle. The same reaction is repeated. After a number of trials the animal is likely to find a clear path. This behavior gives the appearance of trying again after each failure until success is attained

It seems that we perceive *hot* through the stimulation of certain end organs in the skin, and *cold* through the stimulation of certain others.

265. Organs of taste. On the upper surface of the tongue, on the palate, and in other parts of the lining of the mouth

which a neuron is irritable, from the part that is irritable in the sense in which a muscle fiber is irritable. Nor can we separate the perceiving part from the contracting part, although of course we may readily believe that in the complex mixture that we call *protoplasm* there are some contractile arrangements of materials and some irritable combinations.

In the *Vorticella* (Fig. 90) and other one-celled animals it is indeed possible to distinguish a strand of highly contractile substance.

In the *Hydra* (Fig. 91) we can see the beginning of separation between irritable region and contractile region.

264. Organs of touch. In ourselves, as well as in the other higher animals, the sense of touch is dependent upon the presence of special nerve endings in the skin, and their connection, direct or indirect, with other neurons (see Fig. 92).

In some parts of the body the touch organs are much closer together than they are in others; for example, they are set very close together in the skin of the tips of the fingers, and comparatively far apart on the back of the hand.

and of the pharynx there are little projections called *papillae*, which contain the nerve endings of the neurons connected with the cells that feel *taste*. The wry face that one makes on tasting something disagreeable is a reflex in which the afferent nerves of taste and the muscular nerves controlling the muscles of the lips, tongue, and cheeks form the arc.

There are also associated in this kind of reflex other neurons that stimulate the salivary glands. Your mouth waters on tasting something sour, but this watering is not related to the digestive process. It may not be unreasonable to consider this excessive watering as useful in the sense that it helps to dilute the acid, or to neutralize it (since normal saliva is alkaline), or to wash it away.

The nerves are capable of perceiving four distinct tastes: sweet, sour, bitter, and salty. When we perceive the various flavors in substances that we place in our mouths, we are really getting stimuli that act upon the nerve endings in the nose. We can readily convince ourselves of this by trying to distinguish, without the use of sight or smell, the taste of various substances having distinct flavors. A blindfolded person, holding his nose to prevent currents of air passing through it, cannot distinguish ground coffee, for example, from sawdust, or vanilla flavor from raspberry. When we speak of the "taste" of good food, we generally mean the *odor*.

266. Organ of smell. The nerve endings in the lining of the nose, and of the air passages extending back from the nose into the pharynx, are of two kinds: some are sensitive to touch; others are sensitive to odors. This sense of smell is a

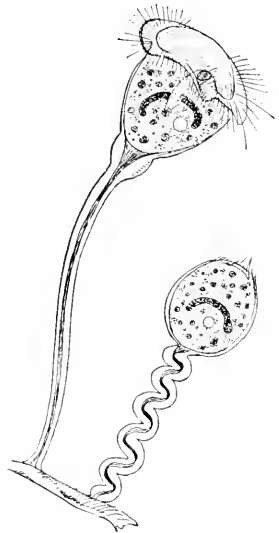

FIG. 90. Vorticella

This one-celled animal lives in water, attached by its stalk to a rock or twig. When disturbed the animal contracts suddenly. Running through the stalk is a strand of highly contractile substance, shown in the figure by the dark area

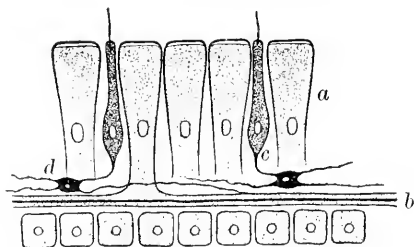

FIG. 91. Simple tissues in a simple animal

The Hydra is among the simplest of many-celled animals, consisting of a hollow bag whose wall is made up of two layers of cells. There is apparent a division of labor between the inner layer of digesting cells and the outer layer of protecting cells. In a section of the wall we may see that the outer cells, *a*, have elongations, *b*, at their bases, which are highly contractile, and that interspersed among these cells are smaller ones, *c*, which are highly sensitive and extended into delicate threads and expansions, *d*, which may be considered to correspond to nerves

that may be started by stimulation of the odor end-organs.

267. Stimulation and sensation. In the case of touch, taste, smell, and other senses, the application of energy or of contact to the nerve endings (or end organs) sets up a disturbance in the protoplasm of the neuron. This disturbance is not in itself a sensation. The disturbance is carried along through the neuron and is passed on through one or more other neurons until it finally sets up a disturbance of one or more cells of the brain. It is here that the stimulus is at last translated into a *feeling*, or *sensation*.

specialized chemical sense, and is more highly developed in some of the lower animals than it is in man.

The sneeze reflex is started either by a strong odor stimulation or by a touch stimulation in some of the nerve endings of the nostrils. Watering of the mouth in response to certain odors illustrates reflexes that are discharged to glands rather than to muscles. The feeling of nausea and the act of vomiting are reflexes

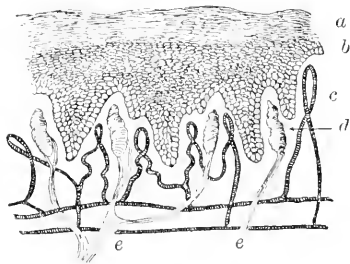

FIG. 92. The touch organs of the skin

We perceive touch or heat or cold according to the end organ that is stimulated. These end organs, *d*, lie beneath the epidermis, *a*, and contain endings of nerve fibers, *e*; *b*, the dermis, or true skin; *c*, blood vessels

CHAPTER XLIV

EYES AND LIGHT

To us the eye is a *seeing* organ — that is, a means of distinguishing objects, forms, colors, shades, and lights at a distance. It is therefore hard for us to realize, first, how animals can get about with-

out such useful organs, and, second, how it is possible to be sensitive to light and shade without eyes. Yet many animals are very sensitive to light without having any eyes, and many animals get along very well without distinguishing

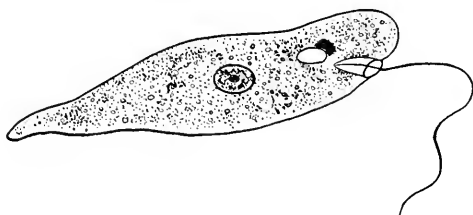

FIG. 93. Euglena

between light and darkness. We have already learned that plants are sensitive to light (p. 38), and that the ameba will respond to sudden changes of illumination (p. 24). From these facts we may infer that protoplasm itself is more or less sensitive to light — that light is a kind of energy that may change the processes that go on in protoplasm.

This one-celled organism is capable of moving about by means of the swimming lash, like many animals; it has chlorophyll, like many plants. Near the base of the lash is a reddish speck which is sensitive to light. Although it is often called an eyespot, it is no more like an eye than a grain of powder is like a cannon

than a grain of powder is like a cannon

268. Primitive light perception. In the ameba every part of the body is equally sensitive to light. This is true of the protozoa generally, and also of the simplest plants. There are some one-celled plants, however, in which there is a special region that is particularly sensitive to light. One of the most common of these is the Euglena (see Fig. 93).

269. Light tropisms. There are many simple animals that are ordinarily phototropic in the positive sense, and there are many that are negatively phototropic. In some cases, as in the *Euglena*, the tropism can be *reversed*; that is, made to be the opposite of what it was. An agitation of the water, an electric shock, a change in the temperature, may reverse the sense

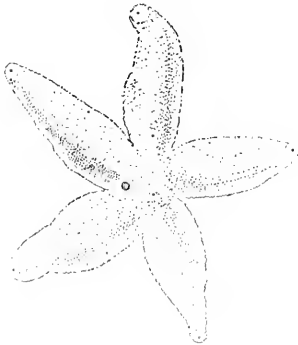

FIG. 94. Eyespots in starfish

The *eyespot* at the end of each ray is connected with the nervous system of the animal and is more sensitive to light than the rest of the body surface. In this group of animals (Echinodermata, or spiny-skinned) there is a central nervous system, so that there are true reflexes

of the phototropisms. This would show that the response depends upon the *condition* of the protoplasm.

270. Mollusks and light. Comparatively few of the mollusca (oysters, clams, scallops, etc.) have special light organs. Most of the common bivalves have a region about the edge of the mantle that is sensitive to light. In the scallops there are definite eyespots at the edge of the mantle. In the snails, the squids, and the octopus there are definite eyes, those of the octopus resembling the eye of the backboneed animals in many ways.

271. General sensitiveness. The earthworm has no eyes, but the whole skin, and especially that near the front end of the body, is sensitive to light. The worms will crawl away from the source of light unless the illumination is very low. Thus they keep out of sight during the day, and crawl to the openings of their burrows at night.

272. Compound eyes. Insects and other arthropoda commonly have *compound eyes*, and many of them have also simple eyes (Fig. 96). There are many nerve-cell endings in each of the eyes, and as the lens projects a tiny image upon these endings, there is formed a patchwork of varying lights and shadows, some of the cells being highly illuminated, others

not at all. In this way some tiny picture of a portion of the outside world is formed inside of each of the many eyes, and thus a mosaic of impressions is produced on nerve cells of the animal's brain.

The images produced in the parts of the compound eye of an insect or a lobster are probably not very distinct; but as the animal gets many simultaneous views from somewhat different angles (a compound eye may have from twenty to several thousand separate facets), the organ is excellently adapted to detecting slight movements. In insects the eyes are immovable, but most of them are able to see the movements of an object or of a light from practically all directions, though not at a very great distance.



FIG. 95. Light-perceiving organs among the mollusks

In the scallop, *A*, and in other bivalves, there is a row of eyespots along the edge of the mantle. In the snails, *B*, there is a more developed eye, frequently on the end of a stalk. The octopus, *C*, has a pair of eyes similar in many respects to the eyes of backboned animals

273. The human eye. We may think of our eye as a small camera with sensitive nerve endings in the place where the film or plate would be (see Fig. 97).

The space between the lens and the retina is filled with a transparent, jellylike mass, and in front of the lens the space under the protective coat contains a watery fluid. Finally, the eye is moved about in its setting by muscles attached to the bony framework, and is further protected by the movable lids.

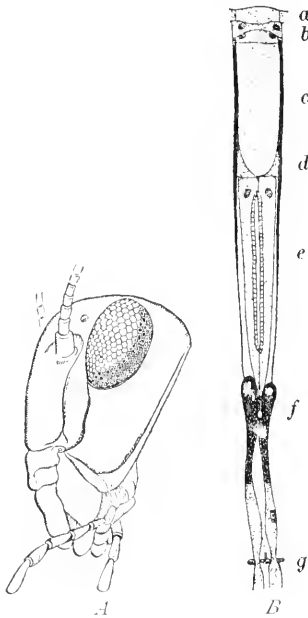

FIG. 96. Compound eye

In the Arthropoda, or jointed-legged animals, there are compound eyes as well as simple ones. *A*, head of a locust, showing the compound eye with its many facets, each representing the exposed surface of an ommatidium, or single eye. *B*, an ommatidium, seen in section cut lengthwise. *a*, corneal lens; *b*, lens-growing cells; *c*, cone; *d*, iris cells; *e*, retinal cells, receiving light impressions; *f*, retinal pigment; *g*, perforated supporting membrane

274. Other vertebrate eyes. While our eye is in general very much like the eyes of other backboned animals, there are important differences, corresponding to the habits and the habitats of the different groups. Animals living in the water, for example, have a different kind of lens; animals that prowl about at night have a different kind of pupil. The fishes (except the sharks) lack eyelids. Snakes have their eyelids permanently closed, but transparent. Among the birds and in many reptiles there is a single eyelid that passes over the eyeball from the inner corner, under the pair of eyelids (Fig. 98).

275. The seeing eye. Although sensitiveness to light is found among all branches of the plant world and among all branches of the animal world, there are only three main groups of animal that can actually see. These are the highest mollusca, the arthropoda, and the vertebrates.

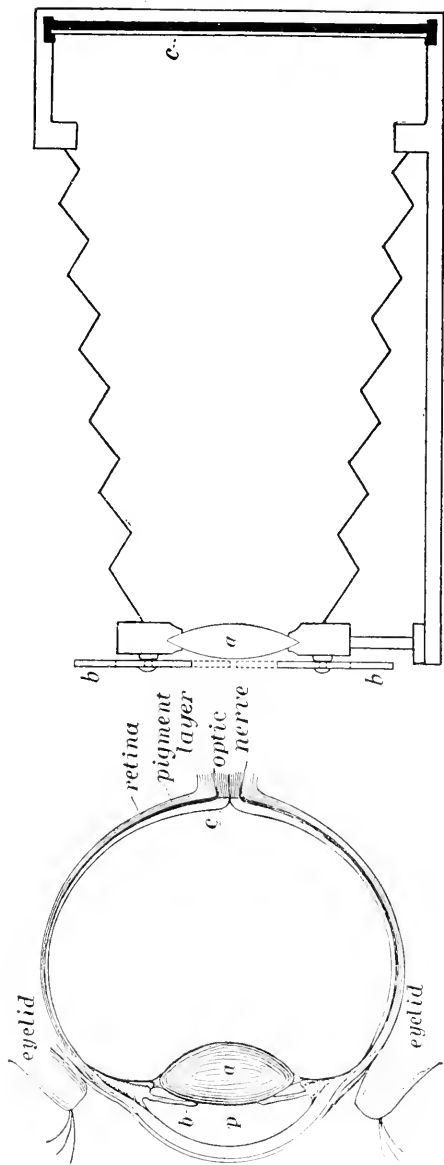

FIG. 97. The human eye compared with a photographic camera

In the eye, as in the camera, there is a lens, *a*, at one end, with a diaphragm, *b*, which is controlled by a set of muscles that are operated in a reflex way by variations in the intensity of illumination. The focusing is brought about chiefly by changing the convexity of the lens rather than by changing the distance between the lens and the sensitive surface, *c*, called the *retina*. The retina is backed up by a layer of pigment and is connected with the optic nerve

By *seeing* we mean not simply discriminating between light and dark, but being capable of distinguishing forms and colors, as well as light and shade, at some distance.

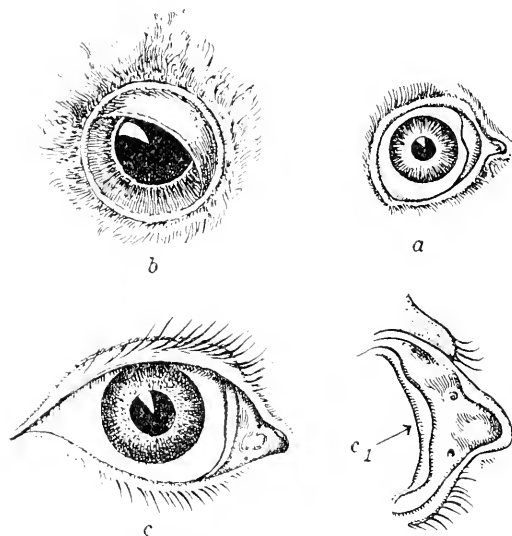

FIG. 98. The third eyelid

The fold of tissue extending from the inner corner of the eye *c* corresponds to the third eyelid, or *nictitating membrane*, in birds and certain reptiles and amphibians. The nictitating membrane can be drawn over the eye so as to cover it completely. *a*, eye of ape; *b*, eye of owl; *c*, human eye; *c₁*, the semilunar fold, eyeball removed

276. The range of sensitiveness.

Some insects, as ants, have shown that they are sensitive to other vibrations that make no impression at all upon our retina. We can understand this both from our experience with other senses and from experiments. Thus, we know that a bloodhound will perceive odors that you and I would pass by without notice, and that even most dogs would not be able to recognize. We know that ordinary dogs will recognize persons by the odor,

but that very few human beings are capable of doing so. Again, by means of experiments we have found out that some people can distinguish shades of red or of blue that others cannot recognize at all. We can therefore understand that some nerve end-organs will be sensitive to certain colors (rates of vibration) that leave others indifferent. Moreover, some animals are sensitive to light of such low intensity as others would not respond to at all, just as individuals vary as to the quantity of light stimulation necessary to make an impression.

CHAPTER XLV

HYGIENE OF THE EYES

277. Eyestrain. No two eyes are ever exactly alike, and while the lens of the ordinary eye may be fairly satisfactory for ordinary purposes, we find that very many eye lenses are not adapted to doing work at close range and with small objects. Now in modern times our work comes to be more and more of the kind that requires the seeing of small objects, or distinguishing small markings, at short range. The strain on the muscles that adjust the eyes for far and near vision (*focusing*) often leads to headaches and irritability, or nervousness, without the person who suffers being aware of the source of his annoyance. An examination of the eyes by means of special instruments easily discloses any defect of the lens, and this can be corrected by the use of glass lenses.

A special defect often found in our eye lenses is that due to lack of symmetry, or *astigmatism*. As the excessive bulging or lack of curvature is usually along one line, it interferes with clear vision, especially where one has to look at views in which lines are important elements. Astigmatism also causes headaches and other inconveniences due to eyestrain, since one unconsciously *tries* to bring the view into clear vision, thus straining the muscles of the eye.

Another kind of strain results from the uneven musculature of the eyes, causing the axis of one eye to turn inward or outward. Squint, or *strabismus*, in children can be remedied by a simple surgical operation, which evens up the tension of the muscles that move the eyeball. In some cases special wedge-shaped or prismatic lenses are sufficient.

278. Outside sources of strain. As the eye has to do with perceiving light stimulations, the character and intensity of the illumination are important in their effects upon the eye and

upon the general health. As light acts in the eye by bringing about chemical changes in certain cells of the retina (the "rods and cones"), prolonged exposure to light will carry these changes so far that it is no longer possible to see. Even before this extreme condition is reached, the cells will show signs of fatigue, which may be accompanied by pain, or at least by discomfort. This is what happens when the eyes are long exposed to strong light, and the only way to counteract the fatigue is by giving the eyes a complete rest. Staying in a dark room or bandaging the eyes for from twenty minutes to an hour will usually give the retinal cells time to recover.

Flickers and flashes. The iris opens or closes in accordance with the intensity of illumination. Sudden increases in the amount of intensity of the light reaching the retina is likely to cause injury to the pigment cells. This is why flashes or a flickering light will fatigue and strain the eye, and such sources of injury should be avoided.

Glare. A glare is produced when a comparatively strong light strikes the retina while the pupil is open, or when a strong light strikes a portion of the retina, the rest being in comparative darkness. This condition results in injury to the eye, and should be avoided as much as possible.

279. Mechanical injury to the eyes. Although the eyeball, in its bony setting, is fairly well protected against injury by large bodies, and although the very quick eyelash reflex keeps many small particles out, many eyes are injured every year either by blows or by dust. In railroading, in the building trades, and in other dusty occupations flying particles of stone, metal, cinders, coal, brick, etc. are sources of serious danger to the eyes of workers. Wherever possible, workers in such occupations should wear goggles. In any case we must be careful not to rub the eye when something has got under the lid, and whoever tries to remove a particle from under the eyelid must approach the task with perfectly clean hands.

280. Eye infection. One of the dangers in getting dust into the eyes lies in the ease with which the lining of the eyelids becomes infected by various kinds of germs. Children suffering from trachoma or other infectious eye diseases should be excluded from school, where they are likely to transmit the disease to others. There is danger, too, in rubbing the eyes with the hands or with unclean towels or handkerchiefs. On the first appearance of an irritation, or redness, in the eyes it is well to wash with a solution of boric acid or argyrol, which acts as an antiseptic without being injurious to the eyes.

A considerable proportion of all blindness could be prevented by the exercise of greater care in dealing with injuries to the eyes, as well as by care in avoiding injuries. The largest single source of blindness is probably *ophthalmia neonatorum*, the "baby sore-eyes," or the sore eyes of the newborn. This is caused by the gonococcus bacteria, and can be prevented by placing a drop of a one per cent solution of silver nitrate in each eye immediately after the birth of the child. In several states this treatment is now required of all physicians and midwives attending a birth, and in the last few years thousands of persons have been saved from this form of blindness.

CHAPTER XLVI

SOUND SENSATIONS

281. What we hear. Certain kinds of movements, or vibrations, of the air, when they make an impression upon our nerves, give us the feeling of "A \sharp ," just as certain other kinds of vibrations give us the feeling of "yellow." The eye

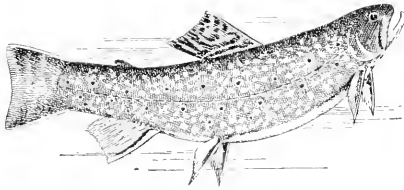

FIG. 99. Lateral line in brook trout

The line running along each side from the gill cover to the tail is made up of nerve end-organs that are sensitive to certain kinds of vibrations in the water

with which we see is an organ whose nerve endings receive impressions from vibrations in the ether at the rate of from 400,000,000,000 to 800,000,000,000 per second. If the vibration is much more rapid or much slower, the eye nerves are not affected by them. Sound is a much slower vibration of the air or of solids. Between 16 or 20 vibrations in a second and 25,000 to 40,000 per second the human ear discovers sounds of varying pitch. In the middle register, which includes most of the sounds with which we are familiar, as the pitch of the human voice, the ear can distinguish very slight differences of pitch. It is possible for a trained ear to distinguish more than 1000 shades of pitch in one octave.

282. Perception of other vibrations. Among lower animals the range of vibrations that can be perceived varies considerably; some animals are quite insensitive to sounds of what we would consider the common range of pitch, while some insects can perceive a much higher tone than any human being can hear at all. The earthworm,

without any special hearing organ, cannot perceive sounds. Yet the whole skin will receive vibrations of certain frequency, and transmit them along nerve fibers, as can be seen when an earthworm is placed on a piano and the instrument is played. Fishes are deaf in the usual sense of the word, but they are capable of detecting vibrations in the water, of a kind that we should not notice at all. The fishes probably

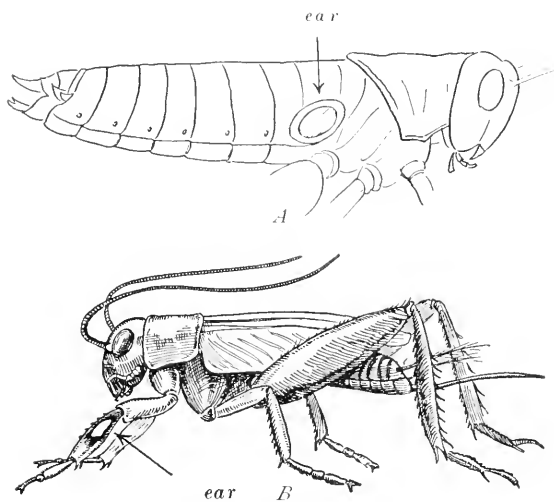

FIG. 100. Sound-perceiving organs in insects

In the locust, *A*, there is a nearly circular membrane, connected with nerve endings, on the first segment of the abdomen. In the cricket, *B*, a similar hearing organ is found on one of the joints of the front leg

receive these vibration impressions through a row of little spots extending along each side of the body, under the skin. This "lateral line" is very prominent in some fishes (see Fig. 99).

283. Hearing in fishes. It is commonly believed that fishes hear sounds through the water, and that they will even recognize the voice of the person who feeds them. Experiments, however, show that some species are much more sensitive than others to different kinds of sounds and other vibrations. Nearly all fish can probably distinguish vibrations through the water, especially those of low pitch. It is doubtful whether any fish can perceive sounds made in the air, since such sounds are very largely reflected from the surface of the water.

284. Sound-perceiving organs. Among the insects there are many special sound-producing organs, as well as many sound-perceiving organs. It is probable also that many insects are sensitive to rates of vibration to which our own nerve endings are indifferent (see Fig. 100). In some insects and spiders

the sound waves are received on fine stretched hairs connected with nerve fibers. In the male mosquito and in other insects sound waves are received by fine hairs on the antennæ, or feelers.

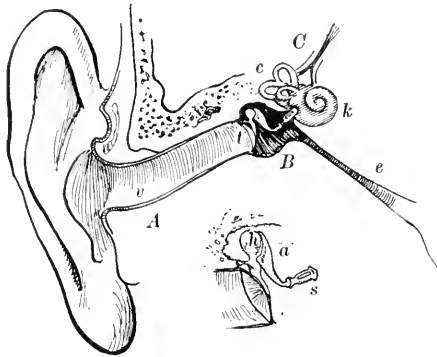

FIG. 101. The human ear

A, the outer ear, consisting of the cartilaginous projection from the side of the head and an air passage, or vestibule *v*; *B*, the middle ear, lying between the ear drum, or *tympanum* (*t*), and the inner ear, *C*. The inner ear is connected with the pharynx by the Eustachian tube *e* (see Fig. 28). Extending from the drum to the inner ear is a series of three tiny bones: *h*, the *hammer*; *a*, the *anvil*; and *s*, the *stirrup*. The main parts of the inner ear constitute the *labyrinth*: *c*, the *semicircular canals*, consisting of three tubes placed almost exactly at right angles to one another; *k*, the *cochlea*, or snail shell. The labyrinth is filled with a fluid and lined by a delicate membrane containing nerve endings

285. The human ear. In the air-breathing vertebrates the hearing organ is very much like our own, although it is possible to arrange a series, extending from the amphibians to the mammals, in which increasing complications and refinements may be observed. Our own hearing organ is pictured in Fig. 101.

286. How the ear works. A vibration striking the ear drum is transmitted through the chain of bones of the middle ear to the liquid filling the labyrinth. From this liquid it is transmitted to the delicate lining of the cochlea, where nerve-endings are located. Here some cells are disturbed by vibrations of one pitch, others by those of a different pitch. The nerve fibers are connected with special cells in the brain.

CHAPTER XLVII

RESPONSES TO GRAVITY

287. Geotropism. We have already learned that gravity is a constantly acting force, and that plant organs respond to the direction of this force (see p. 37). Animals also have occasion to adjust themselves to gravity, and they do this in a variety of ways. Some of the simple marine animals are positively geotropic (or downward swimming) under the influence of light; when light is withdrawn (as at night), they become negatively geotropic, and swarm to the surface of the water. This agrees with the common observation of those who are a great deal on the water, that certain animals can be found near the surface only at night. This is also an example of a tropism reversed by changes in the protoplasm.

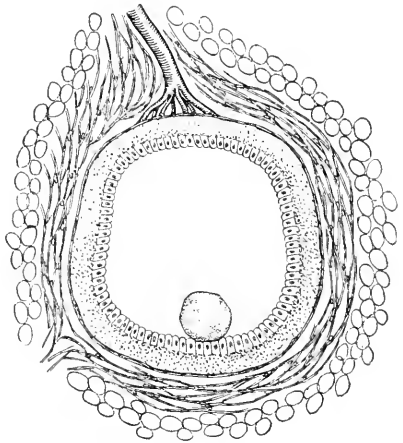

FIG. 102. Statolith of a snail

A hollow structure filled with a fluid and containing an unattached solid that is heavier than the fluid; as the position of the body changes, the solid touches on different portions of the sensitive lining, which is connected with nerves. In some animals the lining of the statolith bears delicate hairs

288. Insects and gravity. The common house fly seems to be indifferent to the direction of gravity; it will crawl upon a surface in any plane and in any direction, and will come to rest in any possible position.

Many insect larvæ, when they hatch out of the eggs, crawl upward to the tips of the twigs. Many adult insects, when they alight on a tree, assume a position with the head pointing upward; others always rest with the head pointing downward. In some species the position of the insect at rest is determined

by the source of light rather than by gravity.

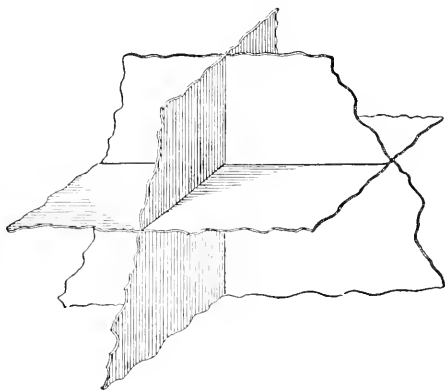

FIG. 103. The three dimensions of space

A solid body moves in a space which we think of as extending in all directions. Every movement can be thought of as a combination of movements in one or more of the three planes representing the three dimensions of space. The semicircular canals of backboned animals are placed almost at exact right angles to one another

289. Statoliths. In the simplest animals the action of gravity is probably similar to that supposed to take place in plants, namely, that the nucleus or some other solid particle presses upon the protoplasm of the cell in a different part, according to the position of the cell. In some animals the organ of *equilibration*, or of perceiving gravity, is essentially a hollow space with a floating body and sensitive walls (see Fig. 102).

In the lobster and crayfish similar organs are located at the base of the antennules. The movable body here consists of some grains of sand.

These organs were formerly supposed to be related to the perception of sound waves, but it is doubtful whether they function in this manner at all.

290. Balancing organs. In the vertebrates, organs of equilibration, or of perception of position, are found in connection with the inner ear. The semicircular canals of the labyrinth (*c* and *k*, Fig. 101) are capable of detecting slight movements of the body (or of the head) in any one of the three planes of space (see diagram, Fig. 103). In our own body it is this

organ, connected by means of nerve chains to the skeletal muscles, that helps us keep our balance in walking or skating, and in recovering our position when we trip. In addition to this, the movements of the viscera and the strain of the muscles at the joints help to keep us aware of the body's position and of changes in the position at all times.

Since the introduction of airships into the army and navy, it has become necessary to give certain classes of recruits a special kind of physical examination, for the purpose of discovering whether the equilibration reflexes are in good working order. Unless a person can respond quickly to changes in bodily position, he can never learn to control a machine that moves in the three dimensions of space.

CHAPTER XLVIII

INSTINCTS

291. A chain of reflexes. When an infant of a certain age sees a small object, there is at once started a reflex ending in the touching of the object. When the palm of the hand comes in contact with the object, there is started the reflex of closing the fingers. The touch of the object against the palm and fingers starts the reflex that carries the object to the mouth, and at the same time it stimulates the muscles that open the mouth. The contact of the object with the lips and tongue may set up a reflex of closing down on the object, or it may set up a reflex of rejection if the taste is what we call disagreeable.

Here we see movements in a connected series, but each part of the series is a very definite reflex, depending upon the association of afferent neurons connected with sensory organs, efferent neurons connected with muscles, and associative neurons in the spinal cord or the lower part of the brain. Such a series we may call an *instinct*.

292. Instincts not perfect adaptations. A frog would starve to death with hundreds of dead worms and insects all about him, because eating movements of this animal can be started only by the *sight of a moving object*. On the other hand, the frog will swallow bits of cloth that are dangled in front of him, and that have no food value whatever.

Again, the female fly that is about to lay her eggs is guided entirely by odor. If a piece of paper that has been soaked in meat juice is placed on a table, the flies will come and lay their eggs upon it, although this is extremely wasteful of eggs, and suicidal for the species if persisted in. Of course, in a state of nature the only things

that smell like meat or like manure are meat and manure; and if the eggs are deposited in such materials, the young are supplied with food. Therefore these instincts are, on the whole, beneficial, or at least not fatal, to the species.

293. Instincts may be modified. We should expect that eating instincts would be so well fixed in the organization of an animal that nothing could change them. But although we cannot teach a frog to eat food that is at rest, or to avoid useless bits of dangling bait, it is possible to modify the instincts of other animals in various ways. The dog who will refrain from eating when he is not hungry illustrates the modification of reflexes by the physiological state of the body. That is, when the animal is no longer hungry, the condition of the blood and of the other juices is different from what it is in a hungry dog; and the "hungry" nerves and muscles behave one way in the presence of food, whereas the sated organism behaves in a different way. A different situation is presented by the goose that has had her food stuffed down her throat by hand for some time. After a while the animal is no longer stimulated by the sight of grain etc. to open her beak and bend her neck and take up the food. We might say that for lack of exercise the instinct has disappeared. It is probable, however, that only certain of the reflexes have dropped out of the chain.

294. How an organism learns. In an aquarium a pike was once placed in the same tank with a number of smaller fish. The pike promptly swallowed his neighbors. A glass partition was then put in, separating the pike from the small fish. The pike would dart at them, however, and was often stunned by striking the glass plate. But after a while he stopped darting at the small fish; and when the partition was removed, the pike would always turn aside on approaching one of the little fish. There was now nothing to prevent his eating them — except certain connections in his nervous system.

This ability to form associations is of great practical importance to us not only in our control of lower animals but in our

own lives. It is the foundation of all our learning, whether learning to know or learning to do or learning to like. It is also the foundation of our learning to avoid doing, or to stop impulses to action.

295. How neurons develop. We know from experience that the muscles grow with exercise. The size of a muscle grows measurably in a few weeks or months, and many boys try their muscles from time to time, to see how they are coming on. The explanation of this growth lies probably in the fact that the exercise (contraction) calls forth a reflex that increases the flow of blood, and that with increased nourishment the muscle fibers increase in size or in number during the resting periods between exercises. Now this sort of thing does not take place so simply when the neurons are exercised. It appears that the body does not increase the number of neurons after birth. But the axons and the dendrites may grow out, and this is what happens when our nervous system develops. The outgrowths of the nerve cell have been compared to the pseudopodia of the ameba, as they are protoplasmic extensions beyond the general outline of the cell, and depend upon the cell's activities. Unlike the pseudopodia, they cannot be withdrawn; but, like the pseudopodia, they partake of the life of the cell. The whole cell, including the very ends of the fine branchings, acts as a unit. As a nerve cell is exercised, by receiving impressions, by sending out stimuli, or by discharging its energy in some other way, these extensions of its protoplasm are formed.

296. Learning in youth. It is by means of the expanding outgrowths of the cells that new connections are formed, and this is the basis for the associations that modify the conduct of an animal as it gets older. Like other cells of the body, the neurons are less and less capable of growth with advancing age. Any associations that are to be formed must be made before the neurons are too old. The development of the ability to do things or to control the organs generally is thus

the result of use (exercise) or disuse. It is for this reason that habits acquired in youth are most lasting, and it is for this reason that "you cannot teach an old dog new tricks." Things that "come natural" to us early in life become difficult if they are not practiced; tricks that we learn in our youth are forgotten if not practiced. Thus we may lose instincts and outgrow them; or we may fix them in our ways of life, remaining childish though old in years.



CHAPTER XLIX

HABIT

297. Habits. The old saying, "The burnt child dreads the fire," refers to this common observation, that acts which have unpleasant associations come to be avoided. The positive side of this fact is just as important — namely, that acts which result in feelings of satisfaction come to be performed more frequently. This is what a boy uses when he tries to teach his dog or colt some new trick. If the animal is rewarded every time he does what you want him to do, he will be more and more likely to repeat the performance. At last he gets to the point at which it is just as easy to perform the trick as to do what it is natural for him to do. A boy taught his dog to fetch his cap for him every time he started for the front door. This trick we call a *habit*.

Now, if you look about you at what others are doing, or if you watch yourself for a day, you will notice that most of our actions are made up of habits. Turning to the right on passing someone, or taking off the hat to a lady, is a habit; these things do not come naturally, for many people never do them at all. And they are not done on purpose each time, for those who have the habit do not stop to think each time what is the proper thing to do. Wiping the mud off the boots before entering a house may be a habit, or it may not; it does not come naturally; it is not instinctive.

298. Inhibition. It is natural to throw out of the mouth anything that one does not wish to keep in; but one may learn to avoid spitting — that is, one may acquire the habit of *holding back* on an impulse. This process of sending out a nerve impulse to interfere with or stop the action started by

another impulse is called *inhibition*, and it is just as important a part of our control as skillful action is. Indeed, skill is in large part a matter of inhibition. In the excitement of a ball game, the impulse of any player who gets hold of the ball is to throw it; the clever player will put the brakes on this impulse — inhibit it — long enough to decide just *where* to throw it, or he may even decide not to throw it at all, but to carry it somewhere, or he may go through the motions of throwing it in one direction and then quickly turn and throw it elsewhere.

299. Practice. All movements can be performed accurately just in proportion as a person has had practice in doing and practice in inhibiting movements. We all know this when we urge the other fellows to come out to practice for an important game, or when we arrange rehearsals for theatricals, or when we practice some new steps in dancing. We do not seem to realize it so well when we are urged to drill on our lessons or to practice some tedious scales on a musical instrument.

300. Kinds of habit. The education of human beings, like the training of a dog, consists very largely of the establishment of habits — habits of doing, habits of thinking, and habits of feeling. Learning to walk, to handle our food or tools, to swim, or to skate — these are examples of habits of *doing*. A person who could walk only by thinking of each step would not get along very far in the course of a day, and he would not have much time to use his brain for anything else if he really had to get anywhere.

301. Thinking habits. When we learn to say — or, rather, to think — "eighty-four" on being presented by the combination " 12×7 ," or when "1492" makes us think "Columbus," we are acquiring habits of *thinking*. Thinking shows itself when you work out the answers to various kinds of problems, when you draw out of your stock of remembered ideas and experiences arguments to use in a discussion or examples to make clear an idea that you are trying to explain to someone, or when you work out a plan for getting certain tasks done

early enough to let you go to a meeting you are anxious to attend. And each one of us learns through practice to do these various kinds of thinking, and each one of us becomes more skillful at one kind than at others—one person has habits that enable him to solve mathematical problems more rapidly than you or I can solve them, another person has habits that make him a ready debater, and so on.

302. Feeling habits. We may have the habit of feeling envy on seeing something new in the possession of another person, or we may have the habit of just feeling glad that the other person has something nice. We may have the habit of feeling contempt toward people who are different from ourselves, — people who wear different kinds of clothes, or who go to a different kind of church, or who speak a different language, — and we may have the habit of feeling friendly toward strangers. The sight of a bird or a squirrel may make us feel like throwing something at it; we may have acquired the habit of inhibiting the impulse to throw, and yet retain the habit of *feeling* destructive or cruel. Our feeling habits show themselves in the attitudes that we assume in various kinds of situations.

The habits which people acquire become so fixed and constant that we may rely upon these sets of habits under all circumstances. This is what we mean when we speak of a person's *character*. We mean that totality of habits of feeling and thinking and doing which distinguishes him from others.

We differ very much from each other in amount of thinking power, in the strength of our muscles, in our endurance, in the depth of our feelings. But we can all acquire certain habits that will constitute the sort of character that can be depended upon, to the extent of our abilities, in all emergencies.

303. Selecting our habits. In acquiring habits of doing, feeling, and thinking we must notice that habits of inhibition are just as important as positive habits. We must suppress the impulse to sneer and the feeling that goes with it; we must inhibit the rising temper or

the feeling of dismay. In the same way we find thoughts coming into our consciousness that must be put down. Castles in Spain have their proper place in one's life, but they must not come into our minds at times that require close attention to something else. The thought of skating must be inhibited when the business of the hour calls for thinking about Washington crossing the Delaware. For the action to be unlearned there must be no indulgence and no compromise.

Society establishes schools for the purpose of drilling children in the kinds of habits that are supposed to be useful to them immediately or at some time in the future. But in addition to what the schools can do, each one of us has opportunities to establish thousands of useful habits that the schools never recognize; and each one of us no doubt has a number of useless habits — or habits that are worse than useless — which it would be worth while to get out of our nervous system. By resolving to inhibit the undesirable habits — whether of thinking, feeling, or acting — we may in time suppress them; or we may replace them with useful habits, as when we replace a slouching gait with erect carriage. But there are two things to remember in the matter of habit-making and habit-breaking: first, "It's dogged as does it," and, second, "You can't teach an old dog new tricks," which, translated into English, mean, *Persistence wins* and *You have to catch 'em young*.

304. Value of habits. One need not go far from his own immediate experience to find out how valuable habits are when they are of the right kind, and how miserable they may make us when they are of the other kind. The amount of work or play that one can accomplish depends very largely upon the kinds of habits one has acquired. In the simple matter of dressing ourselves, how many movements are necessary, and how much thought and effort they take at first! But to-day you probably dressed yourself without thinking about the buttons and sleeves at all. You ought to be able to do all of your dressing and a hundred other things that have to be done daily — or at least very often — without giving the actions the slightest attention. This means not only a great saving of time in the doing of the necessary work, it means also a saving of thought for matters that are much more interesting. The control over our muscles comes by first giving our attention to what we are doing, and then getting the spinal-cord connections to control the actions so that we do not have to think about them at all.

We make use of the fact that animals form habits in many ways not only in the training of animals for performing tricks for our entertainment but in the everyday work of the farm or the stable. By regular programs in feeding and milking cows, for example, we give them the habit of coming in from the pasture when they are wanted, either at sunset or when we call them; this saves the work of going after them. Horses learn to follow fixed routes, and they learn to come home after they have strayed away. Chickens come in response to a familiar call, and everybody can tell a good cat or dog story to show how convenient it is for us that they do acquire habits.

305. Remaining young. As we grow older our protoplasm loses the power to form new extensions and new connections readily. But some people retain the power to form new habits much longer than others. A part of this difference seems to be due to the fact that some people retain their youth, so to speak, by constantly giving their attention to the learning of new ideas, and of doing things in new ways. It may be worth while to establish the habit of changing old habits, or of trying to get new habits as we grow older.

CHAPTER L

CHEMICAL INJURY TO THE NERVOUS SYSTEM

306. Alcohol and the senses. The most important effects of alcohol are upon the nervous system, as indeed is the case with all drugs, stimulants, and narcotics. In small quantities, alcohol dulls the sensitiveness of touch and hearing as well as of sight. Nevertheless the drinker *feels* alert. In one experiment made in Germany, four experienced typesetters were given measured quantities of alcohol in their usual drinks, fifteen minutes before beginning work, on alternate days. All four of them felt that they were working faster on the days when they drank the alcohol than on the other days. But when the number of letters set each day was counted, it was found that, with the exception of one man, who increased his output each day after the first, all did considerably poorer work on the alcohol days than on the non-alcohol days.

A similar experiment was made at the University of Heidelberg, where a number of students were required to add columns of figures for half an hour each day. Although they all *felt* that they were working better on the alcohol days, it was found that they had actually done better work on the non-alcohol days.

In Sweden a number of sharpshooters from the army, when under the influence of drink, thought that they were shooting faster — that is, more shots per minute — and felt just as sure of their aim. But the records showed that they actually shot much more slowly, and very much less accurately, after drinking alcohol than after going without it for several days.

These experiments show not only that the effect of alcohol upon mental work and sharpness of the senses is detrimental, even in small quantities, but that the *feelings* of the worker

are by no means a fair indication of what he is actually accomplishing.

It is well known that in larger quantities alcohol has a depressing effect upon the nervous system, lowering the acuteness of the senses, weakening the attention, deranging the judgment, and leading to sleepiness. It is only the feeling of elation and alertness, which comes shortly after taking the small quantity of alcohol, that deceives the drinker; for the after-effect of a small quantity is of exactly the same kind as the earlier effect of a large quantity. This is the chief danger in the use of alcohol. Like the rabbit that has been taking arsenic, the person who drinks alcohol produces in himself two peculiar results:

1. He must have more and more, as time goes on, to produce the same effect that a small quantity was sufficient to produce at first.

2. He gets to the point where he feels that he cannot live without the alcohol — and, indeed, there are many people who really suffer a great deal from the lack of alcohol, no matter how much more they suffer when they have it.

It was formerly quite a common thing for physicians to apply alcohol in cases that required a heart stimulus for a short time, and in other cases. But since careful measurements have shown that the advantageous effects of the stimulant are largely offset by the reaction, and since it has been found that much of the stimulation is only apparent, and not real, physicians are coming to use alcohol as a medicine less and less. And in some hospitals it is never used internally, except where necessary for the administration of some other drug.

307. Coffee and tea. Next to food drinks and intoxicating drinks the most common beverages are tea and coffee. These drinks are prepared for the aromatic flavor and for the slightly stimulating effects produced by an *alkaloid* which they contain.

The leaves of tea and the seeds of coffee contain the same alkaloid, *caffein*. In a pure state this is poison, even when taken in small amounts. In the small quantities taken with

the usual drink, it acts as a mild stimulant, increasing the heart action. The chief danger in coffee- or tea-drinking lies in the fact that one may come to depend upon it as a regular heart stimulant. In that case one comes to require ever-increasing amounts and to feel weak and helpless without it. There is no excuse for children's drinking coffee.

The action of caffeine resembles the action of nicotine and alcohol in that the reaction counterbalances the first gain. The stimulation is followed by a period of depression, just as in the case of nicotine the narcotic effect is followed by a period of irritation or restlessness. Again, as the protoplasm becomes more and more familiar with the alkaloid, a larger quantity of the latter is required to produce a given amount of stimulation. Finally, as in the case of tobacco and alcohol, though probably not so quickly, the continued use makes one feel that he cannot be comfortable without it.

These consequences are not observed with ordinary foods, but they are observed with all the drugs.

Tea leaves contain, in addition to the stimulating alkaloid and the aromatic oil that gives the flavor to the drink, a considerable quantity of tannin. This substance combines with proteins to form a hard, tough substance, and is thus used in the tanning of leather. If tea leaves are allowed to stand in the water too long, the tannin becomes dissolved. It is this that makes strong tea pucker the lips and the inside of the mouth. Habitual drinking of strong tea will in the same way pucker the lining of the stomach; as the tanning proceeds, the stomach lining becomes hardened, and digestion may thus be interfered with.

308. Habit-forming drugs. A large number of plants that were formerly used as medicaments have been carefully studied in recent years, and the active substances have been separated out in a pure state. In this way we have become acquainted with several important substances, which are very useful in the hands of the expert but very dangerous in the hands of the ignorant.

Morphin, which is the active substance in opium, is an alkaloid that was first separated from the poppy plant about a hundred years ago. In fact, this was the first alkaloid to be systematically studied.

From a medical point of view morphin is the most useful of the alkaloids, but it stands next to cocain as a habit-forming drug, and, from the very fact of its extensive use in medicine, has ruined thousands of times as many victims as cocain has. In small doses it lowers the heart action, slows the breathing, deadens pain, and induces a dreamy, quiet feeling ending in sleep. It acts on the nerves that carry impulses *from* the brain, weakening the control of the muscles. In larger doses it causes the pupils of the eyes to contract until they are almost closed, and lowers the respiration dangerously near the stopping point; in fact, death by morphin is brought about by stopping the respiration. As with other drugs, there is a reaction later, in which the effects are to some extent reversed.

It has been said that the widespread use of opium has been the greatest obstacle to the development and progress of the Chinese people. So degrading are the effects of the drug that in 1907 the Chinese government finally prohibited the raising of the poppy and the traffic in opium; and in 1918 the government of Tunis did the same, going so far as to order all wild and all cultivated poppy plants destroyed.

While morphin has been most commonly administered by the smoking of opium, the *habit* of using it may be traced to its administration as medicine or by injection under the skin. Many drug-store preparations contain morphin, and it has been found that many patent medicines attained to large sales only because they cultivated the morphin craving in the people who were foolish enough to take them. All the pain-killers and soothing sirups carry the danger of developing a craving for morphin, since they depend upon the morphin for whatever useful effects they produce.

Nearly all the patent medicines have depended for their commercial success upon the fact that stimulants and narcotics

are so-called habit-forming agents. Caffein, cocain, heroin, codein, acetanelid, chloral hydrate, and other alkaloids and artificial compounds have been used to make the medicines attractive to people in search of health or suffering from pain.

Every person should be informed of the dangers that lurk in these preparations. Every progressive government is taking steps to prevent the use of these dangerous drugs in the exploitation of people's ignorance, and of their desire for health, for the private gain of a few unscrupulous men. It is only under the direction of a competent physician that any of these substances should be used.

309. Drug regulation. Notwithstanding the danger of drugs, it is as important for the public to have pure drugs, and even liquors, as it is to have pure food. In recent years both the public and the physicians have come more and more to appreciate the importance of having drugs standardized. For the sake of those who depend upon having prescriptions that conform to the wishes of the physician, it is necessary that the composition and strength of the various preparations be reduced to definite standards.

The conditions that have made it necessary for the public to undertake the regulation of water and food supplies have also made it necessary for the public to regulate the sale of drugs. The interest of all people in their health, combined with the ignorance of most people in regard to the conditions of health, has made it possible for unscrupulous men to sell for millions of dollars countless bottles and boxes of worthless liquids and powders and pills, with the promise that they will cure or prevent all kinds of diseases.

In recent times the public has come to realize the amount of suffering that the patent-medicine business represents and the amount of injury these supposed remedies are causing. We are accordingly extending the regulation of business to require manufacturers to state what their products contain. This is only a step in the direction of complete protection, for to most people the names of even dangerous

drugs on the wrapper of a bottle mean nothing. A further step is taken by those states that prohibit absolutely the sale of dangerous drugs, except on the prescription of a licensed physician.

310. Individual variation. Experiments show that from five to ten persons in a hundred differ so much from the rest in their physiological and chemical constitutions that every rule we can make must carry exceptions with it. We are not yet able to say anything about the action of alcohol that will be true for *all* men. If it is found to be injurious in general, there will be a few in every thousand who can take large quantities apparently without measurable harm. If we find that a certain drug is useful for certain purposes, in a given dose, we shall find that there are a few people in a hundred who will get no benefit from it in any dose. Or we shall find that what is a harmless dose for most people will be a dangerous dose for a few. Thus, it has been found that blond, pale-faced people are unusually sensitive to atropin.

For all practical purposes, however, the following conclusions of the "Committee of Five" as to the use of alcohol may serve as a sufficient guide to all of us in our attitude toward this and other habit-forming substances :

1. While, in small quantities, beer and wine may be, in a certain sense, a food, they are a very imperfect and very expensive kind of food, and are seldom used for food purposes.
2. They are not needed by young and healthy persons, and they are dangerous in so far as they tend to create a habit.
3. In certain cases of disease and weakness they are useful in quantities to be prescribed by a physician.
4. When taken habitually, it should be only at meals, and as a rule only with the last meal of the day, or soon after it.
5. Alcoholic drinks are worse than useless for preventing fatigue or the effects of cold, although they may at rare times be useful as restoratives.
6. They are almost always a useless expense.
7. Their use in excess is the cause of much disease, suffering, and poverty, and of many crimes.

311. Anesthetics. Closely related to the narcotics through their peculiar effects upon the nervous system are the substances known as *anesthetics*. Chloroform and ether are the most common of these, although nitrous oxid, or "laughing gas," is coming into greater use.

Chloroform and ether are liquids at ordinary temperatures, but are easily changed to vapor when exposed to the air. The person who is to use the anesthetic breathes the vapor into his lungs. In a short time he is overcome by sleep, in the course of which there is complete insensibility to pain.

CHAPTER LI

UNITY OF LIFE

312. The multiplicity of living forms. When we recall the plants and animals that are familiar to us, at least by sight or by name, we must be impressed by the great variety of forms in which life is to be found. There are probably over a million different kinds of animals and over a million different species of plants. Yet throughout all this variety we find the common facts of life.

A survey of what being alive means, from a biological point of view, will show us how much alike these varied beings really are. We may compare a one-celled organism, a common plant such as a daisy, and the human body.

313. Unity in nutrition. In the one-celled animal there is *nutrition*. This involves the taking in of food, its chemical transformation, and the ultimate assimilation of its usable parts.

In the daisy there is nutrition. This involves the absorption of carbon dioxide by the cells of the leaves; it involves further the chemical transformation of the material received, and the ultimate assimilation of some of the product.

In man there is nutrition. This involves the taking of foreign material into the body, its chemical and physical transformation, and the ultimate assimilation of a part of the intake.

But whereas, in the case of the ameba, the absorption, transformation, and assimilation are all carried on by a single cell, the corresponding operations in the daisy and in man involve the work of millions of cells.

In the matter of nutrition the ameba acts as a unit. The daisy, although made up of many organs and many cells, and the human body, although made up of still more organs and

still more kinds of cells, also act as units. There is some relation between the activity of the roots and the activity of the leaves ; there is a very definite relation between the activity of the hand that conveys food and the activity of the mouth that receives it ; and also between the behavior of the digestive system and the behavior of the conducting system.

Incidentally, organisms commonly take in, besides the usable material, material that is not usable. The elimination of this refuse is accomplished very simply by the ameba ; the animal simply moves away from the refuse, leaving it behind. In the daisy the excess of mineral matter received from the soil is usually deposited in the form of insoluble compounds in various parts of the root or stem or leaf. In the human body the refuse from the food material is accumulated for a period and then discharged by the coördinated activity of special nerves and muscles.

314. Energesis and respiration. In the one-celled animal there is *energesis*, depending upon the chemical union of oxygen with other substances, under the influence of certain ferments. This is also true of the daisy and of the human body.

In the daisy, respiration is necessary for every cell ; and so it is with man. But not all the cells of these organisms can get their oxygen directly from the outside, nor can they all discharge their carbon dioxid directly to the outside. In the daisy the root cells absorb oxygen by osmosis, the oxygen passing directly into the epidermal cells, and from these by osmosis into the deeper layers of cell. Carbon dioxid diffuses out by osmosis in a similar manner. The cells of the leaf and of the stem lying under the skin absorb oxygen from the air surrounding them in the intercellular spaces ; and from these spaces there are connections to the outside atmosphere by way of the little breathing pores, or stomates. The gases move in and out through these open spaces and passages, controlled entirely by the changing osmotic pressure.

Every cell of the human body, like the cell of the ameba, gets oxygen and gives off carbon dioxide by osmosis. But the body as a whole can keep going only on condition that oxygen is brought to every cell.

This involves (1) a special set of organs for receiving oxygen from the outside — the air passages of the nose and throat; (2) a special absorbing area closely packed into a relatively small space — the lining of the lungs; (3) a conducting system that distributes the oxygen and gathers up the carbon dioxide — the blood, with the red corpuscles; and (4) a mechanism for alternately filling and emptying the bags containing the absorbing surface — consisting of bones, muscles, and nerves.

These several distinct organs and tissues act as a unit; there is some connection, that is, between the amount of oxygen used and the activity of the breathing system.

315. Excretion. In all the organisms that we have been considering, energy involves the formation of other substances besides carbon dioxide. But as some of these substances are injurious to protoplasm, their removal is necessary for the continuous life of the cells. In the ameba the wastes simply eliminate themselves by osmosis; in the many-celled organisms, getting waste out of one cell would simply mean passing it on to another.

In the daisy, wastes are accumulated in flower and root and in some stem cells, away from the live, active cells.

In the human body we find that the conducting system (the blood and lymph) absorbs the wastes from the active cells, and that the wastes are then removed from the body by means of special organs (the kidneys, with their connected tubes and bladder, and the sweat glands).

Again, there is unity in the behavior of these special organs — their activity is related to the activity of the body as a whole, and especially to the circulatory system.

316. Correlations within the organism. From every point of view that we have considered, the organisms are alike in that

they all perform the same fundamental functions. Moreover, each organism is a unity in that the various functions are somehow correlated, or harmonized. In the higher animals it is the coördination and correlation of functions that most arouse our wonder and interest. These harmonizing relations are brought about by three special systems :

1. The blood system.
2. The gland system.
3. The nervous system.

317. All life is one. From experiments, from our own observations, and from this discussion we should now be able to think of the unity of life in two distinct ways :

1. All life is one, in the sense that all organisms, large and small, plant and animal, ancient and modern, useful and indifferent and harmful, all live by virtue of doing certain things — getting food, assimilating it after more or less change, liberating energy, eliminating waste. They do other things, too ; but *these they all do, and all in fundamentally the same way.*

2. All life is one, in the sense that the many parts of an organism, however they differ from one another, are alike in their fundamental properties, and in the sense that they produce a unified series of activities. We can understand the body, perhaps, only by understanding the parts ; but we care nothing about the parts except as they have meaning for the unity, for the whole.

PART III

THE CONTINUITY OF LIFE

CHAPTER LII

GROWTH AND REGENERATION

318. How organisms grow. A living body consisting of many cells increases in size (1) by the increase in the number of cells through cell divisions, and (2) by the increase in the sizes of cells through assimilation of nutrients.

There are very many animals that keep on growing indefinitely, as certain fishes; and in plant species that have an apparently definite limit of growth some parts may keep on growing after the plant as a whole has reached its full height. Most of the familiar animals reach a fairly definite limit of growth, beyond which point they may continue to live for a long time without growing any more.

319. Limits of growth. What is it that stops the growth of an organism without killing it?

The growth of a cell depends, for one thing, upon the intake of suitable materials. In the presence of these the rate of income will depend upon the amount of *surface* exposed to the outside. The needs of the protoplasm, however, will depend not upon the amount of surface exposed but upon the amount of protoplasm — that is, upon the bulk, or *volume*. As a cell becomes larger and larger its volume increases with the *cube* of the diameter, but the exposed surface increases only as the *square* of the diameter (see Fig. 104). As a result, the cell soon reaches a point at which the surface is no longer sufficient to admit the necessary food, water, oxygen, etc., nor

sufficient to excrete the waste matters for a larger quantity of protoplasm than the cell contains at that moment. Beyond this point, growth is manifestly impossible, although at this point the protoplasm may be able to maintain indefinitely the balance of income and outgo—that is, to “live.”

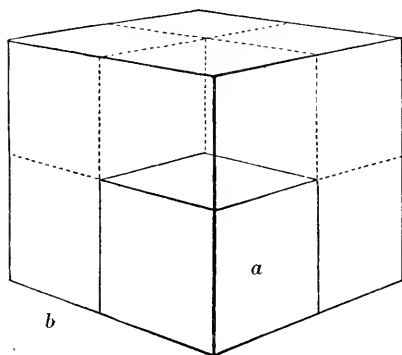

FIG. 104. The ratio of volume to diameter and area

The cube *a* has six surfaces, each a square and all the same size. The larger cube, *b*, of twice the diameter, has eight times the volume and four times the surface that *a* has. As a body increases in size the surface increases in the same proportion as the *square* of the diameter, whereas the volume increases as the *cube* of the diameter. A growing plant or animal may thus reach a size at which the surface is insufficient for the exchange of materials necessary to maintain the inclosed protoplasm

We must not suppose that the ratio of volume to superficial area is the only factor that stops the growth of cells, or that it necessarily has anything to do with it. This is simply a possible reason why the growth of cells cannot go on indefinitely. There may be other factors, chemical or mechanical or electrical perhaps, that play important rôles in this matter. We may say that the growth and multiplication of cells go on *as though* the ratio of volume to area had something to do with it.

In a thread-shaped alga like *Spirogyra* the thread of cells may grow indefinitely, because the receiving and excreting surface

of the cell is not much reduced by contact with neighboring cells (see Fig. 105). The thread-shaped cells of many fungi get to be several inches in length without dividing; this supports the idea that the ratio of surface to volume has something to do with the amount of growth possible.

320. Healing and resumption of growth. When a full-grown man cuts his hand, the cut will heal up by the formation of new cells in the neighborhood of the injured surface. These

cells are derived from other cells. Or, when a bone is broken, the ends of the bone will knit by the formation of new cells and the deposit of bone material about these new cells. This healing of skin or bone or other tissues is widespread among all kinds of animals and plants, and may be considered as a growth in response to stimulation set up by injury.

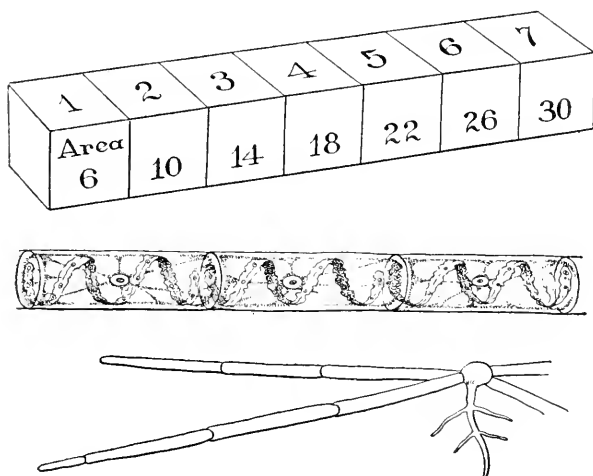

FIG. 105. Growth in a thread-shaped body

A body that grows by increasing in length only, as do thread-shaped algaë, like the *Spirogyra*, and as do the threads of fungi, changes the ratio of its volume to its surface very little. In the diagram a cube is represented as increasing in one direction to seven times its original diameter. With this growth the area has increased to five times the original surface; and with each addition in length the discrepancy becomes less and less

Not all kinds of tissues will produce new cells of the same kind. For example, we learned that the number of nerve cells in the body does not seem to increase after a child is born. An injury to the brain will heal by the formation of a scar consisting not of neurons but of connective tissue. In the same way many kinds of wounds leave scars of connective tissue that close the gaps and hold the parts together but do not function in the same way as the specific kind of cells that were destroyed by the wound. On trees we often find scars consisting of callus, produced as the result of some mechanical injury.

321. Regeneration. A small piece of a begonia leaf, placed in close contact with moist soil, puts forth tiny roots that grow into the soil; and a tiny bud is formed, which starts to grow into a shoot. In other words, it is possible to get a whole plant from a part of a plant. A part of the leaf takes on a new mode of growth, producing root cells and stem cells where under ordinary conditions there would have been reproduced only more leaf cells (see Fig. 13).

If the fore part of an earthworm is cut off, a new fore part is formed; or if the hind end is removed, a new "tail" may be grown (Fig. 106). This process of regrowing a lost part is called *regeneration*, and is in some ways similar to the healing of a wound, only it goes much farther.

Regeneration takes place to a larger or smaller extent in all kinds of animals under normal conditions of life that lead to mutilations of various kinds. A single ray of a starfish will be regenerated, or even two or three rays (see Fig. 107).

a, worm from which the anterior end had been cut off; *b*, worm from which the posterior end had been cut off. The dotted lines show where the cut was made. The shaded portions represent the new growths. (After Morgan)

Salamanders have regenerated tails and legs, and the triton, one of the lizards, can regenerate the eye. In general, however, the higher or more specialized organs are not readily regenerated, and the highest animals do not regenerate as readily as do lower animals. A finger cut from your hand will not be regenerated, although the stump may heal up. And

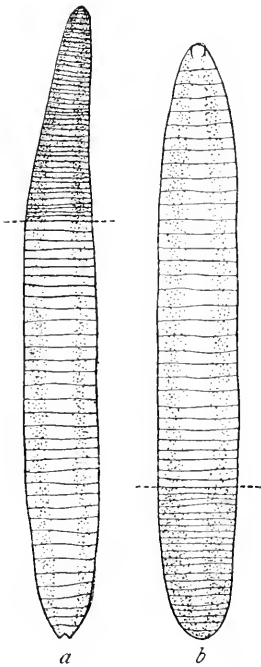

FIG. 106. Regeneration in earthworms

we should certainly never expect to make two whole pigs by cutting one into two parts.¹

Among lobsters, crabs, and crayfish the power of regeneration is also present in a very high degree. When one of these animals has his claw or one of the legs caught or mutilated, he may throw the limb off completely, the separation taking place along a definite plane between two of the joints. The wound does not bleed and the lost limb is soon replaced by the regeneration of another from the tissues about the scar.

322. Vegetative propagation.

A stem separated from the root can regenerate roots, as we have already learned (p. 48). Fruit growers propagate new lots of individuals, from trees that are especially desirable, by setting out slips, or cuttings, of these trees and having them

"set" roots. In this way all the good qualities of a given tree can be indefinitely extended to a large number of trees. Indeed, we may consider all the cuttings from a single tree as really parts of the tree growing separately. This relation has been described as a *discontinuous growth* of a single individual.

¹ The growth of the hair or of the finger nails after the ends have been cut off does not represent a case of regeneration. The hair and the nails grow continuously, the live cells in the follicle and in the root of the nail producing new cells which are being pushed forward by the new cells underneath. Cutting hair or nails simply removes the external, dead portion of the structure. The new teeth that a child gets after losing the first teeth do not represent regeneration either, since the rudiments of the second teeth are present long before the first teeth drop out. The new teeth are independent structures that develop normally and actually push out the first teeth^b

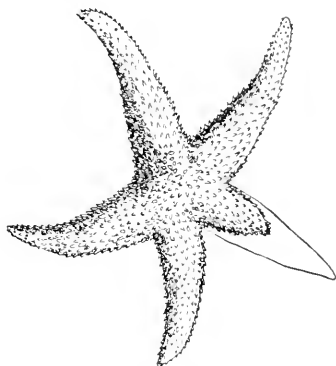

FIG. 107. Regeneration in starfish

The mutilation of starfish does not seem to kill them, for each part may regrow enough to complete a new individual. The regenerated ray shown in the figure is smaller than the rest; but in time the new ray would become full size, since regenerating tissues and organs grow faster than the uninjured parts

On the stems of most plants many more buds are produced than ordinarily develop. But an injury or a mutilation will bring about the development of some of the resting buds. If we cut into the stem of a tall india-rubber plant, close to one of the nodes, we can induce the nearest bud to swell up and begin developing. In this way we can to a certain extent regulate the form of the plant, by determining where branching is to take place (Fig. 109).

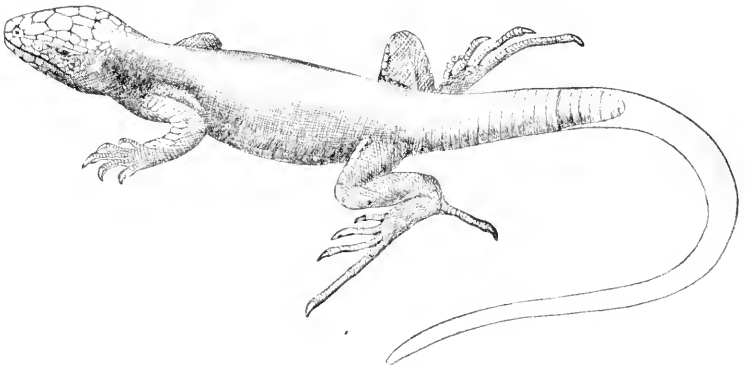

FIG. 108. Regeneration in lizard

The glass snake and other lizards throw or cut off a part of the body when attacked, and later regrow the lost tail or limb. The original tail of the lizard is an extension of the backbone; in the regenerated tail there are no vertebræ. Experimentally lizards have been made to regenerate two or three tails in succession. The figure shows the Surinam Ameiva

323. Grafting. Suppose we have a vigorous apple tree that is perfectly healthy and satisfactory in every way, except that its fruit is too hard or too small or too sour. We have no way of making the fruit of that tree of a better quality. But we can use the vigorous roots of that tree, and the food-making factories (the leaves), to supply water, salts, and food to a twig from another tree that bears the kind of apples we like (see Fig. 110). A notch is cut in one of the branches of the first tree, and the wedge-shaped butt of the twig from the second tree is fitted into the notch. The joint is covered with a special wax preparation to keep out fungi and bacteria and

to prevent evaporation and the loss of sap. In time the growing layers (cambium) of the two stems will heal together, and the juices will move through the twig and branch as though they had always been parts of the same tree. This procedure is called *grafting*, and consists essentially of making a part of one organism grow into continuity with another organism.



FIG. 109. Pollarded trees

White poplars (*Populus alba*) pollarded to supply building poles in Chinese Turkestan. Pollarding is the pruning or trimming of the branches of a tree so as to make more twigs develop. (From a photograph by F. N. Meyer, of the United States Bureau of Plant Industry)

It is possible by grafting buds or twigs to get several different varieties of apples, for example, to grow on the branches of one tree. As a rule, only closely related varieties of plants can be made to graft on one another in this way.

A *scion* always produces leaves, flowers, and fruit of its own kind, and not of the *stock* to which it is attached. This would show that the character of the original protoplasm

determines what kind of fruit will grow from a twig, rather than the character of the food that is supplied.

324. Grafting in animals. Grafting is possible in all classes of animals, but in a very unequal degree. In the insects,



FIG. 110. Grafts

A bud or twig of one plant is made to grow by means of nourishment supplied by the root or stem of another plant. The root or stem supplying the nourishment is called the *stock*; the bud or twig grafted on the stock is called the *scion*. The figure shows stem, bud, and root grafts

experimental grafts have been produced with two halves from different individuals. The most interesting grafts, from a practical point of view, are the fairly common skin grafts. More far-reaching are the experiments of recent years, in which

not only have pieces of skin or bone of one animal replaced corresponding parts of another, but whole sections of arteries, and even kidneys and other organs, have been transplanted from one individual to another.

With the improvement in the technique of such operations it is not unthinkable that we may be able in time to replace a person's diseased kidney, for example, with the kidney of a dog or a sheep, if that is found suitable, or with the kidney of another person who has recently died or who has had to have his kidney removed for some reason. This principle is now applied in the repairing of crushed bones; the injured part is neatly cut away, and the missing portion is replaced with a suitable piece of the same size taken from the leg of a sheep. The chief obstacle to the practical use of grafting with human beings and other warm-blooded animals lies in the fact that the blood, through the chemical activity of the white corpuscles, develops substances that are antagonistic to foreign proteins (see Chapter XXXVII).

CHAPTER LIII

DEVELOPMENT

325. **Many cells from one cell.** Every cell that we have studied *originated* by the dividing of some preëxisting cell. We should therefore suppose that at some time in the past our

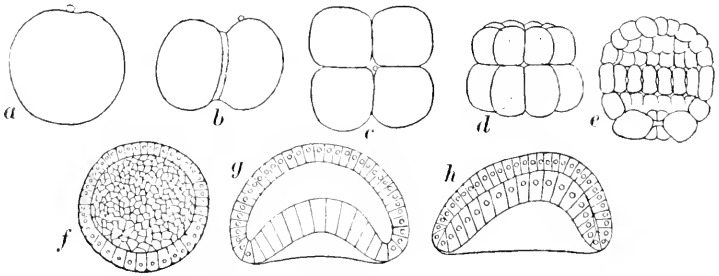

FIG. 111. Development of lancelet

a, the earliest stage of the animal, consisting of a single cell; this divides into two cells, *b*; *c*, the four-cell stage; *d*, eight cells; *e*, a hollow ball resulting from successive cell divisions; *f*, the same still further advanced; in *g* one side of the sphere has begun to cave in; this process continues until the opposite walls meet, forming a double walled, cup-shaped structure, *h*

own bodies were made up of fewer cells than they contain to-day. Then what is the smallest number of cells of which an individual animal may consist? We know, of course, that there are one-celled plants and one-celled animals. But are there one-celled oak-trees and one-celled elephants? An examination of the facts of development shows us that every individual, plant or animal, starts life as a single cell.

If we begin with this one-celled body, we can understand from our earlier studies how it may become a many-celled body (Fig. 111).

326. Differentiation of cells. When there are two cells (Fig. 111, *b*), they are exactly alike. When each of these divides, the four resulting cells are exactly alike. By repeated divisions the number of cells is rapidly increased. In some species the cells are all alike until a very large number are present. In other species of animals it is possible to observe a difference of size after only a few divisions (see Fig. 112).

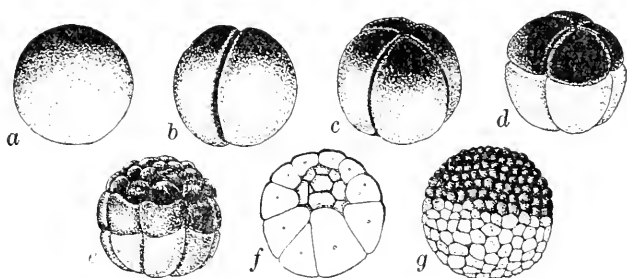

FIG. 112. Early stages in the development of a frog

In the frog's egg there is a considerable amount of food matter, or *yolk*, in addition to the protoplasm. This yolk material is heavier than the protoplasm, and remains at the bottom of the mass. So long as the cell divisions are in a vertical plane, *b*, *c*, all the cells formed may be alike; but when walls are formed in a horizontal plane, *d*, the upper cells will be smaller than the lower ones, for while all the cells may have the same amount of protoplasm, the lower ones will have larger quantities of yolk and will thus be larger. *c*, *f*, *g*

At first all the cells divide at about the same rate. Later the cells in one region divide more rapidly than those in other regions.

We can readily understand that while a starved cell may not be able to *do* as much as a well-nourished cell, a cell that contains a large surplus of inert food material may yet not be as active as one that is not thus handicapped. In Fig. 112 the cells on the upper surface are not only smaller, but in a given time they will also become more numerous, because the cell division proceeds at a more rapid rate.

With inequalities in the rate of division, and inequalities in the sizes of the cells, the shape of the whole mass soon departs from that of a perfect sphere (Fig. 111). With the

formation of new cell layers and with changes in the form of the young embryo there gradually arise new kinds of cells. At first these are in layers, or membranes. We may say that the embryo at one time consists of membranes and cavities. These membranes grow out irregularly into the cavities, forming folds; they break through in places, and they unite in other

places. In this way there appear the tissues and the organs that make up the young animal.

327. Stages in development. If we make a closer comparison of the development of a number of animals, some remarkable facts appear. In the beginning, we may say that all animals are like the protozoa—that is, each one consists of a single cell. Now if we take a large number of higher animals, like the starfish, the snail, a primitive, fish-

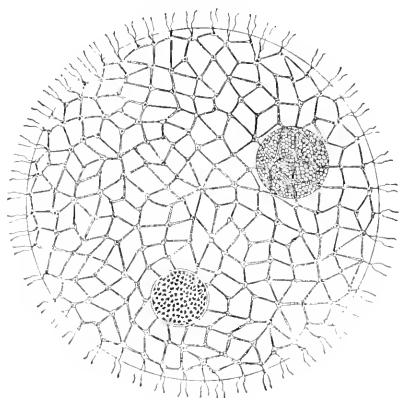

FIG. 113. Volvox

This organism consists of a hollow sphere made up of a single layer of cells connected by strands of protoplasm. The colony moves about in the water by means of *cilia*, or vibrating protoplasmic threads. Each cell contains chlorophyll

like animal called the *lancelet* (*Amphioxus*), and others, we shall find that in the development of each there is reached a stage consisting of a hollow sphere of cells, which has been likened to a golf ball in appearance (Fig. 111, *e, f*). This hollow ball can be very well compared to such an organism as the *volvox* (Fig. 113). In the development of the frog, birds, and many other animals this stage does not appear so clearly, because the presence of the yolk obscures the symmetry of the hollow sphere.

When the hollow sphere caves in and the opposite sides meet, forming a two-layered cup (Fig. 111, *g-h*), this stage of

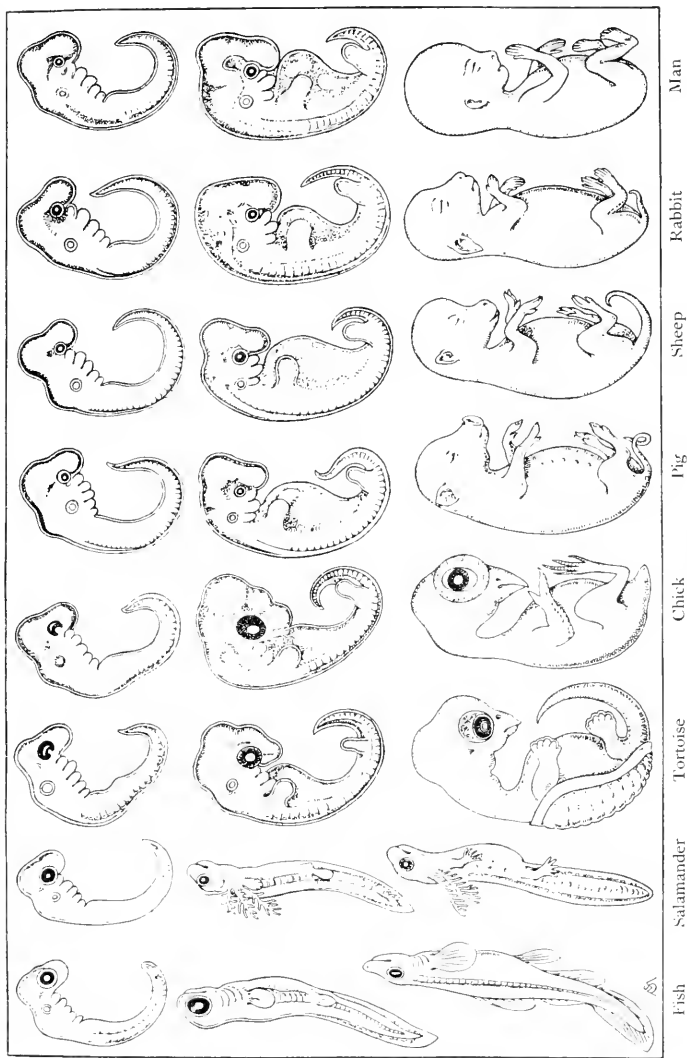

FIG. 114. Parallelism in development of backboned animals

The three rows of embryos represent distinct stages of development. In the first row the stages of the different species are very much alike; in each succeeding stage they are more distinctive

the organism may be compared to animals related to the hydra, which get to this stage of development but never get much farther. Then the two-layered cup becomes longer, suggesting certain kinds of worms.

When we compare the embryos of animals that are closely related, such as several kinds of backboned animals, or several kinds of insects, we find still more remarkable facts. Thus, the fish, the bird, the salamander, and the rabbit are very much alike early in their development, not only when each consists of a single cell, but later, when it is possible to distinguish head and trunk and limbs (see Fig. 114). In a somewhat later stage each has developed a little farther, and it is not difficult to distinguish the bird from the fish or the tortoise. But at this stage we can see certain resemblances between the bird and the reptiles. Moreover, if we compare the embryos of several mammals (such as the rabbit, the pig, the sheep, and man) at this stage, we shall find them strikingly similar. As they become older they become more and more different.

328. Recapitulation. Now if we imagine a series of animals of different degrees of complexity, beginning with the one-celled ameba and ending with man, we shall have before us a picture resembling in many ways the series of stages through which each individual human being passes, from his one-celled stage to his maturity (see Fig. 114). This parallelism between the stages in individual development and in the whole animal series was observed long ago, and is known as Von Baer's Law of Recapitulation. Some biologists have gone so far as to say that each individual passes through stages representing all the types of his ancestors. In a general way this is true only as a restatement of Von Baer's law. But, strictly speaking, it is not true, for example, that you once passed through a hydra stage or a fish stage. All we can say is that we have passed through *stages* that are similar to corresponding stages in many classes of animals.

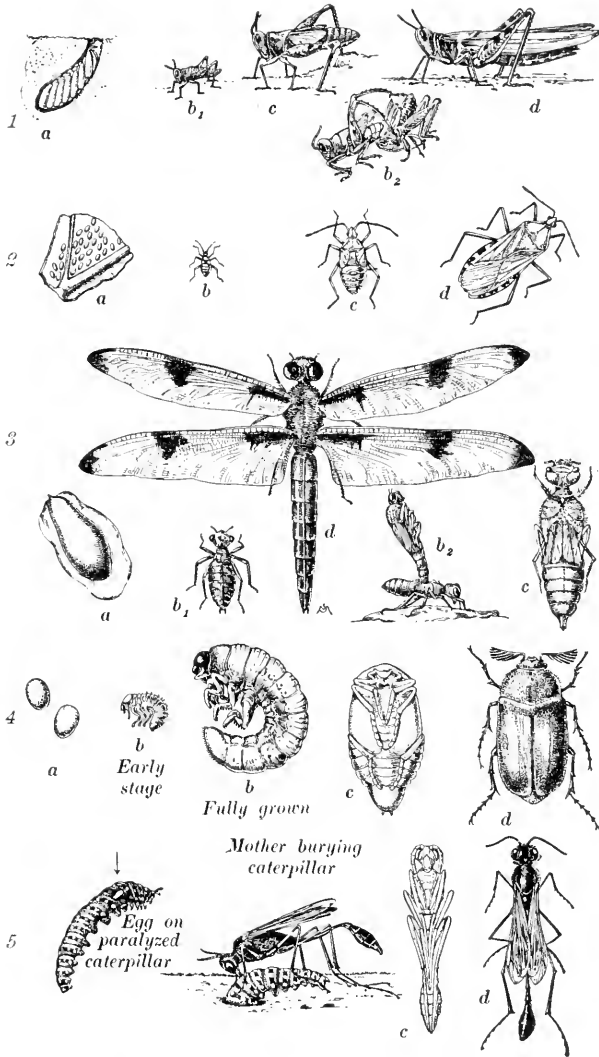

FIG. 115. Life stages of various insects. (All about $\frac{3}{4}$ size)

1, red-legged locust (*Melanoplus femur-rubrum*); 2, squash bug (*Anasa tristis*); 3, dragonfly (*Libellula*); 4, June bug (*Melanontha*); 5, wasp (*Sphex gryphus*). a, eggs; b, larva (not shown for 5) (in 1 and 2 the larva is similar in general form to the adult; successive stages are attained by molting, b_2); c, pre-adult (in 4 and 5 this is a resting stage, or *pupa*); d, adult. The larva of the wasp develops within the caterpillar buried by the mother wasp

329. Transformation. When we compare a chick as it comes out of the shell with the contents of the eggshell before hatching begins, we cannot conceive that the little speck on the side of the yolk has become the chick, with its many organs and its many kinds of cells with their many peculiar functions. And yet all that comes out of the eggshell must have been there at the beginning of the incubation period. We are so familiar, however, with the fact that chicks come from eggs,

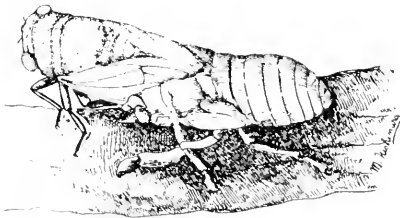

FIG. 116. Molting cicada

In many jointed-legged animals (Arthropoda) the growth takes place at intervals between molts. The hard outer skeleton breaks open and the soft-skinned animal crawls out. After a while the shell hardens and growth stops again

that we are content to accept the changes that go on inside, on the supposition that, since they are so gradual, everything is possible.

egg, it is very much like the parent, except that it is very small and lacks wings (Fig. 115, $I(b_1, b_2)$). By a series of *moltings* the animal advances not only in the matter of size but in the development of the wings and other organs.

A study of the development of insects will give us an idea of how sharply limited the stages in an individual's life may be. When a locust or a cockroach comes out of the egg, it is very much like the parent, except that it is very small and lacks wings (Fig. 115, $I(b_1, b_2)$). By a series of *moltings* the animal advances not only in the matter of size but in the development of the wings and other organs.

When the egg of a moth or of a butterfly hatches out, the young animal that emerges is not at all like the parent; it looks more like a worm (Fig. 117, b, b). It has no wings; its mouth has biting jaws that work sideways; its coloring is different. Indeed, if we did not know that it came from the egg of a butterfly, or that it would in time become a butterfly itself, we should never suspect, from its appearance, that it had anything to do with butterflies. We may well believe that during all the months of outward inaction something was going on inside the case of the pupa, just as

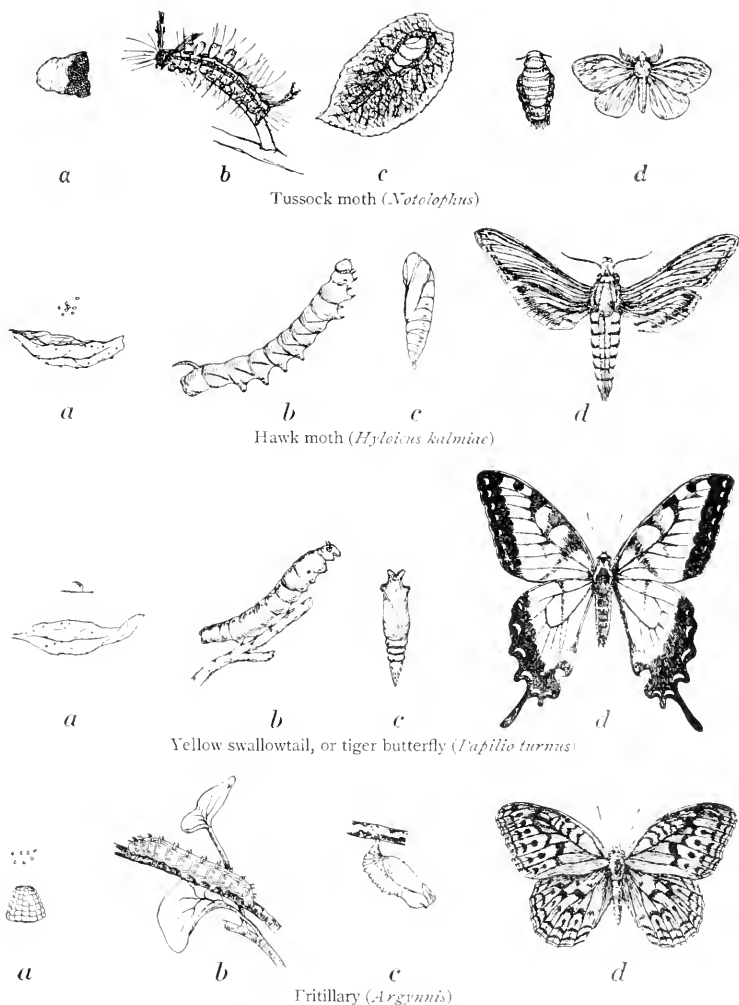

FIG. 117. Development of Lepidoptera (moths and butterflies)

The egg, *a*, hatches into a wormlike larva, or caterpillar, *b*. The larva feeds voraciously and grows very rapidly. On reaching full growth it curls up, secretes a hard covering, and goes to sleep. In this resting stage, or *pupa*, *c*, it may remain for months, giving no outward sign of life whatever. At the end of the resting period the cover of the pupa breaks open, and out crawls the fully formed insect, *d*. In some species the two sexes have distinct forms or color patterns in the adult stage. In the tussock moth the adult female is a sluggish, wingless animal. (All about $\frac{3}{4}$ size.)

Fish, Chinook salmon (*Oncorhynchus tshawytscha*)Batrachian, frog (*Rana palustris*)Batrachian, newt (*Amblystoma punctatum*)

FIG. 118. Development in some backboneed animals

a, egg; *a₁*, fish ready to break out of egg; *b*, first free-swimming stage (tadpole in batrachians); *c₁*, later stage in fish, still showing yolk sac; *c*, more advanced stage (in batrachians, tadpole just before the appearance of hind legs); *d*, later stage; *e*, adult form

during the three weeks of hatching something was going on inside the eggshell of the chick.

The development of an individual through a series of well-marked stages is called a *metamorphosis*, which means "trans-formation."

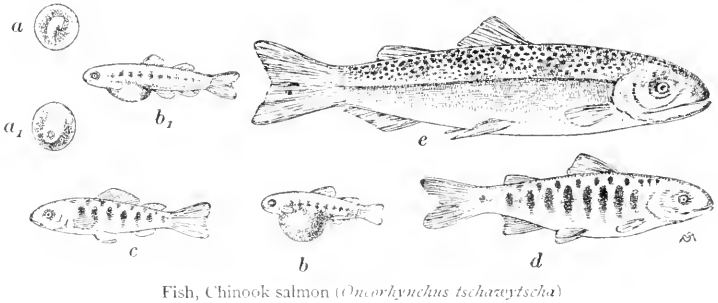
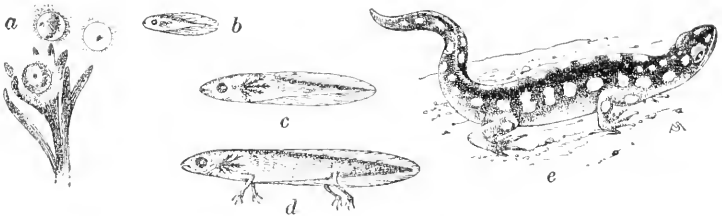
In the large class of Insecta the development is characterized by more or less complete metamorphosis (see Figs. 115 and 117).

In the life history of the frog and the salamander we find a metamorphosis that is as well marked in some ways as that of the insects (see Fig. 118).

A complex animal, developing from a single cell, passes through a number of stages that are different from the finished form, on the one hand, and from the simple beginning, on the other. This is really all that *metamorphosis* means when applied to living things in general. It is another name for development. But when we use the latter term, we have in mind the *process*, whereas when we say "metamorphosis," our attention is fixed on the *forms*, or stages.

330. Metamorphosis in

man. The changes that take place in a human being from day to day are comparatively slow, and

the form of the infant is in general very much like that of the adult, so that we do not commonly think of the metamorphosis of human beings. But if we compare the proportions of a baby with the proportions of an adult, we can see that the changes are real even in the outward form (see Fig. 119). A man is something more than a large baby, something different, even in this outward form. We know, of course, that as we become older there are many changes in the internal

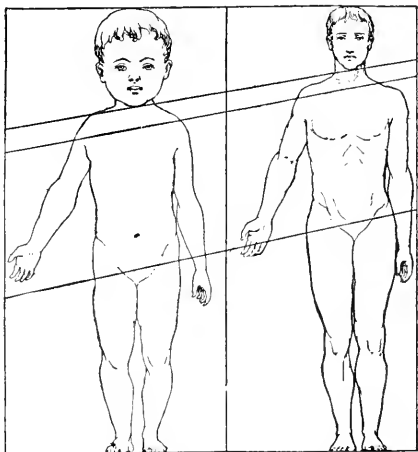

FIG. 119. Metamorphosis in man

A comparison of the infant and the adult shows that after birth the legs of the baby grow more than any other part, whereas the head grows the least. A study of this figure will show other changes that take place in the outward form

organs: some organs present in infancy disappear, others not present make their appearance later, and others are present at first in a rudimentary stage and gradually reach maturity.

331. Development of plants. The simpler stages in plant development are not so familiar to us, so that we do not have the same opportunity to observe the similarities. In our study of the embryo

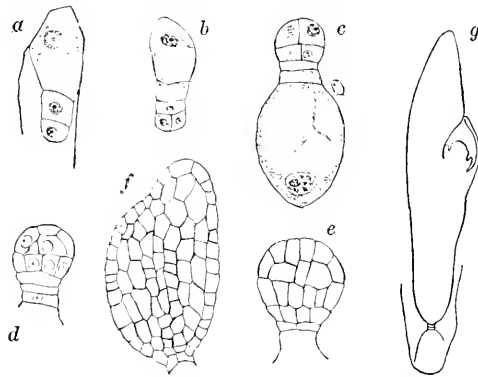

FIG. 120. Development of a plant embryo

Beginning, like an animal, as a single cell, *a*, the plant passes, by a series of cell divisions, *b, c, d, e*, into a mass without any definite form, and gradually assumes distinct structure and organs, *f, g*

of the seed, we saw that the young plant had all the main parts of a plant body, although the embryo did not at all resemble the full-grown plant. The embryos of related plants look much more alike than the adult individuals, just as the tadpoles of the newt and the frog look more alike than the adults. Thus, the embryo and even the seedling of the squash and of the pumpkin are so much alike that it would take

a very experienced person to see any differences between them, aside from size. The different kinds of beans appear very distinct in the full-grown plant and in the seeds, but the seedlings with the first pair of leaves look very much alike.

If we examine the stages in the development of the embryo, *before the seed is ripe*, we shall find still greater similarities in the earlier stages, before the stem, leaf, and root of the embryo are distinguishable, among plants that are not so closely related as are the squash and pumpkin, for example (see Fig. 120).

CHAPTER LIV

CONDITIONS FOR DEVELOPMENT

332. Development and life. The conditions for the development of young plants are the same as the conditions for growth or for being alive. Development is, in fact, one of the aspects of being alive — just as assimilation, energesis, irritability, etc.

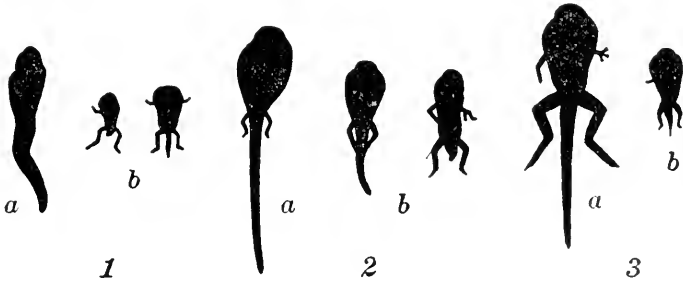

FIG. 121. Influence of thyroid on development

In each series, *b* shows the tadpoles that had been fed on thyroid much more advanced in development, although smaller, than the controls, *a*. The control animal in 1 was fed on plant food, in 2 on muscle, in 3 on adrenal. All full size. (After Gudernatsch)

are aspects of being alive. But development goes on so slowly in most of the familiar plants and animals that most people do not notice it as a distinct fact until their attention is called to it. Changes in the external conditions influence the development of animals, just as they influence the development of plants.

That the development is not altogether a matter of growth has been shown over and over again. In certain experiments conducted by Dr. J. F. Gudernatsch, of the Cornell Medical College, tadpoles were fed on thymus glands obtained from

calves, while others were fed on thyroid material. The former lot of tadpoles grew to a large size, but remained tadpoles, whereas the latter quickly passed through the stages of development without increasing much in size (see Fig. 121).

333. Temperature and development. The temperature of the water in which frogs' eggs are kept will influence the

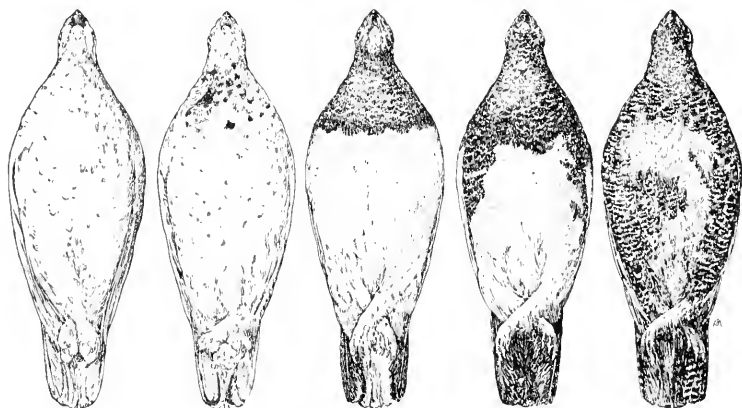

FIG. 122. Color changes in plumage

The ptarmigan (*Lagopus lagopus*) is snow-white in winter and replaces its coat with feathers containing more and more pigment as the seasons advance, reversing the process in the autumn, so that the plumage matches the surroundings the whole year round

rate of development. The warmer it is, up to a certain point, the more quickly will the tadpoles pass into the tailless stage.

Temperature may affect not only the rate of development but other sides of the animal's make-up. Sheep taken to the tropics lose their wool, and in New Guinea they become almost bald. Some English dogs that had been taken to the higher parts of the Himalayas developed a woolly coat. The hare, like many other animals in temperate climates, has a summer coat and a winter coat. In the Alps the animal carries its winter coat about half the year; in Norway, from eight to nine months; in Lapland, about ten months; and in Greenland, the whole year round.

The white plumage of the ptarmigan in winter (Fig. 122), and the white winter coat of the weasel and of other animals, have been associated in our minds with the snows. But experiments have shown that the change in the pigmentation is brought about by a lowering of the temperature. And observation has shown that it does *not* always coincide with the appearance of snow.

Another effect of temperature upon development is shown by the experiments made on insects and other animals. There

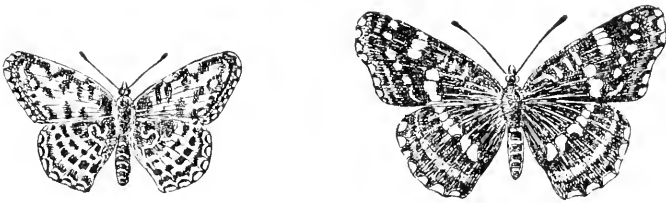

FIG. 123. Effect of temperature on development

In the butterfly *Vanessa levana prosa* the two broods have distinct patterns. By keeping the eggs, larvæ, and pupæ of the spring brood at a low temperature, it has been possible to make the imagos appear in the fall with exactly the same coloring as the spring brood. This showed that the two forms differ from each other because of the influence of the temperature

are many species of butterflies that produce two broods each year. The pupa survives the winter, and the adult emerges in the spring. The eggs laid shortly after give rise to a generation that reaches maturity in the summer. In many of such species the spring form is often distinctly different from the summer form in size, pigmentation, or pattern (see Fig. 123).

Experiments have shown that the so-called *local* races or varieties of insects differ from each other chiefly, if not entirely, because of the influence of temperature.

These examples of the influence of temperature on the life of animals illustrate the irritability of protoplasm in a way that is somewhat different from our earlier studies, and they illustrate a different kind of *response*. Instead of getting a contraction or

a chemical reaction, we find that the effect of the temperature is to produce a definite kind of organic behavior on the part of certain portions of the animal or on the part of the animal as a whole. This behavior is of a continuous kind, not momentary.

334. Light and development. Light influences the rate of growth and the direction of growth in plants, and it influences the formation of pigments in animals as well as in plants. But we know very little about the influence of light upon the development of organisms, apart from the influence upon growth. So far as studies have been made, most organisms develop as well in darkness as in light, although all protoplasm is sensitive to extreme light, which is fatal to bacteria of many kinds and to other living beings that cannot protect themselves adequately against the light rays. It is for this reason that the higher organisms, which have opaque, or pigmented, exteriors, generally thrive better in well-lighted places than in total darkness. Horses and cattle kept in dark stables are exposed to more danger from bacteria; human beings that are kept in dark dwellings, workrooms, or underground cellars or mines are exposed to more danger from bacteria.

335. Food and development. The *amount* of food received by a plant or an animal at a given time — for example, early in youth — has a greater effect than the amount received at another time. If a calf has been underfed, he will have a comparatively large head, long legs, and large joints. *No amount of overfeeding later in life will even up the development.* The same is true of children. Underfeeding or unsuitable feeding in infancy will not only stunt the growth, but will cause a disproportionate growth which can never be made up later.

Experiments have shown that the *character* of the food will in many cases influence the development of an organism in a more direct way. Thus, the intestines of tadpoles fed on vegetable matter, compared with the intestines of tadpoles fed on more concentrated food, were found to be considerably longer. This may be a case of stimulating the growth of a special organ by overexercising it. In general, we should expect a full development of all the parts of an organism only

when a suitable food supply — suitable in quantity as well as in quality — is provided. Overfeeding, especially in animals, will affect the development, as well as underfeeding, by affecting the health of the digestive organs or of the excreting organs, or by leading to a deposit of fat in one or more organs. Certain special substances, we have already found, may have a direct influence upon the development as well as upon the growth and activities of the body.

336. Chemical influences. The direct influence of chemical substances upon the growth and development of organisms is best observed in the lower plants and animals, in which there is no great modification of the received material before this reaches the protoplasm. Nevertheless we have already learned that thyroid extract can influence the development of the body of the frog (p. 285), and it is well known that a derangement of the thyroid gland affects the development (especially of the central nervous system) in human beings.

Over forty years ago a Russian observer reported that two species of a small crustacean of the genus *Artemia* could be converted one into the other by a change in the amount of salt in the water. The form that usually lived in the less salty water acquired some of the characters of the other form on being placed where evaporation increased the relative amount of salt in the water. And the second form acquired some of the characteristic structures of the first when placed in a brine that was gradually diluted by the addition of fresh water. Under natural conditions that sometimes bring about a gradual dilution of sea water by rains, or a gradual concentration of waters by evaporation, modifications in the development of mollusks, arthropods, and other animals have been observed. These modifications extend to forms, colors, shells, bristles, and other parts.

By changes in the chemical condition of the medium, experimenters have made the eggs of certain fish develop into animals having a single eye in the middle of the head; and

other " freak " forms have been produced as a result of changing the external conditions of development.

337. Internal factors. In considering the conditions under which development takes place, we have given attention chiefly to the evidence that exceptional conditions will interfere with or modify what we usually consider the normal course of development. We must be on our guard, however, in respect to two points :

1. Whatever the possibilities of an egg, these possibilities can become realities only under certain definite series of external conditions. Thus, the egg of the frog or the fish must be in water if it is to develop ; the egg of the hen must be kept above a certain temperature if it is to develop at all ; and so on.

2. But the external conditions are not to be thought of as the *causes* of the development, for by themselves they are not the causes. The protoplasm inside a hen's egg, with the water and salts and food in the egg, with the air that circulates through the shell, with the temperature — *all these factors together cause the becoming of the chick*. The fundamental and distinctive factors are in the minute, invisible parts of the protoplasm. The external conditions make the development possible, but the nature of the plant or animal, or rather the organic possibilities of the organism, are already present in the protoplasm.

External conditions are related to development in several different ways :

1. They may supply materials essential to the activities of the protoplasm — for example, growth.

2. They may supply conditions for the chemical action of the parts of the protoplasm, as moisture, heat, light.

3. They may stimulate the activities of certain parts of the developing organism or certain of the chemical processes in the protoplasm.

4. They may retard certain of the activities or processes, or they may prevent certain activities.



CHAPTER LV

NEW ORGANISMS

338. Reproduction. One of the common facts about life is that the life of every organism comes to an end sooner or later. Yet the species, or kind, may continue to live for centuries. This is explained, of course, by the fact that new individuals are constantly being produced. The process by which organisms give rise to new individuals is called *reproduction*.

The term *reproduction* carries the idea of a *special* portion of the parent organism being separated and developing into an individual. The simplest

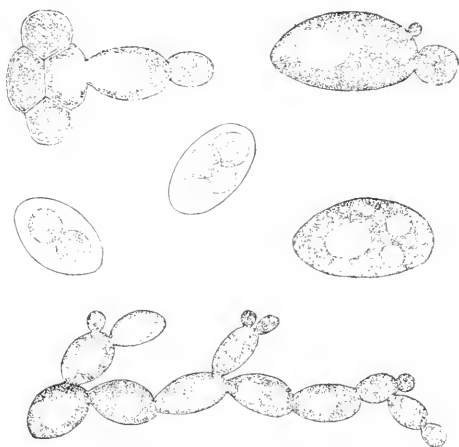

FIG. 124. Yeast plant

The cells of this plant multiply by pushing out buds. Under certain conditions the protoplasm of a cell divides into two and then four parts, which then can remain inactive for an indefinite time. These resting cells are called *spores*

case of which we know is that of a cell division among one-celled plants or animals. When such an organism (for example, a Paramecium, or a Pleurococcus cell, or some bacterium) divides into two, it at the same time reproduces. The number of individuals is thus multiplied by a process of division, or cell fission. Cell division resulting in the multiplication of individuals occurs among nearly all one-celled plants and animals.

339. Budding cells. In some organisms new cells are produced in a different way. The yeast plant, for example, which absorbs its food from the surrounding liquid, continues to grow indefinitely without undergoing cell division. When a cell has reached a certain size, it puts forth one or several

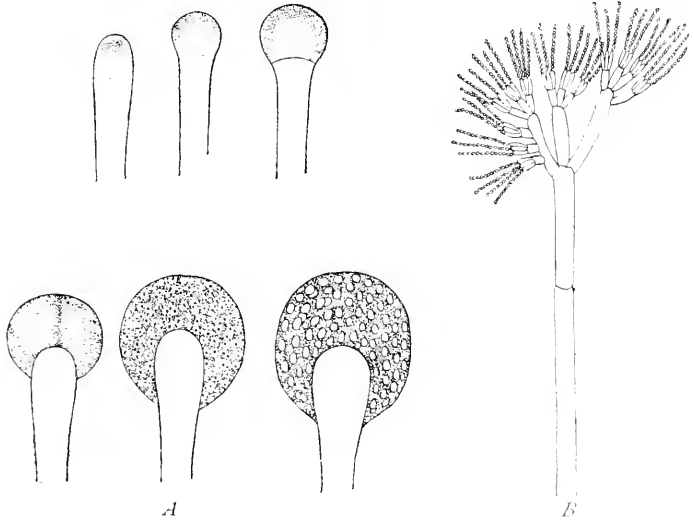

FIG. 125. Spores in fungi

A. In the black molds, reproductive cells (spores) are formed by the repeated division of the protoplasm in an enlarging cell at the end of a thread. When mature, the inclosing wall breaks and the spores are scattered. *B*: In the blue molds, spores are formed by the successive separation of terminal portions of the branched threads. This is a type of fungus used in ripening Camembert cheese

swellings. As all of the exposed surface of the original cell and of the buds absorbs food and water, the protoplasm grows, and the buds may put forth buds in turn (see Fig. 5, 5, and Fig. 124). A bud sometimes drops down; it then continues its growth and its budding, like a new cell. In an organism of this kind the buds are to be considered as new cells or as parts of the parent cell. It is a matter of chance when the bud drops off and begins to live independently. This is another case of what is called *discontinuous growth* (see p. 269).

340. Spores. The cells of yeast change their behavior when the yeast is growing in a solution that is gradually evaporating, or when the food in the solution is gradually being used up, or when it is exposed to an extreme change in temperature. It is often found under such unfavorable conditions that the yeast plant will produce peculiar kinds of cells (see Fig. 124).

A special cell like those described in the yeast (that is, a cell capable of continuing the growth of the plant from which it is derived) is called a *spore*. Spores are produced by nearly all plants and by a number of animals.

The bacteria often produce spores by the formation of a rather thick cell wall when the conditions for growth are not favorable. It is the resisting power of the spores that makes it so difficult to kill certain species of bacteria by boiling.

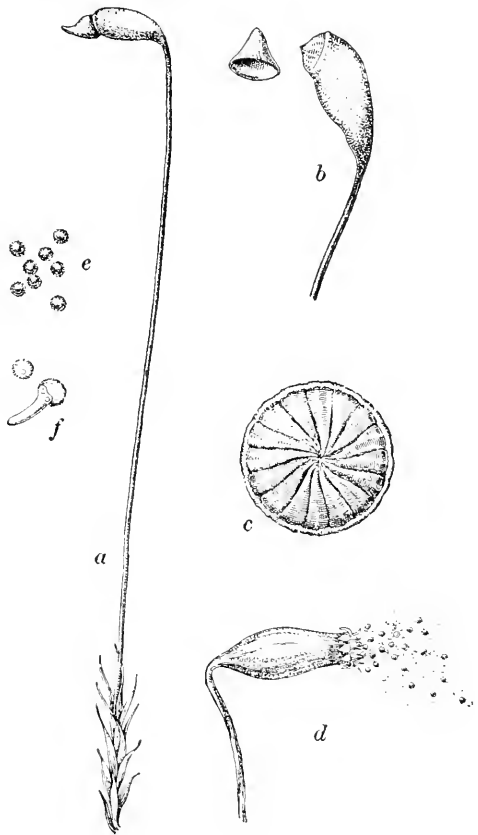

FIG. 126. Spore capsule of moss

a, spore case with stalk, on top of leafy plant; *b*, enlarged view of spore case, with cap removed; *c*, closed surface of capsule tip after removal of cap; *d*, capsule bursting open and discharging spores; *e*, spores, greatly magnified; *f*, spore beginning to germinate by sending out a fine thread of protoplasm. *a*, *Thuidium virginianum*; *b*, *c*, *Funaria americana*; *d*, *Orthotrichum schimperii*; *e*, *Bartramia pomiformis*; *f*, *Funaria hygrometrica*

All fungi, mosses, and ferns, and even the flowering plants, produce spores in very large quantities (see Fig. 125).

The mosses produce spores in rather larger capsules on the ends of very delicate but stiff stalks growing out of the top of

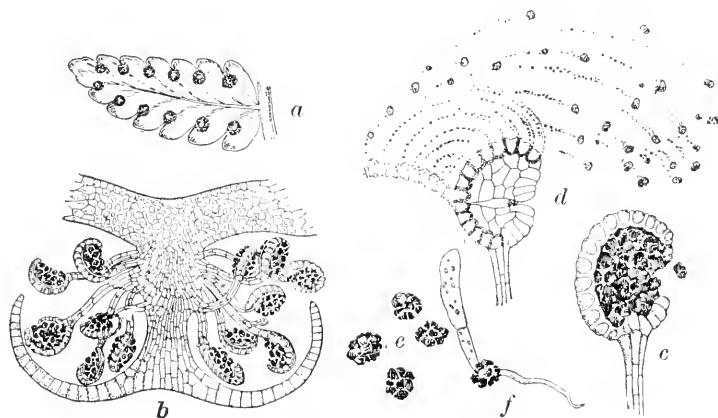

FIG. 127. Spores of fern

a, back of a fern leaflet, showing arrangement of *sori* (singular, *sorus*), or clusters of spore cases; *b*, section through a sorus, showing spore cases with inclosing layer of thin tissue; *c*, single spore case, greatly enlarged; *d*, same bursting open and discharging spores by the sudden straightening out of a row of thick-walled cells; *e*, spores, greatly enlarged; *f*, spore germinating into a new plant

the leafy stem. Ferns produce spores in little capsules found in groups on the undersurface of the leaves, or, in some species, right under the edge (Figs. 126 and 127).

341. Spores in animals. A number of one-celled animals related to the ameba produce spores in a manner that can be compared to the process described in the yeast plant. But the number of spores produced is usually very large, and in some cases the spores do not have thick walls, but are rather active. The protozoön that is the cause of malaria is related to the ameba, and is parasitic on the red blood corpuscles. When the mass of protoplasm has grown to its limit, it breaks up into a large number of pieces, and these are thrown into the

blood plasma. The chill that accompanies this disease takes place just at the time when the spores are being discharged.

342. Swimming spores. In many of the algæ, cells may break up into a number of spores (usually four), but these differ from the spores of the fungi in having rather thin walls

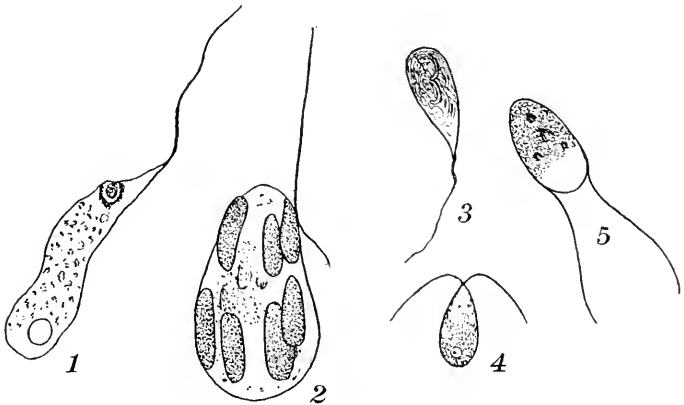

FIG. 128. Swimming spores

In many of the chlorophyll-bearing water plants that do not produce seeds (algæ), swimming, or swarm, spores are produced. 1, *Chondrioderma difforme*; 2, *Conferva bombycina*; 3, *Botrydium granulatum*; 4, *Haematococcus phaeovalis*; 5, *Chlorosphaera limicola*

and in being provided with cilia, by means of which they swim about in the water, suggesting minute animals (Fig. 128).

343. Cysts. There is still another kind of cell that may be classed with the spores. This is formed by many protozoa when the conditions for their usual activities are in some way unfavorable. The protoplasm shrinks into a round mass, and a thick cell wall, or *cyst*, is formed. In this encysted condition the protoplasm may rest for an indefinite time, resisting the unfavorable conditions. The animal may thus survive winters or droughts, or perhaps escape destruction when taken into the food tube of a large animal.

CHAPTER LVI

SEX

344. Conjugation in Paramecium. After reaching a certain size the Paramecium will divide into two cells, and the new cells will again divide, and so on for hundreds of times, when the conditions are favorable. Under ordinary conditions, however, this successive division does not continue indefinitely. After a number of divisions the cells usually become smaller and less vigorous, and then the strain is likely to die out.

Yet ordinarily the species does not die out. Sometimes two individual cells come in direct contact, side by side, and stop swimming. The two animals then *exchange nuclear matter* (see Fig. 129). This process of exchanging nuclear material and combining the nuclear material from two different cells is called *conjugation* (that is, a yoking, or joining, together).

After the conjugation the Paramecium cells seem to be changed, since now they are better able than before to carry on their growth and cell division. How the conjugation causes the animal to take on its new lease of life is not understood, although there are several theories offered to explain what happens.

345. Conjugation in Spirogyra. In the Spirogyra all the cells that make up the threads may take part in conjugation, when the conditions are right. The protoplasm of two cells combines into a single cell that is capable of surviving conditions unfavorable to growth (see Fig. 130).

346. Zygotes. In certain ways the cell resulting from the conjugation of two cells is different from a spore. The important difference is in the way it *originated*. All the cells which we have studied heretofore originated by the splitting, or dividing, of some preëxisting cell. The spores of yeast and

of other plants are the result of the successive *divisions* of the protoplasm of some preëxisting cell. But the sporelike cell of *Spirogyra* originated in the *union* of two preëxisting cells. This conjugation product is called a *zygospore*, which means a spore produced by a joining together; it may be called a *zygote* for short.

347. Gametes. The cells that conjugate to produce zygotes are called *gametes*, which comes from a Greek word meaning "to marry" — that is, to join, or *unite with*. In the case of the *Spirogyra*, it is impossible to tell, from the appearance of the cells, which are to become the resting, or receiving, gametes and which the moving, or supplying, gametes. No doubt there is some difference in the chemical conditions between the two strings of cells, but what the difference is has not been found out.

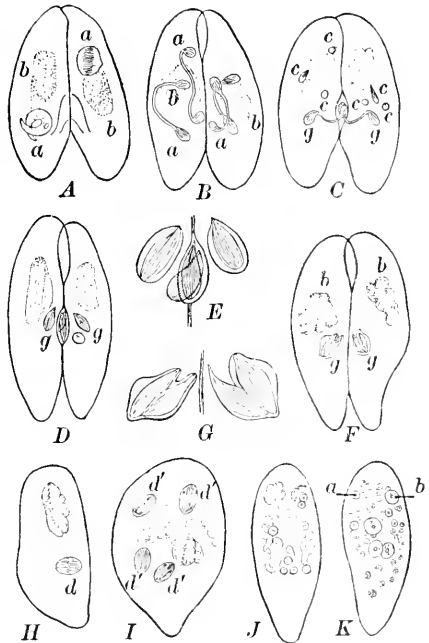

FIG. 129. Conjugation in *Paramecium*

There are two nuclei: *a*, the small (*micronucleus*); and *b*, the large (*macronucleus*). *A*: Two individuals become attached and their micronuclei begin to divide. *B*: The half nuclei divide a second time. Of the four units resulting, three are called polar bodies, *c*, and the fourth is a germ nucleus, *g*, which again divides. *C*: The germ nuclei are interchanged, one of each pair passing over to the opposite animal. *D*, completion of the interchange. *E*, same, further enlarged. *F*: the active germ nucleus fuses with the stationary one. *G*, same, enlarged. In the meantime the macronucleus has broken up and disappeared. After the restoration of the micronucleus through fusion, *F*, the two individuals float apart. *H*: The new micronucleus, *d*, breaks up into two. *I*, each portion splits again. *J*, after a third division. *K*: Four of the nuclei become new macronuclei and four remain as the micronuclei. The rest of the protoplasm divides and four individuals result, each with a micronucleus and macronucleus. (From Calkins, after Hertwig, and Maupas)

Among some of the fresh-water algæ the swimming cells produced are of two sizes. In such cases the smaller cell is usually more active in the water; the larger cell has more food material. In the common rockweed, or bladder wrack, of our

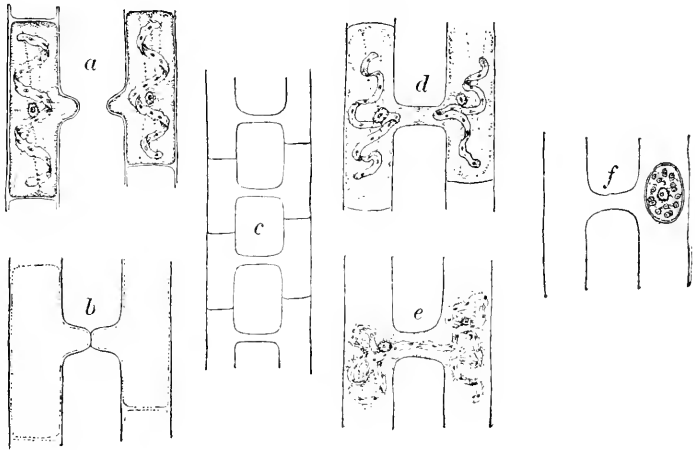

FIG. 130. Conjugation in Spirogyra

Cells lying close together put forth processes, or projections, toward each other. *a*. As these processes finally come in contact, *b*, the two threads with their crosspieces have the appearance of a ladder when looked at through the microscope, *c*. The cell walls at the points of contact are dissolved, probably by the action of a ferment, and there are thus formed continuous passages between the cells of one thread and the cells of the opposite thread. *d*. In the meantime, however, changes have been taking place inside the cells. The spiral ribbon of chlorophyll seems to break down, *d*; the mass of protoplasm in each cell draws away from the cell wall; and the protoplasm from one of the cells of each pair moves into the connecting tube and passes completely into the opposite cell, *e*. Here the two masses of protoplasm unite into one, and a thick cell wall is formed around the new combined protoplasm, *f*. The cell with the thick wall, inside the old dead cell wall, may apparently remain in a resting state indefinitely, or may begin the next day to put out a thread of new Spirogyra, giving rise to millions of cells in the course of a few days

seacoast, the gametes are produced in special organs found on certain of the bladderlike expansions of the plant body. When formed, the gametes are discharged into the water and have nothing more to do with the parent plant (Fig. 131).

348. Fertilization. When the two gametes are so unlike as to be distinguishable, the process of conjugation is sometimes

called *fertilization*. The essential thing about fertilization is the uniting of two different nuclei into one. What the meaning of this process is in the life of organisms we do not know with certainty. We know some of the effects of the process, and we can tell what conditions lead up to it in some cases.

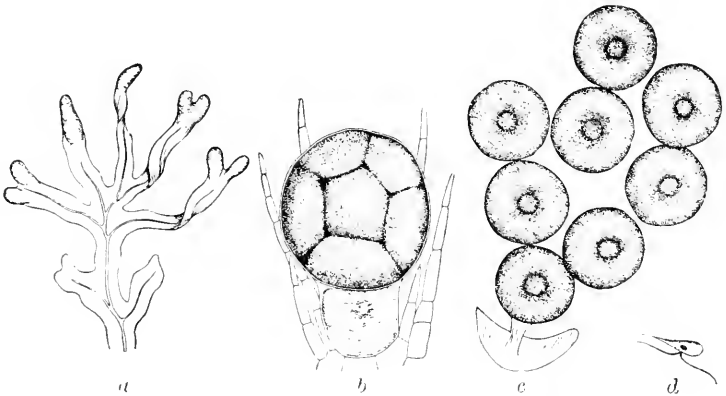

FIG. 131. Reproduction in rockweed, or bladder wrack

a. expansions of the rockweed containing the gamete organs; *b.* section of an egg-bearing organ; *c.* the large gamete, or *egg*, with large, distinct nucleus and food granules; *d.* the small gamete, or *sperm*, having the shape of a pear and bearing motile cilia. Sperms swarm around an egg until one of them unites with the egg. After the conjugation the zygote develops into a new individual

349. Male and female. The gametes that are so unlike as we have seen them to be in the rockweed are distinguished by special names. The large gamete is sometimes called the *öosphere*, or egg cell. The small one is called the *spermatozoid*, or the sperm cell. We sometimes distinguish the two gametes by calling the large one the female and the small one the male.

Most of the familiar plants and animals reproduce by means of male and female gametes, forming zygotes. This kind of reproduction is called *sexual* reproduction, in distinction from reproduction by spores, which is called *asexual*; that is, without sex. There are many animals and very many plants that reproduce both sexually and asexually (see Chapter LXI).

CHAPTER LVII

FLOWERS

350. What do flowers mean? We know that roots, stems, and leaves, with their various parts, are more or less directly related to the securing of water, food, and air, and to the protection of the organism against possible injuries. When we examine the flower with a view to discovering its possible uses to the plant, we shall find very little indeed. On the contrary, we are likely to find the flower a source of expense to the plant, without any compensation whatever. It takes a great deal of material and a great deal of energy to build up a flower like that of the poppy or the lily; and so far as we can discover by experiment or observation, the flower does nothing that is of use to the plant. Are we therefore to conclude that the flower has no meaning in the life of the plant?

351. Structure of a flower. In most common flowers, such as wild roses or tulips, we find certain leaflike parts that are conspicuous because of their color. This set of conspicuous leaflike organs is commonly associated with a less prominent, cuplike arrangement of leafy structures, connected with the base of the flower and partly surrounding the bright leaves (Fig. 132).

Although the floral envelope is in most plants the first to attract people's attention, it is by no means the most important part of the flower. In order to understand the essential organs, we must consider them from the point of view of the function of the flower as a whole, which is the making of seeds.

352. The essential organs. In the center of the flower is a structure called the *pistil*, from its resemblance in many cases to the shape of a pestle (see *f*, Fig. 132).

Surrounding the pistil may be found a number of rather slender stalks, with knobs, or enlargements, on the ends (see *d*, Fig. 132). These structures are called *stamens*, from a word meaning "thready."

Flowers differ greatly in size and shape, as well as in color and odor. The various parts differ in many ways, but the pistil and stamen are always and everywhere the organs that have directly to do with seed-making; and their work is essentially the same in all flowers, no matter how varied they may be in form and arrangement.

353. The ovary. On cutting open the ovary of a flower we find that it is a hollow box, with a number of compartments in some species (see Fig. 133), containing from one to very many tiny rounded bodies that are normally destined to become seeds. These bodies are called *ovules*. As time goes on, these ovules enlarge, and the ovary also becomes larger. When the seeds are ripe, the ovary has become the fruit. But the changing of ovules into seeds is not simply a matter of growth. Every farmer and gardener knows that it is possible to have a good lot of flowers or blossoms with a very poor crop of fruit, although the conditions for the growth of the plants may be of the best, and although there may be no sign that there is anything diseased or out of order with the plants.

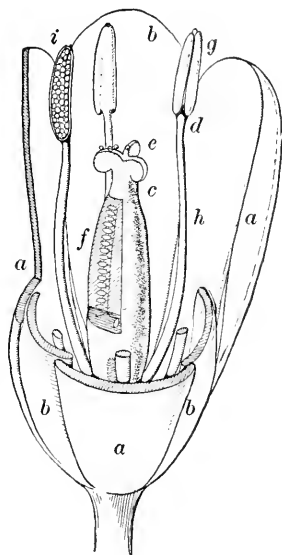

FIG. 132. Structure of a flower

The outer set of covering leaves, *a, a*, is called the *calyx*; the single parts are *sepals*. The inner layer, *b, b*, is the *corolla*; its parts are the *petals*. The central organ is the *pistil*; the main body of the pistil, *f*, is the *ovary* and contains one or many little structures (*ovules*) capable of becoming *seeds*. The tip, *e*, of the pistil is the *stigma*; this is connected with the ovary by the *style c*. Surrounding the pistil are a number of *stamens, d*, consisting of a stalk, *h*, called the *filament*, and an enlarged capsule, *g*, called the *anther*. This contains a mass of cells which can be thrown out, *i*; these loosened cells are called *pollen*

cells are called *pollen*

The inside of the ovule is a soft mass, made up of many compartments, or cells, containing the jellylike living matter, or protoplasm. One of these cells, usually near the center, is much larger than the others (see *es*, Fig. 134). Within this large cell, called the *embryo sac*, the protoplasm divides and grows, becoming a young plant, or embryo, inside the seed. The rest of the ovule becomes the coat, or covering, of the embryo.

354. Fertilization. Before the ovule can become a seed, certain changes must take place in the living matter of the

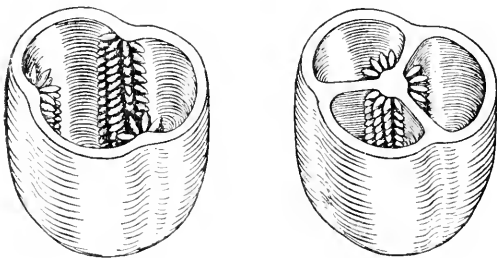

FIG. 133. Sections of ovaries

Ovaries are of many sizes and shapes. They contain but a single ovule in some species of plants, and in other species they bear hundreds. The ovules are definitely placed in one or more compartments of the ovary

embryo sac. A nucleus of the embryo sac must first unite with the nuclear substance of a pollen grain. The uniting of two nuclei is called *fertilization*. The method by which the two nuclei are brought together is shown in Fig. 134.

355. Seed and fruit. After fertilization the combined nucleus, containing protoplasm from two parents, divides into very many cells. The mass absorbs food in large quantities from the parent upon which it is borne, and becomes a baby plant, or *embryo* (see Fig. 120). The walls of the ovule, surrounding the embryo sac, become the seed covers. The ovule with its embryo sac thus changes into a seed. In addition to the food used in the growth of the embryo, the parent plant supplies other food materials that are accumulated either in a mass surrounding the embryo or within the tissues of the embryo itself. This surplus food may later be drawn upon by the young plant, after it sprouts and before it is able to maintain itself through the work of its own leaves and roots.

Fertilization also seems to induce changes in other parts of the flower. The petals drop off, and usually the stamens also. The ovary begins to enlarge, and eventually it ripens into the fruit.¹ In some plants the calyx of the flower, and even the receptacle, may become fused into the fleshy fruit.

We must be on our guard against thinking of the plant as an organism that looks ahead and supplies the later needs of its offspring. We may say merely that the plants behave in such a way that the later safety and development of their offspring are made more probable. The baby plant is protected by the mother, as well as nourished, in the sense that the early development takes place within the ovary, and in the sense that in many species hard or spiny coverings are formed which probably prevent injury.

¹ In most of the common plants the fruit will not ripen—that is, the ovary will not continue its development—unless fertilization takes place. But there are many plants in which a seedless fruit is possible. Seedless oranges, seedless apples, seedless grapes, the pineapple, and the banana are examples of fruits that develop without the ovule being first fertilized. The plantain and the breadfruit develop a more juicy fruit when there is no fertilization.

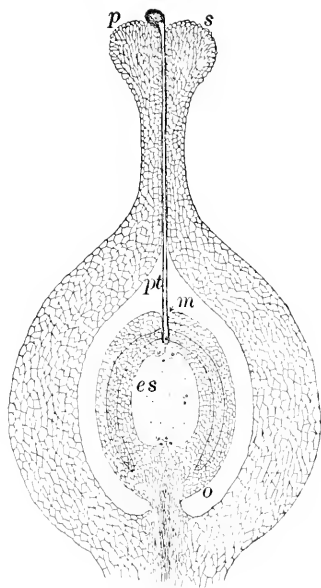

FIG. 134. Fertilization in a flower

When a pollen grain, *p*, alights on the moist surface of a stigma, *s*, it absorbs water and puts forth a thread of protoplasm, or a pollen tube, *pt*, which grows down the style into the ovary. The tip of the pollen tube finds its way to the inside of the ovule, *o*, through a small passageway, the micropyle, *m*. The large cell in the middle of the ovule, called the embryo sac, *es*, undergoes a number of changes which result in producing several nuclei. One of these nuclei at the end nearest the micropyle corresponds to an egg cell. Similar divisions take place in the nucleus of the pollen grain, and one of the resulting nuclei corresponds to a sperm cell. The cell walls separating the pollen tube and the embryo sac dissolve, and the pollen nucleus unites with the egg nucleus. The newly formed joint nucleus, or fertilized egg, begins to divide. Thus it develops into a new plant, or embryo; the ovule becomes a seed; the ovary becomes a fruit

CHAPTER LVIII

POLLENATION

356. Function of pollination. We have learned that flowers are seed-producing structures, and that seed production takes place only after fertilization. But in seed plants (most of which

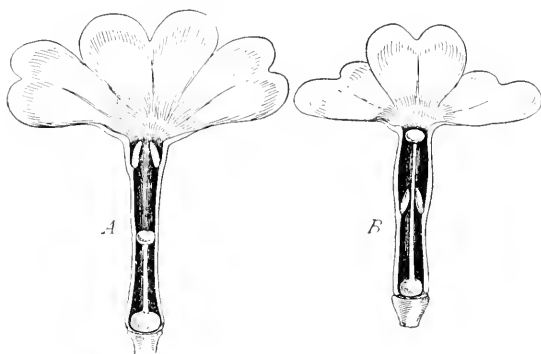

FIG. 135. Dimorphic flowers of Chinese primrose (*Primula*)

In these plants there are two forms of flowers (hence the term *dimorphic*). In form *A* the anthers are high and the stigma is low; in form *B* the anthers are low and the stigma is high. The pollen from form *A* is prepotent for the pistil of form *B*, and vice versa. That is, long-stamen pollen must reach long-style pistil, and short-stamen pollen must reach short-style pistil, to produce the best or the most seeds. This necessitates cross pollination, or at any rate handicaps close pollination

are land plants) the parts of the organism which bear gametes are so situated that fertilization is possible only after pollination; that is, the transfer of pollen from the anthers to the stigma. In these plants reproduction depends in a rather peculiar way upon certain external factors.

357. Self-pollination. In many plants the transfer of pollen is brought about by the growth movements of the parts of the flower. The style, in elongating, may bring the stigma into contact with the anthers; a movement of the corolla may push the stamen against the stigma; the stalk of the flower

may bend as it grows, dumping some of the pollen from the anthers onto the stigma. In other cases the anthers are

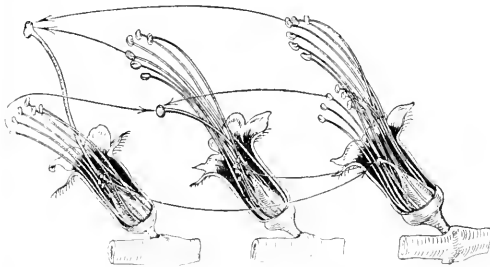

FIG. 136. Polymorphic flowers of purple loosestrife (*Lythrum*)

In species having three forms of flowers the best seed-production seems to result from the pollination of a pistil by pollen from a stamen of the corresponding length, which must necessarily be from a different flower. (After Darwin)

placed above the stigma, so that the pollen is brought to the latter organ by the action of gravity.

There are many plants in which the stigma regularly pushes through the ring of anthers and thus becomes pollinated. In other plants this kind of pollination takes place only under

special conditions, as in extreme dampness or extreme drought.

358. Close pollination and cross pollination. Any process that results in the transfer of pollen from the anther of a flower to the stigma of the same flower is called *close pollination*. This designation is used to distinguish the process from *cross pollination*, in which pollen is carried from the anther of one flower to the stigma of *another* flower (of the same kind, however). There are many plants in which close pollination is impossible.

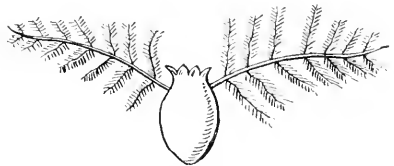

FIG. 137. Stigma of a grass

In wind-pollinated plants the stigmas usually expose a large surface to the wind

359. Obstacles to close pollination. There are three sets of conditions in plants that interfere with close pollination.

1. *Space relations.* The relative position of stamens and pistils within the flower may make close pollination impossible. Or the

stamens may be in one flower and the pistils in a different flower, either on the same plant or on a different one.

Some common *monocious* plants (that is, plants having the staminate and the pistillate flowers on the same individual) are birch, hazel, chestnut, oak, walnut, hickory, squash, maize, and the cone-bearing trees.

Some common *diocious* plants are poplar, willow, box elder, tape-grass (*Vallisneria*), begonia, saffrafr, and virgin's bower.

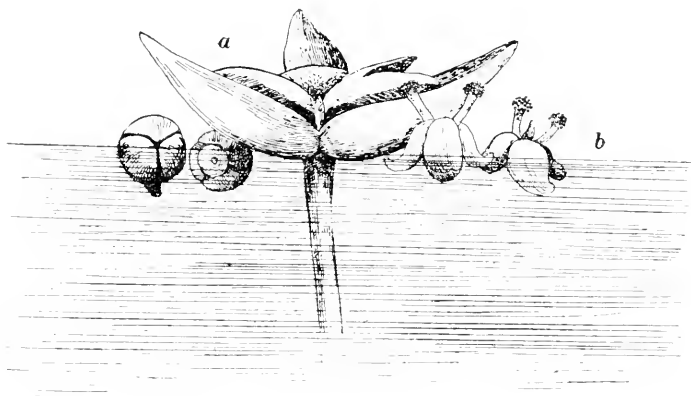

FIG. 138. Pollination by water

The tape-grass (*Vallisneria*) is a dioecious water plant. The pistillate individual grows up to the surface of the water, where the flowers, *a*, are opened, while the staminate individual remains beneath the surface. The staminate flowers, *b*, are detached from the stalks and rise to the surface, where they float about and gather in large numbers in the quiet stretches of water close to solid objects of various kinds. When one of these floating stamen flowers comes close to the pistillate flower of the species, the anther is brought into direct contact with the stigma, and thus pollination is effected

2. *Time relations.* The stamens and stigmas of some species of plants do not ripen at the same time, close pollination being thus impossible in these species.

The pollen ripens before the stigma in maize, in the mallows, in many species of the aster family, in the creeping crowfoot, and in the sage.

The stigmas ripen ahead of the stamens in the common plantain, in the potentilla, or cinquefoil, and in the oriental grass known as Job's tears.

3. *Physiological relations.* In some species of plants it is found that when the pollen is placed on the stigma of the same flower, it will either not germinate at all or it will lead, on the whole, to poorer seeds than those produced by means of pollen taken from another flower. This physiological difference in favor of outside pollen is called *prepotency*, and was demonstrated by Darwin in several species of plants.

Prepotency is commonly associated with the presence of two or three lengths of styles and of filaments.

In the flax, cow-slip, Chinese primrose, bluet, and other species there are two forms (Fig. 135).

In the purple loosestrife (*Lythrum salicaria*) and in certain species of *Oxalis* (related to our sorrel)

there are three lengths of stamens and three lengths of pistils (in different flowers) corresponding to them (see Fig. 136).

In buckwheat, in most orchids, in certain species of day lily, and in certain species of the bean family the pollen will not germinate at all on the stigma of the same flower.

There are, then, many species of plants in which close pollination cannot take place, or in which it is not very effective if it does take place. How, then, do these plants produce seeds, or, rather, how do they secure pollination? In other words, how is pollen carried from flower to flower?

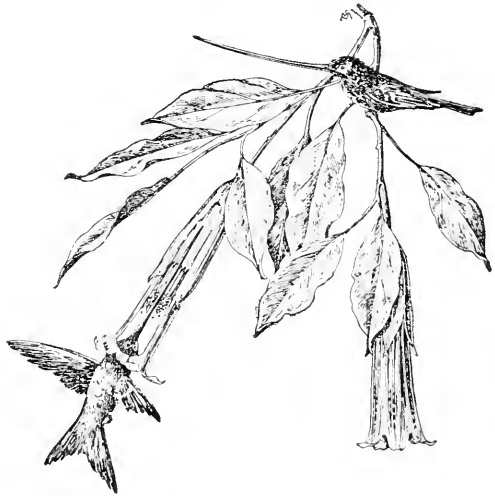

FIG. 139. Pollination by birds

Saber-billed humming bird pollinating flower with trumpet-shaped corolla. (From exhibit in American Museum of Natural History, New York)

360. Wind pollination. The most common moving agency that is able to act between plant and plant is the wind. The abundance and the dryness of the pollen produced by many of the common trees, and the frequency with which pollen may be found in the dust at certain seasons of the year, would lead us to suspect that the wind is an effective agent in this matter (see Fig. 137). A study of conditions on farms that produce corn, wheat, oats, and other grains shows that these plants, as well as many others, depend entirely upon the wind for their pollination. Indeed, it is sometimes necessary to take special precautions to prevent the wind from bringing to a group of plants an undesirable kind of pollen from a remote field.

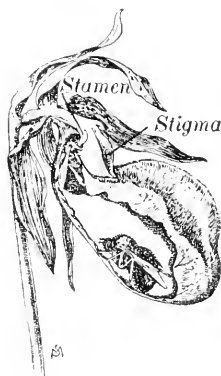

FIG. 140. Pollination by insects

In the lady's slipper and in many other flowers, insects alighting on the corolla crawl into the interior, guided by the form and the markings. In many flowers the arrangement of the parts is such that the insect must brush against the stigma in going in, and against the anthers in passing out. As a result the animal carries pollen from flower to flower. Many species of plants, especially among the orchids, depend upon single species of insects for their pollination

361. Water pollination. Another agent that is effective in distributing pollen for plants is water. This, of course, is confined to plants that live in the water.

A good example of pollen transfer by water is furnished by the tape-grass (*Vallisneria*), which lives near the edges of ponds (see Fig. 138).

362. Bird pollination. Next to the wind, the most common moving agents that go from flower to flower are flying animals and birds and insects. Now we know that not all birds or all insects can serve plants as pollen carriers; only those that regularly visit flowers can be considered of importance in this connection. Certain humming birds that visit flowers lap up the sugary fluid, or

nectar (see Fig. 139), and rub off some of the pollen in one flower, and when they visit another flower this pollen comes off onto the stigma.

Certain tropical flowers are said to be pollinated by bats that come to them for nectar.

363. Insect pollination. There are hundreds of species of plants whose flowers are pollinated by insects, chiefly bees and wasps of the bee order, and certain moths and butterflies. All of these insects have sucking mouths, and they all visit flowers that contain nectar. Some of these insects also use pollen as food. The bees, for example, carry away quantities of pollen, which they feed to the young in the hives. In gathering the pollen or in sucking the nectar the insects rub off pollen on various parts of their bodies, and then transfer this pollen to the stigmas when they visit other flowers of the same kind (see Fig. 140).

CHAPTER LIX

ADAPTATIONS OF FLOWERS

364. Colors and odors. In many species of plants the colors and odors of the flowers are no doubt of value to the plants as furnishing aids to insect visits, and thus to the process of pollination. It is a mistake, however, to suppose either that all colors and odors are of value to the plants in this way or that there is any necessary connection between the existence of these colors in the flowers and the habits of the insects. There are many plants that have colored corollas and that do not depend upon insects at all. And there are other plants that receive the visits of insects without being particularly conspicuous.

365. Nectar. While many insects will visit plants for the nectar, there are many plants that produce nectar in positions that make it impossible for the visits of insects to be of any use to the plants. Indeed, there are certain ferns and some seed plants that produce nectar on the stems or leaves, so that the plants get no benefit whatever from the visits of insects to these nectaries.

366. Fitness. We are not to suppose that the plants produce these queer shapes in their flowers, or the colors or odors, for the special *purpose* of attracting insects. Nor are we to suppose that the insects visit the flowers for the *purpose* of carrying pollen, or for any other *purpose*. Bees will fly toward nectar or honey, houseflies will fly toward manure or decaying fish, moths will fly toward a light, not because they have the idea of getting something they want, but because they are built in a certain way.

It is interesting to note in this connection that while insects cannot distinguish objects at any great distance, — say at more than about

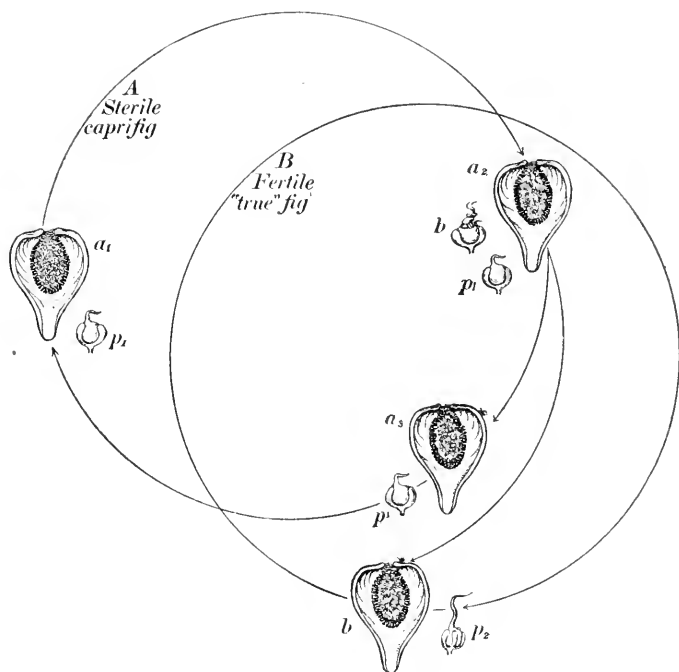

FIG. 141. Diagram of pollination in the fig

The larva of the little wasp *Blastophaga* passes the winter in the sterile pistil, p_1 , of the winter fruit, a_1 , of the caprifig, *A*. In the spring the adults appear, the wingless male first. After fertilizing the female, the male dies. The female flies out and crawls into the new figs which are just forming, a_2 , and loses her wings in the process. This fig carries both stamen flowers and pistil flowers, but the latter have short styles and can bear no seeds. The insect lays her eggs in these sterile pistils, and the young complete their development here. When the new generation of females flies out, there is a new growth of fig buds on the caprifig, a_3 , and also on the true fig, b on *B*. Some of the females find their way into the caprifig receptacles, and some into the fertile-fig receptacles, carrying with them pollen from the spring receptacle of the caprifig, a_2 . The pistils of the true fig have long styles, p_2 , which can be pollinated. The styles are so long, however, that the insect cannot lay her eggs on the ovary. On the other hand, the pollen brought into the receptacle of the caprifig, a_3 , is entirely wasted, since the pistils here are sterile. A new generation of insects develops in this receptacle, and the emerging females find their way into the autumn growth of new figs, in which the winter is spent. The true figs can thus produce fully ripened fruit only in the presence of the caprifig and of the wasp. But the wasp can complete its life cycle with the caprifig alone. The insects that carry pollen (from a_2) either waste this pollen and reproduce themselves (in a_3) or they pollenate pistils and die without reproducing themselves (in b)

two to three yards,—they will nevertheless visit only one kind of flower in the course of a day, or even for many days running. Thus, if a bee starts out in the morning by visiting a red clover, it will visit only red clovers for the rest of the day, or as long as any red clovers are to be had.

367. The interdependence between flowers and insects. In some cases the relation between a seed plant and some insect is so close that it affects the practice of plant raisers.

When fig trees were first introduced into California, they produced large, juicy fruit, even without pollination. But, the fruits thus produced are not as satisfactory for commercial purposes as the others: they do not dry properly, and so cannot be prepared for shipping or for preservation. To get the normal fruit it was necessary to find the insect that regularly brings about pollination. This little wasp, the *Blastophaga*, has a curious life history which is closely adapted to the flowering habits of the fig tree. On the other hand, thousands of fig pistils supply breeding places for wasps without ever producing seeds (see Fig. 141). Thus the insect and the fig tree are of great value to one another, although it is difficult to see what advantage either species has in its dependence upon the other. It is quite impossible for us, at present, to imagine how this relationship came to be established in the course of time.

There are many cases of plants that have been transferred from one region of the earth to another, and then failed to bear seeds because of the absence of the suitable insect.

When vanilla was transplanted from Mexico and South America to various islands in the Indian Ocean and elsewhere, the plants grew luxuriantly, but produced no fruit, although flowers were produced in abundance. Since the plant was raised for the "beans" or pods, there was no profit in the business so long as the fruit failed to develop. It was found that the failure was due to the absence of pollination, which is brought about in the native regions by certain insects.

Instead of importing the insects to carry on pollination, it was decided to hire women and children to go from flower to flower and pollenate by hand (see Fig. 142).

In our regular horticulture it happens occasionally that trees or bushes in full blossom fail to yield the expected crop of fruit because of the lack of insects to insure pollination. This is why wise farmers and orchardmen so often maintain hives of bees in the neighborhood of their fields or orchards. Even where the honey is not worth getting, the bees are worth having because they insure abundant pollination at the right time.

368. Advantage of insect pollination doubtful.

In a general way the lower families of seed plants are wind-pollinated, and the higher families are insect-pollinated. But it must not be supposed that there is any real advantage to plants in depending upon insects to carry their pollen. In

many cases we may see that there is an actual saving of pollen. On the other hand, many species of plants, especially among the orchids, are so dependent upon the insect visits that they are dying

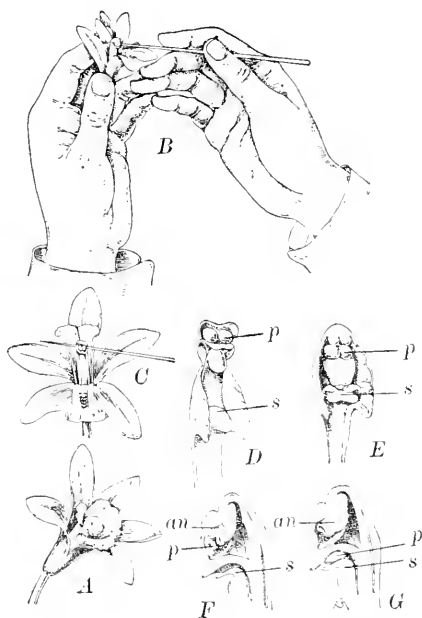

FIG. 142. Hand-pollination in the vanilla flower

In the orchids the stamens are fused with the stigma, placing the anthers above the stigma in such a way as to make self-pollination absolutely impossible. *an*, anther; *f*, pollen masses; *s*, stigma. *A*, general view of flower; *B*, position of hands and needle in artificial pollination; *C*, needle lifting pollen masses; *D*, anther raised to expose pollen masses; *E*, style raised to show opening in stigma; *F*, longitudinal section to show relative positions of anther and stigma; *G*, longitudinal section after pollination, showing pollen masses in the stigma. All the vanilla beans in the Seychelles

Islands are grown with hand pollination

out just because of the inability to produce sufficient seed to replace the old individuals, the suitable insects not being numerous enough. In general, the plants that are most decidedly dependent upon the wind for their pollination seem to be at least as successful as those that are dependent upon insects. Thus, the grasses and the common catkin-bearing trees and the cone-bearing trees are widely distributed over the surface of the earth, and none of the insect-pollinated plants seem to have any decided advantage over them.

The insects that are able to get food from highly specialized flowers, because of their peculiar instincts or structure, may seem to have some advantage over insects that cannot make use of those particular flowers. Nevertheless we find it extremely difficult to understand what advantage a species may derive from such extreme adaptation, since such dependence often leads to complete extermination (as in the case of *Blastophaga* in the absence of fig trees), and in any case means paying a high price for benefits received.

CHAPTER LX

FRUIT AND SEED DISTRIBUTION

369. Seed as forerunner. We have studied seeds as arising from the ovules in flowers (pp. 300-303), and we have studied them as consisting of young plants with more or less accumulated food and a covering (pp. 32-36). We can realize the full meaning of seeds in plant life when we consider that during the winter the fields are bare and thousands of plants have entirely perished, leaving behind them the seeds as the only living remains. It is these seeds that represent the species of all the annuals during the months in which active plant life is impossible. And it is from the seeds that these species will be reestablished the following season when the conditions for growth are again favorable.

From the point of view of the seed as the forerunner of the new generation, the fruit may be considered in relation to the protection and the dispersal of seeds, since the fruit is the organ within which the seed ripens.

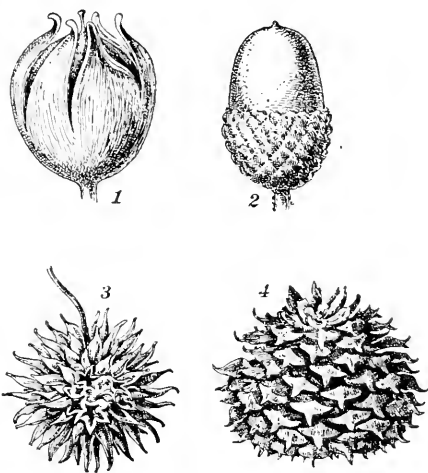

FIG. 143. Mechanical protection of seeds

- 1, bitternut (*Hicoria minima*), of the walnut family;
2, chestnut oak (*Quercus prinus*); 3, sweet gum
(*Liquidambar styraciflua*), of the witch-hazel family;
4, table-mountain pine (*Pinus pungens*)

370. Protection of seed. As living things seeds are exposed to destruction by other plants or by animals and to injury by inorganic factors of the environment, as excessive low temperature and excessive moisture or drought. We find many fruits covered with spines; others have hard or tough coverings or shells; still others contain bitter or acrid substances.

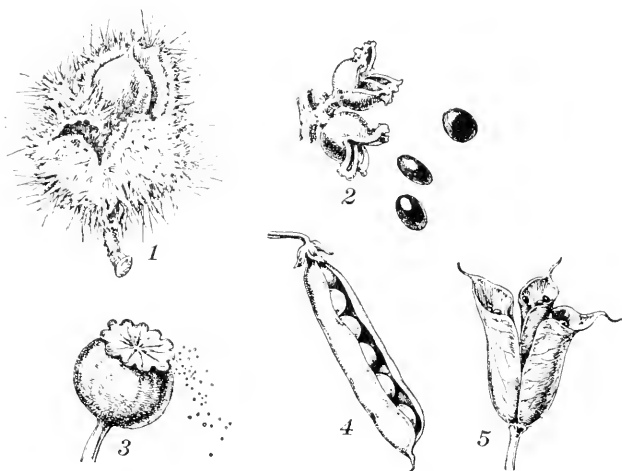

FIG. 144. Dehiscent fruit

seeds are scattered by the opening of the fruit in a definite way. 1. chestnut; 2, witch hazel; 3, poppy; 4, pea; 5, monkshood

Seeds that become separated from the fruit are frequently tough-skinned or covered with some other protective layers (see Figs. 7 and 143).

371. Escape of seeds. The seed attached to the parent plant and surrounded by other structures is of no significance in the life of the species. To be in a position to perform its functions, the seed must *get out* and *get away*—and the farther away the better, in most cases.

Many common seeds escape from the parent plant through the splitting open of the ripe fruit along definite lines or by

the appearance of holes. The pods of the bean family and of the evening-primrose family illustrate this dehiscence, and the poppy is a good example of the formation of pores.

Fleshy fruits often drop off, carrying the seeds with them, and the seed escapes when the fleshy part of the fruit is eaten by some animal or rots (that is, is eaten by some plant).

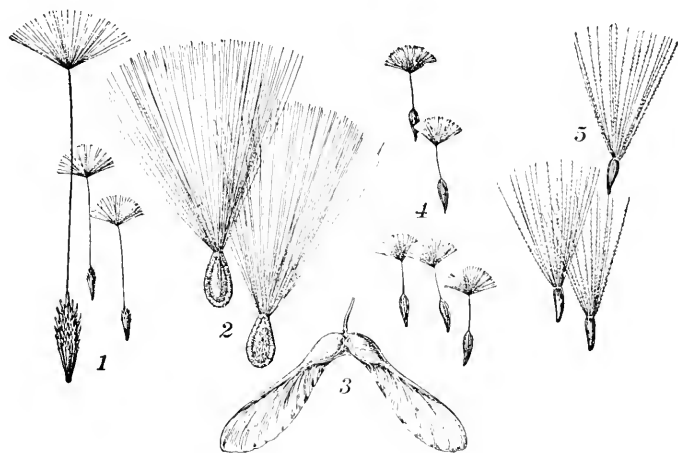

FIG. 145. Seeds scattered by the wind

1, dandelion : 2, milkweed : 3, white maple : 4, prickly lettuce : 5, thistle

Many fruits, however, do not permit the seeds to escape; the fruit and the seed are so closely united that they constitute a structure that acts as a whole — as in the grains, the nuts, and the nutlets of the dandelion family (Fig. 145, 1, 4, and 5).

372. Seed distribution. In their dehiscence many fruits open so suddenly that they shoot the seeds to a distance of a yard or more. This shooting is commonly brought about by the rapid twisting of the parts of the pod, as in the touch-me-not and the lupine (see Fig. 144).

Most plants depend upon outside agencies to scatter their seeds for them. The wind is active in the case of species whose seeds are either very small (the orchids) or have

expansions in the form of wings or tufts of hair that furnish a large area in contact with the air (see Fig. 145).

Fruits that have hooks, as the cocklebur and beggar-ticks, attach themselves to the fur of passing animals and are carried considerable distances from the parent plant (see Fig. 146).

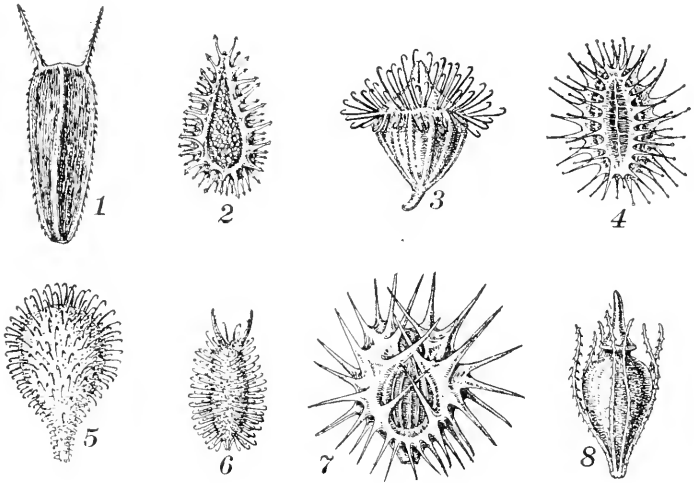

FIG. 146. Fruits scattered by passing animals

1, beggar-ticks, or bur marigold (*Bidens frondosa*); 2, burdock (*Lappula echinata*); 3, small-flowered agrimony (*Agrimonia parviflora*); 4, carrot (*Daucus carota*); 5, enchanter's nightshade (*Circaea lutetiana*); 6, cocklebur (*Xanthium canadensis*); 7, bur grass (*Cenchrus tribuloides*); 8, spike rush (*Eleocharis ovata*). (1, 4, 8, enlarged; 2, 6, reduced)

Seeds that are inclosed in edible fruits are often distributed by being eaten by animals and then discharged from the intestines without having suffered any injury. Cherries, blackberries, and other small fruits are commonly distributed by blackbirds, robins, thrushes, and other birds (see Fig. 147).

From the point of view of the species, there are three factors in seed dispersal that are of fundamental importance: (1) the number of seeds that are scattered; (2) the distance to which they are carried; and (3) the final lodgment in a place favorable to germination and later growth and development.

It is obvious that the more seeds there are scattered, the better are the chances that enough of them will find suitable lodgment to replace the individuals that die each year. On the other hand, to produce excessive seeds would be wasteful, and might under

some circumstances neutralize the advantage of numbers. Thus the orchids, producing relatively many seeds, lose many; only a very small proportion of them ever develop into new plants. On the whole, the plants that depend upon the wind to scatter their seeds seem to maintain themselves and to invade

new regions more successfully than those that depend upon other agencies for scattering the new plants.

Many plants have their seeds distributed by currents of water, — streams of various sizes, or ocean currents, or wind currents acting on the water. Seed plants that grow in swamps or ponds are commonly dependent upon water currents for the dispersal of their seeds. But it seems that many seeds are also spoiled by the water. The coconut, for example, which is often cited as a plant that invades ocean islands by being carried over the sea, is really killed by the salt water.

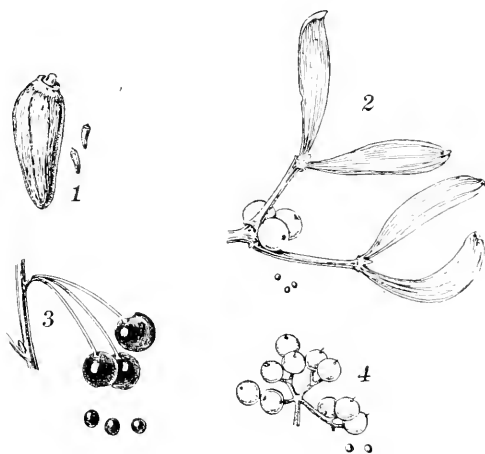

FIG. 147. Seeds scattered by birds

Birds eat the fruit and discharge the indigestible seeds. 1, thistle; 2, mistletoe; 3, bird cherry; 4, red-osier dogwood

CHAPTER LXI

ALTERNATION OF GENERATIONS

373. Life history of a moss. In the moss plants, the individuals that we ordinarily have in mind when we speak of *moss* bear at the end of a leafy stem a group of sexual organs. Some individuals carry egg-producing organs; others bear sperm-producing organs (see Fig. 148).

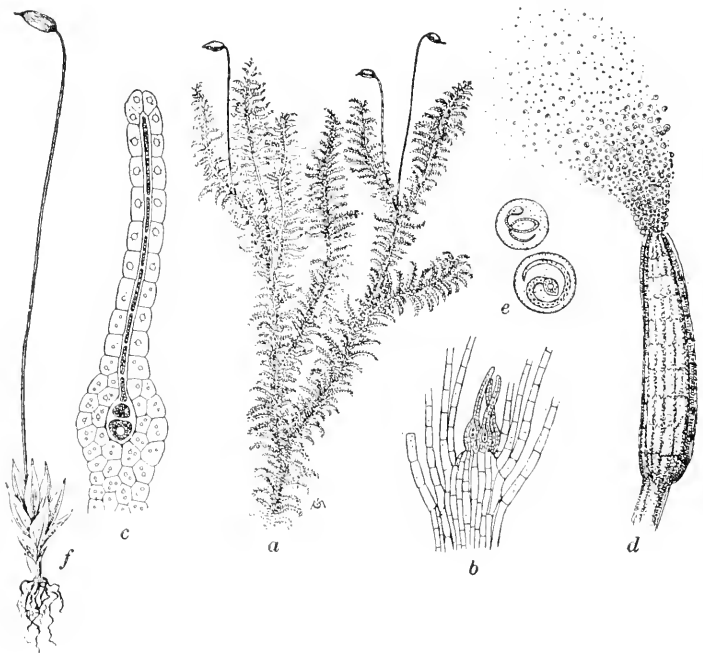

FIG. 148. Reproduction in moss

a, a leafy moss plant (*Hynum molluscum*); *b*, section cut lengthwise through tip of one of the branches, showing position of *archegonia*, or egg-bearing organs; *c*, single *archegonium*, more highly magnified, showing single large egg cell; *d*, enlarged view of *antheridium*, or sperm-bearing organ, of *Polytrichum formosum*, discharging sperm cells; *e*, greatly magnified view of sperm cells; *f*, tip of leafy plant from the archegonium of which a spore plant has grown, showing stalk and spore capsule

When the moss is covered over with water, it is possible for the male gametes to swim about, and some of them find their way into the archegonium. Here one of the sperm cells fuses with the egg cell, and the fertilized egg cell begins to develop into a new moss plant immediately — that is, while still within the body of the parent.

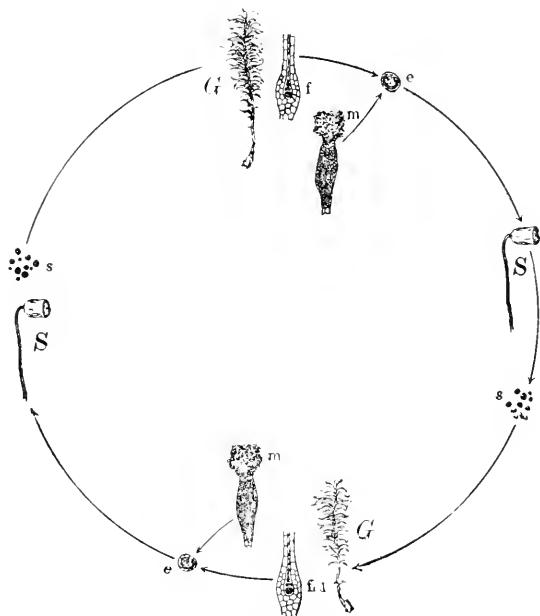

FIG. 149. Alternation of generations in the life history of the moss

G, the gametophyte, or gamete-bearing plant; *f*, the female gamete organ; *m*, the male gamete organ; *e*, the fertilized egg resulting from the fusion of egg and sperm; *S*, the sporophyte, or spore-bearing plant; *s*, spores. The spore always develops into a gametophyte; the gametes (egg) always give rise to a sporophyte. *G* and *S* represent alternate generations that reproduce in different ways, — the first sexually, by means of gametes, the second asexually, by means of spores

But the new plant is very different from the parent plants. It has no leaflike organs or anything to correspond to leaves. It consists mainly of stalk, and at its base it is buried in the tissues of the parent plant, from which it gets most of its nourishment. It is therefore parasitic upon the parent to a large extent. At the end of the stalk a capsule is formed, and when this is ripe, a great many *spores* are

thrown out of the opened top. When one of these spores alights upon a moist spot, it absorbs water, and the protoplasm breaks out on one side; it then proceeds to develop into the next generation.

Here again we must notice that the new plant developed from the spore is not at all like the parent plant; that is, the plant which

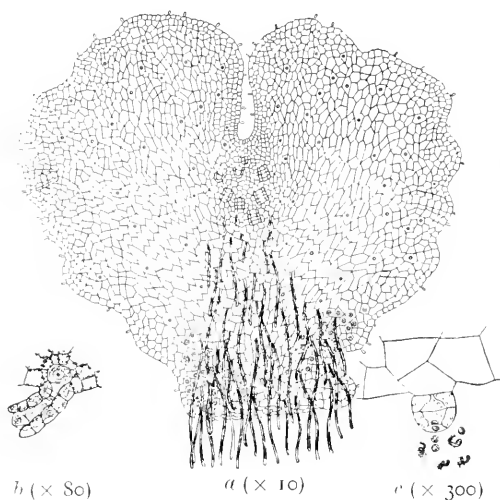

FIG. 150. Reproduction in fern

The gamete-bearing plant, *a*, of the fern, called a *prothallus*, is a flat plate of cells, with hairlike roots on the undersurface. Flask-shaped organs, *b*, each bearing a single egg cell, are embedded on the undersurface, near the notch, with the mouth pointing downward and backward. Near the small end of the prothallus, on the undersurface, are the organs, *c*, bearing the male gametes. These are discharged into the water, and swim about freely, finding their way into the egg organ, where fertilization takes place

produced the spores. At first there is a very delicate, green, branching thread, resembling some of the green algæ found in water. In a short time a clump of cells, or a bud, appears at some point along this branching thread, and from this develops the leafy stalk that we recognize as moss, and some colorless, hairlike threads that look very much like root hairs.

The leafy moss plant, bearing gamete organs at the top, is called a *gametophyte*, which means a gamete plant. The leafless plant, consisting of stalk and capsule, together with the attachment to the parent, is called the *sporophyte*; that is, spore plant. By following the history of a number of generations of moss we may see that there is a regular alternation of gametophyte and sporophyte. This is illustrated in the diagram (Fig. 149).

374. Life history of a fern. In the ferns the spores are produced on the underside of the leaves (see Fig. 127, p. 294). The spore gives rise to a little plate of chlorophyll-bearing cells, sometimes no larger

The leafy moss plant, bearing gamete organs at the top, is called a *gametophyte*, which means a gamete plant. The leafless plant, consisting of stalk and capsule, together with the attachment to the parent, is called the *sporophyte*; that is, spore plant. By following the history of a number of generations of moss we may see that there is a regular alternation of gametophyte and sporophyte. This is illustrated in the diagram (Fig. 149).

than the nail of your little finger, called a *prothallus* (see Fig. 150). Prothalli are often found growing on flowerpots in greenhouses.

The prothallus corresponds to the gametophyte of the moss, while the plant which is familiar to us as the fern is a sporophyte. The

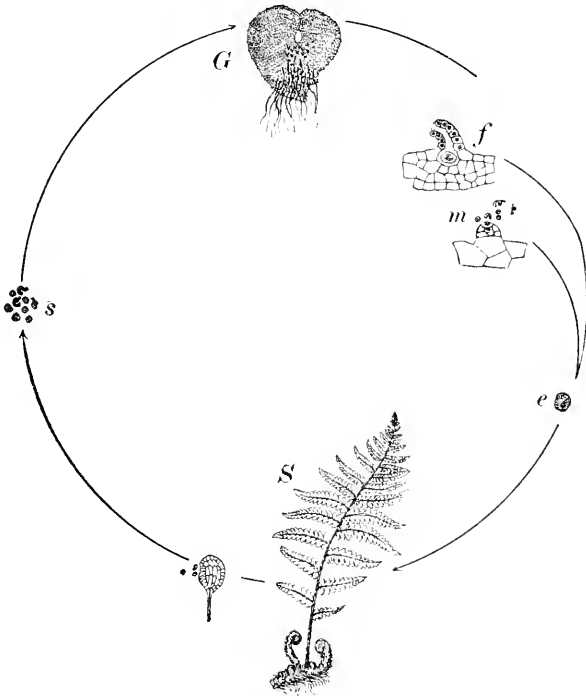

FIG. 151. Alternation of generations in the life history of the fern

G. the gametophyte, or gamete-bearing plant : *f.* the female gamete organ : *m.* the male gamete organ : *e.* the fertilized egg. *S.* the sporophyte, or spore-bearing plant : *s.* the spores discharged by the spore-bearing organ. The spore develops into a gametophyte: the gametes (egg) always give rise to a sporophyte. The alternate generations reproduce in different ways,—one by means of gametes, or sexually, the other by means of spores, or asexually

spore always gives rise to a prothallus, which bears gametes. When fertilization has taken place, the zygote formed develops not into another prothallus but into a sporophyte. The diagram in Fig. 151 shows us the alternation of generations in this group of plants.

In some plants related to the ferns the two kinds of gametes are borne on two different individuals; that is, each individual gametophyte is either male or female. In such species each spore therefore gives rise either to a male plant or to a female plant, as is the case with the moss. It is impossible in such cases to find any difference between the spores that give rise to male plants and the spores that develop into female plants.

375. Heterospory. But there are other plants related to the ferns in which two different kinds of spores are produced, — a large spore and a small spore. In such species the large spore always develops

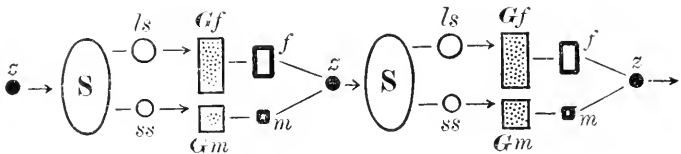

FIG. 152. Heterospory

Plants producing spores of two sizes, *ls* and *ss*, give rise to two distinct forms of sexual, or gamete-bearing, individuals, female and male, *Gf* and *Gm*. The gametes, *f* and *m*, unite to form the zygote, *z*, which develops into the spore-bearing plant, *S*. There is an alternation between the sexual (gametophyte) and the asexual (sporophyte) generation; and there is a differentiation between male and female gametophytes, and, finally, a differentiation between two types of spores. The next step would be to have two kinds of sporophytes, *S*, one bearing large spores and the other bearing small spores; and, indeed, there are plants in which this condition is found

into a female gametophyte, while the small spore always develops into a male gametophyte. There are thus two kinds of spores as well as two kinds of gametes (see Fig. 152).

376. Alternation of generations in seed plants. The pollen grain corresponds to a small spore; that is, one that gives rise to a male gametophyte. In the ovule is a large spore which becomes the embryo sac, or female gametophyte. In seed plants the small spore is scattered, as in ferns and mosses; but the large spore remains in the spore case — the ovule. The male gametophyte is a very much simpler organism than we have found in mosses or ferns; it is, in fact, the simple pollen tube. It is incapable of nourishing itself, but lives in part on the nourishment stored up in the pollen grain and in part on material absorbed from the stigma. By the division of the nucleus, male gametes are formed.

The female gametophyte is still further simplified, for it never gets outside of the spore. It is nourished altogether by the parent plant, and its activities are confined to the dividing up of the nucleus, finally separating the portion of nucleus that is to act as the female gamete.

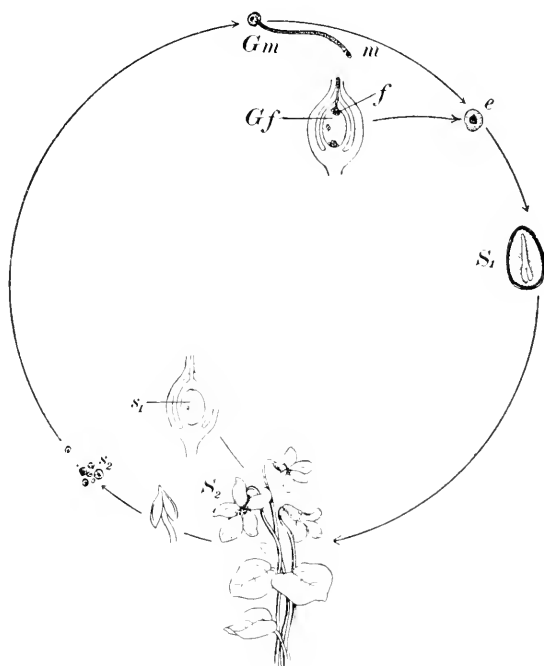

FIG. 153. Alternation of generations in seed-bearing plants

Gm, the male gametophyte, or pollen tube; *m*, the male gamete, a nucleus at end of pollen tube; *Gf*, the female gametophyte, or embryo sac; *f*, the female gamete, a nucleus in the embryo sac; *e*, the fertilized egg, in embryo sac; *S*₁, young sporophyte, the embryo in the seed; *S*₂, the mature sporophyte, a flower-bearing plant; *s*₁, the large spore, giving rise to the female gametophyte, or the embryo sac. *s*₂, the small spores, or pollen grains, giving rise to the male gametophyte. The spores always give rise to gametophytes, and the gametes (producing a fertilized egg) always give rise to sporophytes. Sporophytes alternate with gametophytes, generation after generation

Our common seed plants are accordingly seen to be *sporophytes*, or spore-bearing plants. The alternation of generations of these plants is illustrated by the diagram in Fig. 153.

377. Alternation of generations among animals. Among some of the animals related to the sea anemone and hydra there is found a fairly regular alternation between generations that reproduce sexually — that is, by means of gametes — and generations that reproduce asexually. Good examples of this alternation are furnished by jellyfish found in the ocean off

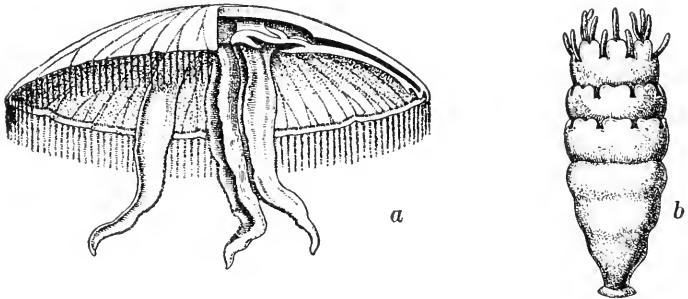

FIG. 154. The jellyfish aurelia

The mature medusa, *a*, reproduces sexually, the gametes being thrown into the water, where fertilization takes place. The egg develops into an individual having the general form of a hydra, *b*, and attaches itself to a rock. The animal elongates and breaks up into a number of individuals by means of constrictions, so that it comes to resemble a pile of bowls. Each individual, when separated, turns over and swims away, changing into a medusa, *a*

our coasts (see Figs. 154 and 155). The complete life history includes both kinds of individuals, male and female, and two kinds of generations, sexual and asexual.

Alternation of generations is also found in many parasitic animals, especially parasites that inhabit two or more different hosts at different stages in their development. Thus, the malarial parasite reproduces in the blood of human beings by *sporulation*; that is, by the formation of a large number of spores. But in the body of the mosquito there are produced tiny protoplasmic structures that unite in pairs; that is, they conjugate. There is thus present a sexual method of reproduction and an asexual method, and these alternate regularly so long as the organism has the opportunity to pass from one host (man) to the other (mosquito) and back again (see pp. 403-407 and Fig. 209).

CHAPTER LXII

REPRODUCTION IN ANIMALS

378. Aquatic invertebrates. Among the invertebrate animals — that is, those having no backbone — living in the water, such as sponges, corals, starfish, clams, and crayfish, fertilization usually takes place outside the body of the parent. In the cases of many, however, the developing egg cell may be protected by some portion of the mother's body, as when the young hatch in the mantle cavity of the clam.

379. Reproduction in fishes. Among the fishes, the female gametes are usually deposited in quiet places at the bottom of the sea, near shore, or in quiet pools of rivers. Then the male fish swims over the eggs, dropping out a quantity of fluid containing the sperm cells. These swim about in the water, fertilization taking place in much the same way as in the rock-weed (see p. 299). The fluid containing the sperms is called *milt*, or *semen*. A sperm cell of a fish is illustrated in Fig. 156, 7. As soon as the nucleus of the egg has fused with the nucleus of the male gamete, the combined nucleus begins to divide, and thus the development of a new fish is started.

The female gamete of the fish contains a small amount of food material in addition to the protoplasm. While the development is under way the young fish lives on this accumulated food. In some species of fish the adults swim about in the neighborhood of the developing fry and protect them against possible destruction by other fish. In most species, however, the sperm and eggs are thrown out by the adult males and females, and then left to themselves. Thus exposed, thousands of eggs are destroyed before they have a chance to develop into fish. Of course, thousands are also destroyed in the case

of those species that protect their young; but it is not probable that in these species so large a proportion are lost.

380. Water essential to gametes. As we have seen, sexual reproduction is possible only on condition that two gametes of opposite sex combine. In addition to producing the gametes, the bringing of them together is another problem of life.

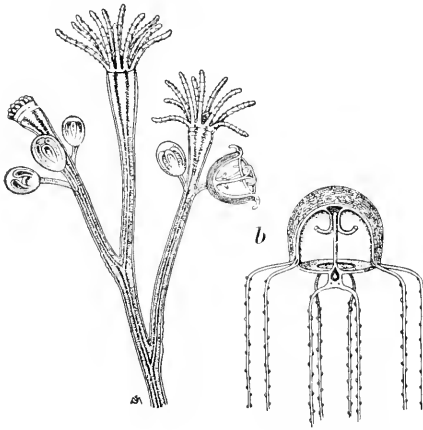

FIG. 155. Hydromedusa (*Bougainvillea ramosa*)

a, enlarged view of portion of colony, showing feeding individuals and reproduction individuals. New individuals are here produced asexually, by budding. *b*, the medusa stage, which originates as a bud on the hydra colony and reproduces by means of gametes thrown into the water

Moreover, the sperm and egg cells (gametes) are unlike spore cells in that they are quite incapable of resisting drought; drying kills them very quickly. It is therefore another condition of reproduction that the gametes be protected against drying up. Among the animals and plants that live in the water, or where water may remain in contact with their reproductive organs, this is simple enough. But in organisms that live on land, or in the air, the older methods of bringing the gametes

together will no longer serve. We have seen how this condition is met in the case of the flowering plants. Among land animals there are special organs and modes of behavior that make fertilization possible.

381. Reproduction among batrachians. The frogs, which live on land and breathe air in their adult state, go to the edges of ponds and puddles at the breeding season. After the gametes are thrown into the water, fertilization takes place, and the adult frogs pay no further attention to them.

In some species of toads the fertilized eggs are placed in the mouth of the parent, where they are kept until the tadpoles are large enough to swim away. Among the batrachians, — which include newts and salamanders, as well as frogs and toads, — there are very many cases of parental care of the developing young, ranging all the way from abandonment directly

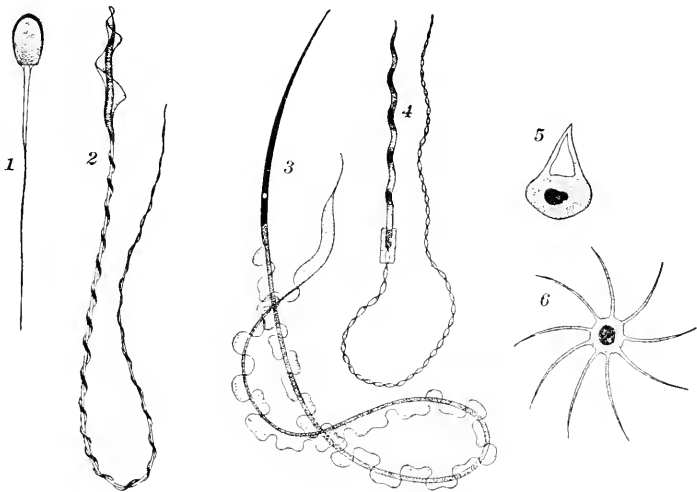

FIG. 156. Sperm cells of animals. (Very highly magnified)

1, pig; 2, bird; 3, salamander; 4, ray; 5, threadworm (*Ascaris*); 6, lobster

after the discharge of the gametes to guarding within the body of the mother until the young are fully formed and able to shift for themselves.

382. Reproduction in the insects. Among the insects, which of all animals are most distinctly adapted to living in the air, the spermatozoa of the male are passed directly into the body of the female through a special duct. The semen is discharged into a receptacle, from which the spermatozoa pass, a few at a time, into another space, wherein the female gametes (the eggs) are fertilized. It is possible for a queen bee to retain a quantity

of living sperms for two or three years, or even much longer, and to force these out of the receptacle from time to time as she produces new eggs. Even the insects that normally lay their eggs in the water — as the mosquitoes — have fertilization take place within the body of the mother.

383. Reproduction in vertebrates. Among all the backboned animals, above the amphibians, fertilization takes place within the body of the mother. The eggs begin to develop immediately after fertilization and are retained within the parent's body for a longer or a shorter period. Here they are not only protected against possible injury by enemies, but they are nourished and supplied with moisture and, in some cases, kept warm.

The degree to which the new organism is dependent upon the parent during the early stages in its development varies considerably. Among the reptiles — for example, some tortoises and alligators — the developing egg becomes enveloped in a mass of food material on its way out of the mother's body and is then supplied with a horny shell. The egg is then deposited in the sand, where it hatches under the heat of the sun. In certain lizards, however, the eggs hatch within the body of the mother, and the young leave her body fully formed.

Among the birds the fertilized egg becomes covered with a large quantity of food material (yolk and egg albumen), and the whole mass becomes surrounded by a limy shell. Nearly all birds protect their eggs, and they also supply the heat necessary for the hatching of the young.

Among the mammals the development of the egg takes place entirely within the body of the parent. The new organism is cared for not only until it leaves the body of the parent but for a comparatively long period after it is born. The length of this period varies almost directly with the level of the family of animals in the scale of development.

CHAPTER LXIII

INFANCY AND PARENTAL CARE

384. Infancy in lower plants. Among the one-celled plants or animals each cell resulting from a cell division begins to shift for itself immediately, as soon as it comes into existence as a distinct cell. The simplest organisms of any series are detached from their parents and shift for themselves early in life. As we go up the scale we find that more and more do the parents provide for the offspring in the way of food or protection or both.

Among the seaweeds, like bladder wrack and many other species, the gametes are thrown into the water, where thousands are destroyed for every pair that fertilize and establish a new individual.

In the mosses and ferns the female gametes are retained within the body of the parent plant until after fertilization, and until the new plant has been well started. In the mosses the new plant gets nearly all of its nourishment from the parent plant.

385. Infancy in seed plants. When we come to the highest plants, the adaptation of structure and behavior to the apparent advantage of the species is still greater. The spores are produced in comparatively small numbers and the gametes in still smaller numbers. The fertilized egg is completely protected by rather elaborate structures, and the young plant develops within the body of the parent until it is fairly well along — in most species until the root, stem, and leaves are quite distinguishable. In addition to the nourishment and protection, the parent also supplies a quantity of food that is available after the baby plant is separated from the parent. And in most species we find a

still further contribution of each generation to the next in the form of special structures or organs that assist the young plant in getting to some distance from the parent (see pp. 315-319).

386. Advantage of longer infancy to the species. In all these various directions the organisms expend energy in ways that enable the offspring to get a better start in life than would be possible if the spore or the gamete (or zygote) were discharged by the parent immediately upon being formed. On comparing the various groups of plants with respect to the amount of nourishment or protection that parents supply to the young, or with respect to any other services rendered by the parents to the young, we shall see that with the ascent of plant life from the lowest to the highest there is an increase of the dependence of the offspring upon the parent. And with the increase of service rendered by parents to offspring there is at the same time an increased advantage to the species.

An advance in the scale of life seems to impose additional burdens upon the organisms. But these are more than compensated by the additional advantages. As has already been pointed out, the production of flowers and fruits and seeds is a source of great expense in material and energy to the organism. Yet in any species of plants that produces well-stored seeds, well-protected seeds, and seeds well adapted to wide dispersal *every individual gets the full benefit of this additional expenditure of energy at the very beginning of his career.* We might even say that, apart from all other considerations, a plant comes to be able to do all of its life's work just in proportion as its parent has guarded its youth and has given it a good start. In doing things for posterity a plant is thus merely repaying to the species what was done for it in the past.

Of course we are not to suppose that the plants do this or that *because* they have any feeling of gratitude, or ability to foresee future needs. In speaking of the advantages or disadvantages of various types of behavior on the part of plants, we mean merely to point out that certain kinds of doings may actually contribute to the prosperity

of the species, whereas other kinds of doings would probably lead to the extinction of the species. Some plants behaved in a certain way in past ages, and their progeny to-day occupy the surface of the earth. Other plants behaved quite otherwise, and we know of them only by the traces they have left in the ancient rocks of the hills.



FIG. 157. The four-spined stickleback (*Apeltes quadracus*)

The adult fish swims about and through the nest, guarding the eggs while they are hatching

387. Infancy among animals. When we study the prolongation of infancy among animals, we find that the advantages of a protected and cherished youth are even more marked there than they are among plants.

Among most of the lower animals the mother lays large numbers of eggs — in the water, on leaves, in the soil — and abandons them. But toward the upper end of many series of

animals we find that much more is supplied for the young. The lobster and crayfish mothers carry the eggs about on their abdominal legs, or swimmerets, and even the young embryos until they are able to care for themselves. Among the insects there are some that abandon their eggs as soon as laid, whereas others provide shelter and food for the young.



FIG. 158. Wallaby and young

The babies are not only protected and kept warm in the *marsupium*, or pouch, but are also nourished by a milky secretion produced by glands in the lining of the pouch

Most fish leave their eggs in the water without further attention. There are a few fishes, like the stickleback, that prepare a rather rough protection, or nest, for the eggs (Fig. 157).

Some toads carry their eggs about in the mouth until they are hatched.

Among the reptiles and birds the egg begins its development inside the parent's body, and receives a large amount of food and a protective covering.

Most reptiles and some birds leave their eggs to be hatched by the heat of the sun, or at ordinary temperatures. Most of the common birds, however, build more or less elaborate nests and care for the fledglings and for the eggs, besides supplying heat for the hatching. The feeding of the young birds by the parents is a very interesting operation to observe, and it shows a very complex development of instincts.

388. Infancy among mammals. When we come to the mammals, the dependence of the young upon the parents is carried even farther. Not only does the egg develop inside the body of the mother until it has acquired the general form characteristic of the species, but it is nourished by the parent

for a long time after birth. Among the *marsupials*, or pouch animals, like the kangaroo and the opossum (see Fig. 158), the young are placed in an abdominal pouch immediately after birth. In all the other mammals the young suckle from the milk glands of the mother. As we go from the lower mammals to the higher, we find that the infancy of the individual becomes proportionately greater or longer.

This is true even if we compare different races of mankind. Among the primitive savages children are allowed to run about without anyone to watch them as soon as they can walk; in a civilized community we sometimes keep close watch over children, even at their play, for several years. It is easy to see the advantages of a long youth from the point of view of more and more complex civilization. There are physiological differences also connected with the relative length of infancy. This is shown, for example, by the length of time it takes the individual to reach maturity.

The table below shows the duration of the growing period for a number of animals, including man.

GROWING PERIOD OF VARIOUS MAMMALS

ANIMAL	LENGTH OF ADOLESCENCE	LENGTH OF LIFE
Dormouse	3 months	4-5 years
Guinea pig	7 months	6-7 years
Lop rabbit	8-9 months	8 years
Cat	1-2 years	12-15 years
Goat	15 months	12 years
Fox	18 months	13-14 years
English cattle	2 years	18 years
Large dogs	2 years	15-20 years
Horse	4½ years	30 years
Hog	5 years	30 years
Hippopotamus	5 years	30 years
Lion	6 years	30-40 years
Camel	8 years	40 years
Man	20-25 years	75 years
Elephant	30-35 years	100-120 years

PART IV

ORGANISMS IN THEIR EXTERNAL RELATIONS

CHAPTER LXIV

OBSTACLES TO LIFE

389. Life and the environment. To live means to do. Protoplasm tends to be active. But the activities of protoplasm depend not alone on its own structure or composition ; they depend in part, as we have learned, upon external conditions as well as upon the opportunity to obtain various materials from without. While many of the external conditions are favorable to the activities of live matter, others are just as decidedly unfavorable.

390. Temperature and life. Observations on various plants and animals show that the activities of life are dependent upon temperature.

Warm-blooded animals can endure a wide range of temperature, but the protoplasm of such animals can really endure a rather narrow range only. When such protoplasm is exposed to a temperature several degrees below the normal, or several degrees above, it ceases its activities and may even be killed. On the other hand, the cells of the so-called *cold-blooded* animals can actually endure extremes of temperature. Many animals can be frozen and then thawed out again without being appreciably injured.

In careful experiments fish have been frozen in blocks of ice to a temperature of 5° F. (27 degrees below the freezing point), kept this way for some time, and then slowly thawed out without being

killed. When cooled a few degrees lower, the fish were killed. Frogs have been frozen to a temperature of -28° C. (18.4° F.) without being killed. Some of the animals without backbones regularly survive even colder temperatures. Many insects that survive the winter in the adult stage have to be frozen and then thawed out again, although many of them no doubt escape freezing by burrowing into the ground.

In our experience with winter weather many of us have no doubt frozen an ear or a finger. That did not kill us, but it may have killed some of the cells in the affected part. When frozen cells are thawed out rapidly, they are liable to burst and thus be killed, but with a slow thawing the life of the cells may be saved. That is why a frost-bitten ear is rubbed with snow, to prevent it from warming too rapidly.

At the other end of the temperature scale some of the simplest animals (ameba) have been found to survive a temperature of 122° F. when slowly heated. But most of them died at that temperature. This does not mean that the animals were unaffected in the gradually heated water until they were killed. Long before this temperature is reached — at about the temperature of our blood — they ceased active motion.

391. Water and life. We have learned that water is an intimate part of the cell contents, and we can realize that life is impossible without it. Yet the amount of water available for plants and animals is constantly changing (except in the oceans and larger lakes and rivers), so that at one time there is drought, — at least relatively speaking, — whereas at other times there is an injurious excess of moisture. Ponds and brooks dry up; and, so far as the availability of water is concerned, the same condition arises when the water freezes. The soil dries, or it freezes, and the water supply is thus cut off from the countless plants that inhabit the earth. We know that a dry spring or summer may mean a famine, and that some parts of the earth's surface are quite uninhabitable because of the scarcity of water.

392. Light and life. We have learned that light is essential to the manufacture of organic food, that it is the ultimate source of

all the energy which living beings constantly use. The amount of living matter that can maintain itself on a given territory depends largely upon the amount of light available. The tropics, in addition to being warmer, also receive more sunlight and are therefore more closely occupied by living beings than the frigid zones. There is an almost continuous gradation in the density of population¹ between the equator and the poles.

On the other hand, extreme intensity of light is itself a serious obstacle to the normal processes of living protoplasm. Light interferes with the growing process (p. 38) and may be destructive to protoplasm. We see again, then, that a form of energy that is essential to life may be a source of danger to it.

393. Salts and life. The various mineral salts found in the ocean, in other bodies of water, and in the soil are ordinarily absorbed by living beings through the process of osmosis, and many of the salts take active parts in the processes that go on in living protoplasm. Many of them are apparently indifferent in their action, being neither helpful nor injurious; a few are injurious; and of those that are essential, some are injurious in large quantities. On the other hand, a scarcity of particular elements, or of compounds containing these elements, will absolutely prevent the growth and development of living things. The kind of life that is possible in each of two regions that are substantially alike as to temperature, moisture, and light will in many cases be determined by the chemical condition of the substratum.

394. Excess of air. The air, which is necessary to practically all living beings either directly, as an immediate source of oxygen, or indirectly, as a more remote source of oxygen (for plants and animals living in the water) and as a source of carbon dioxide, never seems to be injurious when in excess. Indeed, we do not know of any situation where the air is in excess. If we consider high atmospheric pressure in deep holes in the earth as such situations, we may not be sure

¹ *Population* refers here, of course, to *all* plants and animals and not merely to human beings. The statement is not strictly true for human beings.

that it is the excess of air that interferes with life there; no light is available in such places. If we consider artificial conditions produced by the digging of mines or the use of caissons under water, it is indeed true that these conditions interfere with normal life processes; but they do this not because there is too much air, but because the

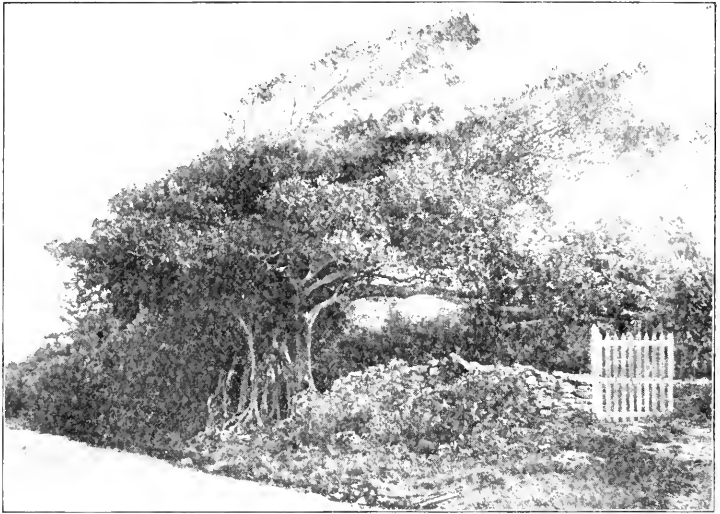

FIG. 159. The wind as an obstacle to life

The wind, often helpful to life and growth, is sometimes a hindrance. In the picture the wind, besides making the tree grow one-sided, and bending over the top branches, has blown the earth away from the roots. (Photograph lent by New York Botanical Garden)

human beings that go into these places are not adjusted to the high *pressure*.¹ Nor is there any place on earth where there is naturally a scarcity of air, except on the very highest mountain tops; but in these situations other conditions are sufficiently unfavorable to life, so that we do not usually think of the absence of plants and animals in these places as due to the lack of oxygen.

¹ The distressing disease known as "the bends," which affects many of those who have to work in the high-pressure atmosphere of the caissons, is very easily avoided by taking sufficient time to enter the working chamber and sufficient time to come out. The disease is not caused by the high pressure; it is caused by the *sudden change* from high pressure to the normal pressure of the surface atmosphere.

CHAPTER LXV

THE CONFLICT OF LIFE WITH LIFE

395. The predatory relations. Many of the animals, and most of the plants, that are incapable of manufacturing their own organic food get their food from the bodies of other plants or animals that are already dead. But there are very many animals, and a few plants, that *kill their prey*.

The gentle cow and the soft-eyed deer browse on the herbage, and we never think of them as beasts of prey; yet from the point of view of the grasses and shrubs that furnish them their food these animals are truly predatory. That is to say, they are direct destroyers of living things. To maintain themselves upon this earth, certain living things must somehow protect themselves against predatory enemies, and this is just as true of plants as it is of animals.

396. The parasitic relation. There are many plants and animals that get their food supplies from the living bodies of other organisms. That is to say, they eat from the living victim, sometimes thereby killing, but not always and not necessarily. Plants and animals that get their food in this way are called *parasites*.

The most common parasites are found among the lowest plants and animals; but nearly every class of living things has its parasitic representatives. Some two dozen of the common diseases of man, and many diseases of our domestic animals, are known to be caused by the activities of parasitic bacteria in the bodies of the victims. Protozoa as parasites are known to cause malaria and the sleeping sickness of Africa. Most of our common plant diseases are caused by fungi or bacteria. The hookworm is a serious parasite on man; and the

tapeworm, although perhaps not so serious, is probably more common. Among insects are many related to the wasp and the bee that lay their eggs in the bodies of caterpillars; when the young hatch out, they begin to feed on the caterpillar (see 5, Fig. 115). Among the backboned animals, certain fishes will attach themselves to the bodies of other fishes and suck the blood from their victims.

Most vertebrates get their food either by killing plants or other animals or by taking dead matter (that is, plant or animal remains) of one kind or another; in other words, there are very few vertebrate parasites.

The idea of parasitism extends beyond the means of getting food. The European cuckoo will¹ lay her eggs in the nests of strange birds, thus getting from other organisms at least two direct benefits—the work of building a shelter for the young and the work of keeping the eggs warm during incubation; there is also the feeding of the young through the work of the strange foster mother. This is a case of getting *services* from another organism, without giving anything in return. It is in this sense that we use the word *parasitism* in connection with higher animals, and especially in connection with human affairs.

From the viewpoint of the unwilling hosts to the unbidden guests, parasitism is an obstacle to life; and every species of living things is exposed to a number of such parasitic enemies. To be able to protect itself against parasites is one of the conditions necessary for maintaining life.

397. The competitive relation. If all the offspring of any plant or animal should reach maturity and reproduce the usual number of young, and if this were continued for several generations, the earth would not be able to hold the resulting population.¹

¹ A conger eel is said to lay 15,000,000 eggs in a year. If each of these eggs hatched and reached maturity, and if each of these individuals reproduced at the same rate as the parents, the ocean would soon be crowded with conger eels. The same thing is true of all animals.

It is evident that survival is impossible for all that are born. Many are killed by the unfavorable conditions of life, many are killed by mechanical injuries of various kinds, many are killed by predatory enemies, and many are killed by parasites. Finally, there are left those who remain to live out their lives. But those do not all reach the full length of years. There are still too many of them to live comfortably in the world. Many of these are now destroyed in their competitive struggle with one another.

This idea of competition, borrowed from the forms of business operations that prevailed during the nineteenth century, applies to living things, for the most part, only in a figurative sense. There are really very few animals, and no plants, that are engaged in a direct conflict for the materials necessary to their well-being or to their survival. There are, however, situations in which more individuals are born than can possibly reach full development, and in the course of time we find that some have endured, while others have perished.

In a shaded wood, for example, the young seedlings grow at different rates. Some grow fast enough to bring their tops into the sunlight before others do — they have the advantage of more light. They now grow faster, not only because they are more favorably situated, but because the growth of their "competitors" is retarded by lack of light. It is absurd to suppose that these plants are struggling, in the sense in which two wrestlers or two racers are struggling with each other. No one does anything that is directly related to injuring the other or to helping itself as against the other. The result that one survives and the other perishes depends upon certain external and certain internal conditions of the plants, and not upon anything in the slightest degree resembling effort, or offense or defense.

It is only when we come to the highest animals — especially birds and mammals — that there is a real competitive struggle that involves direct danger to the participants. A number of wolves, for example, may fight over a carcass. In any farmyard

you may see chickens peck at each other when they are feeding; they peck at anything that gets in their way. More conspicuous are the competitions among the highest classes of animals for their mates. Male seals and walruses will fight for the possession of the females; male stags and other mammals will do the same. In such struggles the individuals are actually exposed to injurious attacks, and the survival of the individual depends upon his superior means of protecting himself. Some birds also fight each other in this competitive way.

We may conclude by recalling that every living thing is exposed to a number of obstacles or direct dangers to well-being; that some of these arise from excess or shortage of certain materials in the environment, and that others arise from the various co-inhabitants of the world. To live, one must be able to overcome these obstacles and to escape these dangers.

CHAPTER LXVI

PROTECTIVE ARMORS OF ORGANISMS

398. Walls and shields. The simple cell wall that we find in the one-celled plants, and the cell membrane found in many one-celled animals, may be considered to serve as protection against mechanical injury to the protoplasm. At the same time they permit the osmotic transfer of income and excretion.

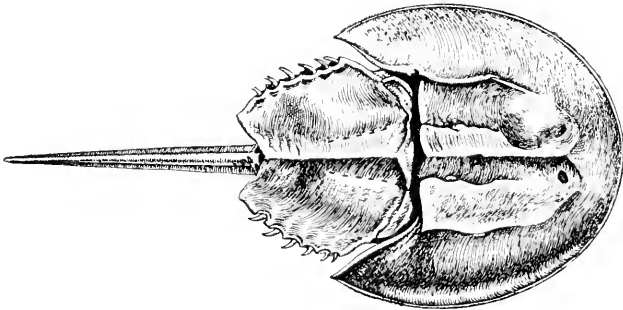

FIG. 160. The horseshoe crab

This animal is protected by an external skeleton, or armor, of *chitin* secreted by the skin cells

In plants and animals made up of many cells we generally find that the external layer of cells is either modified into a protective layer or supplemented by various protective structures. The outer cell walls of skin cells in plant structures are usually thicker than the inner walls and much thicker than the walls of inside cells. The skin cells of leaves usually have a secretion of a fatlike substance on the outer surface (see I, Fig. 5), called *cutin*, which prevents evaporation from within as well as water-logging from without. It adds also to the protection against mechanical injury.

In many plants the outer surface of the leaf or fruit has, in addition to the cutin, a layer of waxy material. This is the bloom that we see on plums and other plant surfaces.

In many animals the cells forming the surface layer of the body are small and thick-walled, and many kinds of secretions add to the protective value. The horseshoe crab (Fig. 160) produces his armor by secreting a substance that

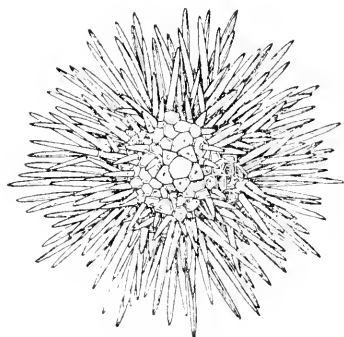

FIG. 161. Sea urchin

Animals of this branch deposit large quantities of lime in their skin, and produce knobs and spines that form a protective armor

hardens like a varnish in the water. This is very similar to the substance that makes up the *exo-skeleton* (outside skeleton) of insects, the *chitin* (pronounced kī'tin), which is also formed by the secretion of the skin cells.

In lobsters, crabs, crayfish, and their relatives (the *Crustacea*) the chitin secretion is combined with a comparatively large amount of carbonate of lime. This it is that gives the exoskeleton of these animals their crusty quality. Clams, oysters, and snails have extremely soft skins. (The name of this whole group of animals, *Mollusca*, refers to the general *softness* of these organisms.) They receive, however, a great deal of mechanical protection from their *shells*, which consist of deposits of lime formed by the secretions of a special fold of tissue called the *mantle* (see Fig. 44).

On the clam and on the snail the lines indicate the successive deposits of lime. The inner surface of the shell is often very beautiful and *iridescent* because of the very fine lines that break up the surface. This mother-of-pearl is used extensively for ornamental purposes. — for buttons, knife-handles, etc., — and the shells of many mollusks are used for their hardness and durability in the making of buttons and similar objects, without regard to their beauty.

In the starfish and sea urchins and their relatives (*Echino-dermata*, meaning "spiny-skinned") the skin secretes a great deal of lime, which is deposited in the form of definite rows of plates and in projecting spines (see Fig. 161). We may well imagine that no fish would care to eat a mouthful of such spiny creatures as the sea urchin or to bite and swallow the harsh rays of a starfish.

In the trunks of our common trees there is a growing layer that constantly produces new layers of wood and new layers of bark (see Fig. 63), which consists at first of epidermal cells, pith cells, and phloëm. As the plant continues to grow, the older cells die and their walls become corky. The older layers are moved farther and farther from the center of the plant as new layers of cells are formed, and the outermost layers, exposed to the weather and to mechanical injury from moving animals and other objects, rub off or chip off. The mass of bark is thus a constantly renewed protective layer.

Similar in some ways to the bark of a tree is the hide or skin of a mammal. Our own skin, for example, is made up of dead cells on the outside. These are constantly rubbing off, but are as constantly replaced by new cells from beneath. The growing layer (see *b*, Fig. 92) gives rise to

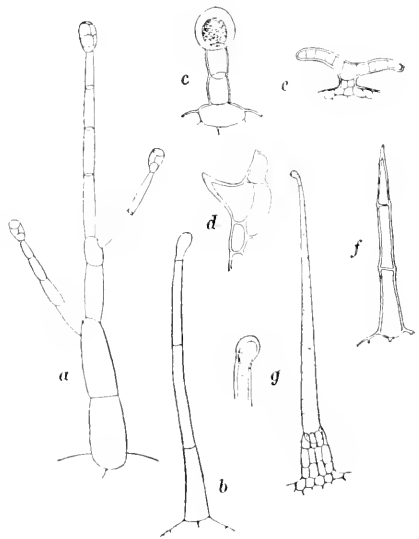

FIG. 162. Hairs of plants

a, branching hair on leaf of tobacco plant; *b*, hair on leaf of thorn apple; *c*, glandular hair on leaf-stalk of Chinese primrose; *d*, marginal tooth on sedge leaf; *e*, glandular hair on flower of hop; *f*, leaf of apple of Sodom; *g*, stinging nettle, with tip, greatly enlarged

new cells; these die as they are moved toward the surface by the newer cells beneath, becoming a layer of dead scales.

The skin protects the animals not only against mechanical injury but also against the loss of water and against the absorption of water, for the skin is practically waterproof, being

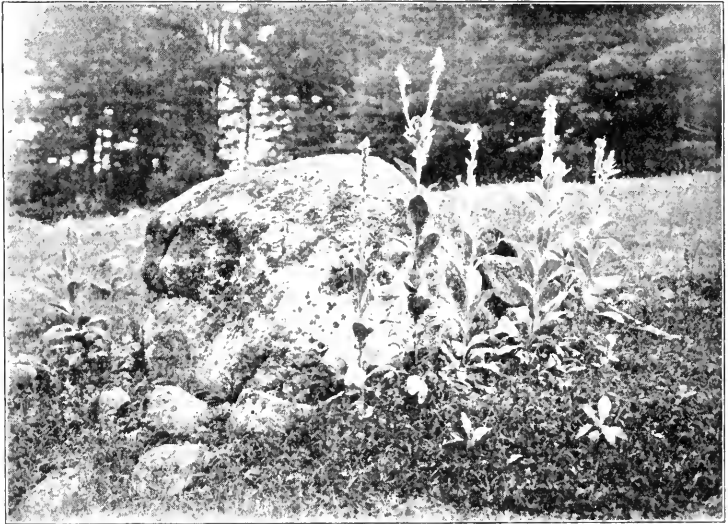

FIG. 163. Mullein in pasture

These plants are closely covered with fine, branching hairs, giving the leaf a flannelly texture. We can well imagine that a cow would not care to eat anything that felt like flannel in the mouth, and so we can understand that the hairy growth may actually protect the plants against grazing animals. (From photograph by Dr. H. A. Kelly)

more or less oily (see p. 206). It also protects, to a certain degree, against too rapid changes of temperature. In this function many skins are supplemented by layers of fat on the inside and by hairs or fur on the outside.

399. Hairs and other outgrowths. On the leaves and stems of plants the cells of the epidermis enlarge at right angles to the surface. This mode of growth results in the formation of hairs (see Figs. 162, 163).

It seems likely that in many plants the hairs are really related to the moisture. The absence of moisture, or, rather, a shortage of

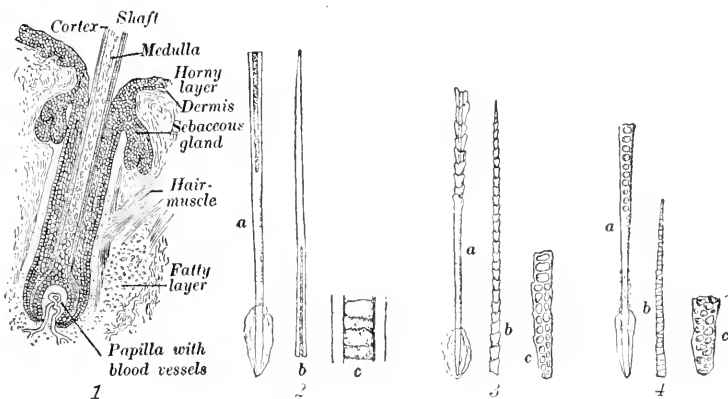

FIG. 164. Hair of mammals

1, human hair follicle, showing mode of growth (the dead shaft is pushed forward by the new growth about the papilla); 2, hair of horse; 3, hair of mouse; 4, hair of marmot. a, base of hair; b, tip; c, more highly magnified portion of shaft

moisture, is known to bring about the production of hairs in species of plants that ordinarily do not produce hairs when water is abundant.

Hairs are also likely to protect many plants against extremely high or low temperature.

The hairs familiar to us in common animals and on our own skin are much more complex in structure than are plant hairs (Fig. 164).

The feather of the bird may be considered as a highly complex hair. In the manner of growth the feather resembles the hair of mammals very much, but in its structure it is of course very

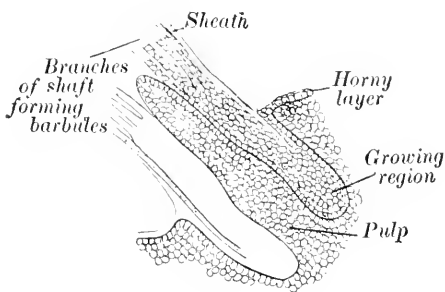

FIG. 165. Feather structure

The feather of a bird is a skin structure that grows in substantially the same way as a hair or a finger nail

different, and each feather has a determinate growth; that is, there is a definite limit to the size and form which a single feather can attain (Fig. 165).

The bristles of hogs and the quills of hedgehogs and porcupines are giant hairs. Hairs, quills, bristles, and feathers may

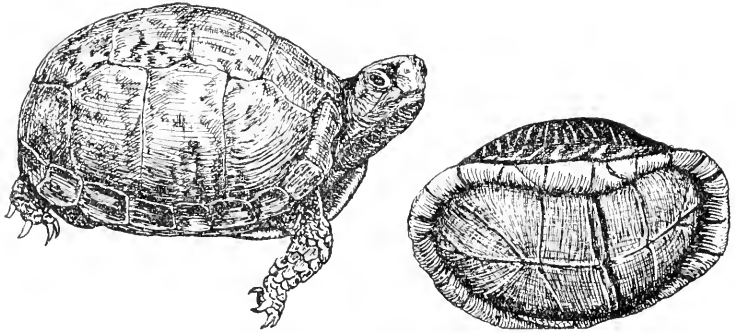

FIG. 166. Box turtle

The exoskeleton consists partly of skin plates and partly of bony expansion. This animal is protected not only by the withdrawal of head and limbs but by the further closing of the hinged breastplate, shown on the right

be considered as special kinds of skin growths and may be compared to the scales of the common fishes and of reptiles, and to the plates found in the skin of sturgeon and the gar pike. The shield of the turtle or tortoise is in part a skin structure and in part produced by the skeleton (Fig. 166). The amphibians (frogs, newts, etc.) are the only backboned animals that never produce outgrowths on the skin, although some of the toads have irregular thickenings in the adult stage.

CHAPTER LXVII

PROTECTIVE PIGMENTS AND APPEARANCES

400. Pigments and light. Animals that live at great depths of the sea, and those that live in caves, — situations in which there is little or no exposure to light, — do not generally show much pigment in the skin. This fact may be interpreted in two ways :

1. Where there is no danger of being injured by light, the species will be able to maintain itself without acquiring the pigment-forming habit.

2. Where there is no light stimulation, pigment will not be formed.

In the human race the dark pigment of the skin is undoubtedly a protection against the light, as shown by the relative sensitiveness of light-skinned races and dark-skinned races to the influence of the tropical sun. It is also shown by the behavior of the skin of a person who has been tanned and the behavior of the skin of the same person before the tan has formed. A person who does not get tanned is likely to be sunburned with every exposure to strong sunlight. On the other hand, in a person who is dark-skinned, or who has become tanned, the pigment acts as a screen, cutting off the rays that are injurious to the protoplasm.

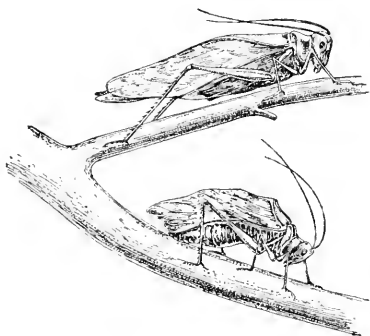

FIG. 167. Katydid

Microcentrum retinerzis (above); *Cyrtophylus concavus* (below). These insects match the color of the foliage upon which they feed: in some species the resemblance to a green leaf is even more striking than in the two shown here

In certain experiments with flatfish that are ordinarily pigmented on the upper surface and white on the lower surface, the light was supplied from below by means of mirrors, with the result that the fish developed pigments on the lower surface and remained white above.

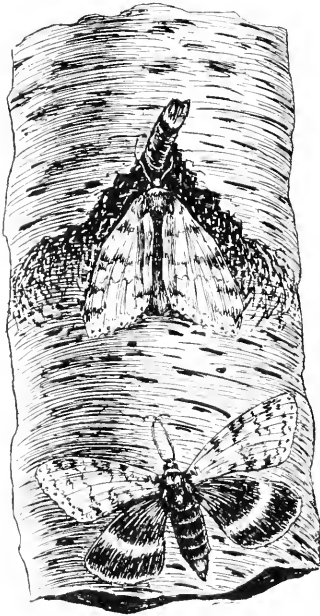

FIG. 168. The underwing moth (*Catocala*). (Slightly reduced)

When they are at rest, the moths of this genus resemble the bark of trees, so that they are no doubt often overlooked by their enemies

surface and remained white above. From these experiments and from our own experience with getting tanned, we may feel confident that at least in many cases the formation of the pigment is due to the stimulation of the light. But we know also that there are many other pigments that are formed without reference to the light, whether they have any protective value or not.

401. Invisibility. In relation to enemies that can *see*, one of the most obvious means of protection is something to make one invisible. The jellyfish (Figs. 154, *a*, and 155, *b*) is so nearly transparent that it is practically invisible in the water.

But transparency is not the only means by which an object may be made invisible. The seeing of objects depends upon the contrasts in lights and shadows; an object that is colored like the background becomes by that fact invisible. This type of invisibility is so common in nature that some men claim to be able to tell the kind of surroundings an animal naturally occupies from the character of its surface colorings. The green katydid among the green leaves is a common example of so-called *protective coloration*

(Fig. 167). The tree toad and the partridge become lost to the eye, as well as the sand flea and the underwing moth (Fig. 168). It is familiar to all of us that desert animals are frequently tawny in their color, whereas arctic animals are frequently white.

There can be no doubt that in relation to certain enemies the resemblance between an animal's color and the background color is often a real protection. At the same time, there is danger of exaggerating the importance of this resemblance to the organisms, and there is a corresponding danger of trying to prove too much from this resemblance. Thus, the whiteness of arctic animals is apparently due in many cases not to the whiteness of the surroundings but to the low temperature.

The color of an animal is often due to the character of the wastes produced by the chemical changes going on in the protoplasm. The character of the waste, in turn, will depend upon the nature of the food. A change in diet will therefore in many cases result in a change of color. This is shown in the

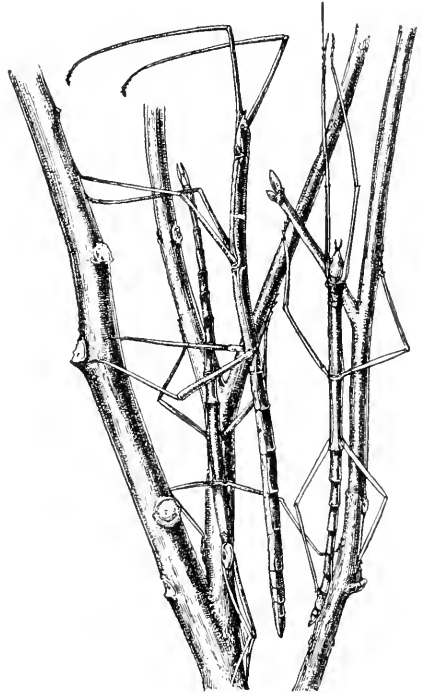

FIG. 169. The walkingstick. (Slightly reduced)

This animal has startled many a person by walking away from a hand stretched out to grasp a leaf or twig. The insect is related to the locust and katydid, but it has no wings. Its body and legs are very long in proportion to thickness, and the enlargements at the joints and the irregularity of outline increase the resemblance to bare twigs. Moreover, the color of the animal changes with the seasons, from a bright green in the spring to a deep brown in the fall, thus matching its surroundings very closely

brightening of the color of canaries by a regulation of the diet, and by a change in the color of many insects with the change of diet. On the other hand, if a color is to *protect*, it can do so only in relation to an eye that fails to discriminate. But if the enemy finds his prey by means of smell or some other sense, the color cannot be a protection.

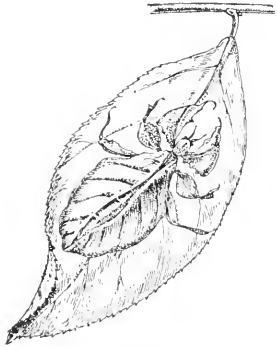

FIG. 170. Walking-leaf insect

This insect, related to the locust and the katydid, resembles the foliage upon which it crawls. ($\times \frac{1}{2}$)

close to the ground these white spots merge with the light of the sky, and the outlines of the animal are as completely lost as are those of the zebra or the tiger among the stems of the underbrush.¹

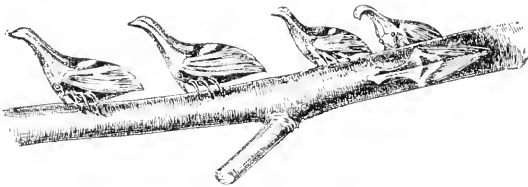

FIG. 171. Tree hoppers (*Membracis binotata*)

These small insects resemble miniature quail quite as closely as other animals "mimic" their models. Yet there is no conceivable advantage to the insect in this resemblance

402. Protective resemblances. In some animals the mottlings and striping are often very close imitations of particular kinds of backgrounds, and this resemblance is further heightened in many animals by peculiar forms (see Figs. 168, 170).

¹ The art of "camouflage" as developed during the Great War rested largely on the observations of naturalists on protective coloration.

What is perhaps the most remarkable resemblance between an animal and a part of its surroundings is furnished by the East India butterfly *Kallima* (Fig. 172). The undersurface of the wings, exposed when this butterfly is at rest, resembles a brown leaf with a distinct midrib and veins passing from this to the edges. Near one end is a dark spot close to a nearly transparent area, resembling very much the kind of spot often produced by the action of some fungus. The details are very sharply defined and almost uniform. If one of us should see a flying kallima come to rest on a twig, he should perhaps have some difficulty in distinguishing the insect among the leaves; it is possible also that the lizards and birds that feed upon this species are sometimes baffled in their pursuit of prey. Yet it is doubtful (1) whether the advantage of this resemblance has had anything to do with its gradual appearance as a character of this species, and (2) whether, indeed, it is an advantage (see Fig. 171).

403. Warning colors. We saw that some of the wastes produced in living bodies are poisonous (see p. 203), and we can understand that the presence of these poisons in the body of a plant or an animal would make such a body undesirable as food for another animal. Distasteful (bitter, sour, acrid, foul-smelling) substances may thus serve to protect organisms against possible enemies. Poisonous and distasteful substances in an animal body are often associated with conspicuous colors, which have been called warning colors by some naturalists. The idea is that the bright color warns enemies against eating



FIG. 172. The Indian leaf butterfly (*Kallima*). (Slightly reduced)

Many arguments concerning the evolution of animal life have been based on the striking resemblance between the wings of this insect when at rest and brown leaves. It has been said that the animal looks like a leaf only when it comes to rest with the head up; but observers who have seen the animal in its native surroundings tell us that it always comes to rest head *down*, on guard against lizards. In this position it is sufficiently conspicuous to be recognized even by untrained human eyes

the animal. But this involves some way of educating the enemies as to the meaning of the warning. It is true that many animals instinctively avoid certain kinds of plants and certain kinds of animals, and that some of the avoided species are really injurious. It is also true that animals are often poisoned by eating unsuitable organisms, and that animals often eat organisms that are distasteful or that make them sick.

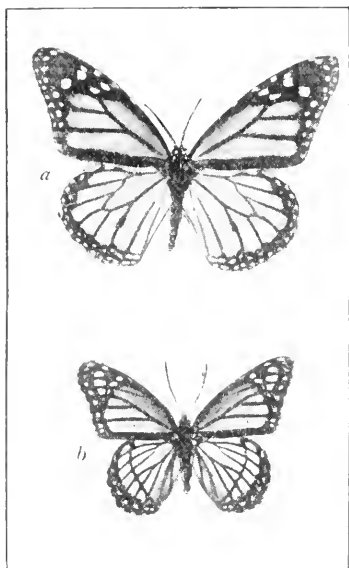

FIG. 173. Mimicry among butterflies

The viceroy, *b*, belongs to a different genus of butterflies from the monarch, or milkweed butterfly, *a*; yet the resemblance at first glance is so striking that most people will be unable to point out any difference between the two except in size. A close study will show us, however, a number of differences in the pattern

A young chick, fresh from the egg, soon begins pecking about for food. A chick finds a worm or a caterpillar and at once eats it. Most of the material thus taken is sufficiently palatable. But presently the chick finds a hornet or a woolly-bear caterpillar. This mouthful is somewhat too much for the chick; it makes a profound impression on the young animal. The hornet may be killed, or the caterpillar may be killed, but the chick is impressed. She will never eat that kind of food again. The dead hornet or caterpillar has taught the chick a lesson, but cannot get the benefit of the lesson. Other hornets, however, or other woolly bears, are safe, so far as that particular chicken is concerned.

The individual *sample* is thus sacrificed for the benefit of the species. When we consider that every individual has to have his own lesson, we should think this a rather expensive mode of protection, but we may take the idea for what it is worth. One thing is certain, many conspicuous species lack the bitter juice, while others have the bitter juice, and yet lack a conspicuous appearance; and one species seems to hold its own about as well as another.

404. Mimicry. Growing out of our knowledge concerning the relations of the characters of animals to their safety and danger, a very interesting idea was developed by some naturalists during the last century. This is the idea of

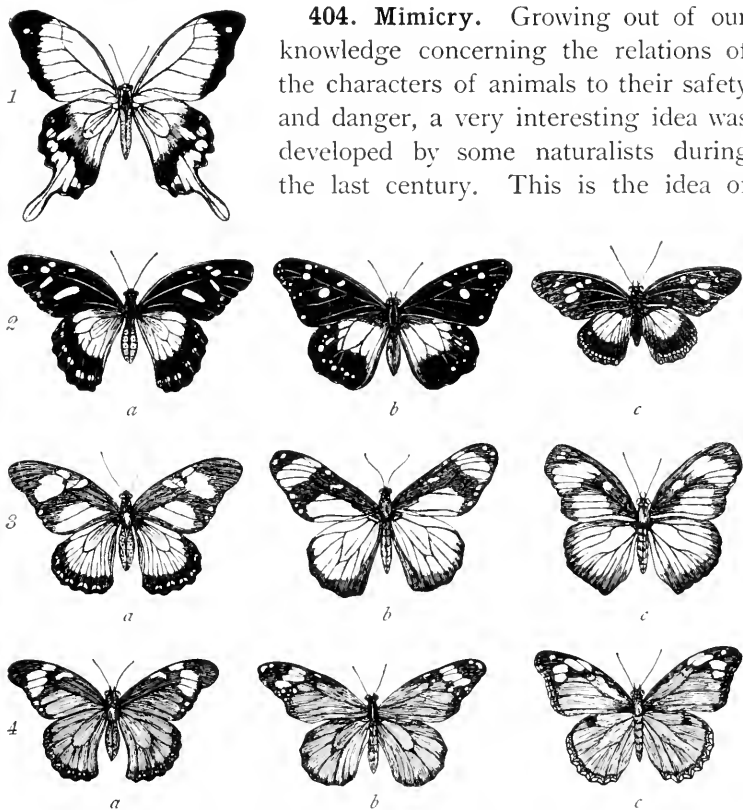

FIG. 174. The mimicry of the African swallowtail butterfly (*Papilio dardanus cenea*)

1, the male. The female, *a*, occurs in three distinct forms. Each of these forms presents striking resemblances to butterflies of other genera. Thus, the form *cenea*, 2 *a*, resembles *Amavris echeria*, 2 *b*, which in turn resembles *Pseudacraea tarquinia*, 2 *c*. The form *lipocoon*, 3 *a*, resembles *Amavris niavius*, 3 *b*, which in turn resembles *Euralia walbergi*, 3 *c*. The form *trophonius*, 4 *a*, resembles *Danaus chrysippus*, 4 *b*, which in turn resembles *Diadema misippus*, 4 *c*. The argument that these resemblances bring about advantages may be sound, but too little is as yet known as to what brings about the patterns of the insects supposed to represent the original model

protective mimicry. A common example of this near home is the resemblance between the milkweed butterfly and the viceroy (see Fig. 173).

The explanation that is sometimes given of this resemblance is as follows: The milkweed butterfly has a bitter or disagreeable taste, and therefore birds commonly avoid eating the insect. The viceroy belongs to a family that is commonly eaten by the birds, being sufficiently attractive to them. The resemblance between the viceroy and

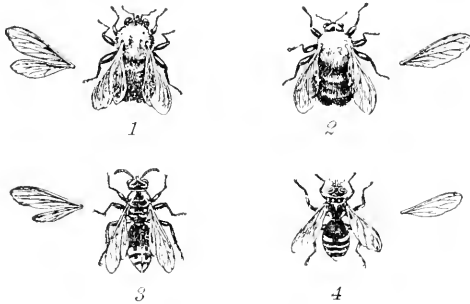

FIG. 175. Supposed cases of mimicy

1, *Bombus pennsylvanicus*, a bumblebee, mimicked by 2, *Laphria thoracica*; 3, *Vespa maculata*, a wasp, mimicked by 4, *Spilomyia fusca*. In these cases the models and the mimics belong to entirely different orders of insects, — the former are hymenoptera, or bee order; the latter are diptera, or fly order

the monarch protects the former from the attacks of the birds. Of course it is not supposed by anyone that the viceroy butterflies have *purposely* mimicked the monarch. It is only supposed that the resemblance, however it may have come about, is of advantage to the insects. We do not understand how these resemblances, or others like them (see Figs. 174, 175), have come about. Some of

the theories offered to explain them are discussed in Chapter LXXXIV.

We are in doubt not only as to how such protective mimicy may have arisen; we are also in doubt as to whether mimicy is in all cases protective.

Professor Punnett, an English biologist, made a special study of this subject in Ceylon, where examples of mimicy are unusually abundant. He found, in regard to certain cases, that the model and its supposed mimic never occupied precisely the same area; at most, the two areas overlap more or less. In the second place, the common birds, against which the mimicy is supposed to be protective, do not molest either the model or the mimic; but the lizards eat the mimic as well as the other members of the family, which are supposed to be defenseless. The only other serious enemy of these butterflies was a certain large fly that pierces the thorax of the insect and sucks the juices. But this fly, like the lizard, attacks the mimic and his defenseless cousins without discrimination. In other

words, the resemblance to the model does not protect. Moreover, in a part of the island where monkeys are supposed to be the chief enemies of the butterflies, the most abundant forms are those that are supposed to be defenseless forms, whereas the mimics are scarce.

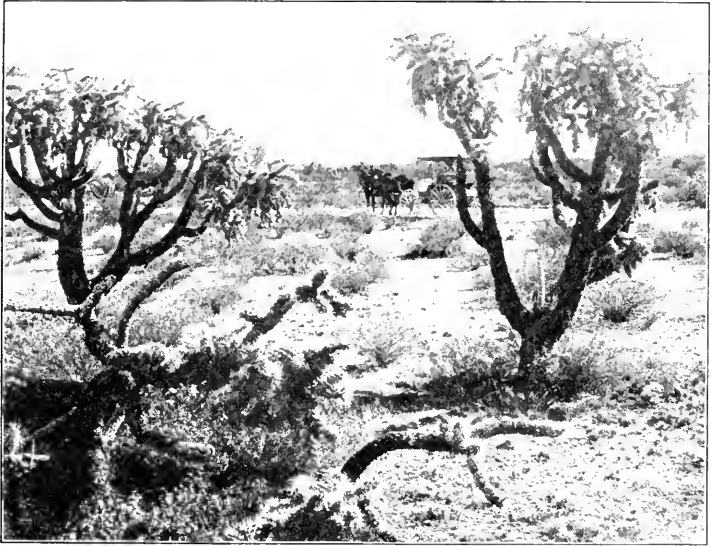

FIG. 176. Desert plants

Cholla cactus on the western deserts. The thickened leaves and short stems, or the entire absence of leaves, may be considered as a more or less direct adaptation to the high temperature and the dry soil, which together make up the danger of excessive loss of water. (From photograph by the United States Reclamation Service)

405. Reduction of surface. Some organisms may derive a kind of protection from a reduction of surface. This is especially common among plants that are exposed to the danger of drought. In desert plants we observe a comparatively small surface in proportion to their bulk (Fig. 176).

CHAPTER LXVIII

PROTECTIVE MOVEMENTS

406. Contractions. Contraction under stimulation is a common thing among living beings. When the ameba is disturbed



FIG. 177. Contraction of sea anemone

When disturbed, the surface of this animal becomes greatly reduced by repeated contractions, until it resembles a wart on a rock

in any one of several ways, it immediately *contracts*. The effect of this contraction may be protective in several ways:



FIG. 178. The pill bug

When suddenly disturbed, this animal curls up, thus reducing its exposed surface and concealing its most delicate and sensitive parts. ($\times 3$)

1. It reduces the total amount of surface exposed to danger
2. It hardens (condenses) the exposed surface.
3. It withdraws the animal from the point of attack.

Here are three results of this simple reaction that may presumably be of use to the animal under various conditions.

The sea anemone shows a remarkable amount of contraction when disturbed. In fact, all the animals of this branch (coelenterates) are extremely contractile (see Fig. 177).

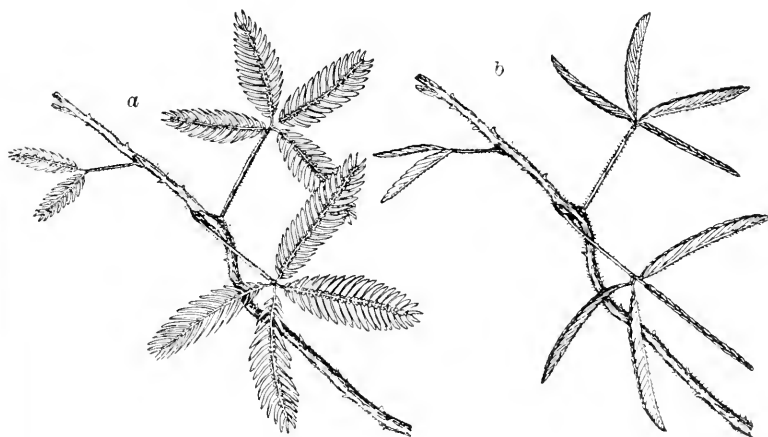

FIG. 179. Sensitive plant (*Mimosa pudica*)

a, leaves in normal position; *b*, leaves reduced after disturbance. It is not necessary for us to assume that this movement is of any real value to the plant. It is true that in the new position the leaf exposes less surface and sheds the water better. But hundreds of plants with similar leaves have no difficulty in shedding rain without being so sensitive. Many plants (clover, oxalis, and others) droop their leaves in the dark in a few minutes. It is possible that in the clover and others the drooping of the leaf is the direct result of reduced transpiration. But that does not give the plant any advantage. It is very likely that the sensitive plant is simply more sensitive than any of its relatives (the bean family), many of which are sensitive in the same way but not in the same degree.

In clams and oysters, contraction of special muscles results in closing the shell. In snails, contractions withdraw the body into the shell. The turtle withdraws head and legs into his "shields," and the box turtle closes the shell up even more completely.

We do not usually think of plants as moving, either to get food or to escape danger. Some plants, however, can do a great deal of moving in connection with the capture of insects

and other animals. Several other plants are capable of moving their leaves when disturbed, as the sensitive plant (Fig. 179).

407. Color changes. To be able to elude the vision of the enemy must be of real advantage to any animal. It is therefore reasonable to assume that the color changes of the chameleon

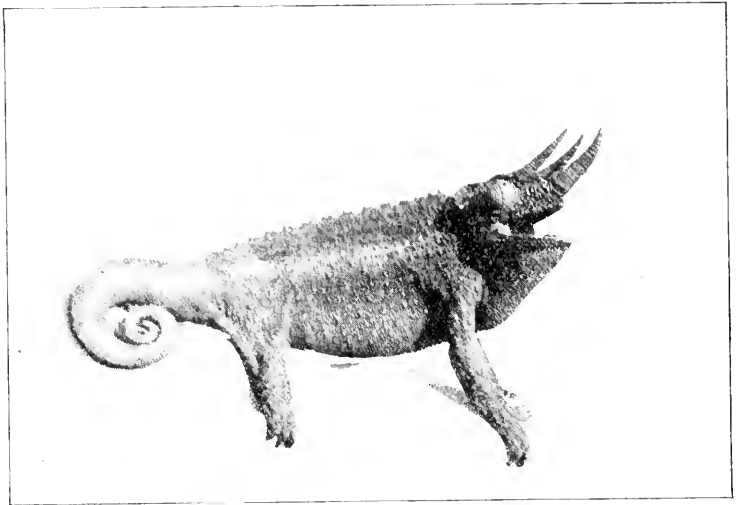

FIG. 180. The true chameleon

African chameleon (*Chameleon sp.*) from Mt. Kenya, near the equator. (Photograph by Carl E. Akeley, American Museum of Natural History)

must be of protective value to him, and that they are brought about by the color of the surroundings. The true chameleon, a native of Africa (Fig. 180), and the American chameleon (Fig. 181), or green lizard, quickly change their color through a wide range of shades, from bright green to rather dull brown. These changes are brought about by the contraction or expansion of various parts of the skin, containing different pigments.

Careful experiments show that the color changes are produced by a response to *temperature* changes or by the intensity of the *illumination* rather than by the color of the background.

In many situations, however, these color changes may be protective, even though they are not necessarily protective adaptations in all cases.

408. Concealment. Another way in which an animal becomes invisible to its enemies is illustrated by the cuttlefish, which ejects a dark fluid into the water when it is pursued. This "ink-bag" trick clouds the water and thus enables the animal to escape from its pursuer.



FIG. 181. The American chameleon

The green lizard (*Anolis carolinensis*). (From photograph by American Museum of Natural History)

The instinct for finding shelter is very marked in many animals of nearly all classes. In many worms we may observe a strong tendency to crawl into cracks or angles. There are certain worms that are so persistent in this trait that if two of them are placed in opposite ends of a glass tube, they will approach each other and keep on driving forwards until they have worn their heads off. The contact of the body against the hard walls stimulates them to move forward, and they don't know enough to stop when they have gone far enough.

A more remarkable home-finding instinct is that shown by the hermit crab, which makes itself at home in the discarded shells of snails. As the animal grows larger it abandons one shell and finds another (Fig. 182). With this instinct we may compare that of the higher animals that dwell in caves or other ready-made openings that they find.

409. Flight. Beginning with the ameba, that withdraws its "false feet" from a point of disturbance, and reaching to man himself, all animals that are not confined or attached protect themselves by some form of flight or escape. With this fact is associated a wonderful series of organs of locomotion, from the false feet and cilia of the protozoa, the water feet of the starfish, the flapping shell movements of the scallop, the wriggling of



FIG. 182. The hermit crab

These crabs make themselves at home in the cast-off shells of whelks and snails. (From photograph by New York Zoölogical Society)

worms, and the legs and wings of insects, up to the various kinds of legs and wings and fins of the backboneed animals.

It is impossible to say that organs of locomotion are primarily related to protection or that they are primarily related to food-getting. At the very lowest levels of life, among the protozoa, we find the same structures and activities serving organisms in both relations. Thus, the paramecium, moving about by means of cilia, also gets food particles into the interior of the protoplasm by means of cilia. And farther up we find feeding organs and locomotive organs differentiated from the same structures (see Fig. 183).

Even among the mammals we find the primates (monkeys, apes, man) using their front limbs in food-getting quite as much as in locomotion, or even more.

410. Migration. A very interesting problem in connection with the protective movements of animals is that of migration. The migrations of the common birds are more or less familiar to all of us. Those of us who live in the northern latitudes are likely to look upon bird migration as "going south in the winter to get away from the cold," or as "going south to get food." If we live in the south we may well ask why the birds ever go north; and we can think of no advantage to their migration except that of finding a breeding place for the young in a region free from the usual enemies or other obstacles (see Fig. 184).

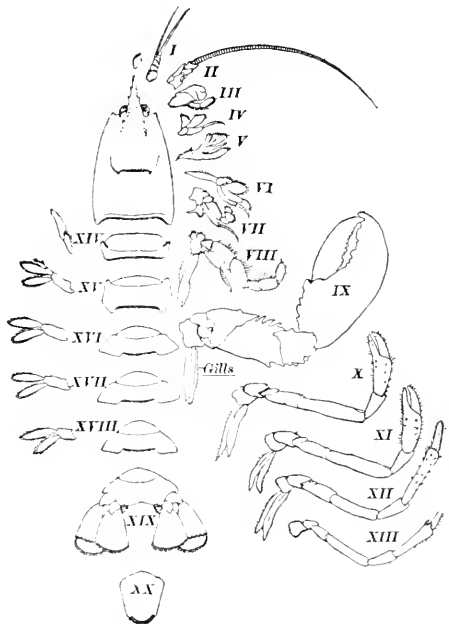

FIG. 183. The appendages of the lobster

In the Crustacea all the appendages are built on the same plan, but each segment of the body (represented by Roman numerals) has a distinctive organ. I and II are sensory; III-I' combine sensory functions with food-getting; VI-VIII are chiefly food-getters, but are also related to breathing; IX is the nipper; X and XI are both grasping and locomotor organs; XII and XIII are walking legs. The abdominal appendages XIV-XVIII are called swimmerets and probably assist in slow swimming. XIV and XV are also related to reproduction in the male, and in the female all the swimmerets carry the hatching eggs and larvæ. XIX and XX spread out into a flat tail-paddle, used in swimming backward suddenly

It is possible that some species migrate originally with relation to food and weather, and that other species migrate primarily in relation to possible enemies. Whatever the advantage to the species, it is

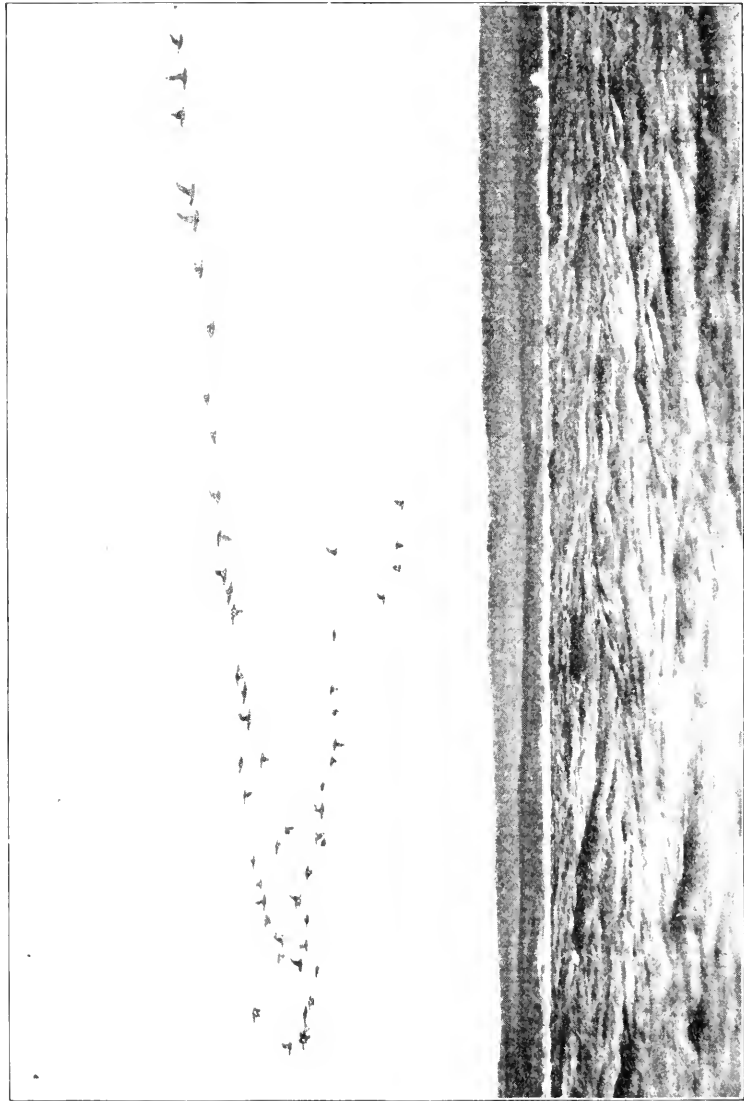

FIG. 184. Birds in migration

The American scoter (sea coot), or booby (*Oidemia americana*), migrating along the Massachusetts coast in winter, after breeding in Labrador. (From photograph by Herbert K. Job)

curious that year after year the birds will follow the same routes, even coming out of their way many miles to go with the flock. It is probable that the older birds lead the migrations, and that the paths are kept by force of imitation. The young follow, and the older ones

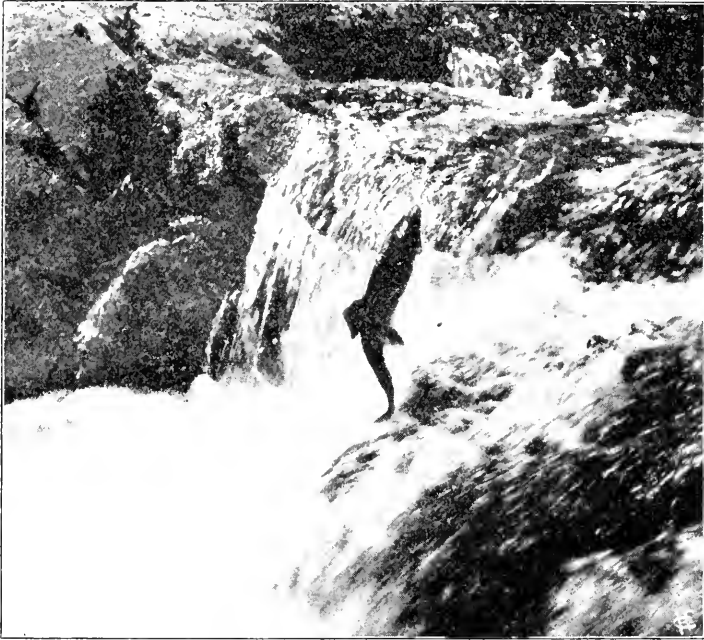

FIG. 185. Migrating fish

Humpbacked salmon jumping low falls, Litnick Stream, Alaska, on way to breeding grounds. (From photograph by United States Bureau of Fisheries)

continue to do as they have always done. As a result, customs are established that persist even when they cease to be of greatest advantage or economy.

Migrations of fishes have also been recorded, and these seem to be related chiefly to finding safe breeding places. Some, like the eel, will go out into the ocean to breed; others, like the salmon, will spend most of their time in the ocean and will come up into the rivers to breed (see Fig. 185).

CHAPTER LXIX

PROTECTIVE ACTIVITIES

411. Home-making. When the earthworm burrows into the ground, it thus escapes the birds and other enemies; but the burrowing is essentially a process of food getting, for the

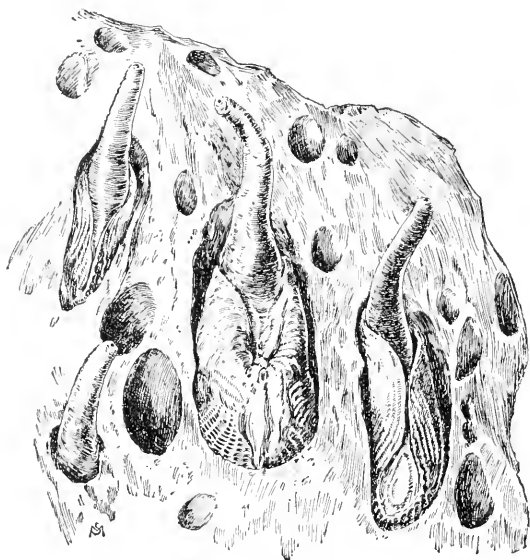

FIG. 186. The piddock

This mollusk grinds its way into the rock, growing larger as it digs deeper, so that in the end it is completely imprisoned

movements related to protection or escape from injury are hardly to be distinguished from the activities related to the getting of food. The simple life will cover all of its necessities by a few acts. But with higher animals it is often difficult to draw a

animal feeds by swallowing dirt as it digs along, and absorbing from it organic material left by decaying plant and animal matter. In the same way, the larvæ of various insects and many adult beetles escape their enemies by boring into trees.

In the simplest of animals, where all the activities of life center in the protoplasm of a single cell, the

sharp line between the processes that are related primarily to the getting of food and those that are related to protection. In the intestines of a child a tapeworm absorbs its food from the host and it is at the same time protected from all possible enemies. It would be absurd to say that the parasite makes its home and its living in the intestines of a vertebrate "because" that is a safe place, although it may be true this habitat is indeed safe enough. In the same way, we must be on our

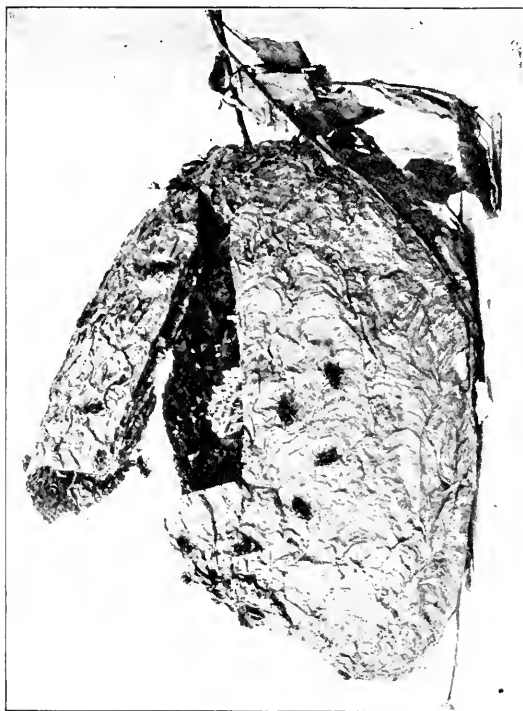

FIG. 187. Nest of the paper wasp, or black hornet

The queen wasp survives the winter alone. In the spring she builds a small nest of wood pulp, or wasp paper, and lays a few eggs in it. While these are hatching she fetches various grubs and caterpillars, which serve as food for the young. On becoming mature the workers proceed to enlarge the nest and to bring supplies of food. The queen continues to lay eggs throughout the summer, and most of these develop into workers, though some of the eggs hatch into perfect males and some into perfect females. After fertilization the males and the workers die, leaving the queens to live through the winter and to start new colonies in the spring

guard against explaining the activities and peculiarities of animals as though they resulted from some purpose that the animals had in mind. We may be sure only that, to continue to live, an organism must be sufficiently adapted to its surroundings.



FIG. 188. Finding a home for the young
Nest of a bluebird in natural hollow of a tree
(From photograph by L. W. Brownell)

With many animals the boring or burrowing is related altogether to protection, as with animals that bore into rocks (Fig. 186). From our own point of view the safety obtained by an animal boring into a rock would seem to be purchased at the price of liberty. But we may be sure that from the piddock's point of view this trick of boring into the rock causes no ill feeling. There is safety, and there is the possibility of getting food as well, for the long siphon projects into the



FIG. 189. Prairie dogs

These animals dig burrows underground and live in large colonies. (From photograph by Elwin R. Sanborn)

ocean and a constant current of water brings oxygen and food, and carries off wastes and reproductive cells (see Fig. 44).

When we come to the highest animals (the insects) of the branch arthropods and the highest animals of the backboneed branch (birds and mammals), we find very complex activities related to the making of homes. The solitary wasp goes no farther than burying a few insects that later serve as food for the young. The social wasps and hornets, like the related bees and ants, build very elaborate homes out of "paper" (which they make from wood pulp and other materials) and out of wax and earth (see Fig. 187).

Nest-building among the birds involves complex instincts, and possibly in some cases a degree of real intelligence. From the crude whisks of the grouse, or the simple mud heap of the flamingo, to the delicate and skillful work of the tailor bird, we find a long series of nests of many degrees of complexity in structure. But with the exception of homes made in hollows, like that of the woodpecker, whatever shelter nests may furnish serves almost exclusively for the protection of the young (Fig. 188).

Indeed, we may say that the making of shelter among the higher animals is closely related to the protection of the young,

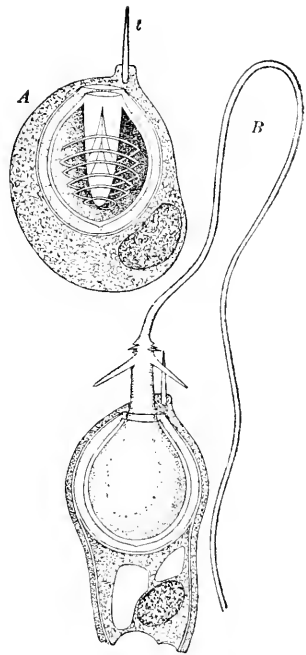

FIG. 190. Netting cell of jellyfish

This specialized skin cell, *A*, contains a fine coiled thread suspended in a capsule of acid fluid. When the surface is disturbed at the trigger, *t*, the coil suddenly straightens out, shooting the sharp needle into the surrounding space, and at the same time the acid fluid from the cell passes through the hair. The stinging sensation is probably produced by this fluid. *B*, the discharged cell

or of a group, rather than to the protection of the individual. This is seen in the constructions of such animals as the



FIG 191. Praying mantis

This animal lies in wait for its prey with the front legs raised in a manner suggesting the attitude of prayer. It catches small insects with its strong front legs. Large species living in the tropics have been known to kill small birds. ($\times \frac{1}{2}$)

beaver or the prairie dog (Fig. 189), in the hutch of the rabbit, in the diggings of the mole, and in the nest of the mouse.

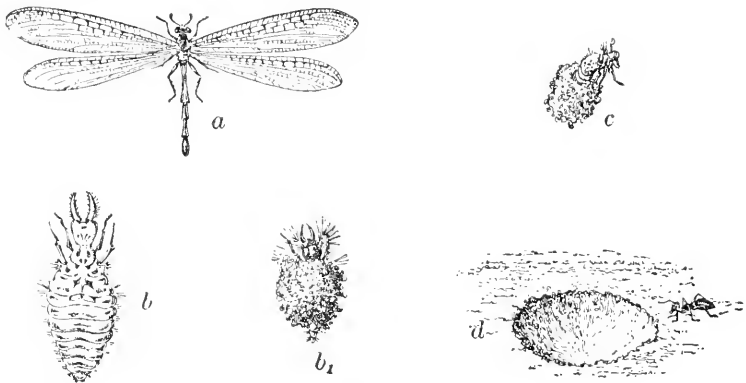

FIG. 192. The ant lion. (Natural size)

a, adult; *b*, larva; *b*₁, larva covered with dirt; *c*, incased pupa; *d*, pit in sand. The larva buries itself in loose sand at the bottom of a small pit. Ants and other small crawling insects tumble into the pit and are seized by the strong jaws of the ferocious "lion"

412. Fighting. Nothing would seem to be more helpless and less offensive than the soft-bodied jellyfish; the very name

suggests something even milder than a clam. But if you have ever picked up a live jellyfish, you may have thought that a

million needles had been shot into your hand. The skin of the jellyfish contains a large number of special cells in which there are fine hollow threads that shoot out when the animal is disturbed (see Fig. 190). These "nettling cells" are found in many species of cœlenterates, such as the hydra, sea anemone, coral polyps, and sea walnuts.

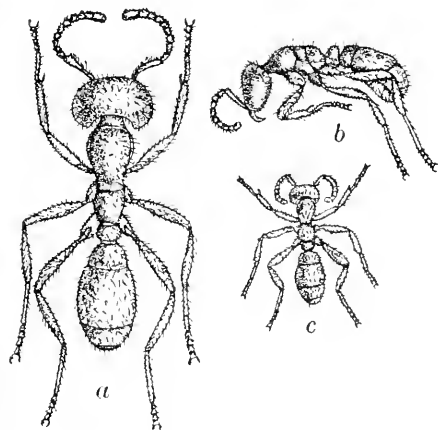

FIG. 193. Fighting ants

Three forms of the Central American ant *Cheliomyrmex nortoni*: a, soldier; b, medium worker; c, small worker

electric shock when they are disturbed, and this is no doubt of value in protecting them. The animal that has been shocked quickly lets go and learns to let other shockers alone.

But some animals, like the ray, do give their enemies a real



FIG. 194. The sting of the bee

In this order of animals the weapon is the egg-laying organ. When the bee stings someone, the point is likely to remain in the flesh; and as the animal flies away, some of its internal organs are mutilated and the insect soon dies. The value of this weapon is not so much for the protection of the individual as for that of the colony or species. The individual is sacrificed to protect the group or to educate the enemies of the species

Another way in which the organism can make itself disagreeable to an enemy, without really producing serious injury,

is illustrated by the skunk. This animal, as everyone knows, is capable of ejecting a foul-smelling liquid from a gland at the rear of the body when it is greatly agitated.

Real fighting appears among animals that have mouths and appendages that are capable of grasping. These organs are at

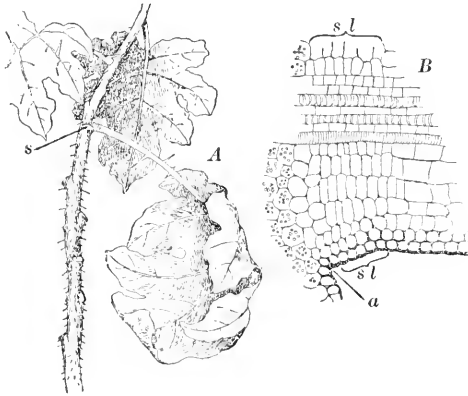

FIG. 195. The fall of a leaf

A, leaf dropping off; *s*, self-healing scar remaining on twig; *B*, microscopic view of section through base of leafstalk; *a*, angle between base of stalk and twig. In plants that regularly drop their leaves in the autumn there is formed a special layer of cells in the stalk of each leaf, and sometimes of each leaflet of a compound leaf. These cells, *sl*, are thin-walled and turgid. Their contents break down into a mucilaginous mass, which dries up. A slight movement is now sufficient to break the fibrovascular bundle at this point, and as the leaf is removed the exposed surface becomes a self-healing scar

at the same time food-getting organs. Lobsters and crabs are very pugnacious animals, or at least that is the impression they make upon the observer. Most of the mollusca (clams, oysters, scallops, etc.) depend on their armors for defense against possible aggressors; some of them, however, as the octopus, are very good fighters (Fig. 95).

Among the insects many are predatory, using their appendages (Fig. 191) or their mouths (Fig. 192) in catching prey. But very few use these organs in fighting their enemies. The colonial insects, especially the ants, furnish the best examples of this mode of protection (Fig. 193). The bees, wasps, and hornets fight when they are disturbed or when the colony is disturbed, but in fighting they use the sting (see Fig. 194), which has nothing to do with food-getting or with locomotion.

The horns of mammals are associated with the instinct to defend or fight, and are quite independent of the organs or

instincts that have to do with the getting of food. Thus, while the ferocity of the tiger or the dog finds expression through organs that are related to food-getting, the strictly vegetarian rhinoceros or mountain sheep will fight fiercely and courageously with horns or hoofs. The branching horns of the deer or elk seem never to be used aggressively except against members of their own species, as when two males are in combat.

413. Shedding of leaves. The dropping of leaves in the autumn, while it does not involve movements like those of muscles, may properly be considered a protective act.

The shedding of leaves seems to be related to the water factor as well as to the temperature factor, which we usually associate with the change of seasons. As the autumn advances and the water in the soil becomes

scarcer, transpiration is interfered with. Evaporation from the leaves, however, continues so long as there is water in the cells. If the loss of water cannot be compensated by the absorption of the roots, the live cells of the plant must suffer injury. The leaf cells are the first to be affected. The loss of the leaves prevents the complete drying up of the plant, and it also prevents the freezing of live cells (see Fig. 195). The relation of water to the fall of the leaf has been determined experimentally.

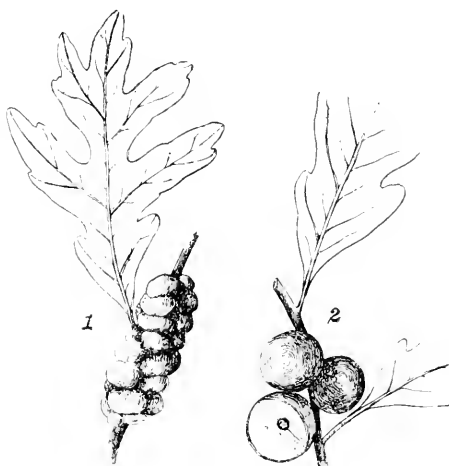

FIG. 196. Insect galls

It is probable that by the formation of such galls many plants are really protected against serious injury, although many of the galls may simply represent the behavior of protoplasm when injured in a certain way, rather than a useful way of behaving. It is interesting to note that the galls are always specific. Thus, both of these galls are on the same species—the white oak (*Quercus alba*)—but are produced by different species of insects: 1, by *Biorhiza forticornis*; 2, by *Holcaspis globulus*.

414. Insect galls. The response of plants to special mechanical and chemical disturbances is illustrated by the formation of the so-called *insect galls*, some of which are shown in Fig. 196. Many insects sting plants and suck juices from them for food. The common mosquito is an example, and the plant lice are sometimes parasitic to a degree that is very harmful. But many insects sting plants with their egg-laying organs and deposit the eggs in the tissues of the plant. Associated with the process of egg-laying there is often a secretion of some juice from the insect's body. The mechanical or chemical injury thus produced is probably very slight; but the young that hatch from the eggs deposited in the tissues of the plant begin to feed, and the injury that they do is likely to be of a more serious nature. We find that many plants begin to grow rapidly about a point at which insects have laid eggs, forming casings of various shapes and structures about the mass of eggs, and eventually about the young insects. Within these galls the insect larvæ find a limited amount of food, and they are cut off from the rest of the plant.

CHAPTER LXX

THE FOREST IN RELATION TO MAN

415. Forest products. Man depends in many ways upon masses of trees growing together as forests. It is from the trees that we get one of the most useful of materials — wood. This is utilized in hundreds of ways, from the making of tooth-picks and tool handles to the timbering of mines or the making of stock for newspapers. All human habitations have some wood in their composition, and probably most people live in houses built almost entirely of wood. Every home has furniture made at least in part of wood; and in every industry, and in every office, furniture and appliances made of wood are used.

In the railroad business millions of dollars are spent every year for the ties upon which the rails are laid. Similar amounts are spent upon telegraph poles and fence posts, although these are coming to be replaced by reinforced concrete and other materials. In shipping goods of all kinds from place to place millions of feet of lumber are used up, in the form of packing cases and boxes and trunks.

In addition to the wood obtained from the trees these plants furnish us with charcoal, turpentine, pitch, wood alcohol, sugar, and various gums and resins. From tropical trees we obtain rubber and quinin. To some extent the dye logwood is holding its own against the anilin blacks, and during the Great War dyewoods took on a renewed importance, because of the changes in the chemical industries. Bark is taken from certain trees, especially the hemlock, to be used, for the tannin it contains, in the tanning of leather.

The use of wood as fuel is coming to be restricted more and more, as we find it more profitable to burn coal, gas, oil, etc., and to use the wood for other purposes. But every forest and every wood lot produces annually large quantities of wood that cannot be used in the making of paper or of other useful things, and this may well be burned.

416. The forest and the air. Another use of the forest is found in the fact that through photosynthesis fresh supplies of oxygen are thrown into the air, replacing the carbon dioxide. In addition to this, the transpiration may be considered a

help in that it keeps down the temperature of the plants and so of the surrounding air. The shade value of trees is highly appreciated in the summer time even by city dwellers, and the effect of trees in breaking the wind is appreciated in the winter time, especially by those living in the country.

417. The forest and water. The most important relation of the forest

to man, aside from the direct utility of the forest products, is in its effects upon water. When we compare the action of rain water and snow on a hillside covered with trees with the action upon a similar hillside devoid of

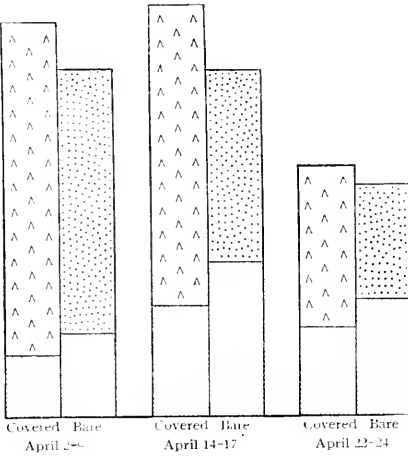

FIG. 197. The relation of the forest to water flow

In experiments made by government agents a comparison of a covered area with one devoid of trees showed (1) that in a given period the covered area accumulated more snow than the bare area (this is shown by the relative heights of the two columns in each pair), and (2) that in a given period the bare area lost more water than the covered area (this is shown by the relative heights of the shaded portions in each pair)

vegetation, we can realize the practical importance of the forest in relation to our water supply. On the bare hillside the water soaks down into the soil almost as fast as it falls, or it runs off, carrying particles of earth along in its course. On the covered hillside the force of the falling raindrops is broken by the leaves of the trees, from which the water slides down to the ground along the twigs and larger stems. The rain

that strikes the mulch¹ soaks through slowly; then, in the entangled soil beneath, it steadily works down to form the underground streams and the springs. Snow in the forest melts slowly and is gradually absorbed in the spongy bed beneath; from this the water slowly escapes into the springs and underground currents. Snow upon the bare ground runs off as fast as it melts.

Actual proof of the difference was furnished a few years ago by an extensive experiment conducted by the United States Geological Survey in the White Mountains. Two similar areas were selected, each covering about five square miles. One of the regions had been entirely cut down and burned over; the other retained the virgin forest (Fig. 197).

The practical bearing of these facts is not hard to understand. Every year, as the snows on the hills begin to melt, the water rushes down the hillsides in the deforested regions, causing the streams to overflow their banks and the torrents to tear down and destroy everything in their path. The annual damage done by floods in this country is estimated to be equal to one hundred million dollars. This does not include the destruction of human life that is often involved in the floods.

Streams depending upon deforested areas for their water will be too full in the spring and will run too low in the summer. Water used for agricultural purposes must be had in abundance throughout the summer, and the destruction of forests in one region has often resulted in the ruin of agriculture and the migration of peoples in a distant valley. Navigation on the larger streams is influenced by the forest in two ways: the steady flow of water is maintained by a proper condition of the forest, and the filling up of the stream by soil is at the same time prevented.

¹ The mulch forms a soft, absorbent carpet, consisting largely of decaying leaves and other organic matter.

418. Water power. As our industrial civilization depends more and more upon the use of machinery, we are pressed to find sources of energy for driving the machines. The consumption of coal has increased so rapidly that the exhaustion

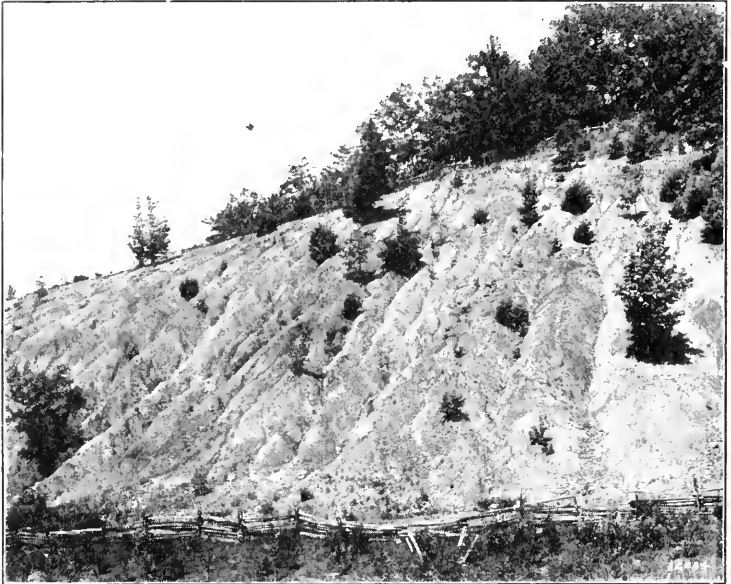

FIG. 198. An eroded slope in western North Carolina

On slopes from which the vegetation has been removed the rains and melting snows produce destructive effects of great practical importance. (From photograph by United States Bureau of Forestry)

of the earth's supply is threatened. Water power seems to be the only source of energy that is constantly renewing itself at a sufficiently rapid rate. But to maintain the service of waterfalls we must be sure of the steadiness of the water supply, and this in turn depends upon the forest.¹

¹ When we burn coal as fuel we are of course again dependent upon the forest (though not the forest of our own times), since all coal consists of the modified remains of ancient vegetations.

419. Soil and forests. The relation of the forest to the soil is also of great practical importance. Every year the streams and rivers carry down to the sea a quantity of earth estimated to be worth over a billion dollars. This is not only a direct loss of agricultural resource; it also interferes with the navigation of streams and with the conditions of harbors. Millions of dollars are spent every year dredging harbors in this country, to remove the soil deposited by the streams coming from deforested regions. And, finally, the millions of dollars spent in reclaiming desert land would all be wasted but for supplies of water drawn from regions covered with forest.

420. Forest control.

Because of our dependence upon the products of the forest, as well as upon the water and the soil that are so much influenced by the living trees, the proper control of the forest becomes a matter of national concern. We cannot depend upon the private owners of forests to handle these in such a way as to secure to the general population the full benefits and protection that are necessary. Ordinarily the owner of a forest cares only for what he can get out of it,



FIG. 199. A good stand of trees, Lake Placid, New York

Forest areas in good condition not only furnish invaluable materials, but protect the soil and insure a steady supply of water. (From photograph by United States Bureau of Forestry)

and he cannot be expected to take into account effects a hundred miles away or fifty years away.

The Forest Service of the United States Department of Agriculture has made many careful, scientific studies of forest conditions and has thus been able to give sound advice on the care and management of forests and wood lots from every point of view. From these investigations we learn, first, the importance of avoiding certain injuries to the forests, and, second, the methods of increasing their value.

For many years, toward the end of the nineteenth century, the people of this country were using up trees about three times as fast as they could grow. This meant that before very long we should have destroyed all the usable trees and been practically without a suitable wood supply. A scientific study of the growth of trees in the forest showed that it is possible to get all the wood we really need without destroying our forest, if only certain principles are followed (Fig. 200).

It is to be noted that the ordinary virgin forest is practically at a standstill so far as growth is concerned. While new growth is constantly taking place, this is only enough to offset the death and destruction among old trees.

421. Increasing forest area. To meet the growing need for more wood, it is possible to extend the forest area of the country. Areas that have been cut and burned over may be reforested, and this process is under way in many parts of the country. There is a great deal of worn-out agricultural land and sand-dune land that would be well suited to forests; in many cases all that is needed is to protect the young growth against fires. Another method of extending the growth area is by fuller stocking of existing forest lands. Thus, some trees are found growing so close together that they never become thick enough to be of great value for timber; but in other forests the trees are so far apart that valuable space is allowed to go to waste. By selecting trees suitable for a given region, and starting the young plants rather close together, and then thinning out carefully, the amount of timber grown on a given area can be greatly increased.

422. Increasing wood yield. Another method for increasing the wood supply is by the selection of varieties that will give a maximum of growth in each forest area. It is likely that not more than seventy

of the 500 native species in this country are worth growing from the economic point of view. The red cedar grows very slowly; the white pine or the red oak could be grown in the same soil to great advantage. We could replace the red spruce in New England by the Norway spruce, just as many areas of France denuded by the Great

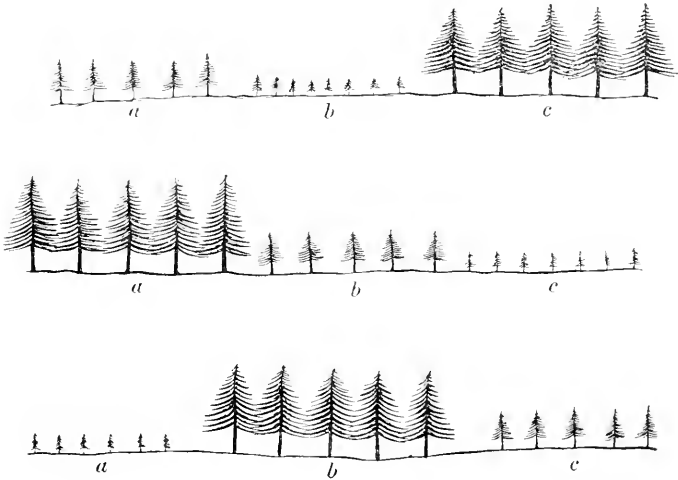

FIG. 200. Cutting trees to preserve forests

The preservation of the forest does not mean simply to avoid cutting timber. By cutting trees in zones at intervals of a number of years, and by thinning out the trees where they are too crowded, it is possible to make a given area yield continuous crops of wood. The zone *a* was cut first, then zone *b*, and so on. By the time the last strip has been cut, the trees on the first strip are well along, and thus a succession of cuttings may be continued indefinitely

War, and other European regions, are being restocked with Douglas fir imported from this country. We shall no doubt find foreign trees better suited to our purposes in many localities than the native trees. In the course of a number of years the rapid varieties will yield much more timber than the others. But rapid growth is not of itself a deciding factor, for it is necessary to consider the toughness of wood and other qualities. The whitewood, or tulip tree, grows much faster than the oak, but it can never be used as a substitute for the oak.

423. Improving wood quality. Another improvement is being brought about by the selection of varieties for quality. Without

increasing the actual amount of growth, it is plain that the value of the growth can be increased if the trees do not have curved or twisted trunks or branches. By selecting straight-growing varieties and by concentrating the growth in the best trees (by thinning out the least desirable ones) it is possible to increase the yield of a forest area.



FIG. 201. United States forest reserves

The economy of national control of forests, as well as the protection of public interests thereby, has been strikingly demonstrated since our entry upon the Great War

424. Avoiding wood waste. In the national forests the lumbermen are given a practical demonstration of the value of scientific cutting, seeding, reforestation, etc., and also of the economical handling of growth. Damage to trees often results from careless lumbering. The tree that is being cut down is sometimes damaged, and it is sometimes allowed to injure trees that are left standing. When wood was cheap, a great deal from each tree was left to rot on the ground. Now everything that can possibly be used is saved, and the remaining brushwood is carefully burned, instead of being left under the trees as a constant fire risk.

425. Advantages of public control. The extent of the national forests is shown in the map on page 384. In these forests are conserved and protected the water supplies for more than a thousand cities and towns, for over twelve hundred irrigation projects, and for over three hundred water-power plants. In these forests nearly ten million head of sheep, horses, and cattle graze every year, and in them nearly half a million people find recreation. The forest service sells timber to private users and gives away firewood to settlers in agricultural lands included within the forest areas.

426. Forest dangers. The forest is exposed to four serious dangers :

1. The person who cuts recklessly and destroys for immediate profit what ought to last practically forever. This enemy can be regulated either by enforcing very strict rules as to the uses of private forests or by making it impossible for individuals or corporations to profit at all through the exploitation of forests.

2. Fire. Since this is probably always of artificial origin, it can be controlled through suitable regulation or supervision. In the national forests there are well-organized fire patrols. They have succeeded in preventing many fires and in keeping the total fire damage in the national forest down to a small fraction of what it is in privately owned forests. The rules for fire prevention in forests are posted on trees, and every person who has occasion to go into the woods should heed these regulations.

3. Various species of insects.

4. Various species of fungi. These classes of organisms (insects and fungi) destroy every year trees and timber worth millions of dollars, and there is no one way to fight them all.

427. Other forest relations. The forest is related to human affairs as the home of many animals and of many plants other than the trees. It is in the forest that valuable game and fur animals find their food and shelter, and the destruction of the forest means the extermination of many of these animals.

CHAPTER LXXI

BACTERIA AND HEALTH

428. Bacteria and specific diseases. Before germs can cause disease it is necessary that they enter the body of the host. Ordinarily they cannot get through the skin. The *infection*, or entrance into the body, therefore, takes place through either (1) a cut in the skin or (2) one of the regular openings to the interior of the body, as the mouth or the nose.¹

Fortunately for us, most bacteria do *not* cause disease. We may therefore carry about with us, in our mouths and air passages and food tubes, millions of bacteria without being made ill.

After the middle of the last century the improvements in the microscope and the development of experimental methods made possible the discovery that certain diseases are caused by microbes, and that *they can be caused in no other way*. Since the time of Pasteur, the French chemist who first demonstrated this idea, many physicians and biologists have succeeded in finding the particular species of bacteria connected with some of the most important human diseases, such as tuberculosis, diphtheria, pneumonia, typhoid fever, tetanus (lockjaw), cerebrospinal meningitis, and others. The methods developed in the course of these studies have been successfully used in the treatment and prevention of several other diseases, although the specific organisms that cause these are not known in all cases. For, in addition to discovering that a given species of bacteria is the specific cause of a disease (for example, the typhoid bacillus in the case of typhoid fever), we have found (1) that the bacteria

¹ In some cases the bacteria may act upon tissues without penetrating into the interior of the host, as the diphtheria germ, which lives on the mucous surface of the throat.

leave the host in special ways; (2) that they are commonly transferred to other hosts in special ways; and (3) that they then enter the bodies of the new hosts in special ways.

TRANSMISSION OF COMMUNICABLE DISEASES

DISEASE	HOW GERMS COME OUT	HOW GERMS ARE CARRIED	HOW GERMS ENTER
Chicken pox . . .	Mouth and nose spray	Air	Nose and mouth
Diphtheria . . .	Mouth and nose spray; saliva	Air, objects exposed to spray or saliva	Nose and mouth
German measles . . .	Mouth and nose spray	Air	Nose and mouth
Measles	Mouth and nose spray	Air	Nose and mouth
Mumps	Mouth and nose spray; saliva	Air, objects exposed to spray or saliva	Nose and mouth
Scarlet fever . . .	Mouth and nose spray; saliva	Air, objects exposed to spray or saliva	Nose and mouth
Septic sore throat	Mouth and nose spray; saliva	Air, objects exposed to spray or saliva	Nose and mouth
Smallpox	Mouth and nose spray	Air	Nose and mouth
Tetanus (lockjaw)	Contact	Hands or objects	Breaks in skin
Trachoma	Contact	Hands, towels, etc.	Contact with eyes
Tuberculosis . . .	Mouth and nose spray	Hands, objects, etc.	Nose and mouth, food
Typhoid fever . . .	Mouth, excretions, intestinal waste, and occasionally through skin	Hands, various objects, flies	Food
Whooping cough . .	Mouth and nose spray	Air	Nose and mouth

429. Infection. The table above tells how the germs of a number of common diseases are thrown off, how they are carried about, and how they enter the bodies of the new hosts.

In all essentials the methods of infection and transmission of disease are the same for the domestic animals as they are for man. When we consider that disease is *preventable* just in proportion as we understand the causes and the modes of infection, we may well believe with certain specialists that the study of bacteriology is among the most important contributions of the nineteenth century to the welfare of the human race. In Fig. 202 are given the annual losses due to various diseases, and an indication of the extent to which these may be prevented.

430. Protection against infection. The chief means of preventing infection consists of preventing the contamination of our food by bacteria. This means that pains must be taken as to the exposure of fresh food to dust, to the mouth-spray of people or other animals, and to contact with unclean hands or with containers of all kinds. Many cities now require that all food exposed for sale, such as meat, pastry, confectionery, and the like, be covered against dust as well as against the visits of insects; but fruit and vegetables are still commonly exposed, at least to dust. In the case of fresh fruits or vegetables the peel is usually a sufficient protection against bacteria. But the peel of many vegetables contains very desirable food material, which should not be thrown away. Fruits and vegetables that are cooked are generally safe, since the cooking itself kills the bacteria (see p. 112). But lettuce, celery, and other vegetables that are eaten without cooking have frequently been the means of infecting people with disease, since bacteria in the soil may cling to the plants, and some of the disease-causing bacteria may get into the soil of gardens. Such plants should be thoroughly washed before being used as food.

431. Care of food. The fact that food rots so readily when left to itself shows that it contains the *materials* necessary to maintain the life of bacteria. We should therefore keep it under *conditions* that are not favorable to the growth of these organisms. We have the practical choice between keeping our

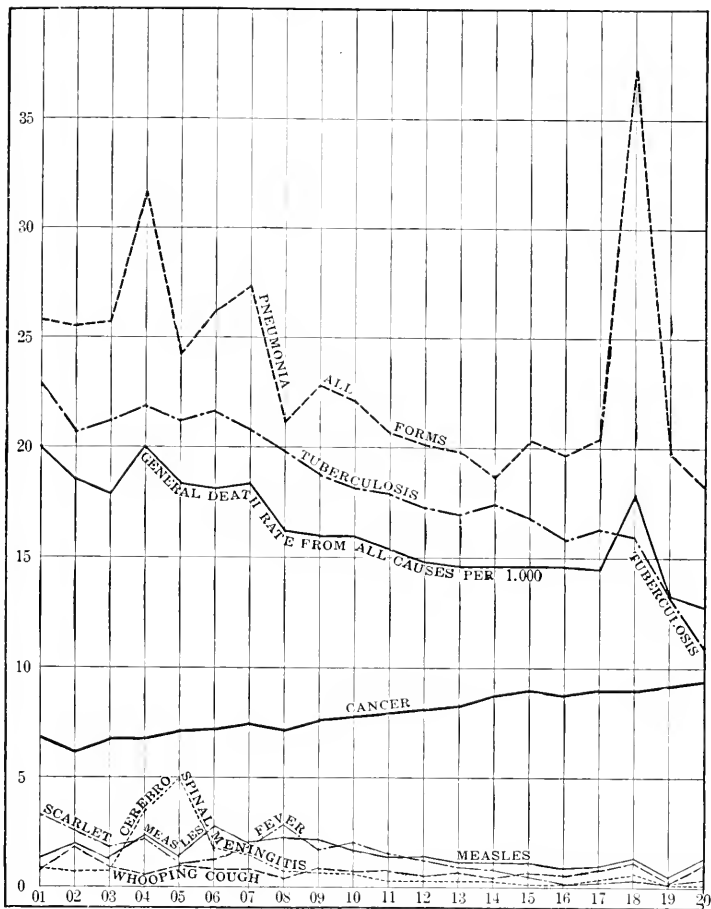

FIG. 202. Mortality rates for various diseases

In the early part of the period the fluctuations are irregular; in the latter part the infectious diseases show a steady decline. There is a steady decrease in the general death rate, and a steady increase in the death rate from cancer. The figures on the left indicate the number of deaths per 10,000 of population in New York City; the figures at the bottom are for the years. The general death rate is on a scale showing the deaths per 1000 for each year. The high point for pneumonias in 1918 represents the influenza epidemic

food very hot or very cold. We are not usually ready to cook our food immediately; meats and vegetables have to be kept for longer or shorter periods before cooking as well as after cooking. We therefore turn to the low temperature as an aid in preserving food against the destructive action of bacteria. Refrigeration has been the means of preventing great loss through the decomposition of food, since at low temperatures bacteria cannot multiply. We must be careful, however, not to assume that well-preserved food from the refrigerator is necessarily free from injurious microbes, since any organisms that may have been present before the food was placed in the refrigerator are still there and are still capable of growing and multiplying when the suitable temperature is reached. It is also necessary to keep refrigerators perfectly clean and free from neglected food particles that may retain bacteria. This principle applies, of course, to all cupboards, pantries, lunch boxes, or other places in which food is kept temporarily or permanently.

Milk, soups, jellies, fruit juices, preserves, and similar food preparations containing a great deal of water are exceptionally favorable to the growth and multiplication of bacteria. They are therefore especially subject to the decaying action of bacteria, and require special care in their handling and storing. In making preserves of fruits or vegetables the chief precautions are concerned with the destruction of the bacteria already present in the materials used, and with the prevention of the entrance of other bacteria. The first end is attained by cooking the materials until the heat kills the germs. The second is attained by placing the cooked material in perfectly clean vessels that can be covered so as to exclude absolutely all bacteria.

432. Milk regulation. The regulations prepared by the health authorities of cities and states for those who have to handle milk take into consideration the importance of milk for human beings, especially for children, and the ease with

which milk becomes contaminated. The conditions under which the cows live make it almost impossible to prevent the hairs and skin of the animal from becoming the bearers of bacteria of many kinds. While the milk in the udder of the cow may be quite free of any contamination, by the time the milk has been poured from the pail to the can it is sure to have many bacteria floating in it. The high temperature makes the multiplication of the organisms proceed very rapidly. By the time the milk is ready for delivery in the city, it contains a large number of bacteria in every drop.

On page 127 are given the rules for the care of milk intended for city markets. There is a biological reason for every rule given, and this should be clear to every student of the subject. It has been found practically impossible to obtain milk in large quantities without excessive numbers of bacteria. For this reason the practice of pasteurization has come into more and more general use. This consists of raising the temperature of the milk to about 140° – 155° F., and keeping it there for from ten to twenty minutes. Pasteurization does not, of course, remove the bacteria; it only kills them.

433. Water supply. Next to milk, the water supply is perhaps the source of greatest danger to the community. In towns and cities that still depend upon separate wells or springs for water the amount of sickness and the proportion of deaths is likely to be much higher than in such places as have a central water supply. To be sure, if the central water supply becomes contaminated, more people are likely to be injured in a short time. But it is easier to control the sanitary condition of one large reservoir than that of hundreds of wells. The bacilli of typhoid fever will remain alive in water for two or three weeks, and are the most frequent disease germs transmitted by water. But other diseases may also be transmitted in this way. The diagram in Fig. 203 shows the reduction in disease and death that was brought about by improving the water supply in the state of New York.

When we consider that the contamination of wells, rivers, and lakes with the germs of disease can be brought about only by discharges from diseased persons (or at least of persons carrying the germs), we see how closely connected are the problems of sewage and health.

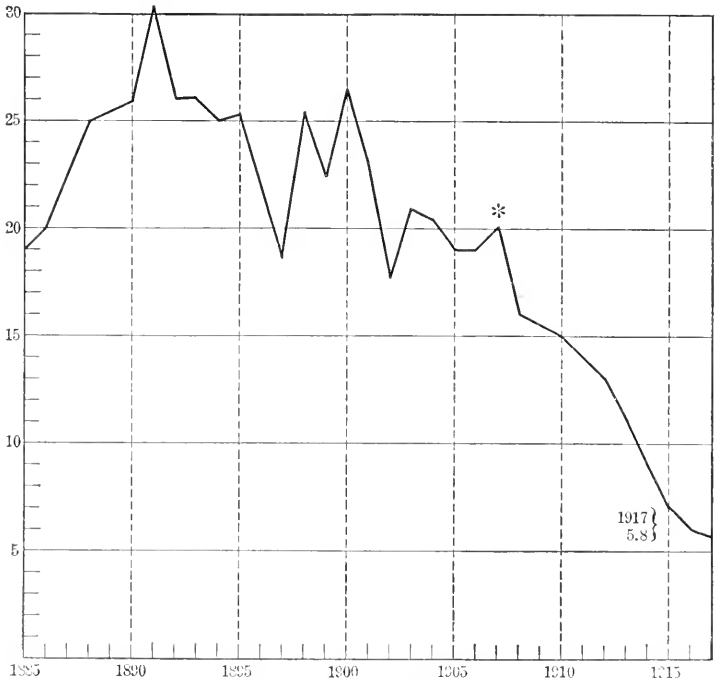

FIG. 203. Typhoid and water supply

For twenty years the deaths from typhoid fever fluctuated between 18 and 31 per 100,000 of the population. Since 1907, when the state authorities (New York) took charge of water regulation, the death rate from this disease has steadily declined

Wherever there is a sewage system, the law should require that every house be properly connected with the sewer. There is unmistakable evidence that the general health is better among people who use modern water closets than among those who do not. It is also certain that the latter are too frequently sources of danger to others in that the contaminations work their way through the ground into the water supplies upon which others are dependent. Thus again we

see the interdependence of people, living it may be at considerable distances from each other or in different states.

Because there is not yet any adequate control over the habits of those who dwell in the country, in the matter of disposing of house soil, garbage, etc., it is important for those who dwell in cities that their water supply be properly guarded, if not at the source, then through suitable filtration or sterilization. All these activities, and many others, suggest how human life is constantly influenced and modified by the activities of these minute yet significant organisms.

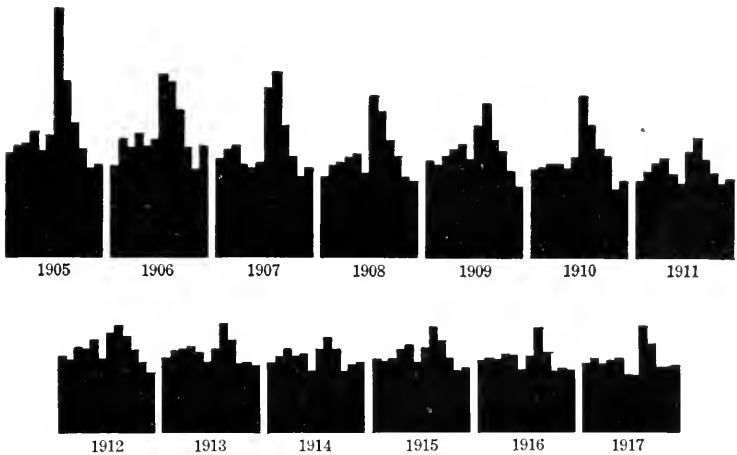

FIG. 204. The reduction of infant mortality in New York City

This diagram shows, month by month, for a period of thirteen years, the proportion of infants (under one year old) who died to the infants born. There is a variation from month to month, with a very striking increase in the number of deaths during the summer months. When the records showed this big jump in 1905, physicians and nurses and sanitary experts at once took steps to discover the causes and to devise preventive measures. Year by year we can see a steady improvement. So much effort has been made to protect the children for the bad month of July, that in recent years this month has showed off rather better than the others, and August and September have become the bad months. With increased knowledge, and especially with wider application of the knowledge we already have, the high points on these black spots will be cut down, and the general level of the spots will be considerably lowered. This is but another way of showing that applied biology saves hundreds of thousands of lives

CHAPTER LXXII

CONTROL AND USE OF BACTERIA

434. Health and the public. As fast as we realize that our health depends upon the control of outside conditions, we extend public regulation to many matters that were formerly considered purely private and individual. A bare list of the points in regard to which public and official action has been taken will indicate how widespread are the influences of bacteria, and how far progressive communities have gone in the attempt to control public health.

Not every town has adopted regulations in regard to each of the matters mentioned in the lists below, but on each point several towns and cities (or states) have adopted definite regulations calculated to protect the public health.

In regard to food in general, the methods used in preparing, handling, and exposing for sale have been regulated. In addition there are special regulations regarding the following:

1. Bakeries: conditions of work, ventilation, lighting, cleanliness, etc.; the wrapping of each loaf of bread before removal from the factory.
2. Slaughterhouses.
3. Ice cream.
4. Soft drinks: conditions of sale, cleaning of glasses.
5. Restaurants: condition of kitchens, cleaning of dishes, etc.
6. Drinking cups in public places.
7. Milk, butter, and other dairy products.
8. Public water supply.
9. Compulsory vaccination of school children.
10. Marriage of persons suffering from certain diseases.

All of these matters are related to health because they have to do with special kinds of disease microbes.

For the purpose of enabling the public to measure from time to time the progress (or the reverse) in matters of health, population, etc. many states and cities require the registration of all births as well as of all deaths, and the notification of the health authorities in every case of contagious or infectious disease. By means of records thus obtained the public is helped in protecting itself. Many diseases are subjected to quarantine and placarding. There are provisions for supplying vaccines, serums, etc. through public laboratories, and for supervising the manufacture and sale of such preparations for profit. There are laboratories for making accurate examinations of blood and other specimens obtained from patients for the purpose of diagnosis. Provision is made for disinfection of discharges from the bodies of sick people; vaccination where needed; inspection of schools and factories to determine sanitary conditions; exclusion of sick persons from schools etc. In some places there are visiting nurses, ambulance service, and hospital service, all helping to keep down the amount and the intensity of sickness.

The activities of various classes of workers are regulated in the interests of public health. Licenses are required of physicians, dentists, druggists, nurses, and midwives. Rules are provided to guard against the transmission of bacteria in barber shops and through manicurists and masseurs.

The keeping of animals within city limits — dogs and cats, as well as horses, cows, and poultry — is regulated for the purpose of preventing the multiplication and spread of bacteria. In many cities dogs have to be muzzled; this device must eventually eliminate all rabies from towns, since this disease is transmitted by the bites of dogs. The burial or other disposal of dead animals is also regulated.

Lodging houses, tenements, and workshops must provide suitable conditions of light, ventilation, and plumbing. Plumbing

and drainage are subject to regulation, as well as the disposal of garbage, household and industrial refuse, ashes, etc. In many towns the scattering of ashes or other dust and the pollution of the air with smoke are treated as public nuisances.

The prohibition of spitting in public places has come to be a matter of course in all wide-awake communities, and the same is true of the use of public towels. The public is also coming to insist that street cars, boats, and other public conveyances be kept thoroughly clean and sanitary. In many towns the public is making provision for baths that are either entirely free for all to use or open for a nominal fee.

435. Uses of bacteria. We have studied the changes that bacteria produce in dead organic matter, making the elements of the latter again available for the living plants, and so for animals. We have also noted the importance of certain bacteria in making the atmospheric nitrogen available for our growing crops.

There is still another way in which bacteria make dead organic matter in the soil and in waters available as food. The bacteria themselves, feeding upon the dead remains, are in turn eaten by various protozoa and other minute animals. These are then eaten by larger animals, and so on until we get to forms that are large enough to serve as food for man, as shrimps, clams, fish, etc.

436. Bacteria in industry. The decay caused by various bacteria is utilized directly in the preparation of sponges for commerce. The sponges are allowed to lie in tanks of water until the dead cells are completely destroyed by bacteria. They are then washed clean, leaving the horny skeletons with which we are familiar. A similar process, involving the activity of different kinds of bacteria, is employed in the "retting" (really "rotting") of the soft portions of flax and hemp stalks, to facilitate the separation of the fibers.

The action of bacteria enzymes is used in the making of vinegar out of eider, wine, or other liquids containing alcohol.

In these liquids the oxidation of alcohol is due to the action of bacteria. In the making of sauerkraut and other kinds of pickles, as well as in the curing of silage, bacterial fermentation is used. In the work of the dairy, from the souring of the milk and cream to the curing of cheese, bacteria are used at several points. Cheeses of the Cheddar type and various cream cheeses, as well as butter, depend for their flavors upon the particular species of bacteria present during the souring.

It is very likely that bacteria play a part in the curing of tobacco and in the making of hay, although the problems connected with these processes have not been thoroughly worked out as yet. In the preparation of indigo dye from the extracts of certain plants of the bean family, it is likely that an oxidizing ferment from certain bacteria performs an essential part of the work. In the preparation of hides for tanning, certain of the changes are brought about by bacterial ferments.

In the disposal of sewage in large cities, a process of converting the decaying mass of organic matter into harmless or less offensive forms through the action of bacteria has come into extensive use. The sewage is collected in large tanks. After the fermentation the "sludge" may be used as a fertilizer.

CHAPTER LXXIII

INSECTS AS SPREADERS OF DISEASE

437. Insects eat. About one half of the different kinds of animals known to man belong in the class *insects*. This class of animals is spread over most of the earth's surface, and many of the species live in water (although all are air breathers). In every main division of the class are to be found species that are closely related to human welfare in one way or another.

Most insects are known to us chiefly as *caters*; and they eat either materials that are of use to us, or they prey upon plants or animals that are of use to us.

Like other animals, man is exposed to the attack of insects in search of food. Many species of fleas and lice, of bedbug and horsefly, of midges, black flies, and mosquitoes, have made themselves obnoxious to man by sucking his blood, by causing more or less serious irritations of the skin, and, as we have discovered only in recent times, by infecting him with microbes capable of causing more serious injury.

438. Insects move about. As carriers of disease, insects are related to us in two different ways. The first is illustrated by the common house fly, which has been shown to carry various bacteria, protozoa, and the eggs of parasitic worms on its legs and proboscis, and to leave these germs where they have a good chance of entering the body of some human being.

Experiments have shown that the *number and kinds of bacteria* clinging to the feet of flies depend altogether upon the kinds of places in which the flies live. Flies caught in dirty streets showed more than those caught in clean streets; those caught in a pigsty showed more than those caught in the open, and flies caught while feeding in a swill barrel showed many millions of bacteria.

The habits of the fly are such that we cannot afford to be associated with this animal in any way whatever. The female lays her eggs in horse manure; but where there is no horse

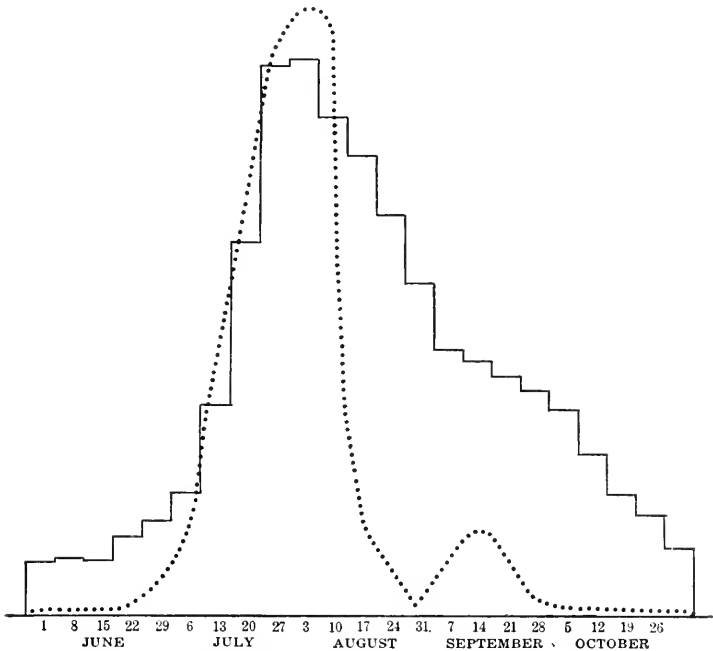

FIG. 205. Flies and intestinal diseases

In New York City a careful study was made (1907-1908) to find the relation between the prevalence of flies and the amount of typhoid fever. The height of the dotted line corresponds to the number of flies caught in traps, week by week, from the beginning of June to the end of October. The solid line corresponds to the number of people who died from intestinal diseases during the same period in the same districts of the city. Typhoid is most frequent where and when flies are most abundant, and there is a direct connection between the insects and the distribution of the disease

manure, she will use cow, sheep, pig, or chicken manure, or decaying fruit, fish, meat, or vegetables, — ordinary garbage, for example, — or any mass of decaying organic matter. The adult fly will visit, for feeding, not only such materials as have been mentioned, but all kinds of perfectly good food that may be

exposed in groceries, meat shops, kitchens, restaurants, dining rooms, or picnic grounds. Flies will visit open wounds or sores on the bodies of animals, and they will visit the excrements of man and other animals. We may thus see what excellent opportunities this animal has not only to collect a varied assortment of bacteria but also to distribute them widely.

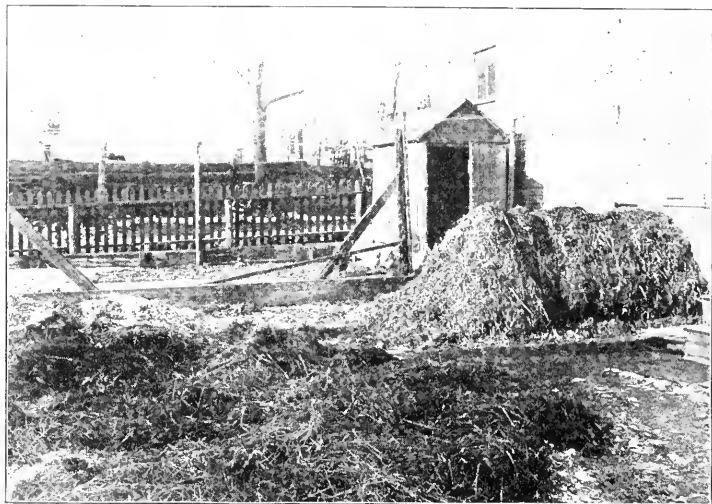

FIG. 206. A breeding place for house flies

The community that saves itself money or trouble by permitting back yards of this kind usually pays for its economy and indifference with disease and death. With the economies of motor cars and traction engines must be reckoned the reduction in typhoid fever and other fly-borne diseases

From a report made by an army commission as to the causes of epidemic fevers in the army camps during the Spanish-American War, we learn that "flies swarmed over infected fecal matter in the pits and fed upon the food prepared for the soldiers in the mess tents. In some instances where lime had recently been sprinkled over the contents of the pits, flies with their feet whitened with lime were seen walking over the food." We can readily understand why it was that more soldiers were killed by intestinal diseases than by Spanish bullets.

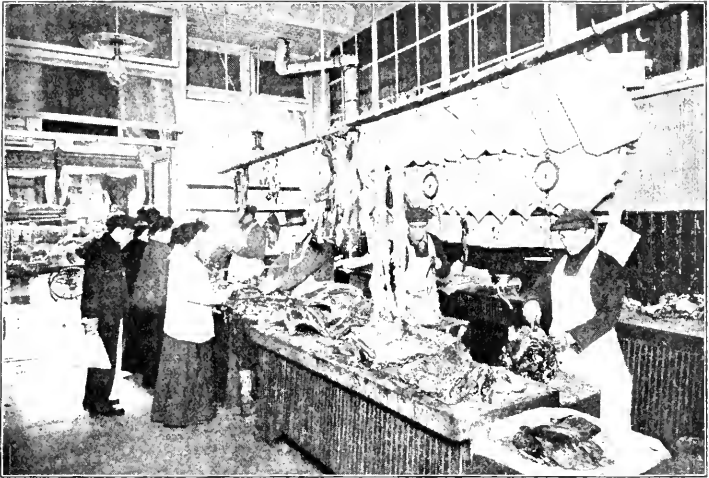

FIG. 207. Food exposed to the visits of flies



FIG. 208. Food protected from flies

Many food dealers have gone to the expense of installing equipment to protect their customers from the danger of contaminated food. Whether the dealer can afford to do this or not, the public cannot afford to leave its food exposed

439. Fighting flies. Just as soon as we realize the relations of the house fly to mankind, we are likely to be seized with a hatred for the whole tribe of flies; and perhaps we may be tempted to "swat" every fly that we see. But if we all swatted flies, and did only that, the fly pest would hardly receive a serious check; for flies breed faster than you and I can kill them, and there is nothing to prevent the flies raised in the stable down the street from coming into our yard.

We have to attack the insects before they are old enough to fly about; that is, we must prevent their breeding by either removing or destroying, screening thoroughly, or poisoning, all materials that may serve as food for the maggots.

The struggle between man and the fly is not a single-handed one,—that of a particular person against a particular fly. It is a struggle of one species against another, and we must carry on our end of the fight through community or group action. Better than *swatting* the fly is the complete elimination of the insect from all places inhabited by human beings.

Many towns have undertaken to exterminate the fly. It has been found that the most effective method is to provide for the systematic removal of garbage and stable manure at least once a week,¹ and to keep streets, back yards, markets, and kitchens perfectly clean.

On the farm or in a village, stable manure can be profitably spread out upon the ground, in field or garden, every day or two. The manure spread out will dry quickly and be incapable of breeding flies. Exposure to sunlight will kill eggs and maggots. In larger towns and cities there should be no difficulty in organizing the work of removing manure and garbage frequently at a comparatively low cost, since the manure is worth gathering for fertilizer and the garbage has a definite commercial value. Where the amount of garbage or manure accumulated is so small that its removal is

¹ The life history of the fly covers a period of ten days.

relatively expensive, arrangements should be made to screen it so that no flies can reach it ; but screening is very expensive and seldom entirely satisfactory.

Lime, crude oil, copper sulfate, formaldehyde, and other poisonous substances have been used in the treatment of garbage and manure to prevent the breeding of flies. But such treatment is in general undesirable, because it makes the manure and garbage worthless for use as fertilizer, since it prevents also the fermentative action of bacteria, which is necessary to make available the elements of the organic compounds for plant growth. Borax and hellebore can be used so as not to injure the manure.

Until a community succeeds in eliminating the flies, it is well for every household to protect its own food supply by suitable screening of the house and by special care in regard to the exposure of food. Every purchaser of food can help by systematically refusing to patronize dealers whose premises harbor flies. And we can all help by keeping our own premises clean and free from these insects.

CHAPTER LXXIV

INSECTS AS INTERMEDIATE HOSTS

440. Malaria. Of all the diseases from which man suffers, malaria is said to be the most widespread, occurring all around the earth as far north and as far south of the equator as mosquitoes may be found.¹ The disease is caused by any one of three or four species of protozoa related to the ameba and known as the *plasmodium* of malaria. The animal feeds upon the red corpuscles of the blood of its host, and then *sporulates* (see p. 294). The spores enter new corpuscles, and the process is repeated indefinitely, greatly weakening the victim and sometimes ending fatally.

The parasites were seen in the blood of patients by the French scientist Alphonse Laveran, working in Algeria. He succeeded in infecting subjects with the blood of sick people, but he could not find out how the infection takes place naturally. It took twenty years more of careful research and experimentation to establish the fact that the mosquitoes of the genus *Anopheles* are the agents of infection.

Two English physicians, Sir Patrick Manson and Dr. Ronald Ross, helped in the establishment of this important fact by tracing the behavior of the parasite in the bodies of mosquitoes. Finally, in 1900, an elaborate experiment was conducted by scientists coöperating in England and Italy. In this experiment a number of volunteers lived in the Roman Campagna, a region that had long been notorious for being full of malaria. But the volunteers lived in houses that were carefully screened against the entrance of mosquitoes. They were also careful not to go out in the evening (when the *Anopheles* is about)

¹ It has been estimated that in the United States the money cost of malaria has been as much as one hundred million dollars a year. This takes the form of time lost from work, the cost of drugs, nursing, and medical service, the unavailability of much fertile land, and so on. In India this disease kills over a million human beings a year, besides causing untold misery to millions of others.

without wearing veils and gloves. Thus they lived through the most dangerous part of the year, from early in July until late in October, and not one became sick, although many of their neighbors became

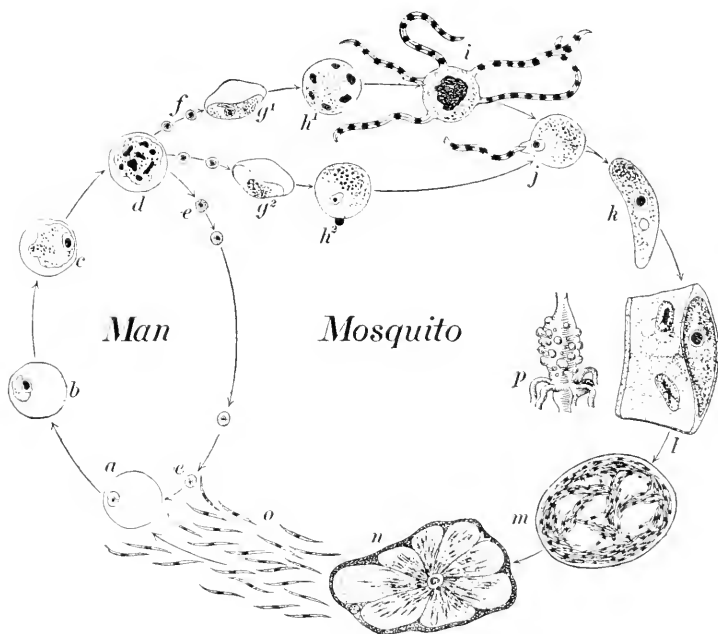

FIG. 209. The malaria parasite

The parasite attacks the red blood corpuscle of a human being, *a*, and when it has destroyed the corpuscle, *d*, it breaks up into a large number of spores, *e*, which may enter other corpuscles and start a new cycle. When blood containing the malaria organism, *f*, gets into the stomach of a mosquito (*Anopheles*), the protoplasm undergoes various changes, *g*, *h*, resulting in two sexual forms, *i*, *j*, which conjugate and produce a fertilized egg, *k*. This works its way into the wall of the insect's stomach, *l*, and breaks up into a large number of tiny bodies, *m*, which finally lodge in the insect's salivary glands, *n*. When the insect again stings a person, some of these bodies, *o*, get into the victim's blood and find their way into the red corpuscles, *a*, and the cycle begins again. *f*, stomach of infected mosquito, showing swellings produced by the parasite

infected with malaria during the summer. At the same time some mosquitoes were caught and allowed to suck blood from persons suffering from the disease. These mosquitoes were placed in little cages and shipped to England. Here two young men—one of them the

son of Dr. Manson — who had never suffered from the disease, and who lived in a region where there were no cases of malaria, allowed themselves to be stung by the suspected mosquitoes. In the course

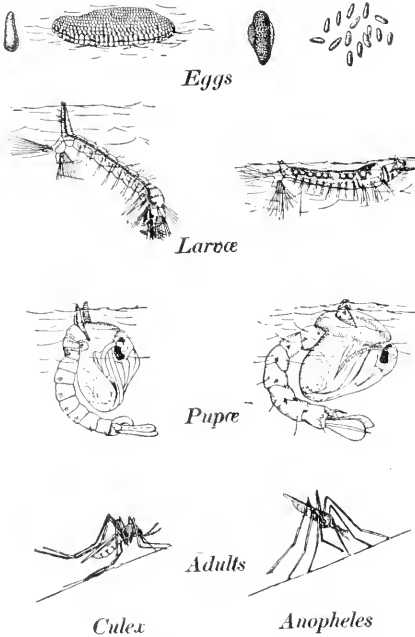

FIG. 210. Mosquito life histories

The mosquitoes of the genus *Anopheles*, which transmit malarial parasites, differ from the common *Culex* in every stage. We can readily distinguish the adults of the two genera by the fact that when at rest the *Culex* holds its body parallel to the resting surface, whereas in *Anopheles* the hind end of the body is farther from the resting surface than the head

of a few days both developed the characteristic symptoms of the disease. This experiment showed that the night air and the vapors from the swamps of the Campagna were harmless, and that the sting of a mosquito that had once bitten a person with malaria was dangerous. Mosquitoes raised from the eggs and allowed to sting a person do not cause the disease to appear. Drinking the water in which the mosquitoes developed does not cause the disease to appear. These conclusions were later confirmed by further experiments, so that to-day there can be no doubt as to the relation between the mosquito and the transmission of the disease (see Fig. 209).

The most common species of mosquito found in various parts of this country belong to the genus *Culex*. This is a nuisance, but, so far as known, does not transmit any disease to human beings (Fig. 210).

441. Yellow fever. This disease is found only in tropical or semi-tropical regions, although there have been epidemics of yellow fever as far north as Philadelphia, New York, and Boston. It has been in the past a much more fatal disease than malaria, and turns out to be carried by certain species of mosquito. While the parasite that causes

this disease is not yet known, it is certain that, like malaria, it requires two hosts for completing its life cycle. At the close of the Spanish-American War a commission of American physicians undertook to find out whether the mosquito was really the intermediary in the transmission of the disease, as had been suspected by many students of the subject. The commission consisted of Dr. Walter Reed,

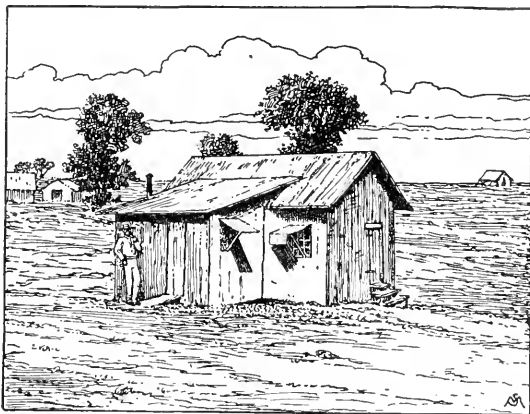

FIG. 211. Camp Lazear

In this building was conducted that part of the yellow-fever experiments which proved that the disease is *not* transmitted by infected clothing etc. The cabin consisted of a room, 14 by 20 feet, with two small windows facing south, closed with wire screens. Heavy wooden shutters excluded the sunlight. Entrance was through a small vestibule on the same side as the windows, protected by a wooden door and a screen door and separated from the main room by a screen door, to make perfectly certain that no mosquitoes could get in. This house was kept closed during the daytime and had a temperature of from 92° to 95° F. It was occupied for twenty nights by three American volunteers, and the test was repeated twice

Dr. James Carroll, and Dr. Jesse W. Lazear, and they were assisted by a Cuban, Aristide Agramonte, who had recovered from the disease and was therefore immune. A camp was established in which two cottages were erected. In one of these the ventilation was intentionally very poor. In the other there was a mosquito-tight screen separating the two halves, and the ventilation was very good. Both cottages were well screened to prevent the entrance or escape of mosquitoes. In the first cottage three volunteers received cases of clothing and bedding from men who were suffering from yellow fever, or who had

died with the disease. They shook out these contaminated articles and slept in the soiled garments and in the soiled bedclothes for twenty days. None became infected. This experiment was repeated two times more, with no results that would indicate the slightest connection between the vomits and excretions of the patients and the infection of new cases.

In the other building a volunteer allowed himself to be stung by a mosquito that had drawn blood from a patient some two weeks earlier. The bedding and other utensils were thoroughly sterilized, and the volunteer had been in quarantine for two weeks, to make sure that he was not infected when he came into the building. On the fourth day he developed the symptoms of the disease. Other volunteers, on the other side of the screen, were not affected. Ten or more individuals contracted yellow fever as a result of stings from mosquitoes that had previously bitten sick persons, and not one of those who stayed on the other side of the screen. In the course of the experiments Dr. Carroll and Dr. Lazear also became sick, the latter dying as a result (Fig. 211).

442. Fighting mosquitoes. With a realization of the importance of the mosquito in the transmission of these serious diseases arose the question of how to combat the pests. Of course each one of us can keep on killing mosquitoes on sight and feel that he is doing his duty. But the mosquitoes do not recognize city limits or state lines, and gayly fly from one man's land to another's. So far the only effective campaign against mosquitoes has been waged on a comprehensive scale by a whole community at a time. It seems that the best way to prevent malaria and yellow fever is by means of ditches to drain off marshy land, by means of cartloads of dirt to fill in low-lying spots, by means of oil on such puddles as cannot be filled or drained, and by means of lids or screens to cover up such cisterns, tanks, or buckets as have to be kept with water standing in them, while all old cans and broken crockery and other possible containers for water are scrupulously placed where the female mosquitoes cannot reach them. For the life history of the mosquito requires quiet water for the laying of the eggs and

the growth of the larva and the pupa. Without such breeding places, one year would see the end of all mosquitoes in all civilized communities. In larger bodies of water, where fish may be kept, these will usually destroy the larvæ and thus prevent the multiplication of mosquitoes; but in the shallow margins, where the fishes cannot reach them, the mosquitoes have things their own way. It is necessary to keep the borders of ponds clear of weeds, sedges, etc. (See Note, p. 411.)

The practical effect of exterminating the mosquito is shown by the decrease of malaria (or yellow fever). Fig. 212 shows the results for the island of Cuba. A similar record stands to the credit of our national government in connection with the work of digging the Panama Canal. The region through which the canal runs was a veritable plague spot. During the various attempts of the French engineers to construct the canal, disease made the completion of the work practically impossible. When the United States took over the enterprise, the first step was the establishment of sanitary conditions; and the largest part of the problem was the extermination of the mosquito through draining and filling in, and the inspection of inhabited regions to prevent the maintenance of breeding places for the insects.

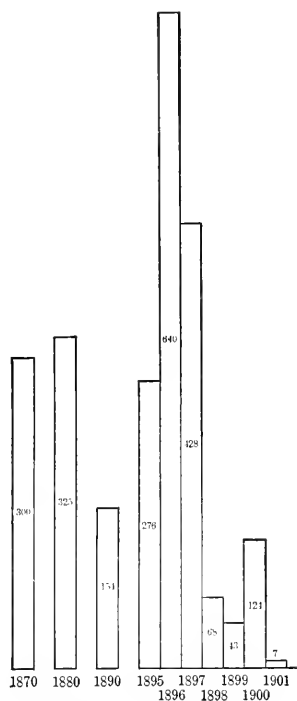

FIG. 212. The reduction of yellow fever in Cuba

The mortality from this disease had always been very high, but much worse in some years than in others. The year 1896 was unusually bad, and 1897 not much better. Immediately after the American army of occupation began to clean up in Havana, in 1898, the sanitary conditions showed marked improvement. By eliminating the breeding places of mosquitoes, yellow fever has been completely banished from the island

443. Other disease-bearing insects. Fleas have been implicated in a very serious combination injurious to man. The bubonic plague, which has in past times been the most dreaded of diseases, especially in Asia, was found (in 1894) to be caused by a specific bacillus. But the mode of infection was not known until quite recently. The Chinese had observed, centuries ago, that there was some connection between the dying of rats in large numbers and the appearance of the plague. Modern scientists set to work to find out whether the rat plague was in any way related to the human plague, and they found that the same bacillus is the cause of both. Then it was found out that the plague spreads from rat to rat not by contact of the animals but through fleas that suck the blood of sick rats and later bite others, thus transferring the infection. Further observation showed that the plague is primarily a disease of rats, and gets into human beings when the fleas abandon dead rats and infect men and women. The plague has spread from the Orient, and cases have appeared at several ports in the United States within a few years. The methods developed for dealing with this danger are directed not toward killing the bacteria but toward killing the rats and fleas. A ship coming from an affected port is thoroughly fumigated to kill the fleas and rats, special devices are attached to ropes and chains to keep rats from getting ashore (or aboard, for that matter), and a search is made for hiding places in which rats may be concealed. In California it was found that the ground squirrels have become infected with the plague bacillus, and systematic patrols are established to catch rats and ground squirrels, which are regularly examined for possible infection.

Since the United States joined the Great War, many important medical problems have been solved by our investigators. One of these had to do with the transmission of trench fever, a disease that caused a great deal of suffering and incapacity, although it was seldom fatal. Volunteers from the ambulance and field-hospital units allowed the blood of patients to be injected into their veins. The development of the disease in the men so treated showed that the sickness is due to a germ (too small to be seen with the microscopes) present in the blood. Other volunteers allowed themselves to be bitten by lice taken from the bodies of sick men, and many of these developed the disease, while others, bitten by lice from healthy men, remained unaffected while living under exactly the same conditions. This showed that the germs are carried over by means of the louse.

Measures were then taken to exterminate the "cooties," as the lice were called by the soldiers. The service that these sixty-six volunteers rendered in this experiment was quite as important as anything else they could do, even from a military point of view, for it established facts that made it possible to save the equivalent of thousands of soldiers for the fighting line.

444. Intermediate hosts. It is not uncommon to find among parasites the dependence upon two hosts for a complete life cycle. This is found among plant parasites as well as among animal parasites; and when there is any doubt about the life history of any such organism, the investigators at once suspect the existence of an alternate host. Through the discovery of the complete life history of many parasites it has been possible to eliminate diseases by the attack upon the intermediate host. For example, in the case of a certain variety of "wheat rust" the alternate host was found to be the barberry plant. By cutting down the barberry plants the farmers saved many a crop of wheat from destruction by the fungus. In the case of certain kinds of tapeworm it was found that the intermediate host is the pig. Here safety lies not in killing off all the pigs, but in cooking the flesh of the animal so thoroughly that the resting stage of the worm cannot reach the inside of the human digestive system alive.

NOTE. "French studies show that the 'preference' of *Anopheles* for blood of cattle and horses is such that malaria practically disappears in regions where these animals are abundant, in spite of the prevalence of the mosquito." — *Public Health Report*, October 15, 1920, pp. 2464-2465

CHAPTER LXXV

INSECTS AND HUMAN WEALTH

445. **Insects as food.** In certain parts of Africa and Asia, as well as in South America, Mexico, and Central America, the natives are said to use various species of locust and caterpillar

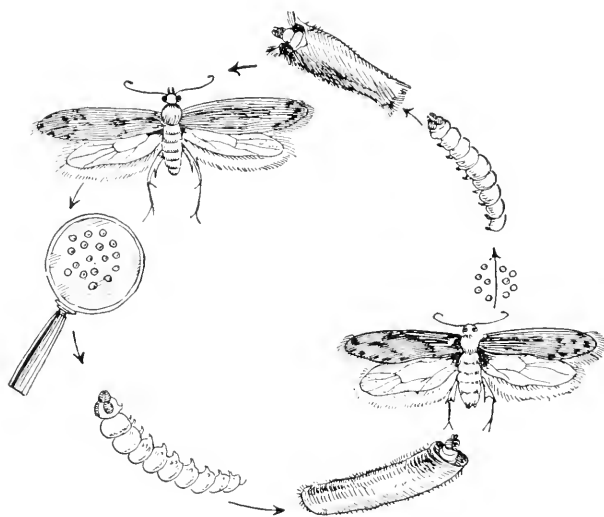

FIG. 213. The clothes moth (*Tinea pellionella*)

It is the larva of this animal that eats woolen and fur material. The eggs are laid on the material and hatch out when the temperature is sufficiently warm. It is for this reason that we rarely find the animals in the winter, and it is for this reason that furs and woolen rugs etc. are placed in cold storage during the summer months. ($\times 8$)

as food. Ants and termites, cicadas, the grubs of beetles, and the eggs of water beetles are also consumed. The Chinese sometimes eat the pupa of the silk moth, after the silk has been removed from the cocoon. In so-called civilized countries the

only insect that supplies food to man is the honeybee, whose honey has been used by man for many centuries.

446. Insect products. The wax obtained from bees is of great practical value, but it is coming to be replaced more and more by paraffin, which is obtained from petroleum.

Another insect product of growing importance, and one for which no satisfactory substitute has yet been found, is *lac*. The lac is used as a dressing for wood and other materials, as shellac, as a stiffening for felt in the making of hats, as an insulating varnish in electrical work, in the making of lithographer's ink and of sealing wax, and in increasing quantities in the manufacture of phonograph records.

The cochineal, another member of the scale-insect family, furnishes a beautiful red dye, which was formerly used in large quantities. This source of supply is of declining economic importance

because of the rapid development of the anilin-dye industry.

The whole silk industry rests upon the fiber obtained from the cocoon covering of the silk moth. Although the chemists have devised ingenious processes for making artificial silk out of cotton and out of wood, we shall probably continue to cultivate the silk moth for a long time to come.

Many of the beetles may be considered as useful, since they destroy large amounts of dead animal remains, as do

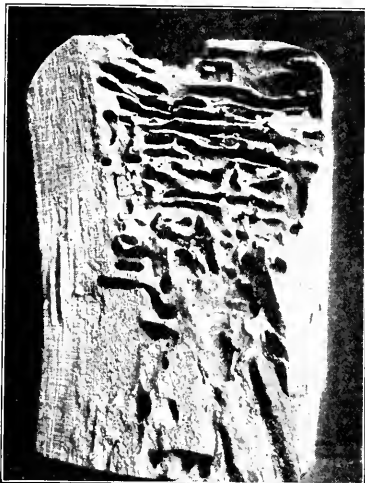

FIG. 214. Destruction wrought by ants

Part of a post completely ruined by the excavations of carpenter ants. There are several species of *Camponotus* and of other genera which are known to bore into wood. (From photograph by New York Botanical Garden)

also some of the ants. In this way they may be looked upon as scavengers. And a few insects, in the course of their predacious activities, devour forms that happen to be injurious to us. This is illustrated by some of the beetles like the ladybug, which eat plant lice and thus keep them in check.

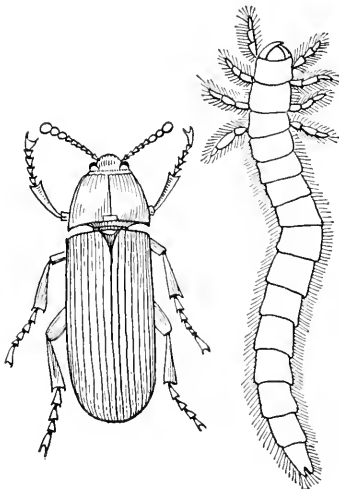

FIG. 215. Meal-worm

Adult and larva of the miller beetle
(*Tenebrio molitor*). ($\times 3$)

We make direct use of very few insects. Many species are nevertheless of indirect value to us as important links in that chain of life extending from decomposing organic matter at one end to the larger useful animals at the other. It is certain also that very many species of insects are essential to the propagation of various species of plants, since they are the sole agents in the distribution of pollen (see pp. 309 ff.).

447. Destructive insects. In this country alone insects of various kinds destroy every year materials and goods estimated to be worth more than two hundred million dollars. This includes stored food, clothing, furniture, carpets and hangings, and furs.

The *clothes moth* is one of the most familiar of these destructive insects, for it is found nearly everywhere that human beings are (Fig. 213). Thorough airing and exposure to sunlight for a few hours will be likely to kill any of the eggs. Naphthalin moth balls do not kill the animals, but repel them and thus prevent destruction. Infested material should be treated with gasoline and then thoroughly aired before being used.

The *cockroaches*, of which there are several species, will eat almost any organic matter, but are seldom destructive to

valuable materials. Yet their presence in a house is an indication that there are crumbs and other scraps of food about, and it is perhaps as well for the cockroaches to eat these as for

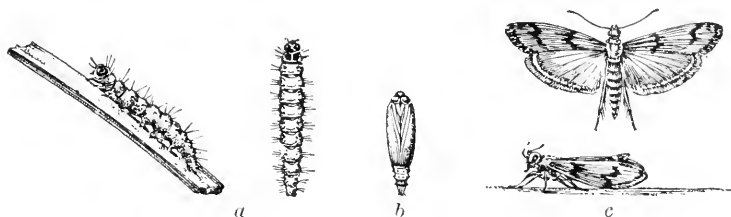

FIG. 216. The flour moth (*Ephestia kuehniella*)

a, larva; *b*, pupa; *c*, adult. ($\times 2$)

some more objectionable animals to do so. On the other hand, they may become a serious menace, in the course of their wanderings, since they may carry disease germs to the food.

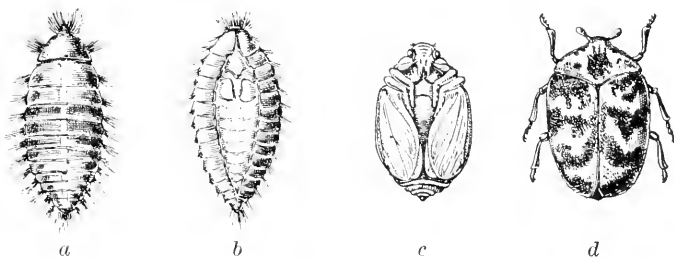

FIG. 217. The buffalo moth

This insect (*Anthrenus scrophulariae*) is a beetle, but is commonly called a moth because it injures furs and rugs in a manner resembling that of the clothes moth. *a*, larva; *b*, pupa in larval skin; *c*, pupa; *d*, adult. (Greatly enlarged)

Ants have been very destructive not only to food materials but also to furniture, clothing, wooden utensils, and even to wooden houses (Fig. 214). The Argentine ant was introduced into this country in the early nineties at New Orleans, and has been more destructive in southern parts of the country than any of our native species.

Ants and cockroaches are always a nuisance about a house and can be exterminated, once they get in, only through careful attention to their nests, cracks in the walls, etc., and to the availability of material that will attract them. Corrosive sublimate is used to poison them, solutions being sprinkled into the cracks. The cockroaches can be driven out by systematically sprinkling borax about the kitchen.

Weevils, small beetles with beaks, are very destructive to stored grains, beans and peas, etc. There are many different species, and they are all destructive. Infested granaries and warehouses need to be thoroughly fumigated with carbon bisulphid, which kills the eggs and the larvæ as well as the adults (see Fig. 219, *c*).

Flour is often spoiled by other beetles, as the meal-worm (the larva of a black beetle, *Tenebrio* (Fig. 215)), and by a species of moth, *Ephestia kuehniella* (Fig. 216).

Another destructive beetle is the so-called *buffalo moth*, shown in Fig. 217. The larva of this carpet beetle is very destructive to rugs and other woolen material.

CHAPTER LXXVI

INSECTS AND OTHER ORGANISMS

448. Insects and useful plants. From the time when men first began to cultivate plants for their own use, insects of one kind or another have caused parts of each year's work to be wasted. There are early records of the destruction caused by locusts, and this name has come to be applied to many varieties of insects that move in hordes. One of the plagues of Egypt was a swarm of locusts, insects which are referred to in the Bible repeatedly.



FIG. 218. The potato beetle (*Leptinotarsa decemlineata*). (Slightly reduced)

There are two or three broods a year. The full-grown larva crawls into the ground, where pupation takes place. The winter is passed underground in the adult stage. The tachina fly, shown in the center, is one of the most important enemies of the potato beetle. The fly lays eggs in the larva of the beetle, and the maggots destroy their host

The first effort in this country to aid agriculture by means of an official investigation of insect ravages was made in the seven-

ties, when an outbreak of this pest did damage over an area of about two million square miles west of the Mississippi River. Since then the federal government and the various states have kept up systematic work through experiment stations or special

agents and commissions, designed to counteract the injuries done by insects to valuable plants. It is estimated that the damage done to our crops by the activities of insects amounts to from six hundred million to seven hundred million dollars every year. To this must be added the injury to forests and forest products, and the injury to animals.

The locusts and many other species of insects will eat almost every kind of plant; but many insects confine their attentions

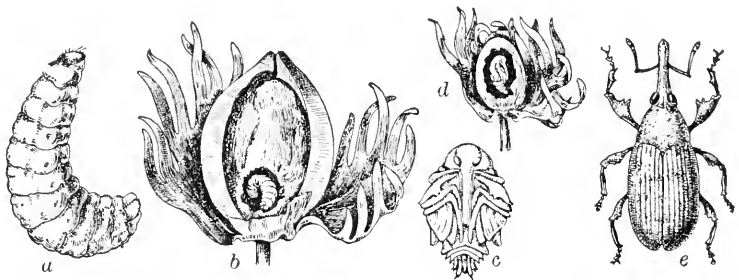

FIG. 219. Cotton-boll weevil (*Anthonomus grandis*). (Greatly enlarged)

This animal feeds only upon the cotton plant and could probably be completely exterminated if the planting of cotton were suspended for a year or two. This was the advice of the government experts to the growers of Texas about twenty years ago; but it was unheeded, with the result that millions of dollars' worth of cotton have been destroyed each year since. Rotation of crops was finally forced upon many of the farmers, with beneficial results. *a*, larva; *b*, larva in mature boll; *c*, pupa; *d*, pupa in boll; *e*, adult

to one or a limited number of food plants. The damage done by such insects is accordingly confined to special kinds of crops.

The *Colorado potato beetle* is perhaps the best known of the special-crop insects (Fig. 218). It is kept in check by the use of poisonous sprays or powders applied to the growing plants.

The *cotton-boll weevil* has spread over a large part of our cotton area in recent years and has ruined many a crop (Fig. 219). This animal is very susceptible to extremes of temperature and has many natural enemies. Planting early-ripening varieties in wide rows, and then burning the stalks and rubbish after the harvest, will do much to keep the pest under control.

The *gypsy moth* has been known as a pest for nearly two hundred years. The larvæ feed upon the foliage of many kinds of forest and orchard trees, ruining the plants completely (see Figs. 220, 221).

The *codling moth* is familiar to everyone who has found a wormy apple. This insect is present wherever apple trees are grown, and in some regions it destroys from 40 to 75 per cent of the crop (see Fig. 222).

The *Hessian fly* is so called because it was supposed to have come to this country with the Hessian soldiers during the Revolutionary War. It has spread to all parts of the world, probably attached in the pupal stage to wheat straw used as packing for merchandise or as bedding for horses and cattle. It has caused great damage to wheat, and it sometimes attacks barley and rye.

The *San Jose scale* has been very destructive to fruit trees, attacking the leaves and twigs as well as the fruit of many cultivated species. It was introduced from China on some nursery stock and was

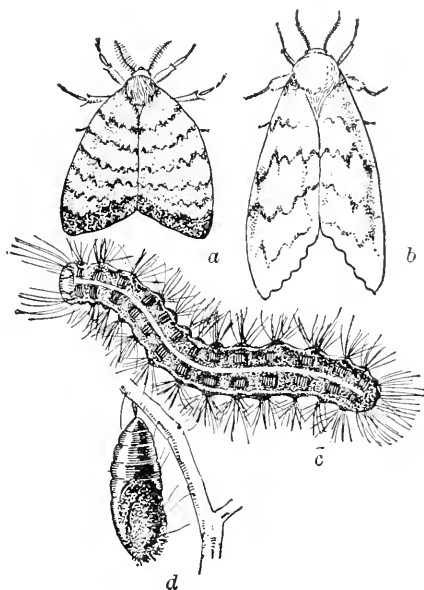

FIG. 220. The gypsy moth (*Porthetria dispar*). (a, b, c, slightly enlarged; d, slightly reduced)

This animal was introduced into this country about 1869, in the course of some experiments made to find a substitute for the silk moth, and in twenty years it became so great a nuisance that the legislature of Massachusetts made an appropriation for the study of methods to be used in checking the insect. In ten years over a million dollars was spent in the fight, but further work was stopped by some of the legislators whose regions had not been affected. The insects then multiplied to such an alarming extent that in 1906 about a quarter of a million dollars was again spent in the fight.

a, male adult; b, female; c, larva; d, pupa

first noticed at San Jose, California. In twenty years it had spread to all parts of the United States and also into Canada.

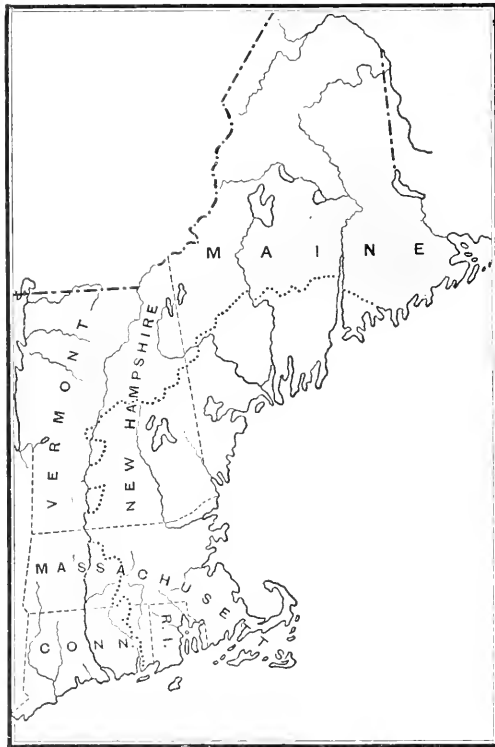

FIG. 221. Gypsy and brown-tail moths (1917)

The region between the dotted line and the ocean is infested with both species. The brown-tail has also invaded the region shown by the shaded surface

Aside from the insects mentioned there are hundreds of others that attack all our garden and field crops and orchard and forest trees. It is hardly possible to find a plant that has not one or more serious insect enemies.

449. Insects and useful animals. It has been said that every plant and every animal has its parasites and its preying enemies. And it is probably safe to add that every organism of any size has its enemies among the insects.

The mammals and birds which are most familiar to us are annoyed by various flies, lice, gnats, and fleas, which sting and suck blood. There are a number of parasitic diseases of animals other than man that are transmitted by insects either directly or indirectly, the insects acting as intermediate hosts. In addition to these sources of injury there are some insects that attack larger animals more viciously.

The *botflies* are representative of a large group of insects that are often injurious to horses and cattle (see Fig. 223).

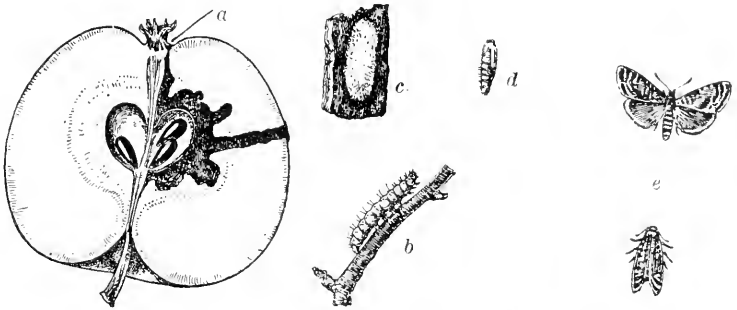

FIG. 222. The codling moth (*Carpocapsa pomonella*)

a, where the egg is laid on the apple; *b*, larva, the "worm" of the apple; *c*, cocoon; *d*, pupa; *e*, adults. (About natural size)

The *ox warble* lays its eggs on the cow. It is not certain whether the larvæ work their way through the skin or from the

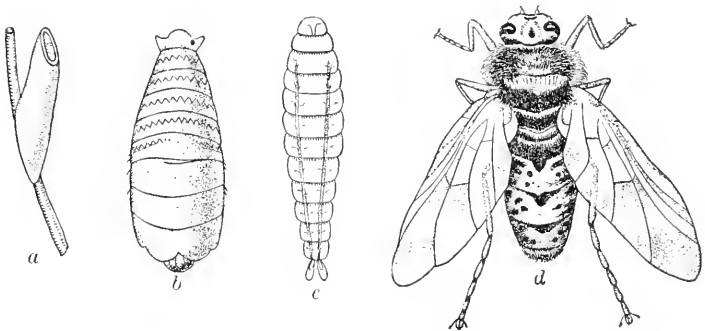

FIG. 223. The horse botfly (*Gastrophilus equi*). (Somewhat enlarged)

The egg, *a*, is laid on the hair of the horse and is swallowed, together with the larva, *b*, in the saliva. In the stomach the larvæ attach themselves, often causing serious irritations and incapacitating the animal for work. The larvæ escape from the host with the excrement, and then pupate in the ground. *c*, pupa; *d*, adult

alimentary canal. They finally lodge under the skin and thus ruin millions of dollars' worth of hides, besides making the animals sick and reducing their milk and beef values.

450. Fighting insects. One of the first suggestions that insects could be controlled by encouraging other insects was made about a hundred years ago by two English entomologists, who declared that an increase in the number of ladybirds in greenhouses and fields would clean out the aphids, or plant lice, and insure the hops against destruction (see Fig. 224).

In this country various species of native ladybirds serve as effective checks upon plant lice of many kinds. It has been possible to control the destructive Hessian fly by means of the parasite *Polygnotus*.

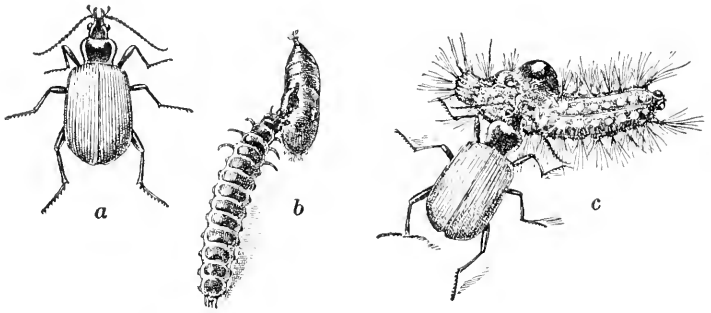

FIG. 224. The calosoma beetle (*Calosoma sycophanta*). (Somewhat reduced)

This beautiful green animal was used by a French scientist in a campaign against the gypsy moth in 1840. In recent years this method of fighting undesirable insects by encouraging the spread of an enemy insect has been rapidly extended, especially in the United States, which leads the world in applied entomology. *a*, adult; *b*, larva feeding on pupa of gypsy moth; *c*, adult feeding on larva (caterpillar) of gypsy moth

Shipments of such parasitic insects from one part of the country to another are frequently made to meet outbreaks of injurious insects. A further step was taken when specialists were sent abroad by the government to look for natural enemies of injurious insects in the regions from which these insects originally came.

The United States probably suffers more from injurious insects than any other country, because there have come here with the migrations of peoples a large number of foreign insects, without their natural enemies. This country has also done more than any other in the scientific and practical study of insects and of methods of control.

Ladybird beetles have been imported from China to keep down the San Jose scale. Calosoma beetles and several parasitic, wasplike insects have been imported to fight the gypsy moth and the brown-tail moth. This kind of work is growing very rapidly. There are now several stations in this country where insects are cultivated on a large scale, to be sent where needed in controlling injurious insects.

Spraying of orchard trees, shade trees, and crop plants with various kinds of poisonous mixtures is one of the common means used by farmers in controlling the damage resulting from insect depredations.

The rotation of crops is used for the purpose of starving out one generation of injurious insects. This can be used against insects that confine themselves to special kinds of food plants.

In recent years it has been found that insects are subject to fatal diseases caused by species of fungi. Cultures of such fungi have accordingly been used to fight insects. A number of the insects are caught alive and infected with the parasitic fungus, and then set free again. The escaped insects infect their fellows, and millions are thus killed off. This method has been successfully employed against locusts in South Africa and in Yucatan.

The other natural enemies of insects are toads, frogs, snakes, and, most important of all, nearly all kinds of birds. A given amount of money spent in protecting and encouraging the native birds of a region is likely to produce more beneficial results than any other method of fighting insects.

451. The balance of nature. The number of individuals in a species fluctuates from year to year, partly on account of climatic conditions, as when an early frost destroys plants before the seeds are ripened, or when the frost kills off certain enemies. But much of the fluctuation is due directly to the variation in other species. A good year for ladybirds will mean a poor year for scale lice; but the following year the shortage in scale lice will reduce the number of ladybirds. The living beings are related to each other in hundreds of ways, so that the elimination or unusual increase in one species is likely to affect the well-being or even the existence of another. Every species has its friends in the living world, as well as its enemies, and when man undertakes to change the face of the earth with

respect to any species, he must proceed cautiously and on the basis of a thorough knowledge of all the relations of the species concerned, and not merely on the basis of a superficial answer to the question, Is that species useful or harmful to me? It is practically impossible to reduce the numbers of one species without producing far-reaching effects upon other species. It is not a matter of interfering with nature's plans, as some suppose. It is a matter of disturbing a certain *balance* that it has taken a long time to establish, with possibilities of unknown consequences.

When rabbits were introduced into Australia, they multiplied so rapidly that before many years they became a real pest, and the government offered bounties for their extermination. Here was a region admirably fitted for the life of these animals, and until man interfered there had been no such animals there. The same kind of thing happened with the introduction of the water cress into New Zealand, and with the introduction of the English sparrow into the United States. Probably these organisms thrive better in the new surroundings because they did not here meet their old enemies. These facts should help us to realize how closely dependent upon one another the various species of plants and animals are.

CHAPTER LXXVII

BIRDS IN RELATION TO MAN

452. The food of birds. As in the case of most animals, birds are important to us chiefly because of the food they eat. But unlike most insects, the feeding of birds usually turns out to be of advantage to mankind. Observation has convicted many birds of eating fruit in the orchards, and the sharp-shinned hawk has been caught carrying off hens from the barnyard. But the systematic study of the contents of birds' stomachs has shown that most of the food of practically all the common wild birds consists of insects, the seeds of various undesirable weeds, and field mice, shrews, mice, and other undesirable animals. In other words, with a very few exceptions, the common birds are worth more alive than dead. The value of most wild birds as destroyers of insects, vermin, and weeds is vastly greater than their value as sources of feathers, as food, or as objects of sport.

453. Destruction of birds. Many birds are destroyed wantonly by ignorant boys and men, others are killed to supply feathers, and still others are exterminated in the destruction of eggs and nests out of idle curiosity or in the interests of untrained collecting. In rural and suburban districts the domestic cat is a serious menace to the native birds, and does damage that is far from compensated for by the mice or rats killed by the cats.

During their migrations many birds are killed by flying against telephone and telegraph wires, and against plate-glass windows. Along the shores, migrating birds frequently hover about the lighthouses at night until they are exhausted. The extension of cities, the clearing of forests, and the improvement of farms are all tending to exterminate various species of birds.

The destruction of dead limbs and dead trees in forests and wood lots will mean the disappearance of the downy and the red-headed woodpeckers, but it is worth while to keep the wood-lot clear.

The spraying of orchard trees with poisons intended to destroy caterpillars has led to the death of thousands of birds that eat the poisoned insects. It is probable that in the long run it would be more economical to encourage the birds to nest in our orchards and let *them* keep the insects in check.

454. Protection and encouragement of birds. Many of the destructive agencies that affect birds are directly under our control. When once we are convinced that it is worth while to do so, it is possible to place electric wires underground, as is now being done in the cities, for example. The Royal Society for the Protection of Birds, of England, has had gratings placed upon a number of lighthouses on the coast, to serve as bird-rests. Here the migrating birds rest until morning and then continue their flight. Thousands of birds are thus saved from destruction; and when we realize the value of the birds, we shall no doubt plan to build all of our lighthouses with some consideration for the safety of these animals.

Men and boys will have to be educated to enjoy life without destroying useful animals, and to find sport in opera glasses or the camera; and girls will have to be educated to be happy without birds' plumage, or to be content with the dyed feathers of domestic fowl.

Those who have tried it seem to get as much fun out of building nest boxes and shelters for birds as others can get out of shooting or trapping them. And the birds that have been encouraged to make their homes in our immediate neighborhood will continue to furnish us with interesting sights and sounds long after dead birds would have been forgotten.

In addition to providing suitable boxes for bird nests, we may do a great deal to protect them against starvation after heavy snowfalls. At such times there is practically no food

available in the fields or woods. The scattering of grain or bread crumbs will enable many birds to survive until the ground is clear and they are again able to find food for themselves.



Cooper's hawk (*Accipiter cooperi*)

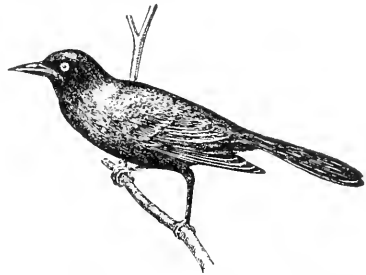

Bronzed grackle (*Quiscalus quiscula*)



Blue jay (*Cyanocitta cristata*)

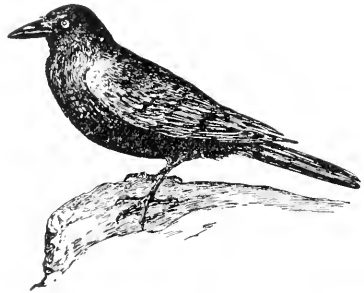

Crow (*Corvus americanus*)

FIG. 225. Some undesirable bird neighbors

Cooper's hawk preys upon poultry and insectivorous birds. The blue jay and the bronzed grackle destroy the eggs of other birds, and the grackle also eats a great deal of grain. The crow destroys grain, fruit, useful insects, and the eggs of useful birds

The cat and all its wild relatives are so destructive to birds that it is doubtful whether we should not all be better off with the domestic cat completely eliminated from our lives. There are some good things to be said in favor of the cat; but the other things more than offset them. The red squirrel

often destroys the eggs and sometimes even the young of birds, and does nothing to compensate for this damage. These animals should therefore be killed, to give the birds a



Cedar waxwing (*Ampelis cedrorum*)



Yellow-bellied sapsucker (*Sphyrapicus varius*)



Red-headed woodpecker (*Melanerpes erythrocephalus*)



Great blue heron, or crane
(*Ardea herodias*)

FIG. 226. Some suspicious tramps

During part of their migration the cedar waxwing destroys fruit and disperses weed seeds; the yellow-bellied sapsucker injures standing trees; the red-headed woodpecker destroys cultivated fruit; the blue heron eats fish and frogs. But on the whole they pay for all they consume, and a little more, and are therefore protected by law

better chance. The weasel, the skunk, the fox, the raccoon, and other mammals sometimes kill birds or eat their eggs; but as they do not feed exclusively or largely upon birds, they are not to be considered serious enemies.

455. Undesirable birds. It is impossible to class every species of bird as altogether useful or altogether injurious. A bird may be very useful in one region and injurious in another. The red-tailed hawk feeds on field mice in one region and discovers that chickens are good to eat in another. The bobolink is a serious menace to the rice fields in the South, but is a valuable insect destroyer in the North. The red-winged black-bird ate so much grain in Nebraska a number of years ago that the farmers just took up arms and killed the bird off. The following year, however, the absence of the blackbirds enabled the locusts to multiply so rapidly that many of the grain crops were ruined.

456. Direct economic value of birds. The poultry and eggs produced in this country and sold for food every year are valued at over five hundred million dollars. To this must be added game birds used as food, the value of which it is practically impossible to estimate, and importations of bird products. Imported feathers and downs come to about eight million dollars a year.

The most valuable organic fertilizer consists of guano, which is the refuse of millions of birds, accumulated through many years upon various islands off the coast of South America (see p. 66).

The satisfaction yielded to the observer by the song and chatter and by the appearance of birds would seem to be enough to pay for the maintenance of many of these interesting animals; but we can have these returns without paying for bird feed, and get in addition the very considerable contribution that they make to the suppression of undesirable insects, rodents, and weeds.

CHAPTER LXXVIII

SOCIAL LIFE OF ORGANISMS

457. Self-sufficient individuals. Among the lowest forms of plants and animals each individual is quite independent of its neighbors, as we may see in the case of the ameba, the paramecium, the green slime, the various bacteria, and so on.

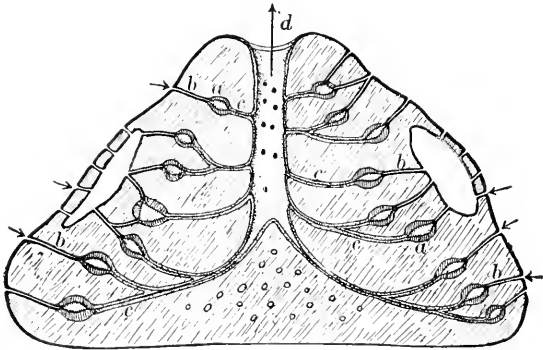

FIG. 227. Diagram of sponge structure

A sponge is a colony of cells arranged about hollow spaces, *a*, which are connected with the surrounding water by means of hollow channels, *b*, carrying currents inward, and by means of other channels, *c*, carrying currents outward through larger tubes, or "sewers," *d*. The currents are produced by the constant vibration of cilia projecting into the spaces, and they bring to the cells fresh supplies of food and oxygen, and carry away waste

Among many of the algæ the cells generally remain attached to form long filaments, but there is apparently no physiological connection, and a break in the filament does not affect the activities of the severed portions.

Among the more complex algæ, such as the bladder wracks, detached portions may continue to grow, since each portion depends upon materials absorbed from its immediate surroundings

for its sustenance. But among these higher algæ the growth of the mass of cells assumes a rather definite form, and certain of the groups of cells become specialized as anchorage organs, others become specialized as reproductive organs, and so on; and it takes all of these together to make up a complete life.

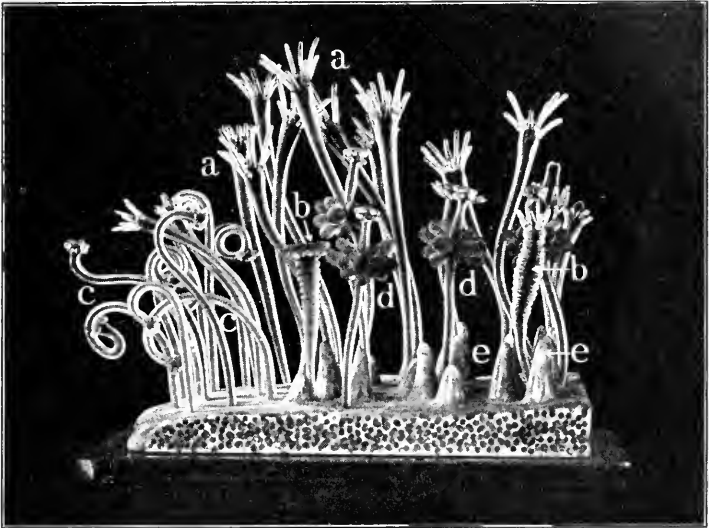

FIG. 228. Colony of Hydractinia

In this colonial animal (related to the jellyfish and to corals), as in many others, there are distinct kinds of individuals, called *hydranths*. *a*, vegetative, or food-getting, hydranths, which take in and digest food for the whole colony; *b*, vegetative hydranths in various stages of contraction; *c*, protective, or fighting, hydranths, which bear large numbers of nettling cells; *d*, reproductive hydranths, male and female, which throw off sperm cells and egg cells respectively; *e*, buds, or undeveloped hydranths. (Photograph from model in American Museum of Natural History)

If we consider the whole plant as an individual, we see that it is quite possible for a single plant to continue its life without relation to any others of the species. In general this is true of all the plants, from the lowest to the highest.

458. Differentiated cells. When we pass from the one-celled animals to the sponges (Fig. 227), we find that while the life

of each cell is practically independent of that of its neighbor, there is some differentiation as to cell structure, and there is a great deal of common activity.

459. Differentiated individuals. Among the Cœlenterata (to which branch belong the hydra, jellyfish, sea anemones, and corals) we find species in which the individuals are quite independent, others in which there are colonies of similar

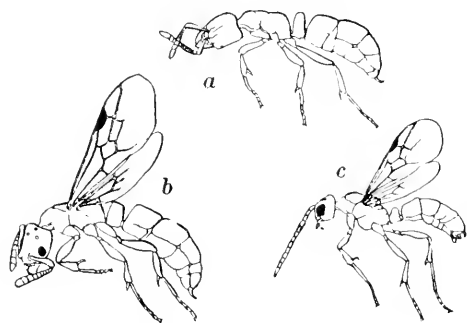

FIG. 229. Ant individuals

In this ant (*Ponera pennsylvanica*), as in so many others, the worker, *a*, is easily distinguished from the female, *b*, and the male, *c*. (After Wheeler)

individuals, and still others in which the individuals are differentiated in structure as well as in function (Fig. 228). The "Portuguese man-of-war" consists of several kinds of individuals, — nutritive, locomotive, and reproductive.

460. Colonial animals. Above these simple colonial ani-

mals we find forms in which the interdependence within the species is chiefly confined to reproduction and the care of the young (see pp. 331 ff.), but toward the upper end of each of two very important branches — the Arthropoda and the Vertebrata — there appears a form of colonial life which is very significant to us, from a practical point of view as well as from a theoretical one.

In an ant colony there may be one or several queens or female ants, thousands of workers, and many soldiers. After the colony is started, the queen may lay eggs continually. The workers extend the nest and keep the structures in repair. They also go forth to forage for food, look after the eggs, larvæ, and pupæ, and clean out all foreign matter that cannot be used (Fig. 229). In some species the soldiers are quite

distinct from the workers, and engage in fights with other ants that may invade or approach the entrance of the nest, whether of the same species or of a foreign species (see Fig. 193). In some species of ants the workers are of two distinct sizes and show marked differences in behavior as well as in structure.

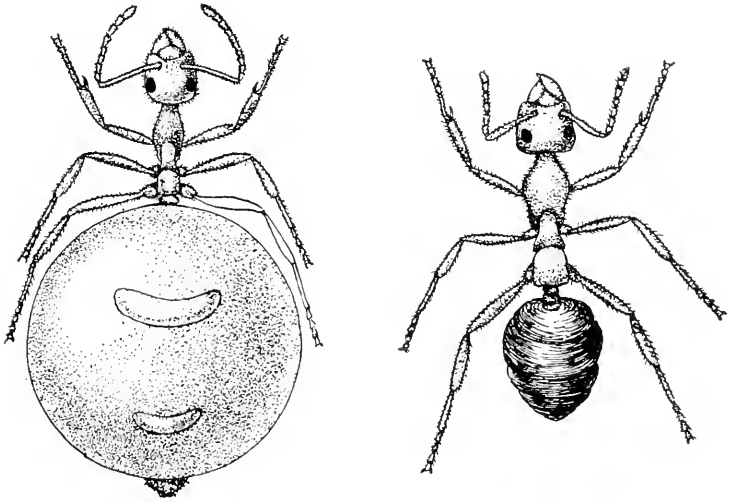

FIG. 230. Honey-pot ants

In this species of ants, found in California, some of the individuals become reservoirs for honey gathered by the forage workers. These living honey-pots cling to the roof of a chamber by their feet, and receive into their crops the food gathered by the workers. From time to time one of the nurse ants comes to the honey-pot and receives into her crop a quantity of the stored fluid, which she then transfers to the larvæ

In a hive of honeybees the individuals are engaged in several different occupations. Some are building comb, others hang up by their feet and secrete wax plates or scales, others pack pollen into cells, some are feeding the young, and so on. You could probably distinguish the queen bee from the others by her size, but all the workers would look alike to you. Or you might notice that the nurses were more fuzzy than the foragers. This does not mean that there are two distinct kinds of workers. Apparently the workers behave

differently at different ages ; thus, when first out of the pupal stage the young bee is a nurse. She does not leave the hive to forage for a week or more, and she is more fuzzy now than those in the foraging stage, because she has not had the time and the trials to break or rub off her hairs.

The high degree to which the division of labor is carried among the social insects, and the complexity of their various activities, have led to a great deal of speculation as to how the animals are directed in their coöperations. Do the insects remember and plan and fit their actions to purposes in the same sense as human beings do? There is a great deal of evidence to show that what has been called recognition by a bee or ant of others from the same colony is nothing at all like our recognition of those with whom we are familiar. It is more like what happens when a blind person smells a rose that arouses agreeable feelings in him. And so with many other peculiarities of these animals, it is possible to understand much of what they do without assuming intelligence.

461. Coördination. In the division of labor there is involved a great deal of coördination. That is, so long as it is impossible for each individual to carry on a complete life, it is necessary that there be some way of exchanging materials or services. This situation has frequently been compared to the physiological division of labor that we find in our own bodies and in other many-celled organisms. We have seen that there is a great deal of coördination through the blood system, through the lymph, and through the nervous system. In a colony of disconnected individuals the coördination must be brought about by what the animals do to each other directly, or by means of the materials with which they all deal. But it is not necessary to assume that there is a conscious coöperation that involves common aims and intercommunication.

There can be conscious coöperation only where there is also a certain degree of general intelligence. In every case there is a great deal of interdependence, so that the individual separated from the group becomes almost helpless.

Among many species of birds and mammals there is a degree of social life that extends somewhat beyond mere gregariousness. The Russian explorer Peter Kropotkin has brought together in his very interesting book, "Mutual Aid a Factor in Evolution," hundreds of examples of animals that hunt in groups, or post sentinels to guard against danger, or fight off attacks of enemies through concerted action, or in other ways show mutual interrelations within the species.

462. Interdependence. Every one of us is dependent upon others of the same species in hundreds of ways. As members of the community we are dependent upon each other for various kinds of personal and specialized services. We depend upon community action for our safety from various plants and animals, as well as from antisocial individuals who would prey upon the rest, and from inanimate dangers, such as fire and flood and storm. We depend upon each other as members of the state or nation in the exchange of materials that are found in some regions but not in others, and upon this is founded all of our commerce. As members of the state or nation we depend upon joint action for the regulation of those things that affect the very conditions of existence,—as the resources of the soil and the waters, the safety of highways and waterways, the protection of food supplies, the prevention of infection of man or domesticated plants and animals, and so on. As members of the human race we are dependent upon those of other countries, not only for materials that are restricted in their distribution, but even more for ideas arising out of different experiences. Modern science, upon which rests so much of our present-day advance in general welfare, is altogether an international product. Every discovery and every invention rests upon hundreds of other discoveries and inventions made by men and women of many nations and of several generations. What we call civilization is an accumulation of the most valuable thoughts of all peoples.

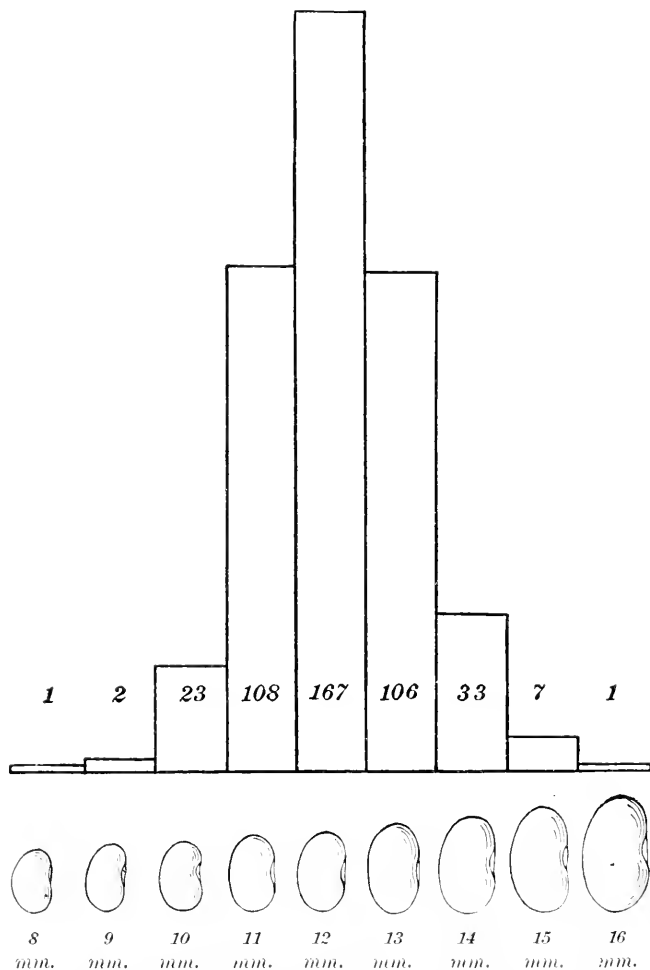

FIG. 231. Variation in size of similar units

On measuring the length of each of several hundred beans taken at random from a large lot, it was found that the largest was about twice as long as the smallest. The number of seeds of each size is shown by the relative height of the corresponding column above the horizontal line. Studies of this kind, repeated by many workers on many kinds of material, show not only that individuals vary, but that they vary *in a certain way*

PART V

HEREDITY AND EVOLUTION

CHAPTER LXXIX

VARIATION

463. No two alike. In some respects all the members of a species are alike; that is why we classify them as of the same species. But in some respects every individual is unique. If a person should get the tips of his fingers inky and place them on a sheet of paper, he would make a mark that could not be duplicated by anyone else. Ordinarily we have no difficulty in distinguishing from each other human beings that look very much alike, although occasionally there is difficulty in identifying a person beyond every doubt.

All species present this fact of variation. And variation is found with respect to every character. There is variation in size and in proportions (Fig. 231), in

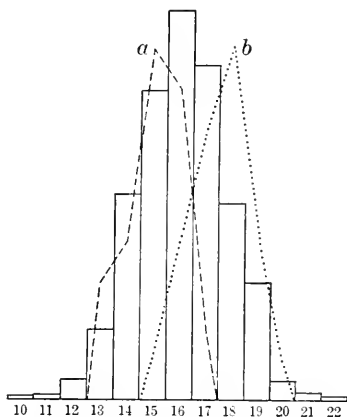

FIG. 232. Individual variation in the number of repeated parts

The principal veins on each side of the midrib on a beech leaf vary from 10 to 22. The number most frequently found is 16. The vertical columns correspond in height to the frequencies with which the various numbers of veins occur. Broken line *a*, a tree in which the number of veins varied from 13 to 17, leaves with 15 veins being most frequent. Dotted line *b*, another tree, in which the veins varied from 15 to 20, 18 veins being most frequent. Each tree has its individuality, and each leaf has its individuality

coloring and in shading, in the numbers of duplicated parts (Fig. 232), and in physiological properties (Fig. 233). Examples of all these kinds of variation are easily found. Examples of physiological variation are the yield of milk, the proportions of sugar or of some other component (Fig. 234), the amount of sleep people need, relative immunity to infection, and so on.

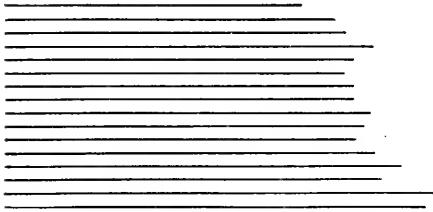

FIG. 233. Variation in physiological characteristics

Each line represents the relative amount of milk given by 16 cows in one month. The poorest yield (represented by the shortest line) averaged 20 pounds a day; the best cow averaged 30 pounds a day. Not only did one cow differ from another, but for each cow the yield varied from day to day. In like manner, the percentage of fat in the milk varied from cow to cow; and for every cow, from day to day

464. Causes of variation.

We know that when a cow is undernourished, she will not yield as much milk as she does when she is properly fed and cared for. This accounts for much of the difference between one farmer's cows and his neighbor's cows. On the other hand, in a given herd of cows, all of which have received the same care and feeding from

the time they were born, there will still be great variations in the ability to produce milk. In the first case we say that the yield of the cow has been *modified* by the treatment she has received. In the second case we say that the cows are of different *breeds*, or strains.

All around us we see examples of modifications resulting from differences in the conditions of development. Differences of feeding affect plants as well as animals. In any season we may see fields of stunted, backward crops and fields of luxuriant growths. In every city we may see well-fed, vigorous, and alert men and women, as well as shriveled, miserable, and timid men and women. It is important to know whether, and how far, these differences can be controlled.

It is quite impossible to say offhand, in any given case, how much is due to inherited differences or *breed*, and how much is due to "fluctuations" produced by the *environment*. But all farmers know that, besides controlling the conditions under which their plants and animals develop, they must also be careful to select the right kinds of seed or stock. The best of care will not make an ordinary white bean develop into a plant bearing lima beans, nor will extra feeding make a scrub cow give the kind of milk that may be obtained from a good Jersey cow.

465. Improvement by selection. All domestic animals and plants have been carefully watched for centuries for the purpose of selecting the most desirable individuals as the parents of the succeeding crops or generations. The best heads of wheat were selected for seeding the following year; the best beans and the best potatoes have been set aside as the progenitors of the crops to come. And the same principle has been applied in the raising of animals. The best milk cows were selected to be the mothers of the calves, the swiftest mares were the mothers of the colts, and so on.

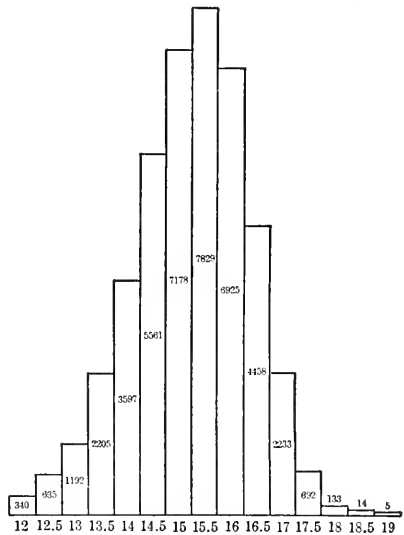

FIG. 234. Variation in physiological properties

Forty thousand sugar beets, tested individually, showed from 12 per cent to 19 per cent of sugar. Beets containing 15.5 per cent of sugar were the most frequent, but there were almost as many beets with 15 per cent or with 16 per cent. As the percentage of sugar departs more from the typical 15.5 per cent, the number of individuals with a given sugar content diminishes, so that the extremely poor and the extremely rich beets are also fewest in number

Careful observers familiar with farm life and practice have noted that cultivated races of plants and animals tend to deteriorate markedly in a very few generations unless the selections are made every year. The explanation for this was unknown, but the fact was clear, and its application was found in steadily selecting the best or most desirable individuals or

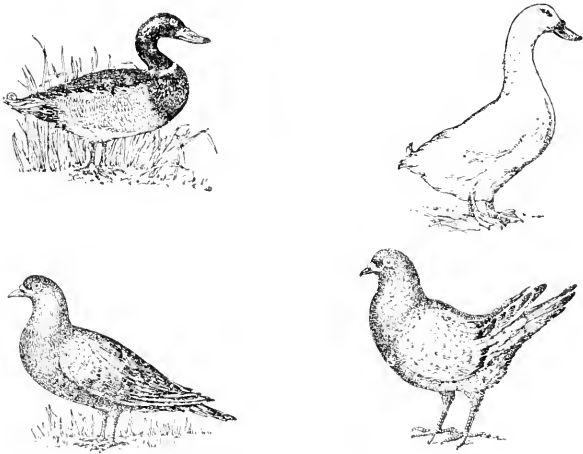

FIG. 235. Improved varieties of domestic birds

seeds for further propagation. For one thing was certain: it was possible to improve the stocks to a considerable degree by constant selection (see Figs. 235, 236).

466. Mixed types. In the diagrams used to illustrate the measurement of variations (Figs. 231–234) we see that for every series there is one measurement that represents the condition of a comparatively large number of individuals. This appears in the diagram as the peak of the curve. In many groups of individuals careful measurements will show two such peaks. For example, the Dutch botanist Hugo de Vries counted the number of ray-florets in a species of daisy (*Chrysanthemum segetum*) and plotted the results of his counting, which are given graphically in Fig. 237.

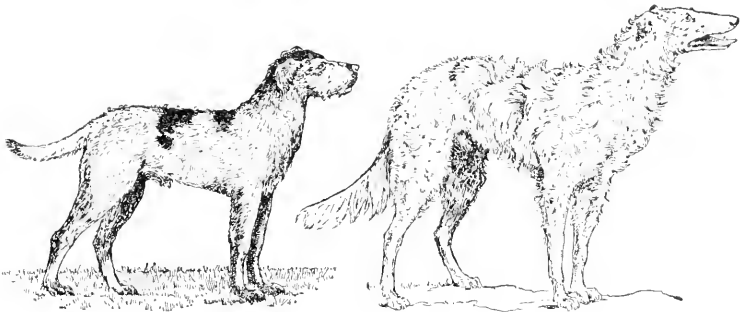
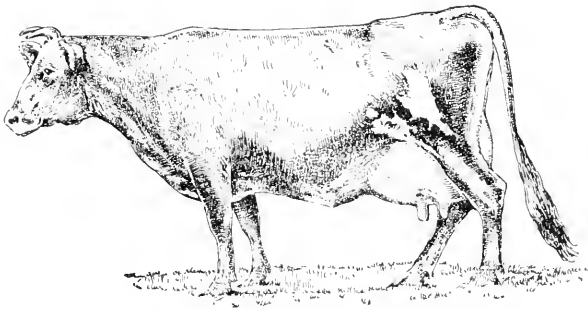
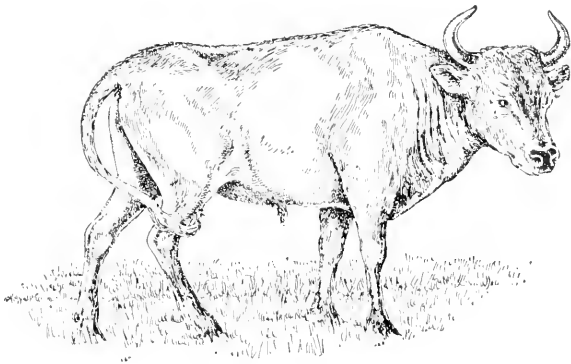

FIG. 236. Improved varieties of domestic animals

The contrast between the modern high-bred Jersey and the ancient banting, or between the high-bred Russian wolfhound and an ordinary yellow dog, is typical of the changes brought about in the course of many generations by the steady work of selecting the most desirable kinds of individuals to be the parents of the following generations

This diagram led to the suspicion that what had been known under a single name was in reality a mixture of two different

plants. In order to try out this idea, de Vries selected seeds from heads having thirteen ray-flowers, and planted them separately. The rays on the flowers of the new plants derived from these seeds were counted, and the distribution of the variations found to cluster more closely around thirteen rays, as shown by the dotted line in the figure. This would show that the wild daisies represented probably two distinct races, or strains, that looked enough alike to be considered as a single species.

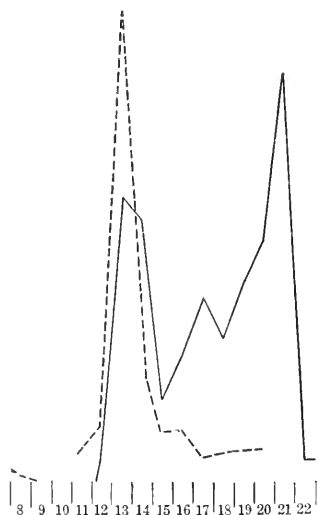

FIG. 237. Two-peaked curve of variation

The height of the line above the base corresponds to the number of daisy heads (*Chrysanthemum segetum*) having the number of ray-florets indicated at the bottom. The solid line shows that there were many heads with 13 florets, and very many with 21, and that the intermediate numbers were represented by fewer individuals, as were also the numbers above 21 and the numbers below 13. The broken line shows the distribution of the following year's crop, grown from seeds out of 13-ray heads. Note the greatly increased proportion of 13-ray heads

Another illustration is furnished by some beans studied by a Danish scientist, Dr. Wilhelm Johannsen. From the appearance of the beans, and from the appearance of the curve showing the distribution of their variations, no person would suspect that they were not all of one kind. But when Dr. Johannsen planted single seeds of different sizes, and kept the plants carefully guarded against possible cross-pollination, he obtained groups of seeds that clustered around the respective parent seeds in size.

This process was continued for several generations, until the experimenter succeeded in separating nineteen pure lines of plants that remained distinct in following generations.

CHAPTER LXXX

HEREDITY

467. The problem of heredity. How is it that the characters of the parents are transmitted so regularly to the offspring? How is it that, in spite of the close resemblances between parents and offspring, these are never exactly alike in every point? These questions have to do with the problem of *heredity*.

468. Analysis of the problem. Certain facts, or laws, of heredity were first discovered in part by an Austrian monk named Gregor Mendel (1822-1884). Mendel had long puzzled about the great variations among his garden peas. There were tall plants and short ones, plants with white flowers and plants with colored flowers. In some plants the seeds were yellow, in others they were green; some seeds were smooth, others were wrinkled. All in all, he studied seven different pairs of contrasting characters in regard to which pea plants differ. He noticed further that a given plant might have any combination of single members of these pairs. A hairy plant might be tall or it might be short, it might have yellow seeds or it might have green seeds, it might have full pods or shrunken pods, and so on.

469. Mendel's experiments. Fixing his attention on a single character at a time, instead of trying to think of the variety as a whole, Mendel crossed garden pea plants that were different. Thus, he crossed green-seeded plants with yellow-seeded ones, tall ones with short ones, hairy ones with smooth ones, and so on for all the pairs of differences.

When pollen of green-seeded plants was placed on stigmas of yellow-seeded plants, or vice versa, *the resulting seeds were all yellow* (see Frontispiece).

Most people have the impression that where individuals with differing characters are mated, the offspring will show characters somewhere between the characters of the parents. The reason for this common belief lies in the fact that in our everyday experience we notice that *children resemble both parents*; but most of us have failed to notice further that this resemblance to both parents consists not merely in *having many characters halfway between* the corresponding characters of the parents, but also in *having some characters just like those of the mother and other characters just like those of the father*.

470. The Law of Dominance. Mendel found that this complete resemblance of the offspring to *one* of the parents (in regard to a particular character) was quite the rule with each of the other pairs of characters. Thus, the offspring of a tall-and-short cross were all tall. The offspring of a smooth-and-wrinkled-seeded cross were all smooth, and so on. This fact is called *dominance*, the idea being that where two characters of a pair meet in an individual one of them masks or dominates over the other, called *recessive*. The latter is not destroyed, as we shall see. Of course, we cannot tell which of the two characters in a pair will appear in the offspring before trying them out. In the tables on page 445 are given the dominants and their alternatives for a number of characters in plants and animals. For many other characters it has been found that the offspring does *not* show complete dominance of one alternative.

471. The Law of Segregation. The yellow seeds of the hybrid¹ pea plant are hardly distinguishable from the pure yellow seeds of one parent. With plants grown from the hybrid yellow seeds Mendel brought about three classes of cross-pollination.

¹ The word *hybrid* was formerly applied to the offspring of two parents of different species or races, as, for example, the mule, or a mulatto, or the offspring of a Caucasian and an Indian. It is now used quite generally among biologists, horticulturists, animal breeders, etc. to mean the offspring of two parents that differ with respect to any particular character. For example, a seedsman might speak of a hybrid tomato, meaning a plant resulting from a cross between two varieties of tomatoes, and so on.

HEREDITY IN PLANTS

NAME OF PLANT	DOMINANT CHARACTER	RECESSIVE CHARACTER
Wheat	Late ripening	Early ripening
Wheat	Susceptibility to rust	Immunity to rust
Barley }	Beardless	Bearded
Wheat }		
Maize	Round, starchy kernel	Wrinkled, sugary kernel
Maize	Yellow grain	White grain
Garden pea	Yellow seed	Green seed
Garden pea	Tallness	Dwarf
Garden pea	Smooth seed	Wrinkled seed
Tomato	Two-celled fruit	Many-celled fruit
Cotton	Colored lint	White lint
Stock }	Colored flower	White flower
Sweet pea }		
Jimson weed }		
Sunflower	Branched stem	Unbranched stem
Nettle	Saw-edge leaves	Smooth-margin leaves

HEREDITY IN ANIMALS

NAME OF ANIMAL	DOMINANT CHARACTER	RECESSIVE CHARACTER
Cattle	Hornlessness	Horns
Horse	Trotting	Pacing
Silkworm	Yellow cocoon	White cocoon
Rabbits }	Short fur	Angora fur
Guinea pig }		
Mice	Normal movements	Waltzing habit
Mice }	Pigmented coat	White coat
Rabbits }		
Guinea pig }		
Leghorn poultry	White plumage	Pigmented plumage
Salamander	Dark color	Light color
Canary	Crested head	Plain head
Poultry	Rose comb	Single comb
Poultry	Short rump	Long tail
Land snail	Plain shell	Banded shell
Pomace flies	Red eyes	White eyes

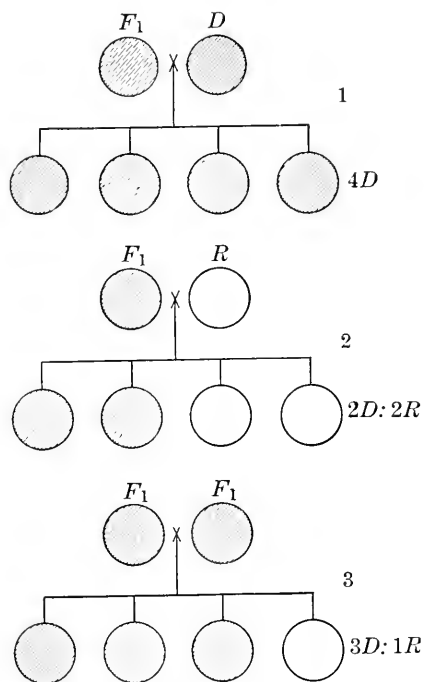

FIG. 238. Mendel's Law of Segregation

When two individuals with a pair of alternative characters are mated, the offspring will all have the character of one of the parents; this character is called the *dominant* one, and the alternative character is called the *recessive*. The hybrid offspring of such a mating is represented in the diagram by F_1 . Offspring of this kind *resemble* the dominant parent D , but experiments show that there is a real difference. If such a hybrid is mated with one of the pure dominant type, 1, the next generation will all *appear* dominant. If such a hybrid is mated with an individual of the recessive type, 2, the offspring will consist of dominants and recessives, in about equal numbers. If two such hybrids are mated, 3, the offspring will show both dominants and recessives, in the proportion of three to one. This splitting up of the offspring of hybrids into two types showing ancestral factors is almost universal; it is called segregation

1. He crossed hybrids with plants of the yellow-seeded parent variety.

2. He crossed hybrids with plants of the green-seeded parent variety.

3. He crossed hybrids with hybrids.

The results of these crosses are indicated in Fig. 238.

This fact of splitting up into the two ancestral types has been found to be quite general among all plants and animals that have been tested, and it is called the *Law of Segregation*. The idea is that the hybrid plant, no matter how much it may resemble one of the parents (with respect to one or more particular characters), does not constitute a pure kind of organism, inasmuch as it cannot reproduce itself in offspring all having the same character.

The plants resulting from the mating of hybrids (that is, the *segregated* yellow-seeded and green-seeded individuals) were experimented with

further, and this remarkable discovery was made: the green-seeded individuals, whether mated with one another or with green-seeded individuals of the original stock, always produced green-seeded offspring. In other words, although they had hybrid parents with yellow seeds, they themselves were pure in the sense that they reproduced or transmitted the green-seeded character to their offspring in exactly the same way as their pure green-seeded ancestors. This principle has been found to hold true in all cases where experiments with plants and animals showing alternative pairs of characters have been carried far enough. An individual of hybrid parentage having a recessive character is called an *extracted recessive*, or the character in question may be spoken of as the *extracted recessive*. It is just as pure with respect to that character as an organism can be.

On the other hand, the yellow-seeded offspring of the yellow-seeded hybrids turned out to be of two kinds: (1) those that produced only yellow seeds in subsequent generations, pure like the yellow-seeded ancestor; (2) those that behaved like their hybrid

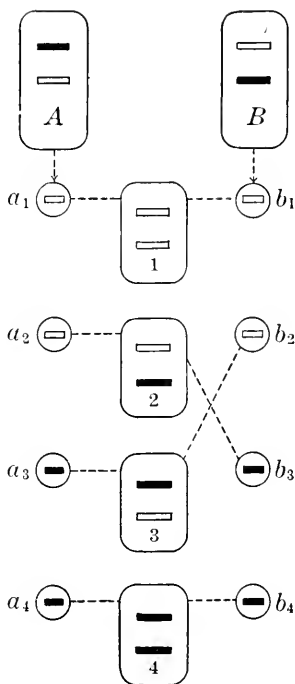

FIG. 239. The Law of Segregation

A hybrid produces germ cells of two kinds with respect to a pair of contrasting characters, — one kind bearing the elements needed for developing the dominant character, and the other kind bearing the elements that result in the recessive. If two individuals, *A* and *B*, both

hybrid and both showing the dominant character, are mated, they may give rise to three kinds of offspring. The germ cells given off by *A* are of two kinds, a_3 and a_4 having the factor for dominance, while a_1 and a_2 bear the factor for recessiveness. In the same way, *B* bears two kinds of germ cells. The two kinds of eggs can combine with the two kinds of sperms in four ways: (1) a recessive egg combines with a recessive sperm; (2) a recessive egg combines with a dominant sperm; (3) a dominant egg combines with a recessive sperm; (4) a dominant egg combines with a dominant sperm. As a result, half the offspring are again hybrid and the other half pure; and the pure are likely to be dominants and recessives in equal numbers. Note that the hybrids resemble the dominant grandparent, giving the *appearance* of one recessive to three dominants

parents, that is, split up again into dominant-appearing and recessive-appearing individuals in the proportion of three to one. The two classes are produced in the ratio of one pure dominant to two mixed or hybrid, although the two classes may have the same appearance.

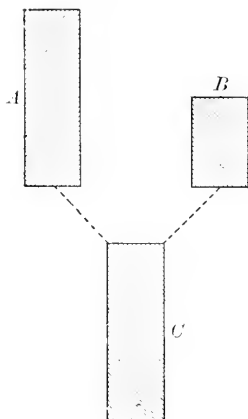

FIG. 240. Inheritance of two or more characters

The offspring of two parents, *A* and *B*, resembles both parents, but it does not, as a rule, stand midway between the parents with respect to the several characters. Instead, the offspring will be like one parent in some characters and like the other parent in other characters

The simplest explanations for these mathematical relations between the characters is to be seen from the diagram in Fig. 239.

472. Combinations of Characters. In the meantime we must not overlook the fact that every organism is made up of many characters. After finding out that his peas showed dominance and segregation with respect to several of the pairs of characters, Mendel went farther and studied the results of his crossings to find out the behavior of *combinations of characters*. For example, suppose that two plants used in an experiment differed with respect to *height* as well as with respect to *seed color*, what would be the results? Experiments showed that if a tall green-seeded parent was crossed with a short yellow-seeded one, the next generation appeared to be all tall yellow, resembling one parent altogether in one character, and the other parent altogether in the other character (see Fig. 240). In succeeding generations the offspring of such a hybrid would show four types — tall-yellow, short-yellow, tall-green, short-green.

The conclusion from this experiment, and many others like it, is that each pair of dominant-recessive characters behaves according to the two laws described above, without regard to what other characters may be present. This general fact has been found to hold for many species of plants and animals

that have been used in experiments, and is sometimes called the *Law of Unit Characters* (see Fig. 241).

This principle will help us to understand how there can be such great diversity among the individuals of any given species of plants or animals, or even among the brothers and sisters of any family. The greater the number of characters, the greater is the possible number of combinations; and the smaller is the chance of any given combination occurring again.

These three laws of heredity — *dominance*, *segregation*, and *unit character*— are known as the *Mendelian* laws, or principles, because they were first discovered by Gregor Mendel.

They have been found sufficiently reliable to serve as a basis for practical work of great importance in connection with the breeding of plants and animals.

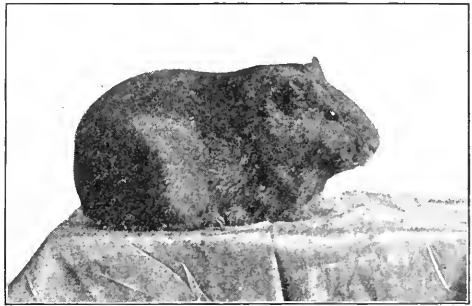

FIG. 241. The law of unit characters illustrated by guinea pigs

Pigmentation in these animals is dominant over albinism. Short hair is dominant over long hair. Rough coat is dominant over smooth coat. When two pure individuals like those shown are mated, the offspring will be short-haired, dark, and rough-coated. On mating the hybrids together in sufficient numbers, the segregation will result in producing every combination of these three sets of characters: dark-short-rough; dark-short-smooth; dark-long-rough; dark-long-smooth; white-short-rough; white-short-smooth; white-long-rough; white-long-smooth. The proportions will be such that *for each pair of contrasted characters* there will be one recessive to every three dominants. (From photographs lent by Professor W. E. Castle)

CHAPTER LXXXI

APPLICATIONS OF THE PRINCIPLES OF HEREDITY

473. Applied Mendelism. In the region about Pullman, Washington, which is one of the best wheat-growing countries in the world, the farmers had for years tried out many varieties of wheat in order to decide which was the most profitable to grow. They found only one variety that was at all satisfactory, and that had serious faults. This variety was known as the "Little Club" and had the advantage over others that the straw was strong enough to withstand the summer storms and that the head remained closed after the grain was ripened, thus preventing loss before harvesting. The one great drawback of the Little Club wheat was the fact that when planted in the fall, it would sometimes be frozen during the severe winters (once in about every three or four years); and although the farmers could get a better crop by planting in the fall, they could not afford to lose every third or fourth planting. The problem was, therefore, to combine the good stem and head qualities of the Little Club with the frost-resisting qualities of some other variety. Mr. W. J. Spillman, of the United States Department of Agriculture, at that time agriculturist of the experiment station at Pullman, began a series of experiments in crossing, or hybridizing, the Little Club wheat with other varieties.

He found that whichever plant (variety) was used as the pollen parent, the next generation always showed the same kinds of combinations of qualities. This is in accordance with what we have learned as Mendel's Law of Dominance.

He also found that in the offspring of the hybrids every possible combination of characters shown by the grandparents occurred. This is in accordance with the Law of Segregation.

By selecting individuals in this third generation and growing from them, and by keeping records of their behavior, he succeeded in finding the strains that had the necessary elements in their germ cells and so transmitted the desired combination of characters, in accordance with the Law of Combinations (see p. 448). In this way it was possible to combine in one variety of wheat the strong stem, the closed head, and the winter-resisting qualities needed for successful wheat farming in this region. By similar methods it has been possible *to combine three or more characters desired in a plant or an animal* from as many different varieties of ancestors.

474. Breeding for immunity. The chief problem of those who have to do with plants and animals is to get organisms that combine desirable qualities and show none of the undesirable qualities. Thus, there are American breeds of cattle raised for beef on the large prairie ranches; they have good beef qualities and are easily handled in large herds. But most of our cattle are very susceptible to the destructive Texas fever, which has caused the death of vast numbers. It had been observed that the "Brahmin" cattle of India were immune to Texas fever. On mating one of these immune animals with one of a susceptible variety the immunity appears as dominant. Brahmin cattle were accordingly imported for crossing with our native cattle, in order to establish a variety having the beef qualities of the American cattle and the immunity to Texas fever.¹ Not every combination of desirable characters appearing in a hybrid plant or animal can be transmitted. It is necessary that the two genes, or elements from the parental germ plasm which determine a given character, be both dominant or both recessive.

¹ In the meantime it has been found out that the Texas fever is transmitted by a little animal known as the tick, which sucks the blood from the diseased cattle. By suitable quarantine it has been possible to restrict the Texas fever; and by applying to the bodies of the cattle something that will either kill the ticks or prevent their biting the cattle, it may be possible to eradicate this costly disease. But if we could replace our present herds of cattle with a type that is quite immune, the added cost would no doubt be made up in a very short time.

Immunity to disease is not always dominant. In the case of wheat, immunity to the rust is recessive. It is nevertheless possible to establish strains of wheat that combine immunity with other desirable qualities, since, as we have seen, it is only necessary to breed the hybrids into the next generation in order to get a complete segregation of the various characters in all possible combinations, and then select in a third generation the offspring that have the desired character in a pure dominant or pure recessive condition.¹

475. Breeding for special points. Those who have to handle cows or sheep often find the presence of horns in these animals a nuisance. Many farmers therefore take steps to prevent the development of the horns by destroying the "button" in the young animal by means of alkali or other chemicals. Occasionally, however, animals have appeared that failed to develop horns at all. When such a naturally hornless animal is mated with one that has horns, the offspring is found to be without horns. In other words, the polled, or hornless, condition is dominant. It is therefore possible to establish breeds of cattle that never produce horns.

In raising sheep certain kinds of fleece are found to be more profitable than others. In order to combine the merino wool with hornlessness, for example, it would be necessary to find out by means of breeding experiments which characters were dominant and which recessive, and then establish in three generations new breeds possessing the desired characters.

476. Practical breeding. The failure of their hybrids to breed true has been the despair of agriculturists and breeders in the past. Only those were successful who, like Luther Burbank, were patient enough to try out large numbers and keen enough to detect the rare individuals that would breed the desirable qualities "true." With the discoveries of the biologists, every intelligent fancier of plants or animals can produce

¹ This is not necessary when plants are propagated vegetatively.

new varieties of organisms without limit, having almost any combinations of useful or fancy characters that he may desire.

This does not mean that *new characters* are produced by these methods. When Burbank produced a "white blackberry" he did not get a plant with a new character, in the

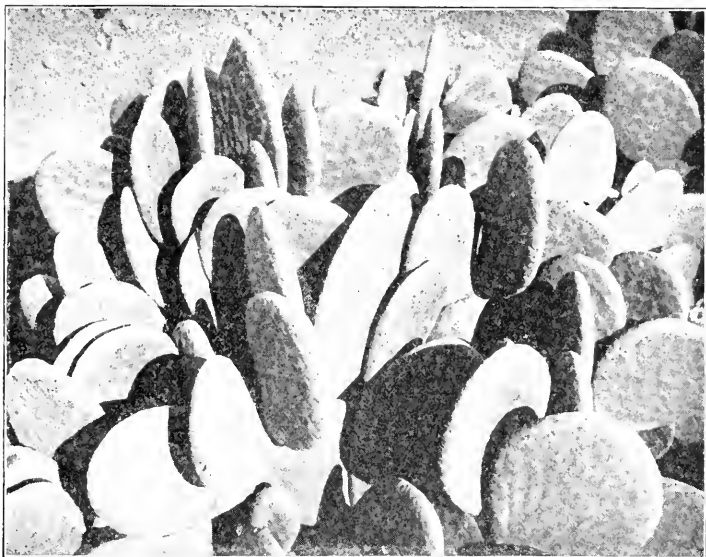

FIG. 242. Spineless cactus (*Opuntia*)

This variety was established by Luther Burbank through experimentation. It grows in arid soil that is otherwise useless, and promises to become a valuable fodder for horses and cattle. (From photograph lent by Mr. Burbank)

biological sense. He combined a plant having pale yellow berries, of no value as fruit, with one having large, black berries,—the Lawton blackberry. From the hybrids he was able to get segregating offspring, and from the latter to fix the individuals that combined lack of pigment with some other desirable qualities in a "pure" state. Another new "creation" of Burbank's is the spineless cactus (see Fig. 242).

Many of the new varieties of plants are hybrids that are incapable of breeding true. These plants are propagated by means of cuttings or

grafts, or by means of bulbs or tubers. The Burbank potato, for example, which is the best-known potato in this country, is propagated by means of the tuber. Seedless varieties of grapes, apples, oranges, plums, and so on would be propagated by grafts or cuttings; and hybrids of various kinds of fruits, although they may have seeds,

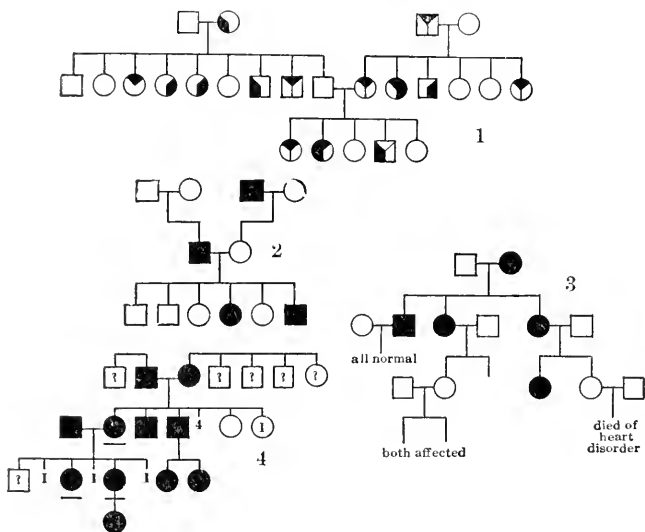

FIG. 243. Heredity of human traits

(Squares represent males; circles represent females.) 1, pedigree of a family showing artistic (dark upper portion), literary (right section), and musical (left section) ability; 2, family with digestive troubles; 3, family with heart disorders; 4, family with feeble-mindedness (*I*, died in infancy; *?*, uncertain mental condition). (1, 2, and 3, after Davenport; 4, after Goddard)

would be propagated in the same way. From what we know of the fact of segregation, we can understand how unreliable the seeds of most common fruits are likely to be, when we consider that most seeds are probably hybrids.

477. Heredity in man. So far as reliable facts are available, heredity seems to follow the same course among human beings as among other organisms.

Human beings take a comparatively long time to mature, so that in order to get complete records for many generations

it would be necessary to go back several centuries ; and such records were not kept in so remote a period. With annual plants and many animals it is possible to get a generation each year, and with some organisms several generations in a year.

The number of offspring in human matings is comparatively small, so that it is never possible to get even an approximation of all the character combinations in any one family. Experiments are, of course, out of the question.

Finally, what we call the human race is really a mixture of many distinct types or combinations of characters, and these are so thoroughly mixed up that we never find a pure race of human beings at the present time.

Nevertheless, by comparing such family records as are available with the behavior of various characters in the pedigrees of plants and animals, it has been possible to show that many human characters follow the same hereditary principles of dominance, segregation, and recombination.

The diagrams in Fig. 243 show the course of certain characters in several carefully studied cases.

The following table gives a list of human characters that are known to be dominant or recessive :

HEREDITY IN MAN

DOMINANT CHARACTER	RECESSIVE CHARACTER
Curly hair	Straight hair
Dark hair	Light ; red
Beaded hair	Even hair
Brown eyes	Blue eyes
Normal pigmentation	Albinism
Hapsburg lip	Normal lip
Normal muscular tone	Low muscular tone
Nervous temperament	Phlegmatic temperament
Fused fingers or toes	Normal digits
Supernumerary digits	Normal number
Broad fingers (lacking one joint)	Normal length
Limb dwarfing	Normal proportion
Normal growth	General dwarfing

The application of our knowledge of heredity to human affairs will probably be along the line of showing us what types of marriages are likely to produce offspring that are undesirable in one way or another. We already know that certain abnormalities of physical structure or of mentality are transmitted in a definite way, and we are therefore warranted in counseling men and women who belong to families that show these characters not to marry others of similar stock. In the course of time we shall no doubt develop certain standards of fitness for marriage which will be enforced largely by the same kind of public opinion and tradition as now distinguishes the customs of different peoples.

CHAPTER LXXXII

HEREDITY AND PROTOPLASM

478. What is inherited? It is common to speak of the inheritance of characters as though something passed on from parents to offspring. But a moment's thought will show that nothing is transmitted in the ordinary literal sense.

What is really meant by saying that a plant or animal has inherited certain characters from his parents is that *there is something in the fertilized egg that makes possible the development of those characters, and whatever is in the egg must have come from the gametes, and so, presumably, from the parents.*

479. Nuclear division. A study of cells shows that the nucleus contains a tangle of substance which behaves in a very definite way before cell division takes place. This substance is called *chromatin* because it readily absorbs various anilin dyes and thus appears highly *colored*, in contrast to other portions of the cell, when looked at under the microscope after treatment with the dyes (Fig. 244). Just before the cell divides, the chromatin breaks up into separate bits of chromatin called *chromosomes*, which means "color-bodies." Each chromosome splits lengthwise into two pieces, and one of these pieces goes into one of the two new cells (see Fig. 244). In this way each cell as it divides distributes one half of its chromosomes to each of the two daughter cells. Thus it comes about that each cell has exactly the same number of chromosomes as the other cells in the body.

480. Formation of germ cells and zygotes. This process of nuclear division goes on as the developing organism continues to grow by the production of new cells. In the formation of

germ cells, however, the chromosomes divide in a different way. In a cell that is to form an egg cell half of the chromosomes separate out; the remaining chromosomes then split

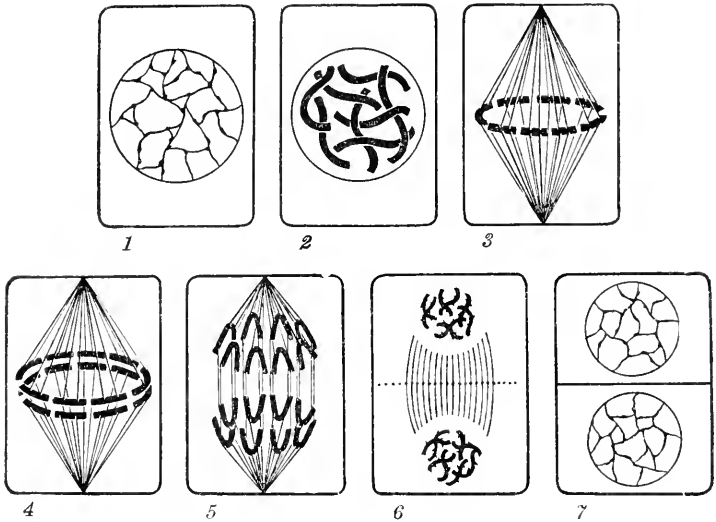

FIG. 244. The nucleus in cell division

1, Diagram of a cell with the chromatin in a tangle, or network; before cell division the chromatin assumes the form of a continuous thread. The thread breaks up into a definite number of pieces, or *chromosomes*, 2; the number of these is constant for any given species of plant or animal. The chromosomes arrange themselves in a central ring, 3; the membrane inclosing the nucleus disappears; fine threads appear to connect the chromosomes with tiny bodies at opposite ends of the cell. Each chromosome splits in two lengthwise, 4. The members of each pair move from each other to opposite ends, 5. The half-chromosomes form two new tangles, 6, and gradually lose their definition. The new masses of chromatin become the nuclei of two new cells, 7

lengthwise (see Fig. 245). As a result of these two divisions, which usually follow each other in rapid succession,¹ the egg cell contains *one fourth of the chromatin* present in the cell from which it was formed, and only *one half of the usual number* of chromosomes. The division which separates the

¹ It is believed that in some cases the splitting of the chromosomes takes place *before* the separation into the reduced numbers.

chromosomes into two groups is called the *reduction division*, since it reduces the *number* of chromosomes.

In the formation of sperm cells also a reduction division occurs. But instead of producing polar bodies the sperm mother cell forms *four sperm cells*.

The polar bodies formed by the maturing of the egg cell die and disappear.

When a sperm cell unites with an egg cell in fertilization, the resulting zygote contains the full number of chromosomes,

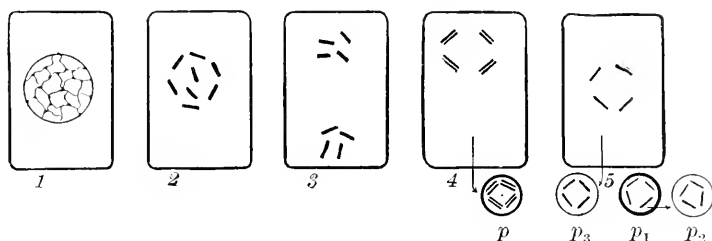

FIG. 245. The formation of an egg cell

The chromatin material of the nucleus network, 1, arranges itself into a definite number of chromosomes, 2, which divide up into two equal groups, 3. Half of the chromosomes are pushed out of the cell, 4, and form the first polar body, p . The chromosomes of the polar body, as well as the chromosomes remaining in the mother cell, split lengthwise, and half of each chromosome is pushed out, 5. The first polar body thus becomes two bodies, p_1 and p_2 , and the mother cell puts out a third polar body, p_3 , retaining half the original number of chromosomes. This cell is now the egg cell

half derived from the male parent and half from the female parent. From all the evidence that is now available it would seem that the chromosomes are the features of the germ cell which bear whatever it is that determines the development of the characters that distinguish the individual from others of the same species, and at the same time those characters that identify it with others of the same species.

481. The germ plasm and acquired characters. According to August Weismann (1834–1914) each organism is what it is because it developed from a certain *germ plasm*. When this organism produces new germ cells, it merely transmits

to these cells some of the germ plasm from which it had itself developed. In other words, the eggs produce the organism, not the organism the eggs (see Fig. 246).

According to this notion it would be impossible for the experience of an individual to influence the germ cells in such a way as to make the offspring show the effects. For example, the result of exercise or of mutilations or of sickness should not appear in the following generation. As a matter of fact we have no evidence whatever that modifications produced in

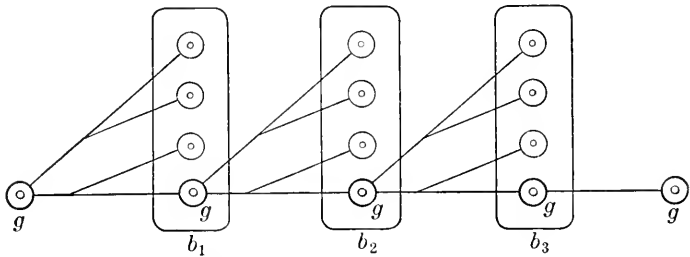

FIG. 246. The idea of the germ plasm

When a fertilized egg, *g*, develops into a new individual, *b*, part of the protoplasm becomes the body, or *soma*, and part remains germ, *within the body*, where it is nurtured. The germ is not a product of the body in any sense. Each body, *b*₁, *b*₂, *b*₃, is a branch, or development, of the germ, but the stream of germ material is continuous. The nature of the germ determines the kind of individuals or persons that will develop: the body does not influence the germ.

an individual in the course of his lifetime are ever reproduced in the offspring, although you will find many people who firmly believe that such modifications are actually transmitted.

482. Sports. The appearance from time to time of an unusual kind of individual that the breeders and horticulturists call a *sport* would suggest that germ plasm may undergo important changes. There appeared on a farm in Massachusetts, in 1791, a queer sheep with a long body and very short, crooked legs. This "ancon" ram was kept for many years, and had many offspring with normal sheep. All the hybrids showed the same curious character. This "turnspit" type of

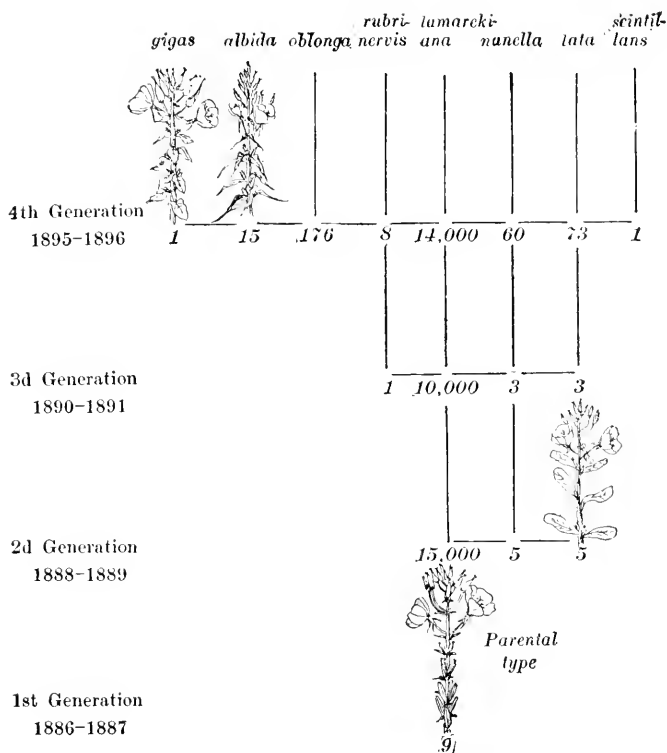

FIG. 247. Mutation in evening primrose

In 1886 Hugo de Vries gathered the seeds from a number of evening primroses (*Enothera lamarckiana*) which he found growing in a vacant lot. These plants are natives of North America, and probably escaped from some Dutch garden. From seeds thus obtained about 15,000 ordinary *lamarckiana* plants were grown, and in addition five peculiar dwarfed individuals (*nanella*) and five with broad leaves (*lata*). These two sets were different from the parents as well as from any other known varieties of *Enothera*. Later these new forms appeared again in very small numbers from very large sowings of *lamarckiana* seeds (third and fourth generations). In the third sowing (1890) another new form appeared, having reddish veins (*rubrinervis*). In the same manner new types have appeared in each succeeding generation, and some of these types appeared anew several times. By means of careful breeding it was possible to preserve the new qualities, and to recombine them with one another and with the contrasting characters of the parent type according to the Mendelian principles

animal is sometimes found among dogs. Peacock fanciers sometimes find a single bird with plain black plumage. Several times whole flocks of such birds have been established from a single freak mated with the normal type.

483. Mutations. In more recent years special attention has been given to these sports by many biologists, and the Dutch botanist Hugo de Vries has developed a theory to account for the origin of new kinds of plants and animals, based on the fact that such freak individuals are often able to establish distinct lines of descendants. De Vries has himself cultivated many lines of new plants that originated in this sudden manner from various wild and cultivated species. Such suddenly arising departures from the ancestral type are called *mutations*, and the individuals bearing these characters for the first time are called *mutants*. De Vries's mutation theory does not attempt to explain how it is that such plants or animals originate; it only tries to show how such mutations may lead to the establishment of new races of organisms (see Fig. 247).

484. Origin of new characters. There are a number of experiments that throw some light on the origin of mutations. One of the best known is that by W. L. Tower, an American biologist, who subjected the eggs and larvæ of potato beetles to various unusual conditions of temperature, moisture, and nutrition. The individuals that developed under these extreme conditions showed no evidence of having been mistreated. But some of the offspring of these beetles departed in a marked way from the usual appearance of their ancestors (see Frontispiece). The conditions to which the beetles were subjected had no direct effect upon the bodies of the animals. But that something really happened to the genes, the elements that determine what characters develop, may be seen from the fact that after mating the "sports" with the normal types and segregating the offspring of the hybrids, it was possible to establish new lines that would breed true.

CHAPTER LXXXIII

EVOLUTION

485. All things change. We understand that we live in a world of change, that in fact all of our experience, all of our life, has to do with these changes. All theoretical studies are concerned with changes ; and all practical studies — agriculture and medicine, engineering and statesmanship — are concerned with three sets of problems. These are

1. *How can we cause desirable changes to take place?*
2. *How can we prevent undesirable changes from taking place?*
3. *How can we best meet the unavoidable changes?*

486. Cyclic changes. Many of the changes that go on about us are of a *cyclic* nature ; that is, they keep on repeating themselves. For example, the day gives way to night, but the night gives way to day again, and so on indefinitely.

Our seasons illustrate cyclic changes. To a mosquito (an individual adult) weather may mean a continuous, progressive change from warm to cold, resulting in death and ending everything.

The seasonal changes show us not only cyclic variations in temperature, moisture, etc. but cyclic changes in the organic world. Eggs hatch, individuals develop to maturity, reproduce themselves, and die. But the following year we see a repetition of the same life histories, and so on, generation after generation. With some species of animals the cycle extends over many years, but the point is that, however far-reaching the individual development may be, it does not go on forever ; it comes to a close and is replaced by others that go through exactly the same kinds of stages. In other words, life forms or life stages

repeat themselves, generation after generation, in the same sense as seasonal conditions of weather repeat themselves.

487. Progressive changes. While much of the happening in the universe is of a cyclic nature, there may nevertheless be, for the world as a whole, a certain continuity of change that has been called *evolution*. We need not feel called upon to prove that *all* changes are altogether cyclic, or that *all* changes are altogether evolutionary. It is quite reasonable and consistent to recognize that both kinds of changes do actually take place.

488. Fossil evidences of evolution. How can we tell whether the plants and animals of past times were different from those of to-day?

The most direct evidence is furnished by the fossilized remains of ancient plants and animals. Some two hundred years ago people became interested in hard coal as a fuel; and in the digging of the coal, and in the digging into the earth alongside of the coal seams, they came across structures that in many ways suggested plant forms. Later they also found stony structures that very decidedly suggested animal forms. A study of these structures naturally led to an attempt to classify them and to compare them with existing plants and animals. These classifications lead to finding many resemblances between the organisms of the past and the organisms of the present, but they also brought out marked differences. Moreover, by arranging the series of fossils according to their relative ages (which can be judged by their relative positions in the layers of rocks) it was found possible in many cases to show that the forms which were intermediate in age were also intermediate in structure between the most ancient and the most recent (Fig. 248). One of the best examples of this is presented by the horse and his probable ancestors (see Fig. 249).

Similar series of fossils have been worked out for the elephant in Africa, for various fishes in England and elsewhere, and for many lines of birds and reptiles in all parts of

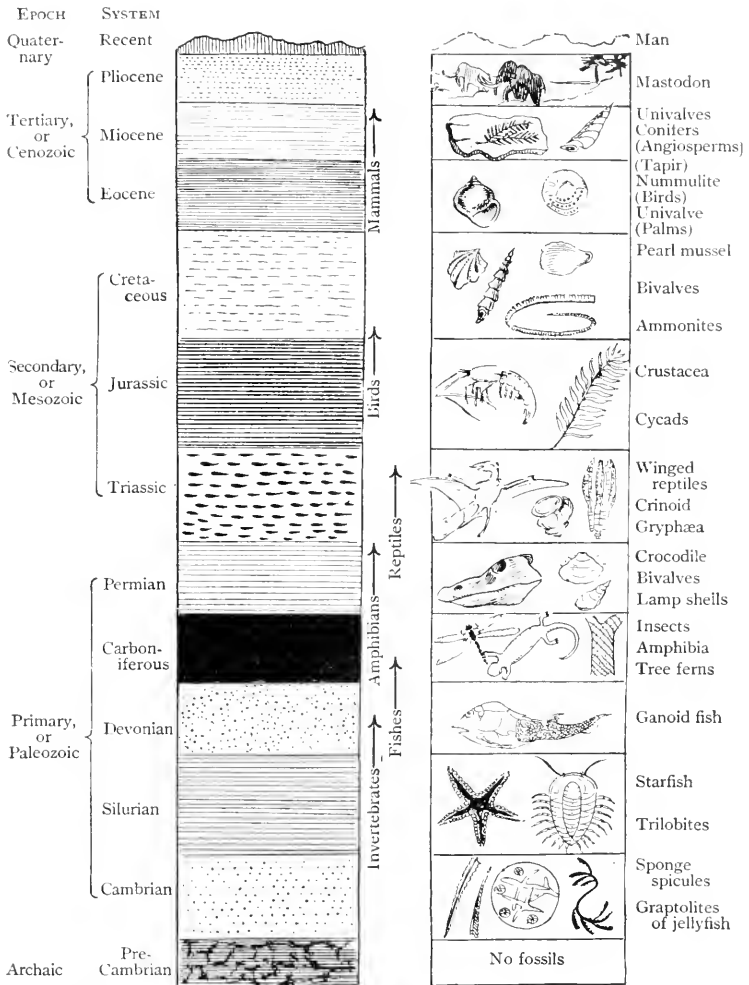

FIG. 248. Geology and evolution

In the oldest rocks no remains of plant or animal life are to be found. In each succeeding age of the earth more and more highly developed plant and animal forms lived, as shown by the remains of the organisms preserved in the rocks

the world. In Germany there has been found a remarkably complete series showing successively different types of snails leading down to the present-day forms. Without regard to the question as to how it comes about that descendants do differ from their ancestors, there can be but one reasonable explanation of the facts,—namely, that there has been modification of plants and animals in the course of their descent.

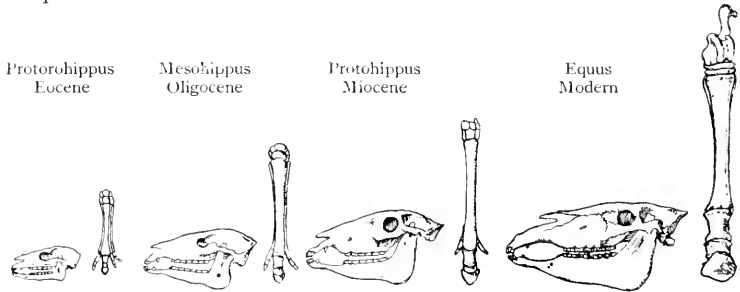

FIG. 249. Evolution of the horse

Our ideas of the probable ancestors of modern animals are based on fossil remains. These represent real organisms that lived thousands and thousands of years ago. In the diagram the oldest type does not resemble the familiar horse very strikingly, but with each succeeding age we find animals having a closer resemblance to the horse of to-day. (After Osborn)

489. Evidence of evolution from structures of organisms. We have observed over and over again that individual plants and animals differ from each other, and that at the same time they resemble each other in groups. The members of a group that are sufficiently alike to be recognized by the casual observer we speak of as being of the "same kind." Thus, while no two oak trees are exactly alike, they are all sufficiently alike to be recognized as of the same *kind*. Now we expect, from our observations, that all the oak trees, however different they may be from each other, will give rise to new plants that will also be enough like the parents to be classed as oaks. And for the same reasons we take it for granted that all the oaks of to-day are related, in the same sense in which we speak of our cousins and second cousins as related. That is to say,

we believe that they are *descended from common ancestors*. An attempt to classify existing plants and animals leads to an arrangement in which similar plants (or animals) are grouped together into species, or kinds, and these species are grouped together into large assemblages, and these into still larger, and so on, on the basis of resemblances. Now, since we assume relationship or common ancestors in proportion to similarities of structure,¹ the classification suggests that if we go back far enough, we shall find that all birds are related (that is, descended from the same ancestors), and that if we go back still farther, we may find that *birds and reptiles* are all descended from common ancestors; or, if we go back still farther, we may find that all backboned animals are descended from the same ancestors.

We can find no reasonable explanation for this "branching-tree arrangement" of the different kinds of living beings, except the supposition that they have descended from common ancestors and have become modified in the course of time.

490. Evidence from development. In our study of development (p. 277) we saw that in the course of each individual's lifetime he passes through a series of more or less distinct stages; and the farther back we go toward the one-celled stage, the more and more are these stages like the corresponding stages of other species of organisms. Moreover, it has been pointed out that the similarities found between different species in the various early stages of development are in a measure parallel to the similarities of the adults or the groups. For example, the larvæ of different kinds of mosquitoes are more alike than are the larvæ of mosquitoes and beetles; the larvæ of insects in general are more alike than the larvæ of insects and crabs; and so on. And in the life history of a mammal there are

¹ Most of our classification is necessarily based upon structure. A comparative study of the structure of organisms—the branch of science known as *morphology*—shows us similarities in detail of structure that are even more remarkable than the superficial resemblances that are obvious to the casual observer.

suggestions of structures found in the life history of birds and of fishes. Now the only explanation of these facts that appears at all reasonable is that there is a common (or similar) development just to the extent that organisms are related through descent from common ancestors.

491. Vestigial structures. Another line of evidence is found in the presence, among plants and animals, of certain organs that

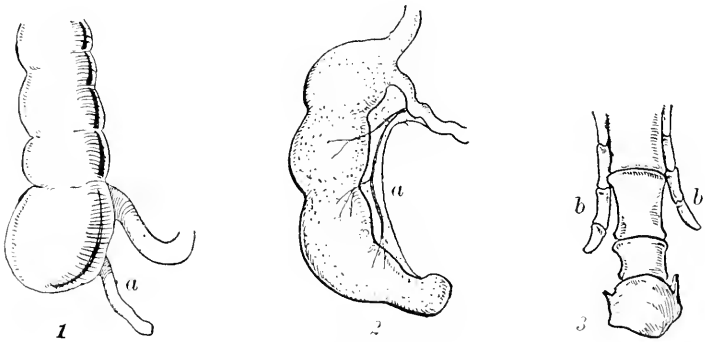

FIG. 250. Vestigial structures

The vermiform appendix, *a*, in some mammals is reduced to an insignificant trifle, as in man, 1; whereas in other mammals, as in some of the rat family, 2, it is capable of holding a considerable amount of food in the process of digestion. The horse walks on his third toe, 3, the others being entirely absent or represented in part by the reduced "splints," *b*

are quite useless from the point of view of adaptation, but which are nevertheless persistent through whole groups. For example, the whale develops legs that are never used, and the same is true of certain snakes. The skeleton of many a bird shows distinct signs of fingers, or claws, among the wing bones.¹ Other examples can be readily understood if we suppose that all plants and all animals are related through having had common ancestors; but they cannot be understood on any other supposition.

¹ The vermiform appendix (see 1, Fig. 28) in man is the lingering reminder of an organ that developed and functioned in other backboned animals, but that has no practical meaning in the life of man to-day—except to make trouble sometimes.

492. Geographic evidence. We expect every group of organisms to expand its range just as far as conditions permit, and we rather expect a given kind of situation to maintain one kind of population and a different kind of situation to maintain a different kind of population. Yet when we examine the distribution of species over the surface of the earth, certain curious facts appear.

In the first place, we find regions in every way similar, so far as climate, soil, etc. are concerned, inhabited by totally different plants and animals. Thus, the climate of Australia is not very different from that of most of Europe and large parts of Africa, Asia, North America, and South America; but when Europeans first came there, they found plants and animals that are not found living naturally in other parts of the world. The same kinds of facts are found in abundance on comparing many regions with one another.

In the second place, we find regions that are very different occupied by forms of plants and animals that are sufficiently similar to be considered as of the same families. Thus, goats and sheep, obviously related to each other genetically, are found in the tropical zones as well as in the temperate, and well up to the arctic and antarctic circles, living in many varied kinds of surroundings.¹

Darwin pointed out that where we have similar regions occupied by different flora and fauna, these regions are always separated from each other by impassable barriers, as oceans, mountain ranges, deserts, etc. On the other hand, where we find similar plants and animals inhabiting regions that are markedly different in their climate, soil, etc., these regions are connected directly or show evidence of having been connected in the past. For example, the plants and animals found in oceanic islands are frequently quite distinct from those found elsewhere, but they are also as a rule closely related to the inhabitants of the nearest mainland. Facts of this kind can easily be explained by the assumption that all the organisms are derived from ancient forms, with modifications, and they cannot be easily explained in any other way.

493. Summary. The evidences for organic evolution or for the descent of plants and animals from common ancestors, with divergence from ancient types, are (1) palæontological, the

¹ Of course we are now speaking of the *natural* range of various wild species.

evidence of fossil remains; (2) systematic and morphological, the evidence from the structure of plants and animals; (3) embryological, the evidence from development; (4) anatomical, the evidence from rudimentary, or vestigial, organs; (5) regional, the evidence from geographic distribution.

The important thing to note is that all the facts in these several groups of facts can be harmonized by the idea of evolution and by no other explanation.

There are many attempts to *explain how* evolution is brought about, and these may be called theories of evolution; but as to *the fact* of evolution biologists are in substantial agreement.

CHAPTER LXXXIV

APPLICATIONS AND THEORIES OF EVOLUTION

494. Direct evidence of evolution. Within the memory of men and women now living there have appeared new varieties of potatoes, apples, plums, oranges, sheep, horses, rabbits, poultry, cats, dogs, walnut trees, wheat, and so on. And the new varieties of plants and animals are, at least in many instances, just as truly new species as any that occur in nature. It is true that very often these new species have arisen under artificial conditions; but it is also true that there is nothing in these conditions that may not occur in nature, except the protection of the new forms from early extermination. We have, then, not only indirect evidence that evolution has taken place, but direct evidence that plants and animals can behave in agreement with the assumption that evolution did take place.

In recent times — within a century and a half — there have been many attempts to formulate a theory to *explain how* evolution takes place. These theories may be grouped according to their family resemblances, but there are only three or four types of theories that are at present worth considering.

495. Lamarckian theory. The French zoölogist Lamarck (1744–1829) laid emphasis on the fact that the development of many organs is influenced by their activity, and on the fact that many organisms (particularly animals) adjust themselves to their surroundings in the course of their lives. He came to the conclusion that “all that has been acquired, begun, or changed in the structure of an individual in the course of its life is preserved in reproduction and transmitted to the new individuals which spring from that which has experienced the change.”

With our present knowledge of physiology and heredity, most of Lamarck's theory is seen to be unsound. Notwithstanding all the evidence to the contrary, however, many people still believe that evolution (and human progress) takes place through the accumulation of the results of experience in the course of generations.

496. Selection theory. The theory of *natural selection* is associated with the name of Charles Darwin (1809-1882), but it was also formulated independently by Alfred Russel Wallace (1823-1913) and Herbert Spencer (1820-1903). This theory is that animal and plant species evolve through the *selective* action of the environment, which kills off those individuals in each generation that are least adapted to the conditions of life,—a process resulting in the "survival of the fittest."

The theory rests on the fact of variation (see pp. 437 ff.) and of overpopulation—that is, the fact that more individuals (eggs, seeds, spores, etc.) are born than can possibly reach maturity and reproduce themselves. It assumes that individual differences may be inherited, whereas the evidence shows that only certain kinds of differences are transmitted to offspring. The theory assumes that the agencies which kill off so large a proportion of each generation are selective, that is, really act upon important individual differences, whereas we know that at every stage of development plants and animals are killed off by agencies and forces and accidents that make no discrimination whatever between the fit and the unfit.

Many studies and experiments in recent years have thrown doubts upon the theory of natural selection. It does not account for the *origin* of new characters, and we know that there is a limit to the improvement that may be brought about by artificial selection. There is at least this much truth in the doctrine, however: plants and animals that are unsuited to the conditions about them, for whatever causes, are not likely to leave similar progeny. Fitness is a requisite for all life.

497. Mutation theory. Charles Darwin had collected many examples of sports that occurred in various crops or herds, but he supposed these to be so exceptional that he did not consider them seriously as the material upon which selection operates in the formation of new species. But Hugo de Vries has emphasized just this class of facts. We saw (p. 462) that he had made direct observations as to the appearance of mutations among plants kept in his gardens and greenhouses, and we saw also that mutations are capable of transmitting their peculiarities to their offspring.

The mutation theory of evolution declares that selection can establish new species only if there first appear *individuals with heritable qualities that are distinctive*. It is not claimed that the mutants have advantages over their parental type, although they *may* have; it is sufficient for the theory if *the new types are capable of living and of establishing themselves*. This theory of evolution, and all the other newer theories, are closely connected with the study of heredity and are supported by the results of experiments.

498. Applications. It should certainly make a practical difference to us which of the many theories of evolution is proved to be true. Suppose we were convinced — as many people are — that the gains and losses of the individual organism affect the constitution of the offspring. Would that not make a difference in our handling of our crops and our domestic animals? Would it not make a difference in the way we conduct human affairs? We might then believe that the son of a criminal *must* be a criminal, or that the son of a judge *must* be righteous. We might make our laws much more rigorous for the children of evildoers, and much more lenient for the offspring of good citizens.

Or, suppose we were certain — as many people are — that the selection theory is true. Then we should follow the recommendations of those who tell us not to build hospitals for the sick, but to let them die — or survive. This recommendation is

made on the supposition that by letting disease kill whom it will, we shall at last have a population that is immune to all diseases. The same people would do nothing to mitigate what they call "the struggle for existence," for they believe that this struggle is necessary to bring out the best qualities of the race and to prevent the multiplication of the unfit.

With the discoveries of recent years regarding the facts of heredity, our whole view of evolution has undergone important changes. For one thing, "struggle for existence" no longer suggests the fierce competition between individuals of a species that it formerly suggested. In the second place, the survival of the fittest can be seen to add nothing *new* to the composition of a line of plants or animals. In the third place, the characters that distinguish one race or variety from another have not necessarily anything to do with being better fitted to live. And, finally, we may think of the progressive changes in species as resulting from the successive modification of the germ plasm, with the elimination of those resulting forms that are not livable.

We have seen that the application of modern *knowledge* about the evolution of organisms has increased our wealth incalculably by establishing varieties of plants and animals that are more resistant to disease or to other unfavorable conditions and by establishing varieties that bear more abundantly of those materials for which we care, — for example, more wool in the case of the sheep, more sugar in the case of the sugar beet, and so on. In similar ways the solution of the problems of evolution must continue to contribute to human welfare on the economic side, and probably also on the social and moral side.

PART VI

MAN AND OTHER ORGANISMS

CHAPTER LXXXV

THE CLASSIFICATION OF ORGANISMS

499. Scientific classification. Apart from the fact that many people derive satisfaction from collecting and sorting various classes of objects, classification is of value because it facilitates the work of reference. Just as the classification of the books in the library makes it possible to find a particular book, or a particular kind of book with the least effort, so classifying plants and animals furnishes a convenient scheme for placing each specimen where it belongs.

In recent times the study of classification has acquired new meaning because of the light it throws on problems of evolution and because of its aid to the study of heredity.

Every scheme for sorting things must provide a way of bringing together plants or animals that are truly related to each other, and it must at the same time avoid bringing together, because of superficial resemblances, plants and animals that are not related.

500. The basis of classification. If we should sort our books according to size or color of binding, we should often bring two books on Mexican history together; but we should be just as likely to bring together a book on Mexican history and one on astronomy, and we should be sure to separate books that really belong together. In the sorting of plants and animals it is necessary to find a basis that will secure the desired results.

The structure of organisms furnishes the basis for modern classifications, but the word *structure* has a wide significance. According to outward appearance we might place certain small snakes with certain large worms ; but a study of the internal structure at once separates them very widely. Again, the appearance of certain caterpillars is much like that of certain worms, but a study of the structure at various stages — that is, the development — at once separates these two groups. Modern classification of organisms accordingly considers *all* that can be known about the living things, and not merely their appearance or their uses.

CHAPTER LXXXVI

KINDS OF PLANTS

501. Higher and lower plants. We often speak of a given kind of plant or animal as being higher or lower than another kind. What we usually have in mind in making this distinction is the fact that some organisms are simpler and others more complex in structure. A dandelion is higher than the taller willow, and the willow is higher than the pine, for the same reason that we consider all three of these plants higher than a fern or a seaweed.

Complexity of structure has to do with the number of different parts or organs. Physiologically this corresponds to a greater division of labor. We may compare three plants to see the general differences as to structure and specialization of functions.

On the vegetative side the *Spirogyra* cell may be considered a complete individual. It is capable of getting from the surrounding water all that it needs to keep it alive, at any portion of the surface. In a moss plant we may already see a division into rootlike part, stemlike part, and leaflike part. The photosynthesis is carried on in one part of the plant; the absorption of water and salts is carried on in another part. The stem is a connecting organ that holds up the leaves and also transports (or, rather, transmits) materials between the two other organs. In the bean plant we see a more complex root, with several kinds of cells (tissues), a more complex stem and a more complex leaf, both having several kinds of cells. The protective layers of cells are different from the supporting (mechanical) tissues; these in turn are different from the conductive tissues and from the photosynthetic tissues.

On the reproductive side we may see a similar advance in complexity from the lowest to the highest of these three plants. In the Spirogyra every cell may act as a gamete, after behaving for some time as a vegetative cell. In the moss certain special cells are borne, in special organs, in a special region of the vegetative plant. And the two gametes (male and female) are borne on two different individuals. In the bean the gametes are still more highly specialized, each being produced in a very simple plant that is parasitic upon the parent. But these two simple plants grow from very highly specialized structures (embryo sac and pollen grain) that are in turn borne on very highly specialized organs (pistils and stamens) which together form a structure (the flower) that is almost completely devoid of any vegetative behavior. In the flower we have an organ that is specialized for producing bodies which have to do exclusively with reproduction and the protection and distribution of the next generation.

502. The basis of classification. While it is possible to say in a general way that a given plant is higher than another, it is quite impossible to place all the known plants in a series from the lowest to the highest. This would be as absurd as trying to arrange all people in a series from the "worst" to the "best." We find that there are several main divisions, some of which we should place higher and some lower. But we find in each division so many degrees of complexity that there is considerable overlapping when it comes to arranging all the plants.

The first separation that we can make is one between plants that bear seeds and those that do not. The seed plants can be further divided into those that bear ovules inclosed in carpels (pistils), like all the flowering plants, and those that bear exposed ovules, like the cone-bearing plants.

Among the non-seed-bearing plants there is a large group in which the egg cell is borne in a special organ, the *archegonium* (see pp. 320-321); this includes the ferns and their allies, the mosses and the liverworts.

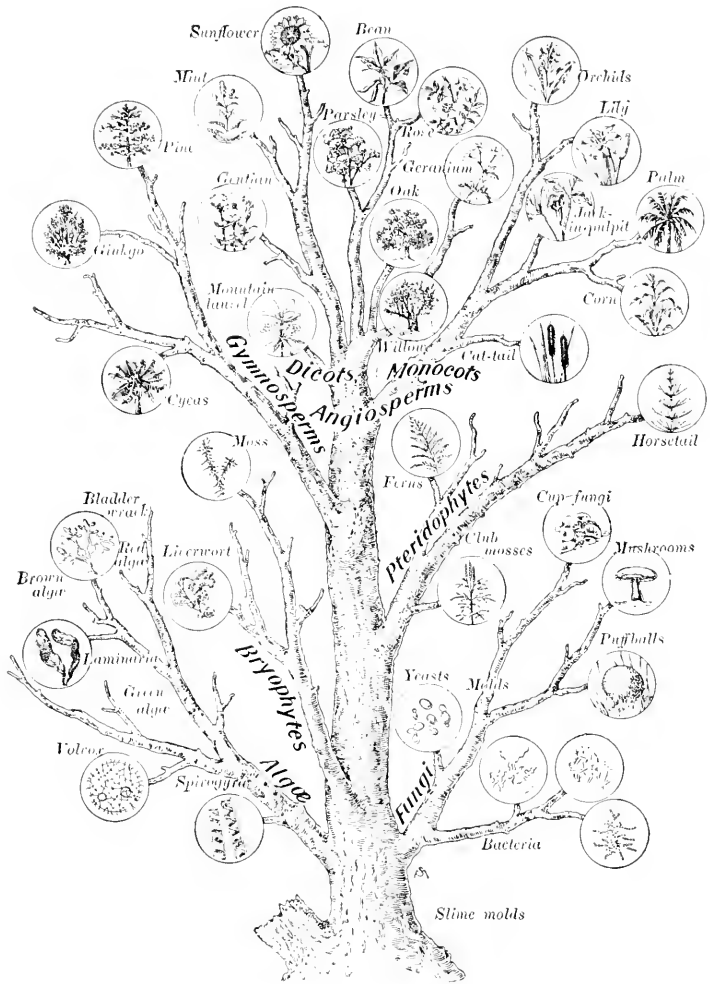

FIG. 251. Genealogical tree of plant life

This diagram is intended to suggest the common origin of all plant forms, with the constant progressive departure from ancestral types, now in one direction and now in another, like the branching of a tree. *Lower* and *higher* mean nearer to or farther from the original types. The closer together two forms are on a given branch, the more closely related they are considered (cf. Fig. 252)

Below the archegonium plants are all those that lack specialized vegetative organs. Here are included all the seaweeds, the bacteria, and the fungi.

503. The main groups of plants. The chief groups of plants are indicated in the following outline :

DIVISION I — THALLOPHYTES. Plants showing no differentiation into true stem and leaf.

- A. Schizophytes ("splitting plants"). Each cell splits into two; no other reproduction.
1. Cyanophyceæ. Splitting plants with chlorophyl, — the blue-green algæ. (*Examples.* Oscillatoria, Rivularia, Nostoc.)
 2. Schizomycetes. Splitting plants without chlorophyl. This group includes all the bacteria.

The distinction between having chlorophyl and not having chlorophyl separates all the thallophytes into two main groups, the algæ and the fungi.

- B. Algæ. The chlorophyl-bearing thallophytes.
1. The green algæ. Usually yellowish green. (*Examples.* Pleurococcus, desmids, Spirogyra, Vaucheria, stonewort, sea lettuce.)
 2. The brown algæ. Mostly marine. (*Examples.* Bladder wrack, Laminaria, Sargassum, diatoms, sea palm.)
 3. The red algæ. Mostly marine; reddish to purple. (*Examples.* Nemalion, Polysiphonia, Batrachospermum.)
- C. Fungi. Thallophytes without chlorophyl.
1. Phycomycetes. Alga-like fungi. (*Examples.* Water molds [often parasitic on fishes], phytophthora [the cause of the potato rot], grape mildew and other parasitic forms, black mold.)
 2. Ascomycetes. Fungi bearing spores in sacs. (*Examples.* Yeast, cup fungi, the edible morel, the mildews, black knot.)
 3. Basidiomycetes. Fungi bearing spores on outside of structure called basidium. (*Examples.* Rusts, smuts, mushrooms, pore fungi, shelf fungus, puffballs.)
- D. Lichens. These curious structures are compound growths of fungi and algæ. The hyphæ in these partnerships generally belong to ascomycetes; the algal partner is a green alga related to pleurococcus or one of the blue-green algæ. (*Examples.* Reindeer moss, Iceland moss, Spanish moss. The common names introduce the word *moss*, although these plants are in no way related to the mosses.)

DIVISION II — BRYOPHYTES. Mosses and their allies. Archegonia but no vascular system.

A. Liverworts.

B. Mosses.

DIVISION III — PTERIDOPHYTES. Ferns and their allies. Archegonia and vascular system; no seeds. (*Examples.* Club mosses, quillworts, scouring rushes (or horsetails), adder's-tongue, maidenhair.)

DIVISION IV — SPERMATOPHYTES. Seed-bearing plants.

A. Gymnosperms. Naked-seed plants. (*Examples.* Sago palm, ginkgo, yews, larches, pines, cypress, sequoia.)

B. Angiosperms. Inclosed-seed plants.

1. Monocotyledons. (*Examples.* Cat-tail, water plantain, grasses, grains and sedges, palms, Indian turnip, rushes, spiderwort, lilies, bananas, orchids.)

2. Dicotyledons.

a. Archichlamydeæ. Flowers having no corolla or one of distinct petals. (*Examples.* Catkin-bearing trees (willows, walnuts, oaks, beeches), smartweed, pink family, buttercup family, water lilies, rose family, bean family, parsley family.)

b. Sympetalæ. Flowers having corollas in which the petals are united. (*Examples.* Heath family, primrose family, gentian family, mint family, morning-glory family, plantain family, madders, honeysuckles, composites, — daisy, aster, sunflower, goldenrod, etc.)

CHAPTER LXXXVII

KINDS OF ANIMALS

504. The classification of animals. Distinctions between higher and lower among animals are based on the same considerations as those among plants,—namely, complexity of structure and specialization of functions. The most striking division among animals is that between the vertebrates (animals having a backbone) and the invertebrates. The latter group is made up of many diverse types that have little in common except the fact that *they are animals*.

505. The main groups of animals. The chief groups of animals are indicated in the following outline :

DIVISION I — PROTOZOA. The simplest animals; body of one cell. (*Examples.* Ameba, Paramecium, Vorticella, Plasmodium of malaria.)

DIVISION II — PORIFERA ("pore-bearing" animals). This includes all the sponges.

DIVISION III — CŒLENTERATA. Radially symmetrical animals having a single cavity in the body; all aquatic, mostly marine.

Class 1 — Hydrozoa. (*Examples.* Fresh-water hydra, certain small jellyfish.)

Class 2 — Actinozoa. (*Examples.* Sea anemones, most corals.)

Class 3 — Scyphozoa. (*Examples.* Most of larger jellyfish.)

DIVISION IV — FLATWORMS (Platyhelminthes). (*Examples.* Tapeworm, liver fluke, planarians.)

DIVISION V — ROUNDWORMS (Nemathelminthes). (*Examples.* Hookworm, trichina, thorn-headed worm.) Many of these animals are dangerous parasites on man or on domestic animals.

DIVISION VI — WHEELWORMS (Trochelminthes). The Rotifera, or wheel animalcules. Mostly microscopic.

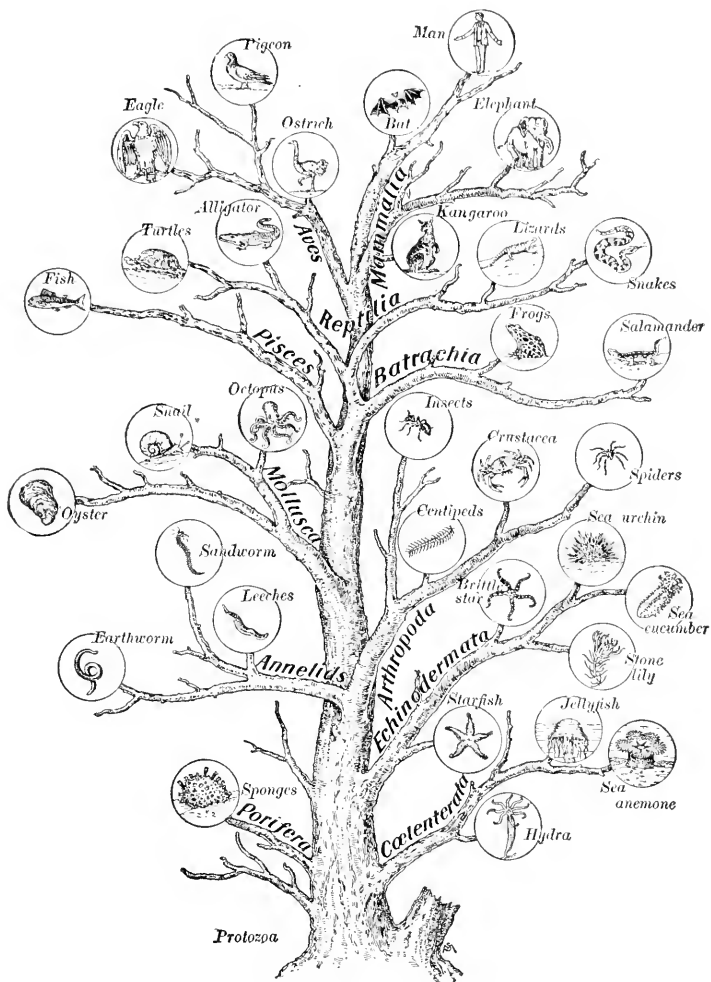

FIG. 252. Genealogical tree of animal life

This diagram is intended to suggest the common origin of all animal forms, with the constant progressive departure from ancestral types, now in one direction and now in another, like the branching of a tree. Of course only the main branches are shown.

There are probably over a million species of animals living to-day (cf. Fig. 251)

DIVISION VII — ECHINODERMATA ("spiny-skinned" animals). Radially symmetrical, all marine.

Class 1 — Asteroidea. Starfish.

Class 2 — Ophiuroidea. Brittle stars.

Class 3 — Echinoidea. Sea urchins.

Class 4 — Holothuroidea. Sea cucumbers.

Class 5 — Crinoidea. Sea lilies.

DIVISION VIII — ANNELIDA ("ringed" animals). Wormlike animals with segmented bodies. The two most important classes are represented by earthworms, sandworms, etc. and by the leeches.

DIVISION IX — ARTHROPODA ("jointed-legged"). The body segmented; exoskeleton.

Class 1 — Myriapoda ("thousand-legged"). (*Examples.* Myriapods, centipede.)

Class 2 — Crustacea ("crusty" shells). Head and thorax fused; water-breathers; antennæ. (*Examples.* Lobster, crayfish, crab, shrimp, barnacle, sow bug.)

Class 3 — Arachnida (spider family). Four pairs of legs; air-breathers; no antennæ. (*Examples.* Scorpions, spiders, daddy longlegs, tarantula, mites, ticks.)

Class 4 — Insecta. Segmented bodies; distinct head, thorax, and abdomen; antennæ, compound eyes; three pairs of legs; one or two pairs of wings (a few forms wingless); air-breathers. A list of the chief orders of this important class is given on page 487.

DIVISION X — MOLLUSCA ("soft" animals). Unsegmented animals, most of them bearing shells.

Class 1 — Gastropods ("belly-footed"). Having shells of a single piece. (*Examples.* Snails, slugs, periwinkle, whelk.)

Class 2 — Pelecypoda ("hatchet-footed"). Bivalve (having shells of two valves). (*Examples.* Oysters, clams, piddock, scallop, mussel, shipworm.)

Class 3 — Cephalopoda ("head-footed"). The foot partly surrounds the head and has a number of arms, or tentacles. (*Examples.* Octopus, cuttlefish, squid, nautilus.)

DIVISION XI — CHORDATA. Animals having a notocord, or internal axial basis for a skeleton. It is from this structure that the vertebral column develops. There are a number of small animals which never develop a true backbone, but which nevertheless have a structure that suggests the beginning of such a column. These are included

among the cordata, although they are not strictly vertebrate. (*Examples.* Acorn worm, lancelet, sea squirt.) The five important classes of vertebrates are

Class 1 — Pisces (fishes). The stone hag and the lamprey are sometimes called fishes, though they are distinct in having a round mouth (no jaws) and no fins or scales. They never develop bones, the skeleton remaining cartilaginous. There are four orders of true fishes:

1. Cartilaginous fishes. Gill slits not covered; "skin teeth." (*Examples.* Skates, torpedoes, sharks.)
2. Armored fishes (*Ganoidei*). Large, bony scales in the skin, especially about the head. In former times this order was very numerous. (*Examples.* Sturgeon and gar pike.)
3. Bony fishes (*Teleostei*). (*Examples.* Salmon, herring, perch, cod, flounder, etc.)
4. Mud fishes (*Dipnoi*). Fishes with lunglike structures. Only three living representatives, all in the southern hemisphere.

Class 2 — Batrachians (amphibia). Breathe by means of gills in early stages, and later develop lungs. Bony skeleton with two pairs of appendages: no exoskeleton. (*Examples.* Frog, toad, newt, salamander, mud puppy, hellbender.)

Class 3 — Reptilia. Wholly air-breathers; plates or scales in the skin. Four orders are usually recognized:

1. Chelonia. (*Examples.* Turtles and tortoises.)
2. Serpents. (*Examples.* Snakes, adders, cobras.)
3. Lacertilia. (*Examples.* Lizards, chameleons, horned toad, Gila monster.)
4. Crocodilia. (*Examples.* Alligators, crocodiles.)

Class 4 — Aves (birds). Warm-blooded; exoskeleton of feathers; front limbs wings; tendency for the bones to fuse; air spaces in bones; no diaphragm; eggs with limy shells. Living species of birds may be divided conveniently into the *running* birds (ostriches, the cassowary, and the emu) and the *flying* birds. The latter include two groups of orders.—the water birds and the land birds. Some of the important orders are

1. Anseres. (*Examples.* Swans, ducks, geese.)
2. Longipennes. (*Examples.* Gulls, petrels, terns.)
3. Pygopodes. (*Examples.* Loons, grebes, auks.)
4. Heron order. (*Examples.* Storks, ibis, bittern.)
5. Plover order. (*Examples.* Snipe, curlew, rail, sandpiper.)
6. Gallinæ. (*Examples.* Hen, turkey, guinea fowl, peacock, pheasant, partridge, ptarmigan.)
7. Columbæ. (*Examples.* Pigeons, doves.)

8. Passeres. Perching birds; includes about one half of our native birds. (*Examples.* Sparrows and finches, swallows, robins, thrushes, crows, etc.)
 9. Raptores. Predatory birds. (*Examples.* Eagle, hawk, owl.)
 10. Pici. (*Examples.* Woodpeckers, sapsuckers.)
 11. Cuckoo family (including kingfishers).
 12. Whip-poor-will order (including humming birds).
- Class 5 — Mammalia (mammals). Warm-blooded; hairy exoskeleton; diaphragm; suckle young.

1. Monotremata. Egg-laying mammals. (*Examples.* Duckbill, spiny anteater.) (With the exception of these two, all mammals develop the young within the body of the mother.)
2. Marsupials. Carry their immature young in a special abdominal pouch. (*Examples.* Kangaroos, wombats, opossums.)

The rest of the mammals are divided into the following orders:

3. Edentata ("toothless" mammals). (*Examples.* Sloths, armadillos, hairy anteaters.)
4. Cetaceans. (*Examples.* Whales, dolphins, porpoises.)
5. Sirenia. (*Examples.* Sea cow, manatee, dugong.)
6. Ungulata ("hoofed" animals).
 - a. Odd-toe. (*Examples.* Horses, zebras, rhinoceros.)
 - b. Even-toe. (*Examples.* Ox, sheep, antelope, camel, giraffe, deer, pig, hippopotamus.)
 - c. Proboscidea (elephants).
7. Rodentia ("gnawers"). The largest order. (*Examples.* Rabbits and hares, squirrels, chipmunks, porcupine, gopher, muskrat, rats, mice.)
8. Insectivora ("insect-eaters"). (*Examples.* Moles, shrews, hedgehog.)
9. Chiroptera ("hand-wings"). (*Examples.* Bats, vampire.)
10. Carnivora ("flesh-eaters"). (*Examples.* Cat family, dog family, bears, weasel, seal, walrus, otter, mink, skunk, badger, raccoon, etc.)
11. Primates ("the first," or leading, order of animals, including man). The families contained in this order are given in the list on page 488.

506. The orders of insects. The insects constitute the most numerous class of animals. The many species show adaptations to all sorts of conditions, and from a human point of view furnish us many friends as well as many enemies.

1. Aptera ("without wings"). The most primitive insects now living. (*Examples.* Silverfish and springtail.)
2. Orthoptera ("straight-winged"). Wings lying parallel with body or folding lengthwise; incomplete metamorphosis; biting mouth. (*Examples.* Locusts, crickets, walking sticks, katydids, cockroaches, mantis.)
3. Neuroptera ("netted-veined wings"). A large group broken up into several orders by entomologists; complete metamorphosis; biting mouth. (*Examples.* Mayflies, dragonflies, termites.)
4. Hemiptera ("half-wings"). Basal part of wings often thickened and without distinct veining; incomplete metamorphosis; sucking mouths. All true bugs. (*Examples.* Squash-bug, bed-bug, water-bug, plant lice, scales, lice, cicada.)
5. Coleoptera ("sheath-wings"). The front wing a hard protective cover; complete metamorphosis; mostly with biting mouth. (*Examples.* Beetles, weevils, fireflies, ladybird, June-bug.)
6. Lepidoptera ("scale-wings"). Rigid membranous wings covered with minute scales; complete metamorphosis; sucking proboscis. (*Examples.* All moths and butterflies.)
7. Diptera ("two-wings"). Hind wings reduced to tiny knobs, or "balancers"; complete metamorphosis; sucking or piercing mouth. (*Examples.* Mosquitoes, gnats, midges, house flies, stable flies, botflies, warbles, fruit flies.)
8. Siphonaptera ("tube-wingless"). Sucking mouth, wings reduced; complete metamorphosis; parasitic on birds and mammals. (*Examples.* Fleas of all kinds.)
9. Hymenoptera ("membrane wings"). Complete metamorphosis; biting or sucking mouth. (*Examples.* Wasps, hornets, bees, ichneumons, ants.)

507. The families of primates. The order Primates is no doubt of great importance in the world, since it includes the human species. From a zoölogical point of view, however, it cannot be considered the highest group of animals, since in many respects the skeleton, the muscles, and the teeth of man and the apes are not so highly specialized as are the corresponding organs of such animals as the whales or the elephants, for example. Nevertheless, the remarkable development of the nervous system among the primates entitles them to a distinctive place in the animal world.

This order consists of the following families :

1. Lemuroidea. Small, squirrel-like animals living in trees and bushes. The lemurs are found in Madagascar, the marmosets in South America.
2. Cebidæ. The New World monkeys. Nearly all have long, grasping tails and flat noses. Smaller than the Old World monkeys. (*Examples.* Howling monkey, spider monkey, capuchin.)
3. Cercopithecidæ. The Old World monkeys. Tail not grasping, or short; nostrils pointing downward. Distinct, opposable thumb. (*Examples.* Baboons, mandrill, macacus, Indian ape.)
4. Simiidæ. The anthropoid (manlike) apes. No distinct tail; arms longer than legs. (*Examples.* Gibbons, orang-utans, chimpanzees, and gorillas.)
5. Hominidæ. The human race.

508. Varieties of the human race. The so-called races of mankind have from earliest times puzzled the thoughtful. On the one hand, the most diverse of peoples are still so much alike as to leave no doubt as to their being human beings. On the other hand, the variations in skin color, in hair characters, in eyes, in shape of head, in form of eyelids, in stature, and in other physical characters are so great as to exceed by far the ranges of "individual variation" found in most other species. In mental characters also, in the rate of development, and in chemical characters (as shown, for example, by distinctive odors of perspiration and by specific immunities to diseases) the races differ in many striking ways. Nevertheless, by every test that zoölogists apply, all belong to the same *species*.

Attempts to classify the species *Homo sapiens* range from three main groups proposed by Linnæus (White, Yellow, Black) to as many as fourteen or sixteen offered by other students. The most common division recognizes five main races, as follows :

1. The *Caucasian*, or white-skinned, or European, races and tribes: hair from pale yellow to black; eyes from blue to brown; wide variation in stature and in form of features. This is to-day, and has been throughout historic times, the most aggressive and masterful branch of the human family.

2. The *Mongolian*, or yellow-skinned, or Asiatic, races and tribes: hair black and straight; eyes dark, with characteristic eyelids; generally shorter than the Caucasians; rather high cheek bones and broad skull. The Chinese and Japanese are the chief representatives. Of very ancient civilization, that seems to have stagnated for a long time; probably likely to play a larger share in world affairs in the future.

3. The *American*, or red-skinned, races and tribes: in many respects the North American Indians resemble the Mongolians. The Eskimos and certain Siberian tribes show remarkable resemblances to both groups. Partly because of the treatment to which they were subjected, and partly because of their racial characteristics, these people are of diminishing importance in the world.

4 and 5. The *Negroid*, or black-skinned, races and tribes: hair black and woolly, or frizzled; eyes dark; nose broad. The African, or Ethiopian, blacks differ in many ways from the Melanesian and Australian blacks. Indeed, but for the color of the skin they should be put into as distinct groups as the Chinese and the Irish, for example. Huxley, who lumps the red-skinned and the yellow-skinned peoples into one race, nevertheless makes two races of the Australian and Melanesian blacks, on the one hand, and the African blacks, on the other.



CHAPTER LXXXVIII

MAN AND HIS RELATIVES

509. Man as organism. Any definition that we can make of living things must apply to man. We have seen that growth and development, irritability and contractility, in general characteristic of the behavior of protoplasm, are also found to be

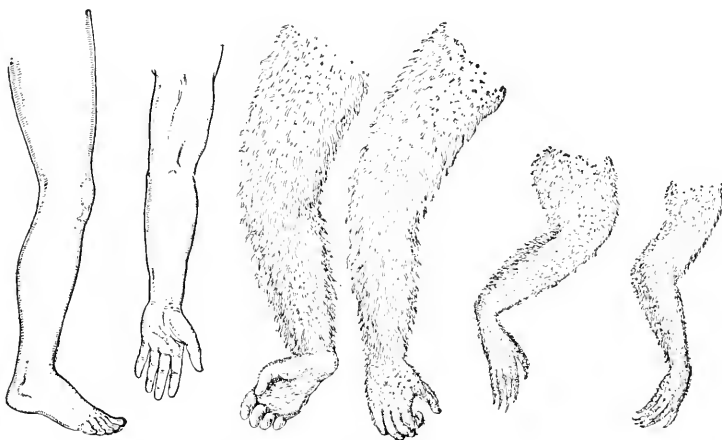

FIG. 253. Limbs of primates

Hind and fore limbs (legs and arms) of man, gorilla, and lemur

essentially the same in human beings. Like other living things man depends upon food and water and oxygen and minerals for his material existence and activities. Like them he is helped as well as hindered by the things about him,—by the living things and by the non-living things. Like them he must at every point adjust himself to his environment or be overcome by it. Like them he reproduces his kind.

510. Man a primate. In trying to place man in the world of animal life we must follow the same methods as would be used if we should find some animal that no one had ever seen before. We have no difficulty in recognizing a newly discovered

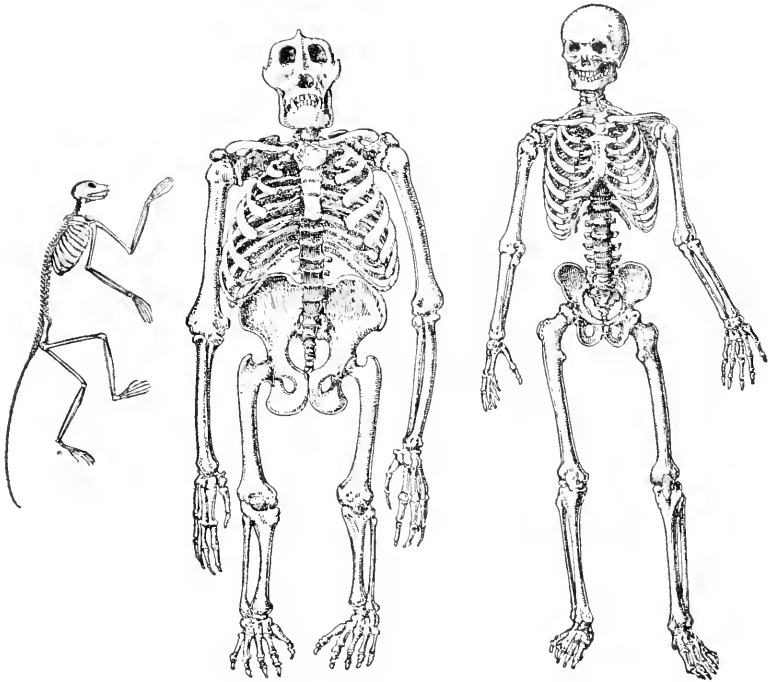

FIG. 254. Comparison of primate skeletons

A comparison of the skeletons of the lemur, the gorilla, and man show many similarities in details as well as in general plan of structure

animal, as, let us say, an insect, even when we see it for the first time. We may be able to tell even in what order of insects it naturally belongs. According to our familiarity with the group, we may be able to tell the family or even the genus.

In the same way we may at once place man among the backboned animals, and, without any hesitation, in the class of

vertebrates known as mammals, because, like the mammals in general, the human species suckles its young and has a hairy outgrowth on the skin. And, of the ten or a dozen orders into which the class Mammalia is usually divided (see p. 486), the highest, or primates, seems best to agree with what we know of our own structure.

In the matter of the limbs, all primates have the thigh quite free from the body, and the hand and foot have five distinct digits, with the first one (inner) usually opposable, thus constituting a grasping organ. The soles of the feet (or hands)

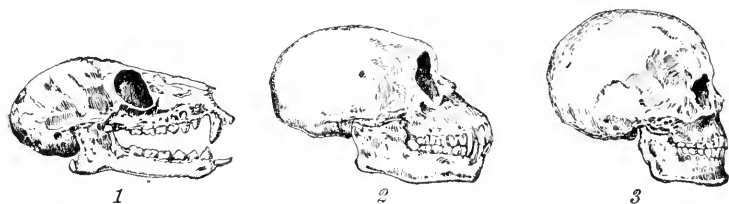

FIG. 255. Skulls of primates

Compare the size of the face and jaw with the size of the brain box. Note the appearance in man of a distinct chin and a nose bridge. 1, lemur; 2, gibbon; 3, man

come down flat on the ground. The lemurs are obviously less like man than are the monkeys, and these less than the apes.

511. Man and other primates. The important differences between man and his nearest living relatives are found in the erect walk, the differentiated appendages, a distinct chin, decidedly larger brain, and articulate speech. Animals other than man are able to get up on their hind legs for longer or shorter periods, but none of them ever acquire the definite, erect walk that all human beings develop (Figs. 253, 254).

It has been pointed out that acquiring the habit of walking altogether on their hind legs gave the ancestors of the human race an opportunity to free their arms and hands for other activities, and that therefore it became possible to develop these organs to higher skill. We must be on our guard against assuming that the evolution of man (or of any other species) proceeded by the hereditary transmission from generation to generation of the effects of practice or experience.

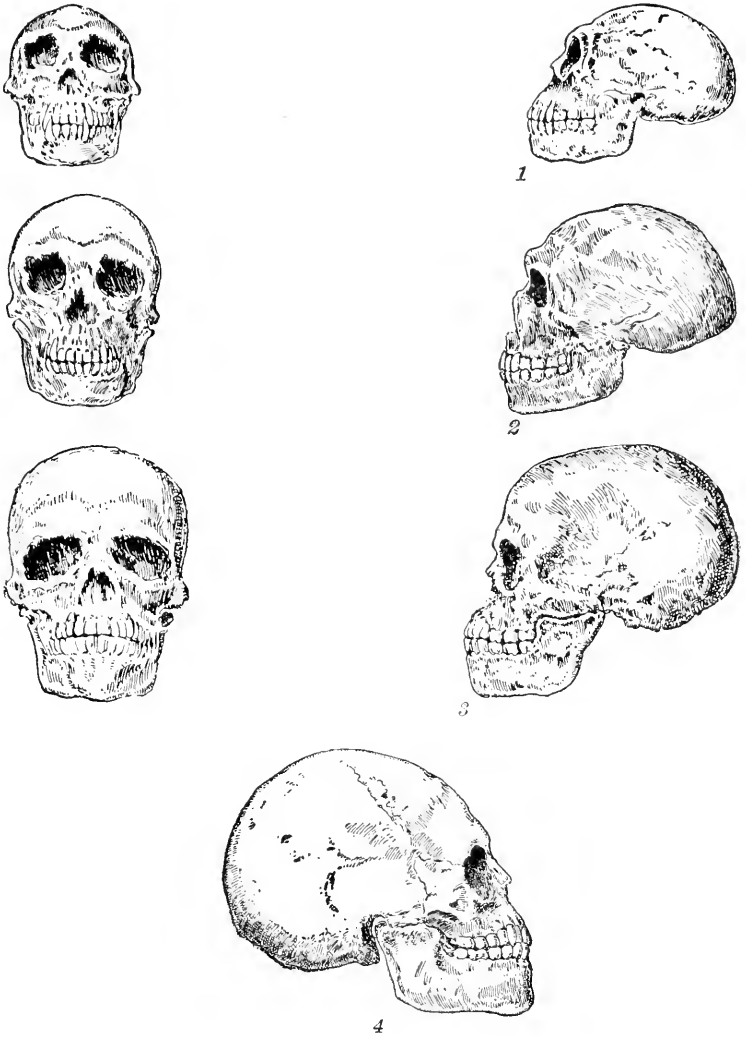

FIG. 256. Ancestors of man represented by remains of skulls

1, *Pithecanthropus erectus*, the "erect ape-man" of Java; 2, the Neanderthal man; 3, the negroid man of Laussel; 4, Nebraska glacial man. These four types represent successive advances in the evolution of the human races, although we must not think of them as a straight series of our ancestors. Compare the size of the brain at different stages of development: Pithecanthropus, 850 cc.; Piltown, 1300 cc.; Neanderthal, 1600 cc.; modern man, 1500-1800 cc.

The larger brain, carrying with it possibilities of learning, imitating, and planning, is perhaps the most important advance made over the simian ancestors (see Fig. 255).

Fig. 256 is a diagram which shows the distinctive traits of several ancient specimens supposed to represent different stages in the evolution of the human species. Fig. 258 represents restorations of some of these primitive forms; from these we can get an idea of how some of the intermediate ancestors probably looked.

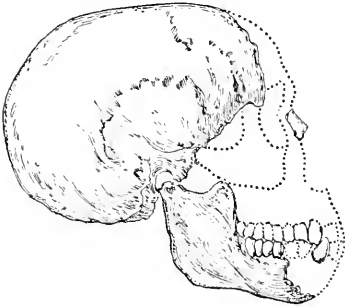

FIG. 257. Fossil remains of man

The pieces of skull, jawbone, and tooth found in England at Piltdown in 1911 represent a lower type of human being than any that had been previously discovered

explanation for the appearance of man upon earth. One of the strongest objections urged against the theory was the fact that it had been impossible to produce a complete record of a graded series connecting man of to-day with his supposed non-human or prehuman ancestors. This argument of the "missing link" carried a great deal of weight with people who did not appreciate how unlikely it would be for complete series of specimens to be preserved through geologic times. Of the millions of human beings and other vertebrates that die in a given region during a century, how many skeletons are likely to remain sufficiently intact to be recognized from ten thousand to fifty thousand years later? From a scientific point of view it would be sufficient if the scattered pieces found at widely different levels (geological ages) do actually fit in with a *supposed* series.

The few bones found in Java by Professor Dubois in 1894 fit into such a series in a very satisfactory way. The type of animal to which these bones belong was named *Pithecanthropus erectus*, and

512. Evolution and man. Fifty years ago much of the discussion among thinking people centered around the question of the validity of the evolution theory as applied to man. There were many who were prepared to believe that evolution has taken place among plants and lower animals, but who hesitated to accept the same

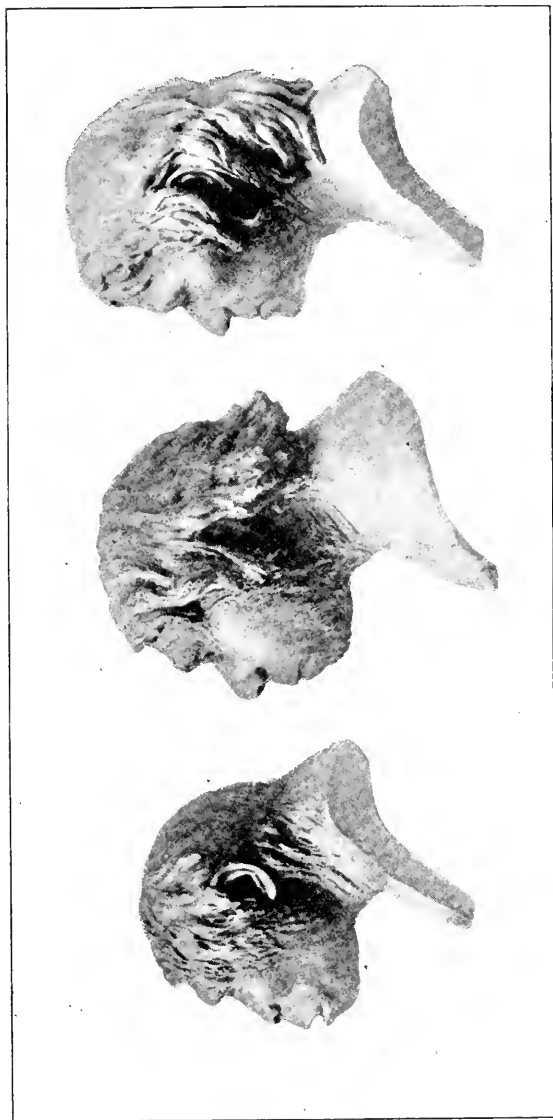

FIG. 258. Three stages in human development

Restorations to suggest the probable appearance of primitive types of human beings. From left to right, *Pithecanthropus erectus* (Java), *Homo neanderthalensis* (Germany), and the "Man of Cro-Magnon," *Homo sapiens* (France). These photographs are of figures moulded by Professor J. H. McGregor on the basis of fragments of primitive man discovered from time to time in various parts of the world

probably represents a "missing link." This animal had among his contemporaries a form of elephant, rhinoceros, Indian hippopotamus, tapir, hyena, a deer, and an animal somewhere between a tiger and a lion. The climate and vegetation were similar in many ways to those we now find in southern India and the islands of that region. This form is in many ways intermediate between the apes and more recent man, but we must not expect it to be an average between the two extremes. It is more like *Homo* in some ways and more like the apes in others; and in some respects it is between, as in the character of some of the teeth.

A more recent discovery of ancient remains in Sussex (England) seems to point to a more closely related ancestor. The skull is larger than that of Pithecanthropus, and the teeth are more like those of modern man (Fig. 257).

Large numbers of specimens have been found in various parts of France, Germany, and Belgium that belong apparently to the same races of primitive men. The first of these was found in a cave in the Neanderthal in Germany, in 1856, and the type is frequently referred to as the Neanderthal race. Although these had much larger skulls than the Piltdown (Sussex),—larger even than is found among races living to-day,—the characters of the jaws and teeth, the low and retreating forehead, the prominent ridges over the eyes, and other features indicate a lower stage of development. This group has been named *Homo primigenius*, or *Homo neanderthalensis*.

CHAPTER LXXXIX

MAN'S BRAIN

513. Hand and brain. The hand of man and the brain of man are the organs that make all the important differences

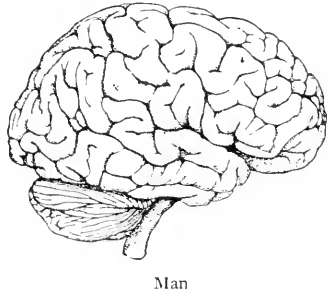
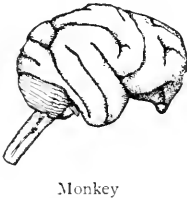
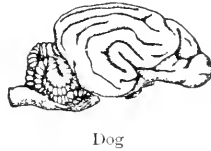
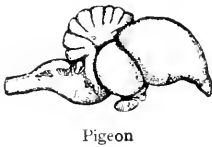

FIG. 259. Brains of vertebrates

Note the relative size of the cerebellum in the bird and mammals. In the mammals note the great increase of cerebrum and the increasing amount of convolution, or wrinkling, of the brain surface. The greater brain area in the higher animals corresponds to greater numbers of association neurons, and thus to greater intelligence

between him and the other animals. And the doings possible for the hand depend finally upon the powers of the brain. It is this organ, therefore, that may properly be considered man's supreme possession.

514. Structure of the brain. In all vertebrate animals the front end of the central nervous system is enlarged into a mass of neurons, connective tissue, and blood vessels constituting the brain (see Fig. 259). In man the brain is not only a larger part of the whole body than it is in any other animal, but it is *absolutely* the largest brain, excepting only that of some of the larger elephants.

The cortex, or "bark," of the cerebrum consists of nerve cells. In mammals this gray layer is very much wrinkled, so that there is relatively more surface than in lower vertebrates. It seems that the extent of the convolution is related to the numbers of cells and to the complexity of their connections. The white part of the brain consists of connecting fibers, or axons.

On the ventral surface of the brain are many connecting nerves, containing efferent and afferent fibers (see pp. 220-223). The hind-brain and the mid-brain have to do with reflexes and automatic movements of various kinds. In the cerebrum, nerve action is connected with consciousness and voluntary movements.

The activities of the heart, the digestive system, the breathing apparatus, etc. may go on indefinitely without being influenced in any way by what happens in the cerebrum, and without producing any effect upon the cerebrum (except to keep it supplied with blood). Many of our activities and movements are unrelated to the cerebrum; but every thought, every conscious desire, and every deliberate or purposeful action depends upon impulses starting from the gray matter in the brain or leading to the gray matter.

Experimental studies upon various mammals, and the experiences with the diseased or injured brains of human beings, have established the fact that each portion of the cerebral cortex is concerned with specific feelings, ideas, or movements. In the diagram in Fig. 260 are indicated some of the localizations of brain function that have been determined in these studies.

The special study of the activities of the cerebrum, as they show themselves in thinking, feeling, willing, is called *psychology*.

515. Tools and weapons. The natives of Madagascar say that if a spear is thrown at a lemur, the animal will catch it and throw it back with deadly precision. Monkeys will crack nuts by pounding them against some hard object, and gorillas

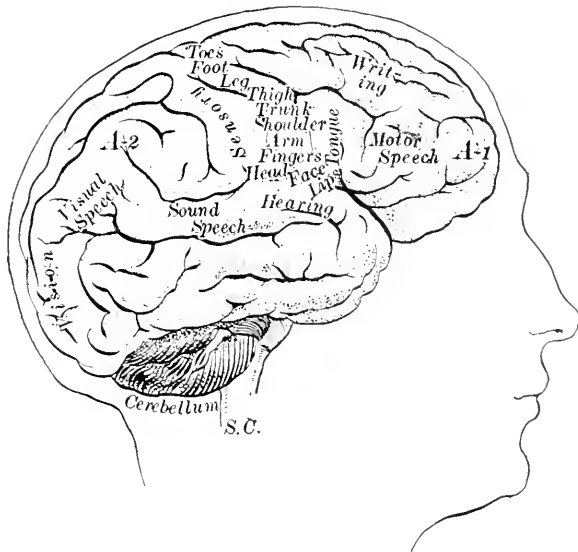

FIG. 260. Localization of functions in the cerebrum

By studying human beings and other animals in which the brain had been injured, and by making experiments, it has been ascertained that certain regions of the brain cortex are related to receiving sensations from specific regions of the body, while other regions initiate movements of specific muscles. Most of the sensory and motor nerves pass through the spinal cord, *SC*. The thinking is carried on by the so-called association areas, *A-1* and *A-2*. The frontal association area has to do with abstract thinking, self-control, concentration, and making decisions. The hind association area has to do with knowing and understanding concrete facts and relations

will fight with a stick used as a club. But probably no gorilla or monkey ever carried a club or a stone about with him for use in possible emergencies, and that is something that man has done. Even among the earliest remains of human activity there are indications that man chipped stones to fit his hand, to be used as weapons or perhaps for breaking shellfish (Fig. 261).

516. Building. Of course other animals have built shelters, and many species of birds build much neater nests than the apes do, and much neater, probably, than primitive man built in the tree tops. But man has finally succeeded in building shelters

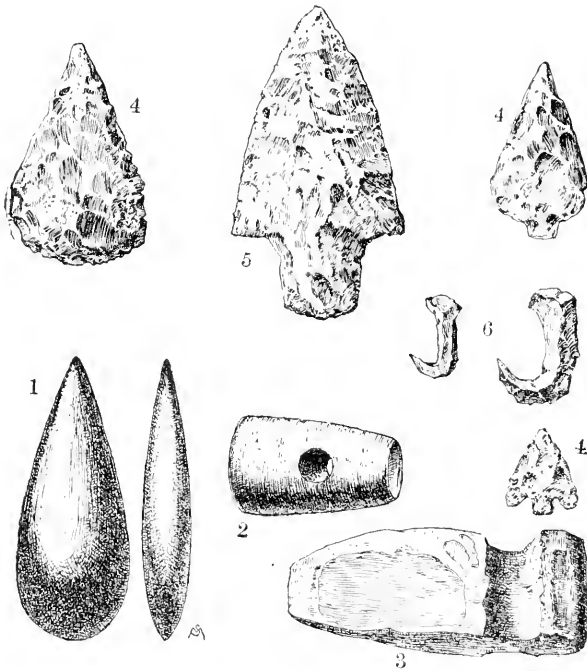

FIG. 261. Relics of man in the Stone Age

1, hatchet; 2, hammer-head; 3, ax; 4, 5, arrowheads; 6, fishhooks. (1, 2, and 4, after Tyler; 3, 5, and 6, original)

so far beyond anything that other animals have made, that it seems ridiculous to compare them. The point is, that although the bees and the birds may build very good shelters, they build the same, generation after generation, controlled in their actions by comparatively fixed impulses or instincts; whereas man has no natural skill or plan for doing these things, yet *can learn*,

because of the constitution of his brain, to make infinitely more complex structures.

517. Fire. What the use of fire has meant to man is hard for most of us to realize, because we have always had the benefits of fire, and grow up accepting it as a matter of course. It made possible his wandering from the tropics ; it made possible his descent from the trees to dwell in caves or even in the open, for with fire he could keep the beasts away ; it made available to him food that he could otherwise not use ; and it was probably helpful in early times in many other ways.

It is not to be wondered that people of all races and in all times have not only seen in fire a great benefactor, but have been impelled to worship the mystery of it as well. Even in our own times the symbolism associated with fire still persists in festivals and religious ceremonials.

518. Speech. Many animals are capable of making several distinct sounds that actually serve as means of warning or other communication between members of the species. The hen, for example, can utter some twenty distinct sounds, and each one has a different meaning. Other animals have been observed to communicate with each other by means of calls or cries. But in human speech there is more than a set of significant ejaculations. Human language comes to be built up into *words*, each of which consists of definite successions of sound (which we represent by means of vowels and consonants), and these words are combined into *sentences* capable of expressing all kinds of ideas. Of course one may say that our language is more complex because our thoughts are more complex, and that is true enough. But human speech differs from the crowing and growling and snarling of other animals in what may be called its structural possibilities as well as in its actual complexity,—it is capable of constant readjustment to the needs of the thinking animal in a way that the expressions of other animals are not. For example, if you have a

new idea, you are quite capable of giving expression to it so that another person can understand you, by means of the language you have acquired. It is not necessary to devise new kinds of noises, and it is not often necessary to make up new words.

But the use of all these things—tools, fire, speech, etc.—is but the external indication of the fact that man has a superior brain. This we can see when we compare, in a general way, man's adjustment to his surroundings with that of other animals.

519. Man's handicaps. It does not take a very close examination to show us that as a living machine man is in many ways decidedly inferior to other animals. For example, his skin is much more tender than that of any other animal of his own size, and the hairy covering is not of much help. When it comes to fighting, his nails and claws are very poor rivals for those of cats, let us say, and his teeth, which he does indeed sometimes use, are not nearly as formidable as are those of many other animals of his own size. His muscular development, too, is rather inferior, when it comes to wrestling with a non-human enemy; and when it comes to running away, he would be easily overtaken by very many of the inhabitants of the forest.

Man has a very good eye, compared to other animals, and a pretty good ear,—though not one of the best, so far as discovering faint sounds is concerned; but his smelling ability is of very low rank. These three senses, which are so valuable to animals in helping them discover their enemies or their prey at a distance, are of great value to man also; but on the whole he has no advantage in competition with the other inhabitants of the forest.

In spite of these various shortcomings man has contrived to hold his own, and some branches of the species have become virtually masters of their environment through the use of the brain. Man has made up for his thin skin by borrowing the skins of other animals and by devising substitutes for skins

(fabrics) out of other material. He has strengthened his arm by means of sticks and stones, and has lengthened his legs — that is, increased his speed — by means of iron and brass. He has extended the reach of his eyesight millions of miles beyond the surface of the earth, and has seen into the world of the little, — a thing no other backboned animal has ever done. He can hear the footsteps of a fly (although he does not need it either for protection or for food), and he has caught vibrations through miles of space. In every direction man has made up for his organic insufficiency by using his thinking organ to guide his hand.

CHAPTER XC

MAN'S CONQUEST OF NATURE

520. Learning from experience. We have seen that one of the peculiarities of the human organism that gives it advantages over others is the fact that it can learn from experience. There are, indeed, other animals that also learn from experience. Experiments made with turtles, cats, crabs, earthworms, starfish, even *Paramecium*, and many other animals show that to a certain extent these organisms can profit from experience.

521. Learning from others. When human beings gather into groups, each one learns not only from his own experience but from the experiences of others. Experiments made with many different animals showed that the monkeys were the only ones that made any attempt to imitate what others were doing; and they were the only ones, therefore, who could possibly learn from the experiences of others.

Among human beings there is the possibility of learning from others, not only through imitation but also through direct instruction. And in the fact that human beings *organize* for various activities (as hunting, fishing, fighting, migrating, etc.), and coöperate, there is a further possibility of learning,—one that other animals do not have in anything like the same degree.

522. Preserving experience. If a wasp should learn a new trick for catching caterpillars, and use it successfully in gathering food for her offspring, her acquired wisdom would die with her, for the eggs which she lays do not hatch out until after she is dead. Among human beings, however, we have an extreme example of the possibility of carrying on the results of experience from generation to generation. Although it is impossible to transmit through heredity the modifications that

occur in the individual organism, it is possible for man to transmit what he has learned, through tradition or ceremonial. Savages who know how to make fire teach their young to go through the *ceremony* of making fire; this is too important, too sacred a thing, to tell a youngster offhand. In the history of primitive peoples we find over and over again that every good idea that they get—and many a foolish one too—is carefully preserved by being organized into a sacred ceremonial that must be performed just so on special days. In this way these people preserve whatever wisdom they manage to gather up, as well as a great deal of what seems to us to be foolish superstition.

523. Knowledge and control. Wherever men have known the relations of forces and materials, wherever they have understood the behavior of plants and animals, they have been able to control nature. And wherever they have controlled they have felt secure and confident, at peace with themselves and with their gods. But wherever they have failed to control, they have been aware of their own weakness; there we find people modest and humble to the last degree; there we find them cringing and fearful and superstitious.

This is well illustrated by the differing attitudes of men toward their industries, on the one hand, and toward their crops and their health, on the other. Men and women who know their trades—that is, who understand the materials and the forces with which they work—are confident about the outcome of their undertakings. They *know* that handling tools in a certain way will produce certain results, and they have no fear, no hesitation, in their undertakings. But when it comes to raising crops or looking after animals, there is no such certainty. These things depend upon the weather—and who can control that? So we find people making mystic signs and muttering magic words to appease the spirits of the wind and the rain, or we find them offering sacrifices—yes, even human sacrifices—to gain the favor of the spirit that controls bugs or mildews. And even then they are not sure of the results, but worry

along in doubt and dread until the crop is ripe. And when the crop is in, they rejoice as those coming to the end of a dangerous journey, and again they have their ceremonials and magic.

We may observe similar attitudes toward problems of health. Before people *know* what causes plague or malaria or tuberculosis, before they *know* what kills their sheep and their potatoes, they are just as fearful, just as superstitious, as they were during the Dark Ages. In those times when witches were burned for bringing on plague by uttering wicked words, or when foreigners were tortured for poisoning wells by making wicked signs, no one *knew* and everyone feared and suspected.

524. The measure of control. We have seen that the use of tested knowledge to solve human problems may bring about *measurable* results; that is, we can measure what difference it makes whether we use the scientific method or some other method. Thus, we can measure how much work it takes to produce a given quantity of potatoes with the use of suitable fertilizer and how much it takes to produce the same without fertilizer, and so find the *advantage* of one method over the other.

The following table shows the number of hours of human labor required to produce by machinery, under conditions that prevailed at the close of the last century, given amounts of various commodities which it took a thousand hours of hand labor to produce under the conditions that prevailed at the close of the Civil War. At the present time every process has been improved so much, especially under the pressure of the Great War, that the figures in the last column may be reduced by one half or more in most cases.

COST IN HUMAN HOURS OF PRODUCING BY MACHINERY
THE EQUIVALENT OF 1000 HOURS OF HAND WORK

UNITS OF VALUE	HOURS	UNITS OF VALUE	HOURS
Barley, 470 bu.	42.4	Books (binding), 2190 vols.	263.4
Corn, 220 bu.	151.3	Shoes, 45 pr.	135.0
Oats, 606 bu.	107.5	Newspapers, 1,750,000 pages	4.8
Potatoes, 2000 bu.	345.3	Envelopes, 230,000	72.6
Wheat, 310 bu.	46.0	Granite (dressing), 6150 sq. ft.	77.9

A study of the average length of life in various countries during the nineteenth century showed that in several countries the average length of life was increased (through the application of the results of scientific study) by as much as from five to twenty-nine years. In India, where alone the people refused to adopt the modern methods, there was no improvement whatever. The table below shows the death rates (number of deaths per thousand of the population in the course of the year) for several different countries. The extremely high death rate of India, compared to that of other countries, or the fact that the average length of life in India is only about twenty-four years, compared to from forty to fifty years in the other countries, shows a measurable difference; and all the evidence that we have indicates that a large part of the difference lies in the different attitudes of the people toward life. There are differences in the theories that people have about the causes of sickness.

DEATH RATES IN VARIOUS COUNTRIES

Denmark (1906)	13.5
Sweden (1906)	14.4
England and Wales (1906)	15.4
United States (registration area, 1907)	16.5
Germany (1905)	19.8
France (1906)	19.9
Italy (1906)	20.8
Japan (1905).	21.9
India (males, 1901)	42.3

The diagram on page 389 shows the steady improvement of health conditions in New York City as measured by the declining death rate for a period of years. Such measurements are constantly being made and are a fair indication of the effectiveness of our ways of doing things. The study of such measurements will tell us just how far it pays to *know*.

525. The social nature of science. What we call knowledge (or, in its organized forms, science) is never the result of an

individual's isolated efforts. It is always the product of human intercourse. Not only does its production involve the *interchange* of thought and experience of many people; it involves also the *preservation* of thoughts and experiences for generations. Each one adds a little to what has gone before; if he did not know what had been learned before him, he would have to start at the beginning, and so each one could get no farther than a child's experience.

Unless we think about the matter for some time, we are not likely to realize how far-reaching is our dependence upon others for the thousands of ideas — useful or entertaining — that we absorb from our surrounding civilization, through books, through customs, through instruction, through social intercourse and various institutions, such as the church, clubs, games, election campaigns, and so on. We get our ideas not only from our immediate neighbors but from all corners of the earth, — not only from our contemporaries but from the remotest antiquity.

Again, our applications are largely social. We have seen this to be the case in hygienic matters. It is impossible for me to save myself from tuberculosis infection by minding my own business or by refraining from spitting etc. My safety depends in large part upon what other people do. The same principle holds in the matter of fighting any plant or animal pest, whether it is merely a nuisance or a menace to our economic welfare. The same thing holds in utilizing most of the great discoveries or inventions, such as the telephone or the wireless, the steam engine or the electric light.

The development of inventions depends not only upon the accumulated knowledge of the past but also on the possibility for joint use. It is only after years of experience with electric-lighting plants, for example, that we may at last contrive to establish a small plant for serving an isolated farmhouse; at first the development is possible only where people live together in communities and exchange their services readily.

CHAPTER XCI

SCIENCE AND CIVILIZATION

526. Casual and purposeful science. Much of the science of the past has been a casual or even accidental product. People just happened to discover this or that. But in modern times — within the last three centuries, and especially during the past fifty years — science is being systematically studied for the purpose of solving special problems. Instead of depending upon an occasional man who is both interested in scientific study and free to devote himself to the study without needing to earn a living, we are coming more and more to provide the opportunity for those who show special aptitudes in that direction. Every large university is in a position to pay a few hundred dollars a year to several students who are willing to devote themselves to special investigations, and who have shown that they have the ability to do work that is worth while. Scholarships for such investigations are provided by the directors of industries who wish to have special problems pertaining to their materials or processes investigated; or wealthy people endow such scholarships as a means of contributing to the general betterment of society.

527. Organization of research. As we come to realize the value of such investigations to the whole nation or to the race, we depend less and less upon the casual endowment of research by people who have money to spare, and depend more and more upon public effort in this direction. Thus, every state in the Union has one or more agricultural experiment stations, in which investigations are being carried on with a view to *finding out* the behavior of different kinds of soil in relation to crops, the most favorable conditions for the growth

of various crops, the best methods for eradicating weeds or exterminating certain insects, how to get the best results from feeding cattle or hens, the best kinds of plants or animals to raise for various purposes, and so on.

The United States Department of Agriculture is not only coöperating with the various state agencies, but is directing special investigations of a kind that may be too costly for a single station to undertake, or on problems that concern the people of more than a single state.

In every large city the department of health has a number of men and women whose business it is to make special investigations on special phases of the local health problems. They study the water supply, the milk supply, the markets, the sewerage system, the disposal of garbage; they examine specimens for the more accurate diagnosis of disease, and they conduct experiments with a view to increasing the accuracy of diagnosis or to shortening the time of diagnosis, for in some diseases a few hours may be of great significance. They experiment for the purpose of improving materials and methods in the preparation of vaccines and serums, and they investigate the relative efficiency of different methods of fighting flies or of ventilating factories or schoolhouses.

The departments of health in the various states are also doing more and more systematic work in extending our knowledge of the conditions that make for health. The United States government contributes to the solution of these problems through the work of the Public Health Service, which not only has the supervision of the marine hospitals, but conducts important investigations on special diseases¹ and on methods for preventing epidemics.

¹ Important investigations were conducted by the United States government scientists, leading to the discovery of the hookworm disease and to the development of methods for curing it among the victims, as well as for preventing it in the future. They made important studies on the relation of rats and fleas to the plague, on the relation of pellagra to the diet, and on other health problems.

In addition to the work done by the departments of the city, state, and national governments,¹ a great deal of scientific investigation is carried on in a number of institutes devoted especially to scientific research. The Rockefeller Institute for Medical Research, the Wistar Institute of Anatomy, the Phipps Institute, the Carnegie Institute, and many others in this country are carrying on scientific investigations in various fields, for the benefit of the public.

It is well understood that science cannot be developed either by those who shut themselves up from the rest of the world or by those who seek to make some private gain through exploiting nature's secrets. Sooner or later the search for the world's truth must come in contact with human knowledge on the one side, and with human welfare on the other. If man is to continue to be master of his environment, it will be first of all because he has learned to organize his machinery for *finding out*, and because he has learned to make general application of what he finds out.

¹ It is impossible to list all the public agencies that are regularly engaged in scientific research, even in this country alone. Some of the important ones besides those mentioned in the text are

The United States Fisheries Commission	The United States National Museum
The United States Bureau of Standards	The United States Census Bureau
The United States Coast and Geodetic Survey	The National Observatory
The United States Bureau of Ethnology	The United States Bureau of Mines
	The United States Weather Bureau

Under the jurisdiction of the Department of Agriculture, investigations are carried on in several different fields by special staffs of scientists. Some of the bureaus, or divisions, are

The Forest Service	The Bureau of Plant Industry
The Biological Survey	The Bureau of Animal Industry
The Bureau of Entomology	The Office of Experiment Stations
The Bureau of Chemistry	The Bureau of Soils

In many cities there have been established, in connection with the education departments, staffs of scientists to investigate various problems arising in the work of education, psychological clinics, and other arrangements for finding out what it is important to know. In a number of cities investigations are being made for the purpose of determining the best way to prevent fires,—of discovering the sources of fire dangers and how best to meet them.

528. Man's place in the world. We have studied the conditions of life and have seen that in every essential respect man is like other living things. We have glanced at man's nature and have seen that in many important respects man is decidedly different from other living things. We do not know when or where or how man first came to use fire or weapons or tools; we do not know when he took to ornamenting his body with paint and beads and feathers and nose-rings; we do not know how he acquired the art of weaving or the art of pottery or how he came to sow seeds or to domesticate animals. We do know that he has been doing these things for hundreds of thousands of years, and that during the past four or five thousand years he has been developing what we like to call civilization. We know that the life of man—that is, civilized man, the man who has the benefit of all the experience of the race—does differ from the life of beasts and from the life of the savage in many important ways.

From the condition in which all activities were concerned with obtaining the means of livelihood, we have passed to the condition in which only a relatively small part of our waking time is needed for this purpose. From a state of uncertainty and fear about the workings of nature,—animate nature and inanimate nature,—we have passed to a very satisfactory knowledge of many of these workings, and to confidence in our methods for finding out more just as rapidly as we apply ourselves to the investigation. From a condition of fear and suspicion toward everything strange,—strange people as well as strange plants and animals,—we have passed to a condition of interest and toleration. We have developed art that may be of value to others, but that interests us in the first place for itself; that is, we have found things to do other than those absolutely necessary to keep us going. In the same way we have become interested in problems the solution of which may be helpful, but which interest us without regard to their possible use; in other words, we have found things to think

about that are not directly concerned with getting our food and dodging our enemies.

Because civilized man has accumulated, in the course of his development, so many kinds of interests, one of his real needs, one that distinguishes him from other animals, is the need for *leisure*. It is not enough to have food and clothing and shelter; the dray horse has that. Man wants time to use in his own way. He wants to play games, he wants to talk things over with people of like minds, and he wants to argue with people of unlike minds. He wants to produce music, or he wants to listen to music. He wants to let himself out in making something of his own design, or at least he wants to look at the pictures and sculptures and handicraft of other people's make. He wants time to think matters over undisturbed, when he is not exhausted, and he wants a change of air and of scene. He would like to see how other people live, and he would like to make new acquaintances. Perhaps he wants to cultivate a garden or keep rabbits. There are thousands of things that men want to do, and the doing of which gives them at least as much satisfaction as any of the activities that are directly related to keeping alive. Indeed, these other things are on the whole far more interesting.

No matter how much we like our food, no matter how much we value the comfort of a warm fireside on a stormy night, or the comfort of a good waterproof when out in the rain, it is these other things that really matter most to-day—these things without which life would still be possible, it is true, but without which our lives would not be very different from the lives of beasts. It is these things that man can do, over and above making his living and keeping his body in working condition, that distinguish him from all other animals. And it is in proportion as these other things play a larger and larger part in our lives, and in proportion as food and clothing and shelter play a smaller and smaller part, that we may consider ourselves humanized.

So far as the race as a whole is concerned, we have already solved the urgent problems of producing the necessities of life. Without extending our science beyond what we know to-day, we are in a position to produce in abundance, and with a very small outlay of human effort, all our food material and all the material needed for our clothing and our dwellings, and for building cities and railroads etc. The Great War has demonstrated our wonderful power and resourcefulness in these respects. On the other hand, it has also made clear our shortcomings. We need to know much more in order to carry on the affairs of community life more effectively (the urgent problems are problems of education, of crime and delinquency, and of political adjustment of individuals and races), and, above all, in order to distribute leisure so that each may live as *human* a life as possible.

INDEX

- Absorption, 40, 87, 114, 118, 477; in nutrition, 260
Acclimating, 131, 257
Accretion, 18
Acetanelid, 257
Acids, 202
Activators, 50
Adaptability, 19, 39
Adaptation, 19, 55, 56; of flowers, 310; and instincts, 244; and purpose, 369
Adenoids, 150 ff.
Adjustment, 131
Adrenin, 189
Adulteration of food, 123, 124
Adventitious roots, 47, 48, 49
Afferent nerves, 219, 221, 222, 498
After-effect, 136
Agglutinins, 196
Agramonte, Aristide, 407
Agriculture, and bacteria, 396; biology and, 4, 67; and birds, 429; and food supply, 75; and forests, 379; and heredity, 450 ff.; and insects, 417 ff.; and science, 506
Air, circulation of, 157; composition of, 12; excess of, 339; and fire, 12; and forests, 378; humidity of, 157; and life, 172-173; pollution of, 158, 396; and protoplasm, 143; temperature standards of, 156
Air cells of lungs, 148
Air requirements of man, 154
Albumen, 51
Alcohol, 133; and Committee of Five, 258; and digestion, 135; and fermentation, 135; fighting the evil of, 139; and infectious disease, 135; and longevity, 134; prohibition of use of, 142; reasons for beginning to drink, 137; and recreation, 140; and the senses, 253; and society, 137, 141; and vinegar, 396; and work, 136
Algæ, 295, 298, 480
Alimentary canal, 81 ff.
Alkaloid, 74, 202, 203, 257; in tea and coffee, 254
All life from life, 19
Alternation of generations, 320 ff.
Ameba, 24, 80, 96, 229, 260, 294, 338, 363
American races, 489
Amino-acids, 104
Amœba, *see* Ameba
Amphibians, 350, 485
Anaerobes, 143
Analysis, 9
Ancestors of man, 493 ff.
Ancon ram, 460
Anesthetics, 259
Angiosperms, 481
Animals, alternation of generations in, 326; classification of, 482; cold-blooded, 337; colonial, 431, 432; compared with plants, 20; genealogical tree, 483; heredity in, 444; infancy among, 333; reproduction in, 327; regulations concerning domestic, 395; useful, and insects, 420
Annelids, 484
Annual plants, 44
Anopheles, 404, 406
Ant lion, 372
Antheridium, 320
Antiseptic, 192
Antiseptic mouth wash, 121
Antiseptic solution, 192
Antitoxin, 193 ff.; for diphtheria, 195
Ants, colony of, 432; destruction wrought by, 413; destructive, 415; extermination of, 416; honey-pot, 433
Aorta, 185
Appendix, vermiform, 82, 468
Appetite, 104, 111; loss of, 118; stimulation of, 117, 138
Arachnids, 484
Arc, reflex, 220
Archegonium, 320, 478
Armors, protective, of organisms, 345

- Arrhenius, Svante, and the nitrogen problem, 63
- Arsenic, becoming accustomed to, 132; insecticide and fungicide, 131
- Artemia, 289
- Artery, 185; pulmonary, 187
- Arthropods, 280, 289, 432, 484
- Arts, development of, 512
- Ascent of sap, 176
- Asexual reproduction, 299
- Asphyxiation, 170
- Assimilation, 18, 50, 260, 265, 285
- Associative neurons, 221, 499
- Astigmatism, 235
- Astringent, 192
- Atwater, W. O., food doctrines of, 90, 93, 99
- Auricle, 185
- Aves, 485
- Axon, 220, 498
- Bacteria, 61; in carbon cycle, 58; control and use of, 394 ff.; and decay, 112, 118; destroyed by cooking, 112; digestion in, 80; and disease, 386; in food, 112, 120; in industry 396; in life cycle, 63; and nitrogen, 62, 67, 396; and soil, 396; on teeth, 120; and wounds, 192
- Bacteriology, 388
- Balance of nature, 423
- Balancing organs, 242
- Bark, in roots, 60; fibers and vessels in, 176, 347
- Bast, 79, 175, 176, 347
- Baths, after meals, 116; hot and cold, 206, 207; public, 396
- Batrachians, 485; reproduction among, 328
- Becker and Hämäläinen, nutritive tables of, 101
- Bee, 329; and orchard, 313; sting of, 373
- Beetle, calosoma, 422; ladybird, 423; potato, 418, 462
- Behavior, as problem of biology, 5; mechanical aspects of, 39, 217, 224
- Bends, 340
- Beriberi, 108
- Biennial plants, 44
- Bile, 86, 118, 184, 216
- Biology, 3; and cost of living, 129; and efficient living, 4; and enjoyment of life, 512-513; and food supply, 130; and health, 3, 507; public protection, 126; applied to saving of life, 393, 507; of the soil, 66; use of, 474; and wealth, 4, 506
- Birds, 485; destruction of, 425; digestive system of, 87; economic value of, 425, 429; eggs of, 330; food of, 425; and insects, 426; migration of, 366, 426; nests of, 371; protection of, 426; undesirable, 429; young of, 334
- Black Hole of Calcutta, 155
- Black hornet, 369
- Blackbird, red-winged, 429
- Bladder, 206, 262
- Bladder wrack, 298
- Blanching of plants, 73
- Blastophaga, 312
- Bleeding, 192
- Blood, 179; changes in, 188; circulation of, 185; clotting of, 181; coordination through, 434; ferments in, 188; a living tissue, 193 ff.; and respiration, 146; a transportation system, 262
- Blood pressure, 190
- Blood system, 264
- Blue jay, 427
- Bluebird, nest of, 370
- Blues, 118
- Bobolink, 429
- Bowels, *see* Intestines
- Brain, structure of, 498
- Brain food, 107
- Brain functions, localization of, 498
- Brains of vertebrates, 497
- Breathing, 144, 148, 149, 172-173; control of, 149; and digestion, 116, 118; habits of, 151 ff.; nose and mouth, 150; in plants, 74 (*see also* Oxidation); summary of hygiene of, 172-173
- Breathlessness, 190
- Breeding, for immunity to disease, 450; for special points, 452
- Breeds, of plants and animals, 438; variation in, 439
- Bristles, 350
- Bronchus, 148
- Bronzed grackle, 427
- Bryophytes, 481
- Bubonic plague, 410
- Buds, first, of seedling, 33; resting, 270
- Buffalo moth, 415, 417
- Burbank, Luther, 452, 453
- Burbank potato, 454

- Burrowing, 368, 370
 Butter, flavor of, 397
 Butterflies, development of, 281
 By-products of organisms, 201
 Cactus, desert vegetation, 359; spineless, 453
 Caffein in coffee and tea, 254
 Calcutta, Black Hole of, 155
 Calorie, 91; measure of daily requirements, 93, 100
 Calorimeter, respiration, 92
 Calosoma beetle, 422
 Calyx, 303
 Cambium, 145, 271, 347; in roots, 44
 Camouflage, 354
 Capillaries, 181, 185, 187, 188
 Carbohydrates, 51, 52, 54, 55, 90, 93, 97 (*see also* Food); digestion of, 81, 85, 87, 112
 Carbon cycle, 57, 58
 Carbon dioxid, 57, 71, 143 ff.; in food-making, 53, 54
 Carbon monoxid, 158, 164
 Carroll, Dr. James, 407, 408
 Casein, 51
 Castle, W. E. 449
 Caucasian race, 488
 Cedar waxwing, 428
 Cells, 21; absorption by, 40; animal, 22; budding, 292; colonies of, 420; differentiated, 431; differentiation of, in development, 275; division of, 76, 265, 274, 275, 291, 457, 458; egg, 299; exchange of material in living, 174; fission (*see* Cells, division of); germ, 447; independent, 76, 430; nerve, 219, 267; nettling, 375; oosphere, 458; origin of, 274, 457, 459; plant, 23; respiration in, 144; sperm, 299, 459; structure of, 21; in tissues, 477; walls of, 57, 345
 Cellulose, 40; digestion of, 112
 Central cylinder, 43
 Cerebellum, 497
 Cerebrum, 497, 498; localization of functions in, 499
 Ceremony, 505
 Chameleon, 362
 Chances of death, 134, 507
 Change, chemical, 7; cyclic, 463; physical, 7; universality of, 7, 463
 Chapin, Dr. Henry Dwight, 109
 Cheese, curd of, 51; curing of, 397
 Chemical changes, 7; in pigments of animals, 353; in soil, 66
 Chemical composition, of air, 23; of carbohydrates, 54; of fats, 55; of food, 51; of human body, 16; of plants, 21; of proteins, 55; of soil, 30
 Chemical cycle of life, 57
 Chemical engine (chlorophyl), 54
 Chemical fixation of nitrogen, 63
 Chemical influence upon development, 289
 Chemical injury to nervous system, 253
 Chemical sense in lowest organisms, 24, 224
 Chewing of food, 81, 115, 117, 119
 Chitin, 346
 Chloral hydrate, 257
 Chlorophyl, 54, 73, 75, 184
 Chloroplast, 54
 Chromatin, 457, 458
 Chromosomes, 457, 458
 Cilia, 295
 Circulation, of air, 157; of blood, 185 ff.; closed and open, 185; depressed, 118; double, 187; and exercise, 116; in plants, 174 ff.
 Circulatory system, 262; hygiene of, 190
 Civilization, 435, 512; and infancy, 335
 Clam, breathing of, 145
 Classification, basis of, 475 ff.; of animals, 482; of organisms, 475; of plants, 478; uses of, 475
 Cleanliness and health, 128
 Climbing plants, 48, 49
 Clothing and health, 152
 Clotting of blood, 181
 Coagulation of blood, 181
 Coal and forests, 380
 Coal seams and fossils, 464
 Cocain, 256
 Cochineal, 413
 Cockroaches, 414; extermination of, 416
 Codein, 257
 Codling moth, 419, 421
 Coelenterata, 432
 Coelenterates, 373, 482
 Coffee, 254
 Cold-blooded animals, 337
 Collaterals, 219
 Colloids, 78
 Colonial animals, 431, 432

- Colors, changes in, 362; warning, 355 (*see also* Pigments)
- Committee of Five on alcohol, 258
- Communicable diseases, transmission of, 387
- Community, 435; life of, 514
- Competition, 343, 344, 474
- Competitive relation, 342
- Compound, chemical, 9
- Concealment, 363
- Conducting system of plant, 174
- Conjugation, in *Paramecium*, 296, 297; in *Spirogyra*, 296
- Connective tissue, 267
- Consciousness, 498
- Conservation, of energy, 10; of food supplies, 112, 129-130; of forest, 382; of manure, 60; of matter, 8; of resources, 4; of sewage, 60; of soil, 68, 380, 381
- Constipation, 88, 118
- Contraction, 24, 218, 360
- Control, by means of knowledge, 505; of breathing, 149; of movements, 217; measure of, 506
- Cooking, 112, 431; waste involved, 112
- Coöperation, 434, 510
- Cooper's hawk, 427
- Coördination, 434
- Cordata, 484
- Corpuscles, 179; red, 183, 184, 262, 294; white, 181, 182, 193 ff., 273
- Correlation of functions, 262
- Cortex, of brain, 220, 498; of root, 43
- Cotyledon, 33
- Crab, hermit, 363, 364; horseshoe, 345
- Crop of bird, 87
- Crops, rotation of, 62, 423
- Crow, 428
- Crustacea, 346, 484
- Crustacean, 289
- Crystalloid, 78
- Cuckoo, 342
- Culex*, 406
- Cup, public drinking, 394
- Cutin, 345
- Cuts, treatment of, 191
- Cuttings for propagation, 48, 269
- Cuttlefish, 363
- Cyclic changes, 463
- Cyst, 295
- Cytolysins, 196
- Cytolysis test, 197
- Dairy and bacteria, 397
- Darwin, Charles, 273, 469, 472
- Death rates, in various countries, 507; from various diseases, 389; of infants, reduction of, 393; diphtheria, 194, 195; malaria, 409; typhoid fever, 299, 392; yellow fever, 409
- Decay of food, 80, 124
- Dehiscent fruit, 316, 317
- Dendrites, 220
- Descent of sap, 176
- Desert land, reclamation of, 68
- Desert plants, 359
- Development, 274, 476; and classification, 476; and metamorphosis, 283; conditions for, 285-289; of plants, 284; stages in, 276
- De Vries, *see* Vries, Hugo de
- Diaphragm, 82, 149, 150, 153
- Diastase, 78
- Dicotyledons, 34, 481
- Diet, and age, 102; and appetite, 111; balanced, 102; and climate, 102; standard, 99; studies of, 89, 90, 510; and work, 100-102
- Dietaries, 90
- Differentiation, 182, 477; of cells, 275, 431
- Diffusion, 40, 76, 78, 83, 85, 144, 147, 174, 179. *See also* Absorption
- Digestion, 78, 80, 110, 111-112; and alcohol, 135; in bacteria, 80; control of, 89, 116; exercise and, 116; in gut, 84-86; hygiene of, 88; in human body, 81; in mouth, 81; organs of, 82, 83, 87; in stomach, 83
- Dimorphic flowers, 304
- Dioecious plants, 306
- Diphtheria, 386; antitoxin of, 195
- Disease, control of, 395, 398; and heredity, 200; microbes as cause of, 200; and parasites, 341
- Diseases, alcohol and infectious, 135; of animals, 420; and insects, 410; mortality rates (*see* Death rates); specific, and bacteria, 386; transmission of communicable, 387
- Division of labor, 262, 434, 477
- Dogs, licensing of, 395
- Dominance, law of, 444, 445, 450, 455
- Dominant characters, 445; in man, 455
- Drowning, 169
- Drowsiness, 118, 155

- Drugs, action on protoplasm, 132; habit-forming, 132, 137, 139, 255; regulations concerning, 257
- Dubois, Professor Eugene, 494
- Dust, and breathing, 155; in industry, 159-161; and occupations, 158; as source of infection, 126, 158, 173, 192
- Dusting, 162
- Ear, 240; in man, 502
- Earthworm, regeneration in, 268; respiration in, 146
- Eating, habits of, 89, 114 ff.; and mental states, 114; and muscular work, 116; pleasures of, 113
- Echinodermata, 347, 484
- Economics, and alcohol, 133, 139, 253 ff.; of bacteria, 388, 394 ff.; and biology, 4, 439 ff., 449, 450 ff.; of birds, 425 ff.; of fatigue, 211, 213 ff.; of food, 122 ff., 128, 388; of forests, 377 ff.; of heredity, 449, 450 ff.; of insects, 311-313, 398 ff., 404 ff., 413 ff., 417 ff.; of photosynthesis, 74, 75; of roots, 46 ff.; of science, 124, 129, 474, 505-506, 512 ff.; of soil, 65 ff., 380, 381; of stems, 176, 202, 377, 453; of tobacco, 167 ff.
- Efferent nerves, 219, 221, 222, 498
- Efficiency, biology and, 4; fatigue and, 211, 216; habits and, 251; health and, 124, 128, 172; smoking and, 166; temperature and, 156; ventilation and, 156
- Egg, of birds, 330; of fishes, 327; of frog, 275; of insects, 279, 281; of mammals, 330; origin of, 457 ff.; of plants, 299, 304, 320 ff.
- Egg cell, 299
- Electric shock, 170, 373
- Elements, chemical, 9
- Elimination of refuse, 88, 118-119, 261
- Embryo, development of, 35, 274 ff.; in seed, 32, 276
- Embryo sac, 302, 303, 324, 325, 478
- Endosperm, 39
- Energesis, 143, 149, 285; and excretion, 262; oxygen in, 143; and respiration, 261
- Energy, 7; chemical, 7, 11; conservation of, 10; daily consumption by body, 93, 100; sources of, 11; transformation of, 13, 70; units of, 91
- Environment, 26; and development, 285 ff.; and health, 214; life and, 337; man's mastery of, 502 ff.
- Enzyme, 78, 79, 396, 397. *See also* Ferments
- Epicotyl, 33, 358
- Epidemics, prevention of, 122, 125 ff., 163 ff., 387 ff., 394 ff., 399 ff., 404 ff.
- Epidermis, 23, 43, 70, 345, 348
- Erosion, 380
- Esophagus, 82
- Etiolation (blanching), 73
- Euglena, 229
- Eustachian tubes, 82, 240
- Evolution, 463, 471; applications of, 473 ff.; evidence of, 464 ff.; of horse, 466; theories of, 471 ff.; and man, 494
- Exchange, in cells, 144, 174; of gas, 73-74
- Excretion, 76, 201, 262; in animals, 203; and fatigue, 208; hygiene of, 205
- Exercise, 116, 118; and breathing, 152; and digestion, 141; and the skin, 207
- Exo-skeleton, 346
- Experience, learning from, 504
- Experiment, problems solved by, 28, 37, 73, 93, 110, 114, 115, 117, 121, 125, 129, 130, 132, 133, 134, 135, 143, 154, 155, 156, 162, 166, 171, 175, 176, 182, 183, 189, 193, 208, 209 ff., 222, 239, 245, 268, 270, 272, 285, 290, 352, 362, 378, 379, 386, 398, 404, 407, 410, 442, 446, 448, 452, 455, 462, 473, 498, 499, 504, 510
- Experiment stations, agricultural, 417
- Expiration, 149
- Extracted recessive, 449
- Eyelids, 232
- Eyes, and light, 229; compound, 230; human, 232, 502; hygiene of, 235; infection of, 237
- Factory regulations for health, 128, 156, 158, 162
- Fall of leaf, 374
- Fat, 51, 52; digestion of, 85-86; origin of, 55
- Fatigue, 208; and efficiency, 210; excretion and, 208; and eyestrain, 236; and health, 215; and rest, 215; and work, 210, 213, 215-216
- Fatigue poisons, 208

- Feather, growth of, 349, 350
 Female, *see* Sex
 Fermentation, 133
 Ferments, 78-79, 80, 85; in blood, 188
 Fern, 322-323; infancy in, 331; spores of, 294
 Fertilization, 299, 302, 303, 323, 327, 328, 459
 Fertilizers for soil, 66, 429
 Festering of wound, 192
 Fever, *see* Diseases, Typhoid fever, Yellow fever
 Fibers, plant, 44, 79, 176; nerve, 219, 498
 Fibrinogen, 181
 Fibrovascular bundles, 44, 70, 175
 Fighting, among ants, 373; against flies, 402; against insects, 422; against mosquitoes, 408; among organisms, 372, 374
 Fire, and air, 12; forest, 385; as source of energy, 11; use of, 501
 First aid, in asphyxiation or drowning, 169; in bleeding, 191-192; for eye, 236
 Fish, 485; breathing in, 147; development of, 282; digestive system of, 87; hatching of, 333; infancy and care of young, 334; migration of, 367; reproduction in, 327
 Fisher, Professor Irving, food tables, 94, 96, 103
 Fission, *see* Cell, division of
 Fitness of organisms, 19, 39, 310 ff. *See also* Adaptation
 Flatworms, 482
 Fleas and plague, 510
 Fleishy fruits, 317
 Flicker of light and eyestrain, 236
 Flies, breeding places, 400; elimination of, 402; house, and food, 399, 400; relation to intestinal disease, 399
 Floods and forests, 379
 Floral envelope, 300
 Flour moth, 415, 416
 Flowering plants, 294, 481
 Flowers, 300, 478; adaptations of, 310 ff.; dimorphic, 304; fertilization in, 303; and insects, 310 ff.; polymorphic, 305
 Fly, Hessian, 419
 Food, 31, 50, 51; adulteration of, 123; of birds, 425; care of, 388; choice of, 89, 98; composition of, 94, 95, 96, 98; conservation of, 129; contamination of, 124, 125; daily needs, 93, 100; decomposition of, 125; and development, 288; digestibility of, 111; distribution of, 130; economics of, 112, 122-123, 129, 130; and flies, 401; fuel, 52; functions of, 51; ideal, 102-103; insects as, 412; kinds of, 51; minerals in, 108, 112; need for bulk in, 118; plant, 31, 50; for plant embryos, 331; preservation of, 124, 125; proportions of, needed, 70, 102-104; protection of, 124, 125-126; public regulation of, 122, 125; relation of light to making of, 39, 53 ff.; in seeds, 35, 46; summary of, 102, 116; taste of, 110; translocation of, 79
 Food habits, 89, 114 ff.
 Food-getting organs, 364, 375
 Fruit, 303; dichiscent, 316; fleshy, 317; and seed, 302; seedless, 303
 Fuel values, 91
 Fumes and the lungs, 158
 Function, biological idea of, 15-16
 Fungi, 294, 341, 480; dangerous to forest, 385; used in fighting insects, 423
 Gall, 86. *See also* Bile
 Galls, insect, 374-375
 Gametes, 297, 324, 332, 478; water essential to, 328
 Gametophyte, 322, 323, 324
 Garbage, 3, 396, 399, 402
 Gas exchange, 73-74, 144, 145; in blood, 188; in leaves, 74
 Gases, injurious, 158
 Gastric juice, 83-84, 110
 Genealogical tree, of animal life, 483; of plant life, 479
 Generations, alternation of, 320 ff.
 Geology and evolution, 464-466
 Geotropism, 37, 38, 241
 Germ carriers, 152
 Germ cells, 447; origin of, 456, 463
 Germ plasm, 459
 Germination, 36
 Gills in respiration, 146, 147, 183
 Gizzard of bird, 87
 Glands, 263; ductless, 188; of intestines, 84, 86, 102; milk, 335; saliva, 81, 83; stimulation of, 110; of stomach, 83, 84

- Glare, 236
 Glucose as adulterant, 123
 Gluten, 51
 Glycogen, 189
 Gonococcus bacteria, 237
 Grackle, bronzed, 427
 Grafting, 270, 271, 272
 Grains, 34, 78, 217
 Gravity, responses to, 38, 241
 Great blue heron, 428
 Green slime, 76
 Growing period of various animals, 335
 Growth, 17; as cause of movement, 38; discontinuous, 269, 292; limits of, 265; and regeneration, 265; in roots, 43; and smoking, 165; in stems, 347
 Guano, 60, 66, 429
 Guard cells, 71, 72
 Gudernatsch, Dr. J. F., 285
 Gullet, 82, 87
 Gut, 84, 101-104. *See also* Intestine
 Gymnosperms, 481
 Gypsy moth, 419, 422
- Habit, 248 ff.; formation of, 150; formation of, by protoplasm, 131
 Habit-forming drugs, 255-257
 Habits, eating, 89, 114; feeling, 250; health, 114-119; kinds of, 249; selection of, 250; thinking, 249; tobacco, 163 ff.; value of, 251
 Habituation, 131, 163
 Haddock, breathing of, 147
 Hæmocyanin, *see* Hemocyanin
 Hæmoglobin, *see* Hemoglobin
 Hairs, of mammals, 349, 350; of plants, 347, 348; root, 42
 Happiness, biology and, 4
 Headache, 118
 Headache powders, 118
 Health, alcohol and, 133; and bacteria, 386; and biology, 1; fatigue and, 215; food and, 89; habits for control of, 114-119; public, 394, 410, 510
 Healing, 266
 Hearing, 238; in fishes, 239
 Heart, 185, 186; beat of, 190; care of, 190; effect of smoking upon, 164; leaky, 190; training of, 191
 Heat, 9, 11, 27, 54, 72, 143, 155, 156, 157, 206, 348, 359, 363 (*see also* Temperature); and living matter, 337-338, 391 (*see also* Frontispiece); measurement of, 91 (*see also* Calorie); from organism, 92
 Hemocyanin, 179
 Hemoglobin, 179, 183, 184
 Heredity, 443; in animals, 444; applications of, 450; and disease, 200; in man, 454, 455; of modifications, 461, 492, 504 (*see also* Frontispiece); in plants, 444; and protoplasm, 457; and theory of evolution, 473, 492 (*see also* Frontispiece)
 Hermit crab, 363, 364
 Heroin, 257
 Heron, great blue, 428
 Hessian fly, 419
 Heterospory, 324
 Home-finding instinct, 363
 Home-making, 368, 371
Homo, 488, 495, 496
 Homology, 365
 Honey, 313, 413, 433
 Honey-pot ant, 433
 Hookworm, 341, 510
 Hormones, 52, 188-189
 Horns, 315
 Horse, evolution of, 460
 Horse botfly, 421
 Horse power, 91
 Horsefly, 398 ff.
 Human race, 455, 488, 501
 Humus, 75
 Huxley, Thomas H., 489
 Hybrid, 445
 Hybridizing, 450
 Hydrotropism in plants, 38-39
 Hypocotyl, 33
- Illumination, 362. *See also* Light
 Imitation, 494, 499; learning by, 504
 Immunity to disease, 198, 452; acquired and natural, 199; active and passive, 200; breeding for, 451
 Indigestion, 115, 118, 135, 138
 Individual differences, 110-111, 198, 234, 258 (*see also* Variation); in digestion of food, 106; in size of stomach, 115; in susceptibility to alcohol, 134; in susceptibility to tobacco, 163
 Individuality, 437
 Industrial dangers, 169, 171, 214, 236
 Industrial hygiene, 128
 Industrial poisons, 158 ff.
 Industry, biology and, 4
 Infancy and parental care, 331 ff.

- Infant mortality, reduction of, 393
 Infection, 386, 387; eye, 237; of food, 152; protection against, 388
 Inhibition, 248
 Ink bag in cuttlefish, 363
 Inorganic, 16-17, 178
 Insecta, 283, 484
 Insects, and birds, 426; damage done by, 418; fighting against, 422 ff.; as food, 412; galls produced by, 374-375; as germ carriers, 126, 398, 410, 420; injurious, 414 ff.; intelligence in, 434; as intermediate hosts, 404; life stages of, 279, 281, 282-283; orders of, 486; predatory, 374; relation to flowers, 309 ff., 312; reproduction in, 329; respiration in, 145; sense organs of, 239, 240, 241; social, 433-435; and useful animals, 420; and useful plants, 417; and wealth, 412; and young, 332
 Inspiration (breathing), 149
 Instincts, 244, 500; home-finding, 363; modification of, 245; relating to young, 334; for selection of food, 90, 110
 Intelligence, 434, 502, 504 ff.
 Interdependence, between organisms, 5, 63, 64, 424, 434, 508; of flowers and insects, 310 ff.; of people, 393, 435, 504, 507, 508, 509 ff.
 Intermediate hosts, 404, 411
 Internal factors in development, 290
 Internal secretions, 188-189
 Intestines, 82, 83, 84, 86-88, 188; evacuation of, 88, 117, 118-119; length of, 106; of various animals compared, 105-106
 Invertebrates, 327, 482
 Invisibility, protection by, 352
 Involuntary muscles, 219
 Irritability, 18, 24, 158, 182, 220, 226, 287
 Jellyfish, 372, 373
 Johannsen, Dr. Wilhelm, 442
 Kallima butterfly, 355
 Kangaroo, 335
 Katydid, 351, 354
 Kidneys, 203, 262; effect of alcohol on, 203; hygiene of, 205
 Knowledge and control, 505
 Kropotkin, Peter, 435
 Lac, insect, 413
 Ladybug (ladybird) beetle, 414, 422
 Lamarckian theory, 471-472
 Lancelet, development of, 274, 276
 Language, human, 501
 Langworthy on daily food consumption, 101
 Lateral line, 238, 239
 Laveran, Alphonse, 404
 Layering, 48
 Lazear, Dr. Jesse W., 407, 408
 Leaf, 70-72, 300; and elimination of refuse, 261; fall of a, 374, 375; gas exchange in, 144; and light, 73; uses of, 74
 Legume family, 62
 Legumin, 51
 Leisure, 513, 514
 Lenticels, 71, 145
 Lice, 410
 Lichens, 480
 Life, without air, 143; and the environment, 336; length of, 507; origin of, 19; salts and, 338; and temperature, 337; unity of, 260
 Light, eyes and, 229; in food-making, 39, 54, 73 ff.; influence on growth of plant, 38, 39; and life, 338; and pigmentation, 352, 362; and tan, 352
 Light tropisms, 230
 Linnæus, 488
 Liver, 85, 86
 Liverworts, 481
 Living bodies, characteristics of, 15
 Living forms, multiplicity of, 260
 Lizard, green, 363; regeneration in, 270
 Lobster, appendages of, 365; breathing in, 146; feeding of young, 332
 Localizations, of brain functions, 498; of functions in cerebrum, 499
 Locomotion, 364
 Locusts, 417
 Lungs, 147, 148 ff., 183; capacity of, 151-152; hygiene of, 151 ff.
 Lymph, 180, 262; coordination through, 434
 Machine, 14, 17; and organisms, 17, 20
 Malaria, 294, 404, 506
 Malaria parasite, 326, 311, 405
 Male and female, 299
 Malt, 78, 133
 Mammalia, 486

- Mammals, 492; egg of, 330; growing period of, 335; hairs of, 349; infancy among, 334
- Man, ancestors of, 493; evolution and, 494 ff.; handicaps of, 502; mastery of environment by, 502-504; as organism, 490, 502; and other primates, 491, 492; place in the world, 490 ff., 512; primitive, 500; relation to other organisms, 6; relics of, in Stone Age, 500; senses of, 502
- Manson, Sir Patrick, 404, 406
- Mantle of mollusks, 346
- Manure, 60, 66; and flies, 399, 402
- Marriages, productive of undesirable offspring, 456; regulation of, 394
- Marsupials, 335, 486
- Matter, composition of, 9; conservation of, 8; kinds of, 9; states of, 7
- Meals, number and frequency, 115-116
- Meal-worm, 414, 416
- Meat in diet, 105-107
- Medicine (*see* Drugs); as source of alcohol habit, 137, 139
- Mendel, Gregor, 443, 446, 448, 449, 461; law of segregation, 446. *See also* Frontispiece
- Mental state and digestion, 114
- Metamorphosis, 283
- Metchnikoff, Élie, 182
- Microbes, 67 (*see also* Bacteria); destroyed by cooking, 112
- Micropyle, 32, 303
- Migration, 365; of birds, 366, 425, 426; of fish, 367
- Milk, care of, 391; food value of, 97, 104; preservatives in, 125; regulations in regard to, 126, 390
- Milk standards, 127
- Milt, 327
- Mimicry, 356, 357, 358
- Minerals, in food, 52, 108, 112, 202; in manufacture of proteins, 56; in plants, 30; in soil, needed by organisms, 66
- Missing link, 494, 496
- Mixed types, 440
- Modifications, by surroundings, 439; transmission of, 461, 492, 504 (*see also* Frontispiece)
- Moisture, and hair formation, 349; and ventilation, 155, 173
- Mold, reproduction in, 292
- Mollusca, 346, 374, 484
- Mollusks, 289
- Molting in cicada, 280
- Mongolian races, 489
- Monocotyledons (monocotyls), 34, 481
- Monococious plants, 306
- Morphin, 199, 256
- Mortality, reduction of infant, in New York City, 393
- Mortality rates, in various countries, 507; for various diseases, 389
- Mosquito, extermination of, 409; fighting against, 408, 409; life histories of, 406
- Moss, alternation of generations, 321; antheridium of, 320; archegonia of, 320; infancy in, 331; life history of a, 320; spore formation, 293
- Moth, brown-tail, 420; buffalo, 415, 416; clothes, 412, 414; codling, 419, 421; flour, 415, 416; gypsy, 419, 420, 422; silk, 413
- Mouth, digestion in, 81-82; watering of, 110, 217, 227
- Mouth-breathing, 150, 151, 173
- Movements, in organisms, 18, 24, 217, 223 (*see also* Muscles); in plants, 361; voluntary, 498
- Mucin, 82, 121
- Mulch, 379
- Muscles, 218, 228; kinds (voluntary and involuntary), 218, 219; reflexes dependent upon, 218
- Mutants, 462
- Mutation, 461, 462, 473
- Mutilation, 269
- Myosin, 51
- Narcotic, 131, 132
- National forests, 385
- Natural selection, 472, 473-474
- Nature, man's conquest of, 504
- Navigation and forests, 379, 381
- Neanderthal man, 493, 495, 496
- Nectar, 309, 310
- Negroid races, 489
- Nerves, 218 ff., 267, 497; development of, 246; effects of smoking on, 164; kinds of, 221, 222; and the reactions of organisms, 217 ff.; and reflexes, 218
- Nervous system, 487; chemical influences, 289; chemical injury to, 253; coördination through, 434; correlation with other systems, 263

- Nest of bluebird, 370
 Nests, 334, 371
 Nettle, 347
 Netting cells, 373
 Neurons, *see* Nerves
 Newt, development of, 282
 Nicotine, 163
 Nictitating membrane, 234
 Nitrates, 60
 Nitrogen, and bacteria, 62; utilization of atmosphere, 63; and war, 64
 Nitrogen cycle, 59, 60, 61
 Nitrogen problem, 61
 Nitrogenous wastes, 90
 Nose as sense organ, 227
 Nosebleed, 192
 Nose-breathing, 150
 Nucleus, cell, 23, 296 ff., 303; division of, 457, 458, 459
 Nutrition, 260
 Nutritive ratio, 97, 100, 103
 Nuts, 317

 Occupational dangers, 158, 235-236
 Occupations, and air, 156; and diet, 101; and dust, 158-162; regulation of, 122-124, 213 ff., 216, 395
 Odors, 202
 Esophagus, *see* Esophagus
 Oleomargarine as butter substitute, 123
 Ommatidium, 232
 One-celled animals, 24
 One-celled plants, 75-77
 Oosphere, 299, 458
 Ophthalmia neonatorum, 237
 Opossum, 335
 Oposonins, 198
 Orchids, 308, 312-313
 Organic, 16, 51, 53, 176
 Organism, 15, 16, 24; how it learns, 245; origin, 19, 291 ff.
 Organs, 15; origin of, 276
 Osmosis, 40-41, 76, 78, 79, 80, 144 ff., 149, 174 ff., 180-181, 188, 201 ff., 260
 Ovary, 301, 302, 303
 Overpopulation, 472
 Ovules, 301, 324
 Oxid, 13
 Oxidation, 13, 59; in organisms, 13, 29, 51, 52, 55, 57, 58, 59, 132, 143 ff., 261
 Oxygen, 12, 52; in engeresis, 143, 144; in photosynthesis, 54
 Oxygen cycle, 59

 Palate, 110
 Palisade cells, 23, 70
 Pancreas, 82, 85, 86, 188
 Paper wasp, 369
 Parallelism in development, 277, 278, 467
 Paramecium, 224 ff.; conjugation in, 296
 Parasites, 410; alternation of generations in, 326; in food, 112
 Parasitic diseases of animals, 420
 Parasitic relations, 341 ff.
 Parasitism, 342
 Parent, dependence of offspring on, 332
 Pasteur, Louis, 133, 386
 Pasteurization, 391
 Patent medicines, 256, 257
 Pawlow, Professor I. P., experiments on digestion, 110
 Pedicel, 70
 Pellagra, relation to diet, 510
 Pepsin, 83
 Peptones, 83
 Peristalsis, 85
 Perspiration, 204
 Petals, 303
 Pflüger, Eduard F. W., experiments on breathing, 143
 Phagocytes, 182
 Pharynx, 82
 Phloem, 79, 174-176, 347
 Photosynthesis, 53-56, 59, 73, 378, 477
 Phototropism, 38, 230
 Physic, 119
 Physical changes, 7
 Physiological variation, 438, 439
 Physiology, 15
 Pickling and bacteria, 397
 Piddock, 368, 370
 Pigments, 202, 203, 287; and food, 354; and light, 288, 351, 352; and temperature, 353; protective, 351
 Piltown skull, 494
 Pisces, 485
 Pistil, 300, 478
 Pith, in root, 43; in stem, 175
 Pithecanthropus erectus, 493, 495, 496
 Plague, 506, 510
 Plants, chemical composition of, 31; classification of, 478; compared with animals, 19; conducting system of, 174 ff.; desert, 359; genealogical tree of plant life, 479; hairs of, 347; heredity in, 444; infancy

- in lower, 330; kinds of, 477, 480; movements in, 37-38; seed-bearing, 478; sensitive, 361; useful, and insects, 417
- Plasma, 179
- Plasmodium of malaria, 404
- Play, 513
- Plumage, color changes in, 286
- Plumbing, regulation of, 395
- Poisons, 118, 131 ff., 194-195, 253 ff., 355; fatigue, 208; in soil, 67
- Polar bodies, 459
- Pollarded trees, 271
- Pollen grain, 324, 478
- Pollen tube, 303, 324
- Pollination, by birds, 306, 307; close and cross, 305; cross, 442; of fig, 311; function of, 304; by hand, 313; by insects, 309, 311; obstacles to close, 305; self, 304; by water, 308; by wind, 308
- Pollution, of air, 396; of water, 122, 392
- Polycotyls, 34
- Polymorphic flowers, 305-307
- Population, and climate, 339; pressure of, 342, 472
- Porifera, 482
- Posture and breathing, 152
- Potato, Burbank, 454
- Practice and learning, 249
- Prairie dogs, 370
- Praying mantis, 372
- Precipitin, 193
- Precipitin test, 197
- Predatory insects, 374
- Predatory relations, 341
- Prepotency, 307
- Preservatives in food, 125, 126
- Pressure, atmospheric, 340
- Primates, 486; families of, 487; limbs of, 490; and man, 491-492; skeletons of, 491; skulls of, 492
- Primitive man. *see* Man
- Production, cost of, 506; of necessities, 514
- Prohibition of alcohol, 142
- Propagation, by roots, 48; vegetative, 269 (*see also* Regeneration)
- Protection, of birds, 426; against infection, 388; of young, 371
- Protective activities, 368
- Protective appearances, 351
- Protective armors, 345
- Protective coloration, 352
- Protective invisibility, 352
- Protective mimicry, 357
- Protective movements, 360
- Protective resemblance, 354
- Protein, 51, 52; daily need, 90, 93; danger of excess of, 90, 104, 107; digestibility of various kinds, 111; digestion of, 35, 83; nutritive ratio, 97; origin of, 55, 60; specific effects of, 107, 108, 109
- Prothallus, 322, 323
- Protoplasm, 21, 24, 80, 131, 132, 181, 224, 228, 229, 265, 275, 287, 291, 295, 298, 302, 303, 337, 490; heredity and, 457; light destructive to, 38, 339; movements of, 21; needs of, 50
- Protozoa, 295, 341, 404, 482
- Protozoön, 294
- Proventriculus of bird, 87
- Psychology, 498
- Ptarmigan, 286
- Pteridophytes, 481
- Pulmonary artery, 187
- Pulse, 190
- Punnett, Professor R. C., 358
- Pure lines, 442
- Pure races, 447, 455
- Purpose, 222-223, 225, 310, 332, 358, 369, 433-434, 498, 509
- Pylorus, 82
- Quarantine, 395
- Quills, 350
- Rabbits accustomed to poison, 132
- Rabies, 395
- Rats and bubonic plague, 410, 510
- Ray (fish), 373
- Reaction of organism, general, 224; and nerves, 217
- Recapitulation in development, 278
- Recessive character, 444 ff., 450 ff.; in man, 455
- Reclamation, 68
- Recombination of characters, 455
- Rectum, 82
- Red-headed woodpecker, 428
- Reduction division, 459
- Reed, Dr. Walter, 407
- Reflex, 217 ff., 498; as adaptation, 244; chains, 244; without consciousness, 222; nerve connections in, 221; using an animal's, 217
- Refrigeration, 390

- Regeneration, 268; in earthworm, 268; of the eye, 268; and growth, 265; in lizard, 270; in plants, 47, 269-270; in starfish, 269
- Registration of vital statistics, 395
- Regulators, 50
- Reproduction, 291; in animals, 327; asexual and sexual, 299, 328; among batrachians, 328; in fern, 322; in fishes, 327; in insects, 329; in vertebrates, 330
- Reptiles, egg of, 330
- Reptilia, 485
- Research, organization of, 509; scientific, 511
- Resemblances, protective, 354
- Respiration, 144; artificial, 170-171; blood and, 146; calorimeter, 92; and energetics, 261
- Respirator, 161
- Rest and work, 214
- Resuscitation, 170 ff.
- Reversal of physiological effects, 136
- Rexford food tables, 97, 98
- Rickets (rachitis), 108
- Rockweed, 298
- Roots, 32, 42, 300, 477; adventitious, 47, 49; as binding agents, 46, 47; climbing, 48, 49; and elimination of refuse, 261; forms of, 44, 45; prop, 47, 49; structure of, 42, 43; tap-, 45; tubercles, 62; uses of, 46-49
- Root hairs, 42, 44
- Root pressure, 45
- Ross, Sir Ronald, 404
- Rotation of crops, 62-63, 423
- Rotting of flax, 396
- Roundworm, 482
- Salamander, regeneration in, 268
- Saliva, 78, 81, 82
- Salivary glands, 83
- Salts, and life, 339; relation to proteins, 556; relation to protoplasm, 52, 339; in soil, 30, 66
- Sand dunes, 46
- San José scale, 419
- Sap in plants, 46, 176 ff.
- Sapsucker, yellow-bellied, 427
- Scale, San José, 419
- Scales of fishes and reptiles, 350
- Scholarship and smoking, 165
- School lunches, 128
- Science, and agriculture, 67; and cost of living, 124, 129, 506; and natural resources, 69; origin of, 509; and research, 511; social nature of, 507
- Scion, 271
- Screening against flies, 403
- Seedless fruit, 303, 454
- Seedling, 35, 36
- Seeds, 32, 315; and alternation of generations, 324, 325; distribution of, 317 ff.; embryo in, 33; escape of, 316; food reserve of, 34, 35, 301-302; and fruit, 301, 302, 315; origin of, 301, 303; protection of, 315, 316; size of, 36, 319
- Segregation, law of, 445, 446, 447, 449, 450, 455
- Selection, improvement through, 439, 440, 441 ff.; natural, 472
- Self-pollination, 304
- Semen, 327, 329
- Sensation, sound, 238; and stimulation, 228
- Sensitive plant, 361
- Serum, 181
- Sewage, 60; and bacteria, 397
- Sex, 296 ff., 320 ff., 331 ff. *See also* Reproduction
- Shedding of leaves, 375
- Shellac, 413
- Shelter, making of, 371
- Shelter, primitive, of man, 500
- Shoot (plant axis), 32
- Sickness, control of, 194 ff., 395, 507
- Sieve plates, 176
- Skeletons of primates, 491
- Skin, 345, 347, 351; hygiene of, 206; temperature regulation by, 155
- Skulls of primates, 292
- Skunk, 374
- Sleep, 118, 215
- Sleeping sickness, 341
- Smell, organs of, 227; sense of, in man, 502
- Smoke, and health, 162; and plants, 162; tobacco, 162
- Smoking, and school standing, 165; effects of, 163, 164 ff.
- Snoring, 151
- Sociability, in animals, 432 ff.; in man, 138, 435, 504-505
- Society, and air, 158 ff.; alcohol and, 137; and birds, 425 ff.; and evolution, 473-474; and food, 122 ff.; and the forest, 378 ff.; and health, 388 ff., 394 ff., 399 ff.; and insects,

- 399 ff., 408 ff., 417 ff.; and mosquitoes, 408 ff.; and science, 507 ff.; and the soil, 65 ff.
- Soil, 30; and bacteria, 396; biology of, 66; chemical changes in, 66; conservation of, 68, 380; erosion, 47, 380; exhaustion of, 66; and forests, 380-381; increase of, 67-68; intensive cultivation of, 67; relation to sprouting, 29; as source of organic bodies, 65
- Sound, sensation of, 238
- Spencer, Herbert, 472
- Sperm cell, 299, 327, 459
- Spermatophytes, 481
- Spermatozoa, 299, 329
- Spillman, Dr. W. J., 450
- Spineless cactus, 453
- Spiracles, 145
- Spirogyra, 76, 266; conjugation in, 296
- Sponges, 430, 431; and bacteria, 396
- Spores, 291, 293, 296, 321, 324, 331, 332; in animals, 294; of fern, 294; of moss, 293; swimming, 295
- Sporophyte, 322, 323, 325
- Sport (mutation), 460, 462, 473
- Sporulation, 326, 404
- Spraying, 423
- Sprouting of seeds, 25 ff., 29
- Stamens, 478
- Standardizing work conditions, 210
- Starch, 51; digestion of, 94, 100-101; energy in, 75; origin of, 54
- Statistics, vital, 395
- Stalolith, 241, 242
- Stem, 32, 174 ff., 269 ff., 300, 477
- Stickleback, 332
- Stigma, 301, 303, 304 ff., 311, 313
- Stimulants, 119, 131 ff., 253 ff. (*see also* Alcohol)
- Stimulation, of glands, 110, 112, 116, 217; of intestines, 119; from meat, 106; of muscles, 217; and sensation, 228
- Sting of bee, 373
- Stomach, 82, 83; glands of, 84
- Stomate, 70, 71, 88, 144, 261
- Stone Age, 500
- Struggle, competitive, 343; for existence, 474
- Suffocation, 169
- Sugar (*see* Carbohydrates)
- Sun, relation of, to life, 55, 75
- Superstition, 505
- Suprenals, 188
- Surface, of cell in relation to growth, 265; reduction of, as protection, 359
- Surinam Ameiva, 270
- Survival of the fittest, 472, 474
- Susceptibility, 198. *See also* Immunity
- Swallowing, 82, 100
- Tannin, 202, 255
- Tanning by light, 352
- Tapeworm, 342, 369, 411
- Tap-roots, 45
- Taste, organs of, 226; in selection of food, 110-111
- Tea, 74, 254
- Teeth, 81, 105, 119 ff., 502
- Temperature, and breathing, 156; and development, 286; and life, 337 (*see also* Heat); color changes related to, 353, 362; regulation of, in body, 187; relation of, to sprouting, 27
- Test, cytolsin, 197; precipitin, 197
- Texas fever, 451
- Thallophytes, 480
- Thymus, 189, 285
- Thyroid, 188, 289; influence on development, 285
- Tick, 451
- Tigerstedt on daily food requirements, 101
- Timber supply, 382, 383
- Tired feeling, 118
- Tissues, 24, 267, 276, 477
- Toads, 329; and young, 334
- Tobacco and bacteria, 347
- Tobacco industry, 74, 167
- Tobacco smoke, 162 ff.
- Tonus, 132
- Tools and weapons, 499
- Touch, organs of, 226, 228
- Tourniquet, 191
- Towels, public, 395
- Tower, Professor W. L., 462. *See also* Frontispiece
- Trachea in man, 148
- Tracheæ in insects, 145
- Transformation (metamorphosis), 280
- Transmission, of communicable diseases, 317; of modifications, 460
- Transparency, 352
- Transpiration, 71, 72, 178
- Transportation, within organism, 44, 79, 174 ff., 179 ff., 185 ff.
- Tree hoppers, 354
- Trees, products of, 377. *See also* Forest

- Trench fever, 410
 Trimorphic flowers, 305
 Trimorphic insects, 357
 Tropism, 37, 38, 230; and reflexes, 218; and senses, 224 ff.
 Tubercles, bacteria in, 67; nitrogen, 62
 Tuberculosis, 152, 386, 389, 506, 508
 Turnspit animals, 460
 Type, mixed, 440
 Typhoid fever, 391; and flies, 399; and water, 392
- Underfeeding, 288
 Underwing moth, 352
 Unit characters, law of, 448, 449, 451
 Urea, 144, 201, 204
 Urine in diagnosis, 205
- Vaccination, compulsory, 394; against typhoid fever, 197; and vaccines, 198
 Vaccines, *see* Vaccination
 Valves of heart, 186, 190
 Vanessa butterfly, 287
 Vanilla, 312
 Variation, 258, 437, 472; causes of, 438; physiological, 438, 439; in size of similar units, 436
 Vegetarianism, 105
 Veins, 185; of leaves, 34, 70, 175, 176
 Ventilation, 154 ff.; and efficiency of work, 156; and moisture, 155; of lungs, 148, 152; regulation of, 395; summary on, 173
 Ventricles, 185, 186, 187
 Vermiform appendix, 82, 468
 Vertebrata, 432
 Vertebrates, 482, 492; brains of, 497; reproduction in, 330
 Vessels, blood, 185; in plants, 44, 174, 176
 Vestigial structures, 468
 Vibrations, perception of, 238
 Villus, 86, 87
 Vinegar and bacteria, 397
 Vitamins, 108-109
 Voit, Carl, food doctrines of, 90, 93, 99
 Volume of cell in relation to growth, 265
 Voluntary muscles, 219
 Volvox, 276
 Von Baer's Law of Recapitulation, 278
 Vries, Hugo de, 440, 442, 461, 462, 473
- Walking-leaf insect, 354
 Walking-stick insect, 353
 Wallaby and young, 334
 Wallace, Alfred Russel, 472
 War, the Great, 64, 108, 130, 133, 142, 216, 243, 354, 383, 410, 514
 Warm-blooded animals, 337
 Wastes of organisms, 201 ff. *See also* Excretion
 Water, essential to gametes, 328; in food-making, 53 ff.; in growth of plant, 38; and life, 50, 52, 338; with meals, 114, 117; related to sprouting, 27
 Water power and forest, 380
 Water supply, 122, 123, 391; and forest, 378; and typhoid fever, 392
 Wax, 413
 Waxwing, cedar, 428
 Wealth, biology related to, 4. *See also* Economics
 Weapons and tools, 499
 Weevils, 416; cotton-boll, 418
 Weismann, August, 459
 Wheat, breeding of, 450; immunity to rust in, 451; rust of, 411
 Wheelworms, 482
 Whiteness of fur related to temperature, 353
 Wood, conservation of, 384; in roots, 44; in stems, 174, 175; supply of, 382, 383; uses of, 377
 Woodpecker, red-headed, 428
 Work, alcohol and, 136; hours of, 213; rate of, 211; relation of, to food requirements, 100-101; and rest, 214
 Work conditions, regulation of, 394, 395; standardizing, 216
 Wounds, treatment of, 191
- Xylem, 175, 176
- Yeast, 23, 133, 291-292
 Yellow fever, 406; reduction of, in Cuba, 409
 Yellow-bellied sapsucker, 427
 Young, protection of, 371. *See also* Development and Infancy
 Youth, 335
- Zygospore, 297
 Zygote, 296, 297, 332, 459; origin of, 457

