

5B 32 948

ELEMENTARY PRINCIPLES  
OF  
AEROPLANE DESIGN.

A. W. JUDGE.



19315

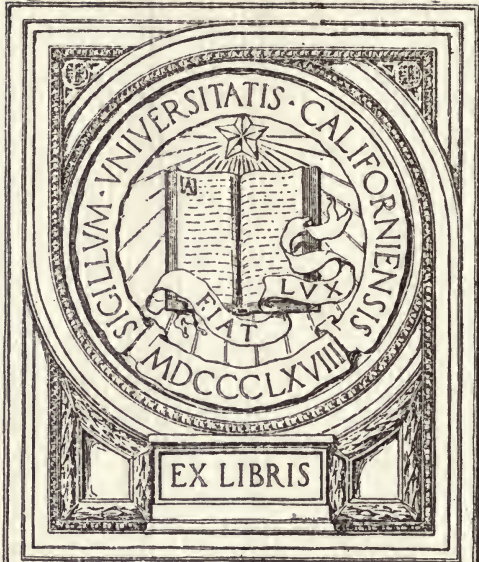

EX LIBRIS

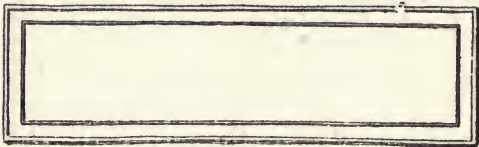





# Selwyn's Aeronautical Library

for  
Engineers, Works Managers,  
Draughtsmen, Foremen,  
Aeronautic Research Students.

---

---

## ADVANTAGES OF THE LIBRARY.

- (1) As a member of Selwyn's Aeronautical Library you can at small cost read all the published matter.
- (2) Members may send up one question on the subject matter of each book to which will be given a written reply.
- (3) Members may purchase soiled copies of books at reduced rates, the price of each book being clearly marked on the cover and fixed by Selwyn's, according to the condition. In this manner a permanent library can be got together at reasonable cost. • Under this scheme also a new book need not be purchased on speculation, but only after a preliminary examination as to the value of its contents.
- (4) Members will be supplied with a monthly list of new publications.
- (5) Members requiring a book which does not appear in the list can put in an application for it, and it will be added to the Library if it appears to Selwyn's to be a useful publication.

Full Particulars on application to—

J. SELWYN & CO., LTD.,

20, ESSEX STREET, STRAND, LONDON, W.C. 2.

# Selwyn's Engineering Science Primers

E. S. ANDREWS, B.Sc.

## **Part I. FIRST STEPS IN APPLIED MECHANICS.**

*CONTENTS.*—Forces and Other Vector Quantities; Moments and Leverage; Work, Power, and Energy; Machines and Efficiency; Mechanisms; Belt, Chain, and Toothed Gearing; Friction and Lubrication; Stress and Strain; Answers to Exercises; Index.

2s. 6d. net.

## **Part II. FIRST STEPS IN HEAT AND HEAT ENGINES.**

*CONTENTS.*—Types of Heat Engines; The Measurement of Heat Energy; Specific Heat and Latent Heat; Properties of Steam; Expansion of Gases, Liquids and Solids; Indicator Diagrams; Transmission of Heat Energy; Answers to Exercises; Index.

2s. net.

## **Parts I. and II.**

In One Volume.

3s. 9d. net.

---

# Selwyn's Tables of Safe Loads on Steel Pillars.

E. S. ANDREWS, B.Sc., and W. C. COCKING, M.C.I.

## **Vol. I. SINGLE PLATED I BEAM PILLARS.**

6s. net.

A Handbook for Engineers, Architects, Surveyors, and Builders. These tables comply with the requirements of the London County Council (General Powers) Act, 1909. Practical Notes on Design and Construction are included.

J. SELWYN & CO., LTD.,

20, ESSEX STREET, STRAND, LONDON, W.C. 2.

# From J. Selwyn & Co.'s List.

**METRIC TABLES.** 2s. 6d. net (post free).

A very handy set of reference tables for all who have to deal with the Metric system.

**MATHEMATICAL TABLES.** 3s. net (post free).

(Including Five-figure Logarithms).

**FIVE-FIGURE LOGARITHMS.** 1s. net (post free).

**MANUAL OF DIVING.** By R. H. DAVIS.

7s. 6d. net (post free).

A most useful handbook to all interested in the problems of submarine diving.

---

## TEXT-BOOKS BY EWART S. ANDREWS,

B.Sc.Eng., M.C.I.

**THEORY AND DESIGN OF STRUCTURES.**

10s. 6d. net (postage 6d.).

**FURTHER PROBLEMS IN THEORY AND  
DESIGN OF STRUCTURES.**

9s. net (postage 6d.).

**STRENGTH OF MATERIALS.**

12s. net (postage 6d.).

**ELEMENTARY STRENGTH OF MATERIALS**

6s. net (postage 6d.).

**ALIGNMENT CHARTS.**

2s. net (postage 2d.).

An interesting little book of great value to all draughtsmen and designers interested in the preparation of graphical charts.

---

*The above books may be obtained from any bookseller,  
or BY RETURN OF POST direct from—*

**JAMES SELWYN & CO., LTD.,**  
20, ESSEX STREET, STRAND, LONDON, W.C. 2.

# Some Interesting Aeronautical Books

By W. E. DOMMET, A.F.Ae.S., M.I.Mar.E., A.M.I.A.E.

## AEROPLANES AND AIRSHIPS

Paper Covers, 1s. 9d. net (post 2d.).

4th Edition. 26 Figs., 8 Plates. Cloth covers, 3s. net (post 3d.).

*6,000 copies of this popular book have already been sold.*

The subject is presented in simple language and is of interest to the general reader.

**CONTENTS**—Historical; General Principles; Descriptions of Different Types of Machines; Engines; Propellers; Steering and Manœuvring; Equilibrium and Stability; Dirigibles, Non-Rigid, Semi-Rigid and Rigid.

## A DICTIONARY OF AIRCRAFT

Paper Covers, 2s. net (post 2d.).

This useful book explains in simple language the meaning of all aeronautical terms, scientific, technical, and popular, and also symbols and abbreviations used in the Daily Papers, Aeronautical Periodicals, and Text-books. It is an invaluable reference book, and is the most complete yet published.

By J. C. HUNSAKER, D.ENG.

## AERODYNAMICAL PROPERTIES OF THE TRIPLANE AND STABLE BIPLANE

Paper covers, 3s. net (post free).

By LT.-COM. VON BUTTLAR.

## AIRSHIP ATTACKS ON ENGLAND

Paper Covers, 1s. 3d. net (post free).

A German account of Zeppelin raids written by one of the most famous German pilots, and translated by Mr. F. PAYNE, M.I.N.A., Assistant Overseer to the Admiralty.

J. SELWYN & CO., LTD.,  
Technical and Scientific Publishers and Booksellers,  
20, ESSEX STREET, STRAND, LONDON, W.C. 2.



**ELEMENTARY PRINCIPLES  
OF AEROPLANE DESIGN AND  
CONSTRUCTION**

BY THE SAME AUTHOR.

**THE DESIGN OF AEROPLANES. (2nd Edition.)**

*14s. net, post free.*

**CONTENTS.**—General Design Principles; The Estimation of Aeroplane Weights; Some Design Considerations; Characteristic Curves of Performance; Stresses in Aeroplanes; Principles of Construction of the Wing System; Principles of Undercarriage Design; Mechanical Principles involved in Aeroplane Design; Fuselage Design; Tables of Weights, Strengths, etc.

*EXTRACTS FROM PRESS OPINIONS.*

*Aeronautics.*—"This is by far the most complete treatise of its kind which has yet appeared, and the book is thoroughly to be recommended as a valuable collection of data applicable to aeroplane design and construction."

*Engineer.*—"This is certainly one of the most practical books on the design of aircraft which we have yet come across. It represents an attempt—and in our opinion a successful one—to collect together all the information, formulæ, and data required in getting out the design of a modern aeroplane."

*Flight.*—"The merit of the book lies in the fact that it contains in a brief form some of the most useful data relating to the fundamental principles of design."

*Machinery.*—"We believe that this book presents the best treatment yet available of aeroplane design, and a treatment, moreover, which gives the reader an intimate and accurate knowledge of modern practice."

**THE PROPERTIES OF AEROFOILS  
AND AERODYNAMIC BODIES. *18s. net, post free.***

**CONTENTS.**—The Flat Plane; The Cambered Plane in Theory; Properties of the Cambered Plane; Experimental Results for Aerofoils and Wing Sections; Experimental Results for Aerofoils of Different Shapes; The Resistance of Solid Bodies; The Resistance of Aerodynamical Bodies; Application of Resistance Results to Practice—Breguet, Nieuport, and Deperdussin Wing Sections; Tabulated Results of Wind-Channel Tests; of Special Wing Section Dimensions; of Propeller Series of Wing Sections.

*EXTRACTS FROM PRESS OPINIONS.*

*Times Engineering Supplement.*—"So well has the author done this book that it will become a standard work."

*The Engineering Review.*—"Provides an excellent resumé of the knowledge now available, and meets the needs of engineers in this particular branch of engineering."

**HIGH-SPEED INTERNAL  
COMBUSTION ENGINES.**

*18s. net, post free.*

**JAMES SELWYN & CO., LTD.,**

**20, ESSEX STREET, STRAND, LONDON, W.C. 2.**

ELEMENTARY PRINCIPLES  
OF  
AEROPLANE DESIGN  
AND CONSTRUCTION

A TEXTBOOK FOR  
STUDENTS, DRAUGHTSMEN, AND  
ENGINEERS

BY

ARTHUR W. JUDGE

WHITWORTH SCHOLAR; ASSOCIATE OF THE ROYAL COLLEGE OF SCIENCE; DIPLOMATE OF  
THE IMPERIAL COLLEGE OF SCIENCE AND TECHNOLOGY; ASSOCIATE MEMBER OF THE  
INSTITUTION OF AUTOMOBILE ENGINEERS; ASSOCIATE FELLOW OF THE  
AERONAUTICAL SOCIETY, ETC.

AUTHOR OF "THE DESIGN OF AEROPLANES," "THE PROPERTIES OF AEROFOILS AND  
AERODYNAMIC BODIES," "HIGH-SPEED INTERNAL COMBUSTION ENGINES," ETC., ETC.

WITH 13 TABLES, 56 ILLUSTRATIONS, NUMEROUS  
EXERCISES AND ANSWERS



JAMES SELWYN AND CO., LTD.  
20, ESSEX STREET, STRAND, LONDON, W.C. 2  
AND 64, FIFTH AVENUE, NEW YORK

1919

[All rights reserved]

TL67/

12

J82

10/6/20

NO 111  
1111111111111111

## PREFACE

THE object of the present volume is to endeavour to fulfil the needs of students, draughtsmen, and others, for an inexpensive book of an elementary nature, dealing with the fundamental principles underlying the design and, to a certain extent, the construction of aeroplanes.

The subject of aeroplane design is essentially one involving a thorough knowledge of mathematics and mechanics, combined with a practical knowledge of the existing conditions to be fulfilled, and a firm acquaintance with the results of aerodynamical research.

To the student approaching the subject for the first time much difficulty is presented, owing to the widely scattered sources of information, and to the specialized and often difficult nature of the information when obtained. It is therefore hoped that the present book will prove helpful in placing before the reader, in a more or less intelligible form, the general principles underlying aeroplane design, and in serving as a "breach" or introduction to more advanced treatises.

The general scheme of the book, which is based upon the author's larger revised volume "Design of Aeroplanes," is to deal with the aerodynamical and stability principles first, and to follow on with the general application of these and of the mechanical principles to design work. The treatment has been intentionally confined to principles rather than to particular cases, tabulated data, etc., for it is the common experience that, given the necessary preliminary training in mathematics, graphics, mechanics, and other ground subjects, a thorough knowledge of principles is of greater importance in design and constructional work than the absorption of a mass of disconnected facts and figures. The latter information is, however, essential when it becomes necessary to apply the principles

to practical design and constructional work in the more advanced stages of the subject.

In conclusion, the writer would be grateful if his attention were drawn to any printer's errors, slips, etc., which may have inadvertently been overlooked, in spite of repeated revisions of the proofs, and would welcome practical suggestions for increasing the utility of the book within the scope of its title.

A. W. J.

LONDON, 1919.

# CONTENTS

CHAPTER

PAGES

## I. GENERAL PRINCIPLES :

Introduction—Mechanical Considerations—Prediction of Aircraft Performances—Aerodynamical Principles—Properties of Bodies in Air Currents—Streamlined Forms—Flat Planes—Inclined Planes—Centre of Pressure—Lift and Drift—Cambered Aerofoils—Resistances of Different Bodies—Principles of Aeroplane Stability—Static Balance—Forces upon an Aeroplane—Estimation of C.G. Position—Dynamic Stability—Aeroplane Nomenclature—Longitudinal Stability—Lateral Stability—Directional Stability—Aeroplane Controls—Design Procedure—Skin Friction . . . . . 1-29

## II. GENERAL DESIGN CONSIDERATIONS AND DATA :

General Characteristics Required—Special Types of Machine—Scouting, Reconnaissance, Bombing, and Commercial Types—Seaplanes and Flying Boats—Weights, Sizes, and Performances—Wing Loading—Metric Units—Table of Lift Coefficients—Application of Model Tests to Full-Sized Machines—Wing Loading and H.P. Loading—Monoplanes and Biplanes—Bird Flight Data—Distribution of Wing Loading—Pressure Distribution over Aerofoils—Choice of Flying Angles—Aspect Ratio Corrections—Biplane and Triplane Spacing—Effect of Staggering—Effect of Dihedral Angle . . . . . 30-51

## III. THE CHARACTERISTIC CURVES OF AEROPLANE PERFORMANCES :

General Considerations—Wing Resistance Curves—Monoplane and Biplane Performances—Effect of Other Factors—Horse-Power Curves—Climbing Rates and Speeds—Gliding Angles—Effect of Altitude upon Performance 52-61

## IV. PRINCIPLES OF CONSTRUCTION OF THE WING SYSTEM :

Systems of Biplane Bracing—Wing Forms—Wing Spar Sections—Metal Spars—Wing Construction—Flexible Wings—Steel Constructions . . . . . 62-73

CHAPTER	PAGES
V. PRINCIPLES OF UNDERCARRIAGE DESIGN :	
Mechanical Principles Involved—Landing Shocks—Springing Forces—Types of Undercarriage—General Requirements for Undercarriages—Light and Heavy Types—Streamlining of the Undercarriage—Tubular Types—Castoring Type—Springing and Suspension—Rubber Shock Absorbers—Aeroplane Wheels . . . . .	74-8
VI. FUSELAGE DESIGN :	
General Considerations—Types of Aeroplane Body—The Wire-Braced Type—Rigid Girder Types—Metal Girder Types—Fuselage Sections—Circular Sections—Methods of Fairing or Streamlining Fuselages—The Monocoque or Single Shell Type—Combination Types—Design Methods—Stresses in the Tail Portion—Stresses in the Main Body—Factors of Safety . . . . .	90-107
QUESTIONS AND EXAMPLES . . . . .	108-110
ANSWERS TO EXAMPLES . . . . .	111-112
INDEX . . . . .	113-11



# ELEMENTARY PRINCIPLES OF AEROPLANE DESIGN AND CONSTRUCTION

## CHAPTER I

### GENERAL PRINCIPLES

#### INTRODUCTION.

The subjects of aeroplane construction and design are very closely interconnected, and a knowledge of the one necessitates an understanding of the principles of the other.

*Aeroplane design* is the process of determining the proportions of aircraft and their components, in order to fulfil specified requirements of stability (including control), performance, and strength conditions.

Before an aeroplane can be constructed,\* it must now be properly designed so as to fulfil each of the specified requirements; a knowledge of the lightest and most reliable methods of aircraft construction, and of the properties and processes of the materials employed, is necessary for design purposes.

*Aeroplane construction*, whilst being based mainly upon the results of design methods, also requires a thorough knowledge of the methods of utilizing to the full advantage the most suitable materials. Present-day constructional work utilizes materials having the greatest strength to weight ratios (see p. 2), whilst possessing reliability and resistance to shock and fatigue: for this reason it is usual to employ such materials as spruce and ash for stress-bearing parts, similar to the wing-spars, interplane, and interspar struts, longerons and other members; high tensile steel (such as nickel, nickel-chrome or chrome-vanadium) for wire-attachment clips, brackets, and similar parts under repeated stress action; aluminium alloys for complicated shapes, requiring castings, or

\* The early "trial and error" methods, involving many accidents, have now been replaced by the more scientific methods of careful design, based upon the results of aerodynamical research, and experience derived from testing actual machines.

for lightly stressed clips and fittings; high tensile cable, rafwire\* or piano wire (up to about 120 tons per square inch tensile strength) for bracing stays and ties; and fabric coverings for parts under air pressure or suction, such as the wing coverings, fuselage and control planes. Constructional methods, whilst employing the best materials, also take advantage of the economical mechanical strength principles. A much employed weight-saving system is that used for the wing bracing, fuselage and control frames—namely, the wire braced deep girder (Fig. 1), in which the upper and lower flanges, which resist bending, are usually of wood, or high tensile metal, and the interflange struts also of wood channel, box or hollow metal tubing; whilst the bracing wires, which take the shearing forces, are usually extremely small in diameter, and therefore light.

TABLE I.—TABLE OF RELATIVE STRENGTHS FOR WEIGHT.

Material.	Strength for Weight Number.	
	Tensile str. in lbs. per sq. in.	Weight per cu. ft. in lbs.
Mild steel .. .. .	115	
Cast steel (unhardened) .. .. .	140	
5 per cent. nickel steel (unhardened), 40 tons ..	183	
(oil-hardened), 80 tons ..	366	
Nickel Chrome (oil-hardened), 100 tons ..	457	
Chrome vanadium (oil-hardened), 115 tons ..	525	
Duralumin (rolled bar), 25 tons .. .. .	320	
(rivet bar), 16 tons .. .. .	204	
Aluminium (sheet), 12 tons .. .. .	162	
Copper (sheet), 13 tons .. .. .	53·4	
(wire), 26 tons .. .. .	106·8	
Ash .. .. .	322	200†
Birch .. .. .	320	100†
Silver spruce .. .. .	330	200†
Cedar (American) .. .. .	308	170†
Mahogany (Honduras) .. .. .	600	228†
Pine: white .. .. .	322	148†
"  yellow .. .. .	406	166†
"  pitch .. .. .	332	210†
Poplar .. .. .	260	160†
Lancewood .. .. .	350	—
Hickory .. .. .	330	220†
Walnut .. .. .	170	120†

In such a girder as that shown in Fig. 1, *A*, the upper flange is in compression (the value of the force progressively increasing from panel to panel towards the support), whilst the lower flange is in tension. All of the vertical bars act as struts no matter

\* Rafwire is flattened wire of "streamline" section (see p. 14), designed originally at the Royal Aircraft Factory.

† Compression strengths.

in which direction the load  $W$  acts; and the full inclined lines represent wires in tension. If, however, as in the case of aeroplane wings, or fuselage frameworks, the load  $W$  may act in either direction, then it is necessary to provide either another set of stay-wires (shown dotted) or to replace the existing ones by struts so fixed at their ends as to take tension also; the flanges

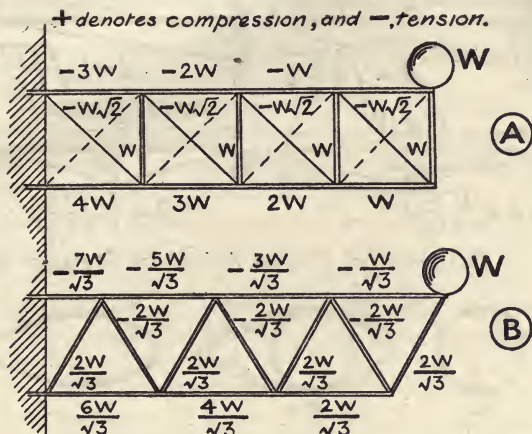

FIG. 1.—ILLUSTRATING GIRDER PRINCIPLES EMPLOYED IN AEROPLANE WORK.

must then be equally strong in tension or compression. Advantage is also taken of the most economical shapes of sections, of members acting either as beams or struts. Fig. 2 represents a few typical cases of light beams and strut sections employed in aeronautical construction.

### PREDICTION OF AIRCRAFT PERFORMANCES.

Returning once more to the subject of aeroplane design, it may be stated that it is now possible to make the full working drawings of a new machine, and to be able to predict very closely, before the machine is made, what will be its speeds (both maximum and minimum horizontal values), its angle, rate and speed of best climbing, and its angles of glide, with the engine switched off, at different air speeds. If the performance or power curves of the engine are provided, then the values of the maximum horizontal air speed and the climbing rate at different altitudes can be computed, for it is well known that both of these factors progressively fall off the higher the machine flies, chiefly on account of the diminishing air density. It is also possible to

predict beforehand what will be the greatest height, or "ceiling,"\* to which the machine can climb.

The degree of controllability and the behaviour of the machine

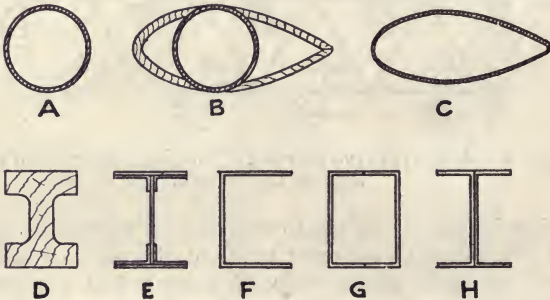
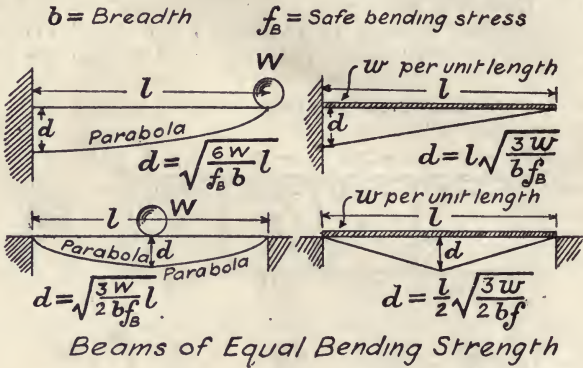

- B - Circular tubing, faired with spruce, for streamline strut purposes.
- C - Hollow metal streamline strut.
- D - Wing spar section.
- A, E, F, G, H - Metal beam and strut sections for Maximum  $\frac{\text{Strength}}{\text{Weight}}$ .

FIG. 2.

under different conditions of flying, such as stalling, banking, looping, or flying in gusty weather, can also be approximately predicted beforehand from stability considerations.

\* The "absolute ceiling" of a machine is the altitude, expressed in feet, at which the rate of climb is zero. The "military" or "practical" ceiling is that at which the rate of climb is 100 feet per min. A modern two-seater machine has a practical ceiling of from 15,000 to 20,000 feet, and takes about an hour to arrive there. Its speed at the ceiling is about two-thirds of its horizontal ground maximum speed.

The estimation of the proportions of aeroplane parts which have to bear loads, when in flight, or on the ground, involves a knowledge of the principles of mechanics, and every designer must be fully conversant with the methods of calculating the stresses in structures, and the strength of materials; knowing the methods of computing the stresses, or loads (which are the same as those used in bridge-work, for machines, or engineering structures), it is then possible, with the aid of data derived from the results of experience and experiment, to determine the proportions of the parts.

From the results of computations and of machine tests in the air, the nature of the loads coming upon the wings and control planes are known, and appropriate factors of safety may be given for fixing the dimensions of these parts. In the present volume the more important methods of computing the stresses of aeroplane parts are dealt with briefly from an elementary point of view. For a fuller treatment the reader is referred to the author's larger book on "Design of Aeroplanes" (James Selwyn and Co., Ltd.). The importance, in design work, of a knowledge of the stability, performance, and of the methods of stress-estimation, has already been emphasized; the elementary principles involved in the latter and in a part of the second of these subjects are dealt with in the following chapters. The present chapter will be devoted to a brief and elementary consideration of the subjects of aeroplane stability and control, and to aerodynamics;\* the latter subject will be treated first, since it has an important bearing upon the other subject.

### AERODYNAMICAL PRINCIPLES.

A body, of any shape, when held in a current of air experiences a force, due to the action of the air, which tends to carry it along in the current. The value of this force is termed the **Resistance** of the body.

Resistance is caused by the direct positive pressure effect of the air upon the front side, by the negative or suctional effect of the air behind (due to the formation of eddies or regions of turbulence behind), and to the surface drag, or **Skin Friction**, of the air flowing past the surface of the body.

These two types of resistance—namely, the normal air pressure and the skin-friction effects—are related to one another in their causes, although their effects may be studied separately.

\* Aerodynamics is the subject which deals with the properties of the airflow around bodies of various shapes, from both the purely theoretical and the experimental standpoints.

In the case of a thin flat plate (Fig. 3, *A*) placed normal to an air stream, the air resistance is practically all of the normal type, and is relatively very high in value, whilst in the case of the fish-like shape (known as a **Streamline Form**) shown in Fig. 3, *C*, the air flows over the surface with little or no turbulence, and the small amount of resistance experienced is almost entirely due to surface friction. The shape of a streamline body is such

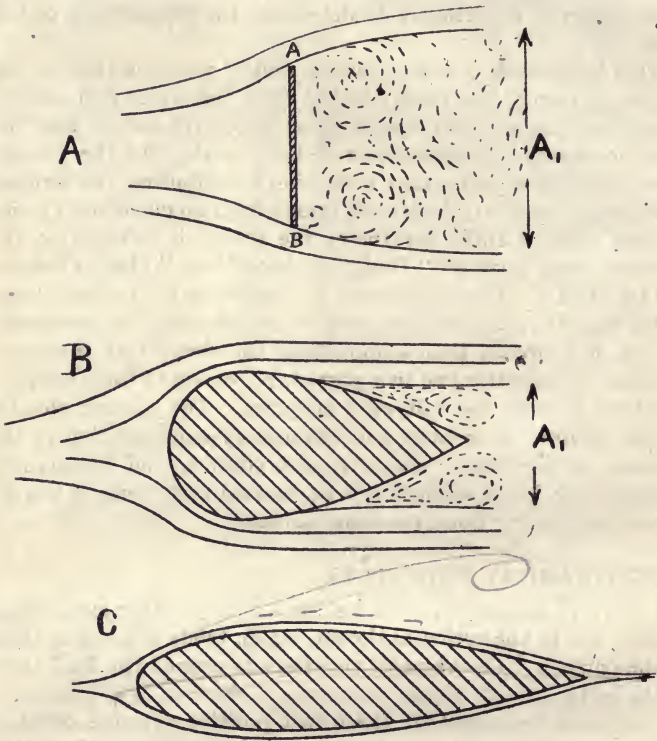

FIG. 3.—TYPES OF FLOW AROUND BODIES.

that the directions of the lines of airflow are changed as little and as smoothly as possible. Fig. 3, *B*, illustrates a typical shape midway in properties between *A* and *C*.

The relative resistances of the three shapes *A*, *B* and *C* (Fig. 3) would be represented by the numbers 8,  $\bar{4}$ , and 1 respectively for the same width perpendicular to the air stream, whilst that of a circular rod or sphere would be represented by about 5.

## LAW OF RESISTANCE.

It has been found that the air resistance of all bodies varies, within certain limits of speed,\* as the square of the velocity, and as the projected area of the body upon a plane normal to the air current, according to the relation

$$R = k \cdot A \cdot V^2,$$

where  $R$  represents the resistance,  $A$  the projected area, and  $V$  the air speed. The value of the constant  $k$  will depend upon the shape of the body (being a minimum for streamline shapes and a maximum for those resembling normal planes, or producing much turbulence behind) and inversely upon the air density.

For very low speeds the resistance is chiefly due to surface friction, and varies as the velocity, and for streamline or thin edged planes along the air stream as the (velocity)<sup>1.85</sup>.

For a flat plane, approximately square, of area  $A$  square feet, held normal to the air stream, the resistance  $R$ , in pounds, for a velocity of  $V$  (in M.P.H.) is given by—

$$R = k \cdot A \cdot V^2 \text{ lbs.}$$

where the value of  $k$  varies from 0.0027 for small planes of 4 square inches area, up to 0.0032 for planes of 25 square feet or over. If  $V$  is in feet per sec., the values of  $k$  are 0.52 and 0.62 respectively. †

*Aspect Ratio.*—The aspect ratio of a plane or wing is the ratio of the span, or length perpendicular to the air stream, to the chord, or length along the air-stream direction.

It has been found, by test, that as the aspect ratio or length-to-breadth increases from the square shape (aspect ratio = 1), so does the resistance of, or pressure upon, normal planes of the same area also increase; the same effect is found in the case of the pressure in a direction at right angles to the surface of flat planes or wing sections at a small inclination to the air streams.

For normal planes of aspect ratios 1, 3, 6, 10, 20, and 50, the relative values of the normal pressures are 1.00, 1.07, 1.10, 1.145, 1.34, and 1.47 respectively, so that a long thin plane of aspect ratio 50 experiences 47 per cent. more pressure than that on a square plane of the same area.

\* These limits, in aeroplane work, may be taken as being 15 and 120 M.P.H. respectively.

† In metric units  $R$  is in kilogrammes if  $A$  is in square metres, and  $V$  in metres per second, the corresponding values of  $k$  being 0.066 for small, and 0.078 for large planes.

## INCLINED PLANES AND SECTIONS.

The term *Aerofoil* is given to a body of rectangular or other shape in plan, having either a rectangular or cambered section,\* placed at a small inclination to the air stream.

The notation employed for aerofoils is indicated in Figs. 4 and 5. As a rectangular flat plane is progressively inclined from the

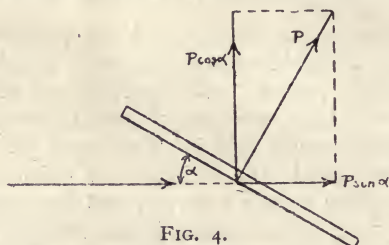

FIG. 4.

edge-on position to the air streams, it experiences an increasing normal pressure to its plane. If the inclination† to the air-stream direction be denoted by  $\alpha$ , then the value of the normal pressure for a square plane is given by—

Pressure at inclination  $\alpha$ ;  $P_{\alpha} = P_{90} \cdot \frac{\alpha^{\circ}}{25}$  for angles up to  $35^{\circ}$ ,

where  $P_{90}$  = the pressure at  $90^{\circ}$ , or the normal plane pressure. It will be seen that the pressure  $P_{\alpha}$  increases from nothing at  $0^{\circ}$  up

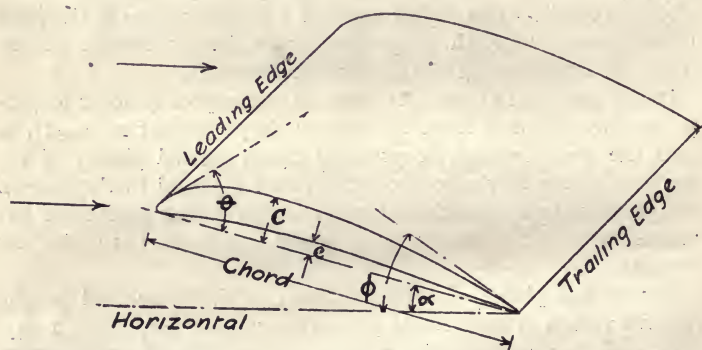

FIG. 5.—AEROFOIL NOMENCLATURE.

Top camber =  $\frac{\text{Chord}}{C}$ ; bottom camber =  $\frac{\text{Chord}}{c}$ ;

angle of entry =  $\theta$ ; angle of trail =  $\phi$ ; deflection angle =  $\theta + \phi$ .

to a maximum value at  $35^{\circ}$ , which is about 40 per cent. greater than that at  $90^{\circ}$ .

\* An aeroplane wing is a typical example of a cambered aerofoil.

† This angle is termed the *Angle of Incidence* of the aerofoil.



The effect of increased aspect ratio is to give higher values for  $P_a$ , for small inclinations (up to about  $12^\circ$ ); but the maximum values for  $P_a$  are less than for the square plane, and occur at smaller angles than the  $35^\circ$  mentioned above. If the aspect ratio be denoted by  $n$ , then the following formula represents the experimental results of M. G. Eiffel's work:

$$P_a = P_{90} \cdot a^\circ (0.032 + 0.005n).$$

This formula only holds for inclinations up to about  $12^\circ$ .

### CENTRE OF PRESSURE.

The point at which the resultant pressure, equal to the total pressure, upon an aerofoil acts is termed its *Centre of Pressure*, or C.P.

For a flat plane the C.P. at  $0^\circ$  incidence is indefinite, but at the small inclination of  $1^\circ$  or  $2^\circ$  it is usually situated at from 0.15 to 0.30 of the width, or chord length from the leading edge. As the inclination increases up to  $90^\circ$ , so the C.P. recedes towards the geometric centre—that is, at 0.5 of the chord from the leading edge.

In the case of a cambered aerofoil, the C.P. at small positive inclinations of  $1^\circ$  or  $2^\circ$  lies farthest back, usually at from 0.5 to 0.6 of the chord from the leading edge, and as the inclination

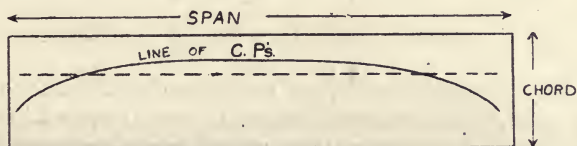

FIG. 6.—CENTRES OF PRESSURE FOR A RECTANGULAR AEROFOIL

increases the C.P. first approaches the leading edge until, at an angle usually varying from  $10^\circ$  to  $20^\circ$ , it reaches its nearest position (from 0.3 to 0.4), and then for higher inclinations again recedes, until at  $90^\circ$  it coincides with the geometric centre.

If the aerofoil were a glider, or aeroplane alone, and the C.G. of its weight coincided with its C.P. at a small angle, say of  $5^\circ$ , then if the plane were of a thin rectangular section the glider would glide stably to earth, without tending to upset, for any tendency for the plane to tilt about its  $5^\circ$  position to its path of flight would bring into play a couple of moment equal to the product of the weight and the amount of movement of the C.P. from its  $5^\circ$  position, which would tend to right the aerofoil again.

A little consideration of the behaviour of the C.P. for different angles in the case of a cambered plane will show that a cambered aerofoil is unstable under such conditions, and that an upsetting couple always occurs when the C.P. moves. This is why it is necessary, in cambered gliders and flying machines, to employ a smaller tail plane fixed at a relative negative angle of a few degrees, to correct the unstable tendency.\* In Table II. values of the C.P. position will be found for different incidences, for both flat and cambered planes of aspect ratio 6.

### LIFT AND DRIFT.

The resultant force normal to an inclined aerofoil situated in a horizontal air stream, as in Fig. 4, can be split up into a vertical component  $P_a \cos \alpha$  known as the *Lift* force, and a horizontal component  $P_a \sin \alpha$  known as the *Resistance, Drift or Drag* force. In the case of an aeroplane or glider, it is the lift force which has to counteract the weight of the machine, whilst the propeller thrust must overcome the drift at any speed, in order that the machine may fly at that speed. The English method of expressing the lift and drift forces, for an aerofoil of given area  $A$  (=span  $\times$  chord) moving through the air with a velocity  $V$ , is as follows:

$$\text{Lift force } L = \left[ C_L \cdot \frac{\rho}{g} \right] A \cdot V^2,$$

$$\text{Drift force } D = \left[ C_D \cdot \frac{\rho}{g} \right] A \cdot V^2,$$

where  $\rho$  = the air density, † and  $g$  = the acceleration due to gravity. ‡  $C_L$  and  $C_D$  are coefficients, known as the *Absolute Lift and Drift Coefficients* respectively, their values depending upon the shape of the aerofoil section along the chord, and upon the inclination  $\alpha$  to the air stream; their values are practically independent of the sizes of the aerofoils, or of the air speeds, but are dependent upon the aspect ratios of the aerofoils.

For the same inclinations, areas and speeds, the lift coefficient is greater for a cambered than for a flat aerofoil, whilst, except for small inclinations, the drift coefficient is invariably less. Table II. (see p. 11) gives the values of the lift and drift coefficients for a flat and a cambered aerofoil of equal aspect ratio, for different inclinations; the superiority of the cambered aerofoil will be at once apparent from these figures.

\* See p. 23.

†  $\rho = 0.0807$  lbs. per cubic foot at normal pressure and temperature.

‡  $g = 32.12$  feet per sec. per sec.

TABLE II.—PROPERTIES OF INCLINED FLAT AND CAMBERED RECTANGULAR AEROFOILS.

[Aspect Ratio = 6.]

Angle of Incidence.	Lift Coefficient, $C_L$ .		Drift Coefficient, $C_D$ .		Lift/Drift Ratio, $\frac{L}{D}$ .		Distance of C.P. from the Leading Edge in Terms of the Chord.	
	Flat.	Cambered.	Flat.	Cambered.	Flat.	Cambered.	Flat.	Cambered.
-4°	-.145	-.078	.0250	.0297	—	—	—	—
-2°	-.071	.033	.0150	.0177	—	1.72	—	—
0°	0	.141	.0070	.0128	—	11.0	—	0.550
2°	.071	.224	.0150	.0135	4.7	16.6	.250	.415
4°	.145	.296	.0250	.0168	5.8	17.5	.269	.340
6°	.214	.368	.0344	.0227	6.2	16.2	.274	.316
8°	.276	.437	.0510	.0306	5.4	14.3	.307	.303
10°	.338	.505	.0672	.0403	5.0	12.6	.340	.290
12°	.364	.570	.0830	.0508	4.4	11.2	.349	.283
14°	.390	.621	.0990	.0595	3.9	10.4	.359	.274
16°	.402	.621	.1140	.0726	3.5	8.5	.368	.276
18°	.395	.602	.1302	.108	3.0	5.6	.378	.310
20°	.390	.565	.1460	.167	2.7	3.4	.387	.360

Note.—The cambered aerofoil section is U.S.A. 1, illustrated in Fig. 8.

The ratio of the lift to the drift forces, or coefficients, is known as the lift/drift ratio, or  $\frac{L}{D}$ , and the results of aerofoil tests in the wind-channel are now usually given in terms of  $C_L$  and  $\frac{L}{D}$ . The values of  $C_D$  are deducible from these results. The manner in which these two factors vary, at different inclinations for a typical efficient aeroplane wing section,\* is shown in Fig. 7. Fig. 8 shows graphically the manner in which the C.P. moves for different incidences. The  $\frac{L}{D}$  ratio is a measure of the efficiency of the aerofoil, and for aeroplanes it is desirable to obtain as high a value as possible.

For a good cambered aerofoil, the  $\frac{L}{D}$  is a maximum at from 15 to 20 for an incidence of from 4° to 6°,† and progressively falls down to about 8 or 10 at the angle of greatest lift ( $C_L$ )—that is, at from 12° to 16°.

\* The U.S.A. No. 1 wing section (Fig. 8).

† This is the usual flying angle, or incidence of aeroplane wings.

The value of  $C_L$  is zero at a small negative angle of a few degrees, from  $0.05$  to  $0.10$  at  $0^\circ$  incidence, and increases almost proportionately to the incidence up to a maximum value of from

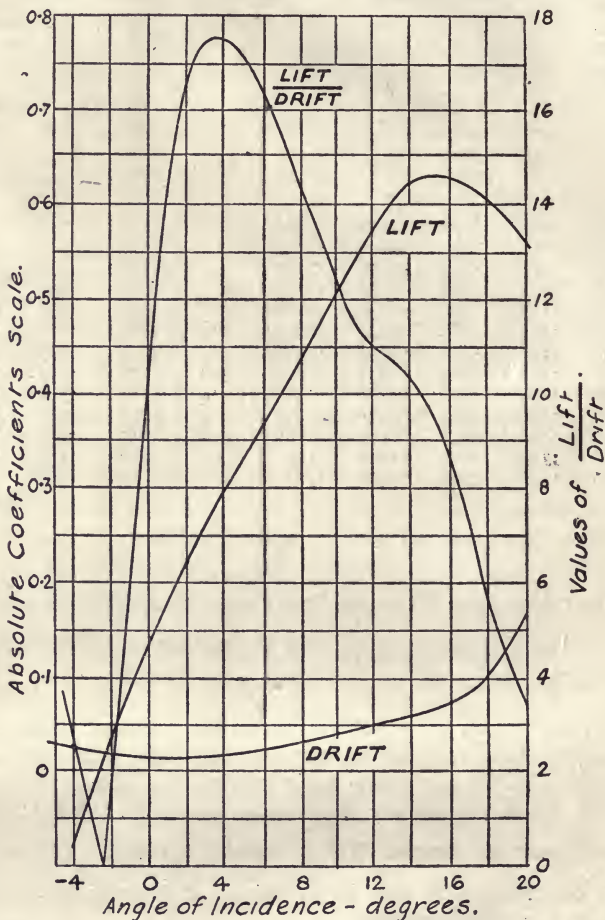

FIG. 7.

$0.50$  to  $0.70$ , for normal aerofoils, at from  $12^\circ$  to  $16^\circ$ ,\* beyond which it decreases.

It may be here mentioned that the higher the maximum value of  $C_L$  is, the lower will be the value of the minimum horizontal flying, stalling or getting-off-the-ground speed, and that the

\* This angle is known as the *critical angle*, or *stalling angle*.

lower the minimum value of  $C_D$  at the normal flying angle of incidence, the higher will be the maximum speed of the machine.

It has been found that, up to a certain limit, the lift of an

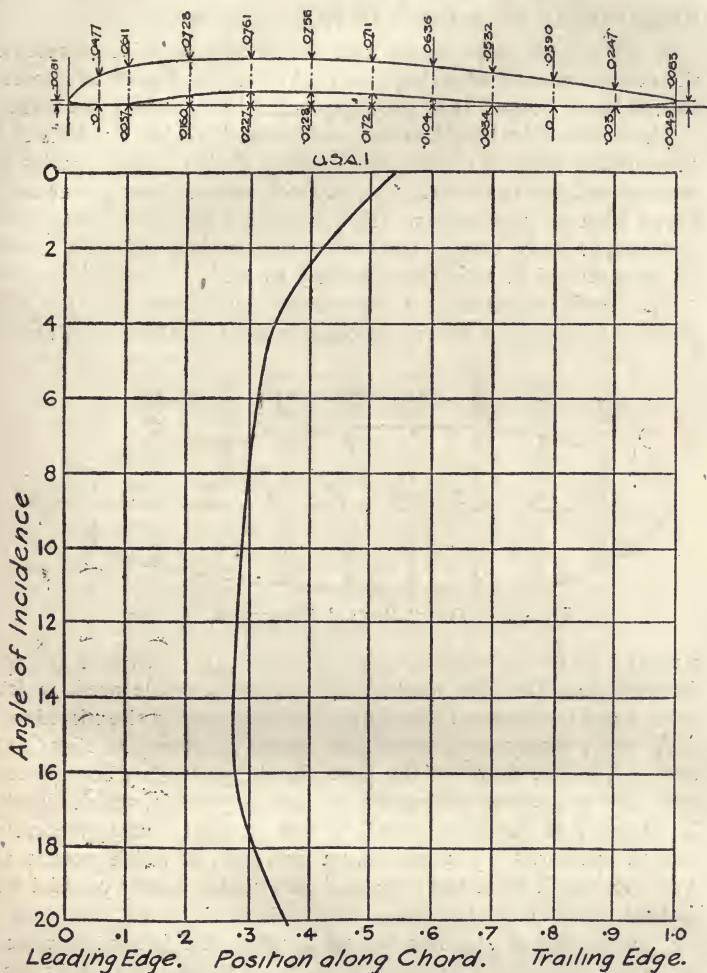

FIG. 8.

aerofoil of given dimensions, and at a given speed, increases as the amount of top camber, and as the amount of lower camber.

The top camber of normal aeroplane wing sections varies from about 12 to 14, and the point of maximum camber is about  $\frac{1}{3}$  of

the chord from the leading edge. The amount of lower camber varies from zero to about 40 or 20 and the maximum point usually lies at about 0.4 to 0.6 of the chord back.

### RESISTANCES OF BODIES IN AIR.

It has already been shown that the streamline form represents the minimum resistance shape, so that all exposed parts of aircraft should be so shaped that they approximate to streamline forms.

The ratio of the length in the air-stream direction to width of a streamlined body is termed its *Fineness Ratio*; fineness ratios of streamlined struts or bodies should not be less than 3, but may be as high as convenient. The fineness ratio of an aeroplane fuselage, or body, usually lies between the values of 6 and 9, and for streamlined or rafwires of from 5 to 10.

The best finenesses for aeroplane struts—namely, for the greatest strength as struts (in compression) combined with least

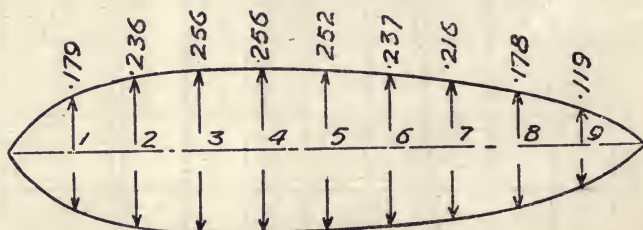

FIG. 8A.—THE "BETA" DIRIGIBLE SECTION.

weight and head resistance—are from 3 to 4. Struts of greater fineness than this are weaker, and give much side area, which often has a detrimental effect upon the stability of the machine.

A well-proportioned streamline shape is shown in Figs. 8A\* and 3, C. The shape of the nose should preferably be between that of a point and a semicircle; the tail portion, which should be about  $\frac{2}{3}$  of the total length, is not straight, but appreciably bulged outwards. The maximum ordinate, or width, occurs at  $\frac{1}{3}$  of the length from the nose, and this part is nearly parallel for a short distance to the axis.

The resistances of a few typical aeronautical forms, expressed in terms of that of a normal flat plane of the same area as that of the maximum cross section, taken normal to the wind direction, are given in the following table:

\* The ordinates of the contour are expressed in terms of the length of the streamline axis. It will be seen that the fineness ratio is  $\frac{1.00}{0.256} = 3.91$  approximately.

TABLE III.—RESISTANCES OF TYPICAL AERONAUTICAL BODIES.

Name of Part.	Resistance in lbs. at 60 M.P.H.	Ratio of Resistance to that of Flat Plane of Same Maximum Cross Section.
Large thin square flat plane normal to wind of area 1 square foot ..	11.52	1.000
Large thin square flat plane edge-on to wind of area 2 square feet (both sides included) [surface friction]	0.0684	—
Aeroplane wing of area 100 square feet with typical R.A.F. wing section No. 6 at 4° incidence ..	36	0.43
Short cylinder with base to wind of circular area 1 square foot ..	11.52	1.000
Long cylinder, rod or wire with base parallel to wind, of area (diam. × length) 1 square foot .. ..	9.79	0.85
Aeroplane fuselage (B.E. type) of length 23 feet × 2 feet wide × 3 feet 8 inches deep. Mean fineness=8.		
Sphere of cross-sectional area 1 square foot .. ..	5.40	0.63
Aeroplane wheel, shielded, 26 inches diameter × 2½ inches .. ..	1.75	0.33
Seaplane float, 12½ feet long × 2½ feet wide × 1½ feet deep .. ..	13.5	0.39
Streamline strut, of fineness 3½, 1 inch wide × 10 feet long .. ..	1.5	0.15
Dirigible (Zeppelin) 490 feet long × 46 feet diameter conoidal shaped ends. Surface of envelope, 80,000 square feet; volume of envelope, 70,600 cubic feet .. ..	2,200	0.12
Tail plane of aeroplane. Fineness=20 Per 25 square feet .. ..	3.25	0.22

For a full analysis of the aerodynamic properties of various forms of wings, airships, etc., the reader is referred to the author's book on "Properties of Aerofoils and Aerodynamic Bodies," published by Messrs. James Selwyn and Co., Ltd.

## PRINCIPLES OF AEROPLANE STABILITY.

An aeroplane which in flight always returns to, or preserves its normal flying position and speed relatively to the air, is said to be *stable*; and if a stable aeroplane is disturbed in any way—as, for example, by a sudden air-gust, it will recover its normal attitude, in a series of diminishing oscillations about its normal position under the influence of a righting couple, with its controls left quite neutral. The case of a stable aeroplane recovering its

correct position after a disturbance is very similar to that of a damped pendulum which is given a small oscillation.

An aeroplane may be made stable in all directions by suitably apportioning the parts, and by providing stabilizing surfaces; when stability is obtained by such means it is termed *inherent stability*—that is to say, stability which is inherent in the design of the machine—and independent of the controls. An *automatically stable* machine is one in which any tendency to upset or disturb the machine affects a device or devices which actuate the controls in such a manner as to counteract the disturbing effect.

There are two types of stability with which the designer is concerned—namely, the *Static* and the *Dynamic Stabilities*. When an aeroplane is in steady flight in calm weather, it is essential that all of the forces acting upon the machine are balanced, or are in static equilibrium; on the other hand, if a disturbance occurs, the machine, if dynamically stable, will right itself in virtue of righting moments brought into action as a result of the air or dynamic pressure of the air upon the stabilizing surfaces provided.

### STATIC BALANCE.

One of the essential parts of any aeroplane design is that of balancing the steady or permanent forces upon the machine under all conditions of its usage—namely, (a) When at rest upon the ground (it shall not tend to topple over with the engine running or stopped), (b) when taxi-ing and taking off, (c) when actually flying or gliding (with engine on or off), and (d) when landing (with engine throttled down, or off).

Conditions (a), (b) and (d) are dependent mainly upon the position of the C.G. relatively to the undercarriage, and for most machines the C.G. when the fuselage is held horizontal should lie from 1 foot to 1 foot 6 inches behind the vertical through the point of contact of the wheels and ground. If the C.G. is too far behind this line, the machine will be difficult to get off the ground, and will land heavily owing to the greater proportion of weight carried by the tail portion.

Condition (c) is only approximated to in most aeroplanes of the present day, for various constructional reasons. There are four forces which may be conveniently supposed to act upon a machine in steady flight—namely, (1) *the Weight of the Machine*, (2) *the Lift of the Wings*,\* (3) *the Head Resistance of the Whole*

\* Sometimes the tail plane is purposely made to lift by giving it a lifting section or incidence; this effect is here supposed to be included with that of the wings.



*Machine*, and (4) *the Propeller Thrust*. The points or lines of action of these forces are known as the C.G., the C.L., the C.R. and C.T. respectively.

The weight of the machine is usually estimated from the component weights and weight data\* after a rough layout of the machine has been made.

The lift and head resistances are usually obtained from the results of wind-channel tests upon models of the wings and component parts.

The propeller thrust is obtained from a knowledge of the engine power output, the air speed of the machine and the efficiency of the propeller. If  $V$  is the air speed in feet per second,  $H$  the brake horse-power of the engine when running at revolutions corresponding to this speed,  $T$  the corresponding propeller thrust in pounds and  $E$  the propeller efficiency,

$$\left( = \frac{\text{b.h.p.} - \text{h.p. lost at propeller}}{\text{b.h.p.}} \right)$$

then 
$$T = \frac{E \cdot H \cdot 550}{V} \text{ lbs.}$$

**Case I.**—In order that the aeroplane may be in equilibrium, these four forces must balance each other.

The ideal conditions of equilibrium are—

$$W = L \text{ and } T = R,$$

and that all four forces act through the same point, as shown in Fig. 9. In this case, if the engine ceases to work,  $T = 0$ ; then for equilibrium to occur the machine will glide downwards at its "natural gliding angle," as shown in Fig. 10, in which the gliding angle is denoted by  $\theta$ .

The forces required to balance the lift force ( $L$ ) and head resistance ( $R$ ) being obtained at the expense of the components of the weight, then—

$$L = W \cos \theta, \text{ and } R = W \sin \theta.$$

The gliding angle  $\theta = \tan^{-1} \frac{R}{L}$ .

Incidentally, this result suggests a method, made use of in practice, for obtaining from the gliding angle of a machine (or glider) the lift to drift ratio.

**Case II. Acentric Types. Line of Propeller Thrust above Centre of Resistance (Fig. 11).**—For equilibrium in this case, the weight-lift couple must balance the thrust-resistance couple—that is,

$$W \times x = T \times y.$$

\* See "The Design of Aeroplanes," by A. W. Judge, for full information on this subject.

If the engine stops,  $T$  will be zero, and the machine will be unbalanced. The weight-lift couple will then cause the nose of the machine to rise; the thrust being lost, the machine loses its flying speed, and the planes cease to support the weight, consequently a tail-dive occurs.

Case III. Line of Propeller Thrust below Centre of Resistance

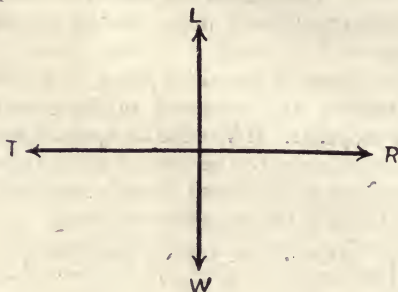

FIG. 9.

(Fig. 12).—As in Case II., the weight-lift couple must equal the thrust-resistance couple, and so

$$W \times x = T \times y.$$

An engine stoppage will, in this case, result in a nose-dive, as the weight-lift couple acts so as to pull the nose of the machine down.

If the lines of thrust and resistance be not far apart—that is, do not exceed 2 feet in ordinary machines—the effects of engine

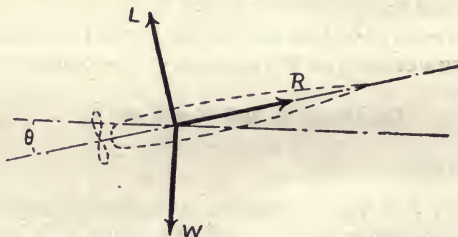

FIG. 10.

stoppage may be counteracted by use of the rear elevator, moving same downwards in Case I. and upwards in Case II.

In many present-day machines the C.G. is below the C.R. by about 1 foot to 1 foot 6 inches.

Where the C.G. is very low, as in the "parasol" types of

machine, "steadiness" is obtained at the expense of pitching and rolling with a fairly low period of movement, and the centrifugal effect of turning causes the weight to swing outwards like a pendulum; lateral control is also more difficult.

In many present-day machines the centre of resistance is below the centre of propeller thrust, in order to obtain sufficient propeller

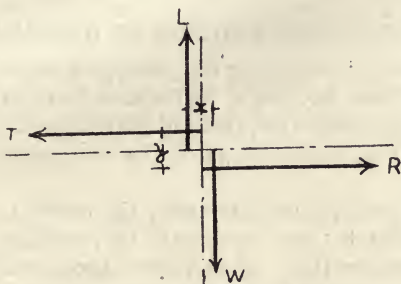

FIG. 11.

clearance from the ground under the worst landing conditions; there is also a stabilizing effect from the propeller.

In Case I. it was stated that for perfect equilibrium the lines of action of the weight and lift should coincide. This condition of equilibrium can only be true for one angle of incidence of the aerofoil, or wing, of present-day practice, since the position of

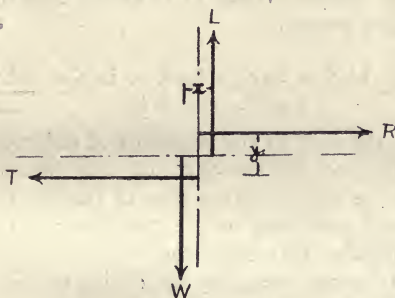

FIG. 12.

the centre of pressure changes with the angle of incidence; the use of auxiliary surfaces, such as the longitudinal V-tail or rider plane arrangement, negative wing tips, etc., ensure a more or less steady position of the centre of pressure at all flying angles.

Some data for design purposes in connection with the stability of aeroplanes is given in the separate volume of this series, entitled "Stability and Control," in which the principles of

stability are discussed, and corresponding particulars are furnished for the design of all control surfaces, etc.

In the case of the lines of action of the resistance and of thrust, these will only coincide at one particular angle of incidence, since the centre line of resistance varies with the angle of incidence and the speed.

### CALCULATION OF THE POSITION OF RESULTANT FORCES.

It is necessary, in applying the principles already given to the case of an actual aeroplane, to be able to compute the exact positions of the centres of pressure, gravity, and head resistance respectively from a knowledge of the component forces acting in each case.

A concrete example will exemplify the method.

It is required to find the centre of (vertical) pressure of a complete aeroplane (Fig. 13) at a given speed and incidence. If the vertical forces due to the air pressures upon the component parts, such as the main planes, fuselage, tail planes, and elevator planes, be denoted by  $L_P$ ,  $L_F$ ,  $L_T$ , and  $L_E$  respectively, acting at distances  $X_P$ ,  $X_F$ ,  $X_T$ , and  $X_E$  from some given datum vertical line  $OO$ ; then, by taking moments about  $OO$ , the following relation is obtained:

$$(L_P + L_F + L_T + L_E)\bar{X} = L_P X_P + L_F X_F + L_T X_T + L_E X_E,$$

where  $\bar{X}$  is the distance from  $OO$  of the line of action of the resultant vertical pressure.

That is—

$$\bar{X} = \frac{L_P X_P + L_F X_F + L_T X_T + L_E X_E}{L_P + L_F + L_T + L_E} = \frac{\Sigma L \cdot X}{\Sigma L};$$

or, is equal to the sum of the moments of the component forces, about  $OO$ , divided by the sum of the forces acting. It is assumed that the actual forces due to the air pressures at the given speed and incidence of the machine are obtainable from experimental data or by calculation.

This general method is equally applicable to the cases of centres of gravity and resistance respectively.

In estimating the positions of the C.G. and C.R. it is usually convenient to take some fixed plane, such as the engine-plate, fuselage end, or in the latter case the propeller-thrust line, fuselage top, etc., and to reckon all moments as positive to one side of the chosen plane and negative to the other; the moments should then be added algebraically, and divided by the total weight in order to obtain the position of the resultant force.

When considering the position of the C.G., allowance must be

made for any variation in the loads themselves, due to such causes as an extra passenger being occasionally carried, the fuel consumption during a flight, release of bombs, etc.

It is usual to situate the passenger's seat and fuel tanks over the C.G. in order to preserve balance; and in the case of it being inconvenient to place the tanks over the C.G., for constructional or other reasons, the tanks may be arranged on either side of the C.G., so that their distances are inversely proportional to their relative fuel consumptions.

In the case of air-cooled engines this ratio is about 5:1, and for water-cooled engines about 10 or 12 to 1. In all cases it

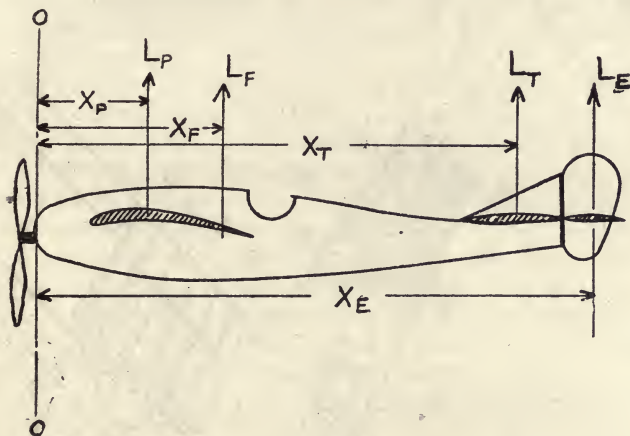

FIG. 13.

should be arranged, if possible, for "variable" weights to be placed as near to the C.G. as possible. In the case of the petrol tank the variation in the position of the C.G. will be very serious if this point is not observed. An 80-h.p. engine requires 240 pounds of petrol for a six hours' flight, which is very nearly the weight of the engine, so that unless the C.G. of the tank and fuel be on the C.G. a difference in balance will occur as the fuel is used up.

#### DYNAMIC STABILITY.

For proper dynamic stability, the machine must be stable against disturbances tending to rotate it—(1) about a lateral axis through the C.G. parallel to the wing-spars, (2) about a longitudinal axis through the C.G., and (3) about a vertical axis through the C.G. These axes are mutually at right angles.

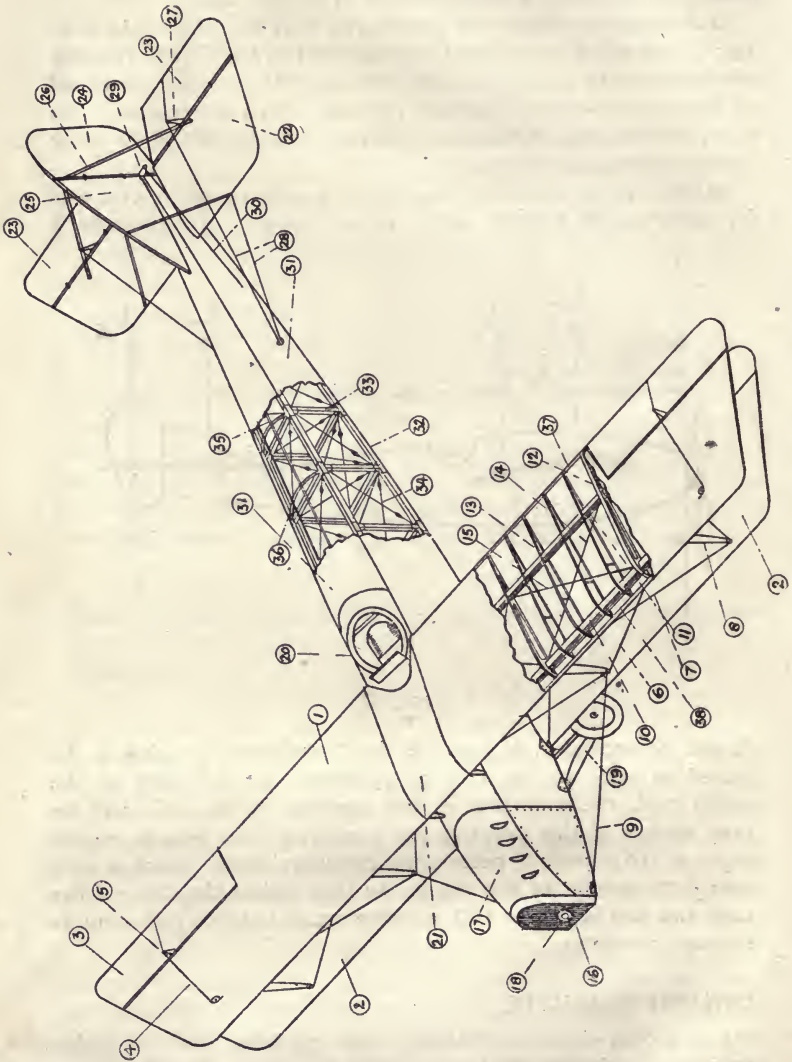

FIG. 14.—AEROPLANE NOMENCLATURE.

*Longitudinal* stability ultimately stops "pitching" about the axis (1), *Lateral* stability ultimately damps out "rolling" about axis (2), whilst *Directional* stability ultimately stops "yawing" about axis (3).

Longitudinal stability can be obtained in several ways, of which the more important methods consist of—

(a) Providing a fixed tail plane of much smaller area than that of the wings, at a distance behind the C.P. of same; the tail plane chord being set at a small incidence to the chord of the wings, so as to make, when both are produced an upward **V**, a little less than  $180^\circ$ . Any longitudinal disturbance brings into play a righting couple due to the increased or decreased amount of tail plane air pressure acting at a leverage about the C.G. of the machine.

(b) By sweeping back the tips of the wings and giving them a negative incidence, as in the Etrich Taube, or Weiss wings. This method is virtually the same as that of (a), for it consists of a large part of the wing area acting as a tail plane, at a small leverage.

(c) By employing two or more wings, and setting one of the wings at a smaller incidence than the others; this may be carried out by making one wing a kind of tail plane as in the tandem-wing machine, or by a biplane arrangement, with or without stagger to the wings, and employing different sections to the wings, so that the relative movements of the C.P.'s of the wings always bring into action a longitudinal righting couple.

NOTE.—The incidence wires are those between corresponding front and rear wing strut pairs, and are used for altering the angle of incidence of the wings.

*Explanation of Symbols in Fig. 14.*

- |                                    |                                 |
|------------------------------------|---------------------------------|
| 1. Upper Wing.                     | 19. Undercarriage.              |
| 2. Lower Wing.                     | 20. Pilot's Cockpit.            |
| 3. Upper Wing Aileron.             | 21. Wing Centre Section.        |
| 4. Aileron Balance Cable.          | 22. Tail Plane or Empennage.    |
| 5. Aileron Control Arm.            | 23. Elevator Plane.             |
| 6. Wing Lift Cable or Flying Wire. | 24. Rudder.                     |
| 7. Load or Weight Cable.           | 25. Vertical Fin.               |
| 8. Interplane Strut.               | 26. Tail Plane Struts.          |
| 9. Main Drift or Drag Cable.       | 27. Elevator Control Arm.       |
| 10. Front Wing Spar.               | 28. Elevator Control Cable.     |
| 11. Rear Wing Spar.                | 29. Rudder Control Arm.         |
| 12. Wing Compression Rib.          | 30. Rudder Control Cable.       |
| 13. Wing Former Rib.               | 31. Fuselage.                   |
| 14. Wing Drift Bracing Wire.       | 32. Fuselage Longeron.          |
| 15. Wing Anti-Drift Bracing Wire.  | 33. Fuselage Strut.             |
| 16. Engine Radiator.               | 34. Fuselage Bracing Wires.     |
| 17. Engine Cowling.                | 35. Fuselage Fairing Stringers. |
| 18. Propeller Boss, Radiator Hole. | 36. Fuselage Fairing Formers.   |
|                                    | 37. Trailing Edge of Wing.      |
|                                    | 38. Leading Edge of Wing.       |

The tail-behind method (*a*) is at present the one most widely employed. It is usual to make the area of the tail plane (including elevators) of from  $\frac{1}{8}$  to  $\frac{1}{10}$  of the wing area, and to place it so that the distance between the C.P. of the tail area (including elevators) and the C.G. is equal to from  $2\frac{1}{2}$  to  $3\frac{1}{2}$  times the chord of the wings. The chord of the tail plane should make an angle of from  $1^\circ$  to  $3^\circ$  to that of the wings. The section of the tail plane may either be a streamline, a cambered section similar to that of a wing, or a flat or rectangular section; the streamlined section appears to be the one most favoured.

Modern machines are provided with a wheel or lever for the pilot to alter the angle of incidence of the tail plane in flight to correct for variations in load, and to assist in gliding and climbing.

### LATERAL STABILITY.

The longitudinal stability of a machine can be treated separately from the other two types, which are more or less interdependent. A change in the lateral stabilizing surfaces or devices usually brings about complications in the directional stability and *vice versa*. When an aeroplane (Fig. 15, *A*) is tilted over sideways by any cause, as shown in Fig. 15, *B*, it will be seen that the "lifting" force on the wings, which acts normal to the wings, is no longer vertical, and that there is now a resultant force called into play which tends to cause the machine to "side-slip" along the plane of the wings. Neglecting the lateral controls, which are supposed to play no part in providing stability, the case illustrated in Fig. 15, *A* and *B*, is not a laterally stable one. The two principal methods adopted for providing a lateral righting couple are—  
(*a*) The lateral dihedral, and (*b*) the pendulum or low C.G. method.

The former method, which is shown in Fig. 15, diagram *C*, consists in setting the two halves of the wing (as viewed from the front of the machine) at a small upward inclination to the horizontal. The difference between the included  $\mathbf{V}$ -angle and  $180^\circ$  is known as the *Lateral Dihedral Angle*. For machines in which the C.G. of the whole side area of the machine approximately coincides with the C.G. of the machine's weight, a dihedral angle of from  $4^\circ$  to  $7^\circ$  is usually given. For a machine with a low C.G. (weight) a smaller dihedral, of from  $2^\circ$  to  $4^\circ$ , is generally given. Many machines have been given dihedrals of from  $6^\circ$  to as much as  $30^\circ$ , but the effect upon a normal design of machine of too much dihedral is to make the machine *too stable* laterally, in that every disturbance tends to make it rock and roll unpleasantly during recovery; it is therefore an uncom-



portable machine to fly. During lateral recovery, an aeroplane invariably side-slips to some extent, and also during such evolutions as banking or turning. The effect of this side-slip is to cause air pressure upon the side surfaces of the machine (including that of the fuselage, or body, the struts, wheels, rudder and fin), and the resultant force of this side pressure will act at a higher or lower point than the C.G., according as to whether there is much side area above or below the C.G. If above the C.G., the side pressure will cause a lateral couple about the longitudinal axis through the C.G. tending to right the machine laterally;

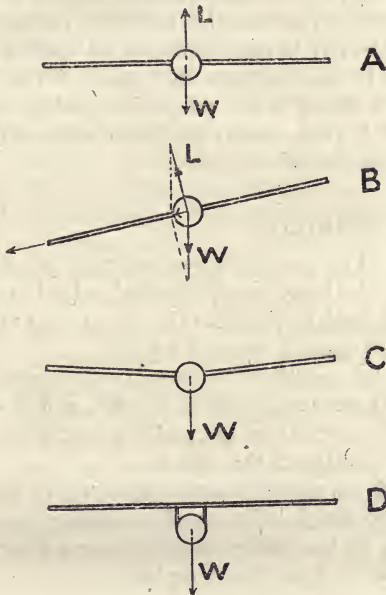

FIG. 15.—ILLUSTRATING PRINCIPLES OF LATERAL STABILITY.

if below the C.G., there will be an upsetting couple upon the machine, and therefore more dihedral angle will be necessary in order to make the machine stable.

If the centre of side pressure lies in front of the C.G., then the resulting couple will tend to bring the nose of the machine up, or the tail down—that is, to stall the machine during banking, whilst a backward position of this centre will tend to make the machine dive during banking; of the two effects, the latter is the more desirable, and one function of the vertical fin and rudder is to bring the centre of side pressure backwards.

The pendulum method of obtaining lateral stability is indicated in Fig. 15, diagram *D*, and it will be seen that the low C.G. produces a pendulum righting effect when the machine is disturbed laterally, similar to that experienced by a parachute in gusty weather.

The "parasol" type of monoplane, having the body below the plane of the wings, is an example of this method, but many machines, more especially seaplanes and flying boats, which do not, to the eye, appear to be of the low C.G. type, are actually so.

This type of machine is usually self-banking—that is to say, when the rudder is moved, the machine takes up its correct banking angle, but it is more difficult to control or manoeuvre laterally, owing to the counteracting effect of the low C.G.

Seaplanes and flying boats, which invariably have much side area below the C.G., are usually provided with vertical fins above the wings, or an increased dihedral.

### DIRECTIONAL STABILITY.

This is obtained by providing symmetrical side area or surfaces to the machine; the body, wing-dihedral, wheel area, rudder and vertical fins, all tend to preserve the directional stability and to keep the machine upon a straight course.

The effect of the propeller slip-stream is to cause a side pressure upon the vertical surfaces situated therein, and it is often necessary to give the vertical fin or rudder a slight rotation about a vertical axis to counteract this effect.

The effect of the propeller torque reaction is to produce a lateral upsetting couple, which it is usually necessary to counteract by giving one side of the wings slightly more angle of incidence (usually about  $\frac{1}{2}^\circ$  to  $1^\circ$  at the wing tip).

### AEROPLANE CONTROLS.

Apart from the stability requirements which all act so as to maintain the machine upon a steady course, it is necessary for evolutions, such as climbing, diving and turning, to provide means to "overcome" the three types of stability already considered. It will be seen, therefore, that the requirements of stability and of controllability are to a great extent opposed; a machine having a high degree of stability is not very easy to manoeuvre, whilst one possessing a low degree of stability will be easy to manoeuvre. For fighting in the air purposes, for small machines this is an advantage.

Fig. 14 illustrates the nomenclature employed in aeroplane work.

The *Longitudinal Control* is usually obtained by hinging the whole, or a part of the tail area about a lateral horizontal axis. In most normal types of aeroplane the elevator area is from 0.4 to 0.6 of the total tail area, and for large machines it is usual to balance part of the elevator by disposing it in front of the hinge axis; otherwise it is a physical strain upon the pilot to use the elevator. Moving the control lever towards the pilot brings the tail down; and away from him, the nose down.

The *Lateral Control* was at one time obtained (invariably for monoplanes, and occasionally for biplanes) by flexing or warping one side of the wings from the tips, and allowing the other side to flex upwards. In all modern machines the part of the wing tips called the *ailerons* or *flaps*, behind the rear spars, are hinged in the same direction as the elevators, but in such a manner that moving the control lever, say, to the left, causes the right-hand aileron to hinge downwards and exert a lift, and the left-hand one upwards and cause a reduction in lift, thus producing a lateral banking couple tending to rotate the machine into a position with the right wing up, as viewed from the pilot's seat.

The total aileron area is usually made from about  $\frac{1}{10}$  to  $\frac{1}{8}$  of the total wing area, and the aspect ratio varies from 4 to 8 or 10. Ailerons of large machines, or having a greater chord than about 1 foot, should be partially balanced,\* as in the case of the elevators.

*Directional Control* is obtained by means of the *rudder*, which is a small flat plane hinged about a vertical axis, and operated usually by the feet, through the rudder-bar. When the right foot is pushed forwards the right control arm affixed to the rudder is pulled and the machine turns to the pilot's right-hand side.

The rudder area is usually from about  $\frac{1}{25}$  to  $\frac{1}{50}$  of the main plane's area, and the distance between the C.P. of the rudder plane and the machine's C.G. varies from about  $3\frac{1}{2}$  to  $4\frac{1}{2}$  times the wing chord.

When a *vertical fin* is provided it is found by experience and test, that its area should be 0.6 to 1.0 times the rudder area.

## DESIGN PROCEDURE.

The commencement of a design should involve a rough layout of the projected machine, to fulfil the given specifications. It is usually the load capacity, speed and range of the machine

\* A control area is "balanced" by hinging it about an axis parallel to the leading edge, and at about  $\frac{1}{3}$  of the chord of the control area, behind same; in partial balance part of the control area is arranged to lie in front of the axis of hinging.

that fixes the type and the size; it is necessary to know beforehand what engine is to be used, together with its weight, h.p. performance curves, and fuel consumptions. Having made a rough layout, employing empirical or rationally derived data for the correct proportions of the wings, the body, and the control areas, an approximate weight estimate is next made; this enables the wing area and control areas to be more accurately adjusted.

The position of the C.G. is then determined for a tentative wing position. The lines of propeller thrust and the position of the wings can then be adjusted, and the main component weights moved a little, so as to bring the centres of action of the four principal forces as nearly as possible into line.

The preliminary design work is usually a matter of trial-and-error, involving many minor changes in the dispositions of the parts in order to obtain not only statical equilibrium, but to fulfil the other requirements of the specification, such as that concerned with the pilot and other occupants' positions and fields of view, the undercarriage position, propeller ground clearance, accessibility of engine and other parts, the strength and structural requirements, etc.

The final design should be carefully checked from the points of view of—(1) Manufacture Economy, (2) Structural Strength, (3) Specification Performance, (4) Degree of Stability, and (5) Degree of Control.

It is often advisable to make one experimental machine of a type first in order to find out what modifications, as the result of air tests, are necessary.

An appreciable amount of time may be saved, and valuable information gained, by testing a scale model of the proposed machine in the wind-channel at speeds approaching those of flight. The aerodynamical characteristics of a machine necessary for a computation of the performance, stability and controllability, may in this way be very approximately obtained.

### SKIN FRICTION.

For a thin flat plate placed edgewise in the air stream, the skin friction may be expressed as  $F=0.0000082 A^{0.93} v^{1.86}$  (Zahm), where  $F$  = force in pounds,  $v$  is the velocity in feet per second, and  $A$  the area of one surface of the plate; or  $F=0.0000316 A^{0.93} \cdot V^{1.86}$  when  $V$  is in M.P.H., and  $A$  the area of the double surface.

An approximate rule for giving fairly accurate values from 0 to 100 miles per hour is (Berriman)  $F=0.000018 A \cdot V^2$ , where

A is the area of the double surface, and V the velocity in M.P.H.

This approximate formula gives results which are correct at 100 miles per hour, but which are about 10 per cent. too low at 40 miles per hour.

A useful figure to remember is that the skin friction per double square foot at 60 miles an hour is 0.06 pound, and that it varies approximately as the square of the velocity.

## CHAPTER II

# GENERAL DESIGN CONSIDERATIONS AND DATA

### GENERAL CHARACTERISTICS.

It is desirable that an aeroplane should possess the following qualities:

1. It should be efficient—that is, it should be able to carry the maximum load for a given distance with the least expenditure of energy. Expressed symbolically, the ratio  $\frac{\text{Weight} \times \text{Velocity}}{\text{Horse Power}}$  should be as large as possible, consistent with the usual factors of safety adopted.
2. It should have a low minimum safe flying speed and a large speed range, and, further, the maximum flying speed should be aerodynamically safe.
3. It should be stable under all conditions of the weather.
4. It should exhibit a good climbing rate.
5. It should be capable of being easily controlled and flown, with the least expenditure of physical energy upon the part of the pilot.
6. It should possess a good gliding angle, in order to obtain, from a given height, the maximum available alighting area.

Further minor requirements are that it should be easily dismantled and re-erected for transporting, silent when in flight, all parts should be weatherproof, it should be able to rise from "plough" land quickly, and should be provided with landing brakes.

### SPECIAL CHARACTERISTICS.

These will depend upon the purpose for which the machine is designed. Examples of these special qualities for certain types of machine are given below:

1. *Scouting Aeroplane.*—Designed to carry pilot only at a high speed, with a high climbing rate. Capable of being started and manipulated single-handed. Built very light; good distance range. (Fig. 16, A.) Either monoplane or small biplane, fitted with engines of h.p.

ranging from 100 to 400. Speeds: maximum, 100 to 150 M.P.H.; minimum, 45 to 80 M.P.H.

2. *Reconnaissance Aeroplane*.—Designed to carry passenger and pilot, with signalling appliances, fuel capacity for

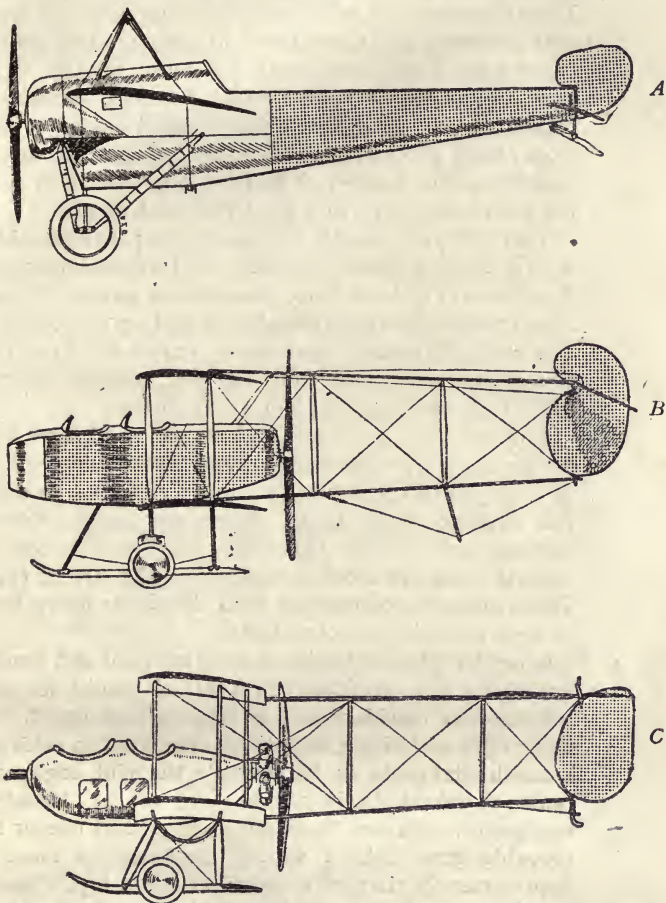

"Flight" copyright.

FIG. 16.—TYPES OF AEROPLANES.

a wide radius of action, large speed range for reconnaissance at a minimum speed, able to land and get off from rough ground, silent and as invisible as possible, both on ground and in the air, wide field of view, stable, easily transported, and weather-proof. (Fig. 16, B).

Usually a biplane of tractor or pusher type, two- or three-seater, one or two engines. Total h.p. varying from 100 to 450. Speeds from minimum of 40 to maximum, about 120 M.P.H. Ceiling from 14,000 to 18,000 feet. From three to six or more hours' fuel supply for full speed.

3. *Large Bombing and Commercial Machines.*—Designed to carry large loads over great distances; usually of the two to six engine types, either tractors, pushers or combinations. Weights of fully loaded machines vary from about 3 to 15 tons, the useful loads (including passengers, goods, bombs, or fuel for long distances) vary from about 0.15 to 0.35 of the total weight.

Two pilots are usually carried in fore part of machine, with good view ahead, engineers, and wireless operators. Engines vary in total horse-power from 400 up to 3,000. Speed range varies from about 40 M.P.H. up to 110 M.P.H. The ceiling is usually from about 12,000 to 18,000 feet. Wing-spans vary from 50 to 150 feet., lengths from 40 to 90 feet, and heights from 15 to 40 feet.

Biplanes and triplanes, with single or biplane tails, are generally in vogue for this type of machine. Flights of from 300 to 1,200 miles, without a stop, can be made, the average stage being about 500 miles. Control surfaces are usually balanced, and servo-motors to operate same are fitted in the case of the largest types. These machines correspond with the larger flying boats in their general characteristics.

4. *Fighting Aeroplane.*—Designed to carry pilot and gunner, quickfiring gun (preferably in front), or bombs, for overtaking other machines and destroying, high speed, good field of fire and vision, sometimes armoured on sides and beneath vital parts, as, for example, the pilot, engine and tanks; it should also be silent. (Fig. 16, C.) Usually a two-seater, with two fixed guns ahead, and one or two movable guns behind wings. Performance must be approximately that of a scout. Engine h.p.'s usually vary from 250 to 450. Lightly built and capable of rapid manœuvring. From two to three hours' fuel supply.
5. *Seaplanes.*—Designed to carry pilot, passenger, and fuel for a wide radius of action, capable of alighting on and getting off from fairly rough seas, seaworthy and protected against external influences, easily dismantled and stowed away. (Fig. 17.) Seaplanes have about the same performances and characteristics as reconnaissance



machines. Flying boats weighing from 5 to 15 tons, of the one to six engine types, are now employed for long-distance oversea flights. They vary from about 400 up to 3,000 h.p., and have speed ranges varying from about

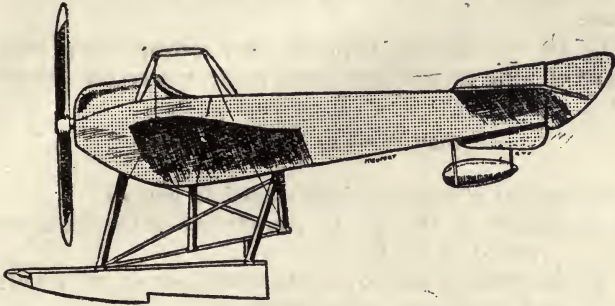

The 100 h.p. Nieuport seaplane.

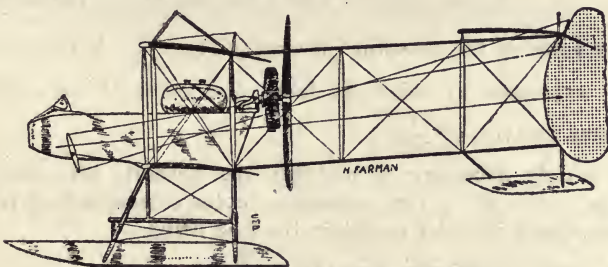

The 80 h.p. H. Farman seaplane.

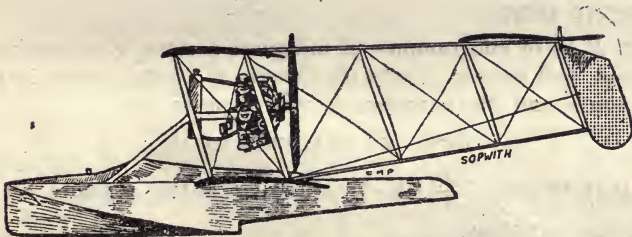

The 200 h.p. Sopwith flying boat.

"Flight" copyright.

FIG. 17.—TYPES OF AEROPLANES.

40 to 110 M.P.H. Their fuel capacities vary from about three up to ten hours at full speed. The number of passengers carried varies from three in the smaller up to fifteen or twenty in the larger types.

**WING LOADING.**

The weight of an aeroplane is governed largely by its special function, and having once been estimated as correctly as possible, the wing area for supporting this load can be obtained as follows:

If  $C_L$  be the absolute lift coefficient corresponding with the section\* of wing chosen from speed range, power, etc., considerations,

$$\text{then } W = C_L \cdot \frac{\rho}{g} \cdot A \cdot V^2, \text{ where}$$

$W$  = weight of machine, fully loaded, in pounds;

$\rho$  = density of the air in pounds per cubic foot = 0.0807 pound at 32° F.;

$g$  = acceleration due to gravity in feet per second = 32.18;

$A$  = area of wings in square feet;

$V$  = velocity corresponding to normal flying angles (usually between 3 degrees and 5 degrees) in feet per second.

The value of the constant  $\frac{\rho}{g}$  is 0.00236, or  $\frac{1}{424}$ . If the velocity  $V$  be expressed in miles per hour, the value of the constant becomes 0.00510, or  $\frac{1}{196}$ .

It is only necessary to multiply the absolute lift coefficient by the area and by the conversion factor corresponding to the chosen speed, in order to obtain the load lifted.

$$\begin{aligned} \text{The wing loading per square foot} &= \frac{W}{A} = C_L \cdot \frac{\rho}{g} \cdot V^2 \\ &= C_L \times \text{Conversion Factor.} \end{aligned}$$

**METRIC UNITS.**

If  $W$  be in kilogrammes,  $A$  in square metres,  $V$  in metres per second, and further, if  $\rho$  be the density of 1 cubic metre in kilogrammes, and  $g$  be expressed in metres per second,

$$\text{then } g = 9.81, \text{ and } \rho = 1.25,$$

so that  $W = C_L \cdot \frac{1.25}{9.81} \cdot A \cdot V^2$  where  $C_L$  is the absolute lift coefficient, as before.

(The lift and drift coefficients  $K_y$  and  $K_x$  employed by Eiffel in his published results can be converted into absolute coefficients by multiplying them each by 8.0.

$$\text{Thus } C_L = \frac{1.25}{9.81} K_y = 8.0 K_y, \text{ and } C_D = 8.0 K_x.)$$

\* A typical section, suitable for an aeroplane wing, is shown in Fig. 8.

TABLE IV.—LIFT COEFFICIENTS FOR 1,000 POUNDS LOAD.

Speed in M.P.H.	30	40	50	60	70	80	90	100	110	120	130
Speed in Ft. per Sec.	44	58.7	73.4	88	102.8	117.4	132	146.8	161.4	176	190.8
Areas in Sq. Ft.											
150	1.460	0.8210	0.5240	0.3660	0.2678	0.2057	0.1624	0.1316	0.1090	0.0911	0.0778
175	1.250	0.7020	0.4485	0.3138	0.2294	0.1762	0.1391	0.1130	0.0931	0.0784	0.0666
200	1.095	0.6140	0.3930	0.2742	0.2010	0.1542	0.1220	0.0971	0.0816	0.0685	0.0585
225	0.9740	0.5470	0.3495	0.2441	0.1787	0.1370	0.1083	0.0876	0.0724	0.0608	0.0520
250	0.8770	0.4810	0.3142	0.2198	0.1606	0.1234	0.0974	0.0790	0.0651	0.0547	0.0469
275	0.7960	0.4465	0.2857	0.1995	0.1459	0.1120	0.0885	0.0716	0.0592	0.0497	0.0424
300	0.7307	0.4100	0.2622	0.1831	0.1341	0.1030	0.0813	0.0659	0.0544	0.0456	0.0389
325	0.6738	0.3780	0.2421	0.1691	0.1236	0.0949	0.0749	0.0606	0.0502	0.0421	0.0359
350	0.6250	0.3513	0.2244	0.1569	0.1147	0.0881	0.0696	0.0563	0.0466	0.0390	0.0334
375	0.5840	0.3278	0.2100	0.1463	0.1071	0.0823	0.0649	0.0526	0.0434	0.0364	0.0312
400	0.5478	0.3075	0.1969	0.1373	0.1006	0.0772	0.0610	0.0494	0.0408	0.0342	0.0292

### CALCULATION OF WEIGHTS, AREAS, AND SPEEDS.

In order to facilitate the process of the selection of wing areas to suit different conditions of loads and speeds, the values in Table IV. have been calculated from the relation—

$$C_L = \frac{W \cdot g}{A \cdot \rho \cdot V^2}$$

There are four possible variable factors in this relation, namely, the load, area, velocity, and lift coefficient; if any three are known, the fourth can be at once ascertained.

*Example 1.*—Required the wing area to support a load of 1,000 pounds at a speed of 80 miles per hour for the Bleriot XI.A section wing having a lift coefficient of 0.159 at 2.0 degrees incidence.

From the table it will be seen that this value for  $C_L = 0.159$  gives a wing area of about 195 square feet.

*Example 2.*—Required the speed necessary to support an aeroplane of 800 pounds weight, with a wing area of 175 square feet, and for which at the normal flying angle of 4 degrees  $C_L = 0.314$ .

The speed for 1,000 pounds weight will be seen from the table to be about 60 miles per hour, and therefore the speed corresponding to 800 pounds weight will be  $60 \sqrt{\frac{800}{1000}} = 54$  miles per hour.

### GENERAL USES OF TABLE IV.

For properly defined conditions of loading, speed, and wing area, it is possible to select the proper wing sections which give the required values of the lift coefficient.

Values of  $C_L$  for all known types of wings vary from  $C_L = 0.00$  at 0 degree, or a small negative angle of incidence, to  $C_L = 0.80$  in the extreme cases at angles of incidence of about 10 or 14 degrees, and the range of values for  $C_L$  chosen must lie between these limits, and, further, must not be associated with any unstable position of the centre of pressure, or with the value of the lift coefficient at the critical angle of incidence (usually beyond 14 degrees), at which  $C_L$  becomes less.

Obviously the values given in Table IV. for  $C_L$ , which are greater than 0.80, are inapplicable to all ordinary types of aeroplane wing of the present day.

For further information upon the subject of wing sections, lift and drift coefficients, and wing selection for design purposes, the reader is referred to the volume of this series entitled "The Properties of Aerofoils and the Resistance of Bodies," to Eiffel's works, and to the Advisory Committee's Reports.

The speed range of a machine can be roughly estimated from the table; thus, if the wing section chosen gives values of  $C_L$  of

0.097 at +0.5 degree incidence, and 0.481 at 12 degrees incidence, and, further, if these extreme flying angles are aerodynamically sufficiently "safe," then for a wing area of 250 square feet and load of 1,000 pounds, the range of speeds (from the table) will be 40 to 90 miles per hour; numerous other examples of the application of the table might be given.

The maximum speed theoretically obtainable will depend upon whether for the chosen load, the horse-power corresponding to the included engine weight is sufficient to overcome the head resistance, after allowing for the propeller "inefficiency"; this subject is further considered later on.

### THE APPLICATION OF THE RESULTS OF MODEL TESTS TO FULL-SIZED MACHINES.

It is of great importance to know how far the results of wind-tunnel tests upon model aeroplane wings are applicable to the full-sized machine; the models are generally made from one-tenth to one-twentieth of the full size, and the wind-tunnel speeds have usually been considerably lower than the true flying speeds of the machines themselves. The wind-tunnel speeds vary from 25 to 45 miles per hour (although the latest wind tunnels give higher speeds), whilst the full-sized machines have flying speeds varying from 45 to 125 miles per hour.

In his earlier researches, Eiffel, with the limited data at his disposal, found that the performances of actual machines could be fairly accurately predicted by increasing both the lift and the drift coefficients by 10 per cent.; this correction being based upon the results of measurements of the normal pressure upon flat plates of different area, the normal pressure coefficients varying from 0.576 in smaller planes to 0.640 for large planes. It should be here mentioned that the wind tunnel and the actual aeroplane speeds were not the same, the former being the slower. Eiffel's later experiments upon models of aeroplanes, when compared with the results worked out from readings of recording instruments placed upon aeroplanes exactly similar to the models, flying in still air, showed that the lift and drift coefficients agreed within 1 per cent., when the speeds (15 to 17 metres per second) were about the same.

The model was here tested at the same speed as the aeroplane readings were taken; other comparisons between scale and actual machines showed the same results.

In the case of the Tatin and Nieuport machines, it was found that the lift/drift ratio was greater than that of the model, owing, no doubt, to increase of speed in the former case.

Tests upon scale models of actual machines show that the model lift coefficient requires only a small correction, if any, but that the drift coefficient for the model is from 15 to 20 per cent. higher than for the actual machine.

It has been demonstrated that the results of model tests may be applied to full-sized machines, if the product  $\frac{V \cdot L}{\nu}$  is the same in the two cases, where  $V$  is the velocity,  $L$  the length, and  $\nu$  is the ratio  $\frac{\text{viscosity}}{\text{density}}$  (or the kinematic viscosity) for the fluid or medium in which the model or full-sized machine is tested. If both are tested in air, then the product  $L \cdot V$  should be the same for each case.

The difference in the drift coefficients of scale and full-sized machines is probably due to the lower skin friction of the latter, for it is known that the skin friction of surfaces both in air and water decreases with increase in area and speed.

In applying corrections to model results for the full-sized machine, it must be remembered that insufficient experimental data has as yet been accumulated in this direction.

### WING-LOADING DATA.

In current practice the wing loading expressed in pounds per square foot for biplanes is about  $0.0012 V^2$ , and for monoplanes is about  $0.0014 V^2$  where  $V$  is the minimum designed speed in feet per second.

Light loadings correspond with large wing areas for a given load, and generally necessitate larger engine powers to fly at a given high speed, but give a larger margin of safety against excessive loadings due to manœuvring, wind gusts, etc.

In biplanes\* the loading varies from values as low as 2.6 up to the limiting value of about 9.0 pounds per square foot, the average value being about 5.5.

For monoplanes the loading varies from 4.5 up to 10.0 for normal type machines, a good average figure being 6.5.

The 1913 Gordon-Bennett Deperdussin monoplane of 107 square feet wing area, and 1,500 pounds weight, fitted with a 160 h.p. engine, gave a wing loading of 14.0, and another machine, the 100 h.p. Ponnier, gave a wing loading of 12.75, the speeds

\* For high performance machines, the wing loadings vary from 6 to 10 pounds per square foot, and such loadings correspond to machines having high maximum horizontal and climbing speeds; the ratio  $\frac{\text{weight}}{\text{b.h.p.}}$  for such machines varies from 10 to 14, whereas in the case of normal machines it ranges from 15 to 20. For large seaplanes and flying boats it varies from about 17 to 22 pounds per horse-power.

attained in both cases being well over 100 miles per hour. These loadings, however, are quite exceptional for normal flight conditions in ordinary machines.

For seaplanes of the normal type, the average wing loading figure is from 4.8 to 5.8 pounds per square foot.

### MONOPLANES AND BIPLANES.

It will be seen from the foregoing considerations that the wing loading of monoplanes is generally higher than that of biplanes for the same performances; both types can, however, be designed quite satisfactorily as regards strength and stability, but each type of construction has its own peculiar advantages, which may be enumerated as follows:

#### Monoplane.

1. Possesses a lower head resistance due to the absence of separate struts, ties, etc., and thus higher speeds are capable of being attained upon this account; the most successful racing machines have hitherto been monoplanes.
2. More easily controlled, and therefore require less physical exertion on the pilot's part; this is chiefly owing to the relatively smaller moments of inertia about axes of symmetry.
3. More efficient than biplanes in effective lifting capacity, on account of absence of interference with the second plane (as in a biplane).
4. Cannot be made in very large sizes, on account of the excessive wing weights, etc.; the largest monoplanes in use have wing areas varying from 240 to 280 square feet, the usual sizes being from 150 to 200 square feet.
5. Can be easily packed and transported.

During 1912, as a result of a number of accidents to monoplanes, a Government Committee instituted an inquiry into the causes of these accidents.

In the Report\* issued it was made clear that the accidents were not due to any causes connected with this type of machine, and that the monoplane could be made just as strong as the biplane; the following are the chief conclusions of the Report:

1. The accidents to monoplanes specially investigated were not due to causes dependent on the class of machine to which they occurred, nor to conditions singular to the monoplane as such.

\* *Vide Aeronautics* (March, 1913), "Report of the Government Committee on Monoplane Accidents."

2. After considerations of general questions affecting the relative security of monoplanes and biplanes, the Committee have found no reason to recommend the prohibition of the use of monoplanes, provided that certain precautions are taken, some of which are applicable to both classes of aeroplane.
3. The wings of aeroplanes can, and should, be so designed as to have sufficient strength to resist drift without external bracing.
4. The main wires should not be brought to parts of the machine always liable to be severely strained on landing.
5. Main wires and warping wires should be so secured as to minimize the risk of damage in getting off the ground, and should be protected from accidental injury.
6. Main wires and their attachments should be duplicated. The use of a tautness indicator to avoid overstraining the wires in "tuning up" is recommended. Quick release devices should be carefully considered and tested before their use is permitted.
7. In view of the grave consequences which may follow fracture of any part of the engine, especially in the case of a rotary engine, means should be taken to secure that a slight damage to the engine will not wreck the machine. Structural parts, the breakage of which may involve total collapse of the machine, should, so far as possible, be kept clear of the engine.
8. The fabric, more especially in highly loaded machines, should be more securely fastened to the ribs. Devices which will have the effect of preventing tears from spreading should be considered. Makers should be advised that the top surface alone should be capable of supporting the full load.
9. The makers should be required to furnish satisfactory evidence as to the strength of construction, and the factor of safety allowed. In this, special attention should be paid to the manner in which the engine is secured to the frame.

In further connection with the comparison of monoplanes and biplanes, it has been estimated that for planes of the same aspect ratio, span, section, and incidence, the monoplane has from 10 to 15 per cent. more lift at the same speed than the biplane, and it is generally considered that for machines of wing area below 250 square feet the monoplane is the more efficient.

A higher landing chassis is required with a monoplane, in order to obtain sufficient propeller clearance, as compared with the biplane.

As regards the weights of monoplane wings, it is generally



recognized that the methods for bracing the wings are inferior from the point of view of strength to the deep girder system of the biplane, and therefore the wing spars are made stronger in themselves, and therefore heavier, in order to obtain the necessary safety factor.

### Biplanes.

1. The wing areas can be made as large as desirable owing to the light girder construction of the biplane system; further, large spans and higher aspect ratios may be used.  
The wing areas vary from 250 square feet for light scouts, 300 to 1,000 for weight-carrying biplanes, 500 to 3,000 for seaplanes, flying-boats, and large passenger-carrying machines.
2. Owing to the large areas available, the wing loading can be made as small as desired, the landing and rising speed can be reduced, and a small engine can be used if it is not desired to fly at fast speeds.
3. The design of a biplane adapts itself much better for military purposes; thus it is easy to place the engine and propeller behind the pilot, to stagger the top plane forwards, and to leave a clear field of view or of gun-fire ahead.

### BIRD FLIGHT DATA.

Dr. Magnan, as the result of a systematic study of bird flight and measurements, gives the following empirical results for monoplane design (*Comptes Rendus*, 1914):

If  $P$  = total loaded machine weight in grammes,  
 $S$  = area of body in square centimetres,  
 $l$  = total length of bird in centimetres,  
 $l = \sqrt[3]{P}$ , and  $S = \sqrt[3]{P^2}$ .

Then

$$\frac{\text{wing area in square centimetres}}{\sqrt[3]{P^2}} = 23.2;$$

$$\frac{\text{weight of wings (in grammes)}}{P} = 0.197;$$

$$\frac{\text{span of wings (in centimetres)}}{\sqrt[3]{P}} = 13.3;$$

$$\frac{\text{chord of wing (in centimetres) at centre}}{\sqrt[3]{P}} = 2.36;$$

$$\frac{\text{length of tail (in centimetres)}}{\sqrt[3]{P}} = 2.6;$$

$$\frac{\text{real length of body (in centimetres)}}{\sqrt[3]{P}} = 5.9.$$

The proportions for any monoplane can be worked out from these relations.

Thus, if  $P = 400$  kilogrammes (for a fully loaded monoplane), we have:

Area of wings = 12.6 square metres, chord = 1.74 metres, span = 9.8 metres, weight of wings = 78.8 kilogrammes, length of tail = 1.92 metres, length of machine = 4.35 metres.

These results correspond with a wing loading of 6.5 pounds per square foot.

It should be mentioned in passing, that the design of the successful Ponnier racing monoplanes has been based upon these methods of application of Dr. Magnan's results, but that the length of body obtained is considerably shorter than in ordinary machines.

### DISTRIBUTION OF WING LOADING.

The previous remarks upon wing loading have been confined to the average values of the loading for the whole area of wing, and in estimations of this mean wing loading it is assumed that the lift coefficient is constant over the whole area of wing.

Actually, the value of the lift coefficient for an aerofoil of constant section varies along the span of the aerofoil. Thus the greatest lift coefficient, and therefore wing loading, occurs at the central section, and falls off towards the tips, and the value of the load per square foot at the centre section of the wing span may become more than twice that at, or near, the wing tips.

The ratio of the loadings per unit area at the centre section of the span, and for the section near the wing tip, will depend upon the aspect ratio of the aerofoil and also its plan-form, being smaller for the larger aspect ratio, and smaller for rounded off and graded, or washed-out, wings towards the tips.

Fig. 18 illustrates an aerofoil tested by the N.P.L., with an aspect ratio of 6, and at a wind speed of 30 feet per second. The values of the pressures at different points over the wing were measured, and the results of these measurements are shown plotted in this figure for the case of the more important negative pressures, at points situated at a distance of 0.200 of the chord from the leading edge. The values of the pressure are about a maximum at the given angle of 4 degrees, and for the points situated at 0.200 of chord from leading edge. The values of the pressures per square foot at any given speed  $V$  feet per second, for the full-sized wing, are obtained from the Absolute Coefficients given in the graphs, by multiplying the ordinate at any point along the span by  $0.00238 V^2$ ; thus, if the ordinate, as measured

off, be 0.424, then the pressure in pounds per square foot at 60 miles per hour (=88 f.s.) will be  $0.00238 \times 88^2 \times 0.424 = 7.72$ .

The values for the lift coefficients and lift/drift ratios for the sections designated by the letters A, B, C, D, and E are given in Fig. 19.

The data given in these curves will indicate the nature of the distribution of the wing loading along the span. In calculations of wing stresses, account should certainly be taken of the variation of the loading along the span of the wing.

The above results are directly applicable to the upper wings of most biplanes and the "parasol" type monoplanes, where the fuselage and its fittings does not interfere with the nature of the air-flow (and consequent pressure distribution) along the surfaces.

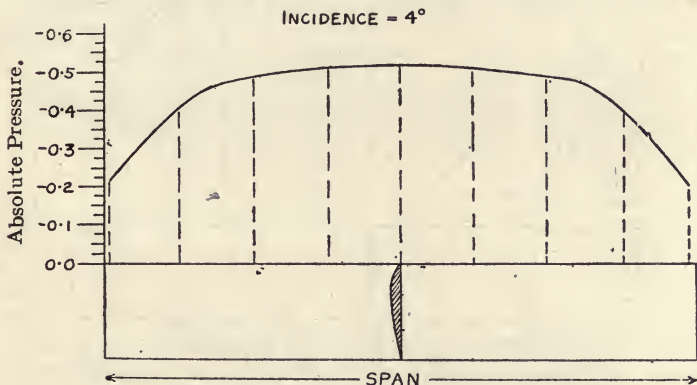

FIG. 18.—PRESSURE DISTRIBUTION ALONG AN AEROFOIL (TOP SURFACE).

The effect of fitting the body or fuselage at or near the centre of the wing, as in the case of the lower wings of most biplanes and in most monoplanes, is to interfere with the air-flow at and near the central section, and so reduce the efficiency of the whole wing. In some cases, however, the fuselage or body resistance is reduced by attaching the wings. The propeller will also depreciate from the wing efficiency if the slip stream pass over the wing surface at the centre, on account of its helical motion.

When it is remembered that a one-sixteenth scale model aerofoil showed a lift/drift of 24.0 at 4 degrees incidence at the mid-section, whereas the average lift/drift for the whole wing, as measured directly, was about 15.0 for the same angle, it will be seen that the central portion of the aerofoil or wing is very important in contributing to the efficiency of the whole wing.

The wing loading per unit area for any given section along the direction of the line of flight also varies along the chord of wing; this will be apparent from the pressure distribution diagrams shown in Fig. 20 for Eiffel's Bleriot XIII.A. At sections near

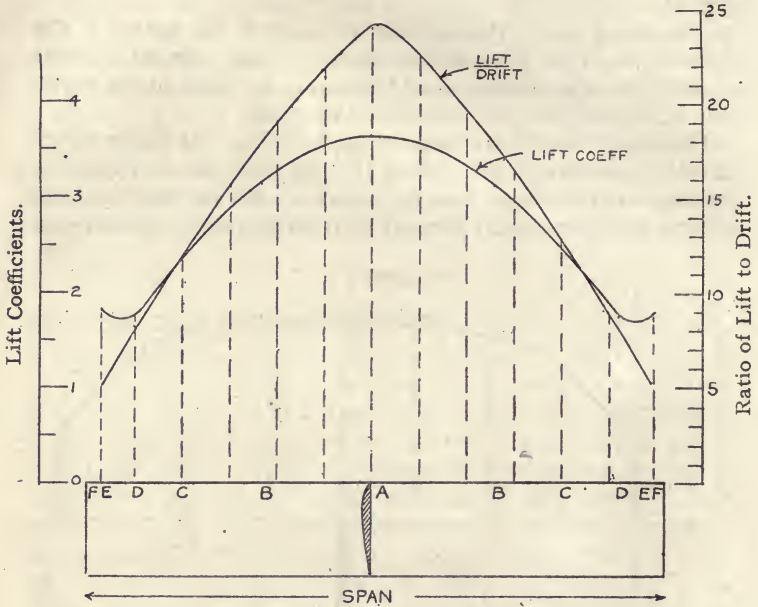

FIG. 19.—LOAD VARIATION ALONG THE SPAN OF AN AEROFOIL.

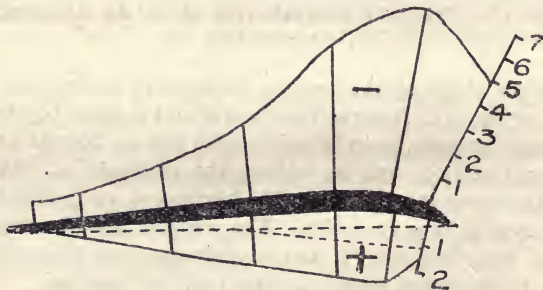

FIG. 20.—DIAGRAM OF PRESSURE DISTRIBUTION OVER AN AEROFOIL.

the centre of the span the point of greatest intensity of loading is near the leading edge and upon the top surface, usually situated between the leading edge and 0.3 of the chord from the leading edge.

The greatest pressure (or suction) occurs at the large flying

angles of incidence, in ordinary flight conditions. The fabric upon the upper surface near the leading edge is under the greatest stress, and the worst stress that can occur is when there is a leakage of positive pressure from the under surface, in addition to the suction upon the top surface. It can be shown that ratio of the maximum to the mean pressure per unit area for the whole wing can be as high as 10.0 for normal flying conditions.

The value of the maximum negative pressure or suction which is realized under normal flying conditions upon the upper surface near the leading edge—that is to say, between the leading edge and a point situated at 0.3 of the chord from the leading edge—lies between 20 and 30 pounds per square foot at small angles of incidence. As the angle of incidence increases, the ratio of the maximum to mean pressure decreases, as reference to Table V. will show.

TABLE V.

<i>Angle of Incidence (Degrees.)</i>								<i>Ratio of Max. Pressure to Mean Lift per Sq. Ft.</i>
0	..	..	..	..	..	..	..	10.00
2½	..	..	..	..	..	..	..	4.20
5	..	..	..	..	..	..	..	2.90
7½	..	..	..	..	..	..	..	2.70
10	..	..	..	..	..	..	..	2.95
12½	..	..	..	..	..	..	..	3.10
15	..	..	..	..	..	..	..	1.20
20	..	..	..	..	..	..	..	1.20

For ordinary angles of incidence as used in practice this ratio is about 3 to 1.

**LOADING OF UPPER AND LOWER SURFACES.**

In connection with the proportion of load carried by the upper and lower wing surfaces, Table VI. gives the percentage of the total lift contributed to, by each surface for a type of wing section resembling Eiffel's Bird Wing No. 9, although the results are generally applicable to most aeroplane wing sections.

TABLE VI.—LOADING OF UPPER AND LOWER SURFACES.

<i>Angle of Incidence.</i>	<i>Upper Surface Load.</i>	<i>Lower Surface Load.</i>
0	92 per cent.	8 per cent.
2	82 "	18 "
4	74 "	26 "
6	74 "	26 "
8	72 "	28 "
10	69 "	31 "

From this table it will be seen that at small angles the upper surface carries about four-fifths of the load, and that even at large flying angles it carries two-thirds; it is general to design the wing of an aeroplane upon the assumption of the whole of the load being carried upon the upper surface.

It follows from the preceding considerations that for design purposes it is necessary to take into account the variation of load distribution both along the span and along the chord.

The method employable, in the absence of more definite data, is to assume a load variation or distribution along the span, somewhat similar to that shown in Fig. 19, so that the mean loading of the whole wing will be the same as if a uniform load were assumed.

### CHOICE OF FLYING ANGLES.

The choice of the normal and extreme flying angles of incidence depends greatly upon the purpose of the machine. Generally speaking, a high-speed type of machine requires a totally different wing section and incidence to a low or moderate speed type. The actual wing sections of aeroplanes of to-day must therefore be a kind of compromise between fast and slow speed sections, in order to ensure safe landing and "getting-off."

Where the greatest maximum speed is the first and foremost consideration, a flat approximation to a streamline wing section, at a small angle of incidence, varying from 0 degree to 2 degrees, is necessary. Further, it is essential that the position of the centre of pressure for the fastest flying angle shall be quite stable, and with a margin of safety in case of unforeseen circumstances causing a further decrease of angle of incidence.

For slow flying a wing section, characterized by good upper and lower surface cambers, and comparatively large angles of incidence, are necessary; further, it is essential that the angle of incidence shall not be too near to the critical angle at which the lift coefficient decreases and the drift increases, and that the centre of pressure has a stable position at the maximum incidence. An example of the wing section of a high-speed "scout" type, and a moderately powered medium-speed machine, similar to those used for flying-school tuition purposes, are given in Fig. 21. For a good speed range the wing sections chosen should possess the following qualities:

1. The centre of pressure for the range of flying angles used should have a stable position, and, further, the range of movement along the chord should be a minimum. The centre of pressure in a good wing section should

- lie between 0.3 and 0.45 of the chord distant from the leading edge at all incidences used in flying, alighting, etc.
2. The lift coefficient should continuously increase over a wide range of angles (from a negative or zero angle to 15 degrees or so), and should then remain constant, and finally decrease at a slow rate, without exhibiting a marked "critical angle"; the maximum safe lift coefficient should not be less than 0.65, whilst the maximum drift coefficient should, preferably, not exceed 0.100.
  3. At the small angles of incidence corresponding with the highest speeds, the drift coefficient should be a minimum; published data shows that a drift coefficient lying between 0.005 and 0.010 is attainable at angles

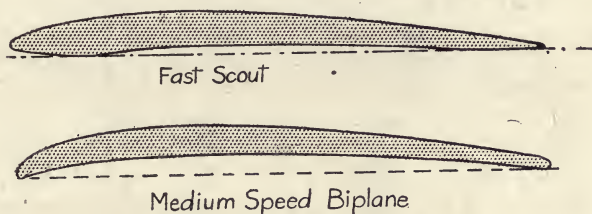

FIG. 21.—EXAMPLES OF FAST AND SLOW FLYING WING SECTIONS.

between 0 degree and 1.5 degrees incidence. A further requirement for maximum speed, for minimum expenditure of horse-power (for the wings alone), is that the lift coefficient at the minimum value of the drift coefficient should be sufficient for the wing area chosen to support the load at that speed.

The subject of wing sections and resistances of various aeronautical bodies is treated fully in the volume of this series entitled "The Properties of Aerofoils and Resistance of Bodies."

### ASPECT RATIO CORRECTIONS.

Models of aerofoils of the same chord and wing section (of approximately the Bleriot XI. *bis* section), but of different spans, have been tested for lift and drift by the N.P.L.

The chords of the models were 4 inches, and the aspect ratios varied from 3 to 8.

The general conclusions drawn from the results of these tests are as follows:

1. That the angles of zero lift occur earlier as the aspect ratio becomes smaller.
2. That at the angles of maximum lift/drift the lift coefficients are only slightly affected by change of aspect ratio.
3. That the maximum lift coefficient is unaltered by change of aspect ratio, but occurs at larger angles of incidence with smaller aspect ratios.
4. That the most important effect of aspect ratio is in connection with the values of the maximum lift/drift ratios obtained, as shown in Table VII. It will be seen that the lift/drift ratio increases rapidly with the aspect ratio; this effect is due almost entirely to the reduction in total drift which occurs with larger aspect ratios.

TABLE VII.—EFFECT OF ASPECT RATIO UPON MAXIMUM LIFT/DRIFT VALUES.

<i>Aspect Ratio.</i>	<i>Maximum Lift/Drift Ratio.</i>	<i>Angle of Incidence.</i>	<i>Lift Coefficient.</i>
3	10.1	5.5	0.305
4	11.5	4.7	0.310
5	12.9	4.7	0.312
6	14.0	4.5	0.314
7	15.1	4.7	0.315
8	15.5	5.7 (?)	—

From the results of aspect ratio tests upon model sections, the correction curves given in Fig. 22 have been drawn. The upper curve gives the percentage increase in the lift coefficients for different aspect ratios, taking the aspect ratio of 3 as the basis of comparison; similarly the lower curve gives the percentage reduction in the drift coefficients for different aspect ratios.

Thus, if it is required to know the percentage increase in the lift/drift in changing from an aspect ratio of 4 to one of 6, then from the curve

$$\begin{array}{l}
 \text{at aspect ratio 4} \left\{ \begin{array}{l} \text{Lift Coefficient} = 110.0 \\ \text{Drift} \quad \quad \quad = 95.5 \end{array} \right. \\
 \text{at aspect ratio 6} \left\{ \begin{array}{l} \text{Lift} \quad \quad \quad = 118.5 \\ \text{Drift} \quad \quad \quad = 87.0 \end{array} \right.
 \end{array}$$

Hence increase in lift/drift from aspect ratio 4 to aspect ratio 6 =  $\frac{100 + (118.5 - 110)}{100 - (95.5 - 87)} = \frac{108.5}{91.5} = 118.5$ .

That is, the lift/drift is increased by 18.5 per cent.

The above curve applies to all wing sections resembling the Bleriot XI. *bis* type, and for all angles between 4 degrees and 14



degrees, there being no correction for the zero angle, and low lift and drift angles.

Evidently aspect ratio corrections will depend upon the effi-

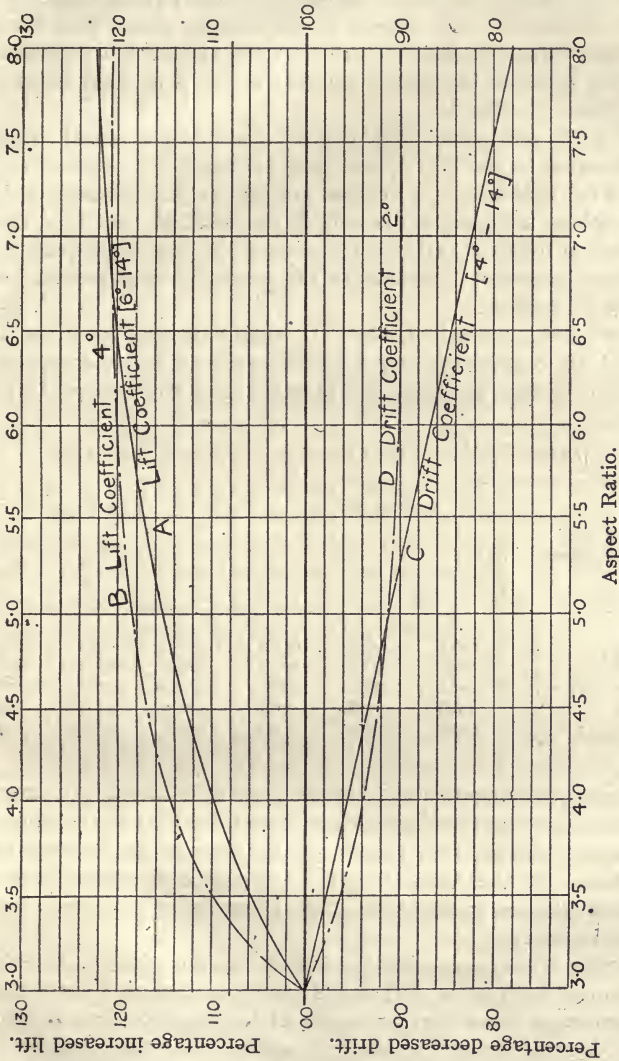

FIG. 22.—CORRECTION CURVES FOR ASPECT RATIO.

ciency of the wing section, being greater as the efficiency increases; also upon the plan-form, being greater for tapered, graded, and washed-out wings.

## EFFECT OF BIPLANE AND TRIPLANE SPACING.

The results of wind-channel tests upon exactly similar aerofoils arranged as in a biplane, but with the line joining their leading edges always at right angles to the chords, shows that there is a disadvantageous interference between the air flows caused by the gap between the planes, unless the gap is at least two and a half times the chord.

In most aeroplanes the gap is, for constructional reasons, made equal to the chord, and tests by the N.P.L. show that for angles of incidence of 4 degrees and above, the lift coefficient of the biplane arrangement is only 80 per cent. of that of a monoplane, the lift/drift ratios being reduced in the same proportion for small angles of incidence, and in greater proportions for larger angles of incidence.

The figures given in Table VIII. enable corrections to be made to the lift coefficients and lift/drift ratios of single aerofoils for different biplane spacings, and is based upon the results of N.P.L. tests.

TABLE VIII.—CORRECTIONS FOR BIPLANE SPACING.\*

Ratio Gap Chord.	Lift Coefficient.			Lift Drift.		
	6°.	8°.	10°.	6°.	8°.	10°.
0·4 .. ..	0·61	0·62	0·63	0·75	0·81	0·84
0·8 .. ..	0·76	0·77	0·78	0·79	0·82	0·86
1·0 .. ..	0·81	0·82	0·82	0·81	0·84	0·87
1·2 .. ..	0·86	0·86	0·87	0·84	0·85	0·88
1·6 .. ..	0·89	0·89	0·90	0·88	0·89	0·91

The best arrangement of biplane spacing is largely a matter for practical consideration, for although both the lift and the efficiency increase as the gap is increased, yet the increase in the weight and resistance of the extra length of struts and cables generally counterbalances these gains after a spacing of gap equal to the chord is reached.

In the triplane system the lift of middle plane is interfered with upon both sides, and of the lower plane upon its upper side. Experiments show that at angles of incidence of from 2 degrees to 12 degrees the lift and lift/drift are less than the corresponding values for the biplane. At angles of about 16 degrees the tri-

\* Single aerofoil coefficients are multiplied by the numbers given for biplane spacing coefficients.

plane has very nearly the same lift, and a rather lower resistance coefficient. The following table shows the Biplane and Triplane Correction Coefficients for the R.A.F. No. 6 wing, with a spacing equal to 1.2 times the chord, and with no stagger.

TABLE IX.

Angle.	Monoplane.		Biplane.		Triplane.	
	Lift.	Lift/Drift. <sup>2</sup>	Lift.	Lift/Drift.	Lift.	Lift/Drift.
0	100	100	88.8	73.2	83.0	70.8
2	100	100	83.8	74.7	75.4	69.8
4	100	100	85.4	82.0	75.7	76.1
8	100	100	85.2	81.9	77.4	80.4
12	100	100	87.6	95.0	81.2	89.0
16	100	100	98.5	124.0	96.4	145.0

### EFFECT OF STAGGERING.

The effect of staggering the top plane forward is to improve the lift coefficient and the lift/drift ratio. When the top plane is staggered forwards through a distance equal to about two-fifths of the chord, the lift and lift/drift are both increased by about 5 per cent. This improvement is equivalent to that which would accrue if the biplane spacing were increased from 1.0 to 1.25 of the chord.

If the top plane be staggered backwards the lift and the lift/drift are reduced, but not by so much as these quantities are increased in staggering the top plane forwards.

If the requirements of design necessitate a backward stagger of the top plane, it can be assumed that the lift and lift/drift will only be slightly affected for moderate degrees of stagger.

It is generally advantageous to stagger forwards for practical reasons connected with the range of vision of the occupants, and also because of the somewhat reduced resistance of the obliquely set struts, although the strengths of inclined struts under vertical load are smaller.

### EFFECT OF DIHEDRAL ANGLE.

The employment of a dihedral angle between the wings for stabilizing purposes for the moderate angles employed in present-day practice—that is, up to 6 degrees—has no detrimental effect upon the lift or lift/drift.

Experiments made with wings in which both positive and negative dihedral angles were given, up to about 7 degrees, have shown that no appreciable difference in either the lift or lift/drift occurs.

### CHAPTER III

## THE CHARACTERISTIC CURVES OF AEROPLANE PERFORMANCES

The wing section is generally chosen to suit the wing loading, speed range, and type of machine.

The wing section having been decided upon, the wing area for the given speed range and load can be obtained from a knowledge of the lift coefficients at different angles of incidence of the section selected, either by direct calculation or more readily by making use of the values given in Table IV.

The engine power must also be sufficient to overcome the total resistance of the whole machine at the two extremes of the speed range, and its total weight with fuel must not cause the total load to exceed the load assumed for the calculated wing area. This, as previously mentioned, is often a case of trial and error in selecting engine types for a given speed range.

### WING RESISTANCE CURVES.

Knowing the lift coefficients required for the load to be supported at the given speeds, the corresponding values of the drift coefficients at these speeds are known from the lift and drift curves for the wing section chosen, and the total wing resistance at the same speeds can be estimated.

Thus, if  $C_L$  be the lift coefficient required to support the load  $W$  pounds at the given velocity  $V$  (in English units) at an angle of incidence  $\theta$  degrees and with a wing area  $A$  square feet,

$$\text{then } W = C_L \cdot \frac{\rho}{g} \cdot A \cdot V^2.$$

If the lift/drift ratio =  $n$  for the incidence  $\theta$  degrees,

$$\text{then } C_D = \frac{C_L}{n} \text{ where } C_D = \text{the absolute drift coefficient.}$$

Then the total wing resistance  $R$ , in pounds, at the given speed  $V$  f.s. is given by

$$R = C_D \cdot \frac{\rho}{g} \cdot A \cdot V^2$$

$$= \frac{C_L}{n} \cdot \frac{1}{424} \cdot A \cdot V^2$$

since  $\frac{\rho}{g} = \frac{1}{424}$ .

This expression assumes that the resistance of a cambered wing varies as the square of the velocity. This is very nearly

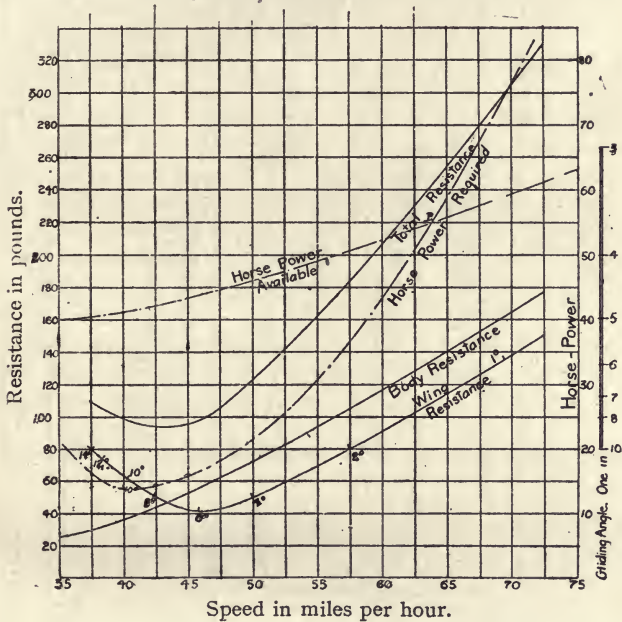

FIG. 23.—CURVES OF PERFORMANCE FOR MONOPLANE.

true for all the normal flying speeds of present practice, but for very high velocities the resistance may vary as  $(V)^n$  where  $n$  is an index greater than 2.

Values of  $R$  can similarly be calculated for all corresponding values of  $C_L$  and  $V$  over the whole range of flying angles of incidence chosen.

The wing resistance at various speeds having been calculated, the curve of wing resistance can be plotted. The general shape of this curve is indicated in Fig. 23, which represents to scale typical monoplane wing resistance and other curves.

BODY RESISTANCE CURVES.

Before the horse-power required to propel the machine at the given speeds can be calculated, it is necessary to know the re-

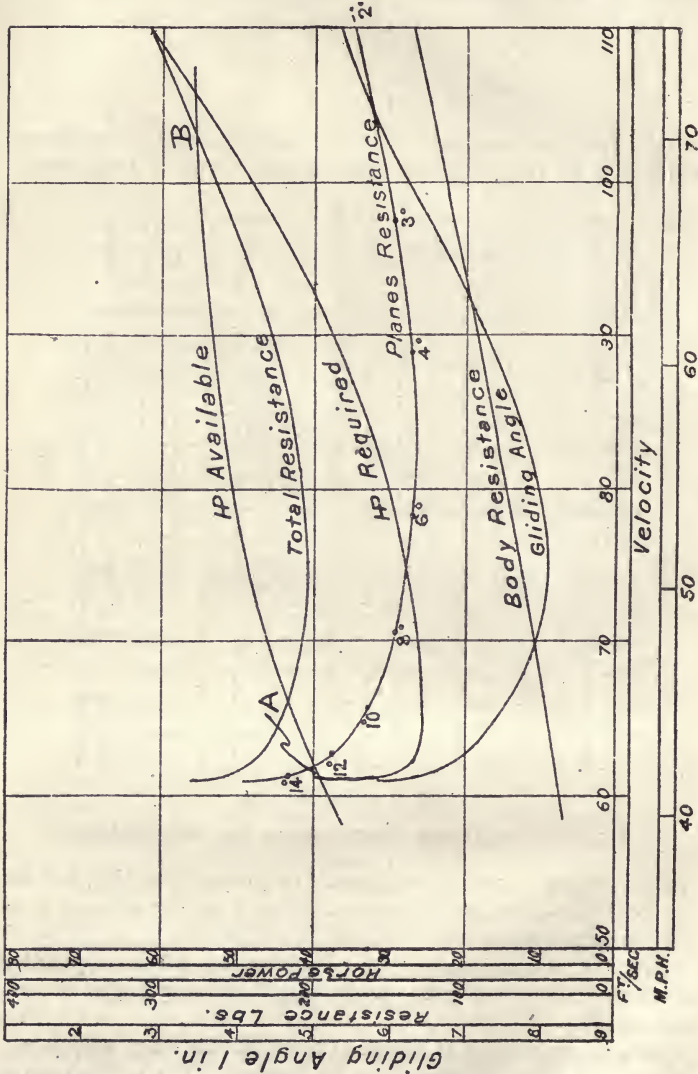

FIG. 24.

sistance of the other parts of the machine exclusive of the wings.

For a fairly accurate estimation it is necessary to calculate the separate resistance of each part of the machine at some given speed.

The experimental data given in another book of this series, entitled "Properties of Wing Sections and Resistance of Bodies," enables the resistance of the important parts of an aeroplane to be computed accurately.

Having found the component resistances at some given speed, the resistance of the whole "body" can be obtained by summation, and as the body resistance follows a law of variation very nearly proportional to  $V^2$  a curve of body resistance with speed can be drawn.

The total resistance of the aeroplane at any speed  $V$  is then the sum of the wing and body resistances. A new curve of "total resistance" can then be plotted by adding the two ordinates of the wing and body resistance curves at each speed.

As an illustration of the method of calculating the total body resistance, values of the component resistances of a monoplane body, chassis, wires, etc., for an actual machine of the Bleriot type are given in Table X., and for a biplane of the B.E. 2 type in Table XI.

Curves of "body resistance" and "total resistance" are given in Fig. 23 for a similar monoplane, and in Fig. 24 for a biplane similar to the B.E.2 considered in Table XI.

TABLE X.—RESISTANCES FOR BLERIOT TYPE MONOPLANE.

No.	Particulars of Parts.	Resistance in Lbs. at 60 M.P.H.
1	Fuselage 20 feet by 2.2 feet square, with exposed area of engine and pilot included ..	41.50
2	Bleriot undercarriage, complete with struts, forks, wheels, shock-absorbers, etc... ..	37.54
3	Pylons and cabane (or masts) .. ..	5.92
4	100 feet of 5 mm. cable .. ..	16.80
5	Rudder and elevator control levers and tail skid .. ..	1.00
6	Skin resistance of control surfaces .. ..	2.00
	Total .. ..	104.76

Note.—Resistance of above at 100 M.P.H. would be 290 pounds.

TABLE XI.—RESISTANCES FOR B.E. 2 BIPLANE.

No.	Part.	Equiv. Normal Area in Sq. Ft.	Value of Section per Cent. of Normal Plane.	Resistance in Lbs. at 60 M.P.H.
1	<i>Struts :</i>			
	Eight 6' × 1½" .. ..	5.00	16.5	4.2
	Four 4' × 1½" .. ..	1.70	16.5	1.4
	Six 3' × 1½" .. ..	1.90	16.5	1.6
2	<i>Wiring :</i>			
	220 feet cable .. ..	3.20	83.0	29.5
	70 feet high-tension wire diameter = 12 S.W.G. ..	0.60	75.0	5.6
	52 strainers .. ..	0.36	75.0	3.0
3	Two wheels, 26" diameter ..	1.50	33.0	3.5
4	Two skids .. ..	0.20	50.0	1.0
5	Axle, 5' × 1½" .. ..	0.63	65.0	2.0
6	Engine and propeller boss ..	2.00	67.0	40.0
7	Fuselage .. ..	5.40	10.0	
8	Exposed pilot and passenger	0.50	48.0	
9	Rudder, 12 square feet ..	—	Skin friction	0.5
10	Elevator, 25 square feet ..	—	Ditto	1.5
11	Skid .. ..	0.25	20	0.5
12	Wing-skids, plates, silencer, etc. .. ..	—	—	10.0
	Total resistance .. ..	..	..	104.3

*Note.*—This biplane has a wing area of 374 sq. ft., an overall length of 29.5 ft., weight of 1,650 lbs. fully loaded, and fitted with a 70-h.p. Renault engine with Tractor propeller. This machine had a speed range of from 39.5 to 73 M.P.H., a climbing rate of about 430 ft. per min., and a gliding angle of 1 in 7.5.

It will be noticed that the method of obtaining the "body resistance" by the process of analysis and summation, is the same as that employed in the estimation of the total load. Similarly, the position of the centre of resistance may be found, as in the case of the centre of gravity.

The body resistance can also be obtained from resistance tests in a wind channel of a model of the complete machine, either by making an allowance for the resistance of the wings from the known wing drift-coefficients and their area, or by supporting the wings separately from the body, but very close to same, and measuring the resistance of the body alone. This method, if it can be employed, is more accurate, as the mutual interference of the air flows for the body and wings is allowed for.

The value of the "body resistance" of the full-sized machine can be independently obtained by subtracting the estimated



resistance of the wings from the estimated or measured propeller thrust at the given speed. This method is usually the more accurate one, for it has been found, from the performances of actual machines, that the estimated "body resistance" is usually higher than the observed, even after due allowance has been made for the increased resistance due to the slip stream of the propeller, which may be taken as being at about 25 to 30 per cent. greater velocity.

In calculating the wing resistance of a biplane, due allowance must be made for the following factors:

1. The interference between the two wings due to "biplane spacing" effect.
2. The stagger of the planes.
3. Aspect ratio of full-sized wings and models.
4. Interference between fuselage, or cabane, or *any other near objects*, and the wings, for in most biplanes the fuselage occupies the centre of the lower wing, and destroys the continuity of the air flow at the most efficient portion. This is a problem which can only be solved by wind tunnel experiment.
5. Scaling-up error from the model to the full-sized machine, if the wing and body characteristics are taken from model test results.
6. Propeller draught and body resistance. The relative velocity of the air to the fuselage or body is increased by as much as 30 per cent. by the propeller slip stream.

Items 3, 4, 5, and 6 are also applicable to monoplanes.

The total resistance of a machine can be obtained, as previously mentioned, by testing a complete model of the machine in a wind channel, if the scale and speed corrections be known.

The larger the model and the nearer the wind-channel velocity to the full-sized velocity, the more accurate will the results be.

It is also essential that the relative roughnesses of the surfaces be proportional, or known, in order that the measured drift values be comparative.

### HORSE-POWER CURVES.

From the total resistance curve the values of the h.p. required to overcome the total resistance at the various speeds can be estimated by the relation—

$$\text{H.P. required} = \frac{R \cdot V}{550},$$

where R = total resistance in pounds at the velocity V feet per second.

The "horse-power required" curve can then be drawn. From a knowledge of the power output of the chosen engine and of the propeller efficiency, the available "horse-power" curve can be plotted. The available h.p. is not easy to obtain with a very near degree of accuracy, since the brake horse power of the engine under flight conditions, and the propeller efficiency at different engine revolutions and air-speeds, cannot be readily and accurately obtained.

If the efficiency of the propeller be represented by  $E$ , and the b.h.p. at the engine speed for which  $E$  is known be denoted by the letters b.h.p.,

$$\text{then available h.p.} = E \times \text{b.h.p.}$$

The efficiency  $E$  of an air propeller varies from 60 per cent. to 80 per cent. The average value for a well-designed propeller may be taken at from 70 per cent. to 75 per cent.

The h.p. available curve can be approximately estimated; an example is shown in Figs. 23 and 24. The curves of h.p. required and h.p. available are only strictly true at one altitude, the effect of an increase in altitude being twofold—namely, to decrease the available h.p. and to increase the h.p. required, due to the effect of the air-density decrease causing a decrease in the lift of the wings, and therefore requiring an increased speed.

A difference in height of 10,000 feet will cause a difference of about 25 per cent. in the engine power.

It will be seen from the curves Figs. 23 and 24 that the "h.p. required" and the h.p. available curves cut in points A and B. The abscissæ of these points fix the minimum and maximum speeds of the machines respectively. In the case of the biplane these are 42.5 and 70 miles per hour respectively.

### RATE OF CLIMBING.

The vertical ordinates intercepted between the two h.p. curves represent the available h.p. for climbing and manœuvring.

In Fig. 24, the maximum available or surplus h.p. is 21, and occurs at 50 miles per hour.

The maximum rate of climbing is then obtained from the relation—

$$V_R \text{ (in feet per minute)} = \frac{\text{H.P.} \times 33,000}{W}$$

where H.P. is the greatest intercept between the h.p. required and h.p. available curves (expressed in horse-power), and  $W$  = weight in pounds of fully loaded machine. In the biplane

considered,  $W = 1,500$  pounds, and the climbing rate is therefore 450 feet per minute.

The rate of climbing is an important factor in aeroplane design. Certain types of machine require high climbing rates, whilst with other types it is a secondary factor.

In fighting types of machine it is considered desirable by some authorities to aim at very high climbing rates, in preference to high maximum speeds in the horizontal plane, as it is held that a machine can then outclimb its opponent and, conversely, having reached a high altitude, can dive down at very much higher speeds than could be obtained by horizontal flight.

It is not only necessary to be able to climb at a certain rate, but also to maintain this mean rate over a specified vertical distance, say 10,000 feet, since it is evident that the actual rate will diminish with increase in altitude. It is therefore now usual to specify a certain average rate of climb for 10,000 feet or more.

The angle of climb is an important factor, since it measures the ability of a machine to arise out of a restricted area, such as a small meadow fringed with trees.

The climbing rates attained in aeroplane practice vary from 300 feet per minute to as much as 1,200 feet per minute at ground level, a good value for a well-designed machine of moderate h.p. and speed being 400 to 500 feet per minute. Some values for the climbing rates measured in the case of the

TABLE XII.—CLIMBING SPEEDS OF AEROPLANES.

<i>Type of Machine.</i>	<i>Rate of Climb in Feet per Minute.</i>	<i>Percentage of Total H.P. employed in Climbing.</i>
Hanriot I. . . . .	365	26.5
Hanriot II. . . . .	333	24.0
Bleriot tandem . . . . .	250	17.7
Bleriot sociale . . . . .	236	16.6
Avro . . . . .	105	8.6
Bristol Monoplane. . . . .	200	14.9
Deperdussin . . . . .	267	20.6
Maurice Farman . . . . .	207	16.8
B.E. Improved, 1913 . . . . .	400-450	40.0*
R.A.F. Scout, B.S. I . . . . .	900	50.0*
	(at 65 M.P.H.)	
R.A.F. Reconnaissance Type, R.E. I . . . . .	600	40.0*
R.A.F. Fighting Type, F.E. 3 . . . . .	350	40.0*

\* Values assumed from characteristic curves.

machines entered for the Military Competition of 1912 are given in Table XII., together with values for the later R.A.F. machines; the rate of climb for the scout type of these latter machines is well defined.

The lowest point of the curve of h.p. required gives the most economical speed of the machine, which in the case of the example illustrated is 44 miles per hour.

The effect of running the engine at full power, when an aeroplane is flying horizontally and at a given incidence, is to cause the machine to climb at such a rate that the surplus h.p. is absorbed.

Thus if  $H_0$  = h.p. required for horizontal flight at  $V$  feet per second,

$W$  = weight of machine in pounds,

$\theta$  = angle of slope or climb,

then b.h.p. at propeller at full throttle =  $H_0 + \frac{V \cdot W \sin \theta}{550}$ ,

so that the climbing angle  $\theta$  is governed by the power output of the engine. This angle may be varied, however, by introducing an artificial wind resistance, so as to vary  $H_0$ .

In both cases of the rate of climb and angle, it will be found that the best results are obtained by having as large a percentage surplus h.p. as possible, and as high a lift/drift ratio for the whole machine as possible at the best climbing speed.

The climbing rate progressively falls off as the altitude is increased, due to the engine h.p. falling off, and to aerodynamic causes.

## THE GLIDING ANGLE.

From the curves given in Figs. 23 and 24 the gliding angles at the different speeds can be readily obtained and plotted. For if  $R$  be the total resistance in pounds at a given speed  $V$ , and  $W$  is the weight of the machine in flying order, then the gliding angle at the speed  $V$  is given by  $\sin a = \frac{R}{W}$ , where  $a$  is the angle made by the direction of the "glide" with the horizontal. In other words, when the machine is gliding freely, and with the engine stopped, the gravity component  $W \sin a$  in the direction of flight must be equal to the head resistance.

Hence the curve of "total resistance" is also a curve of corresponding gliding angles to a different scale—that is, the ordinates, divided by  $W$ , give the sines of the gliding angles.

A gliding angle of  $\sin^{-1} \frac{1}{6}$  is usually expressed as 1 in 6—that is to say, the machine will drop 1 foot vertically for every 6 feet glided.

It will be seen that the flattest gliding angle occurs at the speed where the total resistance ordinate is a minimum. This angle is often termed the "gliding angle par excellence." The smaller this latter angle, the greater is the available area for landing from a given height, should engine failure occur—a desirable attribute in modern aeroplanes. The real gliding angles attained in practice vary from about 1 in 5 to 1 in 8 in the best examples.

Table XIII. gives the measured gliding angles of the aeroplanes entered for the Military Competition in 1912, and for the improved B.E. machines.

TABLE XIII.—GLIDING ANGLES AND SPEEDS.

<i>Type of Machine.</i>	<i>Gliding Angle, One in — n.</i>	<i>Gliding Speed, M.P.H.</i>	<i>Gliding Resistance <math>\frac{W}{n}</math> Lbs.</i>
Hanriot .. .. .	6.6	61	291
Hanriot .. .. .	5.9	68	332
Bleriot tandem .. .. .	5.6	—	267
Bleriot sociable .. .. .	5.3	52	280
Avro .. .. .	6.5	—	270
Bristol Mon. .. .. .	6.5	64	284
Deperdussin .. .. .	6.2	—	328
Maurice Farman .. .. .	6.8	38	284
Cody .. .. .	6.2	60	432
B.E. (improved) biplane, 1913	7.4	50	224

The gliding angles attained in practice are generally greater than the theoretical, on account of the propeller effect in increasing the total resistance during gliding and wind effects.

With a favourable up-wind small gliding angles up to 1 in 9 can be obtained for short periods. The above considerations refer, of course, to calm air conditions.

**EFFECT OF ALTITUDE UPON PERFORMANCE.**

Both the climbing rate and the maximum speed of an aeroplane progressively fall off with increased altitude; one reason for this is that the h.p. varies almost in proportion to the air density, which at 5,000, 10,000, 15,000, and 20,000 feet, is only 87.4, 74.0, 63.0, and 53.3 per cent. respectively of the density at sea-level.

For a modern two-seater biplane of about 250 h.p., the respective speeds at ground-level, 5,000, 10,000, and 15,000 feet, will be about 115, 109, 100, and 90 M.P.H. respectively, and the corresponding climbing rates 800, 510, 300, and 120 feet per minute respectively, the "ceiling" being about 17,000 to 18,000 feet.

## CHAPTER IV

# PRINCIPLES OF CONSTRUCTION OF THE WING SYSTEM

### SYSTEMS OF BIPLANE BRACING.

Examples of some typical methods of bracing the wings of biplanes are given in Fig. 25.

It will be noticed that all of these agree in using a combination of struts and diagonal bracing wires or cables; but that where the upper wing overhangs the last strut by a comparatively large amount, an inclined tie-strut member is employed, as in *A*, which represents the system employed on the D.F.W. biplane and the Farman machines. In some cases an additional king-post is fitted above the last strut, and a series of inclined lift and top load wires take the lift and the top load of the overhung portion, as shown in diagram *F*, which represents the Farman seaplane system.

In cases of a small overhang of from one-half to three-quarters of the chord, it is sufficient to make the overhung portion of the spars strong enough as a cantilever, or to add an additional lift cable, as shown in diagrams *C* and *E*, which are typical of many existing biplane systems.

Diagrams *B* and *F* represent the bracing methods employed for the large spans of flying boats, heavy biplanes, etc., whilst *D* indicates a typical method of bracing light biplane scouts. Here only one interplane strut pair is fitted to each half of the wing, the span being small.

### WING FORMS.

The plan forms of aeroplane wings vary considerably in shape, sometimes for constructional reasons, in other cases for stability purposes, as in the Etrich Taube, Dunne, and other machines, and in many cases apparently for appearance' sake, but in few cases for reasons connected with the aerodynamic efficiency.

Most successful machines agree in having an aspect ratio of

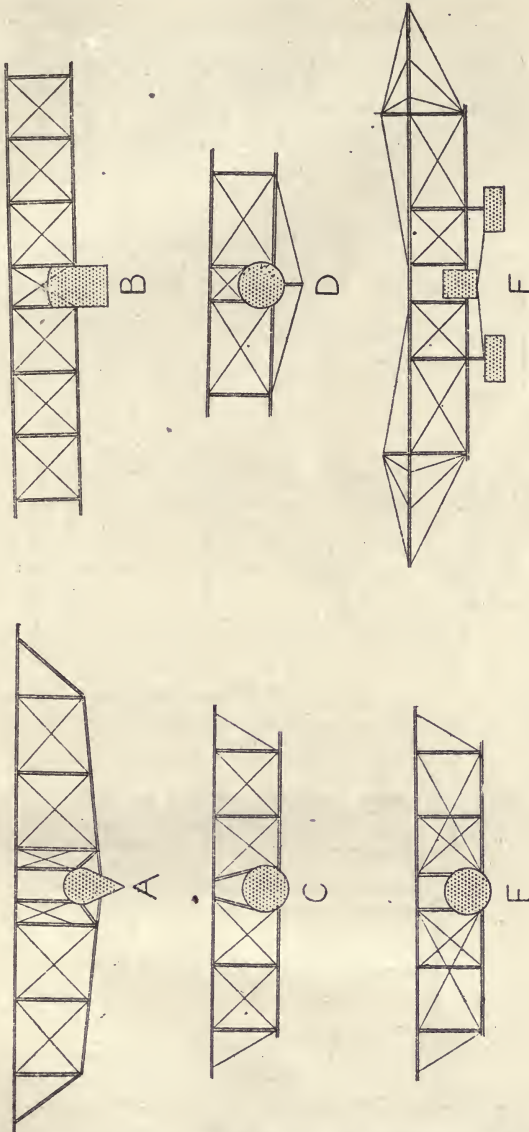

FIG. 25.—DIAGRAMS OF TYPICAL BIPLANE BRACING SYSTEMS.

about 6 or over, except in cases of light scouts, which sacrifice span dimensions for other reasons. The chief differences existing between plan forms of aeroplane wings lie in the shapes of the wing tips and aileron design.

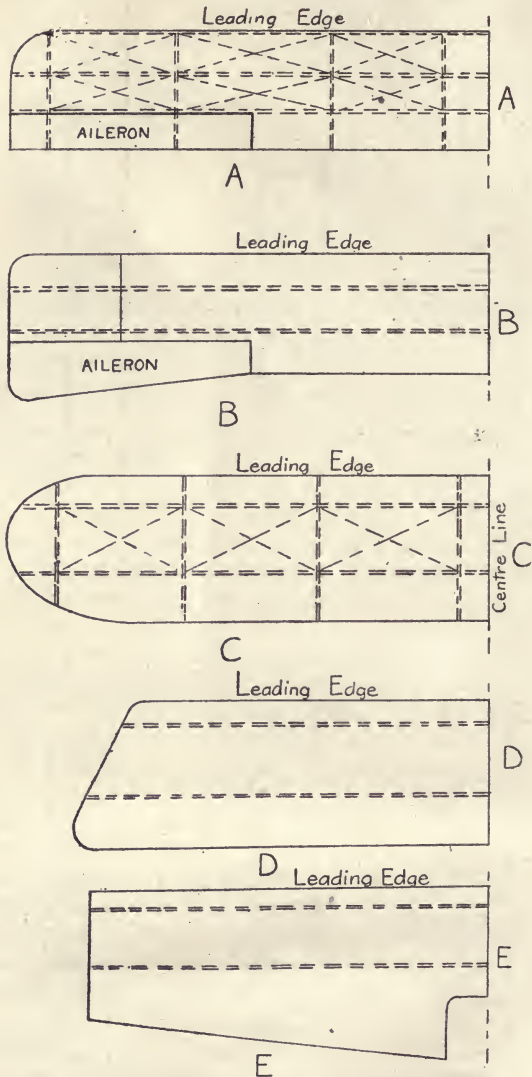

FIG. 26.—SOME TYPICAL WING PLAN FORMS.

The outline diagrams shown in Fig. 26 illustrate a few of the typical wing plan forms of present practice. The diagrams also show the positions along the chord of the wing spars, and in one or two cases the drift bracing system. The wings illustrated in



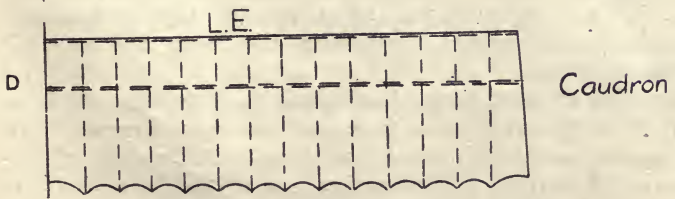
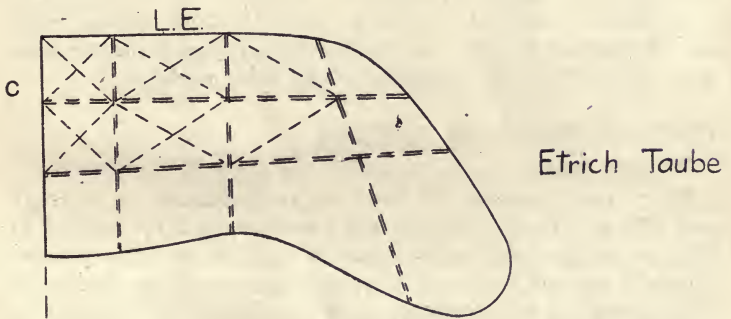
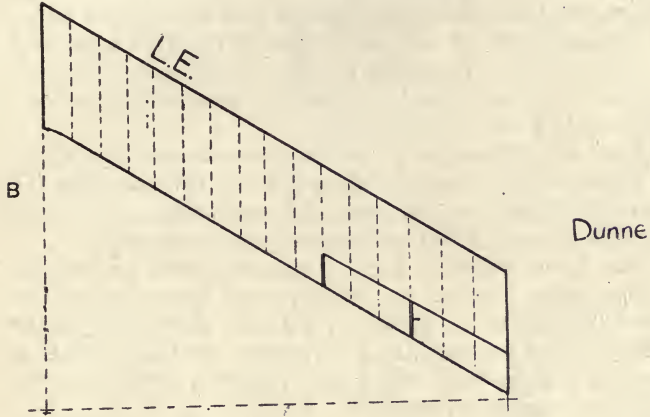
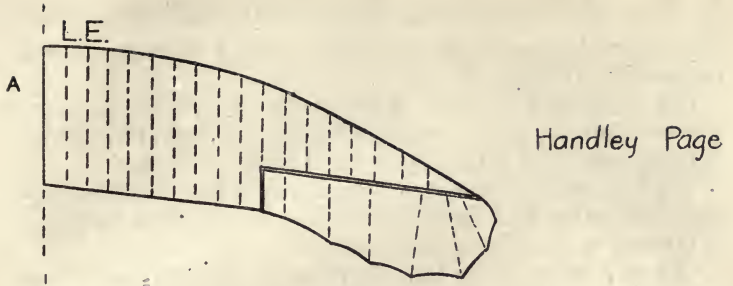

FIG. 27.—SPECIAL TYPES OF WINGS.

this system belong to the rigid type, except in so far as they require to be warped.

The simplest plan form, much evident in earlier machines, was the plain rectangle. Modern tendency is, however, towards rounded wing tips, with parallel chord along the span.

The B.E. type, as shown in Diagram *C*, is used in many other machines, either with the major portion of the curve behind, or in front as in the Bleriot, Sopwith, etc.

The plan shape given in *D* is typical of the Morane-Saulnier monoplane, and Eiffel has shown that this plan form gives a rather higher lift coefficient for the same value of the drift coefficient than the rectangular or rounded forms. The increase in the lift to drift ratio is most marked between 8 degrees and 12 degrees, and amounts to from 4 to 8 per cent.

This type of wing plan is no doubt more efficient on account of the more gradual pressure grading towards the tips, with the consequent diminution in end-losses. A combination of *D* and *E* would probably show a still better aerodynamic efficiency.

The plan forms shown in Fig. 27 represent some exceptional wing plan forms, adopted for stability and control purposes. The chief features of *A*, *B*, and *C*, are that the wing tips are negatively warped for stabilizing purposes. In *A* and *C* this is obtained by warping the trailing edge upwards, whilst in *B* the leading edge is warped downwards.

Diagram *D* illustrates a wing with a flexible trailing edge, also for stability purposes, in which the front edge forms one wing spar; this is also a feature of one or two other machines.

## TYPES OF WING SPAR SECTIONS.

### 1. Wooden Spars.

Wing spars designed to fulfil the requirements of strength may take a variety of shapes and forms, and a large number of different sections are to be found in practice, but this is more especially marked in the machines of a year or two ago than now.

Some typical spar sections are shown in Fig. 28, illustrating different methods of construction.

The spars are usually made of ash, spruce, or poplar, and are made hollow about the neutral axis of the "lift" bending moment, but are left solid where the compression ribs, struts, and external bracing are fixed.

The most common form of section is the I section, which is generally shaped at its outer flange surfaces to conform with the wing section, and is hollowed out as shown in *A* (Fig. 28).

To avoid warping and distortion, spars have been made in

separate portions, as shown in *B*. The grains of the component pieces are sometimes set at angles with each other, and are glued and screwed (or clamped) together.

Another method, in which economy of weight is aimed at, is shown in *C* and *D*, the vertical webs being made of 3-ply in the former example, which has been employed in the Martinsyde machines.

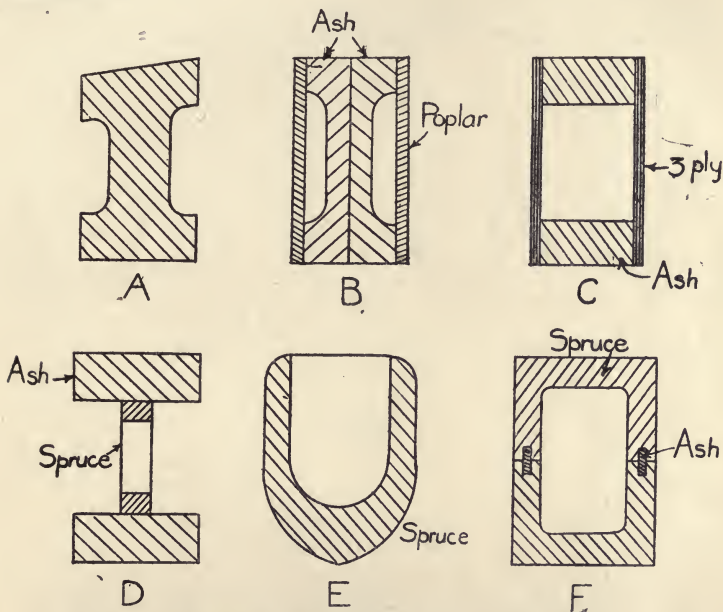

FIG. 28.—EXAMPLES OF WOODEN WING SPAR SECTIONS.

In certain machines, such as the Farman and Nieuport, the leading edge itself forms the front spar, and is shaped (in the former case) as shown in *E*. Needless to remark, in this type the rear spar must be situated well back, in order to withstand the increased stresses due to the backward travel of the C.P. when the angle of incidence decreases; occasionally, however, three spars are employed.

Wing spars are sometimes built up somewhat upon the principle of hollow struts, as shown in *F*, which represents the back spar of a wing of the type in which the front spar is formed by the leading edge.

Armoured wooden spars have been employed in which the greater part of the stresses has been taken by a steel strip (or

strips) set with the depth vertical, as in *G* (Fig. 29), the wooden sides being riveted and bound to the steel, thus giving sufficient rigidity to prevent buckling. Such a spar was fitted to the Caudron machine. In some instances steel tubes of appropriate section have been filled with ash for the wing spars.

## 2. Steel Spars.

The modern tendency in aeronautical practice is towards the elimination of such materials as wood, as the strength of this

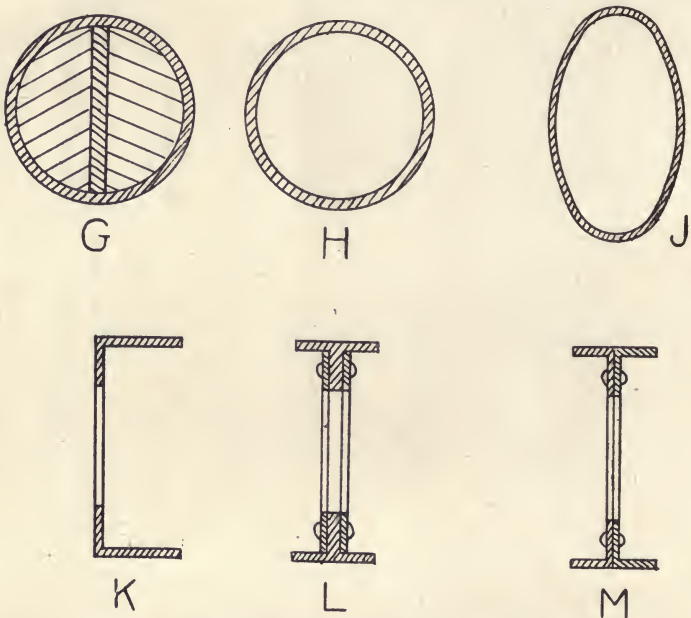

FIG. 29.—EXAMPLES OF METAL WING SPAR SECTIONS.

material depends upon its previous history and subsequent treatment, and is always an unreliable factor. For this purpose steel, and other metals, is replacing these non-homogeneous materials, and successful all-metal wings (and indeed complete machines) have been built.

It is necessary when designing for metals to dispose the material in the best possible way so that the actual weight is a minimum, as one of the reasons for their non-adoption has been on account of their weight as compared with wood.

The introduction of high tensile alloy steels, modern welding and fusion methods, and the more accurate calculation of the

strengths of the parts, may result in the gradual elimination of wooden spars.

The disadvantages of the metal spar as employed up to the present time are, firstly, its rather higher weight; secondly, that in a built-up spar it is difficult to ensure that the union between the component parts will be as strong as the components themselves; and thirdly, that of the protection of the surface of the metal against rust and corrosion. This latter objection has already been largely overcome with the introduction of high tensile non-rusting steels.

Examples of some of the metal spar sections which have been employed are shown in Fig. 29.

Round and elliptic steel tubes have been employed for wing spars, notably in the Breguet machine. For maximum economy of weight, these spars should be tapered in length, or diminished in thickness of section towards the wing tips.

In the Clement-Bayard machine, channel steel section, considerably lightened out in the webs, has been successfully employed for the wing spars (see Fig. 32).

The steel spar, built as a pressing upon this plan, possesses advantages as regards its time of construction, uniformity, and for repetition work.

## WING CONSTRUCTION.

The wing is designed to fulfil several objects. Firstly, it must be constructed to give the correct shapes or sections at all places along the span; secondly, it must suitably house the main wing spars and allow means for their external bracing; thirdly, it must accommodate the lateral control, whether aileron or warp.

The majority of aeroplane wings are now built upon one system, which can be best understood by reference to the wing plan in Fig. 26, C. The two wing spars pass through all the sections, and are internally diagonally braced against drift forces. Suitably shaped ribs are provided at intervals of from 10 to 14 inches to give the fabric its correct profile when stretched over the whole wing framework. These ribs are divided up into two classes: the stronger ribs, to which the drift bracing is attached, are termed "compression ribs," whilst the lighter skeleton ribs, which chiefly serve to give the wing its proper section or shape, are known as "former ribs."

The construction of these ribs is illustrated in Figs. 30 and 31.

Diagram A shows one of the simplest methods of constructing the former ribs, and their attachment to the longitudinal mem-

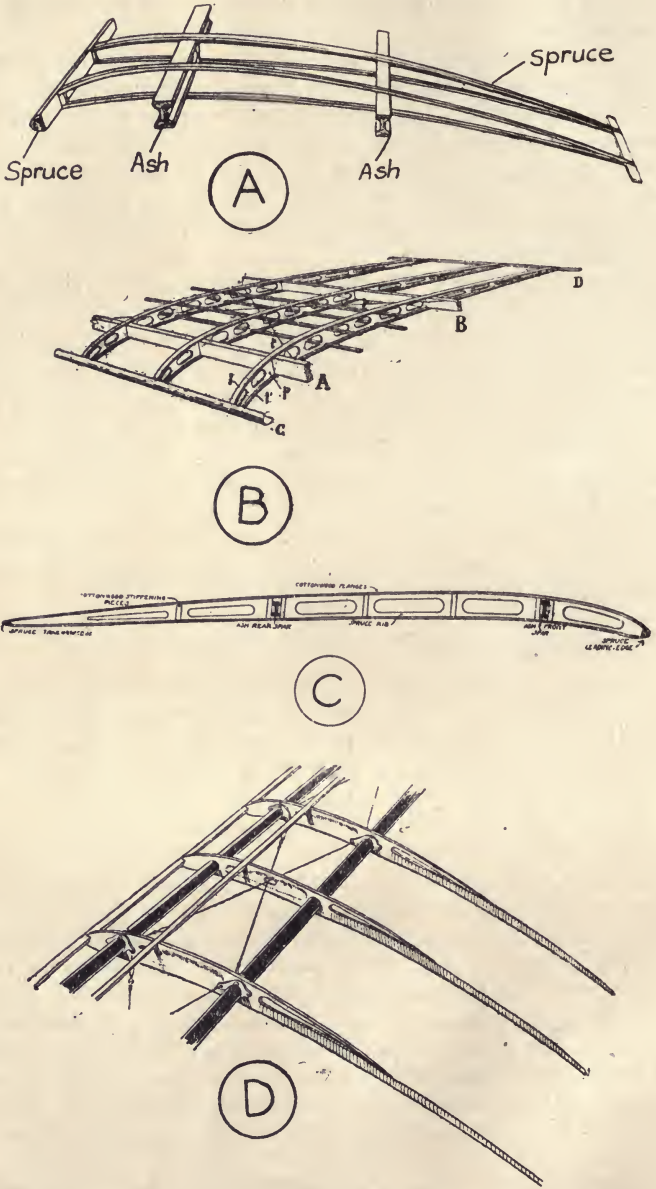

FIG. 30.—METHODS OF CONSTRUCTION OF AEROPLANE WINGS.

bers. They are here composed of either spruce or cotton wood, both being very light material<sup>s</sup>, whilst the leading and trailing edges are of spruce, the main spars being of ash I beam sections.

Diagram *B* shows a perspective view of a portion of the wing structure, with several former ribs in position. In this case the leading edge is composed of an aluminium cup-section bar, whilst the main spars are rectangular in section.

The thin, flat, longitudinal rods *S* are termed "stringers," and their function is to preserve the shape of the wing between the main spars—that is, to prevent excessive sag in the fabric.

Diagram *C* illustrates a method of constructing a compression rib, details of the materials used being given.

### FLEXIBLE WINGS.

In certain types of wing designed for stability purposes, the trailing edge is made flexible. Usually, as in the case of a bird's wing, the trailing portion of the wing offers little resistance to top loading, but is rigid as regards the normal flying loadings.

The Caudron wing is made flexible in the manner shown in *D* (Fig. 30) by splitting the trailing portion of the wing ribs.

In the Taube wings, and in certain experimental machines, bamboo ribs of rectangular section are employed for flexibility. These are made either of solid round cane of about  $\frac{1}{2}$  inch diameter, or of portions of split tubular bamboo of from  $2\frac{1}{2}$  to  $3\frac{1}{2}$  inches outside diameter, the rectangular sections thus obtained measuring about  $1\frac{1}{4}$  inches by  $\frac{1}{4}$  inch.

Steel wire, in conjunction with an upper and lower rib flange, is employed in the D.F.W. flexible wings.

The materials more commonly employed for the wing construction are birch or ash three-ply, or spruce, for the vertical webs of the ribs, spruce, poplar, white pine or cottonwood for the flanges, and spruce for the leading and trailing edges, although metal is more commonly employed here; generally ash or an ash-spruce combination for the main spars is employed.

In some machines, notably the Caudron and Farman machines, the leading edge itself forms the front spar, and is then made considerably stiffer.\*

### STEEL CONSTRUCTIONS.

Several machines have been fitted with wings constructed entirely of metal, which, whilst usually weighing appreciably

\* Full information of these, and other materials used in aeroplane construction, is given in the volume of this series, entitled "Aircraft and Automobile Materials."

more than the wooden constructions, have possessed the advantages of greater strength, homogeneity, and in some cases standardization possibilities.

Some successful wings have been constructed almost entirely of metal tubes welded together, the leading edge being made of about 10 millimetres diameter tubing, whilst the trailing edge was somewhat smaller, the metal thickness being about 22 S.W.G.

The main spars have been made of round tubing of from 30 millimetres to 60 millimetres diameter, and from 20 S.W.G. to 16 S.W.G. in thickness.

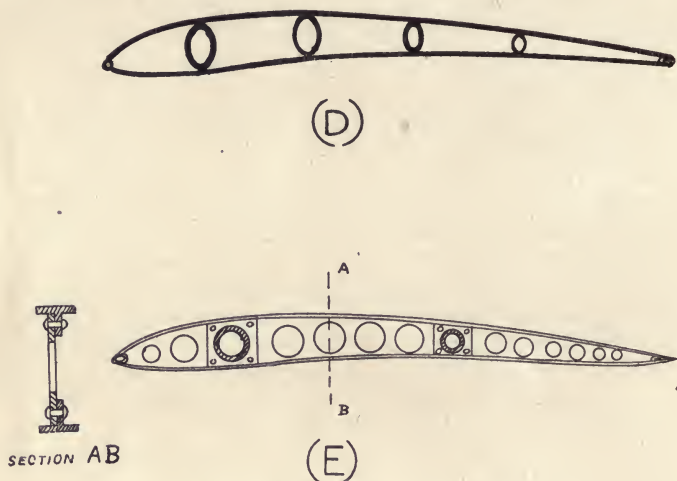

FIG. 31.—EXAMPLES OF STEEL WING CONSTRUCTION.

In order to preserve the shape of the section, short pieces of elliptical tubing were welded between the outside pieces, as shown in *D* (Fig. 31); the limit to the thickness of tubing allowable is fixed by welding considerations, 20 S.W.G. being about the smallest workable width.

One interesting French method of constructing metal wings is shown in *E* (Fig. 31). The spars in this case are of steel tubes; the flanges of the ribs are made of T-section aluminium riveted to the thin steel webs, which are themselves lightened out.

The Clement-Bayard wing construction consists almost entirely of metal, the leading and trailing edges (Fig. 32) being of thin V-section steel, whilst the spars themselves are of channel steel, lightened out around the neutral axis of bending, and are made somewhat thin for flexibility reasons connected with the warping.



The ribs themselves are of wood, whilst the stringers are of very thin flat steel strip.

Another method applicable to the construction of the ribs themselves, especially where reproduction in quantities is important, is to stamp these out of thin steel or aluminium alloy,

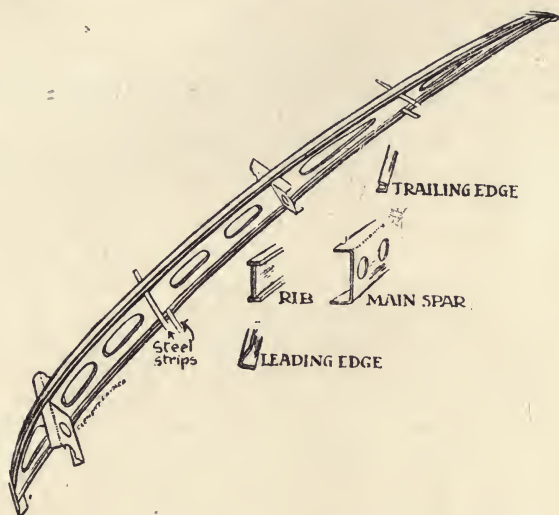

FIG. 32.—THE STEEL CONSTRUCTION OF THE CLEMENT-BAYARD WING.\*

such as duralumin, the section being channel and the webs suitably lightened. Lugs can be stamped, or afterwards bent, for affixing the ribs to the spars.

It should be mentioned that even in wing constructions, consisting almost entirely of wood, metal can be employed with advantage. Thus the leading edge can be made of a C-sectioned aluminium bar, and the trailing edge of very light gauge streamline tubing (usually about  $\frac{3}{4}$  inch major axis,  $\frac{1}{4}$  inch minor axis, and 22 S.W.G. thickness in steel). The ribs are attached to these metal parts by means of light tinned steel straps, held by one or two wood screws to the ribs themselves.

The advent of nickel chrome and other high tensile steels in the form of tubes of various sections, channels, and other parts, has increased the possibilities of all metal constructions for aeroplanes.

\* *Flight* copyright.

## CHAPTER V

### PRINCIPLES OF UNDERCARRIAGE DESIGN

The designer should be well acquainted with the actual conditions of rolling and landing, in order to successfully design the undercarriage.

The pilot always endeavours to bring his machine down with its head to the wind, so that its speed relative to the earth is a minimum. It is generally better to glide down at a somewhat greater angle than the natural one, in order to render the controls more sensitive, and for stability reasons. When the machine nears the ground, the tail is gradually brought down in order to increase the angle of incidence to the maximum lift region, until the machine is flying at its minimum speed and gradually drops until the wheels touch earth. The provision of a mechanical brake is of great assistance in bringing the machine to a standstill after alighting; but air-brakes, which depend for their action upon the speed of the machine, are of little use in this respect.

#### MECHANICAL PRINCIPLES INVOLVED.

When an aeroplane is gliding downwards at an angle  $a$ , it will have a kinetic energy in the direction of flight given by

$$\text{K.E.} = \frac{W \cdot V^2}{2 \cdot g} \text{ foot-pounds,}$$

where  $W$  = the total weight of machine in pounds,  
 $V$  = its velocity in feet per second,  
 $g = 32 \cdot 18$ .

In the landing operation (Fig. 33), the vertical component  $F$  of this energy must be overcome by the springing device of the undercarriage, whilst the horizontal component  $H$  is expended in overcoming the rolling and wind resistances.

In order to absorb the vertical component the springing devices (and the tyres) must deflect vertically through a certain distance. The greater this distance the less the mean force acting upon the springing device.

In practice the vertical movement varies from about 4 inches

with elastic devices up to 12 inches with pneumatic and hydraulic shock absorbers.

If  $d$  = vertical movement of springing device, and  $F$  = mean force acting through springing device, then approximately\*

$$F \cdot d = \frac{W \cdot V^2}{2g} \sin^2 \alpha$$

in the case of a bad landing without flattening out.

To take a concrete example, consider a machine of 1,500 pounds weight with a gliding angle of 1 in 6 to alight at 45 miles per hour at its gliding angle, and further assume that the shock absorbers allow a 6-inch vertical movement, it will be found that the average force acting through the springing will be

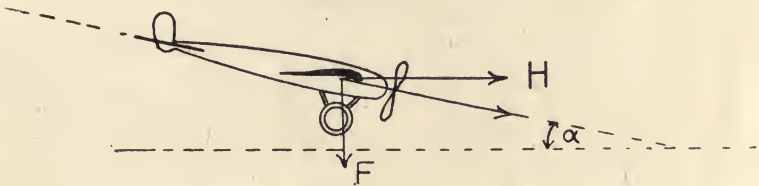

FIG. 33.—THE DYNAMIC FORCES IN ALIGHTING.

5,670 pounds, or about three and three-quarter times the weight of the machine; further, if the machine lands upon one wheel, the conditions will be worse.

It is doubtful whether a landing chassis of aeroplane practice would survive such a mean force. The maximum force acting would be much greater than the mean, so that the conditions are even worse than assumed.

In practice it is the object of the pilot to reduce the vertical component of the machine's velocity to a minimum by flattening out as close to the ground as possible.

The undercarriage should be designed to withstand the shock due to a vertical drop of from 12 to 18 inches of the whole machine. In this case the expression for the mean force acting becomes

$$F = [1.0 \text{ to } 1.5] \frac{W}{d},$$

where  $d$  is the deflection in feet of the springing device and  $W$  the total load, as before.

It should be noted that the stresses in the wings, struts, and

\* More accurately  $F \cdot d = \frac{W \cdot V^2}{2g} \sin^2 \alpha + W \cdot d$ , which includes the effect of the work done by the weight during the yielding of the springs.

bracings may easily be from two to three times the stresses due to the weights of these parts when the machine is at rest on the ground.

Dealing next with the static forces affecting the stability or equilibrium of the machine during landing, it will be seen that when a machine touches the ground in alighting it is subjected to the forces shown in Fig. 34—namely:

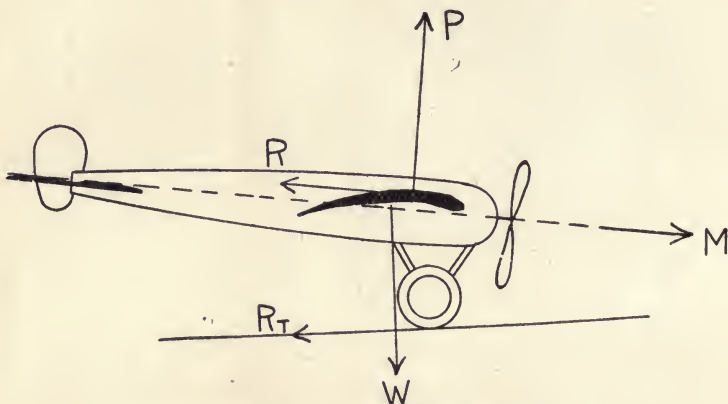

FIG. 34.—THE STATIC FORCES IN ALIGHTING.

1. Its weight  $W$  acting through the C.G.
2. The lift  $P$  due to its forward velocity [this during the landing operation falls off rapidly].
3. The force  $M_F$ , due to the momentum  $M$ , depending upon its weight and velocity, which may be considerable in magnitude, but which will depend upon the rate at which this momentum changes; this acts through the C.G.
4. The tractive resistance  $R_T$ , at the point of contact with the ground, where  $R_T = \mu[W - P]$ , the coefficient of rolling friction  $\mu$  varying with the nature of the ground. Usually for grassy ground, such as found in aerodromes, the resistance may be taken at 80 to 120 pounds per ton.
5. The head resistance  $R$ .

The engine is assumed to be switched off in these considerations. If running it will introduce an additional force  $T$  at the propeller.

The momentum force brings into play a couple  $M \cdot d$  (where  $d$  is the perpendicular distance of  $M$  from the point of wheel contact) tending to overturn the machine, whilst the lift force  $P$  also produces an upsetting moment.

If the C.G. of the machine is behind the point of contact of the wheel and ground, a righting couple is brought into play; the head resistance couple also tends to right the machine.

Calling  $x_w$ ,  $x_p$ ,  $x_m$ ,  $x_r$ , and  $d$ , the perpendicular distances of the lines of action of the forces  $W$ ,  $P$ ,  $M_F$ ,  $R$ , and  $R_T$ , respectively, from the wheel centre, the condition for equilibrium during alighting is that  $[W \cdot x_w + R \cdot x_r]$  shall be greater than  $[P \cdot x_p + M_F \cdot x_m + R_T \cdot d]$ .

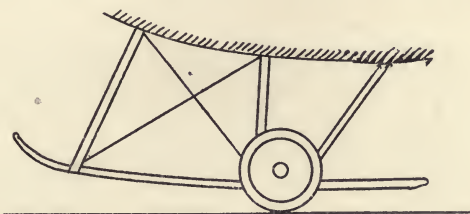

FIG. 35.—TYPES OF UNDERCARRIAGE.

### GENERAL DESIGN PRINCIPLES OF UNDERCARRIAGES.

In undercarriage design the position of the C.G. is usually chosen so that it lies behind the point of contact of the wheel and ground when the machine is flying at its greatest angle of incidence (the distance being from 1 foot to 2 feet in most cases), otherwise a forward skid is provided, and the wheels are placed very nearly at the C.G., as shown in Fig. 35, to prevent overturning.

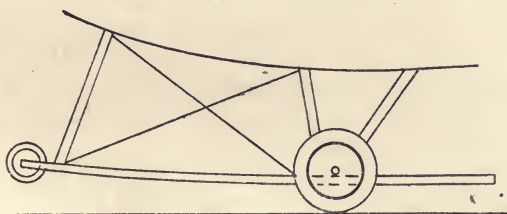

FIG. 36.—TYPES OF UNDERCARRIAGE.

This type of landing chassis sometimes takes the form of a forward skid provided with a single or pair of smaller diameter wheels at its extremity, as shown in Figs. 36 and 37, suitably strutted and braced. The skid itself is sprung or flexibly connected to the transverse member, and is often extended sufficiently rearwards to act as a tail skid, so that no additional skid or support is required at the tail extremity.

In practically all existing designs of undercarriage the C.G. is placed very near to the centre of wheels when the machine is horizontal, and some form of rear support, either as a light tail skid, or an extension of the main skid, as indicated in Figs. 35 and 36, known as a "kangaroo" skid, is provided.

The nearer the C.G. to the wheel centre, the greater the proportion of weight taken by the main wheels, and the lighter the tail skid may be designed.

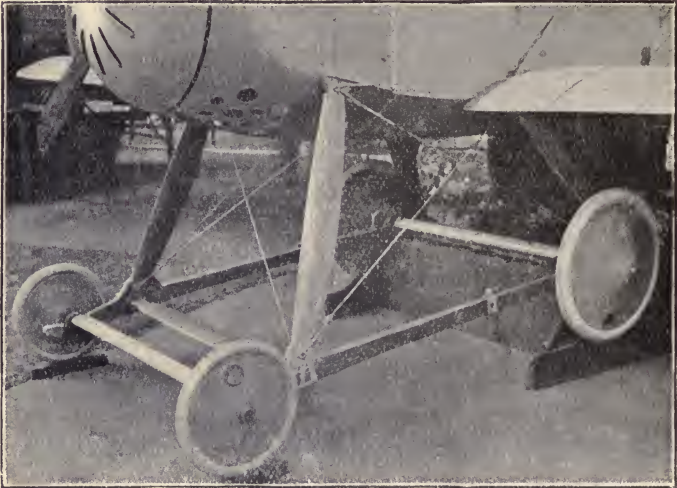

FIG. 37.—TYPES OF UNDERCARRIAGE.

The proportion of the total weight carried by the tail skid in present practice is from 4 to 10 per cent., according to the position of the C.G. relative to the wheels.

The proportion of weight carried by the tail skid, when the machine is running over the ground, depends upon whether the machine has a carrying or a non-carrying tail, being smaller in the former case, and incidentally enabling a much lighter fuselage tail end construction.

If the C.G. is too far behind the wheel centres, the tail will tend to drop during alighting, thus increasing the incidence and causing an increase in the lift, so that the machine "rebounds" several times in coming to rest. Further, the weight upon the tail skid is excessive, and the frictional resistance prevents rapid acceleration when starting off.

The undercarriage should be designed so that when the machine

is at rest, prior to starting, the angle of incidence of the planes is from 12 to 20 degrees, in order to provide for rapid rising.

The height of the undercarriage is dependent upon the propeller diameter, as sufficient ground clearance (from 12 to 24 inches) must be given under all conditions, whether the machine is tilted, or whether the wheels sink in a ground depression when the machine is running over the ground. Tractor machines can be designed with lower undercarriages than pushed machines on account of the propeller clearances being less at alighting angles.

It will generally be found that monoplanes require a somewhat higher undercarriage than biplanes.

When considering landing conditions, the effect of the wheels sinking in soft earth or sand should be remembered.

### GENERAL REQUIREMENTS FOR UNDERCARRIAGES.

The undercarriage must be designed to suit the following enumerated conditions:

1. It must allow the machine to start and to stop in the quickest possible time consistent with comfort and safety. For this reason the resistance to rolling and sliding of the parts must be minimized. Some form of efficient brake should be fitted.
2. It must be well sprung in order to eliminate both forward and side shocks.
3. It must give both lateral and longitudinal stability whilst travelling over the ground (preferably without the addition of wing-tip skids or wheels).
4. It must be capable of withstanding rolling and side-shocks without serious deflection or fracture. The effects of landing in side winds or upon uneven ground may cause serious side stresses.
5. It must enable the machine to rise off soft ground or "plough." Usually this is a question of sufficient wheel diameter and width.
6. The head resistance must be as low as possible, and the chassis weight as low as possible consistent with safety.
7. It should enable the machine to be steered on the ground without the aid of the propeller blast upon the rudder.

In connection with monoplanes and with certain types of biplane employing lift bracing cables below the bottom plane, no lift or drift bracing cables should be anchored upon any

portion of the undercarriage structure, but upon a separate and specially designed "pylon" or mast. Many serious and fatal accidents have occurred through inattention to this point.

In connection with item 3, the fore and aft stability has already been discussed, but the question of lateral stability will depend upon the width of the wheel track in relation to the span and weight of the machine. Generally speaking, the wider the wheel track the more stable the machine laterally; if a narrow track is adopted, then wing-tip skids or wheels become a necessity.

The wheel tracks of aeroplanes vary from about 4 feet in the case of light biplane scouts and monoplanes to 6 feet for ordinary biplanes, and up to 12 feet for wide wing span biplanes of large area.

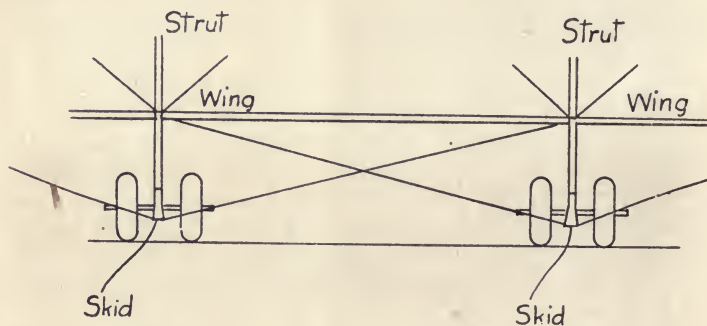

FIG. 38.—UNDERCARRIAGE FOR A HEAVY MACHINE.

The wheel track varies from one-quarter to one-tenth the span of the machine in extreme cases, but may be taken upon the average as from one-sixth to one-eighth the largest wing span (in the case of a biplane).

Many undercarriages have been designed with an intentionally smaller factor of safety than possessed by the remainder of the machine, in order that the greater part of the shock of a bad landing may be taken by the undercarriage, and the resulting damage confined to that part.

#### TYPES OF UNDERCARRIAGE.

Many of the earlier machines, including the Wright and Farman biplanes, possessed rigid skid structures without wheels. This system, although disadvantageous for "getting off," gave a rigid anchoring for the lift cables.

The most popular type of undercarriage for biplanes at the



time present is that outlined in Figs. 39 and 40, consisting of a pair of single or double wheels, and a V-type of strutting.

This latter arrangement is employed upon the heavier types of machine, and gives a firm undercarriage.

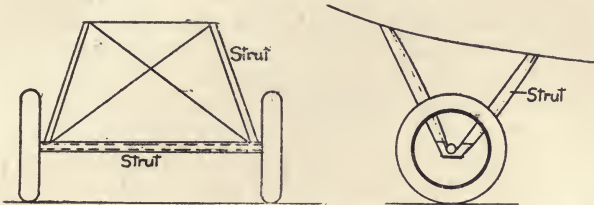

FIG. 39.—UNDERCARRIAGE ARRANGEMENT FOR A LIGHT SCOUT OR MONOPLANE.

The type of undercarriage employed upon light scouts or monoplanes is illustrated in Fig. 39, and consists of a pair of V-struts, either of streamlined steel tubing, ash, or spruce, each pair viewed in front elevation being splayed out towards the

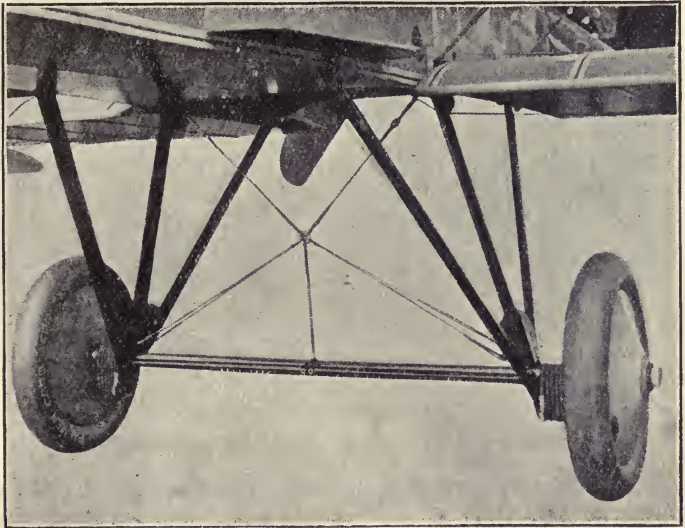

FIG. 40.—THE V-TYPE UNDERCARRIAGE, WITH CENTRAL PIVOTED AXLE.

ground and diagonally braced, as shown, with large gauge piano wire or cable to the eight extremities of the struts.

The wheels are usually carried upon plain axles, running on light gunmetal bushes in the wheel hubs. The main axle may be

continuous or divided in the centre, each half being pivoted at the centre, as shown in Fig. 40.

In the latter arrangement additional staying of the central portion is required, and the head resistance thereby enhanced.

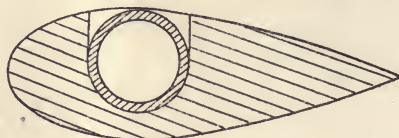

FIG. 41.—STREAMLINE STRUT WHICH IS ALSO USED FOR STREAMLINING THE WHEEL AXLE IN FLIGHT.

In designing the strut system for undercarriages, advantage should be taken of the shielding effect of struts placed one behind the other in the direction of flight, an appreciable reduction in the total head resistance resulting.

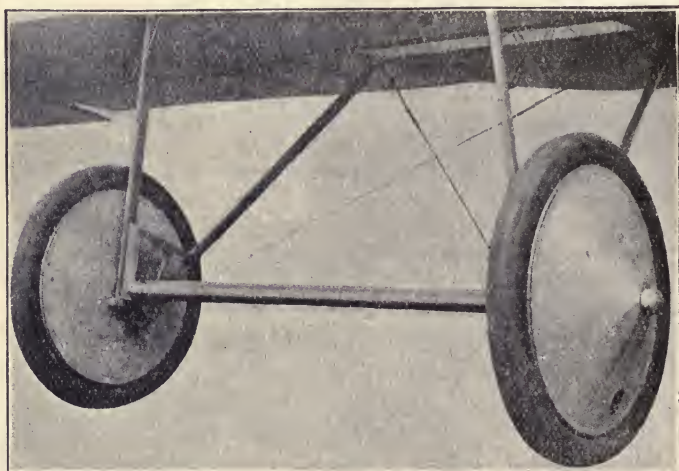

FIG. 42.—STREAMLINING THE AXLE IN V-TYPE UNDERCARRIAGE.

The main axle (or axles) in the V-type chassis, and in those illustrated in Fig. 40, is usually either made in streamline tubing, or, when a transverse strut is fitted between the two V's, it is often grooved out to receive and streamline the plain round section axle when in flight, as shown in Figs. 41 and 42.

In Fig. 40 each system of V-struts is connected along the fuselage extremities by means of a cable or steel strip, to take any outward thrust along the struts.

A very neat but simple type of **V**-undercarriage, and possessing a low head-resistance, is that employed upon the Deperdussin machines, and which has since been adopted on modern military machines. It consists of a pair of similar, outwardly splayed **U**-tube members, hinged or fixed at the top ends of the **U**-arms to the fuselage frame, the lower bends being held apart by horizontal steel tubular struts welded to the **U**-tubes. These struts also serve to carry the streamlining or fairing for the main axle which normally rests in the lower bends of the **U**-tubes, the rubber-braided cord being bound over the **U**-tube member and the axle.

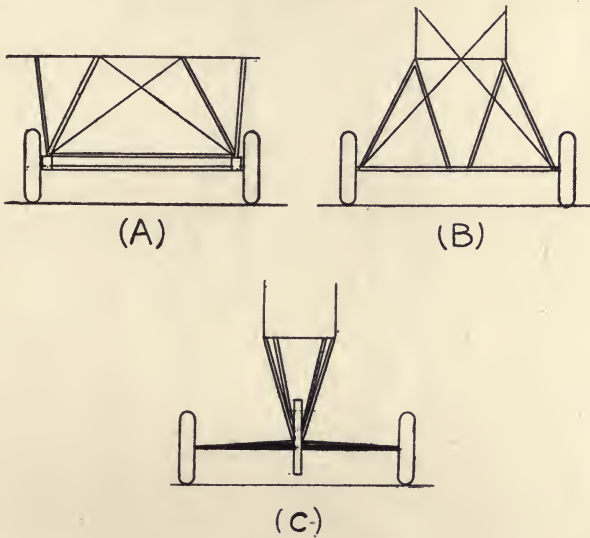

FIG. 43.

For a machine of 1,500 pounds weight, steel tubes, either nickel or nickel chrome, of external diameter about  $1\frac{1}{2}$  inches and of 16 S.W.G. thickness, will be found suitable, and the ordinary wooden fairing may be employed for streamlining purposes.

Other systems of bracing the undercarriage are shown in Fig. 43.

In the Bleriot monoplane (Fig. 44) the undercarriage consists of two wheels of about 6 feet track, each wheel being allowed a vertical travel of 12 inches. The wheels are allowed to swivel through 45 degrees, being held in the normal position by light rubber cables; no front skid is fitted.

The object of the swivelling wheels is to obviate the serious

side stresses consequent upon landing in a side wind, as the machine then has a lateral motion relatively to the ground. If the machine can be brought head to the wind, the use of swivelling wheel devices is obviated.

The additional weight and considerable head resistance of this type of undercarriage more than counterbalances any advantages accruing from its distinctive features.

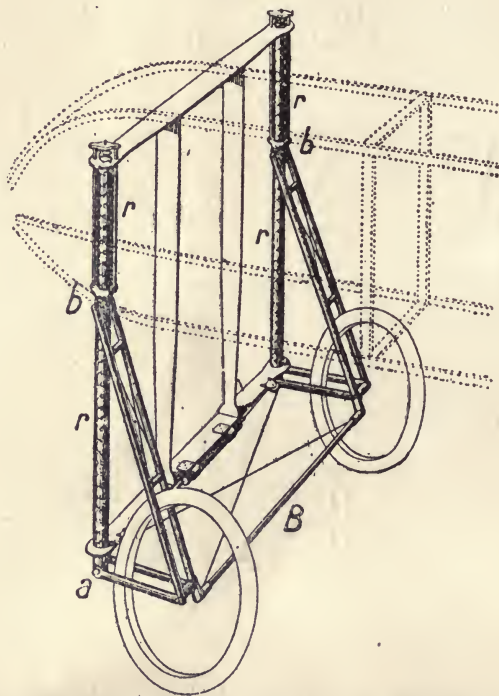

FIG. 44.—THE BLERIOT TYPE OF UNDERCARRIAGE.

In the Nieuport monoplane (Fig. 43, C) the undercarriage has been designed with the object of reducing head resistance. The wheels are mounted at the end of a transverse laminated spring attached to the single central skid in a position well in front of the C.G. The wheels, axle, and skid are held to the fuselage by means of V-struts in front elevation, and the use of cables is obviated.

The central skid is continued behind the wheels, and the usual tail skid is therefore absent. This arrangement is similar to that

shown in Fig. 35, and possesses the advantage that, being heavily loaded, it acts as braking agency when pulling up after landing. When starting, the lifting effect of the propeller blast upon the tail takes most of the weight off the rear end of the skid, and thus facilitates "getting off." This type of undercarriage gives simplicity of design, low head resistance, and strength.

### SPRINGING AND SUSPENSION.

The chief requirements of any springing device are that it should not only absorb shocks of landing and rolling, but that it shall do so in such a way that the energy of the shock shall not merely be stored up by the springing device and then given out again in the form of a rebound, but that it shall absorb the energy without giving it back in the previously mentioned form.

The absorption of vertical shocks is perhaps the chief function of a shock absorber, but a mere energy absorber is insufficient if means are not provided for undamped springing when rolling over uneven ground. It is usual to allow the wheels a few inches of undamped vertical travel, either by means of compressed air or spiral springs.

For this reason rubber and helical springs are not the most suitable devices, as the energy of shock is not "absorbed" but merely stored.

The common form of laminated or leaf spring of motor-car is a decided improvement upon the two forms of springing mentioned above, in that the frictional resistance due to the sliding of the "leaves" over each other absorbs the energy of springing.

Perhaps the best devices for shock absorbing are the pneumatic and hydraulic systems as used upon the Breguet, R.A.F., and other machines. When oil is employed, these latter are known as oleo-pneumatic systems. In these types a dash-pot is provided, which absorbs the "work" of the shock of landing or encountering an obstacle when rolling.

Fig. 45\* illustrates a typical oleo-pneumatic and spring shock absorbing device as used on the Breguet machines.

It consists of two telescopic steel tubes, the outer one, or cylinder, being attached to the axle of the wheels, whilst the inner tube, or piston, is attached to the body of the machine.

The piston is provided with a cup-leather and a spring-loaded valve, which can be adjusted to suit the weight and speed of the machine.

Upon landing oil is forced from the cylinder through the

\* Reproduced from "Aeroplane Undercarriages," Proceedings of Institute of Aeronautical Engineers, 1912.

spring-loaded valve into the interior of the piston, whence it passes out again through ports in the walls of the piston.

When the machine rests upon the ground the spiral spring takes the load, and the valve is automatically opened by the spring seen in the base of the cylinder; the top spring is used for rolling purposes.

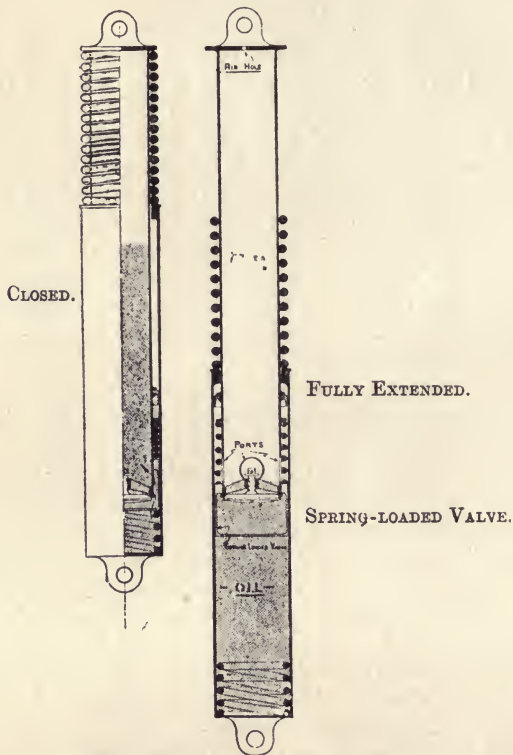
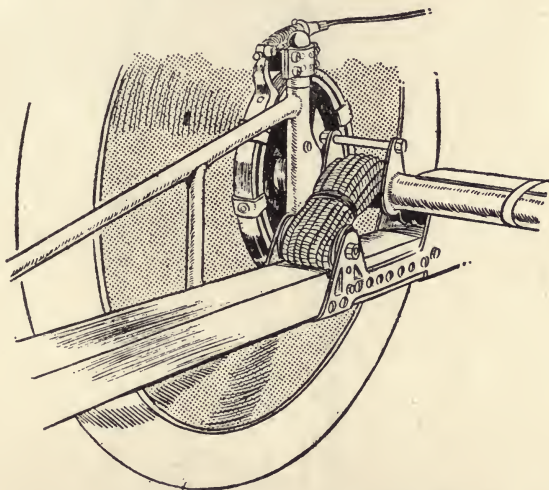

FIG. 45.—BREGUET SHOCK ABSORBER.

In the R.A.F. oleo-pneumatic shock absorber, which is very similar to the Breguet, the lower telescopic tube contains the oil, and this tube, carrying with it the axle, drops 11 inches when in flight. Upon the machine striking the ground the oil first passes into a central air chamber, and then through three exit holes, each 4 millimetres in diameter. When the velocity of impact is sufficiently high, the pressure of the oil due to its resistance in passing through the holes is raised to 640 pounds

per square inch, and a spring loaded valve is opened to provide an additional oil passage.

The arrangement is designed so that after the first 2 inches of travel of the lower tube the resistance remains constant, and equal to two and a half times the weight of the machine. As the total vertical travel exclusive of the first 2 inches is 13 inches, the total energy absorbed at constant pressure works out at 4,300 foot pounds, and this corresponds with a vertical landing velocity of 13 feet per second.



*"Flight" copyright.*

FIG. 46.—RUBBER SHOCK ABSORBER AND BRAKE.

Actually it has been shown that a fully loaded biplane can drop vertically from a height of 18 inches to the ground without injury.

In this form of suspension the rolling shocks are taken by strong spiral springs, as in the Breguet.

The Houdaille hydraulic shock absorber as applied to cars is an additional example of this type, and is very satisfactory in practice.

### RUBBER SHOCK ABSORBERS.

Rubber possesses the advantages over steel for undercarriage springing that it will absorb a much greater amount of energy per unit weight and that it is readily replaceable.

The amount of energy which good rubber can absorb varies

from 500 to 1,000 foot pounds per pound, whilst with steel it varies from 10 to 30 foot pounds, but it absorbs less work the more it stretches.

Rubber is further more easily adaptable to the various systems of suspension in vogue, and signs of deterioration are easily detected.

The rubber is used either in the form of an annular ring of from 6 to 12 inches diameter and from 1 to 3 inches wide and

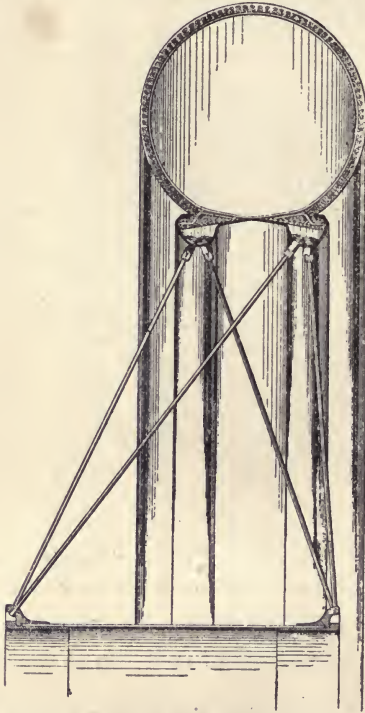

FIG. 47.—SECTION OF THE PALMER AEROPLANE TYRE AND WHEEL.

thick, or more generally as a woven fabric-covered cord or rope composed of from 50 to 300 strands of rubber covered with a woven surface, the diameter varying from  $\frac{1}{2}$  inch up to 1 inch.

The method of adapting this cord to aeroplane undercarriage springing is shown in Fig. 46; sometimes, however, the rubber cords are arranged to take the shocks, in direct tension, as distinct from bending.

The amount of cord used will depend upon the weight and



alighting speed of the machine, but a rough figure to allow for design purposes is 16 yards per 1,000 pounds weight of  $\frac{1}{2}$ -inch diameter cord for the two (or more) wheels, or about 9 yards of  $\frac{3}{4}$ -inch diameter cord.

## WHEELS.

The lighter wheels of earlier aeroplane practice are now being replaced by much stronger wheels with wide axles and well-splayed spokes for taking side stresses.

The hubs are invariably made plain, with gunmetal-steel bearings for lightness and quick replacement facilities.

The sizes of aeroplane wheels vary from 10 inches in the case of the wing-skid tip wheels up to 32 inches for very heavy machines, the standard size for monoplanes and biplanes being about  $700 \times 85$  mm., for total machine weights not exceeding 1,400 pounds.\*

A section of an aeroplane undercarriage wheel is given in Fig. 50, showing the method of taking lateral stress by means of four rows of well-splayed spokes and the long bushed hub for the axle bearing.

The wheels are usually fitted with detachable celluloid, metal, or canvas discs, to minimize head resistance. The larger the diameter of the wheel and the greater its width, the better is it adapted to traversing rough ground; the use of wheels in parallel or in tandem enables the machine to travel over rougher ground, owing to the hollows and crests being "bridged" over better.

It should be here mentioned that the lower the normal landing speed in still air, and the lighter the total weight of the machine, the lighter will be the landing chassis, in construction and weight, and the smaller the section, though not necessarily the diameter, of the wheels.

\* For very large machines, such as large twin-engined and multi-engined machines, weighing from 8,000 up to 25,000 pounds, wheels varying from  $900 \times 200$  mm., up to  $1,500 \times 300$  mm., are now used; the number of wheels ranges from two in the lighter of these machines, up to as many as eight in the largest.

## CHAPTER VI

### FUSELAGE DESIGN

#### GENERAL CONSIDERATIONS.

In the present chapter it is proposed to consider the principles underlying the design, and the more important methods of construction, of different types of aeroplane bodies in common use.

The chief functions which an aeroplane body has to fulfil may be enumerated, briefly, as follows :

1. It must provide accommodation for the engine and fuel tanks, pilot and passengers, instruments and general equipment.
2. It must be capable of taking the anchoring stresses due to the supporting surfaces, either in flight, in landing, or when stationary upon the ground.
3. It should withstand the stresses due to the weights of the engine and fuel tanks, pilot and passenger, equipment, wings and control unit, whether as a dead load, or during the landing and taxiing operations.
4. It should provide a firm anchoring for the engine, or engines, and be strong enough to withstand the stresses due to the thrust or pull of the propeller, and the torque reaction.
5. It must be able to satisfactorily withstand the stresses due to the air pressures upon the tail surfaces under the worst conditions, either as a beam under simple bending action, in torsion, or as a combination of both.
6. It must provide proper anchoring for the wings, undercarriage, and tail skid under the worst conditions of flight, landing, and taxiing.
7. Finally, it should fulfil the conditions set forth in (1), but in such a manner that the resulting form has the best aerodynamic shape for minimum head resistance, and for minimum interference with the supporting and control surfaces, whilst providing sufficient protection

and range of vision for its occupants. Moreover, it should be as light as possible, consistent with the necessary strength.

In the earliest types of machine, the engine and pilot were fully exposed to the elements, and very few attempts were made to protect either; this was not a very serious matter when the maximum speeds attained were low, the flights of short duration, and the question of aerodynamic efficiency not properly understood.

The development of the aeroplane has led towards the total enclosure of the power unit together with the occupants and equipment, in body shapes approximating, as far as constructional considerations allow, to the more perfect streamline forms.

From the military point of view also, the body of an aeroplane has to conform to certain requirements, connected with the field of vision of its occupants, the field of fire of its guns, and the protection of the pilot, passengers, engine, and fuel tanks from hostile attack.

One important requirement is that, in the event of a bad landing accident, the occupants should be protected as far as possible from injury due to the detachment of the heavier parts, such as the engine, fuel tanks, wings, etc. Moreover, adequate means should be provided for exit from the body in the event of a bad landing, without becoming entangled in wires and other parts.

### TYPES OF AEROPLANE BODY.

Although there is a wide variety of shapes and sizes of aeroplane body in present-day use, yet upon analysis these resolve themselves into three or four main types, as regards the principles of construction. These may be classified as follows, namely,

1. The Girder Type.
2. The Hollow Beam Shell, or Monocoque Type.
3. The Monocoque-Girder Type.

#### The Girder Type Fuselage.

This type of body is by far the most common in present-day use.

It consists of three, four or more longitudinal members, either of steel or wood, known as the "longerons" or "rails," which run throughout the length of the body. These rails are supported in their correct positions by means of struts and ties, so that the whole combination forms a box lattice girder, capable of taking

either vertical or side loads, and of withstanding torsion about the longitudinal axis.

In the case of a type which would be suitable for a light biplane, or a monoplane, the longerons are formed of ash members of square cross section, measuring at their widest part 30 mm. by 30 mm., and tapering down to 22 mm. by 22 mm. at the tail. The cross struts in this case also progressively diminish in size and cross section towards the tail.

The cross bracing is provided by means of high tensile wires or rods, varying from 12 S.W.G. in the front to 16 S.W.G. at the tail, and are each provided with turnbuckles or their equivalent for tuning up and alignment purposes.

Occasionally the wires in the last two or three tail panels are not provided with turnbuckles in order to save weight, but are made to the exact length before assembling.

The longerons themselves are either tapered in cross section from the pilot's seat to the tail, or are kept of uniform outside dimensions right through, but are lightened in between the cross-strut fixings. The cross-strut fixing portion itself is left solid, and may be pierced if desired without impairing its strength. The intermediate portions are spindled out into I beam section. The disadvantage of the former method is that the tapering necessitates different sizes of clips and cross-strut sections, and in general is a longer and more expensive process.

In the latter case, the parallel section of longeron enables a uniform series of clips and strut sections, and is a less costly and quicker process; it has the disadvantage of being rather heavier, as the material is not disposed to its best advantage.

One of the chief disadvantages of the previously mentioned type of fuselage is that connected with the erection or assembly of the components, for all the wires have to be separately "tuned" up and locked in position, whilst the resulting final shape must correspond with a proportionate degree of tension in each bracing wire.

This type of fuselage construction also necessitates initial tensioning stresses in order to preserve the shape and to obtain the necessary rigidity; these stresses in the case of part of the members are added to the flying or landing stresses. Further, after continual use or after a few rough landings, it is necessary to retension the bracing wires, or the shape of the framework will be found to alter and its strength will be impaired; the alignment of the whole machine may also suffer.

Another type of wooden framework, but in which the longerons are braced without the use of wires is that shown in Fig. 48. In this form of construction a series of vertical and inclined struts

are used, somewhat upon the N-girder principle. It is obvious, however, that the inclined members must be designed to act as ties, or tension members, as well as struts.

The cross section of this particular fuselage was triangular, as shown in Fig. 50, Diagram B, the whole of the members being made of spruce, the joints being made by means of steel plates.



FIG. 48.—RIGID TYPE OF GIRDER FUSELAGE.

#### *Steel Girder Type Fuselages.*

Many machines are now made almost entirely of steel, whilst in other cases the fuselage framework and undercarriage only are of steel. In some instances the front portion of the fuselage is made of steel, whilst the tail portion is of the usual wood construction. The advantage of the latter system lies in the fact that the members which are subjected to the main stresses may be suitably and economically proportioned, whilst the tail portion can be made by the lighter wood-construction method.

One commonly employed type of all-steel fuselage is that built up of steel tubes of a thin gauge, and the cross struts are either pinned and soft-soldered, brazed or welded to right angle or Vee-sockets on the longerons, as illustrated in Fig. 49.

It will be seen that the front portion of the fuselage is pentagonal in cross section in this case, whilst the tail portion is triangular.

The sockets above referred to are designed to accommodate the cross-bracing wiring plates, and the resulting structure is much more rigid and permanent than the combination wood and wire girder type.

On the score of lightness there is little to choose between the two types, although the advantage is usually somewhat on the side of the wood construction.

A somewhat heavier but permanent type of steel structure would be one built up with inclined tubular struts on the Warren or lattice girder principle; the advantage of this form of construc-

tion would be in its absolute permanence, and in the absence of tensioning or tuning up.

Alternatively, it would be possible and practicable to design a girder-type fuselage having four or more angle-sectioned longérons, with diagonal cross bracing on the lattice-girder principle,



FIG. 49.—EXAMPLE OF STEEL FUSELAGE CONSTRUCTION.

permanently riveted to the angle flanges. Built in an aluminium alloy such as duralumin, such a fuselage could be made of light, yet permanent construction, somewhat upon the lines of the girder framework of modern dirigibles of the rigid type. The cross diagonals could be designed as tie-strut members of angle,

channel, or beaded sections. One advantage of the steel tube method of construction is that the round tubes afford a convenient means for attaching the various component parts to, such as the engine, tank supports, chassis struts, seat bearers and other parts; further, it is possible to allow for longitudinal adjustments in these. The all-metal type of fuselage, moreover, lends itself to

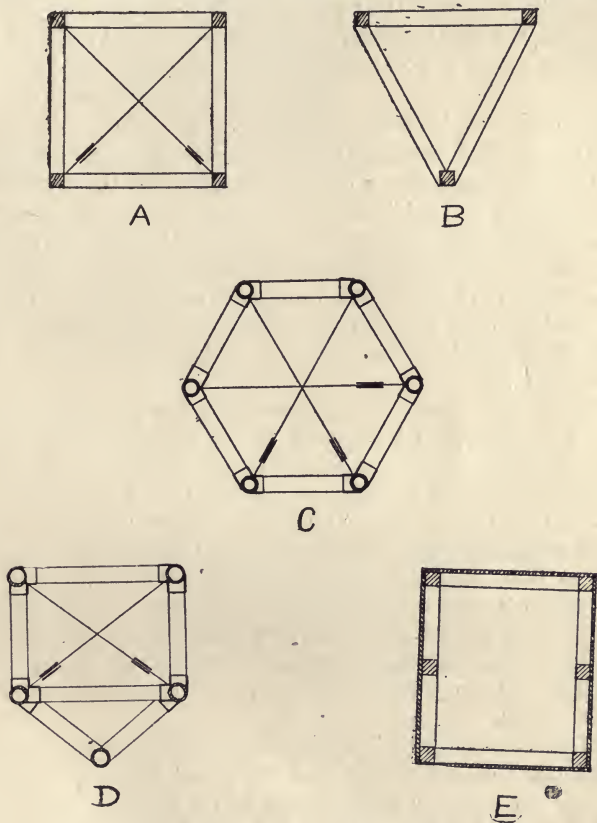

FIG. 50.—TYPICAL FUSELAGE CROSS SECTIONS.

standardization and rapid production, and for these reasons, together with its advantages from a military point of view, it is now becoming more popular.

One disadvantage of the permanent metal structure, as compared with the wooden framework, is that in the event of a breakage or distortion it is practically impossible to use the framework again.

Fig. 50 illustrates some typical fuselage cross sections in common use; it must be admitted, however, that there are many other variations of these shapes. Diagrams *A* and *B* represent braced wooden types of construction, whilst diagrams *C* and *D* illustrate steel tubular constructions, also with wire cross bracing. The junctions of the cross tubes and longerons are made by means of steel sockets of light design.

Diagram *E* refers to a combination plywood and longeron type of fuselage, which will be considered subsequently.

### *Circular and other Fuselage Sections.*

It is known that streamline bodies possessing round or elliptical cross sections have a lower head resistance than those possessing what might be termed "angular" cross sections of equal area, such as the triangular, square and pentagonal shapes; the principal reason for the observed difference is that the former type allows the air streams to flow with less turbulence past the different cross sections than in the case of the angular shapes, in which the angles and flat sides give rise to eddying flow, as in square-ended aerofoils.

Hitherto the cross sections considered have been those connected with the main framework of the body, and although in many cases this cross section is also the final shape of the covered fuselage section, yet in other cases the round or oval section is built up from the angular framework section by means of light formers and longitudinal stringers covered with fabric.

Fig. 51 illustrates one typical method of building up an oval cross section from a square-shaped framework. In this case the formers, which are fitted at intervals of some 18 inches to 3 feet along the axis of the fuselage, are of ash or birch three-ply, usually of from 4 mm. to 5 mm. thickness, and lightened out in the manner shown.

The formers are screwed to the vertical sides of the cross struts, and are cut to very nearly give the outer shape of the curve required. In order to prevent the fabric covering from corrugating or sagging in between the formers, a series of light spruce or cotton-wood girders, called "stringers," are partially let into the formers, as shown in the diagram, being held in place simply by gluing and tacking; these stringers usually project from about 6 mm. to 8 mm. above the formers. The outer sides of the stringers are slightly rounded off so as to enable the fabric to be over them more evenly.

When the whole combination of formers and stringers is covered with fabric, and the latter doped and varnished, the resulting



shape is a polygon possessing a large number of sides, but approximating to the desired oval shape.

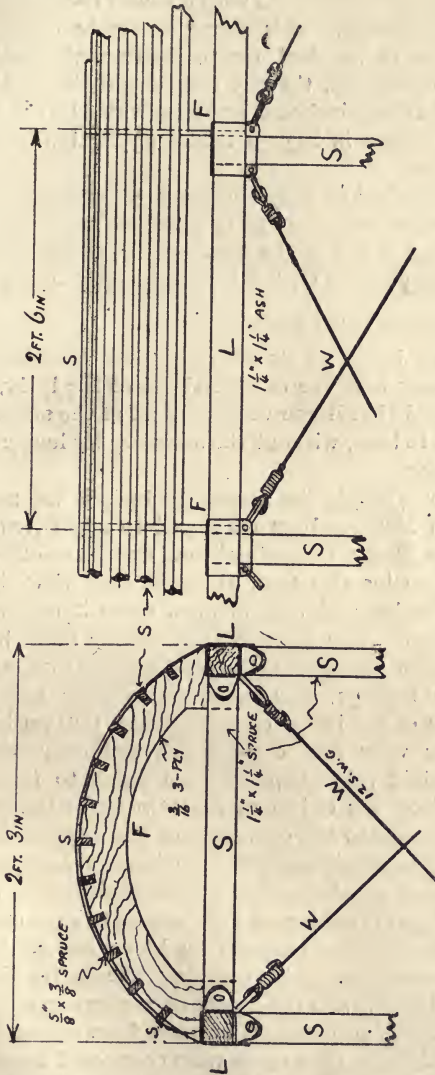

FIG. 51.—METHOD OF FUSELAGE FAIRING.

This fairing naturally increases the weight of the fuselage, but only by a matter of some 8 to 16 pounds in the case of an ordinary biplane; the aerodynamic advantages, however, totally outweigh this factor.

In the case of some aeroplanes the two vertical and the lower sides are left flat, so as to take the shape given by the longerons, whilst the top side is provided with a round back, built up in the above-mentioned way. This shape serves to enclose the projecting portions of the fuel tanks, instrument board, and the heads of the occupants, thereby lessening their head resistance; in Fig. 48 such a shape is shown, and is indicated by the dotted lines.

The fairing shown in Fig. 51 is also applicable to such a type of cross section.

In another method of streamlining the longerons, a number of longitudinal wires are attached to a former near the centre, and brought to the tail end of the fuselage. The whole combination of wires is then covered with fabric and doped in the usual way.

### The Monocoque Type of Body.

This type of body, as its name implies, consists of a single shell, conforming with the outside shape of the body, and which is so constructed that it can withstand all of the stresses which it is called upon to bear, without the necessity for longerons or cross bracing members.

Although in principle the *monocoque* body is the more correct, yet it has not hitherto been employed to any extent, except in the cases of the Bleriot, Deperdussin and one or two other machines. The chief reason for this fact, at the present time, is that it is expensive to make, and that in most cases it requires specially skilled workmen. The type of monocoque body built by the Deperdussin firm for their high-speed monoplanes, and which is illustrated in Fig. 52, was made as follows: Formers of the correct shapes of the inside of the top and bottom halves of the required body were first constructed, and over each of these formers were laid thin strips of tulip wood, to form a kind of veneered surface, the object of the thin strips being to accommodate themselves to the curvature of the former without buckling or curling, as would result if a single wide sheet were used.

Three layers of wood were built up in this manner, the strips of the first two layers running at right angles to each other. When the cementing compound between the layers was set, two layers of strong fabric were glued to the outside of the shell, and one layer of fabric to the inside, with the object of preventing splitting of the wood inside and of protecting the wood from external influences.

The two half-shells thus made were connected together so as to form one complete shell, and the wings, tail unit engine plate and undercarriage were fastened to this shell.

The thickness of the resulting shell was between 3 mm. and 4 mm., and it was remarkably light and strong.

In other methods of construction of monocoque bodies use has been made of thin ply-wood, papier-mâché and red fibre.

Comparing this type of body with the girder type, it will be seen that it can be built to better aerodynamic shapes than the latter, it is practically permanent, and is more or less immune from breakage owing to small fragments of shell or bullets; whereas the longerons of the girder type, especially when made

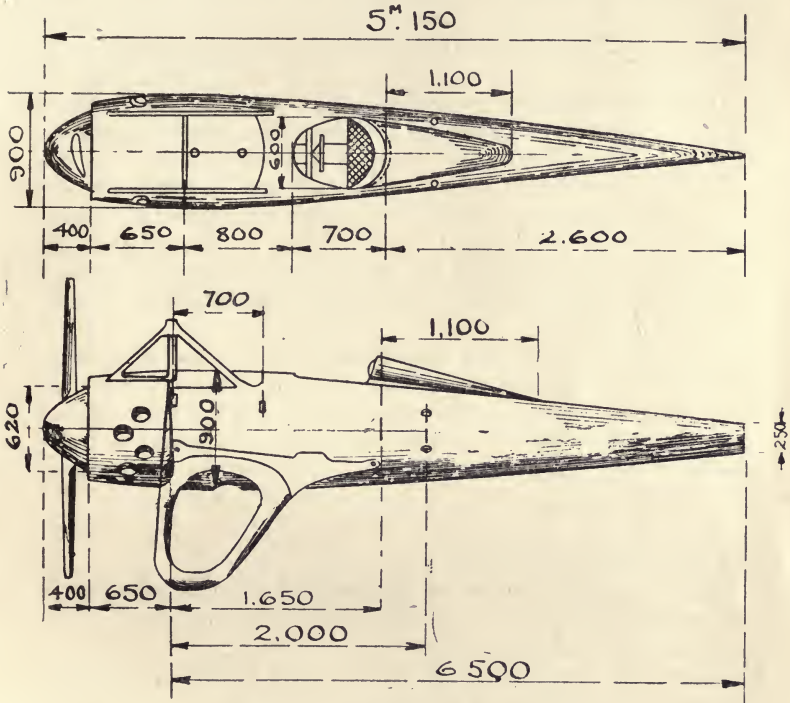

FIG. 52.—THE MONOCOQUE TYPE.

of wood, are liable to fracture, with the possibility of the complete rupture of the fuselage.

On the other hand, the girder type is more easily made, and does not require exceptionally skilled workmen. It should be pointed out that the monocoque type of body can be designed to resist the torsion due to the tail members more easily and more economically than in the case of the girder type; the material is here disposed as far away from the axis of the fuselage as possible and is continuous in the former case, whereas in the latter case

the longerons and struts seldom have the best cross sections and dispositions for taking the torque.

Apart from the employment of wood and similar substances for the material of the shells of monocoque bodies, it has been proposed to employ, in future types of machine, thin metal pressings of a light aluminium alloy, welded or riveted together in suitable sections and without any form of cross bracing. Calculation shows that it would be possible to employ thin sheets of such an alloy, of from 18 to 22 S.W.G., without increasing the weight over that of other types of body. Obviously, this mode of construction would necessitate costly stamps and dies, and would be therefore limited to quantity, production of standardized types. One other possible mode of construction which suggests itself to the writer is to employ a perforated metal or other suitable material for the material of the shell, and to cover this shell inside and out with fabric. This method would enable a heavier gauge of material to be employed, thereby giving more rigidity, without increasing the difficulty of stamping or pressing, and would lessen the risk, which is always attendant in the case of thin metal shells, of accidental indentation.

In connection with the metallic covering method of fuselage construction, it would be possible to make certain of the sheet panels of a stronger gauge of suitable metal, so as to act as engine plates, engine supports, or bullet-proof protection, and to make certain of these panels detachable for quick repair, examination and replacement purposes.

### Combination Type of Body.

Many aeroplane bodies are now made by a method which is more or less a combination of the girder and shell types.

In a typical example from current practice, there are six longerons of square-sectioned ash, arranged so that they form a rectangle with the longer sides vertical. At each corner of this rectangle is a longeron, and at the centre of the two vertical sides is another longeron as shown in Diagram *E*, Fig. 50. Instead of employing the usual struts and cross-bracing wires, the vertical and cross struts only are retained at intervals of about 2 feet along the fuselage, and the sides of the rectangle formed by the longerons are covered with sheets of three-plywood. This plywood is screwed to the longerons and struts, and the whole combination forms a box-like structure which is exceedingly strong, moderately light, and permanent.

Machines having this type of fuselage have been in use for three or four years, at the time of writing, and have given every

satisfaction, even under military conditions. When plywood is employed in place of tension wires, it is usual to either use angle struts, as shown in Diagram *A*, Fig. 53, or light spruce diagonal struts, as shown in Diagram *B*.

Many variations upon this method will suggest themselves, in so far as the arrangement of the panel struts; for example, these struts may be arranged on the Warren or lattice-girder principle, or, again, to the **N**-girder system.

In these systems the plywood covering serves to give greater rigidity, and to strengthen the structure against bending and torsion.

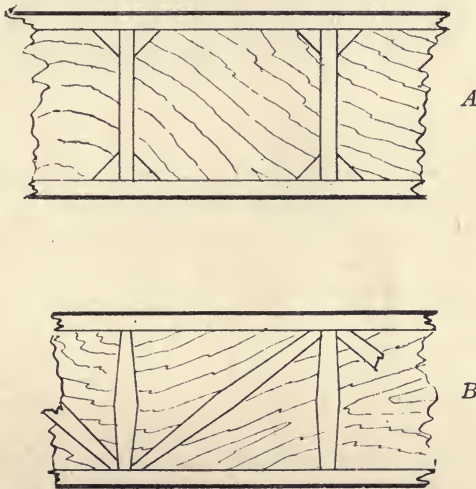

FIG. 53.—METHODS OF STIFFENING PLYWOOD PANELS.

In one well-known type of aeroplane body, the front portion of the framework consists of steel tubular members welded together; this framework is arranged to act as an engine bearer, an anchorage for the wing spars and lift cables, the tanks, seats, and for the steel tubular undercarriage.

The rear portion of the fuselage is built up of ash longerons, with the usual form of vertical struts and cross-bracing wires, or rods, for the two vertical sides, whilst top and bottom sides are simply constructed of plywood and the usual cross struts perpendicular to the longerons. This method is evidently an advantage as regards erection, and also as regards immunity from injury by bullet and shrapnel fragments in the principally exposed top and bottom panels.

## STRESSES IN AEROPLANE BODIES.

In the earlier types of aeroplane body it was the usual practice to obtain the sizes of the different members by trial and error methods, or to make chance shots at the dimensions, and to trust to luck whether the resulting body had any margin of safety or not.

Many cases of fuselages breaking in the air and in landing were the result of this haphazard practice.

Although it is not possible to accurately predict the stresses occurring under every condition of usage in aeroplane bodies, yet these stresses can be calculated in the more important cases, and the proper dimensions determined with a fair degree of accuracy, so that the material may be employed to its best advantage.

## GENERAL CONSIDERATIONS.

At the present stage it may be as well to form some general idea of the stresses resulting from the loadings.

In each case the front portion of the body between the extreme nose and the front pair of undercarriage struts is a cantilever, and the framework can therefore be designed as such—namely, of the smallest dimensions that practical considerations concerning the engine housing will allow, and of the maximum depth to withstand the bending moment at the front chassis struts. Similarly in regard to the tail portion of the body from the rear undercarriage struts, or pilot's seat panel, to the tail, this may be safely designed as a cantilever beam to withstand the worst type of loading found under the conditions of flying.

If the above two portions of the body be designed in this manner, it will usually be found that the central portion will look after itself.

## Design Procedure.

When designing an aeroplane body, the first step is to fix the overall dimensions of the body to satisfactorily accommodate the engine, fuel tanks and pilot; in the latter case the pilot should have sufficient room to manipulate his levers and controls with comfort, be able to see over the sides\* without being too exposed to the relative wind, and to get in or out easily.

The length of the tail portion of the body will be decided from considerations of stability and of control, for the length of the tail must allow sufficient leverage for the fin, rudder, elevator

\* In the open type of body, as distinct from the totally-enclosed type.

and tail planes to perform their proper functions; the length of the front portion of the body is fixed by statical balance considerations for the engine, and fuel tanks must be so situated as to locate the centre of gravity in the predetermined position.

The foregoing remarks upon the fuselage stresses apply directly to the case of aeroplane bodies which are built upon the hollow beam principle, and the dimensions which are governed by the considerations of bending strength may be ascertained by aid of the bending moment and shearing force diagrams, as set forth earlier in this book.

In the case of pusher type bodies, and of fuselages built upon any of the girder principles, it will be necessary to adopt a rather different procedure for determining the dimensions, or for checking the strength of the different members.

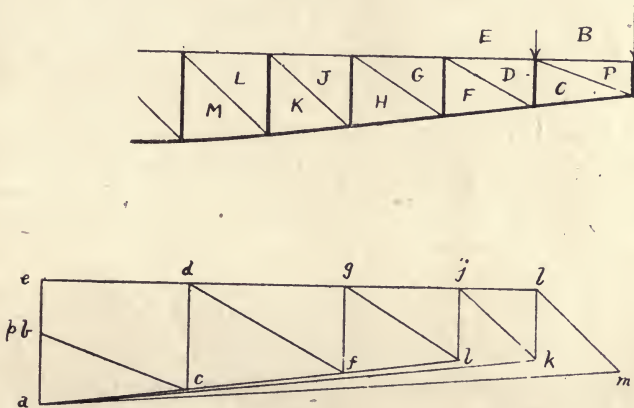

FIG. 54.—STRESSES IN THE TAIL FRAMEWORK.

#### Stresses in the Tail Portion.

The most commonly employed system in tractor fuselage framework design is the N-girder, but with a double set of tie wire diagonals, to allow the framework to take loads in both vertical directions. An example of a force polygon for the case of one of the worst types of load on the tail portion of the fuselage is shown in Fig. 54.

It is assumed that the actual centre of reaction of the tail unit is known (or can be calculated), from which the proportional loads carried by the two rearmost panels can be readily obtained; the loads carried on these panels are indicated by the arrows *AB* and *BE* respectively.

The force polygon showing the forces in the various members is shown in the lower diagram in Fig. 54, and the same general remarks apply.

In the example illustrated the total load on the tail is taken as being that due to the dead weight of the tail unit, and to the air pressure upon the elevators (or movable tail plane, if fitted) at their greatest negative incidence—namely, of from  $20^{\circ}$  to  $25^{\circ}$ —and at the maximum flying speed of the machine. Under these conditions the members of the framework should be designed to a factor of safety of at least 4, but preferably 6. The worst conditions of loading\* of the tail portion would be in the case of a down-gust or air current striking the tail when the elevators were at their greatest effective negative angle, the speed of the machine being a maximum.

Another serious case of tail loading would be that in which the machine lands heavily on its tail skid first; but it is not always possible or advisable to allow for all contingencies of what may be termed "mismanagement" of the machine.

In connection with the design of the tail members of a tractor fuselage, or of the tail outriggers of a pusher type, it is interesting to note that the recent Specifications for military aeroplanes for the United States Army required the body and tail structure to be designed to the following conditions, namely:

- (1) Angle of incidence of fixed horizontal tail surface ..  $-6^{\circ}$ .
- (2) " " " elevator surface .. ..  $-20^{\circ}$ .
- (3) Air speed 100 miles an hour.

Under these conditions the factor of safety was stipulated not to be less than 2.5.

### Stresses in Main Body of Fuselage.

It is obviously impossible in a work of the present nature to exhaustively study every condition of loading, and every type of girder body employed in practice, but it is thought that by considering a typical case, and by pointing out the general procedure observed, any ordinary type of body framework may be designed.

Fig. 55 represents in line diagram a typical arrangement of fuselage bracing in which vertical struts and tension wire diagonals are employed. The case is considered of an aeroplane landing heavily, on the undercarriage, which has two struts attached to

\* It is now usual to assume that a tail+elevator loading of from 20 to 25 lbs. per sq. ft. will just break the tail off.



each side of the fuselage framework at  $A$  and  $B$  respectively, as shown.

It is assumed that there is no support from either the main planes or the tail planes, due to the speed at landing.

For the purposes of calculation it is assumed that the landing shock amounts to twice the total weight of the machine, and therefore each wheel may be assumed to be subjected to a vertical force  $W$  equal to the weight of machine.

This force  $W$  may be resolved into two forces  $F_1$  and  $F_2$ , acting along the struts  $AC$  and  $BC$  respectively; it must be remembered that these struts are not necessarily in the same vertical planes as the wheels, and due allowance must therefore be made for the inclinations to the vertical plane of these struts. Each of the thrusts  $F_1$  and  $F_2$  may be resolved into a vertical force at  $A$  and  $B$  respectively, and a force acting towards  $A$  and  $B$  along the

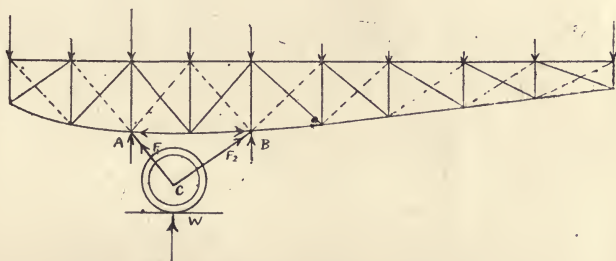

FIG. 55.

longerons, so as to have the effect of placing the portion  $AB$  of the longeron in tension. In designing this portion of the fuselage it is always advisable to allow for this tension effect when it predominates the other stresses. When the forces in the various members of the framework have been obtained, it will be necessary to algebraically add these two tension forces to those found, due to the vertical loads.

It is necessary to compute the equivalent vertical loads coming upon each of the panels, from a knowledge of the weights of the various parts, and from the general lay out of the machine.

The total weights, having been assumed to be doubled owing to the landing shock, may be regarded as the actual weights at the hinge joints, on one side of the fuselage frame (as viewed in front elevation).

The sum of these component weights must be equal to the total weight  $W$ , the fuselage being horizontal and the centre of

gravity over the centre of wheel. Having considered the tail portion of the fuselage already, it will here only be necessary to deal with the overhung front portion and that portion between the struts.

The force polygon for the tail portion, and that for the front

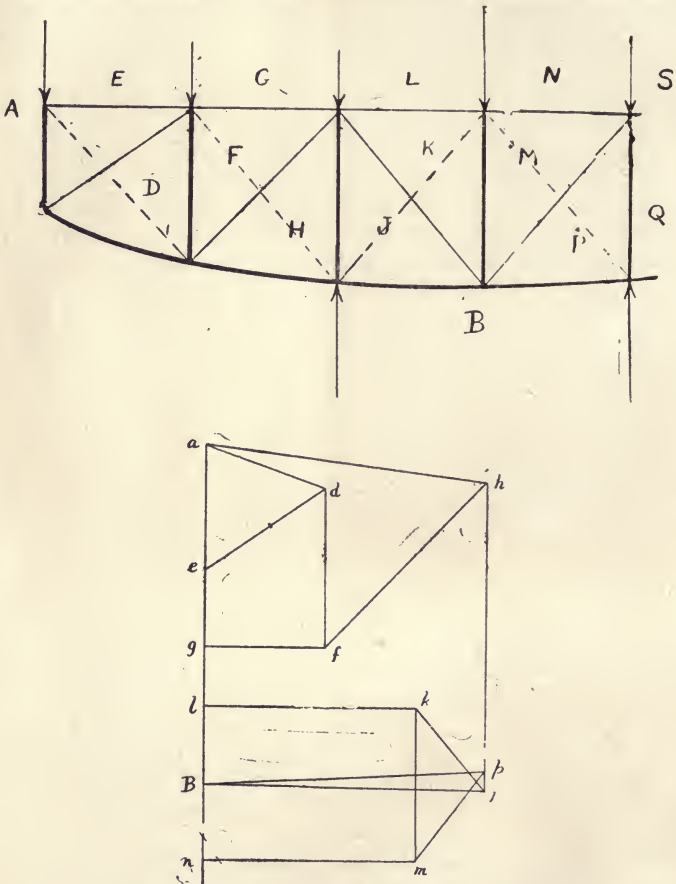

FIG. 56.—STRESSES IN FRONT PORTION OF FUSELAGE.

and centre portion, should then be combined, and the one will be found to check the accuracy of the other.

Fig. 56 represents the force polygon for the front and centre portion of the fuselage, and the lower diagram shows graphically the forces in the various members of the structure.

It will be noted that the forces are least at the extreme front panel, and greatest in the centre panels about the strut fixtures.

Accordingly, under these conditions, and, indeed, under all other conditions, the central portion of the body is designed as the strongest part of the body, and it is usually the deepest portion of the fuselage from other practical considerations, so that this fits in with design requirements satisfactorily.

In arranging the actual constructional details of the fuselage, the more important loads should be made to act as much as possible upon the vertical struts, and not upon the longerons, since these should act only as pure tension or strut members, and not as beams. It is usually possible to arrange that the important loads are transferred to the strut members by means of subsidiary beams anchored on the cross struts.

Another important point is to design the central portion of the fuselage so that the members through which the landing shocks act also take the flying loads due to the wings.

Having determined the forces in the members of the fuselage, it is necessary to adopt a factor of safety for each system, and to then determine their proportions.

Under the conditions above assumed a factor of safety of not less than 4 should be employed for the longerons and struts, and of at least 8 for the tie wires, after making due allowance for the type of end-joint employed; this allows for stretching and other adverse factors. Thus, with the usual loop and ferrule joint, it is necessary to allow from 65 per cent. to 75 per cent. for the inefficiency of the joint; with the screwed ends employed upon some tension wires, which screw into right and left handed forked socket ends at the junctions of the struts and longerons, an efficiency of from 90 to 100 per cent. is allowable.

The strut members of the fuselage should be calculated as fixed struts by the usual strut formulæ.

Finally, some account should be taken of the initial compressions in the various members, in the types of fuselage employing tension wires. These forces should be algebraically added to those found by the methods previously outlined.

## QUESTIONS AND EXAMPLES

1. The wind-vane of a weather-cock is of triangular shape, measuring 10 inches base  $\times$  15 inches height. Work out the normal wind-pressure upon same at 15, 27, and 44 M.P.H. respectively.
2. If the distance of the centre of pressure from the axis of rotation is  $22\frac{1}{2}$  inches, what are the respective turning moments at 50 and 67 feet per second normal wind speeds?
3. Work out approximately the overturning moment due to a 45 M.P.H. wind acting normally to a hoarding measuring  $97 \times 53$  inches high.
4. What is the normal pressure in kilogrammes upon a square plane of 294 millimetres side at 30 metres per second wind velocity?
5. Plot a curve showing the relation between the ratios of rectangular to square plane normal pressures, for the same areas and wind speeds, but for different aspect ratio varying from 1 to 50.
6. Find the respective normal pressures in Example 1 when the planes are inclined at 17 degrees to the wind direction.
7. An elevator plane measuring 6 feet  $\times$  2 feet, having its shorter side parallel to the wind direction, is tilted to an angle of 11 degrees to the slip-stream direction. If the slip velocity is 60 M.P.H., what is the effort experienced at the end of the 7-inch control arm? You may assume that the C.P. is situated at 0.33 of the chord from the leading edge.
8. What is the lift force experienced by a rectangular flat plane of 48 inch span and 7 inches side, at an incidence of 11 degrees, at 60 feet per second?
9. Work out the corresponding drift force in the preceding example.
10. What horse-power will be required to force the inclined plane through the air at this speed?
11. Employing the formulæ for the absolute lift and drift coefficients, find their values in the case given in Example 8.
12. An aeroplane wing measures 34 feet span  $\times$  5 feet chord, and has the U.S.A. 1 wing section. What are the lift, drift, and h.p. required to move same at 73 M.P.H. if the incidence is 6 degrees?
13. An aeroplane weighs 1,850 lbs. What wing area will be necessary in order that the machine may fly at a minimum speed of 45 M.P.H., at 12 degrees incidence, using the U.S.A. 1 wing section?
14. What h.p. will be required at the propeller in order to fly the machine at this speed, given that the body resistance is 60 lbs.?

15. If the maximum speed of the machine is 95 M.P.H., what is the h.p. required at the engine? You are given the following information: (a) That the body resistance varies as the square of the speed; (b) that the incidence is 2 degrees at this speed; and (c) that the propeller efficiency is 73 per cent.

16. A fuselage, of approximately streamline form, measures 18 feet long by 3 feet  $\times$  2 feet elliptical section. If the normal plane coefficient of resistance is 0.37, what is the resistance experienced by the body at 60 M.P.H.?

17. Work out the resistances of the following bodies at 60 M.P.H.:

- (1) A sphere of 2 feet diameter; (2) 100 feet length of 1 inch wide struts; (3) 240 feet of 16 G. wire [=0.064 inch diameter].

18. Explain in your own words the meanings of (a) Longitudinal Stability, (b) Lateral Stability, and (c) Directional Stability.

19. The wings of a monoplane are inclined at an angle of 170 degrees to each other (*i.e.*, a 10 degree dihedral angle). If one wing is suddenly lifted by a wind gust so that the other wing is horizontal, what will be the ratio of the lifts upon the two sides of the wings?

20. If the span is 235 feet and the chord 5 feet, and the wing loading 6 lbs. per square foot, what will be the amount of the righting moment?

21. In a certain aeroplane, weighing 2,350 lbs., the line of the propeller thrust is 18 inches above the centre line of resistance at 75 M.P.H. If the h.p. required at the engine to overcome the resistance at this speed is 120, and the propeller efficiency is 75 per cent., find the position of the C.P. of the wings for static balance at this speed.

22. If the engine is stopped, what will be the moment of the out-of-balance force, and in what way will it affect the machine, neglecting any effects of the slip-stream upon the tail members?

23. What force at the control lever will be required to counteract the thrust-resistance couple, the distance between the C.P.'s of elevator and machine being 15 feet, and the control leverage ratio being  $4\frac{1}{2}$ ?

24. Upon estimating the position of the C.G. of an aeroplane it was found to be 3 inches too far back. What must be the direction and amount of movement for (a) the pilot's seat, or (b) the engine, to bring the C.G. into its correct position? Given the respective weights of the machine, engine and pilot as 2,500 lbs., 940 lbs. and 180 lbs.

✓ 25. What lift coefficient will be necessary for a biplane weighing 1,930 lbs. to fly at 40 M.P.H., if the two wings each measure 35 feet  $\times$  5 feet 6 inches?

26. What will be the lift coefficient at 100 M.P.H.?

27. If the lift/drift ratio is 14 at this speed, what will be the wing resistance? If the body resistance is 45 lbs. at 60 M.P.H., what h.p. will be required at 100 M.P.H. at a propeller efficiency of 70 per cent.?

28. Work out the ratio of lifts and of drifts of two aeroplane wings each of equal area, but of aspect ratios 4 and 7 respectively.

29. What will be the difference in the lifts and in the drifts of the biplane wings of Example 25 and those of a monoplane of equal area and aspect ratio? The gap is equal to 0.8 of the chord, and the lift/drift is 8.0 at 10 degrees.

30. An aeroplane weighs 4,000 lbs., and a 200-h.p. engine is required to propel same at its maximum speed of 100 M.P.H. What will be the gliding angle of the machine at this speed? Propeller efficiency = 70 per cent.

31. If 120 h.p. is required to overcome the resistance of the machine at 70 M.P.H., what will be the maximum climbing rate and angle at this speed?

32. The landing angle of an aeroplane is 1 in 7. If the springing device of the undercarriage acts through a distance of 9 inches, what will be the ratio of the mean vertical landing force to the weight at 40 M.P.H.?

33. The 2 pairs of lift cables of a monoplane wing of 14 feet half-span and 5 feet chord are attached at points along the spars distant from the centre by  $5\frac{1}{2}$  and  $12\frac{1}{2}$  feet respectively. The cabane, or lower support for the cables, is 4 feet below the wings. If the wing loading is  $6\frac{1}{2}$  lbs. per square foot, work out the stresses in the cables and in the spars. You may assume that one-half of the load comes upon each spar.

34. Work out the stresses in a biplane system having the same wings, and struts at the same distances as the lift cables, with a gap of 5 feet 6 inches. Draw the stress and B.M. diagrams in each case.

35. The tail portion of a certain aeroplane has the following proportions: Length from pilot's seat near strut to rudder post = 10 feet; depth at this strut = 2 feet 6 inches; depth of rudder post strut = 1 foot 3 inches. The total tail area is 40 square feet, including elevators. If the breaking load specified is 20 lbs. per square foot of the total tail area, work out the stresses in the top horizontal longeron and lower longeron at the pilot's seat, and the stresses in the struts and other members, the 3 struts between the pilot's seat strut and the rudder post being equidistant (*i.e.*, 2 feet 6 inches apart). [Remember that each side of fuselage is duplicated.]

36. Work out the surface friction of a thin board measuring 4 feet  $\times$  3 feet 6 inches in an air current of 55, and one of 95 M.P.H. Employ Berriman's formula.

37. Repeat the above example, but use Zahm's formula.

38. A Zeppelin of the L 3 type is 490 feet long by 46 feet diameter, and has a volume of 70,600 cubic feet, and an envelope surface of 80,000 square feet. What will be the surface friction at 50 M.P.H.?

[Note.—The coefficient for a long plane of 32 feet or over in length is less than for a square plane, in the ratio of  $\frac{192}{244}$  in Zahm's formula.]

39. What h.p. will be required at the engine if the propeller efficiency is 70 per cent.?

40. At what speed will a motor set of 500 h.p. propel such an airship if the extra resistance due to the gondolas, rigging, and control surfaces is 500 lbs. at 60 M.P.H.?

## ANSWERS TO EXAMPLES

- (1) 0.33 lbs., 1.065 lbs., and 2.83 lbs.  
 (2) 3.18 lbs. ft.; 5.75 lbs. ft.  
 (3) 511 lbs. ft.  
 (4) 5.14 kilogrammes.  
 (6) 0.224 lbs.; 0.724 lbs.; 1.925 lbs.  
 (7) 70 lbs.  
 (8) 9.07 lbs.  
 (9) 1.76 lbs.  
 (10) 0.192 h.p.  
 (11)  $C_L = 0.452$ ,  $C_D = 0.0876$ .  
 (12) Lift = 1,700 lbs.; Drift = 105 lbs.; h.p. = 20.4 at propeller.  
 (13) 314 square feet.  
 (14) 27.2 h.p.  
 (15) 131 h.p.  
 (16) 20.17 lbs. [Area of ellipse =  $\pi \times \frac{3 \times 2}{4} = 4.7$  square feet.]  
 (17) (a) 12.3 lbs [K<sub>N</sub> = 0.34]; (b) with 3½ to 1 fineness 13.0 lbs.;  
 (c) 11.52 lbs.  
 (19) Lower wing to higher wing as 1,000 to 985.  
 (20) Difference in lifts = 7.9 lbs. Moment of righting couple = 69.2 lbs. ft.  
 (21) Propeller thrust = 450 lbs. C.G. must be placed 3.45 inches behind C.P. of wings.  
 (22) (1) If the C.G. lies on the C.L. of propeller thrust there will be no out-of-balance effect. (2) If the C.G. lies below this line the machine will become tail-heavy, the amount varying as the distance below the line of propeller thrust. (3) If the C.G. lies above this line the machine will become nose-heavy.  
 (23) 12 lbs. upon the control lever handle.  
 (24) (a) If pilot is behind C.G. the seat must be moved towards the C.G. by 41.6 inches.\* (b) If engine in front of C.G., it must be moved away from C.G. by 7.96 inches.  
 (25)  $C_L = 0.63$ .  
 (26)  $C_L = 0.101$ .  
 (27) 138 lbs.; 100 h.p. at the engine.

---

\* This would be impracticable; the fuel tanks or wings would in practice each also be displaced to obtain balance.

- (28) Ratio of lifts  $\frac{\text{aspect ratio } 7}{\text{aspect ratio } 4} = 1.059$  at 4 degrees and 1.10 at 6 degrees to 14 degrees. Ratio of drifts, at 2 degrees, 0.88; at 4 degrees to 14 degrees, 0.957.
- (29) The monoplane will lift 540 lbs. more at 40 M.P.H. (10 degrees incidence), but will have 26 lbs. higher resistance than the biplane wings.
- (30) Resistance = propeller thrust = 525 lbs. Gliding angle is 1 in  $\frac{4,000}{525}$  i.e., 1 in 7.6.
- (31) H.P. available for climbing at 70 M.P.H. = 56 at the propeller. Climbing rate, 463 feet per minute.
- (32) 1.47.
- (36) 0.76 lbs. and 2.27 lbs.
- (37) 0.816 lbs. and 2.24 lbs.
- (38) 1,536 lbs.
- (39) 292.5 h.p.
- (40) 64.4 M.P.H.



# INDEX

- AERODYNAMICS**, 5, 28  
**Aerofoil**, 8, 9, 11  
**Aeroplane**, Alighting of, 74, 75, 79  
     " Bodies, 91  
     " Construction, 1, 2  
     " Controls, 26, 27  
     " Nomenclature, 22, 23  
     " Requirements, 30  
     " Types of, 31, 32, 33  
     " Undercarriages, 74-89  
     " Wing Plan Forms, 62, 64, 65  
**Absolute Ceiling**, 4, 61  
     " Coefficients, 7, 10, 11, 12, 34, 42, 52  
**Acentric Types of Aeroplanes**, 17  
**Aircraft Performances**, 3, 52-61  
**Aileron**, 22, 23, 27, 63  
**Air Density**, 3, 10  
     " " Effect upon Horse-Power, 58, 59, 61  
     " " Effect upon Performance, 58, 59, 61  
     " Pressure upon Flat Plates, 6, 7, 8, 9  
     " Stream Flow around Bodies, 6, 7, 8, 43  
     " Surface Friction of, 28  
     " Resistance, 6, 7, 8, 9, 14  
**Altitude**, Effect of, 3, 58, 59, 61  
**Aluminium**, 2, 68, 72, 73, 94, 95, 100  
**Angles**, Critical, 12, 13, 47  
     " Dihedral, 24, 25  
     " Flying, 11, 36, 46, 47  
     " Gliding, 17, 60, 61, 74, 75  
     " of Climb, 60  
     " of Incidence, 8, 36, 46, 47, 53  
     " Stalling, 12, 13, 47  
**Area**, Normal Plane, 7, 8  
     " of Control Surfaces, 24, 25, 26, 27  
     " of Wings, 10, 24, 36, 41, 52  
     " of Tail, 24  
     " Side, of Aeroplanes, 24, 25, 26  
**Armoured Wooden Spars**, 67  
**Ash**, 2, 66, 69, 70, 71, 81, 92, 96, 100, 101  
**Aspect Ratio Corrections**, 47, 48, 49, 57  
     " " Effect of, 7, 42, 47, 57, 63  
**Automatic Stability**, 16  
**Axles**, Streamlined, 81, 82  
  
**Balance**, Lateral, 24, 25  
     " of Control Area, 26, 27  
     " Static, 16, 21  
  
**Banking**, 4, 25, 26  
**Beams**, Economical Sections, 4  
     " " Shapes of, 2, 3, 4  
**Beta**, Dirigible Section, 14  
**Biplane**, General Characteristics, 30, 31, 32, 33, 39, 41, 61  
     " Resistances, 55, 56  
     " Spacing Corrections, 50, 51, 57  
     " Stability Arrangement, 23  
     " Stagger, 41, 51, 57  
     " Wing Bracing, 2, 3, 62, 63  
**Bird Flight Data**, 41, 42  
**Bombing Aeroplanes**, 32  
**Bleriot Monoplane**, 54, 55, 98  
     " Undercarriage, 83, 84  
     " Wing Section, 44, 48  
**Body**, Resistance, 6, 14, 15, 53, 54, 55, 56  
     " Streamline, 6, 14, 15, 80, 99  
**Breguet**, Oleo-Pneumatic Springing, 85, 86  
     " Wing Spar, 68  
**Brake Horse-Power**, 17, 54, 57, 58, 59, 60  
**Brakes for Aeroplanes**, 30, 79, 85, 87  
  
**Calculation of Areas**, 36, 37, 38, 46, 52, 53  
     " of Horse-Power, 54, 55, 56, 57  
     " of Performances, 28, 46, 53, 54  
     " of Position of C.G., 20, 21, 28  
     " of Speeds, 36, 37, 38, 46, 52, 53  
**Camber**, 8, 13  
**Cambered Aerofoils**, 8, 9, 10, 11, 13  
**Castoring Wheels**, 83, 84  
**Caudron Wing Spars**, 67, 68, 71  
     " Wings, 65, 68, 71  
**Ceiling**, 4, 60, 61  
**Chassis**. See Undercarriage  
**Chord**, of Wing, 8  
**Centre of Gravity**, 16, 17, 18, 19, 20, 21, 28, 76, 77, 78  
     " of Pressure, 8, 9, 10, 19, 20, 23, 24, 46  
     " of Resistance, 16, 17, 18, 19, 20  
     " of Thrust, 16, 17, 18, 19, 20  
**Centrifugal Effect**, 19  
**Circular Rod**, Resistance of, 6, 15  
**Clement-Bayard**, 69, 72, 73  
**Climbing Rates**, 3, 58, 59, 60, 61  
**Commercial Aeroplanes**, 32  
**Compression Members**, 3, 14, 69, 70  
     " Ribs, 69, 70, 71, 72, 73  
     " Strengths, 2

- Construction, Methods of, 1, 2, 3, 62, 66, 67, 68, 69, 70, 71, 72, 73, 91, 92, 93, 94-101
- Control Surfaces, 20, 26, 27
- Controls, 2, 25, 26, 27
- Critical Angle, 11, 12, 13, 47
- Curves of Aerofoil Properties, 11, 12, 13, 14
- ,, of Performance, 52, 53, 54, 55, 56, 57
- Deperdussin Fuselage, 98, 99, 100
- ,, Monoplane, 38, 98
- ,, Undercarriage, 83
- Design of Aeroplanes, 1, 27, 28
- D.F.W. Aeroplane, 62, 63, 71
- Dihedral Angle, 23, 24, 25, 51
- Distribution of Pressure across Aerofoil, 44, 45
- ,, of Pressure along Aerofoil, 42, 43
- Directional Control, 27
- ,, Stability, 23
- Dirigible, Resistance, 15, 110
- ,, Shape, 14
- Drift Bracing, 23, 69, 70
- ,, Coefficient, 10, 11, 12, 13, 34, 36, 37, 38, 46, 47, 52, 53
- Dunne Aeroplane 62, 65
- Dynamic Stability, 16, 21, 22, 23
- Economical Beams, Sections, 3, 4, 67, 68, 95
- ,, Shapes, 3, 4, 92, 93, 99
- Eddies, 5, 6, 7
- Efficiency of Aeroplane, 30
- ,, of Ferrule Joints, 107
- ,, of Propeller, 17, 37, 58
- ,, of Performances, 51, 52, 53, 54, 55
- ,, of Stay Wire Joints, 107
- Eiffel, Bird Wing, 45
- ,, Pressures upon Planes, 8, 9
- ,, Wind Channel Researches, 7, 8, 9, 37, 44, 45
- Elevator, 22, 23, 24, 26, 27
- Empennage. *See* Tail Plane
- Energy in Shock Absorbers, 87, 88, 89
- Engine, Power Curves, 3, 53, 55, 57
- ,, Stoppage, Effect of, 16, 17, 18, 19
- Equilibrium of Forces on Aeroplanes, 17, 18
- Estimation of Performances, 51, 52, 53, 54, 55
- Etrich-Taube Wings, 23, 62, 65, 71
- Fabric, 40, 44, 45, 69, 96
- Factors of Safety, 5, 40, 80, 81, 104, 107
- Fairings, 82, 96, 97
- Farman Bracing System, 62, 63, 71
- ,, Seaplane, 62, 63
- ,, Undercarriage, 80
- ,, Wing Spars, 66, 67, 71
- Fighting Type of Aeroplane, 26, 32, 59, 63
- Fin, Vertical, 25, 26, 27
- Fineness Ratio, 14, 15
- Flanges of Girders, 1, 2, 67, 68
- Flaps, 27
- Flat Planes, Resistance of, 6, 7, 8, 9, 28
- Flexible Wings, 65, 66, 71
- Float, Resistance of, 15
- Flying Angles, 11, 12, 13
- ,, Boats, 26, 32, 33, 38, 39, 62
- ,, Speed, 13
- ,, Wires, 62, 63
- Former Ribs, 69, 70
- Friction, Surface, 5, 15, 28
- Fuel Tanks, 20
- Fuselage, Bracing, 92, 94, 95, 100, 101
- ,, Construction, 91, 92, 95, 99
- ,, Design, 90, 91, 92
- ,, Resistance, 14, 15, 55, 56
- ,, Stresses, 102, 103, 104, 105, 106
- Gap of Biplanes, 50, 51
- ,, of Triplanes, 50, 51
- Girder Type Fuselage, 91, 92, 94, 95, 100, 101
- Girders, 2, 3, 92
- Gliding Angles, 3, 17
- ,, of Aeroplane, 16, 18
- Ground Incidence of Machines, 78, 79
- Handley Page, 27
- Head Resistance, 16, 17, 20, 53, 54, 55, 77, 79, 91, 98
- Horse Power, Altitude Effect, 58, 59, 61
- ,, Available, 54, 55, 56
- ,, Brake, 17, 54, 55, 56
- ,, Curves, 54, 55, 56, 57, 58
- ,, Loading of Machines, 38
- ,, Required, 53, 54, 55, 56, 58
- Hollow Metal Struts, 4
- Houdaille Shock Absorbers, 87
- Incidence, Angles of, 8, 11, 12, 19, 36, 46, 47, 53
- Inherent Stability, 16
- Inclination of Aerofoil, 8, 9, 10, 11, 12
- ,, of Flat Plane, 7, 8
- Interference in Biplanes, 43, 50, 51, 57, 91
- ,, in Triplanes, 50, 51, 57
- Interplane Struts, 1, 14, 22, 23, 62, 63
- Kangaroo Skid, 78
- Kinetic Energy in Landing, 74, 75
- Laws of Resistance, 7
- Landing of Aeroplane, 74, 75, 77, 79
- ,, Shocks, 74, 75, 85, 86, 87
- Lateral Control, 25, 26, 27
- ,, Stability, 21, 23, 24, 25, 26
- Leading Edge, 8, 22, 23
- Lift Cables, 22, 23, 40, 62, 63
- ,, Coefficients, 10, 11, 12, 13, 34, 35, 42, 46, 47, 50
- ,, Drift Ratio, 10, 11, 12, 43, 48, 49, 50

- Lift Forces, 10, 11, 12, 13, 24, 36, 38, 43, 44  
 Loading of Wings, 38, 39, 44, 45, 46  
 Longeron, 91, 92, 93, 94, 95, 96, 97, 100, 101  
 Longitudinal Control, 26, 27  
 „ Stability, 19, 23  
 Magnan, Dr., 41, 42  
 Materials, Aeroplane, 1, 2, 3, 66, 69, 81, 92, 96, 100, 101  
 Metal Fuselages, 93, 94, 95, 100  
 „ Wing Construction, 4, 68, 71, 72  
 „ „ Spars, 4, 68, 72, 73  
 „ „ Struts, 4, 68, 71, 72, 93, 94, 95, 100  
 Metals, Relative Strengths, 2  
 Metric Units, 7, 34  
 Model Tests, 37, 47, 51, 57  
 Monocoque Type Fuselage, 98, 99, 100  
 Monoplanes, Characteristics, 39, 40, 41, 50, 51, 53, 55, 57  
 „ Committee's Reports, 39, 40  
 „ Resistances, 54, 55, 56, 57  
 „ Wing Bracing, 39, 40  
 „ „ Stresses, 39, 40  
 Morane Wing Bracing, 66  
 „ „ Plan, 66  
 Negative Wing Tips, 19  
 Nieuport, Aeroplane, 37  
 „ Undercarriage, 84, 85  
 „ Wings, 67  
 Nomenclature, Aeroplane, 22, 23  
 Normal Plane Pressures, 6, 7, 8, 9, 10  
 N.P.L. on Model Tests, 42, 50, 51, 52  
 Oleo-pneumatic Springing, 85, 86, 87  
 Parasol Monoplane, 18, 24, 25, 43  
 Performance of Aeroplanes, 3, 27, 28, 29, 30, 53, 54, 55, 60, 61  
 „ Curves, 53, 54, 58, 59, 60, 61  
 Pitching of Aeroplane, 15, 19  
 Plan Form of Wings, 47, 48, 49  
 Planes, Aerodynamical Properties of, 5, 6, 7, 8, 15  
 Plywood for Aeroplanes, 66, 67, 69, 70, 71, 95, 96, 97, 100, 101  
 Ponnier Aeroplane, 38, 42  
 Poplar for Aeroplane Construction, 61, 71  
 Pressure, Centre of, 8, 9, 10, 19, 20, 23, 24  
 „ Distribution on Wings, 42, 43, 44, 45  
 „ Upon Planes, etc., 5, 6, 7, 8  
 Propeller, Efficiency, 17, 37, 58  
 „ Clearance, 19, 28, 78, 79  
 „ Slip-Stream, 43, 56, 57  
 „ Thrust, 17, 18, 19, 20, 76  
 R. A. F. Oleo-pneumatic Springing, 85, 86  
 „ Streamline Wires, 1, 2, 15  
 „ Wing Section, 1  
 Rate of Climb, 3, 58, 59, 60, 61  
 Reconnaissance Aeroplane, 31, 56  
 Resistance, Body, 15, 54, 55, 56, 57  
 „ Component, 15, 55, 56  
 „ Head, 5, 15, 55, 60  
 „ Laws of, 7  
 „ Line of, 17, 18, 19, 20, 21  
 „ of Various Bodies, 5, 6, 7, 8, 14, 15  
 „ Surface Frictional, 5  
 „ Tables of, 15  
 „ Total, 55, 56, 60  
 „ Wing, 10, 11, 12, 15  
 Resultant Forces, Estimation of, 9, 20  
 Ribs, Compression, 15, 69, 70, 71, 72, 73  
 „ Flexible, 65, 66, 71  
 „ Former, 15, 69, 70  
 „ Steel, 68, 69, 71, 72  
 Rigid Girder Systems, 2, 3, 93, 100, 101  
 Rubber, Shock Absorbers, 85, 87  
 „ Tyres, 89  
 Rudder, 25, 26, 27  
 Scale Model Results, 28, 37, 38, 43, 50, 51  
 Scout Aeroplanes, 30, 31, 46, 47, 62, 63  
 Seaplane, Float Resistance, 15  
 „ Requirements, 32, 33, 38, 39  
 Sections of Wing Spar, 4  
 Shock Absorber, 87  
 Side Area of Fuselages, 24, 25, 26  
 „ „ of Struts, 15  
 Side-Slip, 24, 25  
 Skids, Kangaroo, 78, 84  
 „ Nieuport, 83, 84, 85  
 „ Tail, 77, 78  
 „ Undercarriage, 75, 77, 80, 83, 84, 85  
 Skin Friction, 6, 7, 28, 38, 55  
 Slip Stream, 43, 56, 57  
 Span of Wings, 8  
 Speed Range, 36, 37, 46, 47, 61  
 Sphere, Resistance of, 6, 15  
 Springing, Undercarriage, 74, 75, 85, 86  
 Spruce, 2, 66, 67, 69, 71, 96, 97  
 Stability, 15, 16, 17, 18, 19, 20, 28, 66  
 Stagger of Biplane, 51  
 Stalling Angle, 12, 25, 46  
 „ Speed, 13, 25, 46  
 Static Balance, 16, 17, 18, 19  
 Steel Wing Constructions, 4, 68, 69, 71, 72  
 „ Spar Sections, 4, 66, 67, 68  
 „ Fuselages, 93, 94, 95  
 Streamline, Axles, 81, 82  
 „ Bodies, 5, 6, 14, 15  
 „ Struts, 4, 14, 82  
 „ Wires, 1, 2, 14  
 Stresses, Estimation of, 5, 40  
 „ In Fuselages, 102, 103, 104, 105, 106, 107  
 „ In Undercarriages, 74, 75, 76  
 Stringers, 69, 70, 71, 96, 97  
 Struts, Resistance, 5, 6, 14, 15, 82  
 „ Sections, 2, 3, 6, 14, 15, 82  
 Suction on Wings, 43, 44, 45  
 Tail, Plane, 10, 15, 23, 24, 27  
 „ Skid, 77, 78, 104  
 „ Strength, 103

- Tatin Monoplane, 37  
 Tests, Aspect Ratio, 7, 8, 47, 48  
 ,, Biplane and Triplane Spacing, 50,  
 51  
 ,, Eiffel's, 7, 8, 9, 37, 44, 45  
 ,, Dihedral Angle, 51  
 ,, N.P.L., 42, 50, 51, 52  
 ,, of Machine, 5, 28  
 ,, Pressure Distribution, 42, 43, 44,  
 45  
 ,, Staggering, 51  
 ,, Wind Channel, 7, 8, 9, 28, 37, 50,  
 56  
 Tension Members, 2, 3, 40, 56, 62, 63, 69  
 92, 98  
 Total Resistance of Aeroplanes, 54, 55,  
 56  
 Timber, Relative Strengths, 2  
 ,, in Aeroplane Construction, 2, 3,  
 Also see ash, spruce, plywood,  
 etc.  
 Tubes for Wing Spars, 4, 68, 72, 101  
 Tubular Members, 4, 68, 72, 73, 81, 82, 83,  
 93, 94, 95  
 Turbulence, 5, 6, 7  
 Tyres, Undercarriage, 89  
 Thrust of Propeller, 17, 18, 19, 20, 76  
 Track, Undercarriage Wheel, 80, 81  
 Trailing Edge of Wing, 8, 22, 23  
 Triplane, 50, 51  
 Undercarriages, Design of, 16, 19, 74-87  
 ,, Requirements of, 40, 79  
 ,, Springing, 85, 86, 87  
 ,, Stresses, 74, 75, 76  
 ,, Types, 77, 78, 79, 80, 81,  
 82, 83  
 ,, Wheels, 87, 88, 89  
 Units for Aerodynamical Calculations, 7,  
 8, 9, 10, 11, 34  
 U.S.A. Wing Section, Properties of, 11, 13  
 Vee-type Undercarriage, 81, 82, 83  
 Vertical Fin, 25, 26, 27  
 Washed-out Wings, 49  
 Weight, Aeroplane, 17, 18, 19  
 ,, of Monoplane Wings, 40  
 ,, Relative Strengths for, 2  
 Weiss, Wing, 23  
 Wheel Tracks, 80  
 Wheels, Undercarriage, 80, 81, 82, 87, 89  
 Wind Channel, 28, 37, 50, 56  
 Wing, Areas, 10, 36, 41, 52  
 ,, Bracing, 3, 62, 63  
 ,, Camber of, 13, 14  
 ,, Components, 22, 23  
 ,, Construction, 67, 68, 69, 70, 71,  
 72, 73  
 ,, Flying Angle, 11, 12, 13  
 ,, Load Distribution, 42, 43, 44, 45  
 ,, Loading, 34, 38, 42, 45  
 ,, Plan Forms, 62, 64, 65  
 ,, Sections, 11, 13  
 ,, Spars, 4, 66, 67, 68, 69, 70, 71, 72  
 ,, Resistance, 10, 11, 12, 15, 34, 36, 47,  
 52  
 Wire, Bracing, 2, 3, 40, 55, 56, 62, 63, 69,  
 92, 98  
 ,, Streamline, 1  
 Wood in Aeroplane Work, 2, 3, 66, 67  
 Wright, Undercarriage, 80  
 Yawing, 23  
 Zeppelin, Resistance, 15



THIS BOOK IS DUE ON THE LAST DATE  
STAMPED BELOW

AN INITIAL FINE OF 25 CENTS

WILL BE ASSESSED FOR FAILURE TO RETURN  
THIS BOOK ON THE DATE DUE. THE PENALTY  
WILL INCREASE TO 50 CENTS ON THE FOURTH  
DAY AND TO \$1.00 ON THE SEVENTH DAY  
OVERDUE.

JAN 25 1934

~~JAN 26 1934~~

SEP 17 1935

FEB 15 1943

DEC 20 1942

7 Oct DEAD

LIBRARY USE

JUN 11 1953

9 Jan 1960

REC'D LD

JAN 11 1960

LD 21-100m-7, '33

7

420883

TL 671  
12  
582

UNIVERSITY OF CALIFORNIA LIBRARY

1794

