

GIFT OF
PROF. W. B. RISING

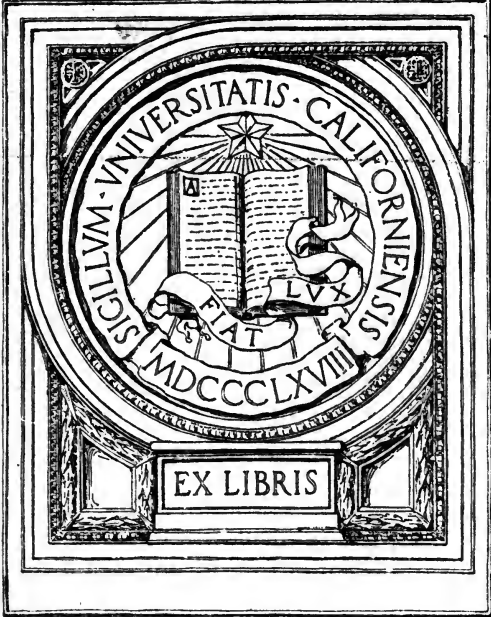

EX LIBRIS





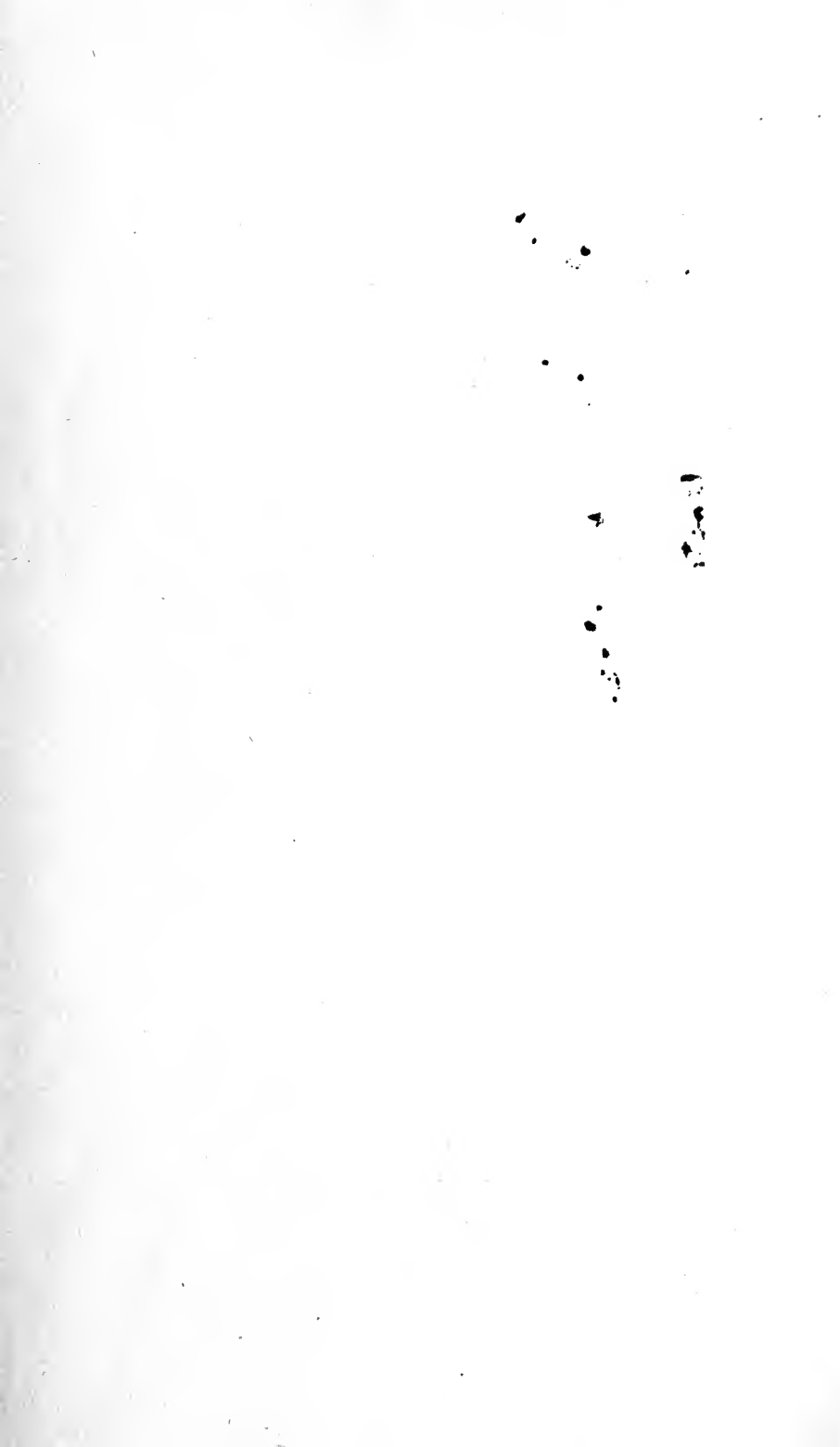

ELEMENTS

OF

CHEMICAL PHYSICS.

BY

JOSIAH P. COOKE, JR.,

ERVING PROFESSOR OF CHEMISTRY AND MINERALOGY IN
HARVARD UNIVERSITY.

SECOND EDITION.



BOSTON:

JOHN ALLYN, PUBLISHER,

LATE SEVER, FRANCIS, & CO.

1873.

Entered according to Act of Congress, in the year 1860, by
JOSIAH P. COOKE, JR.,
in the Clerk's Office of the District Court of the District of Massachusetts.

WILSON

CAMBRIDGE:
PRESSWORK BY JOHN WILSON AND SON.

P R E F A C E .

THE history of Chemistry as an exact science may be said to date from Lavoisier, who first used the balance in investigating chemical phenomena, and the progress of the science since his time has been owing, in great measure, to the improvements which have been made in the processes of weighing and measuring small quantities of matter. These processes are now the chief instruments in the hands of the chemical investigator, and it is evidently essential that he should be familiar with the causes of error to which they are liable, and should be able to determine the degree of accuracy of which they are capable. All this, however, requires a theoretical knowledge of the principles which the processes involve; and the chemical investigator who, without it, relies on mere empirical rules, will be exposed to constant error.

This volume is intended to furnish a full development of these principles, and it is hoped that it will serve to advance the study of chemistry in the colleges of this country. In order to adapt the work to the purposes of instruction, it has been prepared on a strictly inductive method throughout; and any student who has acquired an elementary knowledge of mathematics will be able to follow the course of reasoning without difficulty. So much of the subject-matter of mechanics has been given at the beginning of the volume as was necessary to secure this object; and for the same reason, each chapter is followed by a large number of problems, which are calculated, not only to test the knowledge of the student, but also to extend and apply

the principles discussed in the work. Regarding a knowledge of methods and principles as the primary object in a course of scientific instruction, the author has developed several of the subjects to a much greater extent than is usual in elementary works, solely for the purpose of illustrating the processes and the logic of physical research. Thus, the means of measuring temperature and the defects of the mercurial thermometer have been described at length, in order to show how rapidly the difficulties multiply when we attempt to push scientific observations beyond a limited degree of accuracy; so also the history of Mariotte's law has been given in detail, for the purpose of illustrating the nature of a physical law, and the limitations to which all laws are more or less liable; the condition of salts when in solution, and the nature of supersaturated solutions, have in like manner been fully discussed as examples of scientific theories; and, lastly, the method of representing physical phenomena by empirical formulas and curves, which are the preliminary substitutes for laws, has been illustrated in connection with Regnault's experiments on the tension of aqueous vapor.

Although, for the reason just given, it has not been the aim of the author to make a mere digest of facts, care has been taken to include the latest results of science, and where it was impossible to enter into details, references are given to the original memoirs. The author would earnestly recommend the advanced student to extend his study to these memoirs, and not to spend much time in reading text-books. All compendiums are unavoidably incomplete. They can only give general results, which are necessarily stated in definite terms, and are apt to convey a false notion of the true character of the phenomena and laws of nature. A student who desires to train his powers of observation cannot expend labor more profitably than in looking up fully in a large library one or more of the subjects mentioned above, and reading all the original memoirs that have been written upon it. It is only in this way that he can learn what scientific investigation has really done, as well as what can be expected from it, and can thus prepare himself to work with advantage in extending the bounda-

ries of knowledge. Moreover, that peculiar scientific power which is so essential to the successful interpretation of natural phenomena can be acquired only at these fountain-heads of knowledge.

In preparing the work, the author has used freely all the materials at his command. Most of the woodcuts in the book have been *transferred* from the pages of different standard works, but especially from the *Traité de Physique* of Ganot. The excellent work of Buff, Kopp, and Zamminer has been repeatedly consulted, as well as those of Miller, of Graham, of Daguin, of Jamin, of Müller, of Bunsen, of Dana, and of Silliman, and all that is suitable for the illustration of his subject has been borrowed from them.* Whenever it was possible, the original memoirs were consulted, especially those of Regnault in the twenty-first volume of the *Mémoires de l'Académie des Sciences*. Indeed, this distinguished experimentalist has so greatly improved the methods of investigation in this department of Physics, that any text-book on the subject must necessarily be in great measure an abstract of his labors.

A large number of valuable tables are included in an Appendix at the end of the volume. Several of these have been re-calculated; but the rest are selected with care from standard authors. The authority for each table, and the page on which the method of using it is described, are given at the commencement of the Appendix. A list of numerous other tables distributed through the body of the work will be found, under the word "Tables," in the Index. The author is indebted to Captain Charles Henry Davis, Superintendent of

* Buff, Kopp, und Zamminer. Lehrbuch der physikalischen und theoretischen Chemie. Braunschweig, 1857.

Miller. Elements of Chemistry. Part I. Chemical Physics. London, 1855.

Graham. Elements of Chemistry. Vol. I., London, 1850. Vol. II., 1857.

Daguin. Traité de Physique. Tom. I. Paris, 1855.

Jamin. Cours de Physique. Tom. I. Paris, 1858.

Müller. Lehrbuch der Physik und Meteorologie. Braunschweig, 1856.

Bunsen. Gasometry. Translated by Roscoe. London, 1857.

Dana. System of Mineralogy. Vol. I. New York, 1854.

Silliman. First Principles of Physics. Philadelphia, 1859.

the Nautical Almanac, for the use of a table of logarithms of natural numbers to four places of decimals, which will be found sufficient for solving most of the problems in this book. The greater number of the problems were prepared by the author; the rest have been selected from various works, but especially from Kahl's *Aufgaben aus der Physik*, and from the Appendix to Ganot's *Traité de Physique*. Solutions of these problems will be published hereafter, though for an obvious reason they are not included in this volume. For the purpose of ready reference, the sections and equations have been numbered; the numbers of sections are given in parentheses, those of equations in brackets; and in order still further to facilitate reference, a list of the formulæ is included in the Index.

Great pains have been taken in the printing of the book to avoid errors, and the author is under especial obligation to his friend, Professor Henry W. Torrey, for a careful revision of the proof-sheets. The difficulties of securing perfect accuracy in printing formulæ and tables are almost insurmountable, and many misprints have undoubtedly occurred. Such as may be discovered will be corrected in the next edition; and the author will feel under obligations to any of his readers who will have the kindness to send him a note of such as they find.

Although the present volume is a complete treatise in itself of the principles involved in the processes of weighing and measuring, it is also intended to serve as the first volume of an extended work on the Philosophy of Chemistry. The arrangement of the chapters and sections has been adopted with this view, and the inductive method begun in this volume will be continued through the whole work. The second volume will treat of Light in its relations to Crystallography (including Mathematical Crystallography), and also of Electricity in its relations to Chemistry. The third and last volume will be on Stoichiometry and the principles of Chemical Classification. This volume is now in preparation, and will be published next.

J. P. C.

CONTENTS.

CHAPTER I.

INTRODUCTION.

(1.) Matter, Body, Substance, 3. — (2.) General and Specific Properties, 3. — (3.) Physical and Chemical Changes, 4. — (4.) Physical and Chemical Properties, 5. — (5.) Chemistry and Physics, 5. — (6.) Force and Law, 6.

CHAPTER II.

GENERAL PROPERTIES OF MATTER.

(7.) Essential and Accidental Properties, 10. — (8.) Extension and Volume, 10. — (9.) The Measure of Extension, 11.

English System of Measures 11

(10.) Units of Length, 11. — (11.) Units of Surface and of Volume, 13.

French System of Measures 14

(12.) History, — the Metre, 14. — (13.) Subdivisions and Multiples of the Metre, 17. — (14.) Units of Surface and of Volume, 17. — (15.) Density and Mass, 18. — (16.) Impenetrability, 19.

Problems 1 to 11 19

Motion 20

(17.) Position, 20. — (18.) Mobility, 21. — (19.) Time and Velocity, 22. — (20.) Uniform and Varying Motions, 23. — (21.) Uniformly Accelerated Motion, 23. — (22.) Uniformly Retarded Motion, 26. — (23.) Compound Motion, 27. — (24.) Parallelogram of Motions, 27. — (25.) Curvilinear Motion, 29.

Problems 12 to 24 31

Force 32

(26.) Force, 32. — (27.) Direction of Force, 32. — (28.) Equilibrium, 34. — (29.) Measure of Forces, 34.

Composition of Forces 38

(30.) Components and Resultant, 38. — (31.) Forces represented by Lines, 38. — (32.) Point of Application, 38. — (33.) Resultant of Forces acting in same Direction, 39. — (34.) Parallelogram of Forces, 39. — (35.) Decomposition of Forces, 40. — (36.) Composition of several Forces, 42. — (37.) Composition of Parallel Forces, 43. — (38.) Couples, 47. — (39.) Composition of several Parallel Forces, 47. — (40.) Centre of Parallel Forces, 48. — (41.) Action and Reaction, 49. — (42.) Power, or Living Force, 52.

Problems 25 to 50 54

<i>Gravitation</i>	56
(43.) Definition, 56 — (44.) Direction of the Earth's Attraction, 57. — (45.) Point of Application, 58. — (46.) Centre of Gravity, 60. — (47.) Position of Centre of Gravity, 61. — (48.) Conditions of Equilibrium, 62. — (49.) Intensity of the Earth's Attraction, 64 — (50.) Pendulum, 66. — (51.) Simple Pendulum, 66. — (52.) Isochronism of Pendulum, 68. — (53.) Formula of Pendulum, 68. — (54.) Compound Pendulum, 69. — (55.) Centre of Oscillation, 70. — (56.) Use of the Pendulum for Measuring Time, 71. — (57.) Use of the Pendulum for Measuring the Force of Gravity, 73. — (58.) Value of g , 76. — (59.) Centrifugal and Centripetal Force, 77. — (60.) The Spheroidal Figure of the Earth, 83. — (61.) Variation of the Intensity of Gravity, 85. — (62.) Law of Gravitation, 86. — (63.) Absolute Weight, 87. — (64.) French System of Weights, 89. — (65.) System of Weights of the United States and of England, 89. — (66.) Specific Weight, 90. — (67.) Unit of Mass, 90. — (68.) Density, 91. — (69.) Specific Gravity, 91. — (70.) Unit of Force, 93. — (71.) Relative Weight, 94. — (72.) Lever, 97. — (73.) Balance, 100.	
<i>Problems 51 to 90</i>	106
<i>Accidental Properties of Matter</i>	109
(74.) Divisibility, 109. — (75.) Porosity, 110. — (76.) Compressibility and Expansibility, 113. — (77.) Elasticity, 115.	

CHAPTER III.

THE THREE STATES OF MATTER.

(78.) Molecular Forces, 117.

MOLECULAR FORCES BETWEEN HOMOGENEOUS MOLECULES.

I. CHARACTERISTIC PROPERTIES OF SOLIDS.

<i>Crystallography</i>	119
(79.) Crystalline Form, 119. — (80.) Processes of Crystallization, 119. — (81.) Definitions of Terms, 121. — (82.) Systems of Crystals, 121. — (83.) Centre of Crystal, and Parameters, 124. — (84.) Similar Axes, 125. — (85.) Similar Planes, 126. — (86.) Holohedral Forms, 127. — (87.) Hemihedral Forms, 128. — (88.) Tetartohedral Forms, 129. — (89.) Simple and Compound Crystals, 129. — (90.) Dominant and Secondary Forms, 130. — (91.) Definition of Terms, and Laws of Modification, 131. — (92.) Forms of Crystals belonging to the various Systems, 132. — (93.) Irregularities of Crystals, 170. — (94.) Groups of Crystals, 173. — (95.) Determination of Crystals, 174. — (96.) Goniometers, 177. — (97.) Identity of Crystalline Form, 183. — (98.) Dimorphism and Polymorphism, 184.	
<i>Elasticity</i>	185
(99.) Elasticity of Solids, 185. — (100.) Elasticity of Tension, 185. — (101.) Coefficient of Elasticity, 186. — (102.) Elasticity of Compression, 187. — (103.) Elasticity of Flexure, 187. — (104.) Applications, 189. — (105.) Elasticity of Torsion, 191. — (106.) Applications, 193. — (107.) Limit of Elasticity, 193. — (108.) Elasticity of Crystals, 195. — (109.) Collision of Elastic Bodies, 196.	
<i>Resistance to Rupture</i>	201
(110.) Measure of Resistance, 201. — (111.) Tenacity, 203. — (112.) Cleavage, 204. — (113.) Ductility and Malleability, 205.	
<i>Hardness</i>	208
(114.) Scale of Hardness, 208. — (115.) Sclerometer, 209. — (116.) Annealing and Tempering, 211.	
<i>Problems 91 to 105</i>	213

II. CHARACTERISTIC PROPERTIES OF LIQUIDS.

<i>Mechanical Condition of Liquids</i>	215
(117) Fluidity, 215. — (118) Elasticity of Liquids, 215.	
<i>Consequences of the Mechanical Condition of Liquids</i>	218
(119.) Divisions of the Subject, 218. — (120.) Liquids transmit Pressure in all Directions, 218. — (121.) Direction of Liquid Pressure, 219. — (122.) Hydrostatic Press, 220. — (123.) Pressure of Liquids caused by Weight, 223. — (124.) Upward Pressure, 225. — (125.) Lateral Pressure, 226. — (126.) Generalization, 227. — (127.) Pressure proportional to Specific Gravity, 227. — (128.) Hydrostatic Paradox, 228.	
<i>Equilibrium of Liquids</i>	228
(129.) Conditions of Equilibrium, 228. — (130.) Connecting Vessels, 230. — (131.) Heights of Liquid Columns in Connecting Vessels, 231. — (132.) Spirit-Level, 232. — (133.) Artesian Wells, 233. — (134.) Salt Wells, 234.	
<i>Buoyancy of Liquids</i>	235
(135.) Principle of Archimedes, 235. — (136), (137), and (138.) Demonstrations of Principle of Archimedes, 237. — (139.) Centre of Pressure, 240. — (140.) Floating Bodies, 241. — (141.) Equilibrium of Floating Bodies, 242. — (142.) Stable and Unstable Equilibrium, 243. — (143.) Neutral Equilibrium, 246.	
<i>Methods of determining Specific Gravity</i>	247
(144.) Definition of Specific Gravity, 247. — (145) Specific-Gravity Bottle, 247. — (146.) Hydrostatic Balance, 248. — (147.) Hydrometers, 249.	
<i>Problems 106 to 175</i>	257

III. CHARACTERISTIC PROPERTIES OF GASES.

<i>Mechanical Condition of Gases</i>	263
<i>Properties Common to Gases and Liquids</i>	264
(150.) Pressure independent of Gravity, 264. — (151.) Pressure depending on Gravity, 265. — (152.) Pressure of the Atmosphere, 266. — (153.) Buoyancy of the Air, 268. — (154.) Weight of a Body in Air, 268. — (155.) Balloons, 270.	
<i>Differences between Liquids and Gases</i>	273
<i>The Barometer</i>	275
(157.) Experiment of Torricelli, 275. — (158.) Theory of the Barometer, 278. — (159.) Regnault's Barometer, 280. — (160.) Barometer of Fortin, 282. — (161.) Common Barometer, 284. — (162.) Uses of the Barometer, 285.	
<i>Mariotte's Law</i>	287
(163) Statement of Mariotte's Law, 287. — (164.) Experimental Illustration, 288. — (165.) History, 290. — (166.) Limit to the Compressibility of Gases, 301.	
<i>Application of Mariotte's Law</i>	301
(167.) Pressure of the Atmosphere at different Heights, 301.	
<i>Instruments illustrating the Properties of Gases</i>	307
(168.) Manometers, 307. — (169.) Pneumatic Trough, 311. — (170.) Gasometers, 314. — (171.) Safety-Tubes, 315. — (172.) Siphon, 320. — (173) Mariotte's Flask, 323. — (174.) Wash-Bottle, 325.	
<i>Machines for Rarefying and Condensing Air</i>	325
(175.) The Air-Pump, 325. — (176.) Degree of Exhaustion, 327. — (177.) Air-Pump with Valves, 329. — (178.) Condensing-Pump, 333. — (179.) Water-Pump, 334.	
<i>Problems 176 to 239</i>	336

MOLECULAR FORCES BETWEEN HETEROGENEOUS MOLECULES.

ADHESION.

<i>Solids and Solids</i>	342
(181.) Adhesion between Solids, 342. — (182.) Cements, 343.	
<i>Solids and Liquids</i>	344
(183.) Adhesion of Liquids to Solids, 344. — (184.) Capillary Attraction, 346. — (185.) Form of the Meniscus, 349. — (186.) Molecular Pressure, 349. — (187.) Amount of Molecular Pressure, 351. — (188.) Effects of Molecular Pressure, 352. — (189.) Numerical Laws of Capillarity, 355. — (190.) Verification of the Laws, 357. — (191.) Influence of Temperature, 360. — (192.) Spheroidal Condition of Liquids, 361. — (193.) Examples and Illustrations of Capillarity, 362. — (194.) Absorption, 363. — (195.) Solution, 365. — (196.) Determination of Solubilities, 369. — (197.) Solution and Chemical Change, 371. — (198.) Supersaturated Solutions, 376.	
<i>Solids and Gases</i>	379
(199.) Absorption of Gases, 379.	
<i>Liquids and Liquids</i>	383
(200.) Liquid Diffusion, 383. — (201.) Experiments of Graham, 384. — (202.) Osmose, 387.	
<i>Liquids and Gases</i>	391
(203.) Adhesion of Liquids to Gases, 391 — (204.) Solution of Gases, 392. — (205.) Variation with Temperature, 393. — (206.) Variation with Pressure, 394. — (207.) Influence of Salts in Solution, 398. — (208.) Determination of Coefficient of Absorption, 398. — (209.) Partial Pressure, 405. — (210.) Analysis of Mixed Gases by Absorption Meter, 409.	
<i>Gases and Gases</i>	412
(211.) Effusion, 412. — (212.) Application of the Law of Effusion, 414. — (213.) Transpiration, 417. — (214.) Diffusion, 419. — (215.) Passage of Gases through Membrane, 425.	

CHAPTER IV.

HEAT.

<i>Action of Heat on Matter, and Theories concerning Heat</i>	426
<i>Thermometers</i>	432
(217.) Mercurial Thermometer, 432. — (218.) Graduation of Thermometer, 433. — (219.) Defects of Mercurial Thermometer, 436. — (220.) Change of the Zero Point, 441. — (221.) Standard Thermometers, 442. — (222.) and (223.) Correction of Observation, 448. — (224.) House Thermometers, 450. — (225.) Thermometers filled with other Liquids, 451. — (226.) Maximum and Minimum Thermometers, 452.	
<i>Thermoscopes</i>	455
(227.) Air Thermometers, 455. — (228.) Thermo-multiplier, 457.	
<i>Problems 272 to 290</i>	461
<i>Specific Heat</i>	463
(229.) Temperature, 463 — (230.) Thermal Equilibrium, 463. — (231.) Unit of Heat, 464. — (232.) Specific Heat, 464. — (233.) Determination of Specific Heat, 466. — (234.) General Results, 471. — (235.) Specific Heat of Gases, 476. — (236.) Specific Heat of Gases under Constant Pressure, 477. — (237.) Specific Heat of Gases under Constant Volume, 480. — (238.) Mechanical Equivalent of Heat, 484.	
<i>Problems 291 to 310</i>	489

<i>Expansion</i>	491
(239.) Coefficient of Expansion, 491. — (240.) Relation of Cubic to Linear Expansion, 493. — (241.) Volume of a Vessel, 493.	
<i>Expansion of Solids</i>	494
(242.) Measurement of Linear Expansion, 494. — (243.) Determination of Coefficient of Cubic Expansion, 495. — (244.) General Results, 496. — (245.) Expansion of Crystals, 498. — (246.) Force of Expansion, 499. — (247.) Illustrations of Expansion of Solids, 500. — (248.) Applications of Expansion of Solids, 504.	
<i>Expansion of Liquids</i>	507
(249.) Absolute and Apparent Expansion, 507. — (250.) Absolute Expansion of Mercury, 508. — (251.) Correction of Barometer for Temperature, 511. — (252.) and (253.) Apparent Expansion of Mercury, 513. — (254.) Relation between Apparent and Absolute Expansion, 515. — (255.) Laws of the Expansion of Liquids, 516. — (256.) Expansion of Liquids above the Boiling-Point, 519. — (257.) Expansion of Water, 520. — (258.) Point of Maximum Density, 520. — (259.) Volume of Water at different Temperatures, 526. — (260.) Coefficient of Expansion of Water, 527.	
<i>Expansion of Gases</i>	528
(261.) Experiments of Regnault, 528. — (262.) General Results, 532. — (263.) Air-Thermometer, 533. — (264.) and (265.) Regnault's Air-Thermometer, 534. — (266.) Air-Pyrometer, 539. — (267.) The True Temperature, 539. — (268.) Effects and Applications of the Expansion of Air, 540.	
<i>Problems 311 to 351</i>	544
<i>Change of State of Bodies.</i> — 1. <i>Solids to Liquids</i>	548
(269.) Melting-Point, 548. — (270.) Vitreous Fusion, 548. — (271.) Freezing-Point, 548. — (272.) Effect of Salts on the Freezing-Point of Water, 549. — (273.) Effect of Pressure on the Melting-Point, 550. — (274.) Change of Volume attending Fusion, 551. — (275.) General Results, 553. — (276.) Determination of the Melting-Point, 554. — (277.) Heat of Fusion, 555. — (278.) and (279.) Person's Law, 560. — (280.) Absolute Zero, 564.	
<i>Change of State.</i> — 2. <i>Liquids to Gases</i>	565
(281.) Boiling-Point, 565. — (282.) Variations of the Boiling-Point, 568. — (283.) Determination of the Boiling-Point, 569. — (284.) Formation of Aqueous Vapor of Low or High Tension, 570. — (285.) Dalton's Apparatus, 572. — (286.) Marcet's Globe, 574. — (287.) Apparatus of Gay-Lussac, 574. — (288.) Apparatus of Regnault, 575. — (289.) Discussion of Results, 580. — (290.) Formation of Vapors of different Liquids, 582. — (291.) Maximum Tension of Vapors, 584. — (292.) Gases and Vapors, 585. — (293.) Distillation, 588. — (294.) Steam-Bath, 591. — (295.) Papin's Digester, 591. — (296.) Condensation of Gases, 592. — (297.) Greatest Density of Vapor, 600. — (298.) Smallest Density of Vapor, 602.	
<i>Heat of Vaporization</i>	603
(299.) Latent Heat of Vapor, 603. — (300.) Latent Heat of Steam, 606. — (301.) Illustrations of Laws of Latent Heat, 608. — (302.) Applications of the Latent Heat of Steam, 611. — (303.) Spheroidal Condition of Liquids, 611.	
<i>Steam-Engine</i>	615
(305.) The Boiler, 615. — (306.) Dimensions of Steam-Boilers, 620. — (307.) Watt's Condensing-Engine, 621. — (308.) Single-acting Engine, 626. — (309.) Non-condensing Engine, 628. — (310.) Mechanical Power of Steam, 631. — (311.) Low and High Pressure Engines, 633.	
<i>Problems 352 to 377</i>	634
<i>Hygrometry</i>	636
(312.) Formation of Vapor in an Atmosphere of Gas, 636. — (313.) Hygrometers, 639. — (314.) Drying Apparatus, 646.	

<i>Origin of Heat</i>	647
(315.) Sources of Heat, 647. — (316.) Physical Sources, 648. — (317.) Chemical Sources, 649.	
<i>Propagation of Heat</i>	650
(318.) Divisions of the Subject, 650. — (319.) Laws of Radiation, 651. — (320.) Laws of Conduction, 654. — (321.) Illustrations of the Laws of Conduction, 657. — (322.) Coefficient of Conduction, 659.	

CHAPTER V.

WEIGHING AND MEASURING.

<i>Solids</i>	661
(324.) Weight, 661. — (325.) Specific Gravity, 662. — (326.) Volume, 664.	
<i>Liquids</i>	665
(327.) Weight and Specific Gravity, 665. — (328.) Volume, 666.	
<i>Gases and Vapors</i>	667
(329.) Weight, 667. — (330.) Specific Gravity of Gases, 670. — (331.) Specific Gravity of Vapors, 674. — (332.) Volumes of Gases, 679.	
<i>Problems 378 to 420</i>	682

TABLES	687
INDEX	729

ELEMENTS OF CHEMISTRY.

PART I.

CHEMICAL PHYSICS.

PART I.

CHEMICAL PHYSICS.

CHAPTER I.

INTRODUCTION.

(1.) *Matter, Body, Substance.* — That of which the universe consists, which occupies space, and which is the object of our senses, is named *matter*. Any limited portion of matter, whether it be a grain of sand or the terrestrial globe, is called a *body*; and the different kinds of matter, such as iron, water, or air, are termed *substances*. The number of distinct substances already described is exceedingly large; but they are all formed by the combination of a few simple substances, called *Elements*, or else consist of one element alone. The tendency of science for the last fifty years has been to increase the number of the elements; at present sixty-two are admitted. But those recently discovered exist only in minute quantities on the surface of the globe, and appear to play a very subordinate part in the economy of nature. In regard to the *essential nature* of matter, or of the elements of which it consists, we have no knowledge; but we have observed the properties of almost all known substances, as well elements as compounds, have studied their mutual relations and their action on each other, and have discovered many of the laws which they obey.

(2.) *General and Specific Properties.* — If we study the properties of iron, we shall find that they may be divided into two classes; — one class, which iron possesses in common with all substances; the other, which are peculiar to iron, and distinguish it from other kinds of matter. A mass of iron occupies space, — or, in the language of geometry, possesses extension;

it gravitates towards the earth, that is, it has weight. But every other substance as well as iron, gases and liquids as well as solids, possess both extension and weight. Such properties as these, which are common to all kinds of matter, are called *General Properties*. Besides these general properties, iron is endowed with other qualities, which are peculiar to itself. Thus iron not only possesses extension, but it has a peculiar crystalline form. It not only possesses weight, but every piece of iron weighs 7.8 times as much as the same bulk of water. It has also a certain hardness and a familiar lustre. Properties like the last, which are peculiar to a given substance, and serve to distinguish it from other kinds of matter, are called *Specific Properties*.

(3.) *Physical and Chemical Changes*.—If, next, we study the various changes to which all substances are liable, we shall find that they also may be divided into two classes;—first, those changes by which the specific properties are not altered; and, secondly, those by which the specific properties are essentially modified, and the identity of the substance lost. Thus a mass of copper may be transported to a distant part of the globe, it may be divided into exceedingly small particles, it may be melted and cast into nails, it may be coined; but yet, although the position, the size, or the external shape is thus entirely changed, those qualities which distinguish copper, which make it to be copper, are not altered. Water may be frozen by cold or converted into steam by heat, yet the water is not destroyed; for if the ice be melted, or the steam condensed, fluid water reappears, with all its characteristic properties. A bar of iron, when in contact with a magnet, becomes itself magnetic, and acquires the power of attracting small particles of iron. So also a stick of sealing-wax, if rubbed with a silk handkerchief, becomes electrified, and endowed with the power of attracting light pieces of paper; but the peculiar properties of iron and sealing-wax are not essentially modified by these changes. Such changes, which do not destroy the identity of substance, are called *Physical Changes*.

On the other hand, if copper filings are heated for some time in contact with the air, they fall into a black powder (oxide of copper); if heated with sulphuric acid, they are converted into a blue crystalline solid (sulphate of copper); and in either case the properties of copper entirely disappear. If steam is passed

over metallic iron heated to a red heat, it yields a combustible gas (hydrogen). If an iron bar is exposed to moist air, it slowly crumbles to a red powder (iron-rust). If sealing-wax is heated to a red heat, it burns, and is apparently annihilated; but, as we shall hereafter see, it changes by burning into invisible gases (vapor of water and carbonic acid). Changes like these, by which the distinguishing properties of a substance are altered, and the substance itself converted into a different substance, are called *Chemical Changes*.

(4.) *Physical and Chemical Properties*.—Corresponding to the two classes of changes above described are two classes of properties, into which we may divide the specific properties of a substance. Those properties which a substance may manifest without undergoing any *essential* change itself, or causing any *essential* changes in other substances, are generally called *Physical Properties*. On the other hand, those properties which “relate essentially to its action on other substances, and to the permanent changes which it either experiences in itself, or which it effects upon them,”* are called *Chemical Properties*. Thus, among the physical properties of iron we should include its great tenacity and malleability, its specific gravity, its peculiar lustre, its great infusibility, the facility with which it may be forged at a high temperature, its power of transmitting electricity and of assuming magnetic polarity. Among its chemical properties, on the other hand, we should enumerate the ease with which it rusts in the air, the readiness with which it dissolves in dilute acids, its combustibility in oxygen gas, and many others. This last class of properties evidently cannot be manifested by iron without its losing its essential properties and ceasing to be iron. The first class, on the other hand, do not involve any such radical changes.

(5.) *Chemistry and Physics*.—It is the province of Chemistry to observe the chemical properties of substances, and to study the chemical changes to which they are liable. Physics, on the other hand, deals with the physical properties and the physical changes of matter. The study of Chemistry involves the discussion of at least three questions in regard to each substance. The chemist asks, in the first place, *What are the specific properties*

* Miller's Elements of Chemistry, Part I., page 2.

of the substance? in the second place, *What are the chemical changes to which it is liable, or which it is capable of producing in other substances?* and, in the third place, *What are the causes of these changes, and according to what laws do they take place?* An answer to the first of these questions must obviously be obtained before the chemist can approach the other two, and indeed the whole of Chemistry is based upon the accurate observation of the specific or distinguishing properties of substances. These properties, as we have seen, are physical as well as chemical, and when the substances can only be observed in a state of chemical rest, the chemist is obliged to depend on the physical characteristics alone in distinguishing between them; and under all circumstances he relies upon these characters to a greater or less degree. Hence the study of Chemistry necessarily implies some acquaintance with Physics, and a thorough knowledge of Physics will always be found useful to the investigator of chemical phenomena. There are, however, some portions of the subject which are more closely connected with Chemistry than the rest, and which, therefore, it is particularly convenient to study in connection with this science. This portion of Physics, which is frequently called Chemical Physics, is the subject of Part I. of this work. Chemical Physics is entirely an arbitrary division of the science, including a variety of subjects which are only grouped together because they are closely connected with Chemistry in its present condition. It treats more especially of those physical properties of matter which are used by chemists in defining and distinguishing substances, and which, therefore, it is exceedingly important for the student of Chemistry thoroughly to understand. It treats also of the action of heat on matter, and of the various methods by which the weight and volumes of bodies, whether solids, liquids, or gases, are accurately measured.

(6.) *Force and Law.*—The axiom, that every change must have an adequate cause, leads us to refer all the phenomena of nature to what we term *forces*; thus, we refer the falling of bodies towards the earth to the force of gravitation, the motion of a steam-engine to the expansive force of heat, and the burning of a candle to the force of chemical affinity. The only clear conception of the origin or nature of force to which man can attain, is derived from studying those limited phenomena of

matter which can be traced back to human agency. These phenomena, as we are conscious, result from the mysterious action of mind on matter; and we are thus led to infer that the grand phenomena of nature result in like manner from the action of the Infinite Mind on matter. In this view, force is only another name for the volition either of man or of God, and the varied phenomena of nature are only the manifestations of His all-pervading will.

A careful study of material phenomena frequently leads us to the discovery of unexpected analogies between those which seemed at first sight entirely disconnected. No two phenomena are apparently less related than the motion of our planet through space and the falling of a stone to its surface; and yet it has been discovered that all the phases of both phenomena can be perfectly explained, by assuming that every particle of matter in the universe attracts every other particle with a force varying directly as the mass and inversely as the square of the distance. So also the ripples on the surface of a still lake have no apparent resemblance to the rays of light which play upon them; but nevertheless it has been found that all the phenomena of light can be fully explained, by the assumption that they are caused by a similar undulatory motion in an ethereal medium. Such generalizations as these, by which the phenomena of nature are linked together and in a measure explained, are called *laws*. A law is the mode of action of some assumed force; thus, the law of gravitation is the mode of action of the force of gravitation, and the law of undulations is the mode of action of the force which produces light. But if force is, as above considered, a direct emanation of Divine Power, then law must be regarded as the uniform and unchanging mode of action of the Divine Mind. It must be noticed, however, that what we call a natural law is merely our human expression of the Divine mode of action in the universe, and that this is accurate in proportion to the extent and clearness of our knowledge of the phenomena and of their relations. The great differences which exist in this respect are implied in the very language of science. The words *hypothesis*, *theory*, and *law* stand for the same thing, that is, our conception of the mode in which God acts in nature, and we use the one or the other according to our own conviction of the accuracy of our conception. If we suppose that it is merely possibly correct, or

only in part true, we call it an hypothesis or a theory; but if we are fully convinced of its truth, we say that it is a law of nature.

One criterion by which we judge of the correctness of our ideas of the Divine mode of action in the material universe, and by which we determine whether a proposed explanation of material phenomena should be regarded as an hypothesis, a theory, or a law of nature, is the *completeness* with which it explains the class of phenomena in question. A law of nature must not only cover all known phenomena of the class, but must also include all those which may hereafter be discovered, and even predict their existence before they are actually observed. This has been the case with the laws of nature already discovered, and with none more remarkably than with the law of gravitation, which may be regarded as the most perfect of all. This law was first advanced by Newton to explain the phenomena of planetary motion then known, by connecting them with those of falling bodies on the surface of the earth. As Astronomy advanced, this law was not only found able to explain all the complicated perturbations of lunar and planetary motions as they were successively discovered, but it even went before the observer, and enabled the astronomer to calculate with absolute exactness the extent and the periods of these irregularities of motion, although it will require centuries on centuries to verify his results. The same is also true of the not less remarkable law of undulations advanced by Huyghens to explain the comparatively few facts of optics known in his time. As these facts have been rapidly multiplied by the wonderful discoveries of Malus and of Young, the law has not only been found fully adequate to explain all, but it has also predicted the existence of phenomena, which, like that of conical refraction, would hardly have been noticed had they not been thus pointed out. To hypotheses and theories we do not look for the same full explanation of all the facts which we require of a law. They are regarded as merely provisional expedients in science until the law shall be discovered, as guesses at truth before the truth is known. Laws have been said to be the thoughts of God manifested in nature and expressed in human language. Hypotheses, then, are our first imperfect comprehensions of these thoughts. They are also the shadowing forth of laws, and the progress of science has always been from the dim glimmerings of truth in the

hypothesis and the theory, to the full light of knowledge in the law.

Another criterion of the validity of a law, no less important than the one we have considered, is to be found in the analogies of nature. The force of *analogy* is the great directing principle in the mind of the successful student. It is this which leads him to pronounce some theories unsound, although apparently sustained by facts, and to accept others, which, although not fully verified by experiment, are yet in harmony with the general plan and order of creation, and with those convictions of the truth which are based on an enlarged knowledge and an extended observation of natural phenomena.

In thus defining law as the thoughts of God manifested in nature, and force as the constant action of his infinite will, we must be careful to remember that this is a conclusion of metaphysical rather than of physical science. The demonstrations of physical science unquestionably point to the same result; but it is the goal towards which they tend, rather than one which they have attained. In the present condition of science, we are obliged to use language which implies the existence of separate and distinct forces; but this is unimportant so long as we keep the truth in view, and do not allow ourselves to be led into materialism by the unavoidable imperfections of scientific language.

CHAPTER II.

GENERAL PROPERTIES OF MATTER.

(7.) *Essential and Accidental Properties.* — Of the general properties of matter, I shall consider in this chapter the following, which are common to all bodies, solids, fluids, and gases, and which it is important for us to study early in our course: —

Essential Properties.

1. Extension, implying,
 - a. Volume.
 - b. Density.
2. Impenetrability.
3. Mobility.

Accidental Properties.

4. Weight.
5. Divisibility.
6. Porosity.
7. Compressibility and Expansibility.
8. Elasticity.

The first three of these properties are evidently more essential than the rest. We cannot conceive of a kind of matter which would be destitute of them. Attempt to conceive of a variety of matter which would not occupy space, which would not resist an effort to condense it into a smaller volume, or which would be incapable of motion, and it will be seen at once that these properties form an essential part of the very idea of matter. The last five are as universal properties of matter as the first three; but they do not seem to our minds to be so essential, for we can conceive of matter which would not possess them. It is not difficult to conceive of matter without weight, so hard as to be indivisible, at least in a physical sense, without pores, incompressible, and therefore unelastic. Indeed, some physicists refer the phenomena of light and heat to an *imponderable* variety of matter, and the Atomic Theory supposes that the assumed atoms are indivisible, incompressible, and without pores.

(8.) *Extension and Volume.* — When we say that matter has *extension*, we merely mean that it occupies space, and the amount of space which a given body occupies we call its *volume*. We may study extension without any reference to the matter of

which it is a property, and we shall thus arrive at the principles of *Geometry*. — This science distinguishes three degrees of extension: the solid, or extension in three dimensions; the surface, or extension in two dimensions; and the line, or extension in one dimension. Only the first of these, however, can be said to be represented in matter, for a surface is only the boundary of a solid, and a line the boundary of a surface.

(9.) *The Measure of Extension*. — In order to measure the *Volume* of a solid, the *Area* of a surface, or the *Length* of a line, we adopt some arbitrary unit of extension of the same order, and by the principles of *Geometry* compare all other extensions with it. The unit of length is the only one which must be arbitrary, because we can use a square of this unit in measuring surfaces, and a cube of this unit in measuring solids. Various units both of length and of volume have been adopted in different countries. Of the numerous systems of measure there are two which it is important for us to study.

ENGLISH SYSTEM OF MEASURES.

(10.) *Units of Length*. — The unit of length which has been adopted in this country is the same as that of England. It is called a *yard*, and is said to have been introduced by King Henry the First, “who ordered that the ulna or ancient ell, which corresponds to the modern yard, should be made of the exact length of his own arm, and that the other measures of length should be based upon it. This standard has been maintained without any sensible variation, and is the identical yard now used in the United States, and is declared by an act of Parliament, passed in June, 1824, to be the standard of linear measure in Great Britain.”* The clause in the act is as follows: —

“From and after the first day of May, 1825, [subsequently extended to the first of January, 1826,] the straight line, or the distance between the centres of the two points in the gold studs in the straight brass rod now in the custody of the clerk of the House of Commons, whereon the words and figures ‘Standard Yard, 1760,’ are engraved, shall be the original and genuine standard of length or lineal extension called a yard; and the

* *Hunt’s Merchant’s Magazine*, Vol. IV. p. 334.

same straight line, or distance between the centres of the said two points in the said gold studs in the said brass rod, the brass being at the temperature of sixty-two degrees by Fahrenheit's thermometer, shall be and is hereby denominated the 'Imperial Yard,' and shall be and is hereby declared to be the unit and only standard measure of extension, wherefrom or whereby all other measures of extension whatsoever, whether the same be lineal, superficial, or solid, shall be derived, computed, and ascertained; and that all measures of length shall be taken in parts or multiples or certain proportions of the said standard yard; and that one third part of the said standard shall be a foot, and the twelfth part of such foot shall be an inch; and that the pole or perch in length shall contain five and a half such yards, the furlong two hundred and twenty such yards, and the mile one thousand seven hundred and sixty such yards."

And the act further declares, that "if at any time hereafter the said imperial standard yard shall be lost, or shall be in any manner destroyed, defaced, or otherwise injured, it shall be restored by making, under the direction of the Lords of the Treasury, a new standard yard, bearing the proportion to a pendulum vibrating seconds of mean time in the latitude of London in a vacuum and at the level of the sea, as 36 inches to 39.1393 inches."

The event contemplated by the last clause of the act actually happened in less than ten years after its passage, for the standard was destroyed by the fire which consumed the Parliament House in 1834. It was then found that this clause was entirely nugatory, and that the country was left without a legal standard; for the restoration of the lost yard could not be effected with any tolerable certainty in the manner prescribed by the act. The measurement of the seconds pendulum, which was made the basis of the peremptory enactment, was executed with extraordinary precaution and skill by Captain Kater; but this measurement was subsequently found to be incorrect, owing to the neglect of certain precautions in the determination of the length of the pendulum, which more recent experiments have shown to be indispensable. On account of these sources of error, the yard could not be restored with certainty in the prescribed manner within one five-hundredth of an inch, an amount which, although inappreciable in all ordinary measurements, is a large

error in a scientific standard. The commissioners appointed, in 1838, "to consider the steps to be taken to restore the lost standard," recommended the construction of a standard yard, and four "*Parliamentary copies*," from the best authenticated copies of the imperial standard yard which then existed. They also prescribed the manner in which the standard and the four *Parliamentary copies* should be preserved, and recommended further that authenticated copies, prepared with all the refinements of modern art, should be distributed throughout the realm, and placed in the custody of certain government officers. The recommendations of this commission have in general been followed,* and by an act of Parliament, which received the royal assent July 30, 1855, the restored standard yard was legalized.

The actual standard of length of the United States is a brass scale eighty-two inches in length, prepared for the survey of the coast of the United States, by Troughton of London, in 1813, and deposited in the Office of Weights and Measures at Washington. The temperature at which this scale is a standard is 62° Fahrenheit, and the yard measure is between the 27th and 63d inches of the scale.† From recent comparisons of this scale with a bronze copy of the new British standard, presented to the United States by the British government, it appears that the British standard is shorter than the American yard by 0.00087 of an inch, — a quantity by no means inappreciable. Carefully adjusted copies of the United States standard yard have been prepared, by the order of Congress, under the direction of Professor A. D. Bache, Superintendent of Weights and Measures, and distributed to the different States of the Union; but up to 1859 the standard had not been defined by any act of Congress. The subdivisions and multiples of the yard are given in Table I. at the end of this volume, with their respective numerical relations.

(11.) *Units of Surface and of Volume.* — All the English units of surface are squares whose sides are equal to the units of length, with the exception of a few, which, like the perch or the acre, are used in the measurement of land, and in other coarse measurements. The square inch is the most convenient unit of

* Account of the Construction of the New National Standard of Length and of its principal Copies. By G. B. Airy, Esq., Astronomer Royal. Philosophical Transactions of the Royal Society of London, Vol. CXLVII. p. 621.

† Report of the Secretary of the Treasury on Weights and Measures, 34th Congress, 3d Session. Ex. Doc. No. 27, 1857.

surface for scientific purposes. The circular inch is also sometimes used by engineers.

When volume can be calculated from linear measurements by the principles of Geometry, it is usual to estimate it in *cubic yards*, *cubic feet*, or *cubic inches*, and it is in this way that earthwork and masonry are measured. In measuring the volume of gases, liquids, and of many varieties of solids, however, an arbitrary unit is more frequently employed. Several such units, entirely independent of each other, were formerly used in different trades; but the Imperial Gallon, established by an act of Parliament, has been substituted for all other arbitrary measures of volume. It is equal to 277.274 cubic inches, and contains ten avoirdupois pounds of water at 62° of the Fahrenheit thermometer. A table showing the relations of the units both of surface and of volume, will be found in connection with the table of linear measure.

FRENCH SYSTEM OF MEASURES.

(12.) *History*.—The decimal metrical system of France originated with her Revolution. “It is one of those attempts to improve the condition of human kind, which, should it ever be destined ultimately to fail, would in its failure deserve little less admiration than in its success.”* Previous to the Revolution, the metrical system of France was even more complex than that of England, almost every province having distinct standards of weight and measure of its own, — a condition of things which was productive of the most serious inconveniences in trade and commerce. The first effective movement to reform this extreme diversity was made by Talleyrand in the Constituent Assembly of 1790, and the new system was developed by a commission of members of the Academy of Sciences, consisting of Borda, Lagrange, Laplace, Monge, and Condorcet. In their report, which appeared in the following year, they proposed that the *ten-millionth part of the quadrant of a meridian of the globe* should be adopted as the basis of a new metrical system, and called a *Metre*; that the subdivisions and multiples of all measures should be made on the decimal system; that, in

* Report upon Weights and Measures, by John Quincy Adams, which may be consulted for a full history of this subject.

order to determine the metre, an arc of the meridian, extending from Dunkirk to Barcelona, six and a half degrees to the north and three degrees to the south of the mean parallel of 45° , should be measured, and that the weight of a cubic decimetre of distilled water at the temperature of melting ice should be determined and adopted as the unit of weight. They also proposed a new subdivision of the quadrant into one hundred degrees, the degree into one hundred minutes, and the minute into one hundred seconds. This report was accepted, and the execution of the great work was intrusted to four separate commissions, including the names of the most celebrated men of science of France. The measurement of the arc was assigned to Delambre and Méchain, and the determination of the weight of water to Lefèvre-Gineau and Fabbroni.

Delambre met with great difficulties in the measurement of the French portion of the arc. The work was commenced at the most violent period of the Revolution, and was repeatedly arrested by the suspicions of the people and the fickleness of the government. But, after repeated interruptions, the work was completed in 1796, when the whole of the records of the survey were submitted to a special commission, consisting of Delambre, Méchain, Laplace, and Legendre, of France, Von Swinden, of Holland, and Trallés, of Switzerland, who found the length of the metre to be 443.259936 *lignes*.*

The determining of the unit of weight led to a most important discovery. The commission discovered that water was most dense, not, as had been previously supposed, at the temperature of melting ice, but at a temperature nearly five degrees of the centigrade scale higher. They therefore determined the weight of a cubic decimetre of distilled water at its greatest density, and not, as had been first proposed, at 0° ; and to this weight was given the name of *Kilogramme*. On the 19th of August, 1798, the original metre and kilogramme were presented, with an address, to the two councils of the legislative body.

In order to avoid sources of error which might arise from the ellipticity of the earth, the measurement of the arc from Dunkirk to Montjouy (Monjuich), near Barcelona, was subsequently extended by Biot and Arago, in accordance with the original design

* The French standard then in use.

of Méchain, to Formentera, one of the Balearic Isles, so as to comprehend an arc of more than twelve degrees between the extreme stations, which would be almost exactly bisected by the parallel of 45° ; it being well known that from the length of any given arc which is bisected by the parallel of 45° may be deduced a length of a quadrant of a meridian, and therefore of the metre, which would be independent of the earth's ellipticity. The observations of Biot and Arago were calculated by the same methods prescribed by Delambre in the previous survey, and the result appeared to verify the accuracy both of the method and of the original work, since the length of the metre, which was the result of the entire arc between Dunkirk and Formentera, was found to be almost identical with that which had been previously determined. The perfect accuracy of the base of the French metrical system seemed thus to be established; but, unfortunately, later examinations have not verified this conclusion.

In the year 1838, Puissant, who was then engaged in constructing the *Carte Géographique de la France*, announced that there existed an important error in the calculated length of the arc of the meridian on which the length of the metre was based, and that the calculated metre differed from the one ten-millionth part of the quadrant — the metre by definition — by $\frac{1}{5590}$ of the whole; and that the provisional metre hastily adopted on the 1st of August, 1793, during the heat of the Revolution, and based on an old measurement of an arc of the meridian by Lacaille, was in reality more accurate than that which was established by the labors of the great commission. Puissant's results were subsequently verified by a careful re-examination of the calculations of the commission, when it appeared that the error he had detected, great as it was, resulted from two greater errors, which had in part balanced each other in the final result. It was not, however, thought best to correct the length of the actual metre, and it still remains the same as that adopted by the commission. Thus, then, it appears that the metre of France is no less an arbitrary standard of measure than the English yard, and that, like the last, if destroyed, it cannot be restored in conformity to its definition. Like all other results of human labor, it bears the mark of imperfection and fallibility; and the singular history*

* See the Edinburgh Review, Vol. LXXVII. page 228, for a full account of this subject.

of the work teaches most impressively the limitation and uncertainty of the best human powers of observation and reasoning.

(13.) *Subdivisions and Multiples of the Metre.*—The subdivisions and multiples of the metre are all decimal. The names of the multiples are derived from the Greek numerals, and those of the subdivisions from the Latin. They are as follows :—

Measures of Length.

Kilometre = 1000 metres.	Metre (m.)	= 1.000 metre.
Hectometre = 100 “	Decimetre (d. m.)	= 0.100 “
Decametre = 10 “	Centimetre (c. m.)	= 0.010 “
Metre = 1 “	Millimetre (m. m.)	= 0.001 “

In this work, the abbreviations in the table will be used to designate these units of length.

(14.) *Units of Surface and of Volume.*—The French units of surface are squares whose sides are equal to the units of length. They are named squares of these units, and will be designated by the abbreviations as above with an exponent 2; thus, $5 \overline{\text{m}}^2$ stands for five square metres, and $3 \overline{\text{c.m.}}^2$ for three square centimetres. The common French measure of land is the *square decametre*, which is called an *are*, and the names of its decimal multiples and subdivisions are formed like those of the metre.

The units of volume are in like manner cubes of the units of length, and are named cubic metres, cubic centimetres, etc. They will be designated as before, using the exponent 3; thus, $5 \overline{\text{c.m.}}^3$ stands for five cubic centimetres. The cubic decimetre is the common measure of liquids, and is called a *litre* = $0.001 \overline{\text{m}}^3$. So also the cubic metre, which is the measure for bulky materials, such as fire-wood, has received the separate name *stère*. Both the litre and the stère have decimal multiples and subdivisions named like those of the metre. The very simple decimal relations of the French system render it exceedingly valuable in all scientific calculations, and it will therefore be exclusively used in this book. The relation between the French and English units is given in Table I., and with the aid of the annexed logarithms the reduction from one to the other can easily be made. A similar table has also been added, which gives the means of reducing the metre to several of the most important standards in use on the continent of Europe.

The methods of determining *approximately* length, surface, and solidity, by means of the units of measure just described, are known to all who have studied Geometry, and need not therefore be described. When great accuracy, however, is required, as in most scientific investigations, these methods become less simple, and cannot be fully understood until the student is familiar with the action of heat on matter. This will be described in the chapter on Weighing and Measuring.

(15.) *Density and Mass.*—The idea of volume involves that of *density*, since a given volume may be filled with a greater or a less amount of matter. The amount of matter contained in a cubic centimetre of hydrogen gas, for example, is many thousand times less than that which fills a cubic centimetre of gold. As used in Physics, the word *density* means the amount of matter contained in the unit of volume. This quantity will always be represented by D .

The amount of matter which a body contains is termed its *mass*, and is represented by M . For example, the amount of matter which the sun, the earth, a locomotive, a cannon-ball, or a grain of sand contains, is called the *mass* of that body. When the body is homogeneous, there is a very simple relation between its mass and its density. Its density, as we have seen, is the amount of matter which one cubic centimetre of the body contains. Its mass is the amount of matter which the whole body contains. If, then, we represent by V the volume of the body, that is, the number of cubic centimetres which it occupies, it follows that

$$M = D V. \quad [1.]$$

This, translated into ordinary language, means that the amount of matter which a body contains is equal to the amount of matter which one cubic centimetre of the body contains, multiplied by the number of cubic centimetres which the body occupies. The mass of a body is determined from its weight; for it will be hereafter proved that the weight of a body is proportional to the amount of matter it contains. It must, however, be carefully kept in mind, that weight, although proportional to mass, is not the mass, just as the arc of a circle is an entirely different quantity from the angle which it measures.

From equation [1] we obtain $D = \frac{M}{V}$; that is, the density is the mass of the unit of volume, or, as above, the amount of

matter in the unit of volume. In order to estimate mass and density, we assume a certain amount of matter as a unit of mass and compare all other amounts with it. When we say that the mass of a given volume of iron is 10, we mean that the amount of matter it contains is ten times as great as the amount of matter contained in this assumed unit of mass. In like manner, when we say that the density of mercury is equal to 1.386, we mean that one cubic centimetre of mercury contains 1.386 times as much matter as the unit of mass. In every case, the numbers expressing mass and density stand for units of mass. The unit of mass is derived from the unit of weight, as will be explained in the section on Gravitation.

The terms *Mass* and *Density* will be constantly used throughout this work, and their meaning should, therefore, be clearly impressed upon the mind.

(16.) *Impenetrability*.—Matter not only occupies space, but it also resists, with differing degrees of force, any attempt to reduce it into a smaller volume. Thus, one litre of air can be made to occupy a volume, so far as we can see, indefinitely smaller, but only by great mechanical force. This resistance which all bodies offer to any attempt to condense them, is termed *Impenetrability*.

PROBLEMS.

1. What is the length of one degree on the meridian at the latitude of 45° in French linear measure?

2. The latitude of Dunkirk was found by Delambre to be $51^\circ 2' 9''$; that of Formentera, as determined by Biot, is $38^\circ 39' 56''$. What is the distance between these parallels in metres?

3. The distance between the parallels of Dunkirk and Formentera, as determined by triangulation, is 730,430 *toises* of 864 *lignes* each. What is the length of a metre in fractions of a toise, and in lignes?

4. The equatorial and polar diameters of the globe are to each other in the proportion of 299.15 to 298.15. What is the length of each in metres?

5. Had the decimal division of the circle mentioned on page 15 been adopted, what would have been the length of one degree, one minute, and one second in metres?

6. To how many cubic centimetres do five litres correspond? To how many do 3.456 litres, 0.0034 litre, and 5.674 litres correspond?

7. To how many cubic metres do 564.82 litres, 3240.85 litres, 0.675 litre, and 0.032 litre correspond?

8. A box, measuring ten centimetres in each direction, will hold how many litres, and what portion of a cubic metre?

9. Reduce, by means of the table at the end of the book, —
- 30 inches to fractions of a metre.
 - 76 centimetres to English inches.
 - 36 feet to metres.
 - 10 metres to feet and inches.
10. Reduce, by means of the table at the end of the book, —
- 8 lbs. 6 oz. to grammes.
 - 7640 grammes to English apothecaries' weight.
 - 45 grains to grammes.
11. Reduce, by means of the table at the end of the book, —
- 4 pints to litres and cubic centimetres.
 - 5 gallons to litres and cubic centimetres.
 - 5 litres to English measure.
 - 4 cubic centimetres to English measure.

MOTION.

(17.) *Position.* — We conceive of a body, not only as occupying a certain portion of space, but also as existing in space, and therefore as being in a determinate *Position* with reference to other bodies. A book, for example, not only fills a certain amount of space, but also holds a certain position with reference to the surface of the table on which it lies, or with reference to the walls of the room in which the table stands. If we select a point of that book, its position on the table can easily be defined by measuring its distance from each of two adjacent edges of the table along a line parallel to the other of the two edges, and its position in the room can, in like manner, be defined by measuring its distance from two *adjacent* walls and the ceiling along lines parallel to the three edges formed by the meeting of these three surfaces. This is the method most commonly used in Geometry of defining the position

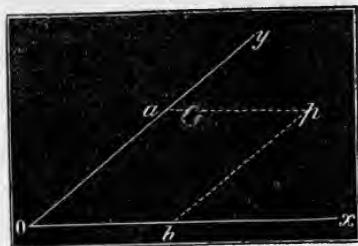

Fig. 1.

of a point. The distances which determine the position of a point are called *co-ordinates*, and the edges and surfaces to which the position is referred are called *co-ordinate axes* and *co-ordinate planes*. In Fig. 1, the position of the point *p* is determined by the

distances $pb = b$ and $pa = a$ from the two co-ordinate axes ox and oy ; and in Fig. 2, the position of the same point is determined by the distances $pc = c$, $pb = b$, and $pa = a$ from the planes xy , xz , and yz . In Part II. of this work, the use of co-ordinates will be fully illustrated in their application to the study of crystallography.

The position of points on the surface of the globe is referred to the equator and the meridian of Greenwich. In this case, however, the position is not defined by

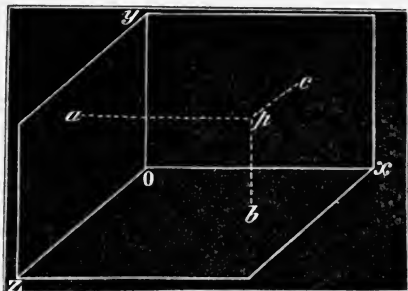

Fig. 2.

the distance from these planes, as in the example just taken, but by the latitude and longitude; the first being the angular distance of the place from the equator measured on its own meridian, and the second the angle made by its meridian with that of Greenwich. In like manner, the position of a body in the solar system is defined by stating its distance from the sun and its angular position with reference to the ecliptic and the vernal equinox, to which its heliocentric latitude and longitude are referred.

(18.) *Mobility*. — The idea of position necessarily involves that of *change of position*, which we call *motion*. We cannot, for example, conceive of the book as having a definite position on the table, without also connecting with it the idea that its position could be changed, or, in other words, that it could move. A body is said to be moving when it is constantly changing its position with reference to the co-ordinate lines to which its position is referred; and when no such change is taking place, it is said to be at *rest*. Rest and motion are relative terms; for absolute rest is not known in nature. Every body on the surface of the globe partakes, not only in a motion of revolution round the axis of the earth, but is also moving round the sun, and perhaps accompanying the sun in its revolution round a more distant centre. All known matter is in motion, and when, in any case, we say that it is at rest, we merely mean to assert that it is at rest with reference to certain lines or planes, which were arbitrarily assumed for co-ordinates. A body on the deck of a steamboat may be at rest with reference to the boat, but in rapid motion with

reference to the earth. In like manner, a body on the surface of the globe, which is said to be at rest because it is not changing its position with reference to the equator and first meridian, is yet in very rapid motion with reference to the ecliptic and the vernal equinox. So, on the other hand, a body may appear to be in rapid motion, and yet at rest with reference to the earth or the sun. For example, a ship, which is sailing through the ocean at the rate of ten kilometres an hour, while the ocean current is flowing at the same rate in the opposite direction, is at rest with reference to the earth, although it would appear to be in motion to persons on board the ship. Again, any point on the surface of the globe at the latitude of 50° is moving from west to east, in consequence of the rotation of the globe on its axis, about 289 metres each second, but is, relatively to the surface of the globe, at rest. If a cannon-ball is, at the same latitude, moving 289 metres each second from east to west, it will appear to be in rapid motion to an observer at this point, while it is at rest with reference to the sun.

Experience teaches us that a body may move on the surface of the globe with equal readiness in any direction, and therefore that this motion is not influenced by the motion of the earth itself. The same amount of gunpowder which would drive the cannon-ball 289 metres each second from west to east, would drive it with the same velocity from east to west, or in any other direction. It is evident, from these and similar considerations, that a body may partake of several motions at once, and yet that each may be entirely independent of the rest.

(19.) *Time and Velocity.*—All the phenomena of nature may be referred to motion; and the succession of natural phenomena gives us the idea of duration, or *time*. In order to measure the duration of phenomena, we select the duration of some one as our unit, and compare the duration of others with it. It is essential that our unit should be invariable, and such invariable units of time we find in the motions of the heavenly bodies and in that of the pendulum. The duration of a single oscillation of a pendulum 0.99394 m. long, at the latitude of Paris, is a *second*, the smallest unit in use, and the one which we shall have most occasion to use in this book. Therefore, when *the unit of time* is spoken of, it is always to be understood to mean one second. The duration of the revolution of the earth on its

axis is the next larger unit, which we call a *day*, and that of the revolution of the earth round the sun, the largest unit in common use, is called a *year*.

The distance passed over by a moving body in the unit of time measures its *Velocity*, which we will represent by \mathbf{v} . When, then, a body is said to have a velocity of ten metres, we merely mean that, if it continue to move at the same rate, it will pass over ten metres in each second of time.

(20.) *Uniform and Varying Motions*.—The motion of a body is said to be *uniform* when its velocity does not change. In such motion the body will pass over the same distance in each second, or, in other words, the distance passed over in uniform motion is proportional to the time. Denoting, then, by d the distance passed over, and by T the number of seconds, we have

$$d = \mathbf{v} T, \text{ or } \mathbf{v} = \frac{d}{T}, \text{ and } T = \frac{d}{\mathbf{v}}. \quad [2.]$$

We have an example of uniform motion in a railroad train moving with a constant speed.

In *varying motions*, the distances passed over in successive seconds are unequal. The body has no longer a constant velocity, and its velocity at any moment is the distance it would pass over in each second, if, with the velocity then acquired, its motion suddenly became uniform. The motion of a body may vary according to different laws. There are two kinds of varying motion which it is important to study. They are called *uniformly accelerated motion* and *uniformly retarded motion*.

(21.) *Uniformly Accelerated Motion*.—The motion of a body is said to be *uniformly accelerated*, when its velocity increases by an equal amount each second. This amount is called the *acceleration*, and will be represented by \mathbf{a} . The most familiar example of such a motion is that of the fall of a stone to the earth. Starting from the state of repose, its velocity at the end of the first second is 9.8088 m., which we may call in round numbers 10 m.; at the end of the second second, its velocity is 20 m.; at the end of the third, 30 m.; at the end of T seconds, its velocity is $10 \times T$ metres. To make the case general, if, starting from a state of rest, the body acquires a velocity each second represented by \mathbf{a} , then its velocity, \mathbf{v} , after T seconds will be,

$$\mathbf{v} = T \mathbf{a}. \quad [3.]$$

In order to find the distance passed over at the end of T seconds, we make use of the principle proved by Galileo, that this distance is the same as if the body had moved at a uniform rate with a mean velocity. In the case of a falling stone, the velocities at the end of successive seconds are, —

0"	1"	2"	3"	4"	5"	6"	7"	n"
0 m.	10 m.	20 m.	30 m.	40 m.	50 m.	60 m.	70 m. (10 n) m.

At the end of five seconds, the velocity is 50 m.; at the commencement, the velocity is 0 m. According to the principle just stated, the distance passed over is the same as if the body had moved uniformly during the five seconds with the mean velocity of 25 m. In like manner, the distance passed over between the end of the third and the end of the seventh second will be $\frac{1}{2} (30 + 70) 4 = 200$ metres. Representing, then, the acceleration of velocity during each second by v , as above, we shall have, for the distance passed over during T seconds by a body moving with a uniformly accelerated motion, and starting from a state of rest,

$$d = \frac{1}{2} (0 + Tv) T = \frac{1}{2} v T^2. \quad [4.]$$

The truth of this principle can be proved in the following way. Let us suppose the time T divided into a large number (n) of very small intervals. Each of these intervals will be represented by $\frac{T}{n}$. These intervals we will take so small, that the motion during this minute fraction of a second may be regarded as uniform, and as having the same velocity which it really has only at the end of the interval. Representing the velocity at the end of one second by v , the velocity at the end of $\frac{T}{n}$ seconds will be, by [3], $\frac{T}{n} v$; the velocity at the end of $2 \frac{T}{n}$ seconds will be $2 \frac{T}{n} v$; at the end of $3 \frac{T}{n}$ seconds, $3 \frac{T}{n} v$, etc.

Regarding this velocity as uniform during the interval, we have, by equation [2], for the distance passed over during the first interval, the value $d_1 = \frac{T^2}{n^2} v$. In the same way, we shall find, for the second interval, $d_2 = 2 \frac{T^2}{n^2} v$; for the third, $d_3 = 3 \frac{T^2}{n^2} v$; and for the last, $d_n = n \frac{T^2}{n^2} v$. The space passed over during the whole time T will be equal to the sum of these values.

$$d = \frac{T^2}{n^2} v + 2 \frac{T^2}{n^2} v + 3 \frac{T^2}{n^2} v + \dots + n \frac{T^2}{n^2} v ;$$

or,

$$d = \frac{T^2}{n^2} v (1 + 2 + 3 + 4 + \dots + n).$$

The quantity within the parenthesis, being the sum of the terms of an arithmetical progression, is equal to $\frac{1}{2} (n + 1) n$; and substituting this value, we obtain,

$$d = \frac{1}{2} v T^2 + \frac{v T^2}{2n}.$$

This value of d will be the more accurate the smaller are the intervals of time, or the larger the number into which T is divided; and it will be absolutely accurate when the number is infinitely large. In this case $n = \infty$, and the last equation becomes the same as [4],

$$d = \frac{1}{2} v T^2. \quad [5.]$$

For another time T' , we should have $d' = \frac{1}{2} v T'^2$, and, comparing the two equations,

$$d : d' = \frac{1}{2} v T^2 : \frac{1}{2} v T'^2 = T^2 : T'^2 ;$$

that is, *in a uniformly accelerated motion, the distances passed over by a moving body starting from a state of rest are proportional to the squares of the times employed.* By substituting in [5] the value of T obtained from [3], it gives,

$$d = \frac{v^2}{2v} ; \quad [6.]$$

for another velocity v' , we should have $d' = \frac{v'^2}{2v}$, and comparing this equation with the last,

$$d : d' = \frac{v^2}{2v} : \frac{v'^2}{2v} = v^2 : v'^2 ;$$

which shows that, *in a uniformly accelerated motion starting from a state of rest, the distances passed over by a moving body are proportional to the squares of the final velocities.* By transposition we obtain from [6],

$$v = \sqrt{2v d} ; \quad [7.]$$

which is an expression for the final velocity in terms of the distance passed over, and the constant increment of velocity for each second.

Returning to the previous illustration, if we represent by a the distance through which a stone falls in the first second, we can easily find the following values for the distances it will fall through during each succeeding second, and also for the whole distance it will have fallen through at the end of each second.

	1''	2''	3''	4''	5''	6''	7''	n''
Successive distances,	a	$3a$	$5a$	$7a$	$9a$	$11a$	$13a$	$\dots (2n-1)a$.
Whole distances,	a	$4a$	$9a$	$16a$	$25a$	$36a$	$49a$	$\dots n^2 a$.

The co-efficients in the last series are to each other as the squares of the times;—which has already been proved. Those in the first series are as the series of odd numbers, and can be deduced from the last series, by subtracting from each of its terms the one next preceding it.

(22.) *Uniformly Retarded Motion.*—When a stone is thrown vertically from the earth, its velocity diminishes by an equal amount each second, and such a motion may be said to be uniformly retarded. The velocity of the stone rapidly diminishes until it becomes zero, when for a moment it is at rest, and then it falls back to the point where it started. The law which governs the upward motion will be most readily discovered if we regard the stone as moving, at the same time, in two opposite directions; rising in the air in virtue of the initial velocity it has received, and at the same time falling to the earth in consequence of the force of gravitation (compare next section). The first is a uniform motion, and obeys the law expressed by [2]; the second is a uniformly accelerated motion, and obeys the laws expressed by [3] and [4]. Since, now, all uniformly retarded motions may be resolved in a similar way, it is evident that the velocity of the motion and the distance passed over by the moving body after a given number of seconds may be found by subtracting from the velocity and distance which would be due to the forward motion alone, the loss caused by the uniformly accelerated motion in the opposite direction. If, then, we use \mathbf{v}' to denote the initial velocity, it is evident that the residual velocity at the end of T seconds will be expressed by the equation (compare [2] and [3])

$$\mathbf{v} = \mathbf{v}' - \mathbf{v} T. \quad [8.]$$

The body will evidently come to rest when $\mathbf{v} T$ equals \mathbf{v}' ; when

$$T = \frac{\mathbf{v}'}{\mathbf{v}}. \quad [9.]$$

In the case of the stone, v is equal, as before, to about ten metres ; so that a stone thrown upwards with a velocity of one hundred metres a second would come to rest in ten seconds. At the end of five seconds its velocity would be $100 - 10 \times 5 = 50$ metres.

In like manner, the distance passed over at the end of T seconds will be the difference between the values of d in [2] and [4], or

$$d = vt - \frac{1}{2} v T^2. \quad [10.]$$

The height to which the stone of the previous example would rise in five seconds is, then, $100 \times 5 - \frac{1}{2} 10 \times 25 = 375$ metres. To find how far the uniformly retarded body will move before coming to rest, substitute in [10] the value of T given in [9], which gives

$$d = \frac{v^2}{2v}.$$

The stone will then rise to $\frac{100^2}{20} = 500$ metres, before it begins to fall.

(23.) *Compound Motion.* — It has already been stated, that a body may be moving in several directions at once, and moving with perfect freedom in each. The movements of the passengers on the deck of a vessel sailing over a calm sea preserve the same relations of direction and velocity, relatively to the different parts of the vessel, as if it were at rest. So also, the motions on the surface of the globe are not influenced by its rotation on its axis, or its motions through space. A point on the rim of a wagon-wheel partakes of the forward motion of the wagon, while it is also revolving round the axle. The actual motion of a body which is the result of two or more motions, is termed a *compound motion*; and we will now inquire what must be the path and velocity of such motions, commencing with the simplest case, where there are but two motions, and where both are uniform.

(24.) *Parallelogram of Motions.* — Let us then suppose that a body, starting from a , is moving towards m with a uniform motion, and that at the same time the line $a \epsilon$ is moving parallel to itself, and also with

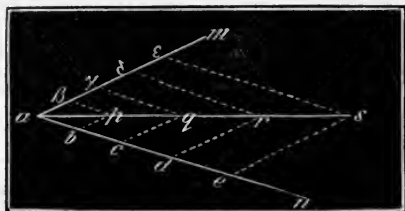

Fig. 3.

a uniform motion, towards es , the point a always keeping on the line ae . Let us also suppose that the velocities are so adjusted, that, when the body reaches the point ε , the line will have reached the position es . It is easy to show that the path described by the body is the diagonal as of the parallelogram, of which $a\varepsilon$ and es are two sides.

Lay off, in the direction am , a line, $a\varepsilon$, equal to the velocity of the moving body, and on the line an a distance, ae , equal to the velocity of the moving line. Divide both of these lines into the same number of equal parts. Each of these will be equal to the space passed over by the moving body or line in a small fraction of a second, which we may take as small as we choose. At the end of the first of these intervals, the body will evidently reach the point p ; at the end of the next, the point q ; at the end of the third, r ; and so on, until the end of the second, when it will reach the point s . By making the number of intervals larger and larger, we can prove that the body will pass successively a larger and larger number of points on the line as ; and by making the number of intervals infinite, that it will pass every point on the line, or, in other words, that it will move on the line itself.

It will be noticed, that the proof is general for any velocities when the two motions are uniform; and moreover, that the line as represents, not only the direction, but also the velocity of the moving body. Hence follows the well-known proposition, first enunciated by Galileo, and generally termed the *Composition of Velocities*:— *The velocity resulting from two simultaneous velocities is represented, both in direction and in amount, by the diagonal of a parallelogram constructed on two straight lines, which represent the direction and amount of these velocities.* The reverse of this must also be true; and any given motion may be considered as resulting from two others which stand in the same relations to it, both as regards direction and velocity, that the sides of a parallelogram do to its diagonal. Hence the converse proposition:— *A velocity in any given direction may be resolved into two others, represented both in direction and amount by the two sides of a parallelogram, of which the first velocity is the diagonal.*

As the same line may be the diagonal of an infinite number of different parallelograms, it follows that a given motion may be

composed of, or may be resolved into, an infinite number of different pairs of uniform motions.

We have considered, above, a motion as resulting from two other uniform motions; but a motion may result from three or more motions. As these motions are entirely independent of each other, we can obviously find, by the above method, what would be the result of two alone; and then, by combining this resultant with the third motion, we shall obtain a second resultant, which would be the result of three alone; and by combining the second resultant with the fourth motion, we should obtain a third resultant; — and so we can proceed until we obtain the final resultant of all the motions.

What has been proved to be true in regard to the resultant of two or more uniform motions, is also true in regard to two or more uniformly varying motions, provided the variations of both follow the same law. This truth can easily be proved in the case of two uniformly accelerated or uniformly retarded motions, by laying off, on two lines representing the directions of the motions, the spaces passed over during successive intervals of time, taken so small that the motion during each interval may be considered uniform. We can thus find the points at which the moving body will be at the end of these successive intervals, as above; and it will then be easy to prove that the resulting motion may be represented, both in direction and velocity, by the diagonal of a parallelogram, of which the two sides represent the velocities at the end of one second.

In the case where the original motion is uniform, it is easy to prove that the resulting motion is also uniform; and where it is varying, that the resulting motion varies according to the same law as its two components. Thus, in the last example, the resulting motion will be uniformly accelerated or retarded, as the case may be.

(25.) *Curvilinear Motion.* — In the cases above considered, the resulting motion is *rectilinear*; if, however, any one of the motions of which a compound motion is composed obeys a different law from the rest, the resulting motion is *curvilinear*. As the velocity of a moving body may vary according to many different laws, and as an infinite number of combinations of such varying motions may be made, an infinite variety of curvilinear motions may result. We can only consider here one, and

that one of the simplest cases, which will serve as an example of the rest. Let us, then, suppose a body moving from a to m (Fig. 4) with a uniform motion, and at the same time moving in the

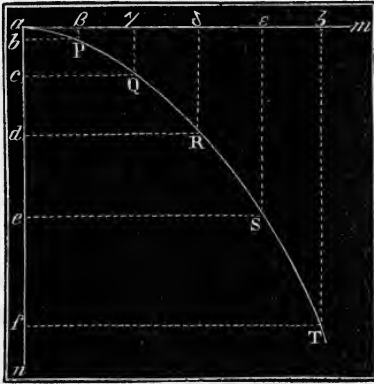

Fig. 4.

direction $a n$ with a uniformly accelerated motion. An example of such a motion would be that of a cannon-ball, fired horizontally from the embrasure of a fort, at some height above the general surface of the ground. In virtue of the projectile force, it would move horizontally along the line $a m$ with a uniform motion, while in obedience to the force of gravity it would rapidly fall to the earth, in the direction $a n$,

with a uniformly accelerated motion. To find the path of the resulting motion, let \mathbf{h} be the velocity of the uniform motion, and \mathbf{v} the acceleration of velocity of the falling body for each second. Lay off on the line $a m$ the distances $\alpha \beta, \beta \gamma, \gamma \delta$, etc., each equal to \mathbf{h} . Lay off on the line $a n$ the distances $a b, b c, c d$, etc., equal to $\frac{1}{2} \mathbf{v}, \frac{3}{2} \mathbf{v}, \frac{5}{2} \mathbf{v}$, etc., the distances through which the ball will fall in successive seconds. Draw through each of the points β, γ, δ , etc., lines parallel to $a n$, and through b, c, d , etc., lines parallel to $a m$. The points P, Q, R , etc., where the first set of lines intersect the second, are evidently points through which the ball must pass. Join these points by a curved line, and this line will represent the path of the ball. It is easy to show that this path is a *parabola*. For this purpose, let the lines $a m$ and $a n$ be the axes of co-ordinates. The co-ordinates of any point, as s , are $s e = x$ and $s \epsilon = y$; and we know that $x = \epsilon \alpha = \mathbf{h} T$, and also $y = e a = \frac{1}{2} \mathbf{v} T^2$. Equating the values of T obtained from these equations, we have, by reduction,

$$x^2 = \frac{2 \mathbf{h}^2}{\mathbf{v}} y.$$

Since $\frac{2 \mathbf{h}^2}{\mathbf{v}}$ is a constant quantity, this is the equation of a parabola, in which $4 p = \frac{2 \mathbf{h}^2}{\mathbf{v}}$.

PROBLEMS.

Velocity and Uniform Motion.

12. A locomotive runs 36 kilometres in $1^{\text{h}} 20'$. What is the velocity of the locomotive?

13. A horse trots 11 kilometres in one hour. What is his velocity?

14. A man walks 5.6 kilometres in $1^{\text{h}} 10'$. What is his velocity?

15. From the extremities, A and B , of a straight line 24,000 m. long, two bodies start at the same time. The one from A moves in the direction AB with a velocity of 2 m.; the other from B , in the direction BA , with a velocity of 3 m. At what distance from A , and after what time, will they meet?

16. From the extremities, A and B , of a straight line a m. long, two bodies start; the one from A , t'' after the one from B . The one from A moves with a velocity of c m., the one from B with a velocity of c_1 m. At what distance from A will they meet?

Uniformly Accelerated or Retarded Motion.

17. Find the space through which a body falls in $7''$, and the velocity acquired. The increment of velocity each second is $v = 9.8$ m.

18. A stone falls from the top of a tower to the earth in $2.5''$. How high is the tower when $v = 9.8$ m.?

19. On the surface of the moon, the increment of velocity of a falling body is $v = 1.654$; on the surface of the planet Jupiter, $v = 26.243$. Find the answers to the last two problems with these values.

20. A stone is let fall into a pit 100 m. deep. With what velocity will it strike the bottom of the pit? With what velocity would it strike the bottom of a similar pit on the moon, and on Jupiter?

21. A stone is projected vertically with a velocity of 50 m. How high will it rise from the earth? How high would it rise from the moon, and from Jupiter? After how many seconds will it again reach the ground in the three cases?

22. A body is projected vertically from the bottom of a tower 80 m. high, with a velocity of 48 m. In what time will it reach the top, and what will be its velocity at that time? Also, to what height above the top of the tower will it rise, and after what time will it again reach the bottom?

23. A body is projected vertically with 30 m. velocity. A second later, another body, with 40 m. velocity, is projected vertically from the same point. At what point of elevation will the two meet?

24. A cannon-ball, being projected vertically upwards, returned in $20''$ to the place from which it was fired. How high did it ascend, and what was the velocity of its projection? Solve the problem also for $v = 1.654$, and $v = 26.243$.

FORCE.

(26.) *Force*. — Matter, of itself, is incapable of changing its state, either of rest or of motion. If a body be at rest, it cannot put itself in motion; if a body be in motion, it can neither change that motion nor reduce itself to rest. Any such change must be produced by some external cause independent of the body. This quality of matter we term *Inertia*; and the external cause we term *Force*. In discussing the origin and nature of force in the introductory chapter, we used this word for the cause of all the phenomena of nature. We shall use it, in this section, in a more limited sense, as meaning “*any agency which, applied to a body, imparts motion to it, or produces pressure upon it, or causes both of these effects together.*” In studying the action of a force upon a body, we must consider three things. First, the point of the body to which it is applied, *its point of application*; secondly, *its intensity*; thirdly, *its direction*. The action of forces on bodies is the subject-matter of Mechanics. We shall only be able to consider here those elementary principles of this science which we shall have occasion to use in this book, referring the student to works on Mechanics for a full exposition of the subject.

(27.) *Direction of Force*. — When a force applied to any point of a body causes it to move, the direction of the motion is the direction of the force. If the point cannot move, the direction of the force is the direction of the pressure exerted by it, or the direction in which the point would move if it were free. *When two or more forces are applied to any point of a body, each of these produces the same effect as if it were acting alone.* This is a necessary consequence of what has already been stated, in regard to the perfect freedom with which a body may move in several directions at once. Each of these motions may be the result of a separate force, which thus acts in producing motion as if it were acting alone. Hence, also, the action of a force upon a body is not affected by its condition of rest or motion, because the result which it produces is by the above principle entirely independent of the motions which other forces have impressed upon it. For example, if a body moving with a given velocity, under the influence of a given force, is suddenly acted upon by another and equal force, in a direction at right angles to the first, it will

move in the new direction with the same velocity as if it had been previously at rest. The path it describes can be found by combining the two motions according to the principles already described.

It follows from this principle, that *a body under the influence of a force which is constant, both in direction and intensity, moves with a uniformly accelerated velocity.* That this must be the case can be seen by reflecting that, if this force imparts to the body a velocity v during the first second, it will, from the principle just stated, impart the same velocity during each succeeding second. At the end of the second second, the body will then have the velocity gained during two seconds, or $2v$; at the end of the third second, it will have the velocity gained during three seconds, or $3v$; and so on. In other words, the velocity will be proportional to the time, which is the characteristic of uniformly accelerated motions. The reverse of this also must be true; that is, *a body moving with a uniformly accelerated velocity in a straight line, must be under the influence of a force of constant intensity acting in the direction of its motion.*

If, when a body has acquired a given velocity, the force ceases to act, the body will continue to move with the same velocity and in the same direction which it had when the action of the force ceased; in other words, it will have a uniform motion, and the motion will continue until it is arrested by an equivalent force, acting for an equal time in the opposite direction. This, which is a necessary consequence of the principle of inertia, is illustrated by many familiar facts. A train of cars continues to move after the action of the steam has ceased, and until the friction of the wheels and the resistance of the atmosphere destroys the motion. Were it not for these opposing forces, a body once set in motion on the earth would continue to move indefinitely with the same velocity, and in the same direction, which it had when the force which produced the motion ceased to act. This does not admit of direct experimental illustration; because, on the surface of the earth, we can never entirely remove a body from the influence of the resistance of the air or of friction. But even here, the more completely these influences are removed, the longer motion continues; and in the heavenly bodies, where they do not exist, at least to any sensible degree, the motion is per-

petual. A uniform motion in a straight line does not, therefore, necessarily imply the existence of a force still acting; it only shows that a force has acted at some previous time.*

(28.) *Equilibrium*. — When two or more forces are acting on a body, or on a system of bodies, in such a way that they exactly balance each other's effects, they are said to be in *equilibrium*. Forces so adjusted will not communicate motion to a body at rest, or alter its motion, if already in motion. That portion of the science of Mechanics which treats of the conditions of *equilibrium*, is termed *Statics*; that part, of which the object is to determine the *motion* which a body assumes when the forces which are applied do not constitute an equilibrium, is called *Dynamics*.

(29.) *Measure of Forces*. — We conceive of forces as having different intensities, and hence as quantities, which can be expressed in numbers, selecting one of them as the unit. As, however, we only know forces through their effects, we can only compare them together by comparing their effects; that is, by comparing together the amounts of motion they cause, or the amounts of pressure they exert. Let us then seek for a measure of force in the amount of motion which it causes. In discussing this subject we can assume as axioms, — first, *that two forces are equal which will give equal velocities to equal amounts of matter in the unit of time*; secondly, *that two forces are equal which, when applied in opposite directions to any point of the same body, or to any two points situated in the line of the forces and inseparably united, leave it at rest*. The following propositions can now be easily proved.

Proposition 1. *Two constant forces, which in the unit of time impart to unequal masses of matter equal velocities, must be to each other as these masses*. Let us suppose that we have n equal masses of matter, each represented by m , on which are acting n equal forces in directions parallel to each other, each represented by f . By the axiom above, each of these masses

* This statement does not apparently agree with the principle of the introductory chapter, in which it is maintained that all phenomena imply a continuously acting cause; but it must be remembered that rest and motion are merely relative terms, and that the last is as much a state or condition of matter as the first. Any change of condition, whether from rest to motion, from motion to rest, or from one mode of motion to another, implies the intervention of some force; but the mere continuance in a given condition implies a continuously acting cause only so far as such a cause is implied by the continued existence of all created things.

will receive the same velocity in the unit of time ; they will, therefore, all move in the same direction and with the same velocity, and must preserve the same relative position. We may then regard them as united in a single body, whose mass is equal to $n \times m$, on which is acting a force equal to $n \times f$. Hence it follows, that the force $n \times f$ will give to the mass $n \times m$ the same velocity that the force f will give to the mass m . It is evident that

$$n \times f : f = n \times m : m.$$

To make this proof more general. Let M and M' represent the two masses of matter, which we will suppose to be commensurable, and let m be their common measure ; so that

$$M = n m, \quad \text{and} \quad M' = n' m.$$

Represent by f the value of the force which will impart to m the given velocity in the unit of time ; then, by what precedes,

$$\begin{array}{ccccccc} n f & \text{will give the same velocity to} & n m, & \text{or} & M, & \text{and} & \\ n' f & \text{“ “ “ “ “ “} & n' m, & \text{or} & M'. & & \end{array}$$

Represent $n f$ by F , and $n' f$ by F' , and we have

$$n f : n' f = n m : n' m, \quad \text{or} \quad F : F' = M : M', \quad [11.]$$

which was to be proved. If the masses are not commensurable, we can take m infinitely small.

Proposition 2. *Two constant forces, which in the unit of time impart to equal masses of matter unequal velocities, must be to each other as these velocities.* Represent the two forces by F and F' , which we will suppose to be commensurable, and let f be their common measure ; so that $F = n f$, and $F' = n' f$. Represent also by v and v' the velocities which these forces respectively impart to the common mass, M , in the unit of time. The force f will be capable of imparting to M a velocity, which we will represent by v'' . It follows now, from the last proof,

$$\begin{array}{l} \text{that } F = n f \text{ will impart to } M \text{ a velocity } n v'' = v, \text{ and} \\ \text{that } F' = n' f \text{ “ “ “ “ } n' v'' = v'; \end{array}$$

hence,

$$n f : n' f = n v'' : n' v'', \quad \text{or} \quad F : F' = v : v'. \quad [12.]$$

Proposition 3. *Two constant forces are to each other as the products of the masses by the velocities which they impart to these masses in the unit of time.* Let F and F' be the two forces

acting on the masses M and M' , and imparting to them the velocities v and v' in the unit of time. Represent by f a force which imparts to the mass M the velocity v in the unit of time. F and f are, then, two forces which, in the unit of time, impress on equal masses, M and M , unequal velocities, v and v' ; hence, from Proposition 2,

$$F : f = v : v'.$$

Moreover, f and F' are two forces which impress on unequal masses, M and M' , equal velocities, v and v' ; hence, from Proposition 1,

$$f : F' = M : M'.$$

Multiplying the two proportions, term by term, we obtain

$$F : F' = M v : M' v', \quad [13.]$$

which was to be proved.

In order to measure a force, we have then only to select some one force for our unit, and, by the principles of the above propositions, compare all other forces with it. We will then assume, as the *unit of force*, that force which, acting on the unit of mass during one second, will impress upon it a velocity of one metre, or that force which causes an *acceleration* of one metre in the velocity of the unit of mass each second. If then a given force, F , acting during one second, impresses on a given mass of matter, M , a velocity, v , we can easily find the relation it bears to the unit of force by the above proportion,

$$F : F' = M v : M' v'.$$

If F' is the unit of force, then, by definition, M' and v' are both equal to unity; and the proportion gives

$$F = M v. \quad [14.]$$

It will be remembered (21), that the quantity v is termed technically the *acceleration*. Hence, *the measure of a force is the product of the mass moved by the acceleration*. For example, if the mass moved is equal to four units of mass, and the acceleration is equal to six metres, the intensity of the force is equal to twenty-four; that is, the intensity of the force is twenty-four times as great as the unit of force.

If a constant force continues to act upon a body during a given time, it imparts to it each second, as we have seen, as much velocity as it gave to it the first. This velocity we have called the

acceleration, and represented by v . At the end of T seconds the velocity is Tv , which has been represented by \mathfrak{v} . If now the force ceases to act, the motion becomes uniform, and the body continues to move with the velocity $\mathfrak{v} = Tv$. In order to stop this motion, it would be necessary to apply to the body, in an opposite direction, a force of the same intensity, for an equal time. If M represents the mass of the body, Mv represents the intensity of the original force; and hence it would require a force of the intensity Mv acting during T seconds to destroy the motion. Evidently, however, the same effect could be produced by a force of T times the intensity, acting for one second. The intensity of this force would be

$$T M v = M \mathfrak{v}. \quad [15.]$$

Hence the product of the mass of a body by its velocity represents the intensity of a force which, acting during one second, will bring the body to rest. This product is usually called the *momentum* of a moving body. We say, for example, that a body whose mass is equal to five units, and which is moving with a velocity of four metres, has a *momentum* equal to 20; and we mean by this, that it would require a force twenty times as intense as the unit of force, and acting for one second in a direction opposite to that of the motion, to bring the body to rest. The momentum is also frequently called the *moving force* of the body, because it not only represents the intensity of the force required to overcome its motion, but also because the body itself would exert a force of this intensity against any obstacle tending to resist its motion. In this view, momentum may be regarded as representing the accumulated intensity of force in a body; the product Mv representing the intensity of force in a body after one second; the product $M\mathfrak{v}$ representing the accumulated intensity after T seconds.

It must be carefully noticed, that we have considered in this section solely the measure of the *intensities* of forces, and not the measure of their *quantities*. The *quantity* of a force, or, as this is frequently called, its *power*, is measured in a different way, as will be shown in (42). In this work, we shall have to deal almost solely with the intensities of forces, and when the measure of force is referred to, it must be always understood to mean the measure of its *intensity*, unless the reverse is expressly stated.

COMPOSITION OF FORCES.

(30.) *Components and Resultant.*—In mechanical problems we frequently have two or more forces acting at once on the same point of a body, or on several points which are immovably united together; and it becomes important to consider what will be their combined effect. This problem, which is termed the *composition of forces*, reduces itself to that of finding the direction and amount of a single force which would produce the same motion as that resulting from the action of all the forces combined. This single force is called the *resultant*, and the forces to which it is equivalent in effect are called its *components*. It follows, from this definition, that a force is mechanically equivalent to the sum of its components, and, on the other hand, that any number of forces are mechanically equivalent to their resultant; because, as we only know forces through their effects in producing motion, any forces which produce the same motions are to us equivalent.

(31.) *Forces may be represented by Lines.*—The unit of force has been defined as that force which causes an acceleration of one metre in the motion of the unit of mass each second; and, further, it has been shown that the product of the mass moved, by the acceleration, is the number of units of force to which any given force is equivalent. If, then, we represent the unit of force by a line one centimetre long, any other force will be represented by a line as many centimetres long as the number which is obtained by multiplying the mass it moves by the acceleration it imparts each second. Moreover, since these lines may be made to represent the directions as well as the amounts of the forces, the problems of resolution of forces may be reduced to problems of geometry.

(32.) *The point of application of a force may be changed to any other point of the body on the line of the direction of the force, without altering in any respect the action of the force on the body, provided only that the two points are immovably united together.* The truth of this proposition

seems almost self-evident; for it amounts only to this,—that a given force acting in the direction AB (Fig. 5) will produce the same effect, whether it is applied



Fig. 5.

in pushing the body forward at A , or in pulling it forward from B . The following illustration may make the matter still clearer. We will assume that the force applied at A is equal to five units of force, and is in the direction AB . We will now apply two forces, each of the same value as the last, to the point B ; one in the direction AB , and the other in the direction BA , as we can obviously do, without changing the condition of the body. The second of these forces will, by the axiom of (29), exactly counter-balance the force applied at A , and we shall then have left a force of five units applied at B , and acting in the direction AB , producing an equivalent effect to that of the first force.

(33.) *Resultant of Forces in the same Straight Line.*—The resultant of a number of forces acting in the same straight line on a point of a body, is obviously equal to the sum of the forces acting in one direction less the sum of the forces acting in the opposite direction; and this resultant is in the direction of the largest sum. If, for example, we have three forces applied to the point A (Fig. 5) in the direction AB , equal respectively to 4, 6, and 7 units, and two forces in the opposite direction equal to 18 and 10 units, then the resultant force will be equal to $(4 + 6 + 7) - (18 + 10) = -11$ units, and, as the negative sign indicates, will act in the direction BA . The validity of this principle follows from the fact, that each force acts as if it were the only force acting (27). As was shown in the last section, it is unimportant whether all the forces are applied at A , or whether they are applied at different points along the line AB .

(34.) *Resultant of Forces acting in different Directions, but applied at the same Point, or Parallelogram of Forces.*—Let us suppose that we have two forces, F' and F'' , applied to the point A (Fig. 6), in the directions Ab and Ab' respectively, and let us inquire what will be their resultant. It has already been proved, that two forces acting on the same or equal masses of matter are to each other as the accelerations; or,

$$F' : F'' = v' : v''.$$

What therefore is true in regard to the two

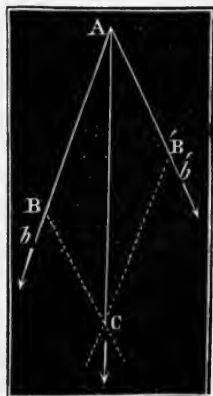

Fig. 6.

velocities must be true relatively in regard to the two forces, so that if we can, by any method, find the resultant of the two velocities, this same method will give us the resultant of the two forces. Now it has been proved (24), that the resultant of two velocities is represented, both in direction and amount, by the diagonal of a parallelogram whose sides represent the directions and velocities of the two motions; and hence it follows, that *the resultant of two forces is represented, both in direction and intensity, by the diagonal of a parallelogram whose sides represent the directions and intensities of the component forces.* The resultant of two forces can, therefore, always be found by a very easy geometrical construction. It can also be calculated; for we have, by a well-known principle of trigonometry, from Fig. 6,

$$\overline{AC}^2 = \overline{AB}^2 + \overline{BC}^2 - 2 \overline{AB} \cdot \overline{BC} \cdot \cos ABC;$$

or, since $BA B' = 180^\circ - ABC$, and therefore $\cos ABC = -\cos B A B'$, we have

$$\overline{AC}^2 = \overline{AB}^2 + \overline{BC}^2 + 2 \overline{AB} \cdot \overline{BC} \cos B A B'.$$

Representing the two component forces by F' and F'' , their resultant by F , and the angle between the components by α , the last equation becomes

$$F^2 = F'^2 + F''^2 + 2 F' F'' \cos \alpha. \quad [16.]$$

In many cases with which we meet in nature, the directions of the two components make a right angle; then the last term of [14] disappears, and the equation becomes

$$F^2 = F'^2 + F''^2. \quad [17.]$$

(35.) *Decomposition of Forces.* — As any given motion may be the result of an infinite number of pairs of motions (24), so any given force is the equivalent of an infinite number of pairs of forces. It follows from what has been proved above, that we can replace a given force acting on the point A (Fig. 7), and represented in direction and intensity by AP , by the two forces represented by either of the pairs of lines AB and AB' , AC and AC' , AD and AD' , AE and AE' , or indeed by any other pair of forces which can be represented by the sides of a parallelogram, of which the line representing the given force is the diagonal. As the sides of a parallelogram may have any

angular position whatsoever with reference to the diagonal, it follows that a given force may be decomposed into two others in any required directions. If, then, the value of a force in units, and two directions, are given, the value in units of two components in these directions can always be found.

The problem can be solved geometrically thus. Draw a line, $A C$ (Fig. 6), as many centimetres long as there are units in the given force. Draw two indefinite lines, $A b$ and $A b'$, in the required directions, making the given angles with $A C$. Finally, draw through C lines parallel to $A b$ and $A b'$. These lines will intersect the first at the points B and B' , and the length in centimetres of $A B$ and $A B'$ thus determined will be the values in units of the required forces.

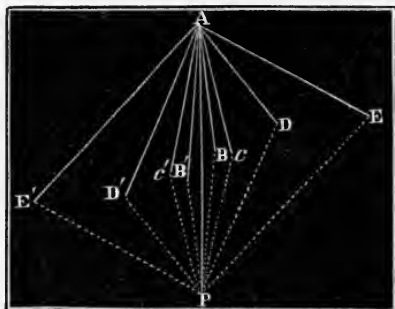

Fig. 7.

The problem can also be solved by trigonometry. Denote the value in units of the given force by F , and those of the required components by x and y . Denote also the angles which x and y are required to make with F by α and β respectively. In the triangle $A B C$, we have

$$A B : A C = \sin A C B : \sin A B C ;$$

and also, since $A B' = B C$,

$$A B' : A C = \sin B A C : \sin A B C .$$

Substituting in these proportions the equivalent values $A B = x$, $A B' = y$, $B A C = \alpha$, $A C B = \beta$, $A B C = 180^\circ - (\alpha + \beta)$, they become

$$x : F = \sin \beta : \sin (\alpha + \beta), \quad \text{and} \quad y : F = \sin \alpha : \sin (\alpha + \beta).$$

Hence,

$$x = F \frac{\sin \beta}{\sin (\alpha + \beta)}, \quad \text{and} \quad y = F \frac{\sin \alpha}{\sin (\alpha + \beta)}. \quad [18.]$$

When the two components are at right angles to each other, then $\alpha + \beta = 90^\circ$, and

$$x = F \sin \beta, \quad \text{and} \quad y = F \sin \alpha. \quad [19.]$$

The decomposition of a force into two others is very frequently applied in mechanics, in order to determine the action of a force when it does not act in the direction in which its point of application moves. The case of a canal-boat affords an illustration of

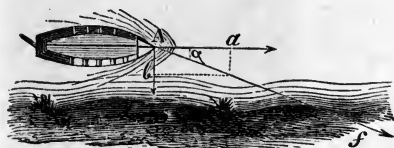

Fig. 8.

its application. The power is applied to the boat at the point *A* (Fig. 8), through the cord *AC*, which is attached at the other end to the horses on the tow-path. The boat is prevented from approaching

the bank by the action of the rudder, and can only move in the direction *Aa*. Knowing the force exerted in the direction *Af*, and the angle α , it is required to find the effective force by which the boat is propelled. Decompose the force *F* into two components, *x* in the direction *Aa*, and *y* in the direction *Ab*. The last force is balanced by the resistance of the water; but the first, acting in the direction of least resistance, that of the boat's length, propels it through the water. This force, or *x*, is equal to $F \cos \alpha$, and will evidently be larger as the value of α is smaller, or, in other words, as the towing-line is longer.

It follows, from what has been said, that a force can produce motion in any direction between its own original direction and one perpendicular to it. It cannot produce motion in a direction perpendicular to itself, because, as can be easily deduced from [18], the perpendicular resultant would in such a case be equal to zero.

In general, when the point of application is made to move in a different direction from that of the force applied to it, the effect of this force is determined by resolving the force into two others: one in the new direction, which represents the effect sought; the other perpendicular to it, which is destroyed by the resistance to the motion in that direction.

(36.) *Composition of several Forces acting in different Directions.* — The course of reasoning used above, in regard to the composition of two forces, applies equally to the composition of any number of forces acting on the same point. Hence, the resultant of several forces can be found in the same way as the resultant of several motions (24). Let us suppose, for example, that the forces acting on the point *O* (Fig. 9) are

locity or the direction of the motion resulting from the parallel forces F' and F'' , and hence will not affect our demonstration. The line $A r$, found by completing the parallelogram $A S r P$,

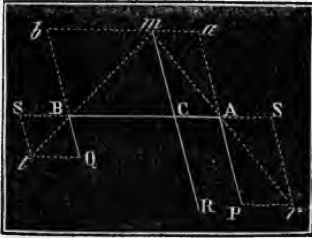

Fig. 10.

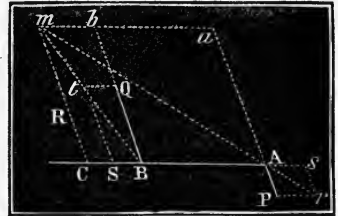

Fig. 11.

evidently represents the direction and intensity of the resultant of the two forces F' and f' , and the line $B t$ the direction and intensity of the resultant of the two forces F'' and f'' . Produce these lines until they cross, at a point m . By (32) it follows that the effect of these resultants is the same as if they were both applied directly to the point m , in the directions $m A$ and $m B$. We can now decompose each of these resultants, at the point m , into two components parallel, and hence also equal, to the original forces F' and f' , F'' and f'' . The two components parallel and equal to $A S$ and $B S$ will be applied to the point m in opposite directions; and since, by construction, $A S$ is equal to $B S$, these two components must also be equal, and will therefore neutralize each other. The two components parallel and equal to $A P$ and $B Q$ will also both be applied at the point m . In Fig. 10, where the original forces were in the same direction, the two components will be in the same direction, and will conspire to move the point m in the direction $m C$. In Fig. 11, where the original forces were in opposite directions, the two components will be in opposite directions, and will tend to move the point m in the direction of the greater component with a force equal to their difference. Hence, the final resultant will be a force in the direction $m C$, parallel to the original forces, in the one case equal to their sum, and in the other to their difference. The point of application of this force may obviously be transferred to the point C , without altering the conditions of its action.

To find the position of the point C . By construction, the sides of the triangle $A P r$ are parallel to those of the triangle $m C A$, and likewise the sides of the triangle $B Q t$ are parallel to those

of the triangle mCB , and hence their homologous sides are proportional; so that we have the proportions,

$$AC : mC = rP : AP, \quad \text{and} \quad BC : mC = tQ : BQ.$$

We have, by construction,

$$rP = AS = tQ = BS = f', \quad AP = F', \quad \text{and} \quad BQ = F'';$$

hence, by substitution,

$$AC : mC = f' : F', \quad \text{and} \quad BC : mC = f'' : F'';$$

or,

$$mC = AC \frac{F'}{f'} = BC \frac{F''}{f''}, \quad \text{or} \quad AC \times F' = BC \times F'';$$

or,

$$AC : BC = F'' : F'. \quad [20.]$$

Hence it appears that, when the two forces have the same direction, as in Fig. 10, the point of application, C , of the resultant force divides the straight line AB , which joins the points of application of the components, into two parts, which are inversely proportional to the amounts of the given forces. When, on the other hand, the forces are in opposite directions, as in Fig. 11, the point of application of the resultant is still on the same line, but beyond the point of application of the larger of the components, and at distances from the points A and B , which are, as before, inversely proportional to the intensities of the two forces. Our general result, then, is the following:—

I. In regard to the resultant of two parallel forces acting in the same direction. 1. *The intensity of this resultant is equal to the sum of the intensities of its components.* 2. *The direction is the same as the common direction of the components.* 3. *The point of application divides the line joining the points of application of the components into two parts, which are inversely proportional to the intensities of the forces.*

II. In regard to the resultant of two parallel forces acting in opposite directions. 1. *The intensity of this resultant is equal to the difference of the intensities of its components.* 2. *The direction is the same as that of the larger component.* 3. *The point of application is on the line joining the points of application of the components, produced beyond the point of application of the larger of the two, and is at distances from these points which are inversely proportional to the intensities of the given forces.*

It follows, from the nature of a resultant force, that a force applied at C , Figs. 10, 11, which is equal and opposite to the resultant of the two forces F and F' , ought exactly to balance this resultant. This obvious truth will enable us to put the validity of our conclusions to the test of experiment. The experiment may be arranged as in Fig. 12.

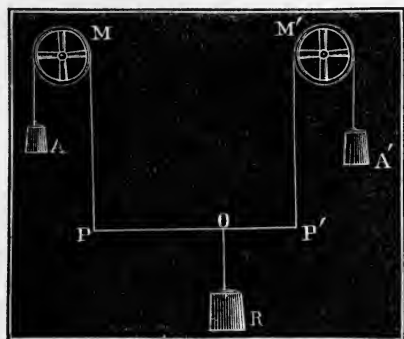

Fig. 12.

F'' of Fig. 10, while the cords indicate the directions in which the forces act. By varying the amount of the weights, and also the position of the weight R on the rod, it will be found that equilibrium can be maintained only when the conditions above stated are fulfilled. Thus, if the weight R be 20 grammes, the sum of the weights A and A' must also be 20 grammes. If A' is equal to 12 grammes, then A must equal 8, and the position of the loop on the rod must be such, that OP' shall be to OP as 8 is to 12. If, then, the distance PP' is equal to 20 c. m., the distance PO will be 12 c. m., and $P'O$ will be 8 c. m.

This same experiment also illustrates the case represented in Fig. 11, where the two components are acting in opposite directions; for, as the system of weights is in equilibrium, it follows that the force exerted by any one may be regarded as equal in intensity to the resultant of the other two; this resultant, however, acting in the opposite direction to the force exerted by the weight. Hence, we may consider the forces exerted at the points O and P' to be the components of a force equal to that exerted by the weight at P , but in a direction opposite to PM . Taking the values of the weights when the system is in equilibrium, as given above, it is evident that the amount of the resultant, and

the position of its point of application, S , are the same as would be found by the rule; for, in the first place, the weight A is equal to the difference of the two weights R and A' , and, in the second place, the distances PO and PP are inversely proportional to the values of the two weights R and A' .

(38.) *Couples.* — When the two parallel forces are exerted in opposite directions, there is one set of conditions which presents a case of peculiar interest; and that is, when the two components are equal. In this case, the value of the resultant is evidently equal to zero; and, moreover, the point of application is at an infinite distance from the points of application of the two equal components. The last fact follows from the proportion [20], $AC : BC = F'' : F'$. This, by the theory of proportions, may be written,

$$AC - BC : F'' - F' = AC : F'' = BC : F';$$

or, substituting (see Fig. 11) $AB = AC - BC$, and $F = F'' - F'$,

$$AB : F = AC : F'' = BC : F'.$$

Hence,

$$AC = \frac{AB \times F''}{F}, \quad \text{and} \quad BC = \frac{AB \times F'}{F}. \quad [21.]$$

When the two components are equal, the resultant $F = 0$, and both the distances AC and BC become equal to infinity. In this case, therefore, there is no single resultant, and therefore no tendency to produce in a body any progressive motion. Such a system of forces is termed a *couple*, and its tendency is to make the body rotate. The theory of couples is of great importance in mechanics; but as we shall not have occasion to apply it in this work, we shall not dwell upon it.

(39.) *Composition of several Parallel Forces.* — We can evidently find the resultant of several parallel forces, by combining them two by two, as in the case of forces acting in different directions. In Fig. 13, the points $m, m', m'',$ and m''' are the points of application of the parallel forces $F, F', F'',$ and F''' , all acting in the same direction. In order to find a common resultant, we first combine F with F' ; let o be the point of application of the first resultant. We next

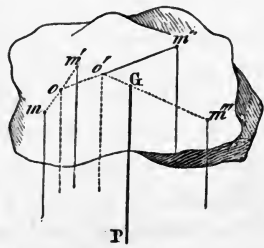

Fig. 13.

combine the first resultant with F'' , and let o' be the point of application of the second resultant. Lastly, we combine the second resultant with F''' , and we shall then find a final resultant of all the forces. This is evidently equal in amount to the sum of all the components, and its point of application will be on the line $o' m'''$, at an intermediate position between the two points, which may be determined by means of the proportions given above.

Where all the parallel components are not in the same direction, we combine each set separately, and thus obtain two partial resultants, acting in opposite directions. If these are equal, we shall have a *couple*, and no final resultant. If they are not equal, we can find a resultant by the method already described.

(40.) *Centre of Parallel Forces.* — By referring to Figs. 10, 11, and the demonstration following, it will be seen that the position of the point C does not depend on the common direction of the forces represented by AP and BQ , but only on their relative intensities. If we suppose these components to revolve round their points of application, A and B , the resultant will still pass through C in any position they may assume, provided only that they remain parallel. Moreover, it will be seen that the point of application of the resultant, which we transferred for convenience from m to C , may be at any point on the line of its direction. In other words, it is not fixed by the conditions of the problem, except so far as this, that it must be on the line mCR . It follows, then, that if, in the system of parallel forces of Fig. 13, we suppose the components to revolve about their points of application, their resultants will always pass through the point G , provided only that they remain parallel. In Fig. 14, all the components have been revolved through an angle equal to $P'GP$. The direction of the resultant has changed from $P'G$ to PG , but it still passes through the point G . In the position of the components represented by Fig. 13, the point of application may be at any point of the body on the line GP which corresponds to the line $G P'$ of Fig. 14. In the second position of the components in Fig. 14, it may be at any point on the line GP . The point G , in

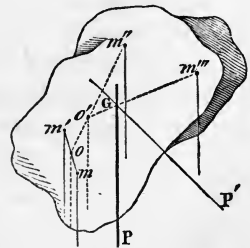

Fig. 14.

which all the successive directions of the resultant intersect when its components revolve about their points of application, is called the *centre of parallel forces*. It follows, from this definition, that if the forces remain parallel, and their points of application invariable, this system of points may be turned round the centre of parallel forces without changing the point of application of the resultant; so that, if this point were supported, the system would remain in equilibrium in any position we could give it in turning it round this point.

(41.) *Action and Reaction*. — The simplest case of the action of one body upon another, is when a body in motion, which we may call M , strikes upon another at rest, which may be termed M' . If M' is free to move, it will be put in motion by the action of M , and in any case the reaction of M' , in retarding M 's motion, will be precisely equal to the action of M in communicating motion to M' . This principle, which is a necessary result of the inertia of matter, is generally expressed thus: — *Action and reaction are always equal and opposite*.

The changes in the motion and in the moving force of both bodies, which result from collision, are in general of a complicated kind, and depend on the degree of elasticity of the bodies, their form, mass, and other circumstances. To simplify the question, we shall consider the bodies as completely devoid of elasticity, and so constituted that after the collision they shall move as one body. Let us then inquire what will be the direction and velocity of the united mass after the impact.

The mass M' , being previously at rest, can have no motion save what it may receive from the mass M , and consequently must move in the same direction as the mass M moved in before the collision. Again, since bodies cannot generate or destroy motion in themselves, it follows that whatever motion the mass M' may acquire must be lost by the mass M ; and also, that the total momentum of the united masses after the collision must be exactly equal to the momentum of the mass M before it. If \mathbf{v} and \mathbf{v}' represent the velocities before and after impact, then, by (29), $M \mathbf{v}$ and $(M + M') \mathbf{v}'$ represent the momentum before and after impact; and since these are equal, we have

$$M \mathbf{v} = (M + M') \mathbf{v}', \quad \text{whence} \quad \mathbf{v}' = \mathbf{v} \frac{M}{M + M'}. \quad [22.]$$

Let us next suppose that the two bodies are both moving, and

in the same direction; the mass M with a velocity \mathbf{v} , and the mass M' with a velocity \mathbf{v}' , less than \mathbf{v} . What will be the common velocity after impact? The momenta of the two bodies are $M\mathbf{v}$ and $M'\mathbf{v}'$. Since these motions are in the same direction, they cannot be either diminished or increased by the collision, and hence the momentum of the united bodies will be $M\mathbf{v} + M'\mathbf{v}'$. If, then, \mathbf{v}'' be the unknown velocity of the united masses, we have

$$M\mathbf{v} + M'\mathbf{v}' = (M + M')\mathbf{v}'', \text{ and } \mathbf{v}'' = \frac{M\mathbf{v} + M'\mathbf{v}'}{M + M'}. \quad [23.]$$

Let us now suppose that the two bodies are both moving, but in opposite directions, and that the momentum of M is greater than that of M' . On their collision, the momentum of M' will destroy just so much of that of M as is equal to its own amount; for it is evident that equal and opposite momenta must destroy each other. The momentum left after collision must, therefore, equal $M\mathbf{v} - M'\mathbf{v}'$, and, using \mathbf{v}'' as before, we shall have

$$M\mathbf{v} - M'\mathbf{v}' = (M + M')\mathbf{v}'', \text{ and } \mathbf{v}'' = \frac{M\mathbf{v} - M'\mathbf{v}'}{M + M'}. \quad [24.]$$

In the last case, as in the first, the reaction of the mass M' is equal to the action of the mass M . The action of the mass M has consisted, first, in destroying the momentum of M' , equal to $M'\mathbf{v}'$; second, in giving to it the momentum $M'\mathbf{v}''$. The total action is therefore expressed by $M'\mathbf{v}' + M'\mathbf{v}''$. The reaction of M' has consisted, first, in destroying a portion of the momentum of M , equal to $M'\mathbf{v}'$; and second, in subtracting from the remainder of the momentum of M the amount which it has after the collision, or $M'\mathbf{v}''$. The total reaction is therefore, as before, $M'\mathbf{v}' + M'\mathbf{v}''$.

We will now suppose that the two masses are moving in different directions; M in the direction AB , Fig. 15, with a velocity

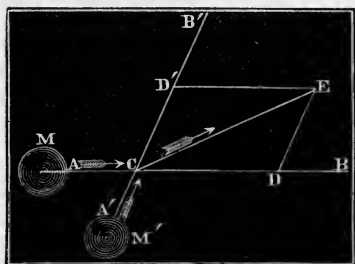

Fig. 15.

and M' in the direction $A'B'$, with a velocity \mathbf{v}' . The direction of the motion after collision, and the momentum of the united masses, can be easily ascertained by the application of the principle of the parallelogram of forces already explained (33).

Let the distance CD represent the momentum $M \mathbf{v}$, and the distance CD' the momentum $M' \mathbf{v}'$, and complete the parallelogram $CDE D'$. Draw its diagonal CE . This diagonal will then represent the direction of the common motion and the momentum of the combined masses, which is equal to $(M + M') \mathbf{v}''$. To find the velocity, it will be necessary to divide the number expressed by this diagonal by the sum of M and M' .

If, in the first case, we suppose the body M' , at rest, to be infinitely large, as compared with the moving mass M , then the value of \mathbf{v}' [22] becomes 0, which shows that the whole momentum is destroyed. This is practically the case when the moving mass impinges against a fixed obstacle, which is either very much larger than itself, or which is firmly fastened to the earth. The body must, however, be supposed to strike the surface of the obstacle from a direction at right angles to this surface. Should it strike the surface at an oblique angle, we may have a different result. Let us suppose an unelastic sphere impinges against an unyielding surface, DBC , in the direction AB , with a velocity \mathbf{v} and a momentum $M \mathbf{v}$; what would be the result? By the principle of the parallelogram of force, the momentum $M \mathbf{v}$ is equivalent to two others, one in the direction AD , and the other in the direction DB . The first will be

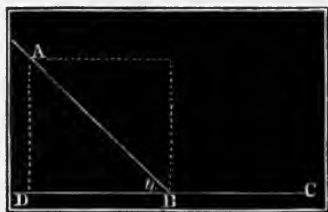

Fig. 16.

destroyed at the impact; but the second, which is equal to $M \mathbf{v} \cos \alpha$, will give the sphere a motion with the velocity $\mathbf{v} \cos \alpha$ in the direction BC . In the figure the surface is a plane, but the demonstration is true for any curved surface; in such cases, however, the plane DBC of the figure is the tangent plane to the surface at the point of contact.

It follows from the above discussion, that the loss of momentum in a mass, M , impinging on another mass, M' , when at rest, is always proportional to its velocity. This loss, as can easily be deduced from [22], is equal to

$$\mathbf{v} \frac{M M'}{M + M'}$$

a quantity whose value is evidently proportional to that of \mathbf{v} .

In all the above cases, it can easily be shown that the re-

action of the body M' is always exactly equal and opposite to the action of the body M . The same is also true, when the body M acts on the body M' through the forces of gravitation, electricity, magnetism, etc., and not by direct impact. A needle, for example, attracts a magnet with exactly the same force with which the magnet attracts the needle; and were both free to move, the magnet would move towards the needle as well as the needle towards the magnet. It is also true, when a body does not strike, but merely presses against, an obstacle, — as, for example, when a weight rests on a table, — that the reaction of the obstacle is exactly equal to the pressure.

(42.) *Power, or Living Force.* — It has been shown (14), that the intensity of a force is measured by $M v$. In the case of a locomotive, for example, M represents the whole mass of the locomotive and train, and v the acceleration of velocity imparted by the moving force each second. Were the motion not retarded by friction and other causes, its velocity would increase indefinitely, according to the laws of uniformly accelerated motion already described. In fact, however, with a given force, F , this velocity soon comes to a maximum, which it does not exceed; and so long as the force and the resistance do not vary, the train moves with a uniform motion. During this time the action of the force is exactly balanced by the resistance arising from friction and other causes, and the train moves in virtue of the momentum, $M v$, previously acquired. In the space passed over by the train each second, the counteracting forces just neutralize the force F , exerted by the moving agent during the same period. It might now be supposed, that, if this force were suddenly quadrupled, so as to equal $4 F$, the velocity would again increase until it attained to four times its present amount. In fact, however, its velocity rapidly increases, but only to twice its present amount; and then it is found that the resistance is again just balanced by the greater force. That this must be the case can be seen by reflecting, that, with a double velocity, the moving train passes over double the space each second, and therefore encounters twice as many points of resistance. Moreover, it strikes each of these points with double the velocity, and hence meets at each point twice the resistance. It therefore meets, during a second, twice as many points of resistance, and suffers at each point twice as much resistance. The resistance during a second is thus four times as great as before,

and must require four times as much force to overcome it. In order to obtain three times the velocity, it would be necessary to increase by nine times the force; and in general the force required will be proportional to the square of the velocity to be attained. What is true of the motion of a train of cars is true also of the motion of a steamboat, and indeed of all motion whatsoever by which work is or may be accomplished. Hence the ability of a force to do work is proportional, not to the velocity, but to the square of the velocity which it imparts to the moving body.

The space passed over during a second by a body starting from a state of rest, is equal to $\frac{1}{2} v$ [5]. The intensity of the force which has moved it over this space is equal to $M v$. The product of the intensity of the force by the space passed (the number of points at which it has acted), represents the work accomplished by the force. This product, equal to $\frac{1}{2} M v^2$, was named by Leibnitz *vis viva*, or *living force*, to distinguish it from force which does not produce motion, but only pressure; and which he named *dead force*. A discussion was excited by Leibnitz on this subject, in which all the mathematicians of the eighteenth century took part, and which continued for more than forty years;—one party claiming, with Leibnitz, that force was proportional to the square of the velocity; and the other, that it was proportional to the simple velocity,—the first party measuring force by the *vis viva*, and the other by the *momentum*. As not unfrequently happens in such cases, both parties were right; and their two opinions were harmonized by introducing the element of time. For, as we have seen, the *living force* represents, not the intensity of the force at any instant, which is always measured by $M v$, but the work which the force will accomplish during a second of time.

It represents, in other words, the *power* or quantity of the force, in distinction from the *intensity* of the force. The intensity of a force has been represented by F . The power or quantity of a force may be denoted by P . Hence,

$$F = M v, \text{ and } P = \frac{1}{2} M v^2. \quad [25.]$$

The word *force* is generally used in a restricted sense, as in (29), to denote only the *intensity* of any effort, the quantity of the force exerted being called *power*. These terms will be adopted with their usual sense in this volume.

PROBLEMS.

NOTE. The following problems should be solved both by geometrical construction and by trigonometry, whenever both methods are applicable.

Measure of Force.

25. A mass of matter equal to 10 units of mass receives an acceleration from a given force of 5 metres. What is the intensity of the force?

26. A mass of matter equal to 7 units of mass receives an acceleration from a given force of 9.8 metres. What is the intensity of the force?

27. A mass of matter equal to 15 units of mass receives an acceleration from a given force of 1.654 metres. What is the intensity of the force?

28. A mass of matter equal to 20 units of mass receives an acceleration from a given force of 26.243 metres. What is the intensity of the force?

Momentum.

29. A railroad train whose mass equals 1000 units is travelling with a velocity of 50 kilometres an hour. What is its momentum? How many units of force would be required to stop the train in ten minutes, supposing the moving power to cease acting?

30. A vessel whose mass equals 120,000 units is moving with a velocity of 2.25 metres. What is its momentum? How many units of force would be required to stop it in five minutes, supposing the moving power to cease acting? If the resistance of the water and other causes of retardation are equivalent, on an average, to a force of 900 units, how soon would the vessel come to rest after the moving power ceased?

Composition of Forces.

31. Three forces are acting on a point in the direction AB , equal respectively to 20, 35, and 70 units. In the opposite direction, BA , are acting four forces, equal respectively to 10, 45, 15, and 30 units. What is the intensity, and what the direction, of the resultant?

32. A force equal to 1000 units is acting on a point in the direction BA . What is the intensity of each of two components, which are to each other as 3 : 5, and both of which are acting in the same direction as the resultant? What is the intensity of each of two components, one of which acts in the direction of the resultant and the other in an opposite direction, and which are to each other in the relation of 3 : 5?

33. It is required to resolve a force equal to 441 units into six components, in the same direction as the resultant, whose intensities shall be to each other as $1 : 2 : 2^2 : 2^3 : 2^4 : 2^5$.

34. It is required to resolve a force equal to 44 units into six compo-

nents. Three of these, which have the same direction as the resultant, are to each other as 1 : 3 : 5 ; while the three others, which have an opposite direction, are to each other as 1 : 2 : 3. Moreover, the sum of the first is 5.4 times greater than the sum of the last.

35. Two forces are acting at right angles to each other on one point. The force $F' = 5$ units, and the force $F'' = 5\sqrt{3}$ units. What is the intensity of the resultant? and what is the angle which its direction makes with the direction of F' ?

36. Two forces acting at right angles on one point are equal, F' to 3 units, and F'' to 4 units. What is the intensity of the resultant? and what is the angle which its direction makes with the direction of F' ?

37. It is required to resolve a force, $F = 100$ units, into two components, F' and F'' , making with F the angles 65° and 25° respectively. What must be their intensities?

38. It is required to resolve a force, $F = 100$ units, into two components at right angles to each other, one of which shall be equal to 30 units. What must be the value of the second component? and what the values of the angles which both components make with the resultant?

39. Two forces, each equal to 100 units, act on one point. The angle made by the directions of the two forces equals 45° . What is the value of the resultant?

40. The directions of two forces, $F' = 100$ and $F'' = 50$, acting on one point, make an angle of 145° . What is the value of the resultant F ? and what are the angles which F makes with F' and F'' ?

41. It is required to decompose a force, $F = 125$, into two components, the direction of each of which shall make, with the direction of F , an angle of 25° . What will be the value of each component?

42. It is required to resolve a force, $F = 100$, into two components, F' and F'' , whose direction shall make, with the direction of F , the angles of 10° and 20° respectively. What will be the value of each component?

43. Five forces, whose directions are in the same plane, act on one point. The intensities of the forces, and the angles which their directions make with a fixed direction passing through the point of application in the same plane, are given in the following table:—

Intensity of the Forces.	Inclination to the fixed Direction.
90	50°
100	120°
120	170°
50	250°
40	290°

What is the intensity of the resultant? and what is the angle which its direction makes with the fixed direction?

44. The force $F = 100$ is resolved into two components, $F' = 100$ and $F'' = 150$. What are the angles which the directions of these components make with the direction of F ?

45. At the extremities of a straight line 44 c.m. long, two parallel forces, $F' = 15$ and $F'' = 7$, are acting in the same direction. What is the intensity of the resultant? and what is the position of the centre of the two forces?

46. At the extremities of a straight line 12 c.m. long, two parallel forces, $F' = 19$ and $F'' = 13$, are acting in opposite directions. What is the intensity of the resultant? and what is the position of the centre of the two forces?

Action and Reaction.

47. A mass $M = 20$ units, moving with a velocity of 5 m., meets a second mass $M' = 15$ units, which is at rest. What will be the velocity of the combined masses after collision? In this and in the few succeeding problems the masses are supposed to be unelastic, and so constituted that after the collision they will move on together as one body.

48. A mass $M = 500$ units, moving with a velocity of 15 m., strikes another mass $M' = 50$ units, moving with a velocity of 10 m. in the same direction. What will be the velocity of the combined masses after the collision?

49. A mass $M = 250$ units, moving with a velocity of 20 m., meets another mass $M' = 300$ units, moving with a velocity of 2 m. in the opposite direction. What will be the velocity of the combined masses after the collision?

50. A mass $M = 25$ units, moving with a velocity of 5 m., meets another mass $M' = 30$ units, moving with a velocity of 2 m. The directions of the two motions before collision make with each other an angle of 75° . What will be the velocity of the combined masses after the collision? and what will be the angle made by the direction of the resulting motion with the directions of the two motions before collision?

GRAVITATION.

(43.) *Definition.* — When bodies near the surface of the earth are left unsupported, they fall to the ground; or, if supported, they exert a downward pressure, which we term their *weight*. The cause of these phenomena is called *the force of gravity*. This force is the attraction which the earth exercises upon all bodies on or near its surface, and is only a particular case of a

general force of nature, in virtue of which all bodies in the universe attract each other, with a force depending on their masses and their mutual distances. Astronomy exhibits the grandest examples of this force, in the motions of the heavenly bodies; but it can also be shown that the same force acts upon the smallest masses of matter with which we experiment on the surface of the globe. The existence of this force of attraction between the heavenly bodies was first recognized by Newton, who discovered the law which it obeys, and gave to it the name of *Universal Gravitation*. In this work, we shall only have occasion to study those phenomena of gravitation which are caused by the attraction which the earth exerts for bodies on or near its surface. Let us then inquire what is the direction, what the point of application, and what the intensity of this force. Compare (26).

(44.) *Direction of the Earth's Attraction.* — It has been stated (27), that the direction of a force is the direction of the motion which it causes, or the direction of the pressure which it exerts. When bodies fall freely, they move on a line which, if extended, would pass through a variable point near the centre of the globe, called its *centre of attraction*. Hence, the direction of the force of gravitation is that of a line joining the centre of attraction of the earth to the point of application of the body. This direction is given by a *plumb-line*, which is merely a small



Fig. 17.

weight, generally of lead, suspended by a light and flexible thread (Fig. 17). When the weight thus freely suspended is at rest, it is easy to show that the pressure exerted by the force of gravitation is in the direction of the line. In Fig. 18, for example, this pressure must be in the direction $A C$. To prove this, suppose for a moment the force exerting the pressure were in any other direction, as $A B$; then the force in the direction $A B$ could be decomposed into two



Fig. 18.

components, one in the direction $A C$, which would be neutralized by the resistance of the point of suspension, the other in the direction $A D$, which would cause motion. As by supposition the weight is at rest, it follows that the direction of the pressure, and hence

also the direction of the force of gravitation, must be that of the plumb-line.

If several plumb-lines be placed near each other, it will be found that the lines when at rest will all be sensibly parallel to each other; because their distances apart are inconsiderable in comparison with the length of the radius of the earth. Hence the directions of the forces of gravity exerted by the earth on neighboring bodies are parallel. The direction of the plumb-line at any place is called the *vertical direction*, and the direction perpendicular to this the *horizontal direction*. The surface of a liquid at rest, as will be proved hereafter, is always horizontal, and therefore perpendicular to the plumb-line.

(45.) *Point of Application of the Earth's Attraction.* — As every particle of a body is similarly situated towards the earth, it follows that every particle must be equally attracted, and that there must be as many points of application as there are particles of the body. The action of the earth's attraction may therefore be regarded as the action of an infinite number of parallel and equal forces on as many distinct points of application. The resultant of these forces can be easily found by extending the method, discussed in (39), of finding the resultant of several parallel forces, to the case where the number of forces is infinite. As the general conclusions of (39) are independent of the number of parallel forces, it follows that the direction of the resultant of the forces of gravity, acting on the particles of a body, is parallel to the common direction of the forces, and also that the intensity of the resultant is equal to the sum of the intensities of the components.

If, for example, AB (Fig. 19) represents a mass of matter, and the small arrows pointing vertically downwards represent the directions of the gravitating forces acting on the particles composing such mass, then it follows, from what has been explained, that the resultant of all these forces will have a direction, DE , parallel to their common direction, and will have an intensity equal to their sum. The position of this resultant remains yet to be determined. The principles of mathematics enable us, in many cases, to combine together the forces acting on all the particles of a body, by extending the method used in (39), Fig. 13, and thus to calculate the exact position of the resultant; but its position can in most cases be determined more readily by experiment.

If, in Fig. 19, we suppose that the line represented by the large arrow is the direction of the resultant, it is evident that, if any point, such as C , on that line, is supported, the body will remain at rest; because the resultant of all the forces acting upon the body having the direction DE , will be expended in pressure on the fixed point C . It is not essential that the point of support should be in the body, for the same would be true for any point in the direction of the arrow DE . If, for example, D were a pin, from which the body was suspended by a thread attached to the body at any point in the line DC , then the body would still remain at rest; for, as before, the resultant having the direction DE would be expended in pressure on the pin at D . It would be different, however, with a point of support not in the direction of the arrow, such as P . If the body be connected with this point by a string attached at C , it will no longer remain at rest; for the resultant DE , acting at the point C , can be decomposed into two components, — the first in the direction of CH , which would be expended in pressure on the point P , and the second in the direction CI , which would move the body towards the vertical line. It follows, therefore, that, if a body be supported by a fixed point, it cannot remain at rest, unless the resultant of all the parallel forces which gravity exerts upon its particles passes through that point.

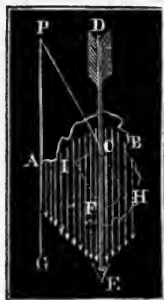

Fig. 19.

This fact gives us the means of ascertaining experimentally the position of the resultant of the parallel forces which gravity exerts upon the particles of a body. We have only to suspend it by a string attached to any point of the body, and the direction which the string assumes will be the direction of the resultant of the forces of gravity when the body is in that position. In Fig. 20, for example, the resultant of the forces which gravity exerts upon the particles of the chair is the line AB , when the chair is in the position represented in the figure. If we attach the string to another point, the chair will take another position, and the resultant will also change its position to the



Fig. 20.

line CD , Fig. 21. We should find, by experiment, that for every point of suspension there would be a different position of the chair, and also a different position of the resultant.

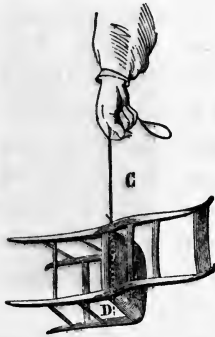

Fig. 21.

When, in any given position of a body, we have determined the position of the resultant of the forces of gravity, we have also determined a line on which the point of application of the earth's attraction must be; because, by (32), this point may be any point on the line of the resultant. The position of the line, however, will depend on the position of the body; and therefore, in order to determine it, the position of the body must be given.

(46.) *Centre of Gravity.* — When a body is turned round in any direction, it is easy to see that the lines of direction of the parallel forces, which gravity exerts on its particles, revolve about their points of application, retaining their parallelism. Hence it follows, from (40), that, in any position which the body may assume, the resultant of these forces will always pass through the same point. This common point of intersection of the resultants of the forces of gravity, in any position which the body may assume, is termed the *centre of gravity*. This point has several important relations, which we will now consider.

The centre of gravity may always be regarded as the point of application of the resultant of the forces which gravity exerts upon the particles of a body, because it has been proved, first, that the point of application may be any point on the line of the resultant; secondly, that the centre of gravity is a point common to all the resultants.

When the centre of gravity is supported, the body remains at rest. If the centre of gravity be supported on a point or axis, and the body is free to turn round such axis, the body will remain at rest in any position in which it can be placed. This result follows necessarily from the last; for, as the point of application of the resultant is fixed, the whole intensity of the forces of gravity must be expended in pressure against this point.

The whole attractive force exerted by a mass of matter may be regarded as emanating from its centre of gravity. The prin-

principle, that action and reaction are always equal and opposite, applies to the attraction of gravity exerted by one mass of matter over another. The earth is attracted, by a body near its surface, with a force exactly equal to the attraction exerted by the earth on this body. Now, since the attraction of the body must be equal and opposite to that of the earth, it follows that the resultant of the force must be on the same line with the centre of gravity, and hence may always be regarded as emanating from it. Hence, also, the attraction of the earth may be regarded as emanating from some one point, which is not, however, the same as the centre of its figure, and, moreover, it is variable.

A singular result follows from the principle of reaction above stated, since it must be, when a body falls to the ground, that the earth must rise to meet the body, — and this is true; but the extent of the motion of the earth is as much less than that of the body, as the mass of the earth is greater than the mass of the body. Representing by m the mass of the body, we have for the intensity of the earth's attraction $m v$; and representing by M the mass of the earth, we have for the intensity of the body's attraction for the earth $M v'$; and since these are equal, we have

$$m v = M v', \quad \text{or} \quad v' : v = m : M;$$

that is, the velocity acquired by the earth at the end of one second is as much less than that acquired by the body, as the mass of the body is less than that of the earth.

(47.) *Position of the Centre of Gravity.* — For the methods of calculating the position of the centre of gravity, we must refer the student to works on Mechanics, since these methods depend on the principles of the higher mathematics. The position of the centre of gravity can be found experimentally by suspending the body by a cord from two points successively, as represented in Figs. 20, 21. The point where the line of the cord produced in one position intersects the line of the cord produced in the second, is, by (46), the centre of gravity. It can thus be proved, that, when a homogeneous body has a regular form, the centre of gravity is at the centre of the figure. This is the case with the sphere, the cube, the octahedron, and the other regular solids of geometry. So also, when a homogeneous body has a symmetrical axis, the centre of gravity will be a point of this axis. Thus, in a cone, the centre of gravity is in the axis of the cone, and it can

easily be seen that, if a cone be suspended by a string from its apex, the direction of the line of suspension would coincide with the direction of the axis of the cone; because, as the matter is uniformly distributed round this axis, the gravity of its particles, acting equally on every side, will have no tendency to move it when in this position.

The centre of gravity is not necessarily in the body. Thus, the centre of gravity of a hoop is at its centre, and the centre of gravity of a hollow sphere, an empty box, or a cask, is within it.

The centre of gravity of two separate and independent bodies immovably united is a point between them. This point can be very easily determined mathematically, from principles already established.

Let A and B , Fig. 22, be the two bodies, and let a and b be their centres of gravity. Connect the two by a line. From what has



Fig 22.

been said, it follows that the attraction of the earth on this system may be regarded as the action of two parallel forces at a and b . Hence, the point of application of the resultant, the centre of gravity of the system, must be on the line ab , and must divide the line into two parts, which are inversely proportional to the intensities of the forces. It will be shown in (49) that the two forces are proportional to the masses, and hence the centre of gravity must divide the line ab into two parts which are inversely proportional to the masses of the two bodies A and B .

(48.) *Stable, Unstable, and Neutral Equilibrium.* — It is a necessary consequence of what has been said, that the centre of gravity of a body has always a tendency to move into the lowest position of which the conditions will admit. Hence, if the body is supported at only one point, it cannot remain at rest, unless this point of support is either at the centre of gravity or is in the same vertical with it. If the centre of gravity is below the point of support, the body is in a *stable equilibrium*; because, if by any means the centre is displaced, the force of gravity will tend to restore it to its original position. If, however, the centre of gravity is above the point of support, the body will be in an

unstable equilibrium; for the slightest displacement will remove the centre out of the vertical, and it will then move to the lowest possible position. The chair suspended by a string in Fig. 20 is in a stable equilibrium, because the centre of gravity is below the point of support. The same chair could, with great care, be balanced on the end of one of its legs, but its equilibrium would then be unstable; because the centre of gravity would be above the point of support, and the slightest displacement of the centre of gravity would cause the chair to fall.

When a body rests on a base, it is stable, when the vertical passing through the centre of gravity falls within the base. The stability of the body in such a position is estimated by the magnitude of the force required to overturn it. If its position can be disturbed or deranged without raising its centre of gravity, the slightest force will be sufficient to move it; but if its position cannot be changed without causing its centre of gravity to rise to a higher position, then a force will be required which would be sufficient to raise the entire body through the height to which its centre of gravity must be elevated. This is illustrated in Figs. 23, 24, 25. To turn the cylinder over the edge *B*, it would be

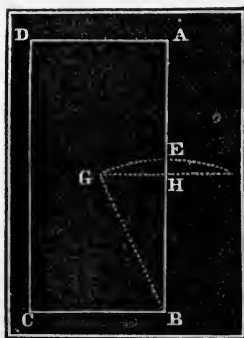

Fig. 23.

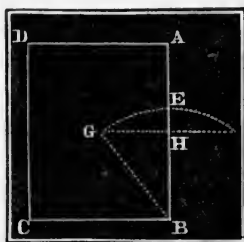

Fig. 24.

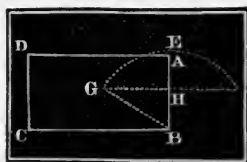

Fig. 25.

necessary in either case to move the centre of gravity, *G*, over the arc *GE*, and hence to raise it through the height *HE*. This distance is greater, and hence the force required to overturn the cylinder is greater, the larger the base of the cylinder relatively to its height. It can also easily be seen that the stability is greatest when the vertical, passing through the centre of gravity, passes also through the centre of the base. If it passes

through the edge of the base, as in Fig. 26, the slightest force will overturn it. If it passes outside of the base (Fig. 27), then

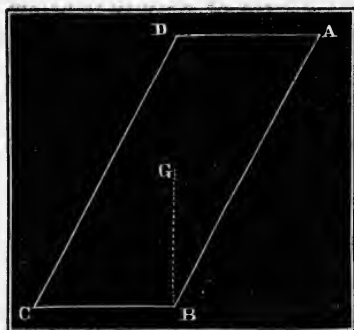

Fig. 26.

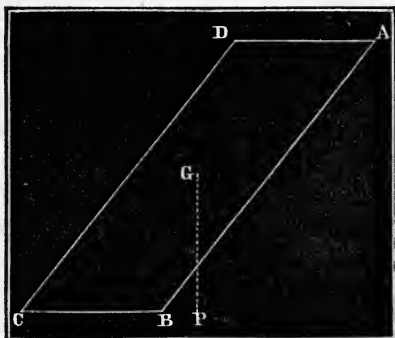

Fig. 27.

the centre will be unsupported, and the cylinder will fall. These principles, which have been illustrated by a cylinder, may be readily extended to other bodies.

When a body rests on two or more points, it is not necessary for its stability that its centre of gravity should be directly over one of these points; it is only necessary that its vertical should fall between them. If a body rests on two points, it is supported as effectually as if it rested on an edge coinciding with the straight line which unites the two. If it rests on three points, it is supported as firmly as it would be by a triangular base coinciding with the triangle of which the three points are vertices.

A familiar condition of equilibrium is presented by a sphere resting on a level plane. Such a sphere has but one point of support, and this is directly under the centre of gravity. If the sphere is rolled upon the plane, the centre of gravity will neither rise nor fall. Hence any force, however slight, will cause it to move; and, on the other hand, the body will have no tendency, of itself, to change its position when it is disturbed. This condition is called *neutral equilibrium*. A cylinder resting with its edge on a plane and level surface is another example of neutral equilibrium.

(49.) *Intensity of the Earth's Attraction.* — The falling of a stone to the earth is, as has been stated (21), an example of a uniformly accelerated motion. Hence, the force of gravitation

must be a force of constant intensity (27). The amount of acceleration, as was also stated (21), at the latitude of Paris, is $v = 9.8088$ metres. This acceleration is the same for all masses of matter, whether large or small. The apparent contradiction to this statement in common experience arises from the fact, that the fall of light bodies is more retarded by the resistance of the air than that of heavy bodies. If, however, the experiment is made in a vacuum, it will be found that a gold eagle and a feather will fall with equal rapidity. The intensity of a force is, as we have seen, equal to Mv . Representing the intensity of the force of gravity, which acts on a given mass of matter, M , by G , we shall have, for the latitude of Paris,

$$G = M \ 9.8088 \ (\text{units of force}). \quad [26.]$$

For any other mass of matter, M' , we shall have, in the same way,

$$G' = M' \ 9.8088 \ (\text{units of force}).$$

Hence,

$$G : G' = M : M'. \quad [27.]$$

The intensity of the earth's attraction is therefore proportional to the quantity of matter on which it acts. In other words, the force increases with the quantity of matter to which it is applied. In this respect gravity differs from many other forces with which we are familiar, from muscular force and the force of a steam-engine, for example, since these have a constant value, and do not vary with the amount of matter to which they are applied.

We assumed (45) that the earth's attraction acts equally on every particle of matter. If this is true, it follows that the resultants of all the forces of gravity acting on the separate particles of two bodies must be proportional to the number of particles in each; in other words, to the masses of the two bodies. That this is the case, is proved by the experiment on falling bodies alluded to above, and by the proportion [27] which followed. Hence the assumption of (45) was correct.

As the intensity of the force of gravity varies with the amount of matter on which it acts, we must, in estimating the strength of this force in different places, always compare the intensities of the force when acting on equal masses of matter. It simplifies the subject, to take a quantity of matter equal to the unit of mass in each case. Representing then by g the intensity of the

attraction of gravitation for the unit of mass, we can easily deduce from [26],

$$g = 9.8088 \text{ (units of force)}; \quad [28.]$$

and also

$$G = M g \text{ (units of force)}. \quad [29.]$$

In this book, g will always be used to express the intensity of the force of gravity acting on the unit of mass, or, in general, the intensity of the force of gravity; and G will always be used to express the intensity of the force of gravity acting on a given mass, M . In every case they both stand for a certain number of units of force. The intensity of the earth's attraction varies slightly at different points of its surface; thus, at the equator, $g = 9.7806$; at the latitude of Paris, as above, $g = 9.8088$; and at the pole, $g = 9.8314$.

In order to determine the intensity of gravity at different places, it might be supposed that we could measure the distance through which a heavy body would fall the first second, and then, by the principles of uniformly accelerated motion (21), twice this distance would be equal to the value of g at the given place. On account of the great rapidity with which bodies fall, it is impossible to measure this distance with any accuracy; nor is this necessary, since we have in the pendulum an instrument by which we can determine indirectly the value of g with great precision.

(50.) *Pendulum*. — A pendulum is a heavy body, suspended from a fixed point by a rod or cord. If the centre of gravity of the body is directly under the point of support, the body remains at rest; but if the body be drawn out of this position, so that the centre of gravity will be on either side of the vertical line passing through the point of support, then the body, when disengaged, will fall towards the vertical line, and in consequence of its inertia will continue its motion beyond the vertical line until it comes to rest. It will then return to the vertical, and thus oscillate from side to side. In order to investigate the phenomena of this kind of motion, the mathematicians study at first an ideal pendulum, which they call a *simple pendulum*, to distinguish it from the actual material pendulum, which they call a *compound pendulum*.

(51.) *Simple Pendulum*. — A *simple pendulum* consists of a material point suspended to a fixed point by means of a thread

and the friction at the point of support, rapidly diminish the arc through which it moves, and finally arrest the motion altogether. By diminishing these resistances, the motion may be made to continue for a proportionally longer time; and a pendulum has been known to continue oscillating in a vacuum for several hours.

Each motion of the pendulum from B to B' , or from B' to B , is called one *oscillation*, and the angle $B O B'$ is called the *amplitude* of the oscillation.

(52.) *Isochronism of the Pendulum.* — It is evident that the length of time required for a single oscillation of the pendulum $O A$, Fig. 28, must be absolutely the same, so long as the amplitude of the oscillation remains constant; but also, what is more remarkable, it is true that the time required for each oscillation of the pendulum is but little influenced by the amplitude of the oscillation; and, for all practical purposes, the time of oscillation may be regarded as equal for all amplitudes not exceeding three or four degrees. This singular property of the pendulum is termed *isochronism*, from two Greek words signifying *equal time*, and the oscillations of the pendulum are said to be *isochronous*. Two oscillations of the pendulum are not, however, absolutely isochronous, unless the difference between their amplitudes is infinitely small.

(53.) *Formula of the Pendulum.* — If we represent by T the time of oscillation of a pendulum in seconds, by l its length in fractions of a metre, by g the acceleration produced by gravity each second, and by π the ratio of the circumference of a circle to its diameter, the value of T may be found to be

$$T = \pi \sqrt{\frac{l}{g}}, \quad [30.]$$

when the amplitude of the oscillation is infinitely small. If the amplitude is not infinitely small, but only very small, then we have

$$T = \pi \sqrt{\frac{l}{g}} \left(1 + \frac{a^2}{16} \right), \quad [31.]$$

when a is the ratio of the length of the arc $A B$, Fig. 28, to the length of the pendulum. The truth of these formulæ cannot readily be demonstrated without the aid of the higher mathematics, and we must therefore refer the student to works on Analytical Mechanics for the demonstration.

Several important truths are expressed in these formulæ: —

1. *The duration of an oscillation does not depend on its amplitude when this is infinitely small, and is but slightly influenced by the amplitude even when it is as large as three or four degrees.* By substituting, in [30], $l = 1$, and $g = 9.809$, we should obtain, for the time of vibration of a pendulum one metre long, at the latitude of Paris, $T = 1.003085$. By substituting in [31] the same values, and also $a = 3.1416 \div 90 = 0.0349$, we should obtain, for the time of vibration when the amplitude was four degrees, $T = 1.003161$, which differs from the first value by only the 0.000076 of a second.

2. *The duration of the oscillation is proportional to the square root of the length of the pendulum.* Substituting, in equation

[30], $C = \sqrt{\frac{\pi^2}{g}}$, which is a constant quantity at any given place, the equation becomes $T = C \sqrt{l}$. For a pendulum of another length, as l' , we have $T' = C \sqrt{l'}$, and, comparing the two,

$$T : T' = \sqrt{l} : \sqrt{l'}; \quad [32.]$$

and also

$$l : l' = T^2 : T'^2. \quad [33.]$$

3. *The duration of the oscillation of a pendulum of an invariable length is inversely proportional to the square root of the intensity of gravity.* Substituting, in equation [30], $C = \sqrt{\pi^2 l}$, which is a constant quantity when l is supposed invariable, we

obtain $T = C' \sqrt{\frac{1}{g}}$. For another place, where the intensity of

gravity is g' , we have $T' = C' \sqrt{\frac{1}{g'}}$; hence,

$$T : T' = \frac{1}{\sqrt{g}} : \frac{1}{\sqrt{g'}} = \sqrt{g'} : \sqrt{g}. \quad [34.]$$

(54.) *Compound Pendulum.* — We have hitherto supposed that the pendulum is a heavy mass, of indefinitely small magnitude, suspended by a string or a rod, having no weight. Such a pendulum is, as has been stated, a pure abstraction, and can never be realized in practice. The pendulum which must be used in all our experiments is a compound pendulum, consisting of a heavy weight, suspended to a fixed point or axis, by means of a rigid rod of wood or metal. The particles of such a pendu-

lum must necessarily be at different distances from the point of suspension, and must therefore tend to oscillate in different times. Hence, the time of oscillation of the whole pendulum will not be the same as that of a simple pendulum of the same length, and the difference becomes of much importance.

The theory of the simple pendulum may be extended to the compound pendulum, by regarding the last as consisting of as many simple pendulums as it contains material particles. Were these free to move, they would oscillate in different times, determined by their distances from the point of suspension; but they form parts of a rigid system, and they are therefore all compelled to oscillate in the same time. Consequently, the oscillations of the particles near the point of suspension are retarded by the slower oscillations of those below them; and, on the other hand, the oscillations of the particles near the lower end of the pendulum are accelerated by the more rapid oscillations of those above them. At some point on the axis of the pendulum, intermediate between these, there must be a particle whose natural oscillation is neither accelerated nor retarded, and where the several effects will be all balanced, all the particles above it having exactly the same tendency to oscillate faster than the particles below it have to oscillate slower. This point is called the *centre of oscillation*, and it is obvious that the time of oscillation of a compound pendulum is exactly the same as that of a simple pendulum whose length is equal to the distance of the centre of oscillation from the point of suspension. This distance is the *virtual* or *acting length* of the pendulum, and equations [30] and [31] will apply to compound pendulums, by substituting for l their *virtual length*. By the length of a pendulum, no matter what may be its form, is always to be understood the virtual length, unless the reverse is expressly stated.

(55.) *Position of the Centre of Oscillation.* — When the form of the pendulum is given, the position of the centre of oscillation can be calculated; but as the methods of calculation involve the principles of the higher mathematics, they cannot readily be explained in this connection. The centre of oscillation can also be found experimentally, by making use of the following remarkable property of the compound pendulum, first demonstrated by Huyghens.

If a pendulum be inverted and suspended by its centre of os-

cillation, its former point of suspension will become its new centre of oscillation, and the time of vibration will remain the same as before. This property is usually expressed by saying, that *the centres of oscillation and suspension are interchangeable*.

This property of the pendulum may be verified by means of a reversible pendulum, Fig. 29. This pendulum is furnished with two knife-edges, *a* and *b*, which, when the pendulum is in use, rest on plates of steel or agate. If *a* is the axis of suspension, and *b* the axis of oscillation, determined by calculation, the pendulum will be found to oscillate in the same time on either knife-edge. If the position of the axis of oscillation is not known, it can easily be found by shifting the position of the lower knife-edge, until, on trial, the pendulum is found to oscillate in equal times on both. The lower knife-edge is then in the axis of oscillation. A pendulum of this kind was used by Captain Kater, in his determination of the length of the seconds pendulum, mentioned on page 12.

When the pendulum consists of a fine thread and a heavy ball, the centre of oscillation very nearly coincides with the centre of gravity, and such a pendulum can be used for ascertaining approximatively the virtual length of a compound pendulum. By shortening or lengthening the thread, a length can easily be found with which the pendulum will oscillate in the same time with the compound pendulum. This length will then be approximatively the virtual length sought.

(56.) *Use of the Pendulum for Measuring Time.* —

If in the equation $T = \pi \sqrt{\frac{l}{g}}$, we substitute for *T* unity, and for π and *g* the values already given, we shall find, for the length of a pendulum vibrating seconds at Paris, the value $l = 0.993839$ m. The lengths of pendulums vibrating in 2, 3, and 4 seconds would be by (33) 4, 9, and 16 times this length. In order to use the seconds pendulum for measuring time, it is only necessary to connect with it a mechanism by which its beats may be recorded and its motion maintained. Such a mechanism constitutes a common clock, the essential parts of which are represented in Fig. 30.



Fig. 29.

The toothed wheel *R*, called the *scape-wheel*, is turned by a weight or spring, either directly, as in the figure, or through the intervention of other wheels. The revolution of the scape-wheel is regulated by means of a peculiar contrivance, *a b*, called the

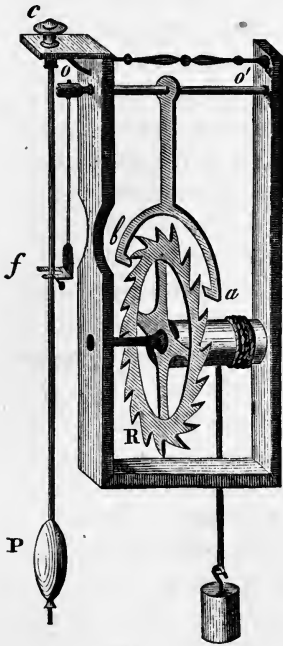

Fig. 30.

escapement, which oscillates on an axis *o o'*. The oscillations are communicated to the escapement by the pendulum *P*, through the forked arm *o f*. When the pendulum hangs vertically, one of the teeth of the scape-wheel, cut obliquely for the purpose, rests on the upper side of the hook *b*, and the clock remains at rest. If now the pendulum is set in motion, so that the hook *b* is moved from the wheel, the tooth which rested upon it is set free, and the wheel begins to revolve; but it is soon arrested by the hook *a*, which has moved up to the wheel as *b* moved from it, and catches on its under surface the tooth immediately below. As the pendulum oscillates back the hook *a* moves away, the wheel again commences to revolve, but is arrested a moment after on the opposite side by the hook *b*, which

catches the tooth next to the one it held before; and thus continuously, so that each oscillation of the pendulum allows the scape-wheel to move forward through a space equal to one half of one of its teeth. If, then, the wheel has thirty teeth, it will complete one revolution in sixty beats of the pendulum, moving forward one sixtieth of a revolution at each beat. This wheel is the one on whose axis the second-hand is placed. It is connected by cogs with another wheel, which is made to occupy sixty times as long in revolving, and this carries the minute-hand; and this is connected with another wheel, which revolves in twelve times the period, and carries the hour-hand. Thus the second-hand registers the beats of the pendulum up to sixty, or one minute; the minute-hand registers the number of revolutions of the second-hand up to sixty, or one hour; and the hour-hand registers the

number of revolutions of the minute-hand up to twelve, or half a day.

If the pendulum and escapement were removed from a clock, there would be nothing to prevent the train of wheels from being turned round with great rapidity by the weight or spring acting on it, and the clock would speedily *run down*. On the other hand, were there not some means of communicating to the pendulum occasional impulses, it would soon be brought to rest by the resistance of the air and the resistance due to the mode of suspension. To prevent this, the escapement is so constructed as to give a very slight additional impulse to the pendulum at each oscillation. The ends of the two hooks, *a, b*, are cut so as to present to the teeth of the scape-wheel inclined surfaces. As the tooth of the wheel leaves one of these hooks, its extremity slides over this inclined plane with a considerable force, communicated by the weight, so as to throw the escapement forward with a slight impulse the moment the tooth is set free. This impulse is communicated, through the axis *o o'* and the arm *o f*, to the pendulum. If the weight is increased, the force with which the impulse is given will be greater; and the pendulum, receiving a greater impulse at each oscillation, will swing through a greater arc. As this will slightly increase the time of each oscillation (53), the addition of weight will make the clock go slower. The change of rate in a clock caused by the expansion and contraction of the pendulum, will be considered in the chapter on Heat.

(57.) *Use of Pendulum for Measuring the Force of Gravity.* — By transposing, we obtain from equation [30] the value of *g*:

$$g = l \frac{\pi^2}{T^2}; \quad [35.]$$

from which, when we know the length of a pendulum which oscillates in a given time, *T*, we can easily calculate the value of *g* for the place of experiment. If, in the last equation, we place *T* = 1, then *l* denotes the length of the seconds pendulum, and we obtain for the value of *g*,

$$g = l \pi^2. \quad [36.]$$

In order, then, to measure the intensity of gravity at any place, we have only to oscillate a pendulum whose virtual length is known,

and observe the time of a single oscillation. This observation is readily made by counting a large number of oscillations, and observing the time occupied by the whole number. This time, divided by the number of oscillations, gives the duration of a single oscillation with great accuracy, because any error we may have made in observing the time is thus greatly divided.

By this method Borda and Cassini, in 1790, measured with great accuracy the intensity of gravity at the Observatory of Paris. The pendulum which they used consisted of a sphere of platinum, suspended to a knife-edge by means of a fine platinum wire. The knife-edge rested on an agate plate, and the whole pendulum was about four metres long. Instead of counting directly the number of oscillations, Borda compared the motion of his pendulum with that of a clock placed behind it. On the ball of the clock's pendulum a vertical mark indicated the position of its axis, and a small telescope, placed a few metres in front, enabled him to observe when the wire of his pendulum exactly coincided with the vertical mark. Starting from a moment when the two coincided, he observed the number of seconds before such coincidence occurred again; and knowing this, he was able at once to calculate the number of oscillations of the pendulum which occurred during an observed number of seconds by the clock. Let v be the number of oscillations of the seconds pendulum between the coincidences, then $v \pm 2$ will be the number of oscillations of the experimental pendulum in the same interval, that is, in v seconds, and $\frac{v \pm 2}{v}$ will be the number in one second. Hence, if p is the number of oscillations of the pendulum, and t the number of seconds observed by the clock, we shall have

$$p = t \frac{v \pm 2}{v} = t \pm \frac{2t}{v}; \quad [37.]$$

an equation by which we can calculate the number of oscillations in a given time, without being obliged to count them. In these experiments, the pendulums were enclosed in glass cases to protect them from currents of air, and separated from each other by glass, so that they should not react on each other through this fluid.

As the amplitude of the oscillations is not infinitely small, but only very small, in such experiments, it is important to correct the number of oscillations observed as above, and substitute for

it in the calculation the number which would have occurred had the amplitude been really infinitely small. If we call the duration of an oscillation which is infinitely small T , and that of one which is only very small T' , we have from [30] and [31] $T' = T \left(1 + \frac{a^2}{16} \right)$, where a is equal to one half the arc which measures the amplitude. Now, as the number of oscillations in a given time is inversely as their duration, we have $T' : T = n : n'$; and hence,

$$n = n' \left(1 + \frac{a^2}{16} \right), \quad [38.]$$

where n is the required number of oscillations, and n' the observed number. The amplitude is measured by means of a horizontal scale placed behind the pendulum, and, as it sensibly diminishes during the experiment, we take for the value of a in [38] the mean amplitude during the time of observation.

The value of g found by the above formulæ is a little too small, owing to the fact that the force of gravity acting on the mass of the pendulum is balanced to a slight degree by the buoyancy of the air, and it is necessary to correct the result for this cause of error. The principles from which this correction may be calculated will be explained in Chapter III. It will there be shown that a body is buoyed up in a fluid by a weight equal to the weight of fluid which it displaces. Hence, if W represents the weight of a body in a vacuum, and w the weight of air it displaces at a given temperature and under a given pressure, then $W - w$ is the weight of the body in the air at this temperature and pressure. If we put $\delta = \frac{w}{W}$, the small fraction which represents the ratio of the weight of the air to the weight of the body, we shall easily obtain

$$W - w = W - \delta W = W(1 - \delta).$$

Representing the weight of the body in air ($W - w$) by W' , we obtain, for the relation between the weight of a body in air and in a vacuum, the equation $W' = W(1 - \delta)$. It will be shown, in one of the following sections, that the weights of the same body under different circumstances are proportional to the intensities of gravity, and hence that $\frac{W'}{W} = \frac{g'}{g}$; substituting this, we have, for the relation between the actual intensity

of gravity, g , and the apparent intensity when the experiments are made in air, g' ,

$$g = g' \frac{1}{1 - \delta}. \quad [39.]$$

It appears, however, from the experiments of Bessel, which were confirmed by the calculations of Poisson, that the loss of weight which the pendulum suffers in air is much greater when it is in motion than when at rest, so that a still further correction must be made to eliminate this source of error; but for the details of this and of the other corrections which are required, we must refer the student to Bessel's original Memoirs.

(58.) *Value of g .* — By the method described in the last section, Borda and Cassini found for the intensity of gravity at the Observatory of Paris the number $g = 9.8088$. This value has since been redetermined by Biot, Arago, Mathieu, and Bouvard, who used the same process, except that they employed a shorter pendulum, and obtained almost absolutely the same results. Bessel, by correcting for the loss of weight in the air due to the motion of the pendulum, found for the value of the intensity of gravity at Paris,

$$g = 9.8096,$$

which is probably the most accurate.

The value of g has also been determined at different points on the earth's surface, with more or less accuracy, by different observers. Some of these results are collected in the following table, which has been taken from Daguin's *Traité de Physique*. The length of the seconds pendulum is easily calculated from the values of g by means of equation [36].

Stations.	Latitudes.	Value of g .	Seconds Pendulum.	Observers.
			m.	
Spitzbergen,	79° 49' 58" N.	9.83141	0.99613	Sabine.
Stockholm,	59 20 34	9.81946	0.99492	Svanberg.
Königsberg,	54 42 12	9.81443	0.99441	Bessel.
Paris,	48 50 14	9.80979	0.99394	Biot, etc.
Ile Rawak,	0 1 34 S.	9.78206	0.99113	Freycinet.
Ile de France,	20 9 23	9.78917	0.99185	Duperrey.
Cape of Good Hope,	33 55 15	9.79696	0.99264	Freycinet.
Cape Horn,	55 51 20	9.81650	0.99462	Foster.
New Shetland,	62 56 11	9.82253	0.99523	Foster.

It appears from this table, that the intensity of the force of gravity gradually increases with the latitude as we go from the

equator towards either pole. In general, the value of g for any latitude can be determined sufficiently near for all purposes of Physics, by means of the formula,

$$g = 9.80604 (1 - 0.0025935 \cdot \cos 2\lambda), \quad [40.]$$

in which λ is the latitude of the place, and 9.80604 the value of g at the latitude of 45° . By substituting for λ , 0° or 90° , we obtain at the equator $g = 9.780642$, and at the poles $g = 9.83146$. It does not appear, however, that the intensity of gravity is rigorously the same at all points on the same parallel of latitude, or at corresponding points in the northern and southern hemispheres. Irregularities in this respect were noticed in the measurement of the arc of the meridian in France, and also by Lacaille at the Cape of Good Hope.

These variations in the intensity of gravity on the earth's surface depend mainly on two causes; first, on the centrifugal force due to the earth's revolution on its axis, which is at its maximum on the equator, and gradually diminishes towards the poles, where it disappears; secondly, on the spheroidal character of the earth, in consequence of which a body at the poles is more strongly attracted by the mass of the earth than it is at the equator. We will consider the effect of each of these causes in turn.

(59.) *Centrifugal and Centripetal Force.* — It has already been stated (25), that a curvilinear motion is the resultant of two motions which obey different laws. Thus, in Fig. 31, the parabolic motion of a ball shot horizontally from a fort is the resultant of a uniform motion in the direction of $a m$, and of a uniformly accelerated motion in the direction of $a n$. We also know that this motion is the result of two forces, one which has acted, and the other which is still acting, on the ball; first, the projectile force of gunpowder, which has given to the ball a certain momentum, $M v$, in virtue of which it will

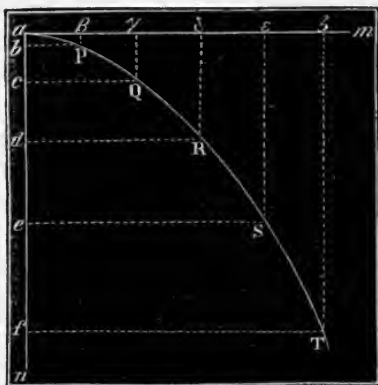

Fig. 31.

continue to move until its motion is arrested by an equivalent force acting for an equivalent time in the opposite direction; second, the force of gravity, a constant force both in direction and intensity. Compare (27) and (29).

Let us now consider the conditions of Fig. 31 to be so far changed, that the *constant force* no longer acts in directions parallel to itself, but in directions which all converge to one point.

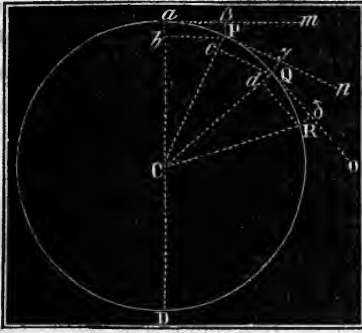

Fig. 32.

Such a force may be regarded as an attractive force emanating from this point, and is therefore frequently called a *central force*. Let us then suppose that in Fig. 32 we have, as before, a ball moving with a certain momentum in the direction $a m$, communicated to it originally by a force acting for a given time with a given intensity, but which has ceased to act.

Let us also suppose that the same ball is attracted towards a given point, C , by a force constant in intensity. What will be the resulting motion of the ball? Let \mathbf{v} be the velocity in the direction $a m$, and \mathbf{p} be the acceleration of the given force. In a small fraction of a second, which we may take as small as we please, the ball will move in the direction $a m$ over a space $a \beta$, equal to $\frac{\mathbf{v}}{n}$, where n is the number of intervals into which the unit of time has been divided. In the same time it will move in the direction $a C$ over a space $a b$, equal to $\frac{1}{2} \frac{\mathbf{p}}{n^2}$ [5]. The resultant of these motions, on the principle of (25), will be a curved line passing through the point P , which can be found by completing the parallelogram $a \beta P b$. Arrived at the point P , the direction of its original motion has so far changed, that, if the central attraction ceased to act at that moment, the original momentum would cause it to move in the direction $P n$, tangent to the curve at the point P , which, according to the principle of geometry, may be regarded as the continuation of the direction in which it was moving at the instant. The central force, however, does not cease to act, and during the

next small interval of time the same thing is repeated. In virtue of the momentum, the ball will pass over the distance $P\gamma$, equal to $\frac{h}{n}$, and in virtue of the central force will move towards the centre by an amount, Pc , equal to $\frac{1}{2} \frac{v}{n^2}$. The resultant of these motions will be a second curved line, similar to the first, and a continuation of it, passing through Q . The same thing will be again repeated every succeeding interval of time, and thus the motion resulting from the two forces will be a curved line bending towards the central point C , the central force constantly changing the direction of the original momentum. It is easy to see, that, with a certain relation between the momentum and the intensity of the central force, the distance of the ball from the centre would keep always the same, and the path of the ball would be a circle. If the central force were greater relatively to the momentum than this, then the ball would be drawn each second nearer to the centre, and the radius of the curvilinear path would as regularly shorten; if the central force were relatively less, the ball would evidently recede from the centre, and the radius of its path would lengthen. If, however, we suppose that the central force diminishes as the body recedes from the centre, and increases as it approaches it, so that the intensity is always inversely as the square of the distance, then it can easily be proved mathematically that the path of the ball will return into itself, and will be an ellipse. We shall have only to deal with that particular case where the path is a circle. In this case, the ball remaining constantly at the same distance from the centre, the whole central force is expended in changing the direction of the original motion, and is evidently just balanced every instant by the inertia of the mass of the ball.

The force which arises from the inertia of the ball is called the *centrifugal force*, while the central force by which it is restrained and kept on the circumference is called the *centripetal force*. The term centrifugal force is very liable to be misunderstood. It is frequently supposed to imply a force which, acting alone, would cause the ball to fly directly from the centre; but we must bear in mind that the centrifugal force *cannot act alone*, since it has no independent existence. When the centripetal force ceases to act, then the centrifugal force ceases to exist, and the *momentum* of the moving body tends to carry it forward in

the straight line tangent to the circle at the point at which the centripetal force ceases to draw it from the circumference. The body will, it is true, then recede from the centre; but it will only do so by passing along the tangent, the distance of which from the centre is continually increasing, and not by flying in a direction opposite to the centre of attraction. Its action, however, will be to cause the particles of a body in rapid revolution to take their places at the greatest possible distance from the centre.

The measure of the centrifugal force in Fig. 32 is obviously the amount of restraint required to keep the ball on the circumference of the circle, and it is measured by the intensity of the centripetal force, which, on our supposition, just balances it. Calling, then, the centrifugal force \mathfrak{C} , the acceleration of the centripetal force \mathfrak{v} , and the mass of the ball M , we have, by [14],

$$\mathfrak{C} = M \mathfrak{v}. \quad [41.]$$

Since, however, we only know, as a general rule, the velocity of the motion of a ball on the circle and the radius of the circle, it is important to obtain, if possible, an expression of the intensity of the centrifugal force in terms of these two quantities. This can easily be obtained by the principles of geometry.

Let aP , Fig. 32, be the arc described by the ball in an interval of time so small that the arc may be considered as equal to the chord. Call this interval $\frac{1}{n}$ of a second, where n may be as large as you please. Represent by \mathfrak{b} the velocity of the ball on the circumference; then $\frac{\mathfrak{b}}{n}$ is equal to the length of the arc aP . Represent next, by \mathfrak{v} , the unknown acceleration of the centripetal force; then the distance ab , through which the ball would move under the influence of this force alone in $\frac{1}{n}$ of a second, will be, by [5], $\frac{1}{2} \frac{\mathfrak{v}}{n^2}$. We have, by geometry, $ab : aP = aP : aD$; from this proportion, by substituting the above values, we obtain $\frac{1}{2} \frac{\mathfrak{v}}{n^2} : \frac{\mathfrak{b}}{n} = \frac{\mathfrak{b}}{n} : 2R$, or $\mathfrak{v} = \frac{\mathfrak{b}^2}{R}$; and substituting this value of \mathfrak{v} in [41], we obtain, for the intensity of the centrifugal force,

$$\mathfrak{C} = M \frac{\mathfrak{b}^2}{R}. \quad [42.]$$

We can give this expression another form, which is more convenient for use. The expression \mathfrak{v} , which represents the velocity of the ball, denotes the number of metres which it passes over in one second. If, then, we represent by T the number of seconds occupied by the ball in going once round the circle (its period of revolution), and by $2 R \pi$, as usual, the circumference of the circle, we shall have $\mathfrak{v} = \frac{2 R \pi}{T}$. Substituting this value in [42], we obtain

$$\mathfrak{C} = M \frac{4 \pi^2 R}{T^2}, \quad [43.]$$

which is an expression for the intensity of the centrifugal force in terms of the time of revolution, the radius of the circle described, and the mass of the body.

If a weight is whirled round at the end of a string, the action of the centrifugal force is shown in the tension of the string, and the only difference between this and the previous example is, that the resistance of the string takes the place of the attractive force. If the string breaks, the weight flies off on a line which is a tangent to the circle which the weight had described. In like manner, the particles of water on the rim of a revolving grindstone tend to fly off from the surface, but are kept in place by the adhesive attraction of the stone; when, however, the revolution becomes rapid, the centrifugal force overcomes the adhesion, and the water is thrown off in lines which are tangent to the cylindrical surface. Not unfrequently, when the revolution is very rapid, the centrifugal force overcomes the cohesion between the particles of the stone itself, and serious accidents have resulted from this cause.

Since the earth is revolving rapidly on its axis, we should expect to find, especially at the equator, a manifestation of this same force; and in fact we do. All bodies on the globe not situated exactly at the poles tend to fly off from its surface on lines tangent to the parallels of latitude on which they revolve, and are only prevented by the force of gravity. Were the rapidity of the earth's revolution more than seventeen times increased, the force of gravity would not be sufficient to restrain bodies on the equator from obeying this tendency. As it is, however, the centrifugal force only acts to diminish the intensity of the force of gravity; and this action, which is greatest at the equator,

gradually diminishes as we go towards the poles, where it is nothing.

We can easily find the intensity of the centrifugal force at the equator, by substituting in [43], for R , the value of the equatorial radius, 6,377,398 metres, and for T the number of seconds in a day, 86,400. The value of the centrifugal force then becomes, for the mass M ,

$$\mathfrak{C} = M \times 0.03373,$$

and for the units of mass,

$$\mathfrak{c} = 0.03373 \text{ (units of force)}. \quad [44.]$$

The apparent value of g at the equator is less than its true value by exactly the amount of this force. Hence the full value of the earth's attraction at the equator is

$$9.78062 + 0.03373 = 9.81435.$$

For any other latitude, the value of the centrifugal force is easily found by assuming that the earth is a perfect sphere. In

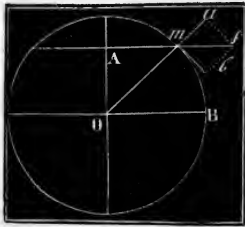

Fig 33.

Fig. 33, let m be the position of the body on the globe; then $m O B = A m O = a m f$ is the latitude of the place, which we will indicate by λ ; also $A m = R \cos \lambda$ is the radius of the parallel of latitude on which the body m is revolving. The value of the centrifugal force, in terms of the latitude, will be found by substituting this last value for R in [43]. Making this substitution, and using for R the mean radius of the globe, we obtain,

for the value of the centrifugal force, $m f = 0.03367 \cos \lambda$. This, however, is the value of the centrifugal force acting in the direction $m f$. The force of gravity acts in the direction $m O$, and in order to ascertain to what extent the force of gravity is influenced by the centrifugal force, we must decompose the last into two components. Let $m f$ represent the intensity of the centrifugal force, then $m a$ and $m b$ will represent the intensities of two components; the first of which, being opposite in direction, will tend to neutralize the force of gravity, while the second, being perpendicular in direction, will produce no effect on it. The value of the component $m a$ is $m a = m f \cos \lambda$; and substituting for $m f$ its value as above, and representing always by \mathfrak{c} that component of the

centrifugal force which is opposite in direction to gravity, we have

$$c = 0.03367 \cos^2 \lambda. \quad [45.]$$

We can easily find how rapid the rotation of the globe must be, in order that the centrifugal force at the equator should just balance the attractive force of gravity. For this purpose we have only to substitute for C , in [43], the value of the attractive force just found, and calculate the corresponding value of T , which will be found to be 5,065 seconds. Hence, if the earth revolved once in 5,065 seconds, or in $1^h. 24^m. 25^s$,—that is, a little more than seventeen times faster than it does,—the force of gravity at the equator would be just balanced by the centrifugal force.

(60.) *The Spheroidal Figure of the Earth.*—The second cause, mentioned in (58), of the variation of gravity with the latitude, is the spheroidal figure of the earth, in consequence of which a body at the poles is more strongly attracted by gravity than at the equator. The form of the earth, as has been before intimated, is not a perfect sphere. It is flattened at the poles, and its figure is best described as an oblate ellipsoid or spheroid. A section of the earth through a *meridian circle* is therefore not a circle, but an ellipse of very small eccentricity, and the figure of the earth may be conceived as generated by the revolution of such an ellipse round its shorter diameter as an axis. The flattening at the poles amounts in round numbers to about $\frac{1}{300}$ of the equatorial radius; in other words, the polar radius is about $\frac{1}{300}$ shorter than the equatorial. This deviation from a true sphere is so small, that it could not be detected by the eye in a common globe, but in the earth it nevertheless amounts to over thirteen English miles. The dimensions of the earth are accurately as follows: *—

Volume of the earth,	1,082,842,000,000.000	cubic kilometres.
Surface of the earth,	509,961,000,000	square “
Length of a quadrant,	10,000.857	kilometres.
Equatorial radius,	6,377.398	“
Mean radius (lat. 45°),	6,366.738	“
Polar radius,	6,356.079	“
Difference between the equatorial and polar radius,	21.319	“

* These data are all taken from the table of constants in Kohler's "Logarithmisch-Trigonometrisches Handbuch."

Were the earth perfectly spherical, a plumb-line at any point on its surface would point exactly to its centre, and the centre of figure would then be also the centre of attraction. The earth being spheroidal, the phenomena of gravity upon its surface become less simple. The plumb-line does not point exactly to the centre of the earth, except at the equator or at the poles, and, moreover, there is no fixed centre of gravity. In Fig. 34, the

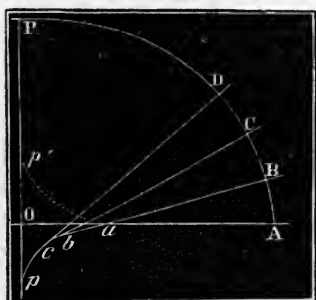

Fig. 34.

line AP is supposed to represent a quadrant of a meridian, of which OP is the polar, and OA the equatorial radius. Starting from the equator, let us take stations only one degree distant from each other on this meridian, and at each station continue the direction of the plumb-line until it intersects the plumb-line similarly produced at the previous station. If, in the figure B , C , and D are three such points, then a , b , and c are the three points of intersection, and it is easy to see, from the figure, that the ninety points of intersection, which would be obtained by producing the plumb-lines from all the ninety stations, would form when united a curved line, $abc p$. By making the number of stations infinite, we should of course have an infinite number of points of intersection; and for every point on the quadrant AP , there would be a corresponding point on the curve ap . The points a , b , c , etc. are termed in geometry *centres of curvature*; the lines Aa , Bb , Cc , etc. are called *radii of curvature*; and the curve ap is called the *evolute* of the curve AP . Now it can be easily seen that what we call the centre of attraction of the earth for any point on the quadrant AP is the corresponding centre of curvature on the evolute ap . At A , for example, the attraction of the earth acts as if it originated at the point a ; at B , as if it originated at the point b , etc. The intensity of the force which resides at these different centres is not, however, the same; the intensity at a , for example, is less than at b , at b less than at c , etc. It gradually increases at the different points on the evolute from a to p .

What is true of the quadrant AP must be true of every

quadrant; hence, if the evolute ap is revolved on its axis, Op , the surface generated would be the *locus* of all the centres of attraction for points on the upper hemisphere of the globe; and if the evolute ap' is revolved, the surface generated would be the *locus* of all the centres of attraction for points on the lower hemisphere of the globe.

It is evident, from the above, that a body placed at the equator, and a similar one placed at the pole of the globe, stand in different relations to its mass as a whole, and we should naturally expect that they would be attracted with different degrees of force. Newton, Maclaurin, Clairaut, and many other eminent geometers, have calculated how great the variation of gravity, owing to the elliptic form of the earth alone, ought to be, in going from the equator to the pole, and the results of their calculations coincide almost precisely with those of observation given above.

It has also been proved by the same mathematicians, that the actual form of the earth is almost precisely that which would result from the revolution of a liquid mass of the same volume and density once in twenty-four hours; and since we have every reason to believe that the globe was once fluid, and that it is even so now, with the exception of a comparatively thin crust on its surface, it follows that the cause of the variation of gravity just considered is itself an indirect result of the centrifugal force.

(61.) *Variation of the Intensity of Gravity as we rise above the Surface of the Earth.* — The law by which the intensity of gravity varies with the distance from the centre of force, can be discovered by studying the effect of the earth's attraction on the moon, as compared with its effect on bodies near its surface. The mean distance of the moon from the centre of the earth, is about sixty times the earth's equatorial radius, and it revolves round the earth, in an orbit which is very nearly circular, in 27.322 days. By (59), it follows that the intensity of the earth's attraction at the moon is just equal to the centrifugal force, and it can therefore be calculated by substituting in [43] the values of R and T just given. Making these substitutions, we obtain, for the value of the earth's attraction on the moon, where M equals the mass of the moon, $G = M \times 0.0027$. For the unit of mass, then, the intensity of the earth's attraction at the distance of the moon is $g = 0.0027$. The intensity of the earth's attraction for bodies on the equator

is, as we have seen, $g = 9.7806$, which is about 3,600 times greater than 0.0027. For bodies as distant as the moon, we may consider the attraction of the globe as concentrated at its centre of figure, and hence we may regard the moon as about sixty times as distant from the centre of attraction as a body on the equator. At sixty times the distance, then, the force is 3600 ($= 60^2$) times less; that is, the intensity of the force of gravity varies inversely with the square of the distance from the centre of attraction. Representing, then, by g and g' the intensity of gravity at the distances R and R' , we have always the proportion,

$$g : g' = R'^2 : R^2. \quad [46.]$$

It follows from the above discussion, that the intensity of gravity must vary at different heights above the sea-level on the surface of the earth. The amount of this variation can easily be calculated by means of the above proportion. Representing by g the intensity of gravity at the sea-level, by g' the intensity at an elevation, h , and by R the radius of the earth, we have, from [46], neglecting the variation in the centrifugal force at the two heights,

$$g : g' = (R + h)^2 : R^2, \quad \text{and} \quad g = g' \frac{(R + h)^2}{R^2}. \quad [47.]$$

When $h = 1000$ m., we have from [47], $g = g' 1.0003$. The amount of variation is therefore perceptible at any considerable elevation above the sea-level. Hence, in studying the variation of the intensity of gravity on the surface of the earth, it is important to reduce the results of observations at different elevations to the sea-level before comparing them. This can always be done by [47], when the elevation is known.

(62.) *Law of Gravitation.* — We proved, in (49), that the intensity of the force of gravitation is directly proportional to the quantity of matter (the mass) on which it acts, and in the last section we have shown that the intensity of the force of gravitation is inversely proportional to the square of the distance of the masses, on which it acts, from the centre of attraction. By combining the two, we have the well-known law of gravitation, which is expressed in the following terms: — *All masses of matter attract one another with forces directly proportional to the quantity of matter contained in each, and inversely proportional to the squares of their distances from each other.*

This law was discovered in 1666 by Sir Isaac Newton, who, while reflecting on the power which causes the fall of bodies to the earth, and considering that this power is not sensibly diminished, even at the top of the highest mountains, conceived that it might extend far beyond the limits of the atmosphere, and even exert its influence through all space. It may be, he thought, this very force by which the moon is retained in her orbit round the earth, and the whole planetary system round the sun. In order to verify his conjecture, he calculated, on the same principle used in the last section, the attraction of the earth on the moon, assuming that the force must diminish in the inverse ratio of the square of the distance, — an assumption to which he was led by the relation, previously discovered by Kepler, between the times of revolution of the planets and their distances from the sun. The result, at first, did not answer his expectations, because he had used in the calculation a value of the earth's radius, and hence also of the moon's distance, which was much too small, and he therefore rejected the hypothesis as not substantiated. Several years later, Picard measured, with great accuracy for the times, an arc of the meridian in France; and from his measurement it appeared that the radius of the globe was nearly one seventh greater than had previously been supposed. Furnished with these new data, Newton resumed his calculations with complete success, and in 1687 published his great work, the *Principia*, in which the consequences of this great law were developed as far as the astronomical and mathematical knowledge of the times would permit.

(63.) *Absolute Weight.* — When a body is not free to fall, the force which gravity exerts upon it is expended in pressure against its support. This pressure is called *absolute weight*. The absolute weight of a book, for example, is the pressure which it exerts against the table on which it rests. It is evident that this pressure is equal to the intensity of the force with which the book is attracted by the earth. The intensity of the force which gravity exerts on a given mass of matter we have represented by G (49). If, then, we represent the pressure caused by this force, or the absolute weight of the same mass of matter, by w , we have $w = G$. Hence, we can substitute w for G in [26] and [27], and shall then have

$$w = M \cdot g, \quad [48.]$$

and

$$w : w' = M : M'. \quad [49.]$$

In these formulæ, w represents weight or pressure; while in [26] and [27] G represents the intensity of the force which is the cause of the pressure. In this work, w always stands for a certain number of grammes, and G for a certain number of units of force. For example, let us suppose that the quantity of matter in the book just referred to is equal to 50 units of mass; we should then know, from [26], that the intensity of the force exerted by gravity upon it was equal to 490 units of force, and, from [48], that its weight was equal to 490 grammes. In the first case, $G = 50 \times 9.8 = 490$ units of force. In the second case, $w = 50 \times 9.8 = 490$ grammes. The numbers in the two cases are precisely the same, but they signify different kinds of units. The identity of the numbers arises from the fact that the unit of force is equivalent to a pressure of one gramme, so that the difference between G and w is rather nominal than real.

It follows from [49], that the weights of bodies are proportional to the quantities of matter which they contain; in other words, that a body which contains two, three, or four times as much matter as a given body, will also weigh two, three, or four times as much. This fact has a most important bearing on chemistry, since the chemist is enabled, in consequence of it, to compare the various quantities of matter on which he experiments, by comparing their weights. So close is this relation, that in common language we confound the weight of a substance with its mass; thus, we speak of ten grammes of iron, meaning thereby a quantity of iron which exerts a pressure of ten grammes. It must be remembered that, in scientific language, weight always means pressure, and not quantity of matter. The word is most commonly used, however, to denote the quantity of matter which exerts the pressure.

So long as matter is neither taken from nor added to a body, its mass, from the very definition of the term, remains constant. It is not so, however, with the absolute weight. This varies with the force of gravity, and, as follows from [48], it is directly proportional to the intensity of this force. Hence, the absolute weight of a body increases as we go from the equator to the poles, and diminishes as we rise above the surface of the earth. It is very different on the different planets and on the sun. A body weighing a kilogramme on the earth would weigh about 28 kilogrammes on the sun, about 2.6 kilogrammes on Jupiter, and

only about 160 grammes on the moon. On the surface of the globe, however, the possible variation of weight is but small, amounting at most to $\frac{1}{100}$ of the whole. Calling this in round numbers $\frac{1}{200}$, it will be found that a body weighing one kilogramme at the equator would weigh 1 kilog. 5 gram. at the poles.

(64.) *French System of Weights.* — Weight is estimated by arbitrarily assuming a unit of weight, and then comparing the pressure exerted by other bodies with that exerted by the unit. If, for example, this pressure in a given case is found to be ten times as great as that of the unit, the body is said to weigh ten grammes, or ten pounds, as the unit may be denominated. The French have assumed, as their unit of weight, the pressure exerted by one cubic centimetre of pure water at 4° C. (its point of maximum density) in a vacuum, and at the latitude of Paris. This unit they call a *gramme*. The gramme is multiplied and subdivided decimally, and the names given to these multiples and subdivisions are analogous to those used in the case of the metre. Thus we have the

French System of Weights.

Kilogramme, 1000 gram.	Gramme, 1.000 gram.
Hectogramme, 100 “	Decigramme, 0.100 “
Decagramme, 10 “	Centigramme, 0.010 “
Gramme, 1 “	Millegramme, 0.001 “

It follows from the last section, that a mass of brass whose weight is one gramme at Paris would weigh less than a gramme at a lower latitude, and more than one gramme at a latitude higher than that of Paris. Hence, the weight of one cubic centimetre of water at 4° C., and in a vacuum, is the standard gramme only at the latitude of Paris.

The great advantage of this system of weights in all scientific investigations arises from the very simple relation which exists between it and the system of measures already described. This is so simple, that it is almost always possible to calculate the weight of a substance from its volume, and the reverse, mentally, when the specific gravity of the substance is known. The French system, both of weights and measures, is exclusively used in this volume.

(65.) *System of Weights of the United States and of England.* — In this country and in England two entirely distinct

units of weight are in use, called the *Troy Pound* and the *Avoirdupois Pound*. These units are entirely arbitrary, and are represented by certain masses of metal, which have been declared by law to be the legal standard of weight. These units bear to each other the relation of 144 to 175, and do not agree in any of their subdivisions except the grain. The Troy pound contains 5,760, and the avoirdupois pound 7,000 grains, all of the same value. The actual legal *standard of weight* in the United States is the *Troy pound*, copied by Captain Kater, in 1827, from the imperial Troy pound, for the United States Mint, and preserved in that establishment. This pound is a standard at 30 inches of the barometer and 62° of the Fahrenheit thermometer.* The English standard of weight is connected with that of measure, by the enactments that 277.274 cubic inches shall constitute the *Imperial Gallon*, and that the weight of this volume of pure water, weighed in air of 30 inches' pressure at 62° F., shall be taken as 10 avoirdupois pounds, or 70,000 grains. Tables of the subdivisions of the two units, showing their relations to the French system, will be found at the end of this Part, in connection with the other tables of weights and measures.

(66.) *Specific Weight*. — The specific weight of a substance is the weight of one cubic centimetre of the substance, and therefore bears the same relation to the weight that the density does to the mass (15). If, then, we represent specific weight by *Sp. w*, we have

$$Sp. w = \frac{w}{V}. \quad [50.]$$

The specific weight of copper, for example, at Paris, is equal to 8.921 grammes. The term specific weight must not be confounded with specific gravity, which will be explained in (69).

The specific weight of a substance is evidently variable, and, like the absolute weight, depends on the intensity of the force of gravity.

(67.) *Unit of Mass*. — In assuming a unit of weight, we have also established a unit of mass. If, in [48], we substitute for *M* unity, and for *g* the intensity of gravity at Paris, the value of *w* becomes

* Report on Weights and Measures, by Professor A. D. Bache. Thirty-fourth Congress, Third Session. Ex. Doc. No. 27.

$$w = 9.8096 \text{ grammes}; \quad [51.]$$

that is, the unit of mass weighs at Paris 9.8096 gram. Any quantity of matter, then, which weighs at Paris 9.8096 gram., is the unit of mass. The weight of the unit of mass evidently varies with the intensity of gravity; thus, at the poles the unit of mass weighs 9.8315 gram., at the equator it weighs 9.7806 gram. The differences are very much greater on the surfaces of the sun, moon, and planets; thus, on the sun the unit of mass weighs about 277.5 gram., on the moon about 1.654 gram., and on the planet Jupiter about 26.243 gram. In general, a quantity of matter which weighs as many grammes as the number which expresses the intensity of gravity at the place of observation, is equal to the unit of mass.

From equation [48] we have, by transposition, $M = \frac{w}{g}$. Hence, in order to find the number of units of mass of which a body consists, we have only to divide its weight in grammes by the intensity of gravity at the place of observation. For example, 500 grammes of iron at Paris contain $\frac{500}{9.8115} = 50.98$ units of mass.

(68.) *Density*. — The density of a substance has been defined as the mass of one cubic centimetre of the substance (15), and from [1] we have $D = \frac{M}{V}$, or, substituting for M its value, $\frac{w}{g}$, and then for $\frac{w}{V}$ the symbol *Sp. w*, we obtain

$$D = \frac{w}{g \cdot V} = \frac{\text{Sp. } w}{g} \text{ (units of mass)}. \quad [52.]$$

The density of copper, for example, is equal to $\frac{8.921}{9.810} = 0.909$ unit of mass. Density has, therefore, the same relation to specific weight that mass has to weight. It is always equal to the weight of one cubic centimetre of the substance divided by the intensity of gravity. It is evidently a constant quantity, and does not vary with the intensity of gravity.

(69.) *Specific Gravity*. — The specific gravity of a substance is the ratio of its absolute weight to that of an equal volume of pure water at 4° C. and at the same locality. If w represents the absolute weight of the substance at any place, and w' the weight of an equal volume of water at the same place, then

$$\text{Sp. Gr.} = \frac{w}{w'}. \quad [53.]$$

Moreover, since $w = M \cdot g$, and $w' = M' \cdot g$, we have, also,

$$Sp. Gr. = \frac{M \cdot g}{M' \cdot g} = \frac{M}{M'}. \quad [54.]$$

Hence the specific gravity of a substance is likewise the ratio of its mass to the mass of an equal volume of water. It is, therefore, like the density, a constant quantity, and does not vary with the intensity of gravity.

In the French system, one cubic centimetre of water at 4° C. weighs at Paris one gramme, and hence at Paris the weight in grammes of a given volume of water at 4° C. is always equal to the number of cubic centimetres. We may therefore substitute in [53], for w' , the volume in cubic centimetres. If we also designate by W the absolute weight of a body at Paris, and by $Sp. W.$ the specific weight at Paris, we can obtain from [53] and [50],

$$Sp. Gr. = \frac{W}{V} = Sp. W. \quad [55.]$$

From this equation, it appears that the numbers expressing the specific gravity of a substance and its specific weight at Paris are always the same in the French system. The difference, however, between the two is an essential one. $Sp. W.$ always stands for a certain number of grammes, but $Sp. Gr.$ is a ratio. When we say that the specific weight of copper is 8.921 grammes, we mean that one cubic centimetre of copper weighs at Paris this number of grammes; but when we say that the specific gravity of copper is 8.921, we merely mean that a volume of copper weighs 8.921 as much as the same volume of water. The first number is variable, depending on the unit of weight used; the last is invariable, and hence the same with all systems of weights. It is only in the French system of weights that the two numbers are the same.

We can easily obtain from [55],

$$V = \frac{W}{Sp. Gr.}, \quad \text{and} \quad W = V \cdot Sp. Gr. \quad [56.]$$

These simple formulæ should be remembered, as they will be constantly used in the course of this work.

It is more usual to refer the specific gravity of gases to air, as a standard of comparison, than to water. It will be shown hereafter that the weight of a given volume of air varies very

greatly, both with the temperature and the atmospheric pressure to which it is exposed; and it is therefore essential, in using air as a standard of comparison, to adopt arbitrarily a certain temperature and pressure, at which it shall be considered as the standard. The temperature which has been generally agreed upon is 0° C., and the pressure which has been adopted is that corresponding to a height of 76 c. m. of the barometer.

We may then define the specific gravity of a gas as the ratio of its weight to that of an equal volume of air at 0° C. and under a pressure of 76 c. m. Representing by W the weight of a given volume of gas at Paris, and by W' and W'' the weights respectively of the same volumes of water and air at the standard temperatures and pressure, — also representing by *Sp. Gr.* the specific gravity of the gas referred to water, and by *Sp. Gr.* the specific gravity referred to air, — we have

$$\text{Sp. Gr.} = \frac{W}{W'}, \quad \text{and} \quad \text{Sp. Gr.} = \frac{W}{W''}. \quad [57.]$$

When the specific gravity of a given substance is referred to one standard, it is frequently required to calculate its specific gravity with reference to the other, or, in technical language, to reduce the specific gravity to the other standard. For this purpose, we know that the specific gravity of air with reference to water is equal to 0.00129363. Hence, $\frac{W''}{W'} = 0.00129363$, and by substituting the value of W' , obtained from this in [57], we can easily obtain

$$\text{Sp. Gr.} = \text{Sp. Gr.} \cdot 0.00129363, \quad [58.]$$

a formula by means of which the reduction can easily be made.

A table giving the specific gravities of some common substances will be found at the end of this Part.

(70.) *Unit of Force.* — The unit of force has been defined as that force which, acting on the unit of mass during one second, will impress upon it a velocity of one metre (29). Since the unit of mass weighs at Paris 9.810 grammes, we can also define the unit of force as that force which, acting during one second, will impress on 9.810 grammes of matter a velocity of one metre. Moreover, it follows from [14] that a force which will impress during one second a velocity of one metre on 9.810 grammes of matter, is equal to the force which will impress a velocity of 9.810

metres on one gramme of matter. But this force is the same as the force exerted by gravity on one gramme of matter. In other words, it is equal to the weight of one gramme. We have, then, a new measure for our unit of force. The unit of force is the force exerted in pressure by the unit of weight. When a weight of ten grammes, for example, is suspended to a fixed point, the pressure exerted by that weight is equivalent to ten units of force.

(71.) *Relative Weight.* — There are, in general, two methods by which the weight of a body (that is, the pressure which it exerts) may be determined.

The first method consists in balancing the pressure against a spring, and determining the weight from the amount by which the spring is bent. An instrument for this purpose is represented in Fig. 35. It consists of a steel spring, bent in the form of a V. To the end of the lower arm is fastened an iron arc, which passes freely through an opening in the upper arm, and ends in a ring. To the end of the upper arm a similar iron arc is fastened, which passes through an opening in the lower arm, and terminates in a hook.



Fig. 35.

In using the instrument, the body to be weighed is suspended by the hook, as in Fig. 35, and the number of grammes by which the spring is bent is then read off on the graduated arc. Such an instrument is called a *spring balance*, and indicates at once the absolute weight of a body. Could it be made sufficiently delicate, it would show that the absolute weight of a body varied on the earth's surface, gradually increasing from the equator towards the poles. Such an instrument would give the absolute weight of a body.

The second method consists in preparing a set of so-called weights, which are masses of brass or platinum weighing exactly one gramme, or some multiple or fraction of a gramme, at Paris. The weight of a body is then estimated by balancing it against these weights in a well-known instrument called the *balance*. The balance is merely a form of the lever, so constructed that, when equal pressures are exerted on its two pans, the beam stands in a horizontal position. The body to be weighed is placed in one pan, and then weights are added to the other until

the beam of the balance rests in a horizontal position. The sum of these weights then indicates the weight of the body. At Paris the balance indicates at once the absolute weight of a body, but not necessarily so at other places on the earth's surface. To illustrate this point, let us suppose that, in weighing at Paris, it required ten grammes' weight in one pan of the balance to equilibrate the body in the other pan. Suppose, now, that we transport the whole apparatus to some point on the equator. It is evident that our gramme weights no longer weigh one gramme each, but something less, by an amount easily calculated from the diminution in the intensity of gravity. Nevertheless, since the body has lost weight in the same proportion, it will still be balanced by the ten gramme weights, and so it would be all over the globe. This weight, which is frequently called *relative weight*, will always be designated in this work by W , in order to distinguish it from the absolute weight at other localities, which we have already designated by \mathfrak{w} . Hence we have, from [48],

$$W = M \cdot 9.8096, \quad \text{and} \quad \mathfrak{w} = M \cdot g, \quad [59.]$$

Since the force of gravity at any given locality, and hence at Paris, does not vary, it follows that the relative weight of a body, or W , is a constant quantity; the same at any point on the surface of our globe, and the same on the sun, moon, and planets as it is on the earth.

We can easily find the absolute weight of a body at any locality, when its relative weight is known. Representing, as above, by W the relative weight of the body, and by \mathfrak{w} the absolute weight required at the place in question, we have, from [59],

$$\mathfrak{w} : W = M \cdot g : M \cdot 9.8096, \quad [60.]$$

and

$$\mathfrak{w} = W \frac{g}{9.8096}; \quad [61.]$$

that is, the absolute weight of a body at any place is equal to the absolute weight at Paris (or the relative weight of the body at the place) multiplied by the ratio between the intensity of gravity at the place and that at Paris.

Relative weight is the direct measure of the mass of a body. Representing by m the mass of the unit of weight, we have $1 \text{ gr.} = m \cdot 9.8096$. By comparing this equation with $W = m \cdot 9.8096$ we obtain $W = \frac{M}{m}$; that is, the relative weight of a

body indicates the quantity of matter which it contains, compared with that contained in one cubic centimetre of water at 4° C. It is therefore a legitimate measure of the quantity of matter contained in a body, and the word *weight* is almost exclusively used in this sense in chemistry, as it is in common life.

MECHANICAL POWERS.

(71 *bis.*) *Machines.*—By the aid of wheels, rods, bands or cords, and inclined surfaces, power may be readily transmitted from one point to another, and the intensity, direction, point, and mode of application of the acting force varied in a multiplicity of ways. The numerous contrivances by which such changes are effected are termed, in general, *machines*. All machines, however complicated their structure, will be found on examination to consist of a limited number of simple parts, generally called mechanical powers, or simple machines. Among these we usually distinguish six; viz. the lever, the wheel and axle, the pulley, the inclined plane, the wedge, and the screw. Of each of these, however, there are many varieties; and the skill of the inventor is shown no less in adapting these parts of his machine to their special purpose, than in combining the parts so that they shall act harmoniously together to produce the desired result. A description of the various mechanical powers, or of their important applications, is entirely beyond the scope of this work. There is, however, one important general principle connected with the subject which may be noticed in passing. A machine transmits power without increasing it in the slightest degree. Indeed, more or less power is always lost during the transmission, in overcoming friction and other causes of resistance. The use of a machine is to adapt power to the work to be done. It may change the direction or the velocity of the motion caused by the power; it may change the mode of action of the power; it may change the intensity of the power, and enable a feeble force, by acting through a great distance, or during a long time, to overcome a great resistance. It may modify the action of the power in an infinite variety of ways, so as to produce the useful effects of which machinery is capable, but it will be found in every case that the work done by the machine is the exact equivalent of the power it receives. One only of the mechanical powers requires further notice in this work.

THE BALANCE.

(72.) *Lever*. — Before studying the theory of the balance, it is important to consider the general theory of the lever, of which the balance is only a single example.

A lever is any rigid bar, AB (Fig. 36), resting on a point, c , round which two forces tend to turn it in opposite directions.

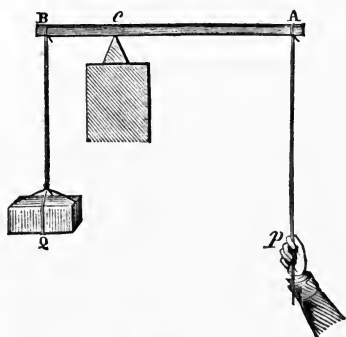

Fig. 36.

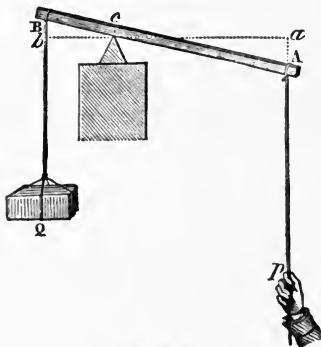

Fig. 37.

The point c is called the *fulcrum*. The force applied at A is called the *power*, and the force applied at B is called the *resistance*, or the *weight*. Levers are commonly divided into three kinds, according to the position which the fulcrum has in relation to the power and the weight. If the fulcrum is between the power and the weight, as in Figs. 36, 37, the lever is of the first kind. If

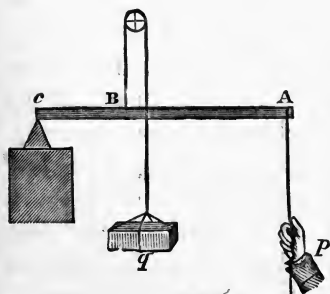

Fig. 38.

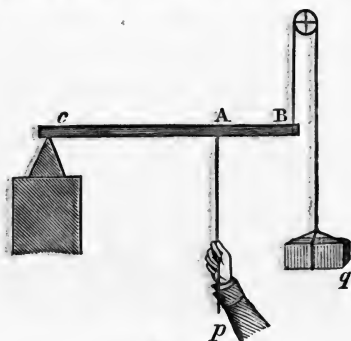

Fig. 39.

the weight is between the fulcrum and the power, as in Fig. 38, the lever is of the second kind. If the power is between the

fulcrum and the weight, as in Fig. 39, the lever is of the third kind.

In the three kinds of lever, the perpendicular distances from the fulcrum to the lines of direction of the two forces are called the *arms* of the lever. If the lever is straight, and perpendicular to the directions of both of the two forces, the two portions of the lever, $A c$ and $B c$, Fig. 36, are themselves the arms of the lever. If, however, the lever is not straight, or is inclined to the direction of one or both of the forces, the arms of the lever are the perpendiculars, $a c$ and $b c$, Fig. 37, $a O$ and $b O$, Fig. 40, let fall from the fulcrum on these directions.

In order that the two forces applied to the lever should be in equilibrium, three conditions are essential:—

1st. The lines of direction of the two forces must be in the same plane with the fulcrum.

2d. The two forces must tend to turn the lever in opposite directions.

3d. The intensity of the two forces must be to each other inversely as the lengths of the arms of the lever to which they may be regarded as applied.

That these three conditions are essential to equilibrium can easily be proved. In the first place, it is evident that the two forces cannot be in equilibrium, unless the direction of their resultant passes through the fulcrum. Now it can easily be

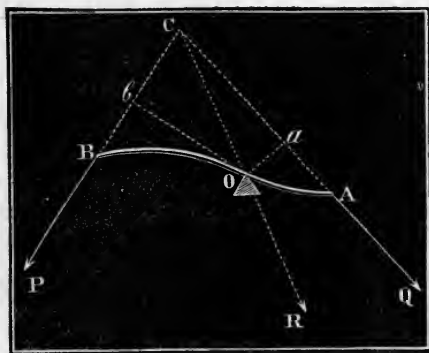

Fig. 40.

proved, that, unless the two forces are in the same plane, they can have no single resultant; and hence follows the necessity of the first condition. In the second place, let us suppose, Fig. 40, that $A Q$ and $B P$ are the lines of direction of two forces in the same plane with the fulcrum O , and that C is the point where these directions intersect;

then, in order that the direction of the resultant $O R$ should pass through O , it is evident that the directions of the

components should be such that they would tend to turn the lever in opposite directions.

The necessity of the third condition will be most readily seen if studied under two cases. In the first place, let us take the case where the two forces are parallel, as in Fig. 37. It has been proved (37) that the point of application of the resultant of two parallel forces divides the line joining the points of application of the components into two parts, which are inversely proportional to the intensities of the forces. Hence it follows, that, in order that the direction of the resultant in Fig. 37 should pass through the fulcrum, the two forces applied at *A* and *B* must be inversely proportional to *Ac*

and *Bc*, and hence also to *ac* and *bc*, which are the arms of the lever. In the second place, let us suppose that the directions of the forces are not parallel, as in Fig. 41. In this figure, *AQ* and *BP* represent the directions of the forces,

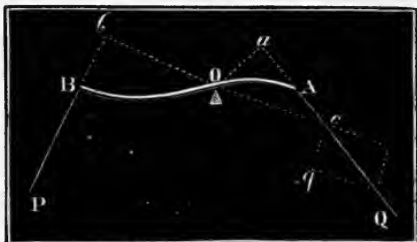

Fig. 41.

which we will represent by *F* and *F'*, and *aO* and *bO* the arms of the lever. By the principle of (32), the effect of these forces is the same as if they were applied respectively at *a* and *b*, points which we may consider as immovably united to the lever. From *O* extend the line *bO* until it intersects the direction *AQ* at a point *c*. By the same principle as above, the effect of the force *F* is the same as if it were applied at *c*. We can now evidently consider this force as made up of two others perpendicular to each other, one acting in the direction *Oc*, which will be neutralized by the resistance of the fixed point *O*, and the other in the direction *cq* parallel to *BP*. Complete the parallelogram, and let us suppose that *F = cQ*, and hence that the component parallel to *BP* is equal to *cq*. It follows now, from the proof given above, that there can only be equilibrium when

$$F' \times Ob = cq \times Oc, \text{ or } cq = \frac{Ob \times F'}{Oc}.$$

But from the similarity of the triangles *cqQ* and *cOa*, we have *cq : Oa = cQ : Oc*, and by substituting for *cQ* and *cq* their values just given

$$F' : O a = F : O b. \quad [65.]$$

It is, then, also a condition of equilibrium, that the two forces should be to each other inversely as the lengths of the arms of the lever, the point which was to be proved. We have proved the validity of the three conditions of equilibrium for the first kind of lever only; but this proof can easily be extended to the second and third kinds of lever.

It follows from what has been said, that the tendency of the power to turn the lever may be augmented either by increasing the amount of the power, or by increasing the length of the arm of the lever on which it acts; that is, by increasing the perpendicular distance of the direction of the force from the fulcrum. In either case, the effect will be increased in a corresponding proportion. Thus, if we remove the power to double its distance from the fulcrum, we shall double its effect; and if we remove it to half the distance, we shall diminish its effect by one half. The perpendicular distance of the direction of a force from the fulcrum is called its *leverage*; and it is evident that the effect of any force applied to a lever will be proportional to its leverage.

From proportion [65] we obtain, by multiplying together the extremes and the means, $F \times O a = F' \times O b$. The product of the intensity of a force by the length of the perpendicular let fall from a fixed point to the line of direction of the force, is called the *moment* of the force with respect to the point. Since $O a$ and $O b$ are such perpendiculars, it follows that, when a lever is in equilibrium, the *moments* of the *power* and *resistance* are equal.

(73.) *The Balance.* — The instrument by means of which the weight of a substance is compared with the unit of weight, is called a *Balance*. It is generally made of brass, and consists essentially of an upright pillar supporting a beam, $B B$, Fig. 42, which turns upon a knife-edge, placed exactly at the middle of its length. From the two ends of the beam are suspended the pans, in which the weights to be compared are placed. The knife-edge is formed by a triangular steel prism passing through the beam, whose axis is exactly at right angles with the plane of the beam. The lower edge of the prism is sharp, and rests upon an agate plane, so as to make the friction as small as possible. For the same reason, the hooks by which the pans are suspended rest also on knife-edges. These knife-edges

are adjusted perpendicularly to the plane of the beam, and on the same level as the fulcrum. The fulcrum is so placed that the centre of gravity of the beam shall be slightly below it, so that

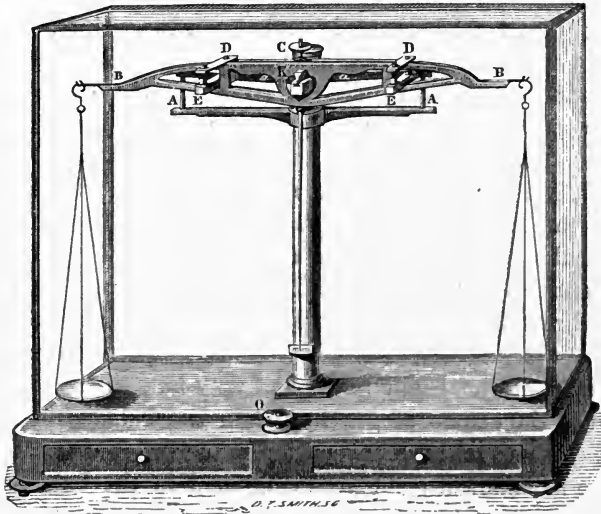

Fig. 42.

when in equilibrium the beam will tend to come to rest in a horizontal position. The centre of gravity can be adjusted by means of the button *C*, Fig. 42, which can be moved up or down on the screw to which it is fastened. The long index-rod attached to the beam below the knife-edge indicates, by the graduated arc, when the beam is horizontal. When the balance is not in use, the beam can be lifted off from its bearing, and supported upon the brass arms *E, E*. These are attached to the cross-piece *a*, which can be raised or lowered by turning the thumb-screw *O*. The motion of the cross-piece is directed by the two pins *A, A*, which play loosely through holes at its two ends.

A balance is evidently a lever with equal arms, and, according to the principle of the lever, if equal weights are placed in the two pans, they will exactly balance each other. The balance, therefore, enables us to compare the weight of a substance with the unit of weight. We have simply to place the substance in one pan of the balance, and then add weights, which have been adjusted by the standard unit, to the other, until the beam assumes a horizontal position, or until it vibrates to an equal distance on

both sides of this position, — as can be observed by the motion of the index over the graduated arc. The sum of the weights required to balance the substance is, then, its relative weight in terms of the unit of weight employed.

The usefulness of a balance depends upon two points, — 1st, its *accuracy*, and, 2dly, its *sensibility* to slight differences of weight. An examination of the conditions on which these depend, will lead us to understand better the principle of this very important instrument. From the mode in which the pans of a balance are suspended, it is obvious that we may regard their whole weight as concentrated on the knife-edges at the ends of the beam. In a theoretical consideration of the subject, we may therefore leave the pans entirely out of view, and consider any weight placed in them as directly applied to the knife-edges, thus reducing the balance to a straight lever. From another point of view, the whole weight of the beam and pans may be considered as concentrated at the centre of gravity, when the balance becomes a pendulum, whose point of suspension is the fulcrum of the beam. These two mechanical principles, combined in the balance, have constantly to be kept in view in studying its theory. It will then be easy to understand the following circumstances, on which the accuracy and sensibility of the instrument depend.

1. It is necessary that *the distances of the two knife-edges from the fulcrum should be exactly equal*; for if the distance from the fulcrum of the point of suspension of one pan were greater than that of the other, then a weight placed in the first, acting under a greater leverage, would balance a larger weight in the last, and the larger in proportion to the inequality of the two arms of the beam.

2. It is necessary that *the centre of gravity of the beam and pans should be below the fulcrum, and as near to it as possible*. Were the centre of gravity at the fulcrum, the beam would not oscillate, but remain in whatsoever position it were placed. Were it above the fulcrum, the beam would be overset by the slightest impulse. When it is below the fulcrum, the beam, as already stated, may be regarded as a pendulum, whose axis coincides with the line joining the fulcrum and centre of gravity. As this line forms right angles with the axis of the beam in whatever position the latter may be placed, and as the pendulum tends always to fall back to the perpendicular position whenever

removed from it, it follows that, if we impart an impulse to the beam of a properly adjusted balance, it will, after vibrating for some time, invariably return to a horizontal position. The centre of gravity of the beam is exactly under the fulcrum, and in a line at right angles to the axis only when the two pans are equally loaded. If unequally loaded, the centre of gravity is to the right or to the left of this line; and in that case the beam tends to come to rest at an angle to the horizontal position, rapidly increasing with the inequality of the weight until the beam is entirely overset. In weighing with a delicate balance, it is not necessary to wait until the beam comes to rest, in order to ascertain whether the pans have been equally loaded. This can be ascertained more promptly by noticing the amplitude of the vibrations of the index on either side of the perpendicular, by means of the graduated arc. They will be equal only when the weights in the two pans are equal.

The sensibility of a balance depends in great measure on the nearness of the centre of gravity to the fulcrum. In order that a small weight, placed in one pan of a balance, should *turn the beam*, it must evidently overcome two forces; first, the friction of the knife-edges on their bearings, and, secondly, the tendency of the beam to remain in a horizontal position. This tendency depends, as has already been shown, upon the position of the centre of gravity below the point of support. Let us now compare two cases in which the centres of gravity are at different distances from the fulcrum,

and ascertain in which case the force required to turn the beam will be the least. In Fig. 43, suppose the line ab to be the axis of the beam, O the fulcrum, and g or G the centre of gravity. We have now to inquire in what position of the centre of gravity it will

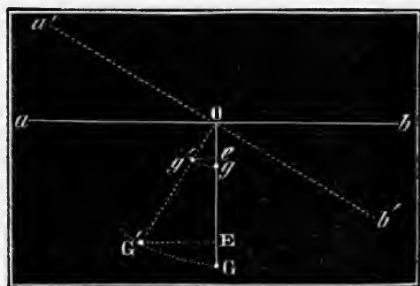

Fig. 43.

require the least force to bring the beam to a new position, $a' b'$. In order to bring the axis of the beam to this position, it will be necessary to bring the centre of gravity from g to g' , or from G to G' . In the first case, it will be necessary to raise the whole

weight of the beam and pans, which we suppose concentrated at g , through the perpendicular distance $g e$; and in the second case, to raise the same weight through the distance $G E$. Since the distance $g e$ is much less than the distance $G E$, it is evident that it will require a less force in the first case than in the second. Hence, the sensibility of the balance is the greater, the nearer the centre of gravity is to the fulcrum.

3. It is important that *the points of suspension of the pans should be on an exact level with the fulcrum*. The importance

of this condition may be seen, by remembering that an increase of weight in the pans is equivalent to adding just so much weight upon the points of suspension, and therefore tends to draw the centre of gravity towards the line (Fig. 44) connecting the two. If this line passed above the fulcrum, as in Fig. 45, then, by increasing the weight in the pans, the centre of gravity might be brought to coincide with, or even be carried above, the fulcrum, when the balance would become useless. If this line, as in Fig. 45, passed

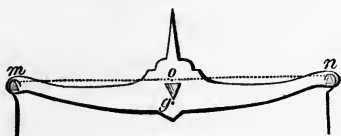

Fig. 44.

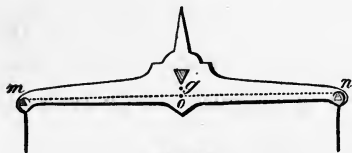

Fig. 45.

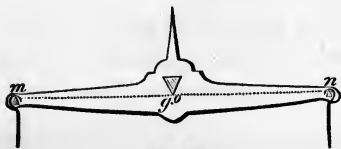

Fig. 46.

below the fulcrum, an increase of weight in the pans would tend to draw down the centre of gravity; and thus, by increasing its distance from the fulcrum, would diminish the sensibility of the balance. When, however, the line passes through the fulcrum, as in Fig. 46, the points of suspension of the pans are on an exact level with the fulcrum, and an increase of load always tends to raise the centre of gravity towards the fulcrum in proportion to its amount; so that a well-adjusted balance theoretically should turn with the same weight, whatever may be the load placed upon it, from the smallest to the largest of which its construction admits.

This last point can be still further illustrated in the following manner. It has already been shown, that the weight required to

turn the balance, when unloaded, may be measured by the force required to raise the centre of gravity of the beam and pans through a small arc, $G G'$ (Fig. 43), when applied at b' . Let us suppose that the pans are loaded with a weight of one kilogramme each. It is evident, from what has been said, that this is equivalent to condensing a mass of matter equal to one kilogramme at each of the points a and b . The centre of gravity of these masses must evidently be at the middle of the line ab , that is, at the fulcrum of the balance. Since, then, this additional weight is supported in any position of the beam, it follows that the weight required to turn the balance is still measured only by the force required to raise the centre of gravity of the beam and pans through the arc G, G' , or, to generalize, the absolute weight required to turn the balance is the same, whatever may be the load. This, however, is only theoretically true, for in practice the weight required increases with the load, in consequence of the increased friction and the slight bending of the beam which it causes. While, however, the absolute weight required to turn the balance increases from these causes with the load, the proportion of this weight to the whole load diminishes. This is what is usually meant by the sensibility of the balance, and in this sense, evidently, the sensibility increases with the load.

4. It is important that the friction of the knife-edges on their bearings should be as slight as possible. The importance of this circumstance is so evident, that it does not require illustration. It is secured by a careful construction of the knife-edges, and by making the beam as light as is consistent with rigidity.

In endeavoring to combine these conditions, the balance-maker meets with many practical obstacles. If he endeavors to increase the sensibility of his balance by diminishing the weight of the beam, he soon finds that he loses as much as he gains, by the increased flexure. If, again, he attempts to increase the sensibility by lengthening the beam, he soon comes to a limit, beyond which the increased leverage is more than compensated by the increased friction due to the necessarily increased weight of the beam. Nevertheless, by carefully attending to the necessary conditions, balances may be constructed with a remarkable degree of sensibility. They have been made so delicate, that, when loaded with ten kilogrammes, they will turn with one milligramme, that is, with one ten-millionth of the load.

PROBLEMS.

Centre of Gravity.

51. Two masses of matter are immovably united, $A = 14$ units of mass, and $B = 10$ units of mass. What is the position of their common centre of gravity?

52. A mass of matter, A , = 15 units of mass, is immovably united to a second mass, B . It is found by experiment that the common centre of gravity of the two masses is nearest to A , and divides the line connecting the masses into two parts, which are to each other as 2 is to 3. What is the mass of B ?

Intensity of the Earth's Attraction.

In these problems, the student is expected to use the values of g given in the table on page 76.

53. What is the intensity of the earth's attraction, at Paris, on a body whose mass is equal to 25 units of mass? What is the intensity of the force of gravity, at Paris, on bodies whose masses are respectively 20, 60, 720, 430, and 510 units of mass?

54. What is the intensity of the earth's attraction, at Paris, on a body whose mass is equal to 0.1019 unit?

Pendulum.

55. What is the time of vibration, at Paris, of a pendulum which is 0.99394 metre long? What are the times of vibration of pendulums which are respectively twice, three times, four times, five times, and nine times this length? The amplitude in each case is supposed to be infinitely small, and the pendulum to oscillate in a vacuum.

56. If the amplitude of the oscillation of the pendulum of the last example is 9° , how much would the duration of an oscillation be increased? Solve the same problem for amplitudes of 1° , 2° , 4° , and 5° .

57. If the pendulum of a clock, beating seconds at Paris, were lengthened by expansion one ten-thousandth of its length, how many seconds would it lose each day?

58. If a clock, keeping perfect time at Paris, were carried to Spitzbergen, how much would it gain each day, on the supposition that all the conditions, with the exception of the intensity of gravity, remained the same? How much would it lose if carried to the equator?

59. A pendulum on the equator, 0.990934 metre long, was found to oscillate in one second. What is the intensity of gravity?

60. A pendulum at Paris one metre long was found to oscillate in 1.00304 seconds. What was the intensity of gravity?

61. A pendulum at Paris four metres long was found to oscillate in 2.00608 seconds. What was the intensity of gravity?

62. What is the intensity of gravity at the latitude of $42^{\circ} 21'$? What is the length of the seconds pendulum at this latitude?

63. What is the intensity of gravity, and what the length of the seconds pendulum, on the following parallels of latitude, viz. 15° , 22° , 56° , and 74° ?

64. What is the intensity of the centrifugal force on the parallels of latitude of 5° , 20° , 30° , 50° , and 70° ? What is the absolute intensity of gravity on these parallels?

65. What is the intensity of gravity at the summit of Mt. Washington, New Hampshire? Latitude of Mt. Washington, $44^{\circ} 15'$. Height of summit above the sea-level, 2,027 metres.

66. What is the intensity of gravity at the summit of Mt. Blanc? Latitude of Mt. Blanc, $45^{\circ} 50'$. Height of summit above the sea-level, 4,814 metres.

Weight.

67. What is the weight of a body containing 10 units of mass at Paris? What is the weight of the same body at Boston? The latitude of Boston is $42^{\circ} 21'$.

68. What is the weight of a body containing 500 units of mass, at the equator and at the poles?

69. What is the specific weight of iron at Paris? What are the specific weights of lead, tin, mercury, sulphur, sodium, and lithium, at Paris? and also at Boston?

Mass.

70. What is the mass of 100 kilogrammes of iron? What are the masses of 50 grammes of sulphur, of 40 grammes of mercury, of 90 kilogrammes of granite, when the value of g is 9.810?

71. What is the mass of 75 kilogrammes of ice, of 20 kilogrammes of common salt, of 50 grammes of air, when $g = 9.810$?

72. What is the mass of a cubic decimetre of lead? What is the mass of a cubic decimetre of ice? Sp. Gr. of Ice = 0.930.

73. What is the mass of 1,000 cubic metres of atmospheric air? What that of the same volume of hydrogen gas?

Density.

74. What is the density of hammered copper? What is the density of the following substances,—lead, tin, mercury, sulphur, sodium, and lithium? Calculate the density from the *Sp. W.* as obtained by solving the 69th example, or else from the *Sp. Gr.* given in the Table at the end of this volume.

75. What is the density of air, of oxygen, of hydrogen, and of nitrogen,

at the temperature of 0° C. and under a pressure of 76 c. m.? The relative weight of one cubic decimetre of these gases will be found in Table II. at the end of this volume.

Relative Weight.

76. The absolute weight of a body at Paris is 500 gram. What is its relative weight?

77. The relative weight of a body at New Orleans is 450 gram. What is its absolute weight at the same place? The latitude of New Orleans is $29^{\circ} 57'$.

78. The relative weight of a body at Paris is 1,250 gram. What is its absolute weight at Boston?

79. The relative weight of a body is 12,300 gram. What is its absolute weight at Quito? The latitude of Quito is $0^{\circ} 13'.5$, and its elevation above the sea-level is 2,908 metres.

80. The relative weight of a body is 5,450 gram. What is its mass? Find also the masses of the bodies whose weights are respectively 560 gram., 4,945 gram., and 500 gram.

81. The relative weight of a body is 5,255 gram., its volume is 500 c. m.^3 . What is its mass? what is its density? and what is its specific gravity?

82. The specific gravity of a body is 7.248, and its volume 500 c. m.^3 . What is its density, mass, and weight?

83. The mass of an iron cannon is 5,000 units, and its specific gravity 7.248. What is its volume and density?

84. The specific gravity of a gas referred to water is 0.00143028, and its volume 500 m.^3 . What is its density, mass, and weight?

85. What is the specific weight, the mass, and the density of 500 c. m.^3 of mercury?

Unit of Force.

86. A body having a density of 2 units and a volume of $1,000 \text{ c. m.}^3$ acquires, under the influence of a given force, an acceleration of 8 c. m. each second. What is the intensity of the force?

87. A body whose weight is 100 kilogrammes acquires an acceleration of 8 m. each second. What is the intensity of the force?

88. A body whose specific gravity is 2 and whose volume is 50 m.^3 acquires an acceleration of 10 m. each second. What is the intensity of the force?

89. On a body weighing 100 kilogrammes a force of 15 kilogrammes is constantly acting. What acceleration does it impart to the body?

90. To a body whose volume equals 10 m.^3 a force of 300 kilogrammes imparts a constant acceleration of 10 m. What is the density of the body?

ACCIDENTAL PROPERTIES OF MATTER.

(74.) *Divisibility*. — We have now considered the first four of the *general properties* of matter enumerated in (7). All of these, with the exception of *weight*, are *essential properties*, and are necessarily associated with the very idea of matter. The four general properties which remain to be studied do not seem to be so essential, for we can conceive of a kind of matter which should not possess them. This is true, for example, of *divisibility*. We can easily conceive of a kind of matter so hard as to be physically indivisible, although no such matter is known to exist. In fact, all kinds of matter, even the hardest, can be subdivided, and, so far as we know, indefinitely; the only limit to our power of subdivision being that fixed by the imperfection of our senses.

The extent to which, in some cases, the subdivision may be carried is almost incredible. The goldbeater can hammer out a single gramme of gold until it covers a surface of $4,364 \text{ c. m.}^2$, when the gold-leaf is so thin, that fifteen hundred such leaves placed upon one another would not equal in thickness a single leaf of ordinary writing-paper. The surface of gold on the gilt wire used in embroidery is much thinner even than this. It has been calculated that its thickness does not exceed one ten-millionth of a centimetre; and if so, with the aid of the microscope magnifying five hundred diameters, a particle of gold can be distinguished upon it not weighing more than one forty-two-million-millionth of a gramme.

The organic kingdom presents us with examples of the subdivision of matter which are still more remarkable. The microscope has proved the existence of animals which are as minute as the particle of gold mentioned above, and yet each of these creatures is composed of organs of locomotion and nutrition, like the larger animals. The finest human hair is about one two-hundred-and-fortieth of a centimetre in diameter. This is generally considered very fine; but the hair is a massive cable in comparison with many animal fibres. The spider's thread is in some instances not more than one twelve-thousandth of a centimetre in diameter, and yet each of these threads is formed by the union of from four to six thousand fibrils. It has been calculated that one gramme of this thread would reach about fifty miles.

Science has not succeeded in discovering a limit to the divisibility of any one kind of matter. Nevertheless, the opinion has been maintained, and is still held by many scientific men, that matter is not indefinitely divisible, and that all bodies are made up of an exceedingly large number of absolutely hard, and hence indivisible particles, called *atoms*. According to the *atomic theory*, as this hypothesis is called, the ultimate particles of matter are indestructible and unchangeable, and hence all physical and chemical phenomena are caused by changes in their relative position or grouping.

As these atoms are supposed to be far smaller than the minutest portions of matter which we can distinguish with the microscope, they are beyond the limits of direct observation, and their existence is therefore a matter of inference from physical and chemical phenomena. It is not necessary, however, in order to explain these phenomena, to suppose that these atoms have any absolute size. We may, with Newton, regard them as infinitely small, that is, as mere points, or, as Boscovich called them, variable centres of attractive and repulsive forces; and all the phenomena can be as fully explained on this supposition as on the other. According to this view, matter is purely a manifestation of force, and only continues to exist through the constant action of that Infinite Will with whom all force originates. As it will be constantly necessary to refer to these centres of attractive and repulsive forces in matter, we will, for convenience, term the minute portions of matter in which they may be supposed to reside *molecules*, and the forces themselves *molecular forces*.

(75.) *Porosity*. — The interstices between the different parts of bodies are called *pores*. The visible cavities of the sponge, for example, are pores of a large size; the meshes, of which its tissues consist, are pores of a smaller size; but in addition to these, there are pores between the fibres of the sponge themselves, although they are so minute that they cannot be seen. In like manner, a thin slice of the hardest wood, examined under the microscope, is found to be full of pores (see Figs. 47, 48); and the same is true, to a greater or less degree, of all organic structures, as well as of the tissues which are manufactured with animal or vegetable fibres. The porosity of such substances is well illustrated by the process of filtering. The filters which are used in the arts and in chemical experiments are simply porous

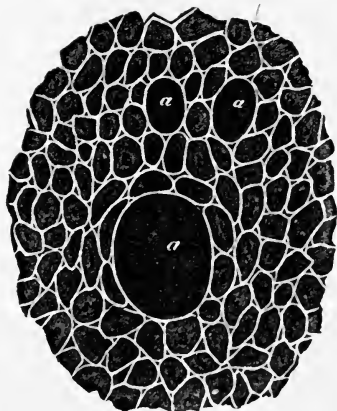

Fig. 47.

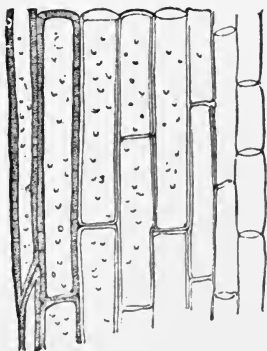

Fig. 48.

bodies, whose pores are large enough to allow fluids to pass through them, but, on the other hand, small enough to arrest the solid particles, which they hold in suspension. The simplest and most useful form of a filter is a cone of porous paper supported in a glass funnel.

The porosity of organic substances may also be illustrated by the apparatus represented in Fig. 49. It consists of a glass tube, *A*, closed from above by a plug of hard wood cut transversely to its fibres, or by a piece of chamois skin, as is represented at *o*. The whole is surmounted by a tunnel-shaped cup, which may be filled with mercury. On exhausting the tube by means of an air-pump, the pressure of air on the surface of the mercury forces it through the pores of the diaphragm, so that it falls in showers through the tube.

A lump of chalk plunged under water, and placed under the receiver of an air-pump, will, on withdrawing the air, expel a torrent of air-bubbles, which had been concealed

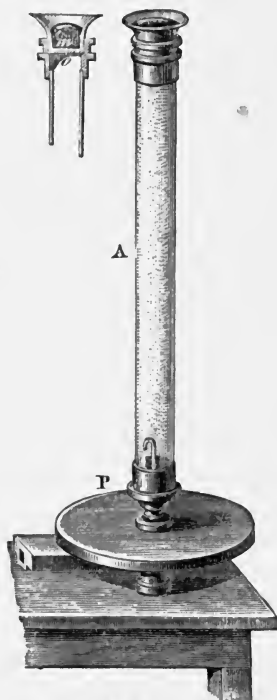

Fig. 49.

in the internal pores of the stone. The same is true of many other varieties of stone. There is a kind of agate, called hydrophane, which in its ordinary state is only semi-transparent, but after being plunged in water takes up about one sixth of its bulk of that fluid, and becomes nearly as transparent as glass. The porosity of metals was proved by the Academicians of Florence in the year 1661. They filled a hollow ball of gold with water, and submitted it to great pressure, by which the liquid was made to ooze through the pores of the metal. The same experiment has since been repeated on different metals, and with like success.

The porosity of gases and liquids is proved by their power of penetrating each other without a corresponding change of volume. This is illustrated by an experiment devised by Reaumur. He filled a long tube closed at one end, half with water and the remainder with alcohol. Having carefully closed the mouth of the tube, he inverted it in order to mix the two liquids, when he found that a contraction of the liquids took place.

Another experiment, illustrating the same property in regard to gases, is the following. A globe containing air is so arranged that small quantities of liquids can be introduced into it without allowing the air to escape. If, now, a few drops of alcohol are made to enter the globe, this alcohol will evaporate to as great an extent as if the globe were empty, and the space, which before contained only air, will now contain both air and alcohol vapor. If, next, some ether is forced into the globe, this liquid will also evaporate, and exactly as much ether vapor will be formed as if the globe had contained previously neither air nor alcohol vapor, and we shall then have the space occupied simultaneously by air, alcohol vapor, and ether vapor. In like manner, we may introduce any number of volatile liquids into the globe, and yet, so far as we know, each of these will evaporate to the same extent as if the globe were entirely empty, provided only that these substances do not act chemically on each other. We may thus have, as the result of spontaneous evaporation, twenty or thirty different vapors, all existing simultaneously in the same space.

By the experiments which have been cited, the porosity of most substances can be abundantly proved. The porosity of glass, however, and of many other substances, does not admit of such

proof; yet in these substances the porosity is rendered quite evident by the changes of bulk which they undergo under the influence of heat and cold.

We make an obvious distinction between the large pores, which exist especially in organized bodies, and the intermolecular spaces. The first arise from the want of continuity of the matter, and may be regarded in a measure as accidental, varying with the structure and organization of the body. They are frequently visible to the naked eye, or at least become evident with the aid of the microscope. The last are the exceedingly minute and invisible spaces which exist between the *molecules* of matter. Those philosophers who have admitted the existence of atoms, have generally concurred in the belief that the atoms even of the densest solids are very much smaller than the spaces which separate them. Sir John Herschel asks why the atoms of a solid may not be imagined to be as thinly distributed through the space it occupies, as the stars that compose a nebula; and compares a ray of light penetrating glass to a bird threading the mazes of a forest.

(76.) *Compressibility and Expansibility.* — The property of porosity necessarily implies that of compressibility and expansibility. According to the atomic theory, any body is capable of an indefinite expansion, because we may conceive of the distance between the atoms as being indefinitely increased. It could only, however, be compressed till the atoms come in contact. According to the other theory of the constitution of matter, advanced in (74), a body is capable of being both contracted and expanded indefinitely. These changes of volume are most readily effected by the action of heat, and, so far as we know, all bodies may be indefinitely expanded by heat and contracted by cold. These effects of heat will be considered at length in Chapter IV., and we shall therefore only allude in this place to a few examples of compression produced by *mechanical* means.

Pieces of oak, ash, or elm, plunged into the sea to the depth of 2,000 metres, and drawn up after two or three hours, have been found to contain four fifths of their weight of water, and to acquire such an increase of density as to indicate the contraction of the wood into about half its previous volume. Some of the metals have their bulk permanently diminished by hammering;

and so also in the process of coining, the volume of the metal is sensibly diminished by the pressure to which it is submitted under the die. The stone columns of buildings, also, when they sustain great weights, are frequently very sensibly shortened. This was the case with the columns which support the dome of the Pantheon at Paris.

It was long supposed that liquids were incompressible; but they are now known to be compressible, although only to a slight degree.

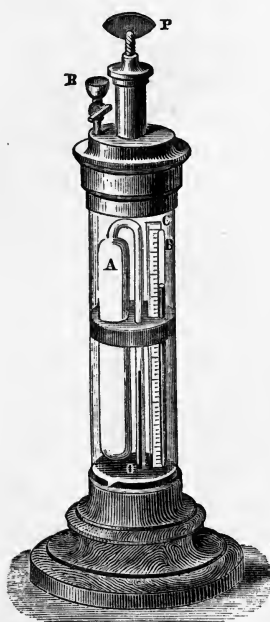

Fig. 50.

The compressibility of liquids may be illustrated by the apparatus represented in Fig. 50. It consists of a very thick cylindrical vessel of glass, eight or nine centimetres in diameter, which is closed at the bottom and supported on a basement of wood. To the top is cemented a brass cap, into which screws a copper plate, which, when in its place, completely closes the cylinder; but which can be unscrewed at pleasure, in order to remove and replace the tubes *A* and *B* within the cylinder. To this plate are adapted the tunnel *R*, for introducing water into the cylinder, and a cylinder with a piston for exerting pressure, which can be moved by the screw *P*. Within the apparatus is the elongated glass bulb *A*, which is filled with the liquid on which the experiment is to be made. This bulb opens into a bent capillary glass tube, whose open

end is plunged in the mercury which covers the bottom of the vessel. At the side of this apparatus is a manometer tube, *B*, which indicates, in a way which will be hereafter described, the amount of pressure.

In using the apparatus, the bulb *A* is first filled with the liquid to be compressed. This is then supported, as represented in the figure, in the interior of the cylinder, with the open end of the tube dipping under the mercury. The cylinder is now filled with water, and the pressure applied by turning the screw *P*. The mercury will then be seen to rise in the capillary tube, indi-

cating a compression of the fluid contained in the bulb. In order to measure the amount of compression, the capillary tube is graduated into parts of equal capacity, each of which bears a known relation to the capacity of the bulb. The total amount of compression, however, which we can thus produce, amounts only to a few millionths of the original volume.

The compressibility of gases is far greater than that of either of the other conditions of matter. If we take a glass cylinder closed at one end, Fig. 51, and insert into it an accurately-fitting piston, it will be found impossible to force the piston into the tube, if it be full of water; but if full of air, the force of the arm is sufficient to drive the piston down so as to reduce the volume of air ten or twenty times, if the piston is small. We feel the resistance increase in proportion to the compression; but, whatever may be the force exerted, we cannot make the piston touch the bottom of the tube. The compressibility of many gases is also limited by the fact that they are reduced by great pressure to a liquid state.

(77.) *Elasticity*. — The property which all bodies possess to a certain extent, of resuming their original form or volume when the force which altered this form or volume ceases to act, is called *elasticity*. This property is the manifestation of a tendency which the particles of bodies possess, to maintain a certain distance or position with regard to each other, and to resume that distance or position when they have been disturbed. The phenomena of elasticity may be developed in solids by *compression*, by *tension*, by *flexure*, or by *torsion*. In fluids, however, elasticity can be developed only by compression, and it is only this form of elasticity, therefore, which can be regarded as a general property of matter.

All fluids, both liquid and gaseous, are perfectly elastic; and this elasticity is unlimited in extent, since they resume exactly their original volume as soon as the pressure by which this was

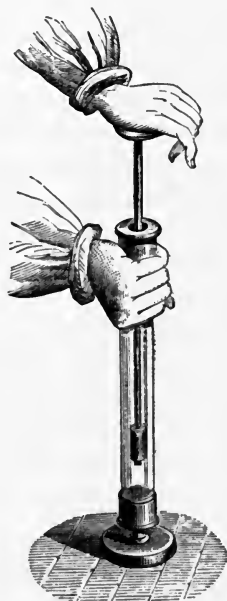

Fig. 51.

diminished is removed, however long it may have been applied.

Gases tend to expand indefinitely, and, other circumstances being equal, a definite volume always corresponds to a given pressure. If the pressure is increased, the volume diminishes, and if the pressure is diminished, the volume increases. Hence, gases are frequently called *permanently elastic fluids*.

The elasticity of solids is not perfect and unlimited, like that of fluids. In some solids, such as glass, it appears to be perfect; for no force, however great or long continued, will cause glass to take a *set*, as it is called, that is, will cause a permanent change either in form or bulk. But then this elasticity is confined within very narrow limits; for if the displacement of the particles exceeds a very small amount, the body is crushed. In other solids, as in India-rubber or the metals, the elasticity is less limited; but in these, if the compressing force exceeds a certain amount, or is continued beyond a limited time, there remains a permanent change of form or bulk. Within these limits, however, which differ very greatly in different substances, all solids appear to be perfectly elastic. It is in the limit of elasticity that we find the great differences between bodies. Thus, a ball of steel or of ivory will be as elastic up to a certain point as a ball of India-rubber, as may be proved by dropping the three balls upon a hard surface from the same height, and then marking the heights to which they rebound; but while the elasticity of the India-rubber extends to almost any degree, that of the others is very limited. Even lead and pipe-clay, which are generally considered as entirely devoid of elasticity, show an elasticity as perfect as that of the best-tempered steel, but within very narrow limits.

CHAPTER III.

THE THREE STATES OF MATTER.

(78.) *Molecular Forces.* — The forces which are supposed to emanate from the molecules of matter, and which we have termed *molecular forces*, are either *attractive*, tending to draw together the molecules of a body, or *repulsive*, tending to drive them apart. The three states of matter seem to depend on the relative intensity of these forces. When the attractive forces are in excess, the molecules of a body are held together more or less firmly, and we have the *solid state*. When the attractive forces are nearly balanced by the repulsive forces, the molecules are in equilibrium and endowed with freedom of motion among themselves, and we have the *liquid state*. Finally, when the repulsive forces are in excess, the molecules tend to recede from each other, and we have a state of permanent tension, which we call a *gas*.

In regard to the mode of action of these molecular forces, we have little or no accurate knowledge, and all our theories in regard to them are inferences from the phenomena which the aggregations of these molecules, the masses of matter, exhibit.

The attractive forces act only through extremely small distances. Several facts may be cited in illustration of this. If, when the flat surfaces of two hemispheres of lead are tarnished, they are pressed together, they will not adhere. If, however, the superficial coating of oxide is removed with a sharp knife, and the two clean surfaces are then pressed together, they adhere with great force. The process of welding iron affords an illustration of the same fact. In order to unite two bars of iron, the ends to be joined are first softened, by heating them to a white heat in a forge, and then hammered together on an anvil. The complete union of the bars cannot be attained in this process unless the coating of oxide, which forms in the forge on the heated surfaces, is dissolved by sprinkling on the ends of the bars powdered borax, or some similar substance. So also pieces of wax, dough, India-rubber, and other soft substances, cannot be made

to adhere when their surfaces are covered with dust, but can be united firmly together when the surfaces are clean. Finally, plates of polished glass have been known, simply from resting on each other in the warehouse, to adhere so firmly as to resist all efforts to separate them, breaking as readily in any other direction as at the plane of junction. The thinnest film of tissue-paper interposed between them is sufficient to prevent any such adhesion.

The repulsive forces do not appear to be so inherent in the particles of matter as the attractive force. They seem to be due to the action of an external agent, called *heat*. This opinion is supported by many facts. The first effect of heat on a solid is to expand it, that is, to separate the molecules from each other; but as it accumulates in the body, it changes its condition, first into the liquid, and subsequently into the gaseous state. So also, when two plates of glass are pressed firmly together, the minute interval which still separates them is increased by heating. The particles of finely divided and infusible powders repel each other when intensely heated, and the powders roll round in the crucible as if they were liquid; and lastly, when water is dropped into a heated metallic dish, it does not moisten the sides of the dish, but is repelled by it and assumes a globular form. The repulsion is so great, that, if the dish is pierced with holes, like a sieve, the water will not run out. Since, then, heat evidently increases the repulsive forces between the molecules of matter, it is natural to conclude that it is the cause of these forces, and this hypothesis is generally admitted.

In studying the phenomena of matter due to these molecular forces, it will be convenient to class them under two heads: first, those phenomena caused by the action of these forces between homogeneous molecules, such as the molecules of the same substance; secondly, those phenomena caused by the action of the forces between heterogeneous molecules, such as those of different substances. To the first class belong those phenomena which characterize the solid, liquid, and gaseous conditions of matter; to the second, the phenomena of *capillarity* (or adhesion) and *diffusion*.

MOLECULAR FORCES BETWEEN HOMOGENEOUS MOLECULES.

I. CHARACTERISTIC PROPERTIES OF SOLIDS.

Among the characteristic properties of solids, we shall consider the following:—Crystalline Form, Elasticity, Resistance to Rupture, and Hardness.

Crystallography.

(79.) *Crystalline Form.*—The force which holds together the molecules of solids is called *cohesion*; and the most obvious effect of this force is to retain the molecules in a fixed position with reference to each other, and hence to give to the solid a more or less permanent form. Almost all solids, when they are formed slowly, under circumstances such that the molecules are free to arrange themselves in accordance with the tendencies of the molecular forces, assume definite external forms. These forms, with certain limitations, are always the same for the same substance, but may differ in different substances. They are, therefore, *essential* forms, depending upon the nature of the substance. Such forms are called *crystals*, and the processes by which they are obtained are called processes of *crystallization*.

The larger number of inorganic solids which we meet with in every-day life, do not appear to have any regularity of outward form. Their form is generally *accidental*, one which has been given by art, or which is due to the accidental circumstances under which the solid has been placed. In some cases, however, if we break the solid and examine the fracture, it will be seen that the solid is an aggregation of minute crystals closely packed together. This is the case with granite and many other rocks. Other solids split readily along certain planes, called *planes of cleavage*. Both these classes of bodies are said to have a *crystalline structure*. In many cases, however, no indications of a crystalline structure can be seen; but in almost all, the solid can be made to assume a regular crystalline form by one of the processes described in the next section.

(80.) *Processes of Crystallization.*—The conditions of crystallization are freedom of motion in the molecules from which the solid is forming, and sufficient time for the molecules to ar-

range themselves in obedience to the molecular forces. These conditions are generally obtained in one of four ways.

The *first* consists in dissolving the solid in water or some other solvent, and allowing the liquid to evaporate slowly. As the solid is slowly deposited, it assumes the crystalline form. This method is the most universally applicable, and the one by which crystals are usually formed in nature. The best method of applying it consists in making a concentrated solution of the substance in water, placing the solution in a shallow dish, covering the dish with porous paper fastened tightly round the edges to prevent dust from settling upon the liquid, and leaving it in a moderately warm place until the crystallization is completed. When the substance is not soluble in water, it can generally be dissolved in alcohol, ether, sulphide of carbon, or melted boracic acid, instead of water. Sulphur, for example, may be crystallized from a solution in sulphide of carbon; and alumina may be crystallized by dissolving it in melted boracic acid, and exposing the solution to the intense heat of a porcelain furnace. At this very high temperature the boracic acid slowly evaporates. Most substances are more soluble in hot water than in cold, and these can also be crystallized by making a concentrated hot solution, and allowing it to cool; the excess of the solid in solution over that which cold water will dissolve, is deposited in crystals. Unless, however, the quantity of the solution is very considerable, large and perfect crystals are not so frequently formed in this way as by slow evaporation. A small quantity of solution cools so rapidly, that sufficient time is not afforded for perfect crystallization.

The *second* method consists in melting the solid in a crucible, and allowing the liquid to cool very slowly. When a solid crust forms on the surface, this is broken, and the remaining liquid turned out, when the inside of the crucible is found lined with crystals. Sulphur and many of the metals may be crystallized in this way.

The *third* method consists in converting the solid into vapor, and subsequently condensing the vapor in a cool receiver, — a process which is called *sublimation*. Iodine, arsenic, arsenious acid, and many other substances, can be crystallized by this method.

The *fourth* method consists in very slowly decomposing some chemical compound containing the substance, either by electricity

or by the action of some chemical agent. The crystals of metals formed in the processes of electro-metallurgy are the best examples of this method.

(81.) *Definitions.* — A crystal is always bounded by plane faces, and is therefore a *polyhedron*. The faces of the diamond and of some other crystals are at times curved; but in such cases the apparently curved surface can generally be seen to be made up of a large number of very small planes. The terms of solid geometry are used, without change of meaning, in crystallography. Thus we speak of faces, edges, plane angles, interfacial angles, and solid angles. The axis of a crystal is a line passing through its centre, round which two or more faces are symmetrically arranged. In every crystal, at least three such lines can be distinguished. In Figs. 52, 53, and 54, the axes are indicated by dotted lines.

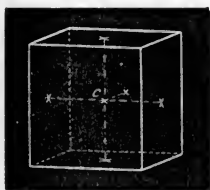

Fig. 52.

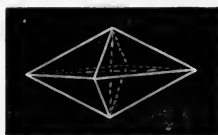

Fig. 53.



Fig. 54.

(82.) *Systems of Crystals.* — A crystal is a solid bounded by planes arranged symmetrically round one or another of six systems of axes.

1. The first system (Fig. 55) is called the *Monometric System*, and consists of three axes, of equal length and at right angles to each other. The length of each semi-axis we shall represent in this work by a , and the system of axes by the symbol $a : a : a$. It is hardly necessary to observe, that, as crystals may vary very greatly in size, the absolute lengths of the axes must vary to the same extent, and that it is the relative lengths only which are constant.

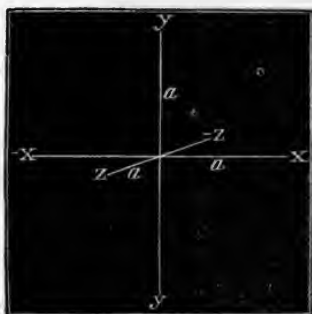

Fig. 55.

2. The second system (Fig. 56) is called the *Dimetric System*, and consists, like the last, of three axes at right angles to each other. The two axes in the horizontal plane of the figure are called the *lateral axes*, and are equal to each other. We shall represent the length of each half of these axes by a . The third is called the *vertical axis*, and is either longer or shorter than the other two. We shall represent the length of each half of this axis by b . The symbol representing this system of axes is $a : a : b$. The ratio between a and b is irrational. Thus, in crystals of tin, the ratio between the axes is $a : b =$

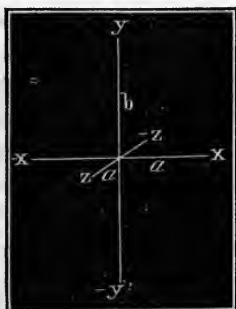

Fig. 56.

$1 : 0.3857$. In the monometric system there can be but one set of axes; but in this system there can be as many sets of axes as the number of possible irrational ratios between a and b , which is of course infinite. The ratio for crystals of the same substance is always the same; but it differs for crystals of different substances, no two substances having the same ratio.

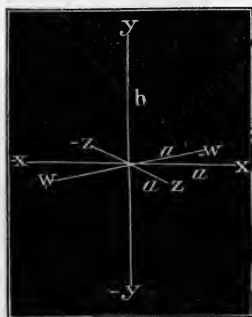

Fig. 57.

3. The third system (Fig 57) is called the *Hexagonal System*, and consists of four axes. Three of these are in the same plane, the horizontal plane of the figure, and are called *lateral axes*. They are equal in length, and have the same relative position as the diagonals of a regular hexagon (Fig. 58). The common length of the six halves of these lateral axes we shall represent by a . The fourth axis, called the *vertical axis*, is at right angles to the other three, and is either shorter or longer than their common length. The length of one half of this axis we shall represent by b , and the symbol of the system of axes is $a : a : a : b$. The relation between a and b is, as in the last system, irrational. Thus, in crystals of antimony, $a : b = 1 : 1.3068$, and in crystals of carbonate of lime (calcite), $a : b = 1 : 0.8543$. Here, as in the last system, the ratio is con-

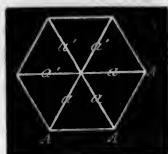

Fig. 58.

stant in crystals of the same substance, but differs in crystals of different substances.

4. The fourth system (Fig. 59) is called the *Trimetric System*, and consists of three axes, all at right angles to each other, but all of unequal length. One of these axes is selected as the vertical axis, and the length of one half of this axis will be represented in this work by b . The shorter of the two lateral axes is called the *brachydiagonal*, and its half-length will be represented by a . The longer is called the *makrodiagonal*, and its half-length will be represented by c . The symbol of this system of axes is $a : b : c$. The relation between a , b , and c is irrational. In crystals of sulphur, $a : b : c = 1 : 2.340 : 1.233$.

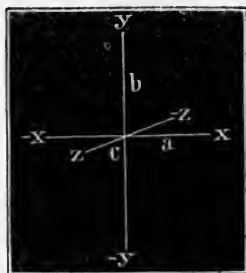

Fig. 59.

5. The fifth system (Fig. 60) is called the *Monoclinic System*, and consists of three unequal axes. The two lateral axes are at right angles to each other. The third axis, called the vertical axis, is at right angles to one of the lateral axes, but is inclined to the other. The length of one half of the vertical axis we shall represent by b . The one of the lateral axes which is at right angles to the vertical axis is called the *orthodiagonal*, and its half-length will be represented by a . The lateral axis which is inclined to the vertical axis is called the *klinodiagonal*, and its half-length will be represented by c . The value of the acute angle which the vertical axis b makes with the *klinodiagonal* c will be represented by α . The symbol of this system is the ratio $a : b : c$, with the angle α . For the crystals of the same substance, the ratio between a , b , and c , and the value of α , are constant; but they differ in crystals of different substances. In crystals of sulphate of iron, for example, $a : b : c = 1 : 1.495 : 1.179$, and $\alpha = 75^\circ 40'$, while in crystals of gypsum $a : b : c = 1 : 0.413 : 0.691$, and $\alpha = 81^\circ 26'$.

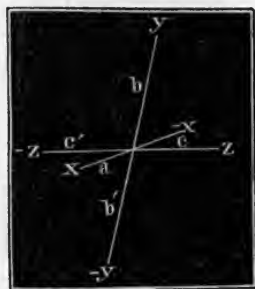

Fig. 60.

6. The sixth system (Fig. 61) is called the *Triclinic System*,

and consists of three unequal axes, which are all inclined to each other. One of these axes is selected as the vertical axis, and the

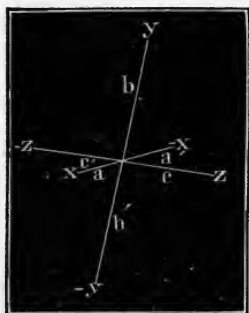

Fig. 61.

half-length of this axis will be represented by b . The half-lengths of the two lateral axes will be represented by a and c . The angles of inclination between the axes will be represented as follows:—

a on b by γ ,

a on c by β ,

b on c by α .

The symbol of this system is the ratio $a : b : c$, with the angles α, β, γ . In crystals of sulphate of copper, $a : b : c = 1 : 0.9738 : 1.7683$, and $\alpha = 82^\circ 21'.5$, $\beta = 77^\circ 37'.5$, $\gamma = 73^\circ 10'.5$. In crystals of bichromate of potash, $a : b : c = 1 : 0.9886 : 1.794$, and $\alpha = 82^\circ$, $\beta = 83^\circ 47'$, $\gamma = 89^\circ 8'.5$.

All crystals which have the same system of axes are said to belong to the same *crystalline system*; and hence all crystals may be classified under six crystalline systems, corresponding to the systems of axes just described. The systems of crystals have the same names as the systems of axes.

(83.) *Centre of Crystal, and Parameters.*—The point at which the axes of a crystal intersect is called the *centre of the crystal*.

If we suppose the axes of a crystal indefinitely produced, it is evident that each of its planes, if also produced, must intersect each of the axes, either at a finite or at an infinite distance from its centre. The distances of the points of intersection from the

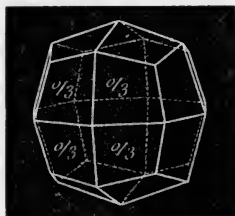

Fig. 62.

centre are called the *parameters* of the planes. Each of the planes of the crystal represented in Fig. 62, for example, would, if produced, intersect the three axes of the monometric system at distances from the centre equal to $a : 3a : 3a$ respectively, a representing, as stated above, the length of any semi-axis. These lengths are the parameters of each plane of the crystal.

When a plane is parallel to a given axis, it may be regarded as intersecting it at an infinite distance from the centre, and hence

its parameter measured on this axis is infinity. The faces of a cube, for example, intersect one axis of the monometric system at the distance a from the centre (Fig. 63), and are parallel to the other two. The parameters of each face are therefore $a : a : \infty a$. So, also, each of the faces of the *dodecahedron* (Fig. 64) intersects two of the axes of the monometric system at the distance a from the centre, and is parallel to the third axis. Hence the parameters of each face are $a : a : \infty a$.

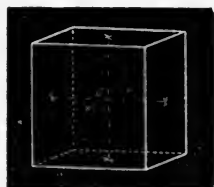

Fig. 63.

It has already been stated that the crystals of a given substance have always axes of the same relative lengths, and with the same relative inclination. It is also true that the parameters of the planes of any crystal of a given substance are always equal, either to the lengths of the semi-axes on which they are measured, or else to some simple multiples or submultiples of these lengths. Hence it follows, that the parameters of any plane of a crystal may always be expressed very simply in terms of its axes, as above.



Fig. 64.

(84.) *Similar Axes.* — *In any system of axes, one axis or one semi-axis is said to be similar to another axis or to another semi-axis, when the two have the same length and the same inclinations to the other axes or semi-axes.* It is important to apply this definition to the different systems, and distinguish the similar axes in each.

1. In the monometric system, all the axes and all the semi-axes are similar.

2. In the dimetric system, the two lateral axes are similar, and also the four halves of these axes are similar. The two halves of the vertical axis are also similar to each other, but they are not similar to the halves of the lateral axes.

3. In the hexagonal system, the three lateral axes are similar, and their six halves are also similar. The two halves of the vertical axis are also similar to each other, but not similar to the halves of the lateral axes.

4. In the trimetric system, all three axes are dissimilar, but the two halves of each axis are similar to each other. By referring

to the notation given in the previous sections, it will be seen that in the first four systems similar semi-axes have in every case been designated by the same letter, and that the dissimilar semi-axes have been distinguished by different letters.

5. In the monoclinic system, not only the three axes are all dissimilar, but moreover the two halves of the same axis are not in all cases similar to each other. The two halves of the orthodiagonal are similar, but the two halves of the klinodiagonal, although they have the same length, have not the same inclination to any one half, say the upper half, of the vertical axis, and are therefore dissimilar. The same is true reciprocally of the two halves of the vertical axis. In order to distinguish the dissimilar halves of these axes, we will accent the b when it refers to the lower half of the vertical axis, and also accent the c when it refers to the half of the klinodiagonal, which is inclined to b at an obtuse angle. The notation of the monoclinic system of axes is, then, as follows:—

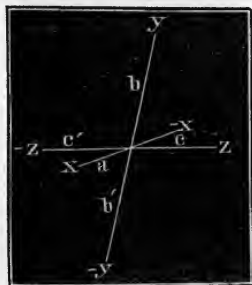

Fig. 65.

- a = either half of the orthodiagonal.
- b = the upper half of the vertical axis.
- b' = the lower half of the vertical axis.
- c = the half of the klinodiagonal which is inclined to b at an acute angle.
- c' = the half of the klinodiagonal which is inclined to b at an obtuse angle.
- α = angle of b on c .

It is evident that the angle of b on c is equal to the angle of b' on c' , being vertical angles; and hence, that b and c together are similar in position to b' and c' together.

6. In the triclinic system, all the semi-axes are dissimilar, and the two halves of each axis may be distinguished by accentuation, as in the monoclinic system.

(85.) *Similar Planes.*—*Similar planes are those whose parameters, measured on similar semi-axes, are equal.* There is no difficulty in distinguishing similar planes, by means of this definition, in any except the last two systems of axes, since in all the other systems those planes are similar which in the notation here adopted have equal parameters, and none others.

In the monoclinic and triclinic systems, however, two planes

are similar, not only when they have equal parameters, but also when the parameters, measured on the dissimilar halves of the same axes, are in both cases oppositely accented. For example, in the monoclinic system, two planes are similar whose parameters are $a : 2b : c$, and $a : 2b' : c'$. In the two symbols, the two halves of the dissimilar axes are oppositely accented. On the other hand, two planes whose parameters are $a : 2b : c$, and $a : 2b : c'$, are not similar.

In the triclinic system, since the six semi-axes are all dissimilar, no two planes are similar, unless the three parameters of the one are all accented oppositely to the three parameters of the other. Thus, two planes are similar whose parameters are $a : b : 2c$, and $a' : b' : 2c'$, respectively.

(86.) *Holohedral Crystalline Form.* — A holohedral crystalline form is the union of all the possible similar planes which can be arranged around a given system of axes. Thus, the form of Fig. 66 is the union of all the possible planes having the parameters $a : a : 2a$, which can be arranged round the monometric system of axes. So also the form of Fig. 67 is the union of all the possible planes having the parameters $a : a : \infty a : b$, which can be arranged round the hexagonal system of axes. Both of these are therefore holohedral forms.

It must not, however, be inferred from these examples that a crystalline form is always a crystal, and that it always encloses space. The word *form* is used in crystallography in the technical sense, as defined above. A form may consist of only two planes. Thus, the two basal planes of the hexagonal prism (Fig. 68) are a crystalline form, because they are all the possible planes, having the parameters $\infty a : \infty a : \infty a : b$, which can be arranged round the hexagonal system of axes. In like manner, the six planes on the convex surface of the prism, being all the planes having the parameters $a : a : \infty a : \infty b$, which can be arranged round

Fig. 66.

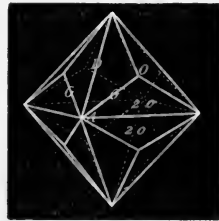

$a : a : 2a.$

Fig. 67.



$a : a : \infty a : b.$

Thus, the two

Fig. 68.

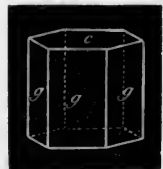

$\infty a : \infty a : \infty a : b,$
 $a : a : \infty a : \infty b.$

the same system of axes, form another holohedral crystalline form. In neither case does the form enclose space. It requires the combination of the two forms to complete the crystal. In the triclinic system no crystalline form can consist of more than two planes; and hence the combination of at least three crystalline forms is required in this system to complete a crystal.

The parameters of one of the planes are used as the symbol of the holohedral crystalline form. Thus, the parameters printed below the Figs. 66 and 67 not only denote the position of each plane of the form with reference to the axes, but they are also used as the symbol of the form itself. When a crystal consists of two or more crystalline forms, like the one represented in Fig. 68, we use as the symbol of the crystal the several symbols of the crystalline forms of which it consists, written one after the other, or one beneath the other, as convenience may dictate. Examples of these symbols may be seen beneath the figures of crystals on this and the few following pages.

(87.) *Hemihedral Crystalline Form.* — A hemihedral crystalline form is the union of one half of the possible similar planes, which can be arranged round a given system of axes. The form represented in Fig. 69 is the union of all the possible planes having the parameters $a : a : a$, which can be arranged round the

Fig. 69.

 $a : a : a$.

Fig. 70.

 $+\frac{1}{2}(a : a : a)$.

Fig. 71.

 $-\frac{1}{2}(a : a : a)$.

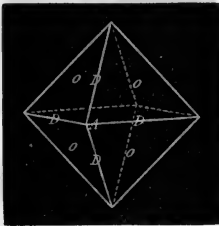
monometric system of axes, and is therefore a *holohedral* form. The form of Fig. 70 is the union of one half of the planes having the same parameters, and arranged round the same system of axes. It is, therefore, a *hemihedral* form. This form is called the *tetrahedron*, and it may be regarded as derived from the octahedron, by suppressing every other plane of this form and producing the rest. Hence, it is frequently called the hemihedral form of the octahedron. The form of Fig. 70 is obtained by pro-

ducing one set of the alternate planes of the octahedron of Fig. 69. If, now, we suppress this set of planes, and produce the other set of the alternate planes of the octahedron, we shall obtain a second tetrahedron; differing, however, from the first only in relative position. This form is said to be the *negative* of the first. We use, as the symbol of a hemihedral form, the symbol of the corresponding holohedral form, preceded by the fraction $\frac{1}{2}$, and we distinguish between the two hemihedral forms of which the holohedral form may be supposed to consist, by means of the signs plus and minus, as shown by the symbols beneath Figs. 70 and 71.

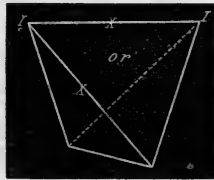
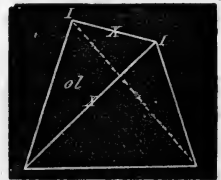
(88). *Tetartohedral Crystalline Forms.*—A *tetartohedral crystalline form* is the union of one quarter of the possible similar planes which can be arranged round a given system of axes. Such forms are met with among crystals, but they are of comparatively rare occurrence. They are designated by writing the fraction $\frac{1}{4}$ before the symbol of the corresponding holohedral form.

(89.) *Simple and Compound Crystals.*—A crystal is said to be simple, when it is bounded by the planes of one crystalline form only; and to be compound, when it is bounded by the planes of several crystalline forms. Thus, the crystals represented by

Fig. 72.

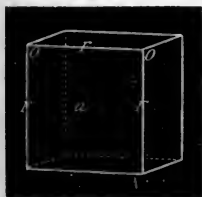

$$a : \infty a : \infty a.$$

Fig. 73.



$$a : a : b.$$

Fig. 74



$$a : a : \infty a : b.$$

Figs. 72, 73, and 74 are simple, because in each case all the planes which bound the crystal have the same parameters. On the other hand, the crystals represented by Figs. 75, 76, and 77 are compound crystals, because there are two or more sets of planes on each crystal, of which the planes have different parameters. The faces of the crystals are lettered, and below each crystal the parameters of each set of planes are given opposite to the corresponding lettering.

Fig. 75.

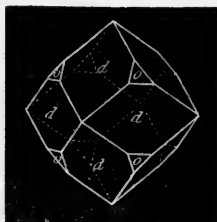

$$d = a : a : \infty a,$$

$$o = a : a : a.$$

Fig. 76.

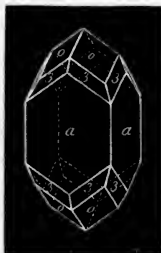

$$a = a : \infty a : \infty b,$$

$$o = a : a : b,$$

$$3 = a : a : 3 b.$$

Fig. 77.



$$r = +\frac{1}{2} (a : a : \infty a : b),$$

$$\frac{r}{2} = -\frac{1}{2} (a : a : \infty a : \frac{1}{2} b),$$

$$2r' = -\frac{1}{2} (a : a : \infty a : 2b).$$

Most of the crystals which we meet with are compound crystals. Indeed, in the monoclinic and triclinic systems, we cannot have a simple crystal, because in these systems no single crystalline form will enclose space, and simple crystals are seldom found in any of the systems, with the exception of the monometric and hexagonal.

(90.) *Dominant and Secondary Forms.*—It is seldom that the faces of the various forms of which a compound crystal consists are equally developed and conspicuous. As a general rule, the faces of one form are more prominent than those of the others, and give to the crystal its general aspect. This form is then called the *dominant form*, and the others are called *secondary forms*. Figs. 78, 79, and 80 represent three compound crystals, each of which consists of faces of a cube combined with

Fig. 78.

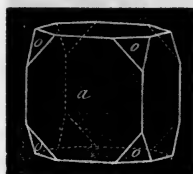

$$a : \infty a : \infty a,$$

$$a : a : a.$$

Fig. 79.

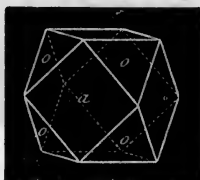

$$a : \infty a : \infty a,$$

$$a : a : a.$$

Fig. 80.

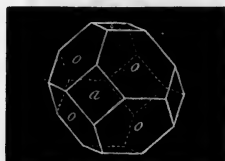

$$a : a : a,$$

$$a : \infty a : \infty a.$$

those of an octahedron. In Fig. 78, the faces of the cube are dominant, and those of the octahedron are secondary. In Fig. 79, the two sets are equally developed, and in Fig. 80 the faces of the octahedron are dominant. In writing the symbols of compound crystals, we always write the symbols of the dominant form first, and the symbols of the secondary forms in the order of their prominence.

When the faces of the dominant form are so much developed as to give their general aspect to the crystal, it is usual to describe the crystal as having the dominant form *modified* by the faces of the secondary forms. For example, the crystal represented in Fig. 78 would be described as a cube modified by an octahedron, and the crystal of Fig. 80 as an octahedron modified by a cube. In Fig. 78, the solid angles of the cube have been *replaced* by planes of an octahedron, and in Fig. 80 the solid angles of the octahedron have been *replaced* by planes of a cube.

(91.) *Definitions.* — A crystalline form may modify another in different ways, and several technical terms are used in describing these modifications, which it is important to understand.

Truncation. — When the edge of a crystal is replaced by a plane equally inclined to the adjacent faces, and forming with them parallel edges, the edge is said to be truncated. In like manner, a solid angle is said to be truncated when it is replaced by a plane equally inclined to the similar adjacent faces. Figs. 81,

Fig 81.

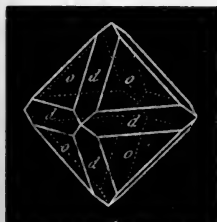

$$a : a : a.$$

$$a : a : \infty a.$$

Fig. 82.



$$a : \infty a : \infty a,$$

$$a : a : \infty a.$$

Fig 83.

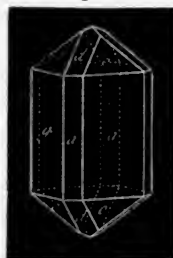

$$a : a : \infty b.$$

$$a : \infty a : \infty b,$$

$$a : a : b,$$

$$a : \infty a : b$$

82, 83 are examples of truncation of edges, and Figs. 78, 79, 80 are examples of truncation of solid angles.

Beveling. — If an edge is replaced by two planes, as in Fig. 84, each of which is inclined to the adjacent face at the same angle, and which form with these faces parallel intersections, the edge is said to be bevelled.

Similar edges are those formed by the intersection of two planes which are similar each to each. *Similar solid angles* are those formed by the union of three or more planes which are similar each to each.

Fig. 84.

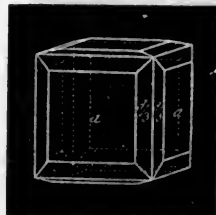

$$a : \infty a : \infty a,$$

$$a : 3 a : \infty a.$$

The modifications on crystals follow one of two simple laws:—

1. *All the similar parts of a crystal are simultaneously and similarly modified.*

2. *Half the similar parts of a crystal are simultaneously and similarly modified independently of the other half.*

It sometimes, although more rarely, happens, that only one quarter of the similar parts of a crystal are simultaneously and similarly modified.

The modifying planes which are distributed on the edges and solid angles of the dominant form in accordance with the first law, are the planes of *holohedral* forms; those which are distributed in accordance with the second law, are the planes of *hemihedral* forms.

(92.) *Forms of Crystals belonging to the various Systems.*—

We shall only be able, in this place, to give figures of the most important forms in each system, and must refer the student to the special works upon Mathematical Crystallography, for a full development of the subject. As it is difficult for unpractised persons to obtain a perfect conception of solids from projections, the student is advised to prepare models of the more important forms. These can be readily made with the *outlines of crystal forms* which are given in several German works on Crystallography, and which have in several cases been published separately.* Crystal models of wood or of porcelain can be obtained from dealers in philosophical instruments; but by far the most instructive models are made with glass faces fastened together with strips of colored paper pasted on the edges. Each set of similar edges is distinguished by its special color, and the axes are indicated by colored strings within the model. The mode of composition of compound forms may be beautifully illustrated by making the dominant form of card, and then, outside of this and enclosing it, the secondary form of glass.

MONOMETRIC SYSTEM.

The simple holohedral forms of the monometric system are seven in number, and are named as follows, the numbers above the figures corresponding to the numbers before the names.

* Krystallformennetze zum Anfertigen von Krystallmodellen, von Dr. Adolf Kenn-
gott. Wien, 1856. To be procured from B. Westermann & Co. of New York.

Simple Holohedral Forms.

1.

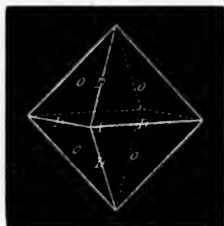

$a : a : a.$

2.

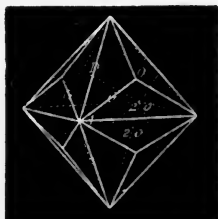

$a : a : m a.$

3.

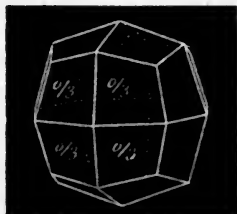

$a : m a : m a.$

4.

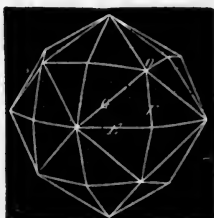

$a : m a : n a.$

5.

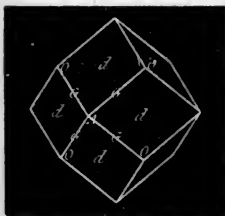

$a : a : \infty a.$

6.

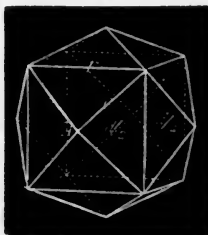

$a : m a : \infty a.$

7.

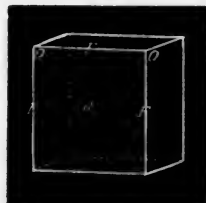

$a : \infty a : \infty a.$

Fig. 85.

- | | | |
|-------------------------------|--------------------------------|---|
| 1. $a : a : a.$ | Octahedron. | Solid bounded by 8 equilateral triangles. |
| 2. $a : a : m a.$ | Trigonal triakis-octahedron. | “ “ 3 × 8 isosceles “ |
| 3. $a : m a : m a.$ | Tetragonal triakis-octahedron. | “ “ 3 × 8 quadrilaterals. |
| 4. $a : m a : n a.$ | Hexakis-octahedron. | “ “ 6 × 8 scalene triangles. |
| 5. $a : a : \infty a.$ | Rhombic dodecahedron. | “ “ 12 rhombs. |
| 6. $a : m a : \infty a.$ | Tetrakis-hexahedron. | “ “ 4 × 6 isosceles triangles. |
| 7. $a : \infty a : \infty a.$ | Hexahedron (cube). | “ “ 6 squares. |

Three of these forms — the octahedron, $a : a : a$, the dodecahedron, $a : a : \infty a$, and the hexahedron, $a : \infty a : \infty a$ — have invariable parameters, and therefore do not admit of any variation in the relative position of their planes. They are frequently called the fundamental forms of the system. The parameters of the remaining four forms are variable, and the exact position of their planes depends on the values given to m and n , which are always very simple rational numbers. The relation between the forms can easily be seen from the disposition of the crystals in the above figures. For example, in the trigonal triakis-octahedron, when the value of m is unity, the solid angle o disappears, and the form becomes an octahedron. As we give to m larger and larger values, the angle o becomes more and more prominent; and, finally, when $m = \infty$, the two planes, meeting at the edge d , coincide, and the form becomes the dodecahedron. There may, therefore, be an infinite number of trigonal triakis-octahedrons, varying between the two limits of the octahedron on the one side, and the dodecahedron on the other. By drawing a series of these forms with gradually increasing values of m , the relation can easily be made evident to the eye. In like manner, the tetragonal triakis-octahedron is an intermediate form between the octahedron and the cube, and within these two limits there may be an infinite number of forms with different values of m . In fact, however, only a very few of the possible varieties of either of these forms have been found in nature, the most frequent occurring values of m being $\frac{3}{2}$, 2, $\frac{3}{4}$, and 3.

Again, the tetrakis-hexahedron is a variable form, intermediate between the dodecahedron and the cube. When $m = 1$, the pair of faces meeting at m coincide, and we have the dodecahedron. As the value of m increases, the solid angle at A becomes more and more obtuse, until, when $m = \infty$, the four planes meeting at A coincide, and we have a cube. Finally, the hexakis-octahedron is the central form of the triangular group. It can easily be seen that it is intermediate between the octahedron and the tetrakis-hexahedron, between the cube and the trigonal triakis-octahedron, and, lastly, between the dodecahedron and the tetragonal triakis-octahedron. To trace out these relations, both in the symbols and the forms, is left for an exercise to the student.

Simple Hemihedral Forms.

1. *Oblique Hemihedral Forms.*

1.

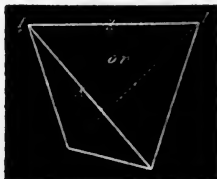

$$+\frac{1}{2}(a : a : a).$$

2.

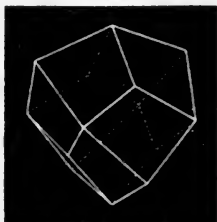

$$+\frac{1}{2}(a : a : m a).$$

3.

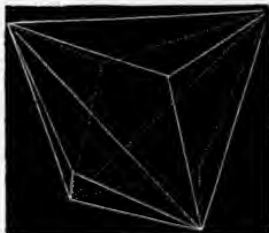

$$+\frac{1}{2}(a : m a : m a).$$

4.

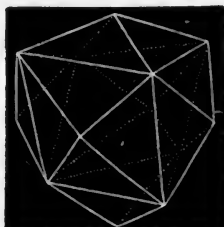

$$+\frac{1}{2}(a : m a : n a).$$

5.

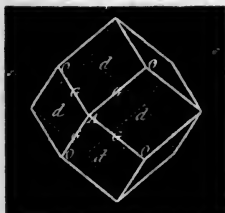

$$+\frac{1}{2}(a : a : \infty a)$$

6.

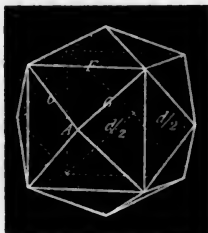

$$+\frac{1}{2}(a : m a : \infty a).$$

7.

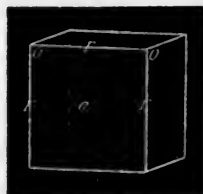

$$+\frac{1}{2}(c : \infty a : \infty a).$$

Fig. 86.

There are two groups of simple hemihedral forms in the regular system. The opposite planes of the characteristic forms of the first of these groups are inclined to each other, while

those of the second are parallel. Hence the forms of the first group have been called *oblique hemihedral forms*; those of the second, *parallel hemihedral forms*. The symbols of the oblique hemihedral forms are formed by writing $\frac{1}{2}$ before the symbol of the corresponding holohedral form enclosed in parentheses, thus: $\frac{1}{2} (a : m a : m a)$. The symbols of the parallel hemihedral forms are formed by writing $\frac{1}{2}$ before the symbol of the corresponding holohedral form enclosed in brackets, thus: $\frac{1}{2} [a : m a : m a]$.

The oblique hemihedral forms of the monometric system, which are seven in number, are represented in Fig. 86. Each of these forms has a holohedral form corresponding to it in position in Fig. 85. They are named as follows:—

1. $+\frac{1}{2} (a : a : a)$.	Tetrahedron.	Solid bounded by 4 equilateral triangles.
2. $+\frac{1}{2} (a : a : m a)$.	Tetragonal triakis-tetrahedron.	3×4 quadrilaterals.
3. $+\frac{1}{2} (a : m a : m a)$.	Trigonal triakis-tetrahedron.	3×4 isosceles triangles.
4. $+\frac{1}{2} (a : m a : n a)$.	Hexakis-tetrahedron.	6×4 scalene “
5. $+\frac{1}{2} (a : a : \infty a)$.	Dodecahedron.	12 rhombs.
6. $+\frac{1}{2} (a : m a : \infty a)$.	Tetrakis-hexahedron.	4×6 triangles.
7. $+\frac{1}{2} (a : \infty a : \infty a)$.	Hexahedron (cube).	6 squares.

The mode by which the tetrahedron is derived from the octahedron has already been explained. In Fig. 87, the planes of the octahedron which are suppressed are shaded, and those which are extended are left light. By comparing this figure with the figure of the hexakis-octahedron (Fig. 88), in which the parts corresponding in position to the shaded parts of the octahedron have also been shaded, and the reverse, it will be seen that a group of six planes corresponds in position, on this form, to a single plane on the octahedron. If, now, we extend the parts on this form corresponding to the parts which were extended on the octahedron, that is, every other set of six planes, those left light in the figure, we shall obtain the hexakis-tetrahedron, a form which bears the same relation to the tetrahedron that the hexakis-octahedron does to the octahedron.

In like manner, if we apply the same principle to the trigonal triakis-octahedron and to the tetragonal triakis-octahedron, extend-

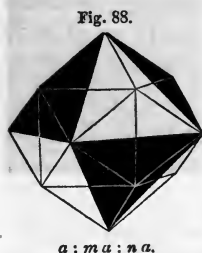

ing in these cases every other set of three planes, and suppressing the alternate sets, we shall obtain the tetragonal triakis-tetrahedron and the trigonal triakis-tetrahedron. It will be noticed, however, that the trigonal triakis-octahedron gives the tetragonal triakis-tetrahedron, and the reverse.

On Fig. 89, the portions of the cube corresponding in position to the planes of the octahedron which were suppressed are shaded, and it can be easily seen, that, if those portions of the cube faces which are not shaded are extended, they will form again a cube. The same is true of the tetrakis-hexahedron, as may be seen by Fig. 90, and also of the dodecahedron. In other words, the same process by which the tetrahedron is derived from the octahedron, applied to these three forms, reproduces these forms again. These forms are at once both holohedral and oblique hemihedral forms, and have therefore a place in both groups.

The seven oblique hemihedral forms bear similar relations to each other to those sustained by the holohedral forms, which have been already fully explained. The tetrahedron, the dodecahedron, and the cube are invariable forms. The rest admit of limited variation in the position of their faces, depending on the values of their parameters. Thus, the tetragonal triakis-tetrahedron is an intermediate form between the tetrahedron and the dodecahedron, admitting of every possible variation between these two limits. So also the trigonal triakis-tetrahedron is an intermediate form between the tetrahedron and the cube, and the hexakis-tetrahedron an intermediate between all the forms of the groups. These relations can easily be studied out by the student, both by means of the symbols and also by means of the figures of the forms.

Corresponding to each of the hemihedral forms of Fig. 86, there is an inverse form, which would be generated by extending the alternate planes, or sets of planes, which were suppressed before. The negative forms differ from the corresponding positive forms only in their position. In any case, if the negative form is turned round on its vertical axis one quarter of a revolution, it will coincide with the positive form.

Fig. 89.

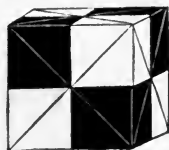

$$a : \infty : \infty a.$$

Fig. 90.



$$a : m a : \infty a.$$

2. *Parallel Hemihedral Forms.*

1.

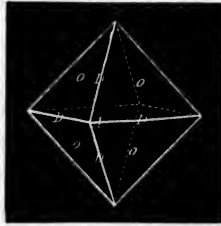

$$+\frac{1}{2}[a : a : a].$$

2.

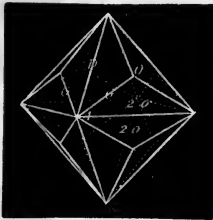

$$+\frac{1}{2}[a : a : m a].$$

3.

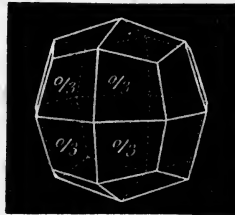

$$+\frac{1}{2}[a : m a : m a].$$

4.

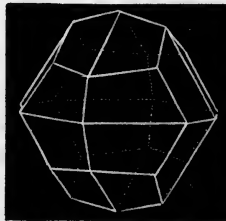

$$+\frac{1}{2}[a : m a : n a].$$

5.

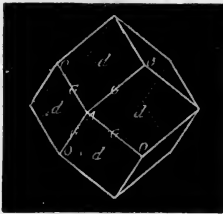

$$+\frac{1}{2}[a : a : \infty a].$$

6.

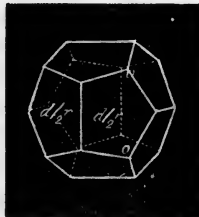

$$+\frac{1}{2}[a : m a : \infty a].$$

7.

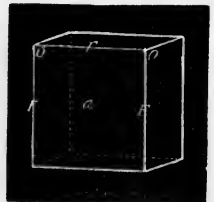

$$+\frac{1}{2}[a : \infty a : \infty a].$$

Fig. 91.

The parallel hemihedral forms of the monometric system may be generated by extending alternate pairs of planes of the hexakis-octahedron, or the portions of planes which correspond to these pairs on the other forms. In Fig. 92, the planes of the hexakis-octahe-

dron, which are suppressed in this process, are shaded, and those to be extended left light. The extension of the latter set of planes leads to the central form of Fig. 91, which is called the *diakis-dodecahedron*. If, now, we extend the portions of planes on the other forms which correspond to the alternate pairs on the hexakis-octahedron in position, we shall obtain in the case of the tetrakis-hexahedron the pentagonal dodecahedron; but in all the remaining five forms this extension will reproduce the original form. In Figs. 93, 94,

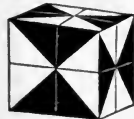

Fig. 93.

Fig. 94.

Fig. 95.

Fig. 96.



$a : a : a.$

$a : a : m a.$

$a : a : \infty a.$

$a : \infty a : \infty a.$

95, 96, the portions which correspond in position to the alternate pairs of the hexakis-octahedron, on the octahedron, the two triakis-octahedrons, the dodecahedron, and the cube, are left light, and it can easily be seen that the extension of these portions will reproduce the original form. It appears, therefore, that the same process by which the diakis-dodecahedron is derived from the hexakis-octahedron, and the pentagonal dodecahedron from the tetrakis-hexahedron, applied to the other five simple holohedral forms, reproduces these forms again. These forms are, therefore, at once holohedral and parallel hemihedral forms, and have a place in both groups. It will also be noticed that the rhombic dodecahedron and the cube belong to all three groups.

It is not necessary to enumerate the names of the seven simple forms of this group, since they are the same as those of the holohedral group, with the exception of the two whose names have just been given. The symbols of the parallel hemihedrons are the same as those of the corresponding oblique hemihedrons, with the exception that the bracket is used in place of the parenthesis. The forms of Fig. 91 are all positive, but a corresponding group of negative forms can easily be constructed, by extending the alternate planes or portions of planes which were suppressed before, that is, those which are shaded in Figs. 92, 93, 94, 95, 96.

The relations between the seven parallel hemihedral forms are similar, in all respects, to those which exist between the forms in the other two groups. The octahedron, the rhombic dodecahedron, and the cube are, as before, invariable forms. The remaining four are variable forms, the exact position of the planes depending on the values of the parameters. Since, after the details already given, the relations of these forms can easily be traced by the student, we need not dwell upon the subject.

Compound Forms.

It is only the forms of the same group which are found united on the same crystal. For example, we find the cube and the rhombic dodecahedron, which are common to the three groups, combined with any one of the other simple forms of the system, but we never find the octahedron combined with the hexakis-tetrahedron, nor the pentagonal dodecahedron combined with the tetrahedron. In order to become familiar with the compound forms of this system, the best method is to study each form in succession, and consider how it will be modified by each of the other forms of the system, when it is the dominant form in the combination. After the description which has been given of the simple forms of the system, the student will be able, with a little study, to discover the nature of the modifications in each case, and he can confirm his results by referring to the figures of the compound forms given in the larger works on Crystallography.* We will take the case of the octahedron as an illustration.

The cube modifies the octahedron by truncating its solid angles. The rhombic dodecahedron modifies it by truncating its edges; the tetragonal triakis-octahedron by replacing its solid angles by four planes, which are variously inclined on the faces of the octahedron, the inclination depending on the value of m in the symbol of the modifying form, $a : m a : m a$. The trigonal triakis-octahedron bevels the edges of the octahedron, the interfacial angle between the bevelling planes and the faces of the octahedron depending on the value of m in the symbol of the modifying form, $a : a : m a$. The hexakis-octahedron replaces the solid angles of the octahedron by eight planes, whose inclination on the faces of the dominant form depends on the values of m and n in

* See the plates of Naumann's "Lehrbuch der Krystallographie." Leipzig. 1830.

the symbol of the modifying form, $a : m a : n a$. Finally, the tetrakis-hexahedron replaces the solid angles of the octahedron by four planes inclined on the edges of the dominant form at angles which depend on the value of m in the symbol $a : m a : \infty a$.

We give below several figures of compound crystals. The symbols, which are also added, will furnish a sufficient description of the forms.

1.

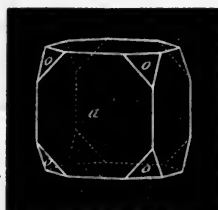

$$a : \infty a : \infty a,$$

$$a : a : a.$$

2.

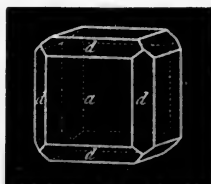

$$a : \infty a : \infty a,$$

$$a : a : \infty a.$$

3.

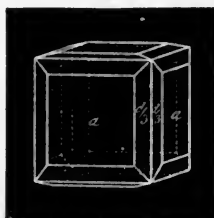

$$a : \infty a : \infty a,$$

$$a : m a : \infty a.$$

4.

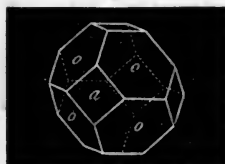

$$a : a : a,$$

$$a : \infty a : \infty a.$$

5.

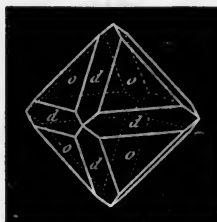

$$a : a : a,$$

$$a : a : \infty a.$$

6.

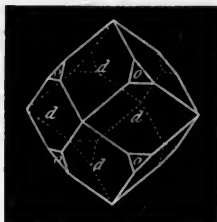

$$a : a : \infty a,$$

$$a : a : a.$$

7.

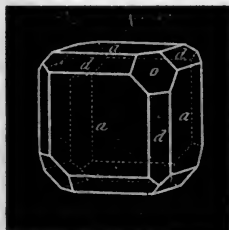

$$a : \infty a : \infty a,$$

$$a : a : \infty a,$$

$$+ \frac{1}{2} (a : a : a).$$

8.

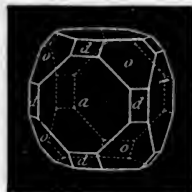

$$a : \infty a : \infty a,$$

$$a : a : a,$$

$$a : a : \infty a.$$

9.

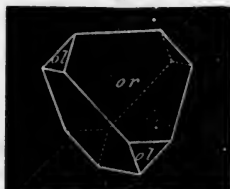

$$+ \frac{1}{2} (a : a : a),$$

$$- \frac{1}{2} (a : a : a).$$

Fig. 97.

DIMETRIC SYSTEM.

Simple Holoedral Forms.

Fig. 98.

The most important simple forms of the dimetric system are represented in Fig. 98, and the forms have been grouped so that the relation between them can be easily seen. We can study this

relation to the best advantage, by commencing with No. 2, which is called the *square octahedron*, and whose symbol is $a : a : b$. When the length of the semi-axis b is greater than that of a , as is the case in crystals of sulphate of nickel, where $a : b = 1 : 1.906$, then the octahedron is acute, like No. 3. When, however, the length of the semi-axis b is less than that of a , as is the case in crystals of acid phosphate of potassa, where $a : b = 1 : 0.664$, then the octahedron is obtuse, like No. 2.

In the monometric system, we can have only one octahedron ; but in the dimetric system the same substance frequently presents several octahedrons. In all cases, however, if we reduce the octahedrons to the same base, the lengths of their vertical axes will bear to each other very simple and rational ratios. Thus, for example, on crystals of sulphate of nickel we find octahedrons, where the ratio of the two semi-axes is not only $1 : 1.906$, but also $1 : 0.953$ and $1 : 0.635$. The first of these octahedrons has been selected as the *principal form* of this substance, because it is the one which is the most frequently seen, and which, in compound crystals, is generally the dominant form. To the planes of this form we give the symbol $a : a : b$, and then the symbols of the other octahedrons are $a : a : \frac{1}{2} b$, and $a : a : \frac{1}{3} b$.

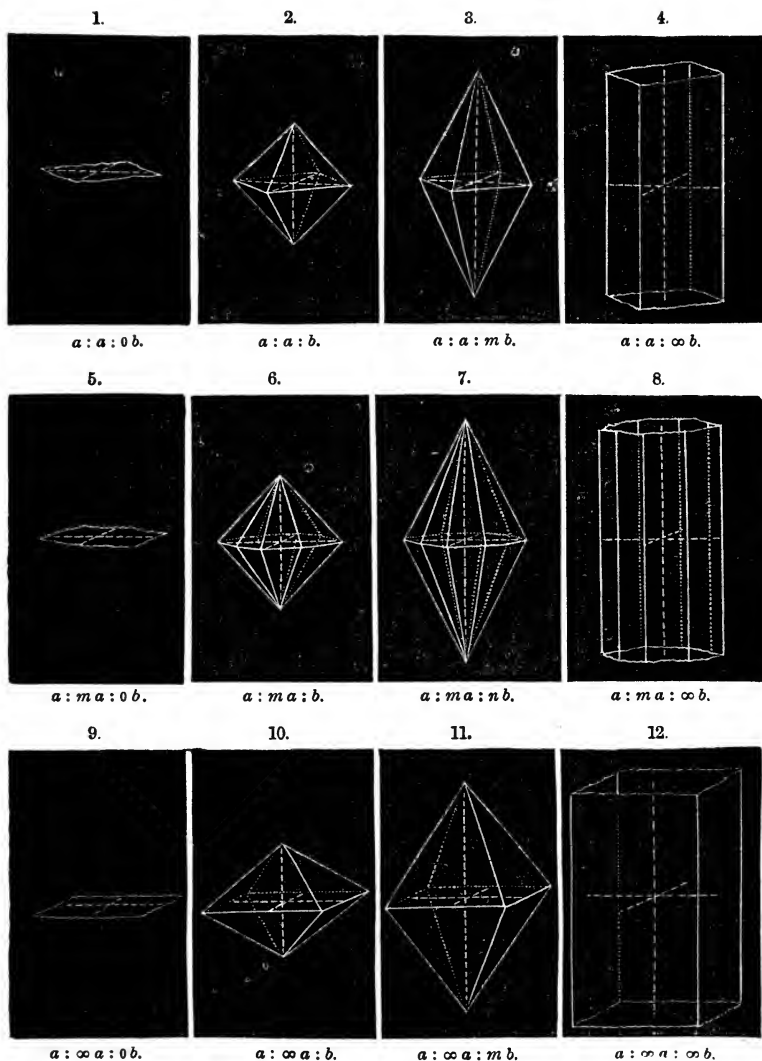
When a substance presents several octahedrons, we are guided in the selection of one of these for the *principal form* by many circumstances. Among these may be mentioned the frequency of occurrence, the predominance of the planes of the different octahedrons on compound crystals, the position of the planes of cleavage, and the crystalline form of other substances which are analogous in composition and homœomorphous* with it. The selection is in all cases, however, more or less arbitrary, and we must be careful in comparing the crystalline forms of different substances to keep this fact in view, since otherwise we might be led to erroneous conclusions. †

Having, then, in the case of a given substance crystallizing in the dimetric system, selected one octahedron as the principal form, and given to it the symbol $a : a : b$, we may have on crystals of this same substance an infinite number of other octahedrons, having the general symbol $a : a : m b$, where m is always

* Two substances are said to be homœomorphous, when they crystallize in forms which are closely allied.

† See Dana's System of Mineralogy, Vol. I. p. 192 and following.

a very simple rational integer or fraction. Thus we may have octahedrons whose symbols are

$$\begin{array}{lll} a : a : 2b, & \text{or} & a : a : \frac{1}{2}b. \\ a : a : 3b, & \text{"} & a : a : \frac{1}{3}b. \\ a : a : 4b, & \text{"} & a : a : \frac{1}{4}b. \end{array}$$

As the value of m increases, the octahedrons become more and more acute; and finally, when $m = \infty$, the octahedral planes become parallel to the vertical axis, and we have the square prism whose symbol is $a : a : \infty b$ (No. 4, Fig. 98). This we may regard as one limit of the series of octahedrons. On the other hand, as the value of m diminishes, the octahedrons become more and more obtuse; and finally, when $m = 0$, the octahedral planes coincide with the basal plane, No. 1, which we may regard as the other limit of the series. The symbol of the basal plane may be written either $a : a : 0b$, or, as is more usual, $\infty a : \infty a : b$, which is obtained from the first by multiplying each parameter by ∞ , remembering that $0 \times \infty = 1$.

It will be noticed that neither the square prism nor the basal plane encloses space, and therefore neither can alone constitute a crystal. The two combined form a square prism with its basal plane, which is therefore a compound crystal.

In the monometric system, the axes of the octahedron always unite the vertices of the opposite solid angles. In the dimetric system, also, the vertical axis always unites the vertices of the two solid angles forming the summits of the octahedron, but the lateral axes may have two positions. They may either unite the solid angles or the centres of opposite basal edges. The two positions which these axes may assume are represented in Figs. 99, 100, which represent sections through the base of the octahedron.

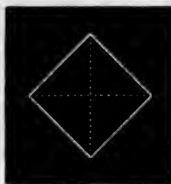

Fig. 99.

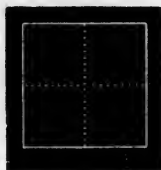

Fig. 100.

We may thus have two octahedrons, such as Nos. 3 and 11, of different dimensions, but yet having axes which are perfectly equal. The faces of the octahedron whose base is represented by Fig.

100 have the same position as the edges of the octahedron whose base is represented by Fig. 99. We distinguish the two octahedrons by calling the one represented in No. 3 the *direct* octahe-

dron, and the one represented in No. 11 the *inverse* octahedron. Since the external appearance of the two octahedrons is precisely the same, it is not always possible to determine to which form a given crystal belongs; and this fact introduces a still further difficulty in determining the principal form of a substance.

The general symbol of the inverse octahedron is $a : \infty a : m b$, where m represents any simple rational integer or fraction. Thus we may have inverse octahedrons on crystals of the same substance, whose symbols are

$$\begin{array}{lll} a : \infty a : b, & \text{or} & a : \infty a : \frac{1}{2} b. \\ a : \infty a : 2 b, & \text{“} & a : \infty a : \frac{1}{3} b. \\ a : \infty a : 3 b, & \text{“} & a : \infty a : \frac{1}{4} b. \end{array}$$

The limit of this series of octahedrons on one side is a square prism, No. 12, whose symbol is $a : \infty a : \infty b$; and on the other side the basal plane, whose symbol is $a : \infty a : 0 b$, or $\infty a : \infty a : b$.

Between the direct octahedron, No. 3, and its corresponding inverse octahedron, No. 11, there is an intermediate form, No. 7, which may be called the *diocahedron*. The parameters of the faces of this form are $a : m a : n b$. When $m = 1$ this form becomes the direct octahedron, and when $m = \infty$ it passes into the inverse octahedron. Again, for any constant value of m , for example, $m = 2$, as in the figure, we may have an infinite series of diocahedrons with different values of n . As the value of n increases, these diocahedrons become more and more acute; and when $n = \infty$, they pass into the octagonal prism, No. 8. As the value of n diminishes, they become more and more obtuse; and when $n = 0$, they pass into the basal plane, No. 5. For any other value of m , for example, $m = 3$, we may have a similar series; and hence there may be an infinite number of series of diocahedrons and an infinite number of forms in each series.

Hemihedral Simple Forms.

By extending the alternate planes of the square octahedron, two tetrahedrons may be obtained similar to the two tetrahedrons of the monometric system, but differing from them in the relative length of their vertical axis. We may evidently have a series of either positive or negative tetrahedrons, corresponding with the system of octahedrons, and varying between a square prism on one side and the basal plane on the other. In like

manner, by extending the alternate planes or the alternate sets of planes of the dioctahedron, we may obtain several hemihedral forms. The hemihedral forms of this system, however, rarely occur except as modifying holohedral forms.

Compound Forms.

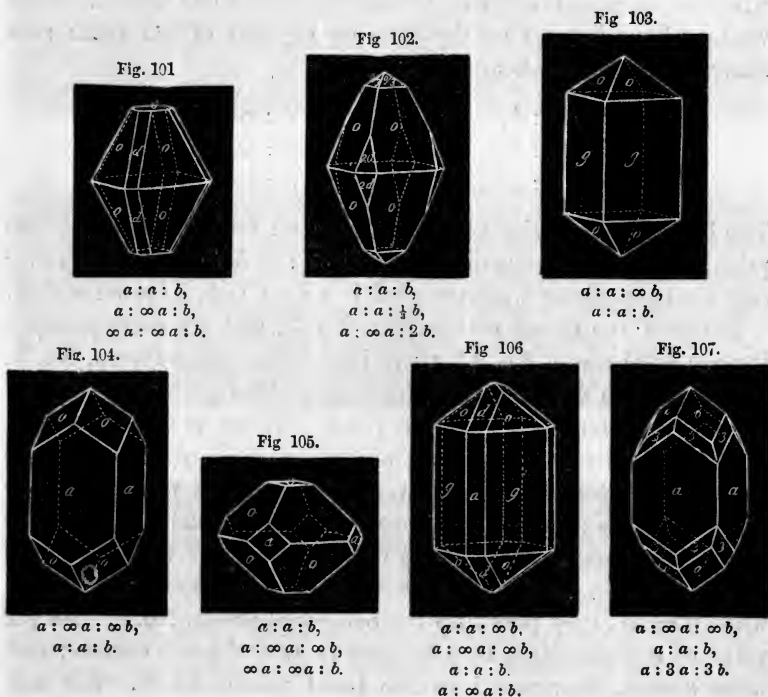

When the two principal octahedrons combine, the inverse octahedron truncates the edges of the direct octahedron, as in Fig. 101, which also presents the two basal planes. Fig. 102 represents a combination of the principal octahedron, o , with an octahedron of the same class, $\frac{2}{3}$, and with an octahedron of the second class, $2d$. Fig. 103 represents a combination of the square prism of the first class, g , with the principal octahedron, o . Fig. 104 represents a combination of the square prism of the second class, a , with the principal octahedron, o , in which the prism is the dominant form. Fig. 105 represents the same combination, in which the octahedron is the dominant form, with the addition of the basal planes. The composition of the two remaining crystals can easily be made out from the symbols below the figures.

HEXAGONAL SYSTEM.

Simple Holohedral Forms.

Fig. 108.

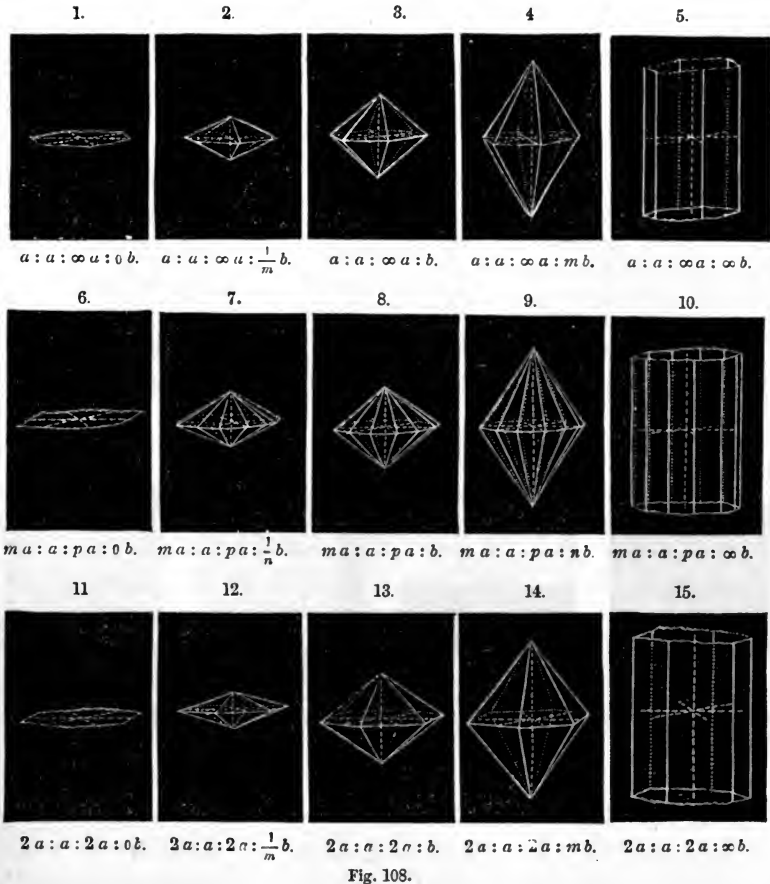

Fig. 108.

The simple forms of the hexagonal system are closely allied to those of the dimetric system. They are represented in Fig. 108, and the relation between them is indicated by the arrangement of the forms in the figure. The fundamental form of this system is called the *hexagonal pyramid*,* No. 3. The crystals of the same substance may present a number of these hexagonal pyramids, but we always find that, when they have the same base, the lengths of their vertical axes stand to each other in very simple ratios. As

* The term *pyramid* is not used here in the geometrical sense.

in the dimetric system, we select one of these for the principal form, and give to it the symbol $a : a : \infty a : b$. The general symbol of the other hexagonal pyramids of the same substance is then $a : a : \infty a : m b$, in which m is always some very simple integer or fraction. As the value of m increases, the pyramid becomes more and more acute; and when $m = \infty$, it passes into the hexagonal prism, No. 5. On the other hand, as the value of m diminishes, the pyramid becomes more and more obtuse, and finally passes into the basal plane, No. 1. This series of pyramids are called *hexagonal pyramids of the first order*, to distinguish them from the hexagonal pyramids represented in the lower row of forms in Fig. 108, which are called *hexagonal pyramids of the second order*.

In the hexagonal pyramids of the second order, the lateral axes unite the centres of edges, as in Fig. 110, while in those of the first order they unite opposite solid angles, as in Fig. 109. The lengths of the axes in the two figures are the same. The intersection of one of the faces of the pyramid of the second order with the basal plane, is the line



Fig. 109.

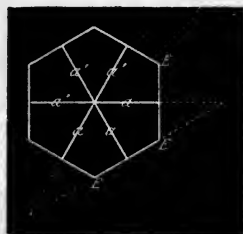

Fig. 110.

EE , Fig. 110, and it can easily be seen that this plane, if extended, would intersect the three lateral axes at distances from the centre of $2a$, a , and $2a$ respectively. The symbol of the principal pyramid of this class (No. 13 of Fig. 108) is therefore $2a : a : 2a : b$, and the general symbol of other pyramids of the second class $2a : a : 2a : m b$, where m is always some simple rational integer or fraction. As the value of m increases or diminishes, this series of pyramids passes through the same variations of form as those of the first class. The two limits are the hexagonal prism, where $m = \infty$, and the basal plane, where $m = 0$.

It will be noticed that the planes of the hexagonal pyramid and prism of the second order have the same position as the edges of the corresponding forms of the first order, and will therefore truncate these edges when the two forms enter into combination.

Intermediate between the two classes of hexagonal pyramids

are the dihexagonal pyramids (Fig. 111). This form is bounded by twenty-four scalene triangles, and the symbol of the principal form of the class is $ma : a : pa : b$, in which m and p are so related that $p = \frac{m}{m-1}$. When $m = 1$ then $p = \infty$, and this form passes into the hexagonal pyramid of the first order, and when $m = 2$ then $p = 2$, and it passes into the hexagonal pyramid of the second order. The general symbol of other dihexagonal pyramids is $ma : a : pa : nb$, where n is any rational fraction or integer. When $n = \infty$, the form passes into the dihexagonal prism, No. 10 of Fig. 108, and when $m = 0$, it passes into the basal plane, No. 6 of Fig. 108.

Fig. 111.

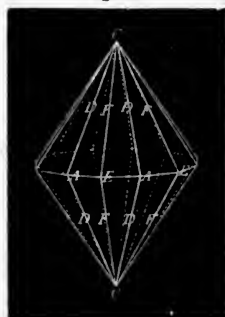

$ma : a : pa : nb$.

Simple Hemihedral Forms.

The hemihedral forms of this system occur more frequently in nature than the holohedral forms, and therefore demand special attention. The most important of them are represented in Fig. 115 (see next page), in which the forms have been grouped so as to show the relations between them. In studying these forms, we will commence with the rhombohedron, Nos. 2, 3, 4 of Fig. 115.

Rhombohedron. — The rhombohedron is bounded by six equal and similar rhombs. Its edges are of two kinds; — first, six sim-

Fig. 112.

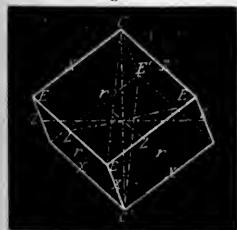

$+\frac{1}{2}(a : a : \infty a : b)$.

Fig. 113.

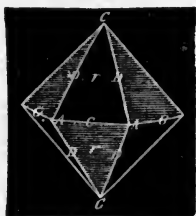

$a : a : \infty a : b$.

Fig. 114.

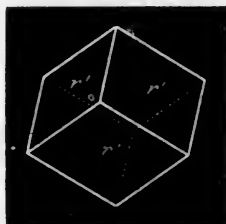

$-\frac{1}{2}(a : a : \infty a : b)$.

ilar *terminal edges*, marked X in Fig. 112; secondly, six similar *lateral edges*, which are lettered Z. The solid angles are also of two kinds; — first, two similar *vertical solid angles*, lettered C, consisting of three equal plane angles; secondly, six *lateral solid*

angles, lettered E , which are similar to each other, but do not consist of equal angles. The vertical axis of the rhombohedron

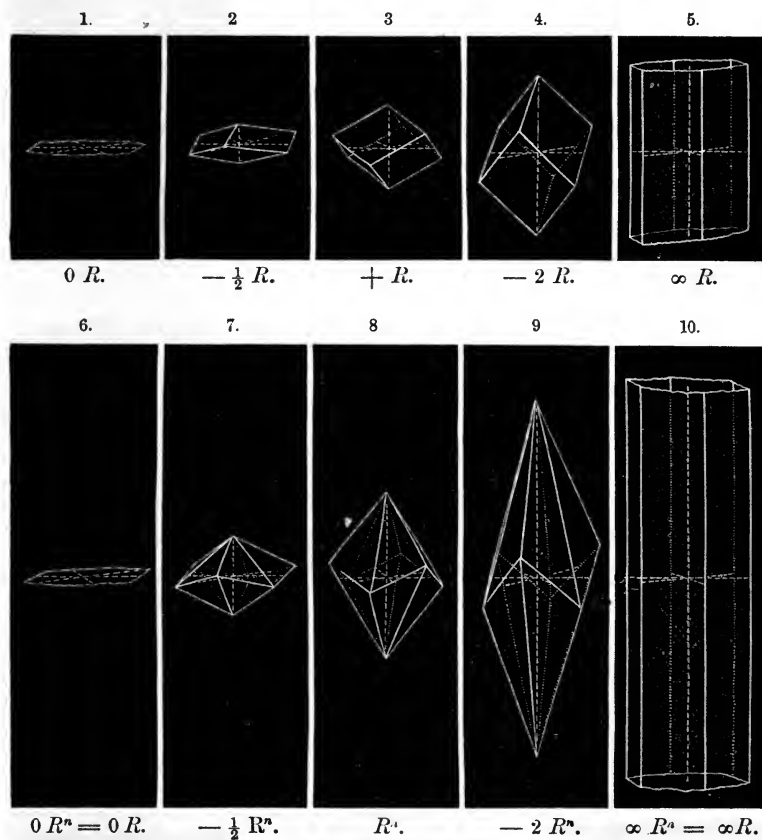

Fig. 115.

connects the vertical solid angles. The lateral axes connect the centres of opposite edges.

The interfacial angles formed at the terminal edges X are all equal to each other. This angle is one of the most important characters of the rhombohedron, and we shall call it the *rhombohedral angle*, and distinguish it by the same letter which we have used to denote the edge. When this angle is acute, the rhombohedron is said to be acute, and when it is obtuse, the rhombohedron is said to be obtuse.

The sections of the rhombohedron passing through two opposite

terminal edges are rhombs which are perpendicular to two of the faces of the form. There are three such sections in every rhombohedron, and they are called *principal sections*. One of these, $CEC'E'$, is represented in Fig. 112.

The crystals of a given substance frequently present a number of rhombohedrons, both obtuse and acute; but when these rhombohedrons have the same lateral axes, their vertical axes always bear to each other a very simple proportion. One of these rhombohedrons, which is selected on the same grounds as those already stated in connection with the dimetric system, is termed the *principal rhombohedron*.

The *principal rhombohedron* may be regarded as formed from the principal hexagonal pyramid, by extending the alternate planes until they cover the rest. As there are two sets of alternate planes, it is evident that we can obtain by this method two rhombohedrons which are perfectly equal, and which differ from each other only in position. We shall call them the positive and negative rhombohedrons, and distinguish them by writing the signs plus and minus before the symbols. These symbols are given below Figs. 112, 114, and it will be seen that they are formed after the analogy of the symbols of the hemihedral forms in the monometric system.

Since every hexagonal pyramid will give by this method two rhombohedrons, it is evident that, corresponding to the series of hexagonal pyramids, Fig. 108, we have two series of rhombohedrons. The general symbols of these two classes of rhombohedrons are

$$+\frac{1}{2}(a : a : \infty a : mb), \quad \text{and} \quad -\frac{1}{2}(a : a : \infty a : mb).$$

As the value of m increases, the rhombohedrons become more and more acute, and finally, when $m = \infty$, they pass into the hexagonal prism, No. 5, Fig. 115. On the other hand, as the value of m diminishes, the rhombohedrons become more and more obtuse, and when $m = 0$ they pass into the basal plane, No. 1, Fig. 115.

Of the series of possible rhombohedrons with any given values of the axes, there are several which stand to each other in an important relation. Commencing with the principal positive rhombohedron, $+\frac{1}{2}(a : a : \infty a : b)$, No. 3, Fig. 115, we find that the planes of the negative rhombohedron $-\frac{1}{2}(a : a : \infty a : \frac{1}{2}b)$, No. 2,

have the same position as its terminal edges, and therefore truncate them. This rhombohedron is called the *first obtuse rhombohedron*. Again, the faces of the positive rhombohedron $+\frac{1}{2}(a : a : \infty a : \frac{1}{4} b)$ truncate the edges of the first obtuse rhombohedron, and it is called the *second obtuse rhombohedron*, and so on. On the other hand, the faces of the principal rhombohedron truncate the edges of the negative rhombohedron $-\frac{1}{2}(a : a : \infty a : 2 b)$, No. 4, which is called the *first acute rhombohedron*. The faces of the first acute rhombohedron truncate the edges of the positive rhombohedron $+\frac{1}{2}(a : a : \infty a : 4 b)$, which is called the *second acute rhombohedron*, and so on.

The rhombohedrons which form this series are, then, as follows:—

Third obtuse rhombohedron,	$-\frac{1}{2}(a : a : \infty a : \frac{1}{8} b) = -\frac{1}{8} R.$
Second “ “	$+\frac{1}{2}(a : a : \infty a : \frac{1}{4} b) = +\frac{1}{4} R.$
First “ “	$-\frac{1}{2}(a : a : \infty a : \frac{1}{2} b) = -\frac{1}{2} R.$
Principal rhombohedron,	$+\frac{1}{2}(a : a : \infty a : b) = + R.$
First acute rhombohedron,	$-\frac{1}{2}(a : a : \infty a : 2 b) = -2 R.$
Second “ “	$+\frac{1}{2}(a : a : \infty a : 4 b) = +4 R.$
Third “ “	$-\frac{1}{2}(a : a : \infty a : 8 b) = -8 R.$

And in this series each rhombohedron truncates the terminal edges of the one which follows it. In crystals of the mineral calcite, almost all the above rhombohedrons have been observed, and a large number of others, not belonging to the series, but intermediate between the members of it. The general appearance of these crystals varies from almost flat plates, where the terminal angle $X = 160^\circ 42'$, to sharp needles, where the angle $X = 60^\circ 20'$.

As the regular symbol of the rhombohedron is inconveniently long, we frequently abbreviate it in practice, and write, as the symbol of the principal rhombohedrons of a given substance, $\pm R$. For other rhombohedrons we use the general symbol $\pm m R$, in which m is the same quantity as the m in the regular symbol. The abbreviated symbols of the series of acute and obtuse rhombohedrons have been given after the corresponding regular symbols in the above table, and by comparing the two the use of the abbreviation can be easily understood.

Intermediate between the obtuse and acute rhombohedrons there is a possible form, where $X = 90^\circ$. This is the case when

$a : mb = 1 : \sqrt{\frac{3}{2}}$. The rhombohedron then becomes the cube, which may therefore be regarded as a form of the hexagonal system. In like manner, all the other simple forms of the monometric system may be regarded as forms of the hexagonal system, but in this system they are compound forms. In consequence of this analogy, the crystals of the two systems frequently resemble each other very closely, especially when they have been irregularly formed.

Scaleno-hedron.—By comparing together Figs. 116 and 117, on which the similar parts have been similarly lettered, it will be seen that in the position

occupied by one plane on the hexagonal pyramid there are two planes on the dihexagonal pyramid; and hence, that we must extend the alternate pairs of planes on the dihexagonal pyramid, in order to apply to it the same method by which we obtained the

rhombohedron from the hexagonal pyramid. If, then, we extend the alternate pairs of planes on the dihexagonal pyramid, commencing with the two front upper planes of Fig. 116, we shall obtain the form represented in Fig. 118, and called a *scaleno-hedron*; or, by extending the planes suppressed in the last case, a second scaleno-hedron, differing from the first only in position. The two are distinguished, like the rhombohedrons, as positive and negative scaleno-hedrons. The scaleno-hedron, which is derived from the *principal dihexagonal pyramid*, will be called the *principal scaleno-hedron*, and its symbol is $\pm \frac{1}{2} (ma : a : pa : b)$. The general symbol of other scaleno-hedrons is $\pm \frac{1}{2} (ma : a : pa : nb)$. As the value of n diminishes, the scaleno-hedron becomes more and more obtuse, and finally, when $n = 0$, merges

Fig. 116.

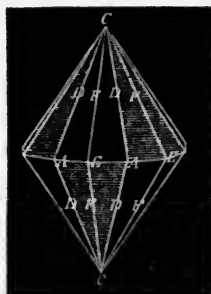

$$ma : a : pa : b.$$

Fig. 117.



$$a : a : \infty a : b.$$

Fig. 118.



$$+\frac{1}{2}(ma : a : pa : b).$$

in the basal plane. On the other hand, with increasing values of n , the scalenohedron becomes more and more acute, and when $n = \infty$ merges into the hexagonal prism.

By bringing together the rhombohedron and the scalenohedron, as has been done in Fig. 119, it will be noticed that the lateral

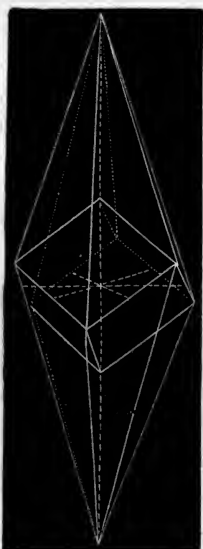

Fig. 119.

edges of the two forms have a similar position towards the axes, so that for every scalenohedron there must be a rhombohedron whose lateral edges coincide with the lateral edges of the other form. This rhombohedron is called the *inscribed rhombohedron* of the scalenohedron.

The scalenohedron may evidently be formed from the inscribed rhombohedron by prolonging the vertical axis, and then drawing lines from the ends of the vertical axis thus produced to the lateral solid angles of the rhombohedron. It is evident that we may thus make from every rhombohedron an infinite number of scalenohedrons, whose form will depend upon the extent to which the vertical axis has been elongated. We find, however, that the semi-vertical axis of the scalenohedron is always some simple multiple of that of the inscribed rhombohedron. Hence we

may use, as the abbreviated symbol of the scalenohedron, the abbreviated symbol of the corresponding inscribed rhombohedron, with an exponent indicating how many times its semi-vertical axis is greater than that of the rhombohedron. If, as in Fig. 119, the inscribed rhombohedron is the principal rhombohedron, $+R$, and the semi-vertical axis of the scalenohedron is three times that of the rhombohedron, the abbreviated symbol of the rhombohedron is $+R^3$. The general symbol for any scalenohedron is $\pm mR^n$, in which $\pm mR$ is the symbol of the inscribed rhombohedron. It has already been stated, that the number of the possible rhombohedrons on the crystals of a given substance is infinite, and it now appears that for every rhombohedron there may be an infinite number of scalenohedrons; so that the number of possible scalenohedrons on the crystals of a given substance is infinitely greater than the infinite number of possible rhombohedrons. The mineral calcite has a great tendency to

crystallize in scalenohedrons (dog-tooth crystals), and no less than thirty-eight rhombohedrons and seventy-six scalenohedrons have been observed among the crystals of this substance.*

Besides the two hemihedral forms which have been described, there are two other hemihedral forms in the hexagonal system, which may be derived from the dihexagonal pyramid.

The *first* of these is obtained by extending the alternate pairs of planes, united at a lateral edge, *A E*, Fig. 120, where the alternate planes are distinguished by the shading. As we extend the shaded or the unshaded planes of Fig. 120, we obtain one or the other of two hexagonal pyramids, which differ from each other and from the hexagonal pyramids already described only in the position of the axes. The lateral axes of the pyramids thus derived do not unite the opposite solid angles, as is the case with pyramids of the first order (Fig. 109); nor yet the centres of opposite edges, as is the case with pyramids of the second order (Fig. 110); but points on the lateral edges intermediate between the centre and the ends.

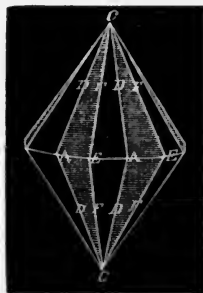

Fig. 120.

The *second* of these hemihedral forms is obtained by extending the alternate pairs of planes united at a lateral solid angle,

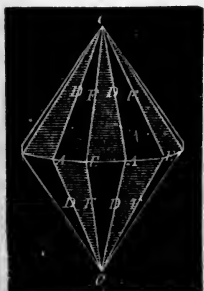

Fig. 121.



Fig. 122.



Fig. 123.

as shown by the shading in Fig. 121. According as the unshaded or the shaded planes are extended, we obtain the two forms represented in Figs. 122, 123. They are called the *hex-*

* See Dana's System of Mineralogy, Vol. II. p. 437, for the symbols of these forms.

agonal trapezohedrons. The two forms derived from the same dihexagonal pyramid differ from each other, not only in the absolute position of the form, but also in the relative position of their planes. They are distinguished as the *right* and *left* trapezohedrons, and their symbols are respectively

$$r \frac{1}{2} (m a : a : p a : n b), \quad \text{and} \quad l \frac{1}{2} (m a : a : p a : n b).$$

Tetartohedral Forms.

By extending the alternate planes of the right hexagonal trapezohedron (Fig. 121), we can obtain two forms, differing from each other only in position, whose symbols are

$$\pm r \frac{1}{4} (m a : a : p a : n b);$$

and, in like manner, from the left hexagonal trapezohedron two other forms may be obtained, whose symbols are

$$\pm l \frac{1}{4} (m a : a : p a : n b).$$

Each of these four forms is bounded by six isosceles trapeziums, and they are therefore called *trigonal trapezohedrons*. They are evidently tetartohedral forms of the dihexagonal pyramid.

These tetartohedral forms are never found isolated in nature; but they appear very frequently on crystals of quartz in combination with other forms. The crystals of this mineral are usually a combination of a hexagonal prism with a hexagonal pyramid of the same order (Fig. 125), and the trigonal trapezohedrons appear as modifying planes on the solid angles. In Fig. 124, the

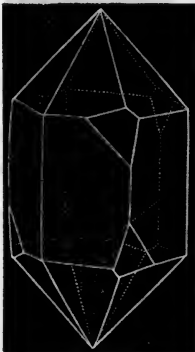

Fig. 124.

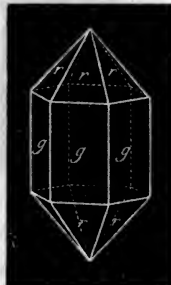

Fig. 125.

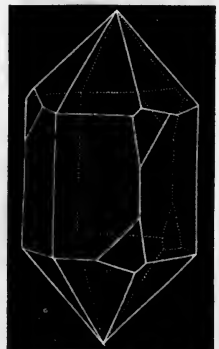

Fig. 126.

lateral solid angles are modified by the planes of the positive right-trigonal trapezohedrons, and in Fig. 126, by the planes of

the positive left-trigonal trapezohedron. The two negative forms would modify in a similar way the set of solid angles, which are not modified in the figures.

The difference of form between the right and left trapezohedron is found to be accompanied with remarkable differences of optical properties, which will be explained in the section on the circular polarization of light.

Compound Forms.

The crystal represented by Fig. 127 is a combination of the hexagonal prism with the basal plane, the symbols of which are given in this order below the figure. On the crystal represented by

Fig. 127.

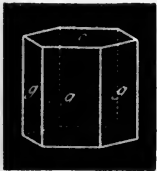

$$a : a : \infty a : \infty b,$$

$$\infty a : \infty a : \infty a : b.$$

Fig. 128.



$$-\frac{1}{2}(a : a : \infty a : \frac{1}{2} b),$$

$$+\frac{1}{2}(a : a : \infty a : b).$$

Fig. 129.

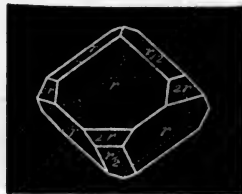

$$+ R - \frac{1}{2} R + 2 R.$$

Fig. 128 there are evidently the faces of two rhombohedrons, the one positive and the other negative. If we assume that the faces lettered r are those of the principal rhombohedron, R , then it is evident that the faces lettered $\frac{r}{2}$ are those of the first obtuse rhombohedron,

$\frac{1}{2} R$, because they truncate the vertical edges of the rhombohedron R . As the planes of the first obtuse rhombohedron are much larger than those of the principal rhombohedron, it is not at once evident from the figure that the first are truncating planes; but on a model this fact could easily be discovered, by noticing that the edges formed by any plane, $\frac{r}{2}$, with the two adjacent planes, r , are in every case parallel (91). If, in Fig. 129, we assume that the faces r are those of the principal rhombohedron, then the faces $\frac{r}{2}$, which truncate the edges of the prin-

Fig. 130.



$$+ 4 R + R$$

Fig. 131.

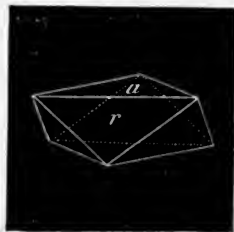

$$+\frac{1}{2}(a : a : \infty a : b),$$

$$+\frac{1}{2}(\infty a : \infty a : \infty a : b).$$

cipal rhombohedron, belong to the first obtuse rhombohedron, $-\frac{1}{2} R$, and the faces $2r$ to the first acute rhombohedron $-2R$; because the edges of this form are truncated by the faces r of the principal rhombohedron. Fig. 130 represents a combination of the principal rhombohedron with its second acute rhombohedron, $4R$. Fig. 131 represents the combination of the principal rhombohedron with the basal plane. It will be noticed how closely this form resembles the octahedron of the monometric system, and it, in fact, merges into the octahedron when the angle of a on r is equal

to $109^\circ 28' 16''$, which is the case when the axes of the rhombohedron are to each other as $1 : 2.4495$. It will be remembered that the cube may be regarded as a rhombohedron, in which $a : b = 1 : 1.2247$. Hence the octahedron may be regarded as the first acute rhombohedron of the cube combined with the

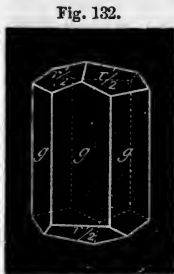

Fig. 132.
 $+\frac{1}{2}(a : a : a : \infty b)$,
 $-\frac{1}{2}(a : a : a : \frac{1}{2} b)$.



Fig. 133.
 $+R^2 + R$.

basal plane. The compound form of Fig. 132 consists of a hexagonal prism of the first order combined with the rhombohedron $-\frac{1}{2} R$. Finally, Fig. 133 represents a combination of a scalenohedron, R^2 , with the rhombohedron R .

TRIMETRIC SYSTEM.

Simple Forms.

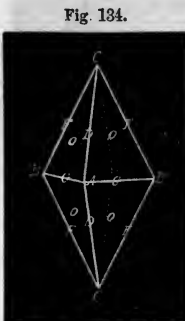

Fig. 134.
 $a : b : c$.



Fig. 135.



Fig. 136.



Fig. 137.

The fundamental form of this system is the *rhombic octahedron*, so called because the three *principal sections* made by planes

passing through the axis are all rhombs.* This fact is illustrated by Figs. 135, 136, 137, which represent these sections, and which have been lettered to correspond with Fig. 134. The same substance frequently crystallizes in several octahedrons. In such cases we select one of these as the principal octahedron, giving to it the symbol $a : b : c$, and we then find that the parameters of the planes of the other octahedrons always stand in some simple relation to those of the one thus selected. Besides the octahedrons, the only other simple forms of this system are rhombic prisms and terminal or basal planes.† The relation of these forms can be best understood by studying their symbols.

Having given to the principal form the notation $a : b : c$, then the other octahedrons which the same substance can present will be expressed by the following symbols:—

- | | |
|--------------------|----------------------|
| 1. $a : m b : c$, | 3. $m a : b : c$, |
| 2. $a : b : m c$, | 4. $m a : b : n c$, |

in which m and n are always very simple rational numbers. The first three of these symbols may evidently be regarded as particular cases of the third.

The number of possible octahedrons in which a given substance may crystallize in the trimetric system is evidently infinite; but the number which have in any case been observed is extremely limited, including only a few of the possible values of m and n , together with the rhombic prisms and terminal planes which result when m and n are made equal either to infinity or zero.

If in No. 1 we put $m = \infty$, the symbol becomes $a : \infty b : c$, which represents a rhombic prism whose axis is the axis of b . If $m = 0$, the symbol becomes $a : 0 b : c = \infty a : b : \infty c$, which is the symbol of the basal planes of the same prism. If in No. 2 we put $m = \infty$, we obtain the symbols of a rhombic prism whose axis is the axis of c ; and if we put $m = 0$, we obtain the symbol of the basal planes of the same prism. So also, if in No. 3 we put m equal to infinity and zero, we obtain the symbols of a rhombic prism parallel to the axis of a and of its basal planes.

* A section of a crystal is called a *principal section* when it contains two of the axes.

† Planes placed at the ends of any axis, and parallel to the plane of the other two, are called *terminal planes*. Such planes, when they form the base of a crystal, are called *basal planes*.

The general symbol No. 4 may be put in the three following forms:

$$1. a : n b : m c, \quad 2. n a : m b : c, \quad 3. m a : b : n c.$$

If in No. 1 we put $n = \infty$, we obtain a rhombic prism parallel to the axis of b , whose symbol is $a : \infty b : m c$; if $n = 0$, we obtain the basal plane of this prism. If in No. 2 we put $n = \infty$, we obtain a rhombic prism parallel to the axis of a , whose symbol is $\infty a : m b : c$; if $n = 0$, we obtain the basal planes of this prism. If in No. 3 we put $n = \infty$, we obtain a rhombic prism parallel to the axis of c , whose symbol is $m a : b : \infty c$; if $n = 0$, we obtain the basal planes of this prism.

Compound Forms.

We give below several figures of the compound forms of this system, and beneath each the symbols of the simple forms of

Fig. 133.

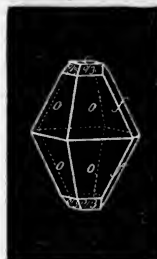

$$\begin{aligned} o &= a : b : c, \\ o/3 &= a : \frac{1}{3} b : c, \\ f &= \infty a : b : c, \\ c &= \infty a : b : \infty c. \end{aligned}$$

Fig. 139.

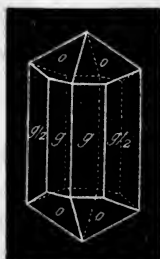

$$\begin{aligned} o &= a : b : c, \\ g &= a : \infty b : c, \\ g &= a : \infty b : \frac{1}{2} c. \end{aligned}$$

Fig. 140.



$$\begin{aligned} g &= a : \infty b : c, \\ f &= \infty a : b : c, \\ 2f &= \infty a : 2b : c. \end{aligned}$$

Fig. 141.

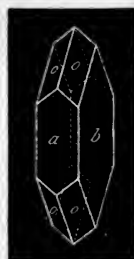

$$\begin{aligned} o &= a : b : c, \\ a &= a : \infty b : \infty c, \\ b &= \infty a : \infty b : c. \end{aligned}$$

Fig. 142.

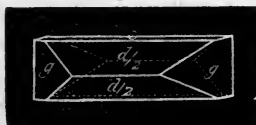

$$\begin{aligned} g &= a : \infty b : c, \\ d/2 &= a : \frac{1}{2} b : \infty c, \\ c &= \infty a : b : \infty c. \end{aligned}$$

Fig. 144.

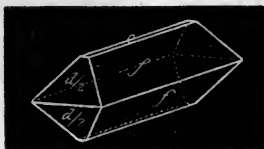

$$\begin{aligned} d/2 &= a : \frac{1}{2} b : c, \\ f &= \infty a : b : c, \\ c &= \infty a : b : \infty c. \end{aligned}$$

Fig. 143.

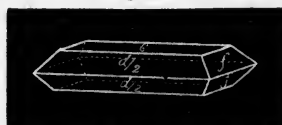

$$\begin{aligned} d/2 &= a : \frac{1}{2} b : \infty c, \\ f &= \infty a : b : c, \\ c &= \infty a : b : \infty c. \end{aligned}$$

Fig. 145.

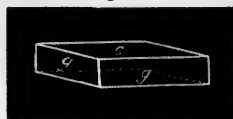

$$\begin{aligned} g &= a : \infty b : c, \\ c &= \infty a : b : \infty c. \end{aligned}$$

which it consists, opposite to the letters on the faces of the crystal. With the aid of these symbols, the student will easily be able to see the relations of the forms without any further description.

Hemihedral Forms.

Fig. 146.

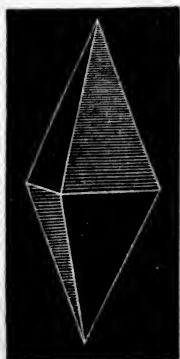

$$a : b : c.$$

Fig. 147.

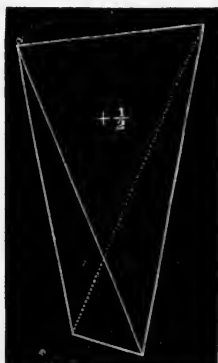

$$+\frac{1}{2}(a : b : c).$$

Fig. 148.

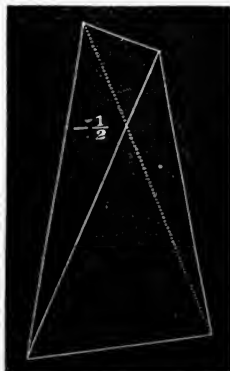

$$-\frac{1}{2}(a : b : c).$$

The most important hemihedral form of this system is the rhombic sphenoid, Figs. 147, 148. It may be developed by extending the alternate planes of the rhombic octahedron, Fig. 146. If we extend the shaded planes, we obtain the positive sphenoid, Fig. 147; and if we extend the planes which are not shaded, the negative sphenoid, Fig. 148. The rhombic sphenoid is a tetrahedral form, and is bounded by four scalene triangles. It will be remembered that the two tetrahedrons, derived from the octahedron of the monometric system, differed from each other only in position, and that, by turning one round the vertical axis through a quarter of a revolution, the two would coincide. It is different with the two sphenoids. They differ from each other in the relative position of their planes, and by turning one on its axis it cannot be brought into a position in which it will coincide with the other. The two forms are related to each other as the *left hand* is to the *right hand*, or as an object is to its image in a mirror. Hence, we call the positive a *right form*, and the negative a *left form*.

The two sphenoids never occur in nature except in combination with other forms, and the presence of one or the other of these

forms on a crystal is associated with certain remarkable optical properties. By neutralizing a solution of racemic acid, half with soda and half with ammonia, a bibasic salt is formed, called the racemate of soda and ammonia, which can be readily crystallized by evaporating the solution. The crystals thus formed are of two kinds, part resembling Fig. 149, and part Fig. 150. The two

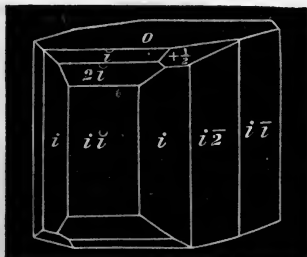

Fig. 149.

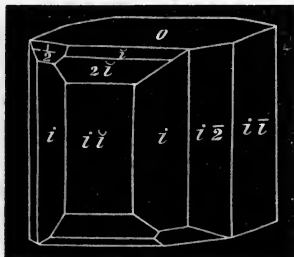

Fig. 150.

kinds of crystals resemble each other in their general appearance. They both have the planes of the vertical rhombic prisms (i and $i\bar{2}$), the terminal planes ($i\bar{1}$ and $i\bar{1}$), the basal planes (o), the planes of two prisms parallel to the brachydiagonal (\bar{i} and $2\bar{i}$); but in addition to these, there appear on the first kind of crystals (Fig. 149) the planes of the positive sphenoid, $+\frac{1}{2}$, and on the second kind of crystals (Fig. 150) those of the negative sphenoid, $-\frac{1}{2}$. If, now, we arrange a crystal of each sort, as in the figures, with the terminal planes $i\bar{1}$ in front, it will be seen that the upper sphenoid plane is in the first figure on the right, and in the second on the left, of the observer; so that, if we place one form before a mirror, the image will have exactly the second form. In these two forms there are present two varieties of tartaric acid, into which the racemic acid divides in the process of crystallization. In the crystals of Fig. 149, the two bases are united with a variety of tartaric acid, which has the power of rotating the plane of polarization of a ray of light to the right; and in Fig. 150, with a variety of tartaric acid resembling the other in all its chemical relations, but differing in its crystalline form, and rotating the plane of polarization to the left.

The sphenoid is the only hemihedral form in this system which encloses space, and which therefore could alone form a crystal. Other hemihedral forms have been observed, but they never ap-

pear except in combinations modifying one half of the similar edges or solid angles of the dominant form, and they can therefore be easily recognized.

MONOCLINIC SYSTEM.

Simple Forms.

In the monoclinic system, as has been already stated, no single crystalline form can enclose space; and hence we have no simple crystals. Fig. 151 represents an octahedron belonging to this system; but this is not a simple crystal, because it is bounded by faces of two kinds. The triangular faces BAC , $B'A'C$, $B'A'C'$, and $B'A'C'$ are not similar to the faces BAC' , $B'A'C'$, $B'A'C$, and $B'A'C$, and therefore belong to a different form. The first set of faces, if extended, would evidently form a rhombic prism; and the second set of faces, if extended, would also form a rhombic prism differing from the first. These two prisms may be appropriately termed *hemi-octahedrons*; and in order to distinguish them, we shall name the one whose planes are over the acute angle a , Fig. 151, the *positive hemi-octahedron*, and the other the *negative hemi-octahedron*. This distinction is necessary, because it frequently happens that one of these hemi-octahedrons is present on a crystal without the other, or at least that the faces of one are far more dominant than those of the other.

Adopting the notation of Fig. 152, already described (85), the symbol of the positive hemi-octahedron is $a : b : c$, or $a : b' : c'$. The first symbol consists of the parameters of the two upper right-hand planes of the form, Fig. 151, and the second of those of the two lower left-hand planes; either symbol may be used at pleasure. The symbol of the negative hemi-octahedron is $a : b : c'$, or $a : b' : c$; the first being the parameters of the two upper left-hand planes, and the second

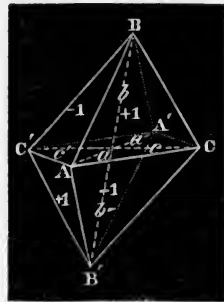

Fig. 151.

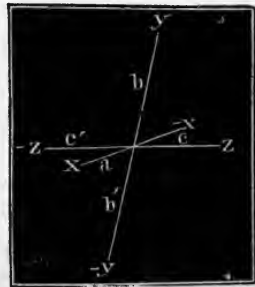

Fig. 152.

those of the two lower right-hand planes. Either symbol, as before, may be used as the symbol of the form, but for the sake of uniformity we shall use in both cases the first of the two symbols. The symbols of the two hemi-octahedrons, of which the octahedron of this system consists, are, then,

$$a : b : c, \quad \text{and} \quad a : b : c';$$

but it must be remembered that these symbols include not only the planes whose parameters they actually express, but also the planes which have the same parameters oppositely accented.

In this system, as has been already stated (82-85), not only the relative length of the axes may vary, but, moreover, the angle of inclination of the vertical axis b to the klinodiagonal c varies also. When, however, the crystals of the *same substance* present planes of several pairs of hemi-octahedrons, we always find that, although the relative lengths of the axes of these forms may differ, yet the angle of inclination, α , is the same in all. We select in this system, as in the last three, one pair of these hemi-octahedrons as the principal form, and give to it the symbols $a : b : c$ and $a : b : c'$. The general symbol of other hemi-octahedrons of the same substance is, then,

$$m a : n b : p c, \quad \text{or} \quad m a : n b : p c',$$

the quantities m , n , and p being always simple rational integers or fractions, and one of them being always unity.

The forms which are most frequently met with in this system are those which result when either $m = \infty$, $n = \infty$, or $p = \infty$, or when $m = 0$, $n = 0$, or $p = 0$, in the general symbols.

In making $n = \infty$, and $p = 1$, the general symbols become $m a : \infty b : c$, and $m a : \infty b' : c'$.* Since the dissimilar semi-axes are oppositely accented in the two symbols, they are both equivalent symbols of the same oblique rhombic prisms parallel to the axis b . When, also, $m = 1$, we obtain the symbol of the principal of these oblique prisms, $a : \infty b : c$.

In making $m = \infty$ and $p = 1$, in the general symbols, we obtain the two symbols $\infty a : n b : c$, and $\infty a : n b : c'$. These symbols are not equivalent, and each represents two opposite and parallel planes, which are also parallel to the orthodiagonal. The two planes represented by the first symbol are over the acute

* Since b and b' are halves of the same straight line, the parameters ∞b and $\infty b'$ are in all respects equivalent, and may therefore be substituted for each other.

angle α , and are therefore narrower than the two planes represented by the second symbol, which are over the obtuse angle $180^\circ - \alpha$. The two sets of planes evidently bear the same relation to each other as the two hemi-octahedrons, and may therefore be called the *positive* and *negative orthodiagonal hemi-prisms*. When $n = 1$, the two symbols become $\infty a : b : c$, and $\infty a : b : c'$.

Finally, if we put $p = \infty$, and $m = 1$, in the general symbols, we obtain $a : nb : \infty c$ in both cases, which is the symbol of horizontal rhombic prisms parallel to the klinodiagonal, called the *klinodiagonal prisms*. When $n = 1$, the symbol becomes $a : b : \infty c$.

Substituting $m = 0$, and multiplying all the parameters by ∞ , the general symbols become in both cases $a : \infty b : \infty c$, which is the symbol of a form consisting of two terminal planes parallel to the planes of the axes b and c . In like manner, if we put $n = 0$, or $p = 0$, we obtain the symbols of terminal planes parallel to the planes of the axes a, c or a, b respectively.

Compound Forms.

Fig. 153.

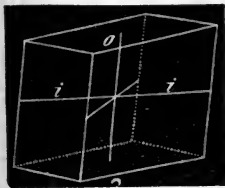

$$\begin{aligned} i &= a : \infty b : c, \\ 0 &= \infty a : b : \infty c. \end{aligned}$$

Fig. 154.

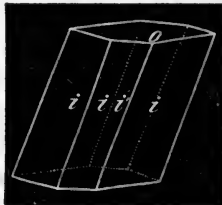

$$\begin{aligned} i &= a : \infty b : c, \\ 0 &= \infty a : b : \infty c, \\ i' &= a : \infty b : \infty c. \end{aligned}$$

Fig. 155.

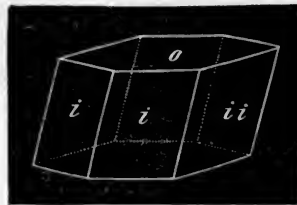

$$\begin{aligned} i &= a : \infty b : c, \\ 0 &= \infty a : b : \infty c, \\ ii &= \infty a : \infty b : c. \end{aligned}$$

Fig. 153 represents the combination of the principal oblique rhombic prism, with its basal planes. Fig. 154 represents the

Fig. 156.

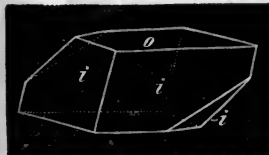

$$\begin{aligned} i &= a : \infty b : c, \\ 0 &= \infty a : b : \infty c, \\ -i &= \infty a : b : c'. \end{aligned}$$

Fig. 157.

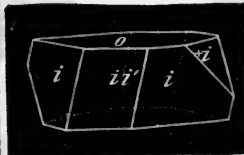

$$\begin{aligned} i &= a : \infty b : c, \\ 0 &= \infty a : b : \infty c, \\ ii' &= a : \infty b : \infty c, \\ +i &= \infty a : b : c. \end{aligned}$$

Fig. 158.

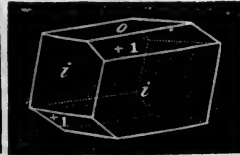

$$\begin{aligned} i &= a : \infty b : c, \\ 0 &= \infty a : b : \infty c, \\ +1 &= a : b : c. \end{aligned}$$

same combination, with the addition of two terminal planes at the end of the orthodiagonal. Fig. 155 represents the same combina-

Fig. 159

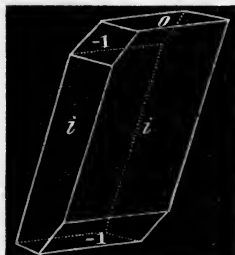

$$\begin{aligned} i &= a : \infty b : c, \\ 0 &= \infty a : b : \infty c, \\ -1 &= a : b : c. \end{aligned}$$

Fig. 160.

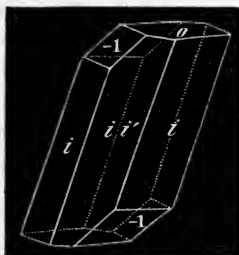

$$\begin{aligned} i &= a : \infty b : c, \\ 0 &= \infty a : b : \infty c, \\ i' &= a : \infty b : \infty c, \\ -1 &= a : b : c. \end{aligned}$$

Fig. 161.

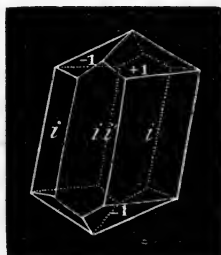

$$\begin{aligned} i &= a : \infty b : c, \\ i' &= a : \infty b : \infty c, \\ +1 &= a : b : c, \\ -1 &= a : b : c. \end{aligned}$$

tion, with the addition of two planes at the end of the klinodiagonal. Fig. 156 represents still the same combination, with

Fig. 162

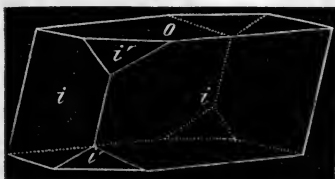

$$\begin{aligned} i &= a : \infty b : c, \\ 0 &= \infty a : b : \infty c, \\ i' &= a : b : \infty c. \end{aligned}$$

the addition of the two planes of the negative orthodiagonal hemiprism. Fig. 157 represents the same combination as Fig. 154, with the addition of the two planes of the positive orthodiagonal hemiprism. Fig. 158 is the same combination as Fig. 153, with the addition of the positive

principal hemi-octahedron. Fig. 159 is also the same combina-

Fig. 163

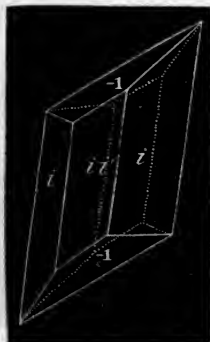

$$\begin{aligned} i &= a : \infty b : c, \\ i' &= a : \infty b : \infty c, \\ -1 &= a : b : c. \end{aligned}$$

Fig. 164.

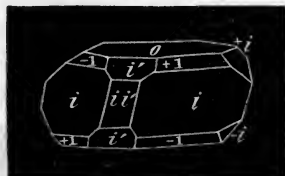

$$\begin{aligned} i &= a : \infty b : c, \\ 0 &= \infty a : b : \infty c, \\ i' &= a : \infty b : \infty c, \\ +1 &= a : b : c, \\ -1 &= a : b : c, \\ +i &= \infty a : b : c, \\ -i &= \infty a : b : c, \\ i' &= a : b : \infty c. \end{aligned}$$

tion, with the addition of the negative hemi-octahedron. Fig. 160 is the same combination as Fig. 154, with the negative hemi-octahedron. Fig. 161 is the same with both hemi-octahedrons. Fig. 162 represents the same combination as Fig. 153, with the addition of the four planes of the prism parallel to the klinodiagonal. Fig. 163 is the same combination as Fig. 160, except that the planes of the negative hemi-octahedron are more dominant, and the basal planes do not appear. Lastly, Fig. 164 represents a combination of all the forms which have appeared on the previous figures of this system.

Hemihedral Forms.

The hemihedral forms of this system only appear as modifying planes on the edges or solid angles of the holohedral forms, and

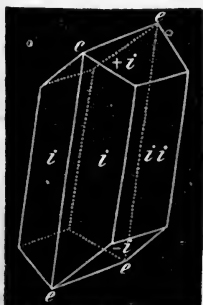

Fig. 165.

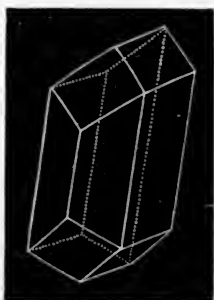

Fig. 166.

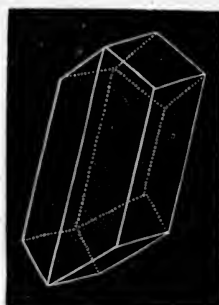

Fig. 167.

can easily be distinguished, because they modify only one half of the similar edges or solid angles of the form. Fig. 165 represents a compound form, in which ordinary tartaric acid frequently crystallizes. It is a combination of an oblique rhombic prism i with the terminal planes ii and the two hemi-prisms $+i$ and $-i$. On these crystals there are four solid angles, e , which are evidently similar, and we should therefore expect that they would in any case be similarly modified. But on the crystal of the variety of tartaric acid which rotates the plane of polarization of light to the right, we find only the two front planes, as on Fig. 166; and on the crystals of the variety of tartaric acid which rotate the plane of polarization of light to the left, only two back planes, as on Fig. 167. These two forms are evidently related to each other in the same way as the two forms of Figs.

149, 150, and cannot be made to coincide by any change of position.

Such hemihedral modifications occur chiefly on crystals of substances which have the power of rotating the plane of polarization of light. Common cane-sugar has this property, and on its crystals we find the two back planes of the klinodiagonal prism, without the corresponding front planes. Fig. 168 represents the common form of the crystals of this substance. They have all

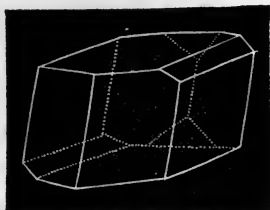

Fig. 168.

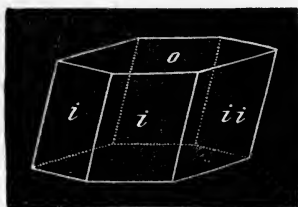

Fig. 169.

the planes of Fig. 169, with the addition of the planes of the positive hemi-prism $+$ ($\infty a : b : c$), and the two back planes of the klinodiagonal prism $a : b : \infty c$.

TRICLINIC SYSTEM.

In the triclinic system, a simple form consists of only two opposite parallel planes. These planes may have any position towards the three axes, and these axes may have any inclination towards each other, and any relative lengths. In all crystals of the same substance, however, the axes have always the same relative length, and are inclined to each other at the same angles. Moreover, of the possible positions in which the two parallel planes of a simple form may be placed towards the axes, only a very few are ever observed; the most frequently seen are those in which the planes are parallel either to one or to two of the axes.

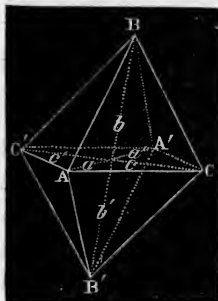

Fig. 170

Fig. 170 represents an octahedron belonging to this system, and formed by uniting the ends of the axes by planes. It is com-

posed of four simple forms : first, the form consisting of the plane ABC and its opposite, which has the symbol $a : b : c$, or $a' : b' : c'$; secondly, the form consisting of the plane $AB'C'$ and its opposite, which has the symbol $a : b : c'$, or $a' : b' : c$; thirdly, the form consisting of the plane $A'B'C$ and its opposite, which has the symbol $a : b' : c$, or $a' : b : c'$; fourthly, the form consisting of the plane $AB'C'$ and its opposite,

which has the symbol $a : b' : c'$, or $a' : b : c$. Fig. 171 represents an oblique prism belonging to this system, in which the axes have the same position as in Fig. 170. It is composed of three forms : first, the form consisting of the plane $ABCD$ and its opposite,

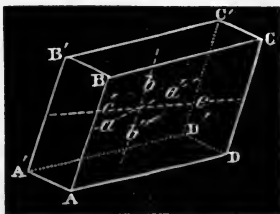

Fig. 171.

which has the symbol $a : \infty b : c$, or $a' : \infty b' : c'$; secondly, the form consisting of the plane $AA'B'B'$ and its opposite, which has the symbol $a : \infty b : c'$, or $a' : \infty b' : c$; thirdly, the form consisting of the plane $BB'C'C'$ and its opposite, which has the symbol $\infty a : b : \infty c$, or $\infty a' : b' : \infty c'$.

Since, however, the relative lengths and inclinations of the axes in this system may have any possible values, it is evident that we may suppose the axes of this oblique prism to unite the centres of opposite planes, as in Fig. 172, or in fact to have any other position whatsoever.

Indeed, the position of the axes in the crystals of any given substance is in a great measure arbitrary, and we assign such a position in every case as will render the symbols of the observed forms of the substance as simple as possible. Fig. 173 represents a crystal of sulphate of copper, and the symbols below the figure indicate the position of each pair of parallel faces towards the three lines which have been assumed as the axes of the crystals of this substance. The relative lengths of these axes are $a : b : c = 1 : 0.974 : 1.768$ and the

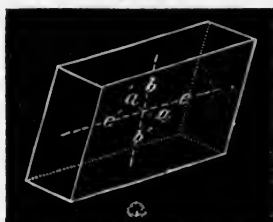

Fig. 172.

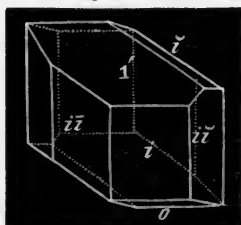

Fig. 173.

- $i \bar{i} = a : \infty b : \infty c.$
- $i \bar{i} = \infty a : \infty b : c.$
- $i = a : \infty b : c.$
- $l = a : b : c.$
- $o = \infty a : b : \infty c.$

angles of inclination are $\alpha = 82^\circ 21'$, $\beta = 77^\circ 37'$, $\gamma = 73^\circ 10'$.

(93.) *Irregularities of Crystals.* — The crystalline forms, which we have studied in the last section, have been perfect and regular. Not only the similar angles have been equal, but also the similar faces and the other similar dimensions of the crystals have been in like manner equal. Such, however, is very seldom the case with the crystals which we find in nature or form in our laboratories; indeed, this perfection and equality are so uncommon, that the figures which we have studied can hardly be considered other than as ideal. Crystals are very generally distorted, and often their forms are so much disguised, that an intimate familiarity with the possible irregularities is required in order to unravel their complexities.

Crystals are rarely terminated on all sides, one or more of the faces being obliterated where the crystal is implanted on the rock, or where it is merged in other crystals. Frequently, also, some of the faces have been disproportionately developed, and so much so as to change entirely the general aspect of the crystal; but in all such cases the relative directions of the faces remain constant, and we can always easily construct the ideal form which corresponds to the imperfect crystal, by projecting it on paper, and placing all the similar faces at equal distances from the centre of the crystal, taking care to preserve their relative direction.

A few examples will give an idea of the nature and extent of these irregularities.

The common form of alum is the octahedron of the monometric system, and we sometimes find perfect octahedrons among the minute crystals which have been formed freely in the midst of a solution of the salt; as, for example, at the end of a thread suspended in the liquid. The crystals which form against the sides of a vessel are always more or less united with each other, so that only a few of their faces, and sometimes only portions of these faces, are free. Fig. 175

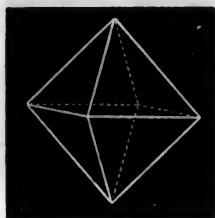

Fig 174.

represents a group of alum crystals, such as is found in the large vats in which the salt is crystallized, and will give an

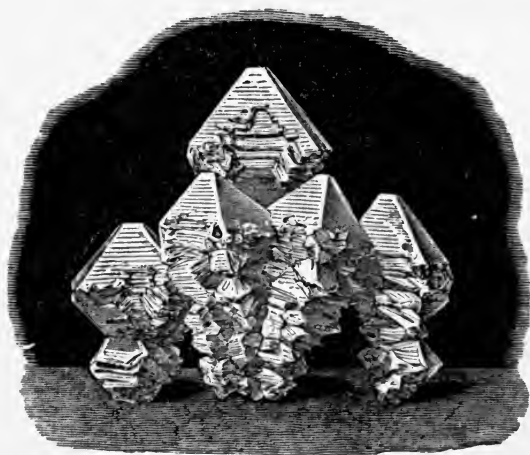

Fig. 175.

idea of the mode in which the individual crystals are grouped together.

If a small and perfect crystal of alum is placed on the bottom of a vessel filled with a saturated solution of this substance, the crystal will gradually enlarge, and in a regular manner, on all sides except on that on which it rests. Fig. 176 represents a crystal which has been thus formed; the shaded face, $m n p q r s$, being the one which rested on the bottom of the vessel. And it will be noticed that the form is precisely the same as would be obtained by removing from the regular octahedron a slice parallel to one of its faces.

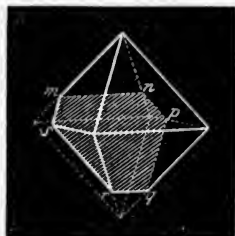

Fig. 176.

Frequently the growth of the crystal, under such circumstances, is much greater in a horizontal direction than it is in the direction perpendicular to the face on which it rests; and the crystal then presents an appearance similar to Fig. 177, in which the two faces which were horizontal in the solution have the same form.



Fig. 177.

We sometimes meet with octahedrons belonging to the monometric system, which have the form of Fig. 178. Four of the

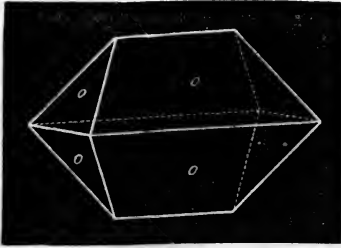

Fig. 178.

faces of this octahedron have been abnormally developed, and so much so that we might even mistake the system to which the crystal belongs; but on measuring the interfacial angles, we should find that they were all equal to $109^{\circ} 28'$, which is the angle of the octahedron.

Fig. 179 represents a compound form, already described, consisting of an octahedron and a cube, a form in which the sulphide of lead, *galena*, frequently crystallizes. We sometimes,

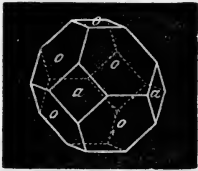

Fig. 179.

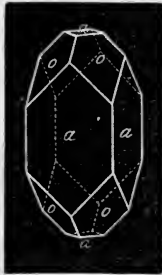

Fig. 180.

also, find crystals of this mineral, having the form represented in Fig. 180, which we might mistake for a form of the dimetric system. It is, however, the same form as that of Fig. 179, only abnormally developed in the direction of one of the axes, as could easily be proved by measuring the interfacial angle

between any two faces, *o*, which would be found in every case to be $109^{\circ} 28'$.

The common form of quartz is a hexagonal prism, terminated by a hexagonal pyramid. The interfacial angle between any two consecutive prismatic faces is 120° ; that between any two consecutive pyramidal faces, $133^{\circ} 40'$. Fig. 181 represents a perfect

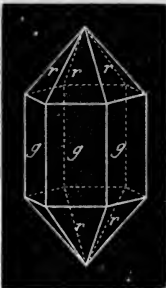

Fig. 181.

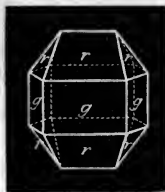

Fig. 182.

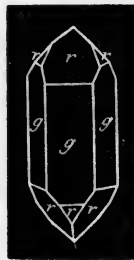

Fig. 183.

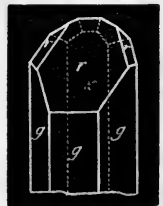

Fig. 184.

crystal of this form ; but it is very rarely that we find crystals so perfect, unless they are very minute. One or more of the faces are usually abnormally developed, and forms like those represented by Figs. 182, 183, 184 are the results. Here, as in the other case, it would be found, on measuring the interfacial angles, that they are the same as those between the faces of the regular form.

In the oblique system, the irregular development of faces produces even greater changes in the general aspect of the crystal than those which have been noticed. Figs. 185 and 186 represent two crystals of felspar belonging to the monoclinic system, which have exactly the same faces, but very differently developed.

Most of the difficulties in the study of crystals arise from similar distortions to those which have been described, and it requires practice to be able to unravel the complexities which they present.

This practice is best acquired by studying actual specimens whose form is known, and comparing them with the perfect models of the same forms.

(94.) *Groups of Crystals.* — We frequently find two or more crystals united in such a way as to produce a symmetrical combination. These collections of crystals, when consisting of only two individuals, are called *twin crystals*. They have regular faces, and the same perfection of outline and angles as simple crystals, for which they might sometimes be mistaken by unpractised observers. There is, however, a simple criterion by which they can be generally distinguished. Simple crystals never have re-entering angles ; so that, whenever such angles occur, there must be present on the specimen two or more individual crystals.

Fig. 187 represents a twin crystal, consisting of portions of two octahedrons united at the plane $m n p q$, which is parallel to an octahedral face. It may be formed from the regular octahedron (Fig. 188), by cutting it into two equal parts by the

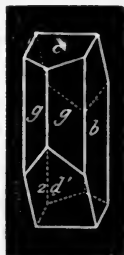

Fig. 185.

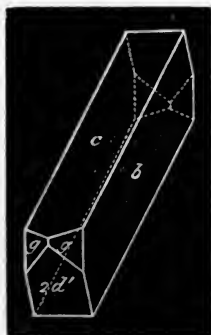

Fig. 186.

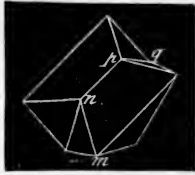

Fig. 187.

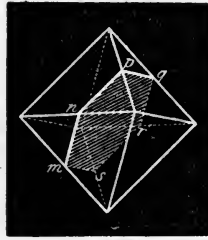

Fig. 188.

plane $m n p q r s$, and then revolving one half on the axis uniting the centres of the two octahedral faces through an angle of 60° or 180° , and then uniting the two halves again by the surfaces at which they were separated.

Fig. 189 represents a common form of the crystals of gypsum (sulphate of lime). It consists, as the re-entering angle shows, of parts of two crystals, and may be formed by cutting a complete crystal (Fig. 190) into two equal parts by the plane $p q r m n o$, and revolving one half of the crystal through an angle of 185° , on an axis at right angles to the plane of section, and then again uniting the two halves. Twin crystals like these are called *hemitropes*. We may suppose that such crystals were formed from two nuclei, which became originally united, one being in an inverted position as regards the other, and that one grew only in one direction, and the other in the opposite direction.



Fig. 189.

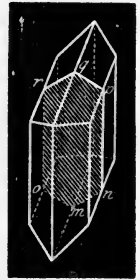

Fig. 190.

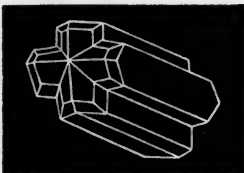

Fig. 191.

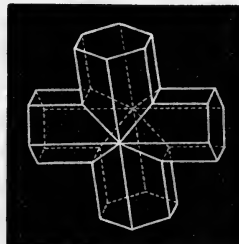

Fig. 192.

In the trimetric system, cruciform crystals, like those represented in Figs. 191, 192, are very common. The crystals represented in the figures consist, in each case, of four

simple crystals. For a fuller development of this subject, we refer the student to Dana's "System of Mineralogy," Vol. I. p. 127.

(95.) *Determination of Crystals.*—In order to determine a

crystal, it is essential to ascertain two points: first, the crystalline system to which it belongs, and, if not of the monometric system, the relative lengths and inclinations of the axes; secondly, the simple forms of which it consists.

When the crystal has been regularly formed, a simple inspection is generally sufficient to determine the crystalline system to which it belongs; but when, as is most generally the case, the crystal is more or less distorted by the enlargement of a portion of the planes at the expense of others, the determination of the crystalline system is frequently very difficult. In studying out the crystalline system in such cases, it is, first of all, important to distinguish the different sets of similar planes, each of which constitutes a simple form. The following indications give important aid in this respect.

1. Similar planes are alike in lustre, hardness, striæ, whatever may be the variations in size. For example, if a cubical crystal has like striæ on all its six faces, these faces are all similar, and the form belongs to the monometric system.

2. Most crystals may be split (*cleaved*) with more or less readiness parallel to certain of their faces. This property, which will be considered in a future section, frequently enables us to distinguish similar planes when the crystallization is very imperfect; for we find that cleavage is obtained with equal ease or difficulty parallel to similar faces, and with unequal ease or difficulty parallel to dissimilar faces; and again, that cleavage parallel to similar planes affords planes of similar lustre and appearance, and the converse.

3. Planes equally inclined to the same plane are similar, and planes equally inclined to similar planes are similar.

Having, by means of these indications, studied out the similar planes of the crystal, the student will very probably be able to recognize the crystalline system at once; but if not, he will generally find an unerring guide to the system of crystallization in the modifications of the crystal. The law which governs these modifications has already been stated (91), and the mode of applying it is evident. If, for example, we find a cubical crystal whose basal edges are differently modified from the lateral edges, we know that these edges are not similar, and hence that the crystal does not belong to the monometric system. If the basal edges are all modified alike, the crystal belongs to the dimetric

system; but if only the opposite basal edges are modified alike, it belongs to the trimetric system. The following table, for which I am indebted to Professor Dana,* will aid the student in the examination of crystals.

<p>1. All edges modified alike. 2. Angles truncated or replaced by 3 or 6 similar planes.</p>	<p>} MONOMETRIC System.</p>	<p>Number of similar planes at extremities of crystal 3 or some multiple of 3.</p>	<p>} HEXAGONAL System.</p>
<p>1. All edges not modified alike. 2. Two† or none of the angles trunc. or repl. by 3 or 6 similar planes.</p>	<p>} Number of similar planes at extremities of crystal neither 3 nor a multiple of 3.</p>	<p>The superior basal modifications in front not similar to the corresponding inferior in front or superior behind.</p>	<p>Two adjacent or two approximate sim. pl. impossible. } TRICLINIC System. Two adjacent or two approximate sim. pl. possible. } MONOCLINIC System.</p> <p>N. B. The right rhomboidal prism on its rhomboidal base may be distinguished from the other right prism by the dissimilar modifications of its lateral and basal edges and angles.</p>
		<p>The superior basal modifications in front similar to the corresponding inferior in front or superior behind.</p>	<p>1. Similar planes at each base either 4 or 8 in number. (if modified) simil. trunc. or bevelled. ‡ } DIMETRIC System. 1. Similar planes at each base either 2 or 4 in number. 2. All lat. edges (if modified) not simil. truncated or bevelled. ‡ } TRIMETRIC System.</p>

The study of the modifications of crystals may sometimes correct deductions from measurements. The interfacial angles of crystals are liable to slight variations, not generally exceeding a few minutes, but in extraordinary cases amounting to one or two degrees. For example, cubes of common salt have been observed with angles of 92° or 93° , and might be mistaken for rhombohedrons, were it not that the distribution of modifying planes indicated the perfect similarity of the edges and angles.

Having determined the system of crystallization, it is next important, if the system is not the monometric, to determine the

* Dana's System of Mineralogy, Vol. I. p. 123.

† The rhombohedron is the only solid included in this division, any of whose angles admit of a truncation or replacement by three or six planes.

‡ The terminal edges of the octahedrons are here termed lateral, in order that these statements may be generally applicable both to prisms and octahedrons.

relative lengths and inclinations of the axes. There is obviously a direct relation between these values and the interfacial angles, and this relation can be expressed mathematically, so that the one can be calculated from the other. It is the especial object of works on the subject of Mathematical Crystallography to explain these relations, and to develop the formulæ by which the calculations can be made.

The last point in the determination of a crystal is to ascertain the simple forms of which it is composed, so as to give the symbol, that is, the parameters of each set of similar planes. In many cases, the forms may be discovered by inspection; but in other cases the exact parameters of any one form can only be ascertained by calculation from the value of the interfacial angles, or from the parameters of other forms already known. The method of making these calculations is also explained in the works on Mathematical Crystallography.

(96.) *Use of Goniometers.* — It is evident, from the last section, that the interfacial angles are the most important elements in the *determination of crystals*. These angles are measured by means of instruments called *Goniometers*. The simplest of these instruments, called the *Common or Application Goniometer*, is represented by Fig. 193. It

consists of a semicircular arc, graduated to half-degrees, and of two arms, arranged as represented in the figure. The first of these arms, *ab*, is fixed at the zero division; but the second, *df*, turns on *c*, the centre of the arc, as an axis, and

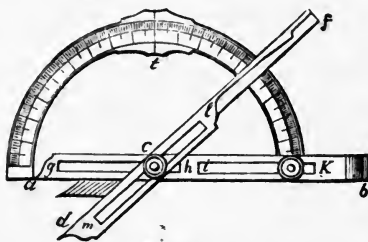

Fig. 193.

indicates on the limb the angle of the crystal. In using the instrument, the faces whose inclination is to be measured are applied between the arms, which are opened until they just admit the angle, taking care that the edge made by the two faces is perpendicular to the plane of the instrument. It is easy to determine when the arms are closely applied to the faces of the crystal, by holding the instrument between the eye and the light, and observing that no light passes between the arms and the faces of the crystal. The two arms, *ab* and *df*, slide in the slits *ik*,

$g h, l m$, and can be shortened at pleasure, a provision which is frequently important in the case of small crystals. Moreover, for measuring crystals partially imbedded, the arc is jointed at t , so that the part $a t$ may be folded back on the other quadrant. Sometimes the arms admit of being separated from the arc, an arrangement which is more convenient than the one represented in the figure.

When a regular goniometer is not at hand, approximate results may be obtained by means of an extemporaneous pair of arms made of thin sheet-metal, mica, or even of card. The arms are first applied to the faces of the crystal, as already described; then, carefully retained in their relative position, they are placed on a sheet of paper, and the angle is laid off by drawing lines with a pencil and ruler parallel with, or in the direction of, each of the arms. This angle may then be measured by means of a common protractor, or a scale of cords.

The common goniometer is at best a rough instrument; for, even when delicately used, it seldom furnishes results within a quarter of a degree of the truth.* For polished crystals we have a much superior instrument, called the *Reflective Goniometer*. There are several varieties of this instrument, but we shall only describe the one which is most generally used. This was originally devised by Wollaston, and is called by his name.

The principle of all reflective goniometers is illustrated by Fig. 194. Let $a b c$ be the section of a crystal made by a plane

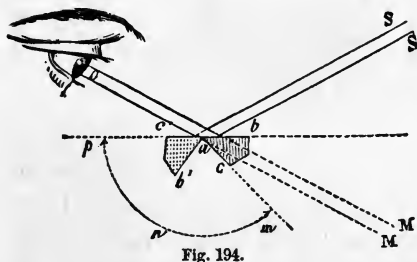

Fig. 194.

perpendicular to the edge formed by the intersection of the two faces whose angle we wish to measure, and $a b, a c$, the sections of the two faces. The angle required is evidently the same as the plane angle $b a c$. Let $S S$ and $M M$ be two objects at some distance from the crystal, which may be used as signals. The eye of an observer at O , looking at the face of the

* A more accurate form of the Application Goniometer, devised by Adelmann, is described in Dufrenoy's "Traité de Mineralogie," Vol. I. This instrument may also be used as a Reflective Goniometer.

crystal, sees a reflected image of the upper signal in the direction OM , and coinciding with the lower signal, seen by direct vision. If, now, the crystal is revolved on the edge whose projection is the point a , until it assumes the position $a' b' c'$, it is evident that the reflected image of the upper signal will again be seen in coincidence with the lower signal. But in order to bring the crystal to the second position, it is obviously necessary to revolve the face ac through the arc $m n p$, which is the supplement of the required angle. If, then, we can measure the angle through which the crystal must be turned in order to reproduce the coincidence, we can easily calculate the angle of the crystal. This object is readily accomplished by the goniometer of Wollaston.

The instrument consists of a vertical brass circle, $L L'$, Fig. 195, about twelve centimetres in diameter, whose axis is mounted

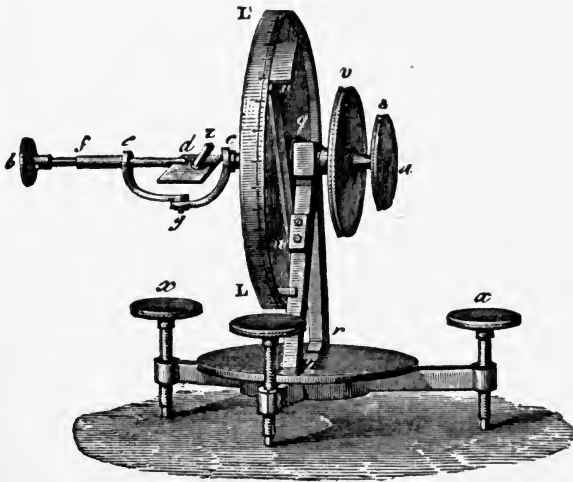

Fig. 195.

on a firm support, $p q r$. The circle is graduated on its rim to half-degrees, and may be revolved by means of the milled head v , which is fastened to one end of the axis. A vernier,* u , permanently attached to the support at w , indicates the angle through which the circle is revolved, and also subdivides the half-degrees into minutes. The axis on which the circle revolves is hollow,

* The vernier will be described in the chapter on Weighing and Measuring.

and through it passes, with slight friction, an interior axis, $a c$. At one end of this interior axis is fastened the milled head s , by means of which it may be revolved, and at the other end the contrivances for supporting and adjusting the crystal, z , which is fastened with wax to a thin metallic plate, $d c$. From this construction it is evident that, if we turn the milled head v , the circle and crystal will both revolve; but if we turn the milled head s , the crystal may be revolved independently of the circle. Any distinct horizontal line, such as the bar of a window, may be used for the upper signal; and for the lower signal, a black line drawn on white paper, placed several feet below, and adjusted parallel to the first.

In use, the instrument is placed on a table about ten or twelve feet in front of the signals, and adjusted by means of the leveling-screws, until its axis is perfectly horizontal and parallel with the lines forming the signals. The crystal, which has been previously attached to the movable plate $d c$, is next adjusted, so that the edge of the interfacial angle to be measured shall exactly coincide with the axis of the instrument produced. This is the most difficult adjustment, and requires some skill. The crystal should first be brought into place as nearly as possible by the eye, either by shifting its position on the plate $d c$, or by changing the position of the plate by means of the axis $b d$ and the joint g . When apparently adjusted, the eye should be brought as near the crystal as possible, and directed towards the lower signal. The milled head s should next be turned until the image of the upper signal is seen reflected from one of the faces, which includes the angle to be measured. If the crystal is perfectly adjusted, the image will appear horizontal, and may be brought into perfect coincidence with the lower signal, seen by direct vision. If there is not a perfect coincidence, the adjustment must be altered until it is obtained. The milled head is next revolved until the reflection of the upper signal is seen in the second face, and if this image also coincides with the lower signal, seen in direct view, the adjustment is complete; if not, the adjustment must be made perfect, by altering the position of the plate $d c$, and the first face again tried. A few successive trials of the two faces will enable the observer to obtain a perfect adjustment. When the two images are perfectly horizontal, the edge formed by the intersection of the two faces must be parallel to the axis of the

circle, but it will not necessarily coincide with it. A slight variation from exact centring in the position of the edge is not, however, of importance, when the goniometer is placed ten or twelve feet distant from the signals, so that this adjustment may be made sufficiently near by the eye. The method of adjustment which has been described depends on the laws of reflection, which will be explained in the chapter on Light.*

The crystal thus adjusted, the angle is very easily measured. The zero division of the limb is first made to coincide with the zero division of the vernier. The eye is then brought as near to the crystal as possible, and directed towards the lower signal. The crystal is then revolved by the milled head *s* until the image of the upper signal, reflected from one of the faces enclosing the required angle, coincides with the lower signal seen by direct vision. This coincidence obtained, the circle and crystal are turned together by means of the milled head *v*, taking care to keep the eye in exactly the same position until the same coincidence is observed with the second face. The angle through which the circle has been turned may now be read off by means of the vernier; and this, as we have seen, is the supplement of the angle of the crystal. When the faces of a crystal are highly polished, we can determine its angles by means of the Wollaston goniometer within a few minutes.† Unfortunately, however, the faces of most crystals are not sufficiently polished to give, under ordinary circumstances, a distinct image of the signal. In many such cases, good results can be obtained by making the measurements in a partially darkened room, and using as the upper signal a narrow slit in the screen covering one of the windows, and as the lower signal, a horizontal black line drawn on the casement below. The slit is best made by covering a rectangular aperture in the screen with a parallel ruler, which

* Another method of adjusting the goniometer and the crystal is described by Professor W. H. Miller, of Cambridge, England, in his work on Crystallography, and also in the last edition of Phillips's Mineralogy, London, 1852. This method is preferable to the one described in the text in most cases, and especially when the crystals are minute or the lustre of the faces dim.

† For the methods of rectifying the instrument and of determining the probable errors of measurement, the student may consult Naumann, *Lehrbuch der reinen und angewandten Krystallographie*, Leipzig, 1830, Band II.; Neumann, *Das Krystalssystem des Albites (Abhandlungen der königlichen Akademie der Wissenschaften in Berlin, vom Jahre 1830)*.

may be opened more or less, as circumstances require. When the faces are very dull, the slit may be illuminated by means of a heliostat. In such cases, when we can see no image, we can sometimes get an impression of light imperfectly reflected from the faces of the crystal, and this enables us to measure the angle within ten or twelve minutes. We can sometimes render the faces of crystals reflecting, by fastening on them very thin pieces of mica by means of some interposed liquid, such as water or oil of turpentine.

The Wollaston goniometer has been modified by Rudberg* and Mitscherlich,† and the instrument, as thus improved, is constructed by Oertling, of Berlin. The modifications consist chiefly, — First, in an improved apparatus for centring and adjusting the crystal. Secondly, in substituting for the distant signals cross-wires at the focus of the eye-piece of a telescope which is firmly attached to the stand of the instrument. The object-glass, which is directed towards the crystal, is so adjusted that the rays of light emanating from a lamp placed before the eye-piece and illuminating the cross-wires are rendered parallel before they strike upon the face of the crystal, and thus produce the same effect as if they emanated from a signal ten or twelve feet distant. Thirdly, in directing the eye by means of a second telescope, furnished with cross-wires, whose optical axis is in the same plane as that of the first telescope, and is parallel to the plane of the graduated circle. In using this instrument, the crystal is first carefully adjusted, and then turned until the reflected image of the cross-wires of the first telescope is seen to coincide with those of the second, seen by direct vision. The whole circle is then turned until the same coincidence is obtained with the image reflected from the second face. The angle is then read off on the graduated limb, which, in the large goniometer constructed by Oertling, is divided into sixths of a degree, and each of these divisions subdivided by a vernier into sixths of a minute. This goniometer gives very accurate measurements; but on account of the loss of light produced by the lenses, it can only be used with crystals whose faces are highly polished. In-

* Vorschlag zu einem verbesserten Reflexionsgoniometer (Annalen der Phys. und Chem. von Poggendorf, IX. s. 517).

† Abh. der kön. Akad. der Wiss., Berlin, 1825, 1839. Also Dufrénoy, *Traité de Mineralogie*, Vol. I.

deed, it is seldom that such nicety is required, since the angles of crystals are liable to accidental variations amounting to several minutes, and the ordinary Wollaston goniometer will in most cases measure the angles as accurately as they are formed by nature.

For descriptions of the various forms of reflective and other goniometers, which have been proposed by Babinet,* Haidinger,† and others,‡ the student is referred to the original memoirs.

(97.) *Identity of Crystalline Form.* — It was stated in (79), that, *with certain limitations*, the crystalline form is always the same for the *same substance*, and we are now prepared to understand what the limitations are. It is not true, in the ordinary acceptation of the word, that the same substance always crystallizes in the *same form*; but the same substance, with the exceptions hereafter to be noticed, always crystallizes in the *same system*. Common salt, for example, usually crystallizes in cubes; but when it is crystallized from a solution containing urea, it takes the form of the regular octahedron, or else a compound form, on which the cube and octahedron are united. Both of these forms belong to the Monometric System. So also, M. le Comte de Bournon, in a monograph of two volumes, has described eight hundred different forms of the mineral calcite; but all of these belong to the Hexagonal System. When a substance crystallizes in the Monometric System, the relative lengths of the axes of the different forms must necessarily be the same; but in the other systems, the relative lengths of the axes of the different forms of the same substance may be different. We have seen, however, that these lengths always bear to each other a very simple numerical ratio (compare pages 143, 147, 159, and 164), and that in the oblique systems the axes of the different forms of the same substance have always the same relative inclinations (compare pages 164 and 168). It follows, therefore, that when we say that a substance always crystallizes in the same form, we only mean that it crystallizes in forms belonging to the same system. The number of *possible* forms in which a given substance may crystallize (although it is restricted to forms of one system) is,

* Dufrénoy, *Traité de Mineralogie*, Vol. I.

† Sitzungsberichte der mathem.-naturw. Classe der kais. Akademie der Wissenschaften zu Wien. Novemberhefte des Jahrganges 1855.

‡ Suckow, Vorschlag zu einem Goniometer (*Journal für praktische Chemie von Erdmann*, Band II.). *Gilbert's Annalen der Physik*, Jahrgang 1820. Also Kolinati, *Elemente der Krystallographie*, Brunn, 1855.

of course, infinite; but the number of *actual* forms in which it is observed to crystallize is generally very limited, — seldom exceeding two or three. Under *similar circumstances*, a given substance almost invariably takes the *same form*; so that this form is one of the most characteristic properties by which a substance may be recognized. Moreover, we also find that in any given system the possible forms of a substance are limited to either holohedral or hemihedral forms. For example, we always find iron pyrites crystallized in the parallel hemihedral forms of the Monometric System, and gray copper in the oblique hemihedral forms of the same system.

(98.) *Dimorphism and Polymorphism.* — There are several substances, which, under widely different conditions, may be made to crystallize in the forms of two systems, and a few which may be made to crystallize in those of three systems. Such substances are said to be *dimorphous* or *polymorphous*. Sulphur, for example, at the ordinary temperature of the air, crystallizes in the forms of the Trimetric System; but at the temperature of 113° C. it crystallizes in the forms of the Monoclinic System. Carbon, also, is found in nature as diamond, whose crystals belong to the Monometric System, and as graphite, whose crystals belong to the Hexagonal System. Again, carbonate of lime occurs in forms of the Hexagonal System, when it is called *calcite*; and in forms of the Trimetric System, when it is called *arragonite*. Lastly, titanate of lime crystallizes in the forms of the Dimetric System, in which $a : b = 1 : 0.6442$ (*rutile*); in forms of the same system, in which $a : b = 1 : 1.7723$ (*antase*); and also in forms of the Trimetric System (*brookite*).

When, however, a substance crystallizes in the forms of different systems, we find that in the several states its other properties differ as widely as the forms; and so much so, that it may be questioned whether they can properly be regarded as the same substances. No two substances could differ more widely than the two states of carbon (diamond and graphite); and similar differences, although not quite so striking, exist between the different states of other substances. It becomes, then, a question of considerable interest, whether these states can properly be regarded as the same substance. But this discussion must be reserved for another portion of this work.

Elasticity.

(99.) *Elasticity of Solids.* — Having considered the effect of cohesion in retaining the molecules of solids in a determinate position with reference to each other (79), we come next to consider the effect of this molecular force in determining phenomena of elasticity. It has been stated (77), that the phenomena of elasticity could be developed in all matter by *compression*, and that in solid matter they could also be developed by *tension*, by *flexure*, and by *torsion*. The laws of elasticity in solid bodies may, for the most part, be developed both by mathematical analysis and by experiment; but we shall be obliged to confine ourselves, in this work, to a simple enunciation of them, referring the student to the works on Physics which have been previously cited, for a full development of the subject.

(100.) *Elasticity of Tension.* — In experimenting on the elasticity developed in solids by tension, we suspend the rod or wire by its upper extremity to a firm support, and attach to its lower extremity a pan to receive weight (Fig. 196). The elongation caused by the addition of weight to the pan can then be measured by means of a cathetometer.* If the elongation does not exceed a certain amount for any given rod, and the experiment is not continued too long, the rod will resume its original length when the weight is removed. If, however, the elongation exceeds the *limit of elasticity*, or if the strain is continued beyond a limited time, a permanent change of length and bulk will ensue. When the limits of elasticity are

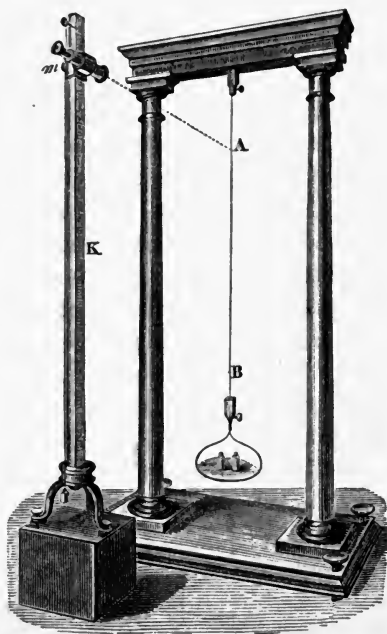

Fig. 196.

* This instrument will be described in the chapter on Weighing and Measuring.

not exceeded, it will be found that the following laws will hold true in all experiments of this kind.

1. *The elongation caused by an increase of tension is the same for the same substance, whatever may have been the original tension.* For example, if we are experimenting on a rod of iron, we shall find that the elongation caused by the addition of one kilogramme to the pan is the same, whether the pan was before empty, or was loaded with fifty kilogrammes or any other amount of weight.

2. *The elongation is proportional to the increase of tension.* If the rod is elongated one millimetre by one kilogramme, it will be elongated ten millimetres by ten kilogrammes, and so on.

3. *The elongation is proportional to the length of the rod.* A rod of the same substance, of the same size, but twice as long as another, will be elongated twice as much by the same increase of weight.

4. *The elongation is inversely proportional to the area of the section made at right angles to the length of the rod.* If, for example, two rods of the same substance have the same length, and if the area of the section of the first is twice as great as that of the second, it will only be elongated one half as much by the same strain.

(101.) *Coefficient of Elasticity.* — It follows from these laws, that the elongation of a given rod, which we will represent by l , is proportional, first, to a constant quantity, C , depending on the nature of its substance; secondly, to the weight, \mathfrak{w} , by which it is stretched; thirdly, to its length, L ; and, fourthly, is inversely proportional to the area of the section, S . This, expressed in mathematical language, is

$$l = C \cdot \mathfrak{w} \cdot L \cdot \frac{1}{S};$$

hence,

$$l = C \frac{\mathfrak{w} L}{S}, \quad \text{or} \quad C = \frac{l S}{L \mathfrak{w}}.$$

If in these equations we put $K = \frac{1}{C}$, they will become,

$$l = \frac{1}{K} \frac{\mathfrak{w} L}{S}, \quad \text{or} \quad K = \frac{L \mathfrak{w}}{l S}. \quad [66.]$$

This quantity, K , is called the coefficient of elasticity. If in the last equation we put $l = L$, that is, if we suppose the elongation

to be equal to the original length, and also make $S = 1 \text{ m.m.}^2$, the equation becomes $K = W$; which shows that the coefficient of elasticity of any homogeneous substance is equal to the absolute weight required to double the length of a bar of that substance, whose section is equal to one square millimetre, supposing such an increase of length were possible, which is not the case except with threads of India-rubber. The following table gives the coefficients of elasticity of a number of metals, as determined by M. Wertheim.

Coefficients of Elasticity of Annealed Metals at different Temperatures.

	15° to 20°.	100°.	200°.
Lead,	1,727	1,630	. . .
Gold,	5,584	5,408	5,482
Silver,	7,140	7,274	6,374
Copper,	10,519	9,827	7,862
Platinum,	15,518	14,178	12,964
Iron,	20,794	21,877	17,700
Cast-Steel,	19,561	19,014	17,926
English Steel,	17,278	21,292	19,278

It appears from this table, that, as a general rule, the coefficients diminish as the temperature rises from 15° to 200°.

M. Wertheim has also made experiments on metals which have been submitted to various mechanical agencies, and has found that *all circumstances which increase the density increase also the coefficient of elasticity, and the reverse.*

The coefficient of an alloy is sensibly the mean of the coefficients of the metals which enter into its composition, even when a change of volume accompanies the formation of the alloy. A current of electricity diminishes momentarily the elasticity, independently of the diminution caused by the elevation of temperature which it produces.

(102.) *Elasticity of Compression.* — If a bar is compressed in the direction of its length by a force acting at the extremities, it is found that the amount by which it is shortened is exactly equal to the amount by which it would be lengthened, were the force applied so as to stretch it. It follows, from this equality in the effects produced, that the laws of elasticity developed by compression are the same as the laws of the elasticity of tension.

(103.) *Elasticity of Flexure.* — The simplest case of elasticity developed by flexure is illustrated by Fig. 197. It repre-



Fig. 197.

sents a rectangular bar, AB , fastened at one of its extremities in a horizontal position. If, now, we press upon the free extremity of the bar at B , so as to curve it a little, the bar will tend to return to its first

position, in consequence of the elasticity developed by the flexure; and if left to itself, will resume the horizontal position after a few oscillations.

The elasticity of flexure is, in great measure, a mixed effect of the elasticity of compression and tension. Since, by the bending of the bar, the particles of the convex surface AB' are drawn apart, while those of the concave surface CD' are forced together, and it is in consequence of the elasticity thus developed that the bar tends to return to its original position. But, moreover, the particles of the bar have changed their position, independently of the change of their relative distances apart, since the particles, which were previously situated on a straight line, are now on a curved line; and we know that such a change of position must be accompanied with a development of elasticity.

Starting from these data, the laws of elasticity of flexure can be deduced by mathematical analysis. They are comprised in the formula,

$$a = \frac{\mathfrak{w} L^3}{K b e^3}, \quad \text{or} \quad \mathfrak{w} = \frac{K a b e^3}{L^3}; \quad [67.]$$

in which L is the length of the bar; \mathfrak{w} , the weight acting perpendicularly, and tending to bend it; b , the breadth of the bar measured perpendicularly to the direction of this force; e , the thickness of the bar; a , the arc described BB' ; and K , a constant quantity depending on its substance. If in [67] we put $L = 1$ m., $b = 1$ c. m., $e = 1$ c. m., $a = 1$ c. m., it becomes $\mathfrak{w} = K$. The number K is called the coefficient of the elasticity of flexure, and it is evidently equal to the weight which will bend a bar of a given substance one metre long and one centimetre square through an arc of one centimetre. When the values of a , b , e , and L have been determined by experiment in the case of any substance, the value of K for this substance can easily be calculated.

Equation [67] shows that the flexure of the bar, or a , is proportional to the force W . It follows from this, that, as the rod is bent, it tends to restore itself to the position of equilibrium with a force which increases with the distance of each of its points from their position of equilibrium. Now it can be proved that, when this condition exists, the oscillations which the bar makes in returning to the position of equilibrium will be isochronous, whatever may be their amplitude. Hence reciprocally it will follow, that, if the oscillations of such a bar are isochronous, the condition under consideration must exist. It is easy to verify the isochronism of the oscillations experimentally, because, being very rapid, they produce a sound whose pitch depends on the number of oscillations in a second, and hence in any case would vary, if the isochronism were not preserved. Now it is well known that this pitch is constant for a given bar, whatever may be the amplitude of the oscillations; and thus this is at once a consequence and a proof of the law, that the flexure is proportional to the force.

It has been assumed in this discussion, that the section of the bar is a rectangle, and that the force is applied in a direction perpendicular to one of its sides. When these conditions are not fulfilled, the formulæ [67] no longer hold true. It has been also assumed that the bar returns exactly to its first position when it is freed, or, in other words, that the flexure does not exceed the limit of elasticity.

(104.) *Applications.* — Almost all springs — for example, watch-springs and carriage-springs — are applications of the elasticity of flexure. The bow is another example. The elasticity of a hair cushion is due to the elasticity of flexure developed in the single hairs. The spring balance, Fig. 198, which has been already described (71), is an application of the law that the flexure is proportional to the weight.

The elasticity of flexure has been applied by Bourdon in the construction of a metallic manometer and barometer, which bear his name. It is a familiar fact, that, if we force air into a flexible tube, closed at one end, which is flattened and coiled up on its flat side, the pressure tends to



Fig. 198.

uncoil it; and, on the other hand, that, if we exhaust the air, the exterior pressure tends to coil it still further. If the tube is also elastic, it is evident that, when the pressure is removed or restored, it will return to its former condition, provided that the limits of elasticity are not passed. These facts are the basis of the two instruments represented in Figs. 199 and 200.

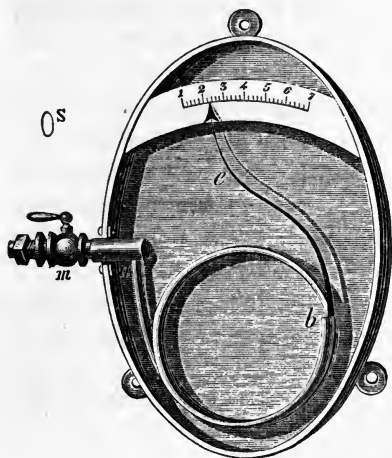

Fig. 199.

figure. A section of this tube is represented at *S*. The end of the tube, *a*, is firmly fastened to the stopcock, *m*, by which it connects with the steam-boiler. To the closed end of the tube, *b*, is attached a hand, *e*, which moves over an index. As the pressure of the steam on the interior surface of the tube increases, it gradually uncoils, and the hand points to the number of atmospheres of pressure. When the pressure is removed, the tube, in virtue of its elasticity, resumes its original position, and the hand points to the first division of the scale.

The *barometer* (Fig. 200) is a more delicate instrument, constructed on the same principle.

The tube is here closed at both ends, and when the pressure of the atmosphere is just equal to the tension of the confined air, it



Fig. 200.

is in the condition of equilibrium. When, however, the pressure of the atmosphere diminishes, there is an excess of pressure on the interior surface of the tube, and it tends to uncoil; on the other hand, when the atmospheric pressure increases, there is an excess of pressure on the exterior surface, and the tube tends to coil still more. As constructed, the air is partially exhausted from the tube, and hence the pressure of the atmosphere always tends to coil it more or less, as compared with the condition of equilibrium. The tube is fastened, at the middle of its length, to the upper part of the instrument, and its free ends are connected, by the metallic threads a, b , with the hand, which serves to multiply the motion, while a small spiral spring, c , causes the needle to follow with accuracy any change of position in the ends of the tube. The arc is graduated to correspond with a mercurial barometer, and denotes the number of centimetres of mercury to which the atmospheric pressure corresponds.

(105.) *Elasticity of Torsion.* — It is a fact of frequent observation, that, when a metallic wire, ab (Fig. 201), fastened at one end, is twisted by a force applied at the other, it strives to return to its original position, and when free returns to this position, after having made a number of oscillations. This of course supposes that the strain has not exceeded the limit of elasticity.

It is easy to see how elasticity is developed in a wire by torsion. Suppose mn , Fig. 201, to be a line of particles parallel to the axis of the wire when in a state of equilibrium. It is evident that, when the wire is twisted, these particles will be distributed on the helix mn' ; but in order to assume this position, the distances between the successive molecules must be increased, which will develop the elasticity of tension. Besides, this elasticity is also developed by the fact that the particles resist any change of position, even when the relative distances are preserved.

The angle α , through which a radius of the lower base of the wire is turned, is termed *the angle of torsion*. The force which,



Fig. 201.

applied at the extremity of a lever equal to the unit of length and perpendicular to the wire, will maintain it in a position which corresponds to a certain angle of torsion, is called *the force of torsion*. And when the angle of torsion is such that the arc described by the extremity of the lever is also equal to unity, the force of torsion is called *the coefficient of torsion*.

The laws of the elasticity of torsion were investigated by Coulomb, and are expressed in the following formulæ:—

$$t = \pi r \sqrt{\frac{W}{2gF}}, \quad [68.]$$

or

$$F = \frac{\pi^2 r^2}{2g} \frac{W}{t^2}; \quad [69.]$$

which apply to the case represented in Fig. 201, of a cylindrical weight suspended by a cylindrical wire to a fixed support, *a*, so that the axis of the cylinder and the wire correspond. In this case, *W* represents the weight of the cylinder; *r*, its radius; *g*, the force of gravity; *F*, the coefficient of torsion of the wire; and *t*, the time of the oscillations which the cylinder makes on its axis, in returning to the state of rest after the wire has been twisted. The laws of torsion discovered by Coulomb are as follows.

1. *The force of torsion is proportional to the angle of torsion.* In order to establish this law, Coulomb made experiments on the oscillations of the weight *W* on its axis caused by the torsion of the wire, using wires of different substances, and loading them with different weights. He found that in each case the times of the oscillations were independent of the amplitudes, or, in other words, that they were isochronous; and it can readily be shown, by the same course of reasoning used in (103), in regard to the elasticity of flexion, that the law is a necessary consequence of this fact.

The isochronism of the oscillations caused by torsion is expressed by [68], since the value of the second member of the equation is independent of the amplitude.

2. *The force of torsion is independent of the tension of the wire.* It has been proved by experiment, that the square of the time of oscillation is proportional to the weight, *W*, or, in other words, that $\frac{W}{t^2}$ is a constant quantity; and hence it follows, that

the value of F [69] is not changed by any variation of the weight.

The coefficient of torsion depends upon the substance of the wire, and also upon its diameter and its length, it being inversely proportional to the length and directly proportional to the fourth power of the diameter of the wire.

(106.) *Applications of the Elasticity of Torsion.* — One of the most beautiful applications of the laws of torsion is the torsion-balance, contrived for measuring the intensity of feeble attractive and repulsive forces. One form of this balance, which is used for measuring the intensity of the attractive or repulsive force between electrified bodies, is represented in Fig. 202. The general structure of the apparatus is evident from the figure, and does not require description. The most essential part of it is a fine silver wire, attached, at its upper end, to the brass circle e , and from the lower end of which is suspended a shellac needle. The circle e is movable, and turns on the cap, which is cemented to the glass tube d . This circle is graduated on the exterior rim into degrees, and the index-mark at a , which is fastened to the cap, indicates the angle through which the circle e has been turned. The glass tube also turns in a brass socket, which is cemented to the glass cover of the apparatus. The repulsive or attractive force between the two electrified balls m and n , is measured by the angle through which it is necessary to twist the wire (by turning the circle e), in order to balance it, the force exerted being always proportional to the angle of torsion. A modification of the torsion-balance was employed by Cavendish, and subsequently by Bayly, in the determination of the density of the earth.

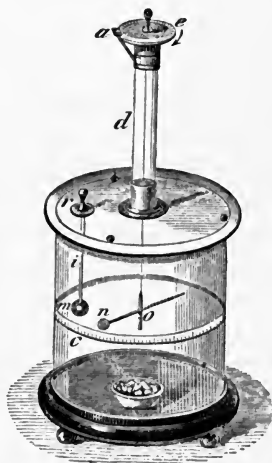

Fig. 202.

(107.) *Limit of Elasticity.* — It has been several times stated in the previous sections, that the laws of elasticity only hold true so long as the strain does not exceed the *limit of elasticity*, and it was stated in section (77), that, within more or less narrow

limits, all solids were perfectly elastic. The phenomena of elasticity may be developed by torsion in those substances which seem the most destitute of this property. Thus, if we take a leaden wire two millimetres in diameter and three metres long, fix one end of it firmly to the ceiling, and fasten an index to the other, it will be found that, if we twist the wire twice round and let it go, it will, after a number of oscillations, come to rest in its original position; showing that the elasticity in this leaden wire is perfect up to the point mentioned. But if we twist the wire four times instead of two, it will not return to its first position, but to a position short of that by nearly two revolutions. The particles of a leaden wire of this length and thickness will bear a displacement measured by two revolutions of the index; but the displacement occasioned by four turns is more than its particles can bear, and they remain permanently displaced, — the wire having taken what is technically called a *set*. So also, a thin cylinder of pipe-clay (which is generally considered as destitute of elasticity as almost any substance can be) shows the existence of elasticity as perfect as can be found in the best-tempered steel; but here again the limit of elasticity is soon reached. A steel wire, similar to the lead one just mentioned, might be twisted a great many times before its particles would receive such a set as to prevent it from completely untwisting again; but after it had been twisted a certain number of times, the limit of its elasticity would be passed, and it would not come to rest again at its first position.

The same phenomena appear in all the cases we have studied. A wire, which, when stretched by a light weight, will resume its original length when the weight is removed, will be permanently lengthened if the weight exceeds a limited amount. So also a steel spring, if bent beyond a certain point, is *forced*, and remains permanently bent to a greater or less extent.

It is a remarkable fact, that even when the limit of elasticity has been exceeded, so that the particles have taken a permanent set, the elasticity of the whole mass remains the same as before. Thus, when a wire has been permanently lengthened by a great strain, it is as perfectly elastic in its new condition as before, readily recovering from the effects of smaller degrees of extension. So also it was found by Coulomb, that, after he had given a *set* to the lead wire already referred to, by twisting it four

times round, the wire was as elastic in its new condition as before, requiring the same force to give it a further twist, and recovering itself as completely when that force was withdrawn.

The limits of elasticity have been determined only in the case of the elasticity of tension. The method of experimenting was to take wires of any length, but whose section was equal to one square millimetre, and to determine the amount of weight required to extend them permanently 0.05 m. m. for each metre of length. This investigation was more difficult than would appear, on account of the fact that the duration of the strain has an important influence on the permanent elongation which results; for, when once commenced, this elongation slowly increases, and although it may not be sensible at the end of a few minutes, yet after several hours it may become very evident. This principle is illustrated by the well-known facts, that the best springs are worn out with long use, that the beams of floors bend little by little, and that buildings settle with time. The limit of elasticity is not, therefore, a value which can be rigorously determined, and hence the numbers in the following table must be regarded as only approximate.

Metals.		Limit of Elasticity.	Tenacity.
		k.	k.
Lead,	{ Drawn,	0.25	2.50
	{ Annealed,	0.20	1.80
Tin,	{ Drawn,	0.40	2.45
	{ Annealed,	0.20	1.70
Gold,	{ Drawn,	13.00	27.00
	{ Annealed,	3.00	10.08
Silver,	{ Drawn,	11.00	29.00
	{ Annealed,	2.50	16.02
Copper,	{ Drawn,	12.00	40.30
	{ Annealed,	3.00	30.54
Platinum,	{ Drawn,	26.00	34.10
	{ Annealed,	14.00	23.50
Iron,	{ Drawn,	32.50	61.10
	{ Annealed,	5.00	46.88
Cast-Steel,	{ Drawn,	55.60	80.00
	{ Annealed,	5.00	65.70

(108.) *Elasticity of Crystals.* — In most crystalline solids the elasticity is not the same in all directions, as is shown by the phenomena of cleavage (110). By a beautiful application of the

principles of acoustics, Savart* has determined in a few instances the differences of elasticity which the same crystals present, when examined on different lines of direction with reference to their crystalline axes. As neither the methods nor the results of his investigations could be made intelligible in this connection, we must refer the student to the memoirs cited below. These differences of elasticity in crystals give rise to some of the most beautiful phenomena of optics, and we shall have occasion to refer to the subject again in that connection.

(109.) *Collision of Elastic Bodies.* — The effects of collision, described in (41), are greatly modified when the bodies are elastic, and in a way which it is important to study. Let us then suppose, in order to make the case simple, that the bodies are two *elastic spheres*, *a* and *b*, Fig. 203, with different masses, *M* and *M'*, which are moving in the same direction, from left to



Fig. 203.

right, with the velocities v and v' respectively, v being greater than v' . When the balls come together, they will flatten each other (Fig. 204), until the velocities of the two become equal. If the bodies are soft, this flattening will be permanent, and the balls will move on together with a velocity which, as we have found, [23.] is



Fig 204.

$$v'' = \frac{M v + M' v'}{M + M'}. \quad [23.]$$

If the bodies, on the contrary, are elastic, and the limit of elasticity is not exceeded during the impact, we have the same result as before up to the moment of greatest flattening, and at that moment the velocity is v'' , as given above. But after this moment a new set of phenomena appears. The two balls thus flattened act as springs, and in resuming their original form impart reciprocally to each other as much momentum as was expended in producing the compression. At the moment of greatest com-

* Annales de Chimie et de Physique, 2^e Série, Tom. XL. Also Dufrenoy, *Traité de Minéralogie*, Tom. I. p. 289.

pression, it is evident that the ball a has lost in velocity an amount equal to $\mathbf{v} - \mathbf{v}'$; and, on the other hand, the ball b has gained in velocity an amount equal to $\mathbf{v}'' - \mathbf{v}$. In recovering its form, the ball b tends to drive a to the left, and therefore to retard its motion; and, on the other hand, the ball a tends to throw b forward, and therefore to accelerate its motion. Moreover, by the principle just stated, this retardation and acceleration will be just the same as that caused between the first contact of the balls and the moment of greatest compression. Hence, after the impact, the velocity of a will be diminished by an amount equal to $2(\mathbf{v} - \mathbf{v}'')$, and that of b increased by an amount equal to $2(\mathbf{v}'' - \mathbf{v})$. Representing, then, the velocities after the impact by \mathbf{v}_0 and \mathbf{v}_1 , we have

$$\mathbf{v}_0 = \mathbf{v} - 2(\mathbf{v} - \mathbf{v}''), \quad \text{and} \quad \mathbf{v}_1 = \mathbf{v}' + 2(\mathbf{v}'' - \mathbf{v}). \quad [70.]$$

Subtracting the second of these equations from the first, we obtain

$$\mathbf{v}_0 - \mathbf{v}_1 = \mathbf{v}' - \mathbf{v}. \quad [71.]$$

This equation shows that the difference of velocity is the same after the impact that it was before; but the relation has been reversed, the velocity of a being now less than that of b . Hence it follows, that, after the impact, the two balls will recede from each other as rapidly as they approached each other before; and this is true in every case of the impact of two spheres, when both are perfectly elastic. In order to find the actual velocities after impact, we have only to substitute in [70] the value of \mathbf{v}'' given by [23], when we obtain

$$\mathbf{v}_0 = \frac{(M - M') \mathbf{v} + 2 M' \mathbf{v}'}{M + M'},$$

and

$$\mathbf{v}_1 = \frac{(M' - M) \mathbf{v}' + 2 M \mathbf{v}}{M + M'}. \quad [72.]$$

In obtaining these values, we have supposed that both balls were moving from left to right, the mass M , whose velocity is the greatest, being at the left of the other. The same formulæ, however, hold true for all cases of direct impact; except that, when one of the balls is moving from right to left, the sign of its velocity must be changed. A few examples will illustrate the application of the formulæ.

Let us suppose, then, for the first case, that the masses of the two balls are equal, and that the ball b is at rest. We shall then have $M' = M$, and $\mathbf{v}' = 0$. Substituting these values in [72], we have

$$\mathbf{v}_0 = 0, \quad \text{and} \quad \mathbf{v}_1 = \mathbf{v}. \quad [73.]$$

Hence, after the impact, the ball a remains at rest, and the ball b moves on with the velocity which a had before the impact.

Let us suppose, as the second case, that the masses are equal, and that the motions are in opposite directions, that of a positive, and that of b negative. We shall then have $M' = M$, and $\mathbf{v}' = -\mathbf{v}$. Substituting, we obtain

$$\mathbf{v}_0 = -\mathbf{v}, \quad \text{and} \quad \mathbf{v}_1 = \mathbf{v}. \quad [74.]$$

Here, after the impact, the ball a will move from right to left with the previous velocity of b , and b will move from left to right with the previous velocity of a ; and in general, *when the masses are equal, the two spheres will interchange velocities.*

Let us suppose, as a third case, that the velocities are equal, and the motions in opposite directions, as before; and further, that the mass of b is greater than that of a . We then have $\mathbf{v}' = -\mathbf{v}$, and $M' > M$. Substituting, we obtain

$$\mathbf{v}_0 = \frac{(M - 3M')\mathbf{v}}{M + M'}, \quad \text{and} \quad \mathbf{v}_1 = \frac{(3M - M')\mathbf{v}}{M + M'}. \quad [75.]$$

In this case, after the impact, the ball a must always move from right to left, when, as supposed, $M' > M$. If $M' < 3M$, the ball b , after the impact, will move from left to right. If, however, $M' > 3M$, it will move from right to left. When $M' = 3M$, we have

$$\mathbf{v}_0 = 2\mathbf{v}, \quad \text{and} \quad \mathbf{v}_1 = 0; \quad [76.]$$

that is, the ball a will move from right to left with twice its previous velocity, and the ball b will remain at rest.

We can also apply the formulæ to the case where an elastic ball strikes vertically on a fixed obstacle, as when an India-rubber ball is let fall on the ground. In this case, $M' = \infty$, and $\mathbf{v}' = 0$. Substituting these values, [72] becomes $\mathbf{v}_0 = -\mathbf{v}$; that is, the body moves, after impact, with the same velocity as before, but in an opposite direction. Hence the India-rubber ball should, by (22), rebound to the same height from which it fell.

This is not practically true, because the surface on which it falls is never perfectly elastic, and, moreover, because the ball does not recover promptly from the compression.

Let us next suppose that the sphere strikes the obstacle in an oblique direction (Fig. 205), and that its velocity at the moment of collision is represented by the line ia' , which represents also the direction of the motion. This motion is, by (24), equivalent to two others, one in a direction which is tangent to the surface, and whose velocity at the moment of collision is represented by the line ic , and another, which is normal to the surface, and whose velocity at the moment of collision is represented by the line in' . The lines ic and in' are sides of a parallelogram, of which ia' is the diagonal. The first motion will continue, after the impact, with the same velocity, without changing its direction. The second motion, as we have just seen, will be changed by the impact into a motion in the opposite direction, but with the same velocity. In order to find the resulting path and velocity of the ball after the impact, we need only to combine these two motions. For this purpose, we have already drawn the line ic , which represents the velocity and the direction of the first component. The line in , drawn equal to the line in' , and in an opposite direction, will represent the velocity and direction of the second component. Completing the parallelogram and drawing its diagonal, we find that the body moves, after the impact, in the direction ib , with a velocity represented by the length of this line. Moreover, since the parallelograms cn and cn' are equal, their diagonals are also equal, — proving that *the velocity after the impact is the same that it was before*. Further, since in is in the same plane as in' , it follows that the diagonals must be in the same plane, which shows that *after the impact the ball moves in the same plane in which it moved before*. Lastly, it follows, from the equality of the parallelograms, that the angles bin and $a'in'$ are equal, and consequently the angles bin

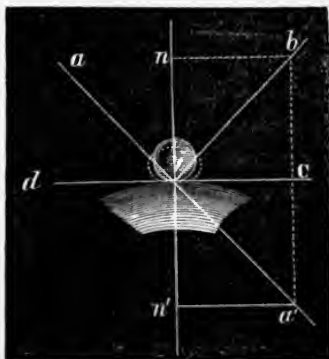

Fig. 205.

and $a i n$ are equal. The angle $a i n$, which the original direction of the motion makes with the normal to the surface of the fixed obstacle, is called the *angle of incidence*; and the angle $b i n$, formed by the direction of the motion after impact with this normal, is called the *angle of reflection*. Hence, *the angle of incidence is equal to the angle of reflection*.

The absolute equality of the angles of incidence and reflection is only realized when both the body and the obstacle are perfectly elastic. When this is not the case, the component $i n$ is less than $i n'$, and hence the angle $b i n$ greater than $a i n$, the angle of reflection becoming greater in proportion to the deficiency of elasticity; and when the bodies are unelastic, it becomes equal to 90° , and the ball moves, after the impact, in the direction $i c$. Compare (41).

Finally, let us suppose that two elastic spheres, A and B , Fig. 206, — moving in the same plane with the different velocities \mathbf{V} and \mathbf{V}' , — meet each other obliquely.

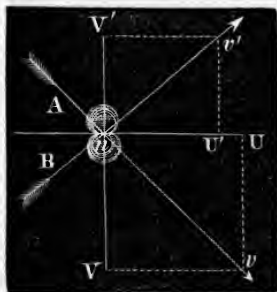

Fig. 206.

In order to find the directions and velocities of their motions after impact, we may extend the method adopted in the case just discussed. We first decompose the velocity of A , represented by the line $n v$, into two components at right angles to each other, $n U = a$, and $n V = b$. In like manner, we decompose the velocity of B into two components, $n U' = a'$, and $n V' = b'$. It is now evident that the effect of collision will not be felt in the directions $n U$ and $n U'$, since the balls will slide over each other in the direction of these components, and hence we shall obtain for the two velocities after contact in the direction $n U$ or $n U'$ two quantities, a_0 and a_1 , equal to a and a' respectively. It is, however, entirely different with the other two components. The velocities in the directions $V n$ and $V' n$ are reversed and changed by the collision, and we therefore seek by (72) what will be the velocities after the collision in the directions $n V$ for A , and $n V$ for B , and obtain two quantities, b_0 and b_1 . Lastly, by combining together on the principle of the composition of velocities the components a_0 and b_0 , we shall obtain the final direction and velocity of A ; and by combining a_1 and

b_1 , the final direction and velocity of B . This calculation can easily be made in any special case, and does not, therefore, require further illustration. When the masses of the two spheres are equal, as follows from [74], they exchange velocities in the directions $n V$ and $n V'$, and, the velocities in the directions $n U$ and $n U'$ being the same as before, the calculation then becomes quite simple.

The laws of the collision of elastic bodies may be illustrated in a great variety of ways; but the best of all illustrations is found in the game of billiards, which is based almost entirely upon them. This game is played with balls of ivory, which are in themselves elastic, and on a table whose raised edges are covered with elastic cushions. The object of the game is to hit one ball with another, set in motion with a stick moved by the hand, so that one or both shall afterwards move toward a certain point or points. To effect this, in the various positions of the balls, requires an empirical knowledge of the laws of the collision of elastic bodies, and great skill in their application. The results obtained in this game do not conform exactly to the theory, on account of the imperfect elasticity of the balls and cushions. Thus we have seen [73] that, when an elastic body encounters another of the same mass at rest, the last is set in motion, and the former remains stationary. This is not generally the case with billiard-balls, for usually both balls move after the impact; but nevertheless, when the stroke is very sharp, this result does at times occur. This is probably owing to the fact, that the friction of the ball on the cloth covering of the table, the imperfect elasticity of ivory, and other causes of disturbance, have the least influence when the ball is moving with a powerful force. So also, when the ball rebounds from the elastic cushion, the angles of incidence and reflection are not exactly equal, but they are very nearly so when the ball is driven with a powerful stroke.

Resistance to Rupture.

(110.) When a rod is stretched in the direction of its length, with a gradually increasing force, it finally breaks, the force required to break it depending on the substance of the rod, and its size. The smallest weight required to part it is the measure of

the resistance of the rod, and the weight required to part a rod of any substance, whose section is equal to one square millimetre, is the measure of the *tenacity* of that substance.

The resistance to rupture can be conveniently determined by means of the dynamometer, represented in Fig. 207. It consists

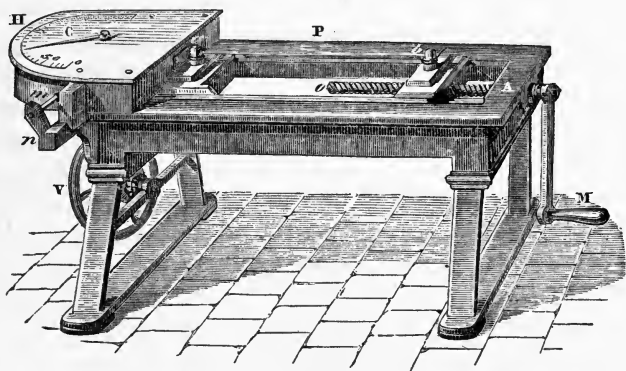

Fig 207.

of an iron frame, *P*, on which slide two carriages, *a* and *b*. The first of these is connected with a powerful spring, contained in the box *H*. When the carriage *a* is drawn forward, the spring is bent, and communicates motion to the index, *C*, which moves on a graduated arc, and indicates in kilogrammes the intensity of the force. The second carriage, *b*, is united with the frame at *A* by means of the screw *o*, and may be moved forwards or backwards by turning the handle *M*. The rest of the apparatus consists of a train of wheels and pinions, which connect the spring with the fly-wheel *V*, and prevent it from flying back too suddenly when the tension is removed.

In order to determine the *resistance to rupture* of a given wire by means of this apparatus, the two ends of it are fastened to the carriages by means of the vices which they carry. The handle, *M*, is then slowly turned until the wire breaks, when the needle, *C*, indicates in kilogrammes the amount of force which has produced the rupture.

By means of this apparatus, we can easily establish the truth of the following laws:—1. *The force required to produce rupture is proportional to the section of the bar.* 2. *It is independent of the length of the bar.*

In determining the resistance of bars to rupture, we meet with the same difficulty already referred to in connection with the determination of the limit of elasticity. The rupture is not caused by the action of a constant force. As soon as the strain exceeds the limit of elasticity, the rod elongates little by little, the particles are at first slowly displaced, but finally they suddenly separate and the rod breaks; so that a moderate force applied for a long time will frequently cause the rupture of a rod which would resist a much greater force applied for a short time. This slow diminution of tenacity is a fact to which it is essential to pay regard in the construction of buildings.

(111.) *Tenacity*. — The tenacity of a substance is the resistance to rupture, measured in kilogrammes, which a rod will exert, whose section is just one square millimetre. In determining the tenacity of solids, we may obviously experiment on rods or wire of any convenient size, the area of whose section is known, and then calculate the tenacity by the principles of the last section. The tenacity of the different metals differs very greatly, between that of lead, in which it is very feeble, and that of steel, which has the greatest tenacity of all, as will be seen by referring to the table on page 195, in which the tenacity of the useful metals is given at the side of the numbers expressing the limit of elasticity. It will also be noticed, that there is a very great difference between the tenacity of the same substance when drawn into wire and when annealed, it being greatest in the first condition. The process of drawing wire will be described in (113). The change of form which it produces is accompanied by another very curious result. Although the particles of the wire are really less close together after the operation of *drawing* than they were before, yet they hold together more firmly, so that the tenacity of the wire is greatly increased. The cohesion of iron is increased, in drawing, to a very remarkable degree, so that fine iron wire is the most tenacious of all materials. “ Thus a bar one inch square of the best cast-iron may be extended by a weight of nine tons and three quarters; a bar of the same size of the best wrought-iron will sustain a weight of thirty tons; a bundle of wires one tenth of an inch in diameter, of such size as to have the same quantity of material, will sustain a weight of from thirty-six to forty tons; and if the wire be drawn more finely, so as to have a diameter of only one

twentieth or one thirtieth of an inch, a bundle containing the same quantity of material will sustain a weight of from sixty to ninety tons."* Hence cables made of fine iron wire twisted together will sustain a far greater weight than chains containing the same quantity of iron. The cables of suspension bridges are usually made in this way.

(112.) *Cleavage*. — In crystalline bodies, the resistance to rupture is not equally great in all directions. Most crystallized bodies are found to break most readily in certain planes affording a more or less smooth fracture or cleavage, while, if they are broken in any other direction, the fracture is rough and jagged. These planes are called *planes of cleavage*. They are always parallel either to actual faces on the crystal, or to possible faces. Cleavage can generally be reproduced on the same crystal to an indefinite extent, in planes parallel to each other, thus dividing the crystal into a series of thin laminæ. Generally the same crystal may be cleaved in several directions, and the union of the several planes of cleavage forms what is called a *solid of cleavage*, which is constant for the same substance, and is always one of the simple forms of the system to which the crystal belongs. Compare (93).

Crystals differ very greatly from each other in the facility with which they may be cleaved. In some cases, the laminæ can be separated by the fingers. This is the case with mica and several other minerals. At other times, a slight blow of the hammer is required, as, for example, with galena and calc-spar; while not unfrequently cleavage can be obtained only by using some sharp cutting-tool and a hammer. When other means fail, it can sometimes be effected by heating the crystal and immersing it while hot in cold water. When cleavage is easily obtained, it is said to be *eminent*.

In crystals of the Monometric System, cleavage is obtained with equal ease in the direction of any one of the planes of cleavage; but in crystals of the other systems, cleavage is obtained with equal ease only in planes which are parallel to the similar planes of the crystal. The cubic crystals of galena, for example, which belong to the Monometric System, may be cleaved with equal readiness in either of the three directions which are parallel to

* Carpenter's Mechanical Philosophy.

the faces of the cube. On the other hand, the crystals of gypsum, which belong to the Monoclinic System, may be cleaved with great facility in one direction, less readily in a second, and only with some difficulty in a third; in thick crystals, the last two cleavages are scarcely attainable.

The general laws with respect to cleavage are stated by Professor Dana* as follows:—

1. *Cleavage in crystals of the same species yields the same form and angles.*

2. *Cleavage is obtained with equal ease or difficulty parallel to similar faces, and with unequal ease or difficulty parallel to dissimilar faces.*

3. *Cleavage parallel to similar planes affords planes of similar lustre and appearance, and the converse.*

(113.) *Ductility and Malleability.*—Some substances will not allow a permanent displacement of their molecules, and break whenever the strain exceeds the limit of elasticity. Such substances are called *brittle bodies*, and to this class belong glass, tempered steel, marble, sulphur, and many others. There are other substances, on the contrary, which, when submitted to various mechanical processes, allow a permanent displacement, more or less considerable, of their molecules, which then assume new positions of equilibrium. This property is possessed in a high degree by the metals, and is called *ductility* or *malleability*, according as it is applied in drawing out wire, or in reducing the metal to sheets and leaves in a rolling-mill or under the hammer.

The machine for drawing wire consists essentially of a plate of hardened steel pierced with a number of conical holes of different sizes. Through one of these holes is passed the end of a metallic rod, which has been reduced in size for the purpose. This end is then seized with a pair of pliers and pulled with considerable force. In being thus forced through the hole, the rod becomes lengthened, and diminished in size. It is then passed in like manner through a smaller hole, and thus successively, until the wire is reduced to the requisite fineness. Fig. 208 is a representation of a mill used for drawing iron wire. The coarser wire is unwound from the reel *F*, and, after having

* System of Mineralogy, Vol. I. p. 103.

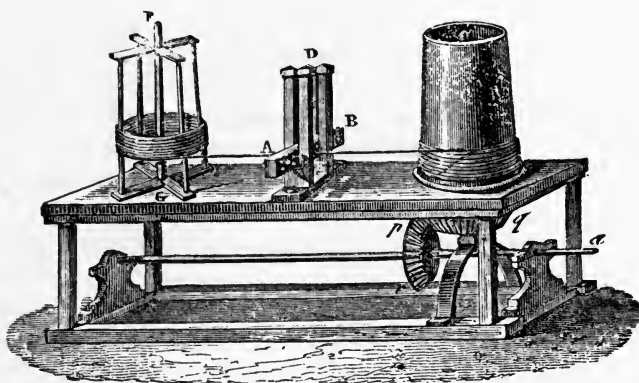

Fig. 208.

passed the *drawing-plate* *A B*, is received on the drum *C*, to which the force is applied through the cog-wheels *r p, n q* (see Fig. 209).

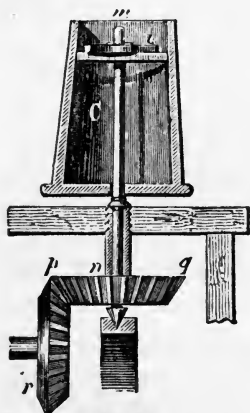

Fig. 209.

In order that a substance should readily yield to this mechanical action, it is evidently essential, not only that its particles should have the power of readily changing their position, but also that it should be endowed with great tenacity. Hence those metals whose particles admit most readily of change of position are not necessarily the most ductile.

A rolling-mill consists of two steel rollers, arranged as represented in Fig. 210, so that their distance apart can be varied at pleasure, and so that they may be turned together in unison, but in opposite directions. The plate of metal is applied between the two rollers, and is forced to accommodate its thickness to the distance between them, which is adjusted so as to be a little less than the thickness of the plate. This distance may then be diminished, and the process repeated until the thickness of the plate is reduced to the desired amount.

Many of the metals can be reduced to leaves of exceeding tenacity under the hammer. It is in this way that the goldleaf used in gilding is prepared. The gold plate is first reduced in a rolling-mill to the thickness of about one millimetre. Several

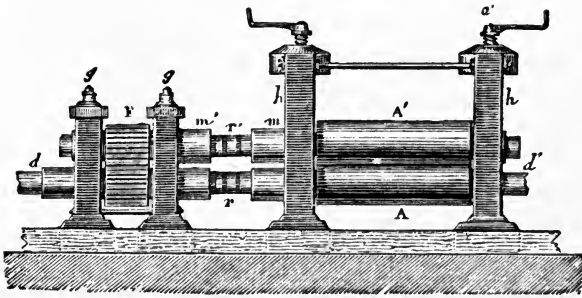

Fig. 210.

of these plates are now piled on each other, and spread out by beating the pile with a heavy mallet until they are reduced to the thickness of a sheet of paper. The leaves are next separated from each other by sheets of paper, and the pile beaten again. Finally, the sheets of paper are replaced by others made of gold-beaters' skin. In this, as in all similar processes, the metal becomes brittle, and would infallibly break or tear were it not frequently reannealed. The process of annealing consists in heating the substance to a high temperature, and then allowing it to cool very slowly.

The relative malleability of the metals is not the same when hammered as when rolled, and the difference appears to arise from the sudden shocks which accompany the blows of the hammer. In the following table, the relative malleability of the useful metals by both methods is given side by side, together with the relative tenacity and ductility. A comparison of the columns will illustrate what has been stated above.

Tenacity.	Ductility.	Malleability under the Hammer.	Malleability under the Rolling-Mill.
Iron	Platinum	Lead	Gold
Copper	Silver	Tin	Silver
Platinum	Iron	Gold	Copper
Silver	Copper	Zinc	Tin
Zinc	Gold	Silver	Lead
Gold	Zinc	Copper	Zinc
Lead	Tin	Platinum	Platinum
Tin	Lead	Iron	Iron

The action of heat modifies, in a most marked manner, both the ductility and malleability of many bodies. Iron, for example, is

very malleable at a red heat, and in this condition it can be readily forged or rolled into sheets. Glass, again, which is brittle at the ordinary temperature, is both malleable and ductile to the highest degree at a red heat. Copper, on the other hand, is most malleable when cold, and zinc cannot be rolled out with success except between the temperatures of 130° and 150° C. Above this last temperature, it becomes very brittle.

The malleable metals are capable of receiving impressions from blows; a property which is continually made use of in various processes of the arts. The processes of stamping coins and embossing figures on surfaces of various kinds are an illustration of the fact. The impression is made by means of a die, in which the design is sunk, just as the raised impression which the wax is to present is sunk in the seal. The die, which is made of the hardest steel, is forced down upon the blank coin by means of a powerful screw or lever, and the metal of the coin, being comparatively soft, is driven with great force into the cavities of the die, and retains the impression.

Hardness.

(114.) *Scale of Hardness.* — Hardness is the resistance which bodies oppose to being scratched or worn by other bodies. Of two substances, that one is said to be the hardest which will scratch the other. The hardness of a body is closely related to its ductility and tenacity, all circumstances which increase the ductility or diminish the tenacity rendering the body softer, and the reverse. In order to distinguish a harder body from a softer, we either attempt to scratch the one with the other, or we try each with a file. The last method is generally to be preferred; but both should be employed when practicable, since some bodies “give a low hardness *under the file*, owing either to impurities or imperfect aggregation of the particles, while they scratch a harder species, — showing that the particles are hard, although loosely aggregated.”*

Hardness is an important character of a substance, and is much used by mineralogists as a means of distinguishing between mineral species. In order to fix a common standard of comparison, the distinguished German mineralogist, Mohs, introduced a

* Dana's System of Mineralogy, Vol. I. p. 130.

scale of hardness. This scale consisted of ten minerals, which gradually increase in hardness, marked from 1 to 10. It has been since modified by Breithaupt, who has introduced two additional degrees of hardness, one between 2 and 3, the other between 5 and 6, as these intervals were larger than the rest. The numbers of Mohs, however, have been retained. The scale is as follows:—

1. *Talc*; common laminated, light-green variety.
2. *Gypsum*; a crystallized variety.
- 2.5. *Mica*; variety from Zinnwald.
3. *Calcite*; transparent variety.
4. *Fluor-Spar*; crystalline variety.
5. *Apatite*; transparent variety.
- 5.5. *Scapolite*; crystalline variety.
6. *Felspar* (orthoclase); white, cleavable variety.
7. *Quartz*; transparent.
8. *Topaz*; transparent.
9. *Sapphire*; cleavable varieties.
10. *Diamond*.

In determining the hardness of a mineral, we draw a file over it with considerable pressure. If the file abrades the mineral with the same ease as No. 4, and produces an equal depth of abrasion with the same force, the hardness is said to be 4; if less readily than 4, but more readily than 5, it is said to be between 4 and 5 (written 4-5); or we may determine it with more accuracy as 4.25 or 4.50. Several successive trials should be made, in order to insure accuracy, and the student should practise himself in the use of the file with specimens of known hardness, until he can obtain constant results.*

(115.) *Sclerometer*.—In testing the hardness of the dissimilar faces of the crystal, very marked differences are frequently observed. Differences may also be perceived on the same face when examined in different directions. For the purpose of measuring with great accuracy the differences in hardness which the faces of a crystal present, an apparatus has been contrived by Grailich † and Pekarek, called a *sclerometer*. It consists

* Boxes containing the twelve minerals of the Mohs scale can be procured from the dealers in philosophical apparatus.

† Sitzungsberichte der mathem.-naturw. Classe der kais. Akad. der Wissen., (Wien, 1854,) Band XIII. s. 410.

essentially of a hard steel point attached to the under side, at one end, of a balance beam, which is carefully poised on its knife-edge. Above the point, and on the upper side of the beam, there is a pan to receive weights, by which the steel point may be pressed down upon the face of a crystal with a regulated force. At the other end of the beam there is fastened a spirit-level, and the whole is so adjusted that the beam—with the point and pan at one end, and with the spirit-level at the other—is just in equilibrium.

By means of the sclerometer, it appears, for example, that the rhombohedral faces of crystals of calcite, r (Fig. 211), are softer

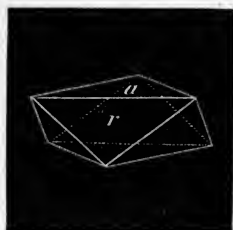

Fig. 211.

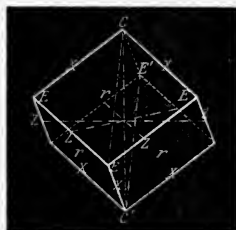

Fig. 212.

than the end faces, a . It has also been found that the hardness is not the same in all directions on the rhombohedral face. From a series of determinations made by Grailich and Pekarek with their sclerometer, it appears that the greatest hardness is in the direction of the shorter diagonal of the face, from C to E (Fig. 212), and the least hardness in the opposite direction, from E to C on the same diagonal. The weights required in the pan above the hard point, in order to scratch the face in various directions, were as follows:—

Angle.*		Weight.
0°	Shorter diagonal from C to E ,	285 centigrammes.
39°	Perpendicular to edge x ,	250 "
51°	Parallel to edge z ,	213 "
90°	Longer diagonal from E to C ,	152 "
129°	Parallel to edge x ,	135 "
141°	Perpendicular to edge z ,	126 "
180°	Shorter diagonal from E to C ,	96 "

These numbers are in each case the mean of several observations. Similar differences have been observed on a large number

* These angles are those made by the given direction with the shorter diagonal.

of other crystals, and they lead to the following general conclusions: —

1. That the hardest planes of a crystal are those which are perpendicular to the plane of most perfect cleavage.*

2. That on a given plane the direction of greatest hardness is that which is most inclined to the direction of most perfect cleavage.

(116.) *Annealing and Tempering.* — The hardness of many substances may be greatly modified by the action of heat, and by various mechanical processes. The effects of change of temperature in varying the degree of hardness are most important in regard to steel, since it is on this influence that the application of steel to so great a variety of useful purposes depends. If steel is heated to a red heat, and then very slowly cooled, it becomes ductile, flexible, soft, and comparatively unelastic.* This process is called *annealing*, and, when thus annealed, steel can readily be drawn into wire, rolled into sheets, or manufactured into its numerous useful forms. If, however, the articles thus manufactured are heated to a white heat, and then suddenly cooled by plunging them into water or mercury, the steel becomes very hard, brittle, highly elastic, and less dense.

In its state of greatest hardness, steel is scarcely fit for any purposes in the arts, since it is so brittle that its points or edges are broken by a very slight resistance. But by reheating it to a lower temperature, and then slowly cooling it, this extreme hardness may be reduced, and the flexibility of the steel proportionally increased. The amount of the reduction is greater, the higher the temperature to which the articles are heated, and if heated to a red heat, they again become soft.

This process of reheating is termed *letting down* or *tempering*, and the workman is guided to the effects he wishes to produce by the changes of color which the surface of polished steel exhibits at different temperatures. The tints which correspond approximately to the different temperatures are as follows: —

Light straw, 220°	Violet-yellow, 265°	Blue, 293°
Golden-yellow, 230°	Purple-violet, 277°	Deep Blue, 317°
Orange-yellow, 240°	Feeble blue, 288°	Sea-green, 330°

* Lehrbuch der Krystallographie von Miller übersetzt und erweitert durch Dr. J. Grailich, (Wien, 1856,) Seite 229.

The hardest steel is used for little else than the making of dies for coining. The steel of the hardest files is but little let down. The first shade of yellow indicates that the reheating has been carried sufficiently far for lancet and other small surgeons' instruments, on which the keenest edge is required. Razor and pen-knife blades are heated until they exhibit a light straw-color. Scissors, shears, and chisels, in which a greater tenacity is required, are tempered at the first shade of orange. Table cutlery, in which flexibility is more desirable than the hardness, which would give a fine but brittle edge, are heated to the violet. Watch-springs are heated to a full blue, and coach-springs to a deep blue. In many manufactories the *temper* is given by immersing the hardened steel articles in a bath of mercury or oil, the heat of which can be exactly regulated by a thermometer. The bath is heated up to the required temperature, and then allowed to cool slowly. In this way, any number of articles which are to receive the same temper may be equably heated and gradually cooled.

Most other metals are acted upon by heat and cold in somewhat the same manner, although to a much less degree. Copper, however, is a remarkable exception to the rule, its properties being exactly the reverse of those of steel; for when cooled slowly it becomes hard and brittle, but when cooled rapidly, soft and malleable. This same property is possessed to a still higher degree by *bronze*, which is an alloy of copper and tin.

Glass undergoes, from the action of heat and cold, the same changes as steel. When heated to a red heat, and suddenly cooled, it becomes more brittle, harder, and less dense than in its annealed condition. When a glass vessel is first blown, it cools rapidly and irregularly, and the varying hardness of its different parts gives to it such a degree of brittleness, that the slightest shock or a small change of temperature would break it. In order to prevent this, it is annealed, by passing it through a long furnace, of which the heat is very great at one end and slowly diminishes towards the other, and it is thus cooled gradually and equably.



Fig 213.

The properties of unannealed glass are illustrated by Prince Rupert's drops. These are made by dropping melted glass into water, which of course cools them suddenly, and gives to the glass a high degree of hardness and a proportionate brittleness. They have a

long oval form, tapering to a point at one end (Fig. 213). The body of the *drop* is so hard that it will bear a smart stroke; but if a portion be broken off from the small end, the whole immediately flies into minute particles with a loud snap.

The cause of the changes in hardness produced by the action of heat has not been as yet satisfactorily explained. The explanation usually given is this. When a bar of steel highly heated, and hence greatly expanded, is immersed in cold water, the exterior layers suddenly contract, and are compelled to adapt themselves, by a permanent displacement of their molecules, to the core, which is still in an expanded state within. Subsequently, when the interior of the mass cools, its particles cannot approach each other freely, because they are more or less united to the external crust, which has been already fixed in position. Hence, these particles remain in a state of tension, and this is supposed to give rise to the peculiar change of properties.

Were this explanation correct, the effects of a sudden change of temperature ought to be greatest on thick bars of steel, but in fact the reverse is the case. The change is most probably connected with the phenomena of dimorphism (98), but in what way is not yet understood.

Most metals are hardened, not only by sudden cooling, but also by such mechanical processes as tend to condense them permanently, and thus increase their density. The processes of stamping coin, of wire-drawing, of rolling out metallic plates, and of hammering, are all evidently of this nature. This change is usually called *hammer-hardening*, and its effects are the same on almost all ductile bodies. They become denser, more tenacious, harder, more brittle, and more elastic. All these effects can be removed by annealing; and hence the necessity of continually reannealing the metals, during the processes just mentioned.

PROBLEMS.

Elasticity of Tension.

91. A rectangular iron bar 2 m. in length, and whose section is equal to 2 c. m.^2 , is suspended by its upper extremity to a firm support, and to its lower extremity is attached a weight of 1,000 kilog. How much is it temporarily elongated by the strain, when the temperature is 15° ?

92. An annealed iron wire 2 m. m. in diameter and 2.25 m. in length is suspended as in the last example. How much weight is required to elongate it 0.25 m. m., when the temperature is 15° ?

93. A silver wire 0.75 m. m. in diameter and 5 m. long is elongated by a weight 0.25 m. m. How great is this weight when the temperature is 15° ?

Tenacity.

94. With how much weight in kilogrammes must a copper wire be loaded, in order to part it, when the diameter of the wire is equal to 1 m. m.? Calculate both for annealed and unannealed wire.

95. In a pendulum experiment, it is required to suspend a weight of 50 kilog. by a copper wire. What must be the diameter of the wire, allowing $\frac{9}{59}$ for security beyond the diameter absolutely essential? Calculate both for annealed and unannealed wire.

Collision of Perfectly Elastic Bodies.

In the following problems marked with a (), the masses and velocities of the two balls are indicated as described in (109). The motion is from left to right, unless the reverse is indicated by a negative sign. In each problem it is required to find the velocities of the two balls after the impact, and also the direction of the motion.*

- *96. $M = 6.$ $v = 3$ m. $M' = 17.$ $v' = 1$ m.
 *97. $M = 10.$ $v = 5$ m. $M' = 20.$ $v' = 2.5$ m.
 *98. $M = 10.$ $v = 10$ m. $M' = 100.$ $v' = 0$ m.
 *99. $M = 20.$ $v = 10$ m. $M' = 10.$ $v' = -5$ m.
 *100. $M = 15.$ $v = 16$ m. $M' = 10.$ $v' = -32$ m.

101. A ball whose mass is M , with a velocity v , meets a second ball moving in the same direction, whose mass is M' . What must be the velocity of the second ball, when the first ball remains at rest after the collision?

102. A ball strikes on a plane making an angle of incidence equal to 60° . What will be the angle of reflection when, in consequence of the imperfection of the elasticity both of the plane and the body, one third of the vertical velocity is lost by the impact? Solve the same problem, supposing that one fourth of the velocity is lost.

103. An elastic ball falls from the height of 2 m. How high will it rebound, supposing that one fifth of the final velocity is lost at the impact, in consequence of imperfect elasticity?

104. Two perfectly elastic balls, moving in the same plane, meet each other obliquely. The angles made by the two directions of their motions with the line nU (Fig. 206), lying in the same plane and tangent to both balls at the point of contact, are $\alpha = 60^{\circ}$ and $\beta = 30^{\circ}$. The masses are $M = 10$ and $M' = 5$; the velocities are $v = 2.5$ and $v' = 5$. It is required to find the velocities of the two balls after collision, and the angles which the directions of their motions make with the given line.

105. Solve the same problem for the following values: —
 $\alpha = 40^{\circ}$. $\beta = 30^{\circ}$. $M = 5$. $M' = 10$. $v = 4$ m. $v' = 6$ m.

II. CHARACTERISTIC PROPERTIES OF LIQUIDS.

(117.) *Mechanical Condition of Liquids. Fluidity.* — The liquid has not, like the solid (79), a definite form; but it takes the form of the vessel in which it is placed. Its particles are in a condition of equilibrium between *the attractive and repulsive forces* (78), and instead of being bound together, as in a solid, they possess a perfect freedom of motion; and under the influence of the slightest force, they move among each other without friction and without disturbing the general equilibrium. This mechanical condition of matter is termed *fluidity*, and belongs both to liquids and gases. Liquids are not, however, perfect *fluids*, for there always exists between their particles a certain amount of adhesion, owing to an excess of *attractive force* which renders them more or less *viscous*. Between an almost perfect fluid, like water, and a condition like dough, we have every grade of fluidity. This is illustrated by the well-known series of organic acids, commencing with formic acid and ending with mellic acid. The series consists of over twenty members, and presents every grade of condition. Formic acid is as fluid as water; but as we descend in the series, the numbers are found to be more and more viscous, becoming first oily, then soft fats, next hard fats, and finally solids, like wax.

(118.) *Elasticity of Liquids.* — It has already been stated (76), that liquids are compressible, and, moreover, that they resume exactly their original volume as soon as the pressure by which this was diminished is removed. It follows from these facts, that liquids are perfectly elastic, and that this elasticity is unlimited in extent.

In the early experiments on compressibility made by Oersted, it was assumed that the capacity of the bulb *A*, of the apparatus already described (Fig. 214), remained invariable. This assumption was based on the fact, that the walls of this reservoir were equally pressed by the fluid on both sides. It is easy, however, to see that this assumption is incorrect; for if we suppose the interior of the bulb to be filled with solid glass, it is evident that the volume of the interior core, and hence that of the bulb, would be diminished by the exact amount that this glass core would be compressed by the given pressure. In such a case, the pressure on the exterior surface of the bulb would be

exactly balanced by the reaction of the glass core. If, now, the place of the glass core is supplied by water, the pressure on the exterior surface remaining the same, it is evident that the reaction of the water core must be exactly the same as that exerted by the glass core ; for otherwise the law of action and reaction (41) would not be obeyed. The conditions, then, with respect to the bulb, are not changed, and it is evident that its volume will be just as much reduced when filled with water as when filled with glass ; that is, by the amount to which a glass core just filling it would be compressed by the given force.

It follows from this, that the *apparent condensation* of any fluid under a given pressure, when determined by the apparatus repre-

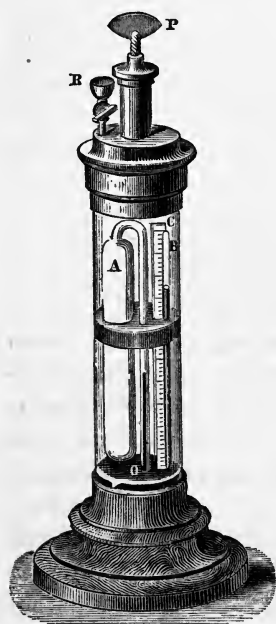

Fig. 214.

sented in Fig. 214, is not so great as the real condensation, and that it is necessary to correct the determinations thus made by adding to the observed compression an amount equal to the compression, under a given pressure, of a glass core which would just fill the interior of the bulb. This amount can in any case be calculated from data furnished by experiments on the elongation of glass rods by tension, since, according to M. Wertheim, the diminution, under a given pressure, of one cubic centimetre of glass, in fractions of a cubic centimetre, is just equal to the elongation of a glass rod one centimetre long, in fractions of a centimetre, under an equivalent tension. M. Grassi has carefully redetermined the compressibility of several liquids, making use of an improved apparatus contrived by Regnault, and correcting his observa-

tions for the compressibility of the reservoir used according to the formulæ of Wertheim. He has also studied the influence of a variation of temperature on the compressibility, as well as the influence of different pressures. The most important results obtained by M. Grassi are given in the following table. In every case, the numbers expressing the compressibility of a liquid

indicate the fraction of its volume by which it is condensed when submitted to a pressure of one atmosphere.

*Table of the Coefficients of Compressibility.**

Liquid.	Temperature.	Compressibility.	Pressure in Atmospheres, from which the Compressibility was determined.
	°		
Mercury,	0.0	0.00000295	. .
Water,	0.0	0.0000503	. .
"	1.5	0.0000515	. .
"	4.1	0.0000499	. .
"	10.8	0.0000480	. .
"	13.4	0.0000477	. .
"	18.0	0.0000463	. .
"	"	0.0000460	. .
"	25.0	0.0000456	. .
"	34.5	0.0000453	. .
"	43.0	0.0000442	. .
"	53.0	0.0000441	. .
Ether,	0.0	0.000111	3.408
"	0.0	0.000131	7.820
"	14.0	0.000140	1.580
"	13.8	0.000153	8.362
Ethylic Alcohol,	7.3	0.0000828	2.302
" "	7.3	0.0000853	9.450
" "	13.1	0.0000904	1.570
" "	13.1	0.0000991	8.97
Methylic Alcohol,	13.5	0.0000913	. .
Chloroform,	8.5	0.0000625	. .
"	12.0	0.0000648	1.309
"	12.5	0.0000763	9.2

In the case of water, it was found that the amount of condensation was proportional to the pressure, and that it diminished when the temperature was increased. On the other hand, it appeared that the compressibility of alcohol, ether, and chloroform increased with the temperature, and, moreover, that the compressibility of these fluids, as well as that of methylic ether, increased with the pressure.

M. Grassi also made experiments on the compressibility of saline solution, and found that, for the same solution, it was as constant as that of pure water, and that it diminished when the amount of salt in solution was increased.

* Annales de Chimie et de Physique, 3^e Serie, Tom. XXXI. p. 437.

Consequences of the Mechanical Condition of Liquids.

(119.) We have seen, in the last two sections, that the molecules of a liquid are in a condition of equilibrium, and also that all liquids are but slightly compressible and perfectly elastic. Of the characteristic properties of liquids, we shall only consider those which are a necessary consequence of these conditions. These naturally divide themselves into two classes: first, those which are independent of the action of gravity; and, secondly, those which depend upon it.

(120.) *Liquids transmit Pressure in all Directions.* — This most important quality of liquids was first clearly stated by Blaise Pascal, in the following terms: *Liquids transmit equally in all directions a pressure exerted at any point of their mass.*

We may illustrate what is meant by this statement of Pascal, by means of Fig. 215, which represents the section of a vessel

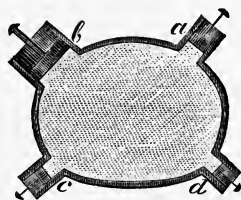

Fig. 215.

—which may be of any shape—filled with water, on the sides of which are several apertures closed by movable pistons. Let us suppose that the two pistons *d* and *c* present the same surface; and, further, that the piston *a* presents twice, and the piston *b* five times, the area of *c*. If, now, we press in the piston *c* with the force of one kilogramme, this force will be transmitted in every direction to the sides of the vessel, and every portion of the interior surface whose area equals that of the piston will be pressed upon with a force of one kilogramme; the piston *d* will be pressed out with a force of one kilogramme; the piston *a*, with a force of two kilogrammes; the piston *b*, with a force of five kilogrammes. And so will it be with any other portion of surface, either on the side of the vessel or immersed in the fluid; it will be pressed upon with a force as many times greater than one kilogramme, as it is itself greater than the surface of the piston *c*.

It is easy to see that this is a necessary consequence of the constitution of liquids. Since fluids are compressible and elastic, it follows that, on pressing in the piston *d*, the liquid is very slightly condensed, and the elasticity of compression developed in its particles. Each particle at once becomes like a bent spring,

and presses in all directions. If the particle is in the midst of the fluid mass, it presses against the neighboring particles; if it is on the side of the vessel, it presses in one direction against the vessel, but in all others against similar particles. Since the same is true of every particle, it follows that the pressure exerted by the condensed liquid against any two surfaces will be proportional to the number of particles in contact with these surfaces; and as the particles have the same size, it will also be proportional to the area of the surface. Hence the pistons *d* and *c* will be pressed out each by the same force, the piston *a* by a force twice as great, and the piston *b* by a force five times as great, as this. From the principle of equality between action and reaction, it follows that the outward pressure on the piston *c* is exactly equal to the force applied to press it in; so that, if this piston is pressed *in* with a force of one kilogramme, the piston *d* is pressed *out* with the same force, the piston *a* with a force of two kilogrammes, etc.; which was the proposition to be proved.

Representing the area of any portion of the interior surface of a vessel by *S*, and that of any other portion by *S'*; representing also by *F* and *F'* the pressure exerted against these surfaces by a confined liquid, in consequence of any compression; we have

$$F : F' = S : S'. \quad [77.]$$

Moreover, it is evident from the principle involved, that this equation is true, not only for the surface of the vessel itself, but also for that of any solid immersed in the compressed liquid, or for any section of liquid particles whatsoever in the vessel.

(121.) *The line indicating the direction of the pressure exerted by any liquid particle against the surface with which it is in contact, is always a perpendicular to this surface at the point of contact. If the surface is a plane, the line is a perpendicular to this plane; if the surface is curved, the line is a normal to this curve.* The truth of this principle will be seen, if we consider what must be the result if the direction of the pressure were oblique. It is evident that such oblique pressure would be resolved into two forces (35), one perpendicular to the surface, and the other tangent to it. The second component could of course exert no pressure against the surface; so that the whole pressure exerted by the liquid particle would be that of the first component, which is, as the proposition requires, perpendicular to the surface at the point of contact.

When the surface is plane, the directions of the pressures exerted by the particles are all parallel. It is then always possible, by (39), to find a common resultant of all these parallel forces. The point of application of this resultant is called the *centre of pressure*. When the pressures exerted by the separate particles are all equal, the centre of pressure is always the centre of figure of the surface. In the case of the pistons (Fig. 215), the centre of pressure is in each one the centre of the circular base, and in studying its mechanical effects we may regard all the pressure as concentrated at that point. Were the base of the piston concave, then the directions of the pressures exerted by the separate particles would no longer be parallel; since the lines indicating these directions would diverge from the centres of curvature. Compare (60). Moreover, as the area of the curved surface would be greater than that of the plane surface, it is evident that the total amount of pressure which it would sustain under the same circumstances would be greater; but it can be proved that the pressure available in moving the piston would be the same as before. For this purpose, it is only necessary to decompose the pressure exerted by each particle into two forces, one acting in a direction which is parallel to the axis of the cylinder, and the other at right angles to this direction. The forces acting parallel to the axis of the piston are obviously the only ones which are available in moving it; and the sum of these forces will be found to be the same as the total pressure which would be exerted if the base of the cylinder were a plane.

(122.) *Hydrostatic Press.* — This most beautiful application of the equality of pressure was conceived by Pascal; but the difficulty of avoiding the escape of water from the joints of pistons prevented him from realizing his conception, and the press was first constructed by Bramah, in 1796, at London.

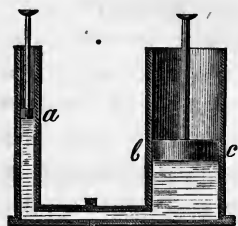

Fig. 216.

It is perfectly evident that the principle of equality of pressures deduced in the last section is entirely independent of the form of the vessel, and we may therefore give to the vessel the form of Fig. 216, in which the area of the piston *b c* is twenty times as large as that of the piston *a*. Hence it follows, that, if we press in the pis-

ton *a* with a force of five kilogrammes, the piston *b* will be forced out with twenty times as much force, or one hundred kilogrammes; and, on the other hand, if we press in the piston *b c* with a force of one hundred kilogrammes, the piston *a* will be forced out with a force of only five kilogrammes. It is evidently unimportant that the connection between the piston should be so direct as in Fig. 216. If it is effected by a long and narrow tube, the principle will still hold true, provided only that the joints are tight and the material of the vessel unyielding.

The hydrostatic press, which is used in the arts for producing great pressure, is only a modification of the apparatus represented by the diagram, Fig. 216. One of the most usual forms of this machine is represented in perspective by Fig. 217, and in section

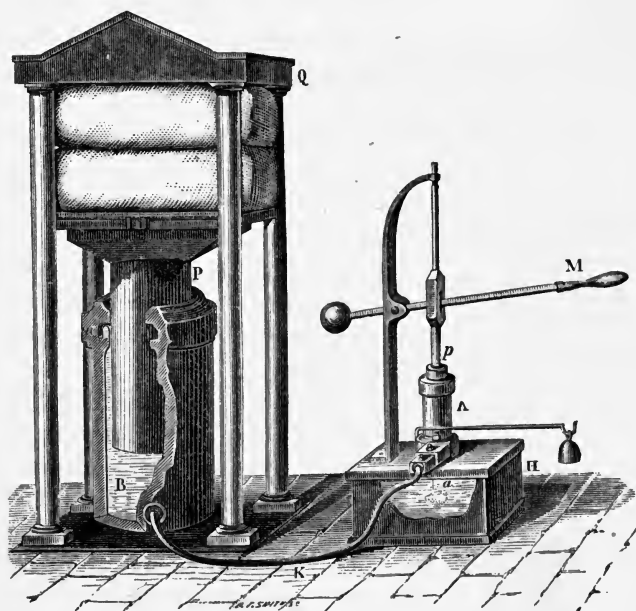

Fig. 217.

by Fig. 218. The same parts are lettered alike on the two figures. It consists of two cylinders, *A* and *B*, connected together by a tube, *K*. In the larger cylinder moves the large piston *P*, which is made in the form of a plunger, touching the walls of the cylinder only at the top, where it passes through a water-tight packing. On the top of this piston is a platform, which rises and falls with

it, and the articles to be submitted to pressure are placed between this and a second platform, *Q*, which is firmly fastened to the floor by means of four iron columns, which also serve to guide the motion of the lower platform. The small piston *p* is con-

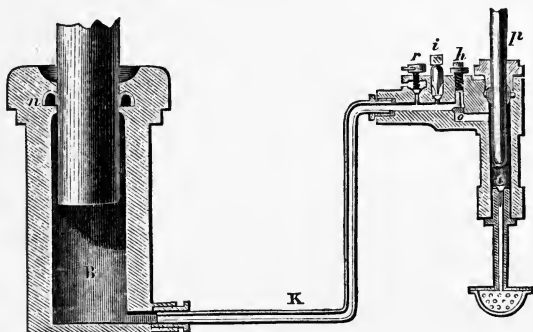

Fig. 218.

structed exactly like the larger, and is moved up and down in the cylinder by the pump-handle *M*. The small cylinder acts as a force-pump. It connects with a reservoir of water below by means of a tube terminating with a *rose*, *a*. This tube is guarded by a valve, *c*, which allows the water to flow up into the pump, but not in the reverse direction. It is evident from this description, that, on working the handle *M*, water will be alternately sucked up from the reservoir and forced into the large cylinder *B*, through the pipe *K*, from which it is prevented from returning by a valve at *o*. The large piston will thus be forced up by a pressure which will be as much greater than that exerted on the small piston as the area of its section is greater. If, for example, it is a hundred times as large, it will be pressed up with a force one hundred times greater than that exerted on *p*. This force can be so much increased by the lever *M*, that a man can easily exert a downward pressure of 150 kilogrammes on *p*, and the piston *P* will then be pressed up with a force equal to 15,000 kilogrammes.

It must be noticed, however, that the piston *P* will rise very slowly, and as much more slowly than the motion of *p* as the area of its section is greater. This is in accordance with a well-known principle of mechanics, which is true of all machines, that what is gained in force is lost in velocity (or extent of motion). In the present case, in order to raise the piston *P* one metre under a force

of 15,000 kilogrammes, it is necessary to push down the piston p through one hundred metres with a force of 150 kilogrammes. This is accomplished by repeated motions of the handle M .

The tube K is furnished with a safety-valve, i (Fig. 218), kept in place by a weight acting on it through a lever (Fig. 217). There is also a valve-cock at r , by which the water in the cylinder B may be vented into the reservoir H , in order to lower the piston; and, lastly, a third valve-cock, by which the communication between the cylinders may be closed when it is desirable to keep the articles under pressure for some time. The peculiar form of the packing at n is also deserving of notice. It is made of thick leather saturated with oil, in the form of an inverted U, and the more the water is compressed, the more firmly the leather is pressed against the sides of the cylinder and piston.

The hydraulic press is applied in the arts for a great variety of purposes, such as packing dry goods in bales, pressing out printed sheets, extracting oil from grains, and testing steam-boilers. It was also used for raising the iron tubes of the Britannia Bridge over the Menai Strait.

(123.) *Pressure exerted by Liquids in Consequence of their Weight.* — In the first place, let us consider what will be the pressure exerted by a liquid on the bottom of the containing vessel. Let $a r m$, Fig. 219, be a conical vessel, which we will suppose filled with water to the point o . Let us suppose the liquid to be divided into a number of strata by the planes $b c$, $e d$, $i g$, $p n$, which we may take as thin as we wish, and only consider in each stratum the cylindrical mass enclosed in dotted lines. It is now evident that the pressure exerted by each cylindrical mass on its own base will be equal to its own weight. Then, from the principle of Pascal, the pressure exerted by the weight of the first mass will be transmitted to the whole section $b c$, so that this will have to support a pressure as much greater than the weight of the first mass as the area of this section is greater than the area of the base of the first cylinder. Hence it follows, that it will support a pressure equal to the weight of a column of water whose base equals $b c$, and whose height is that of the first cylinder. This pressure will then be added to the weight of the second cylinder,

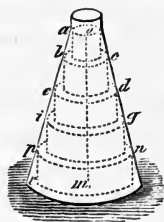

Fig. 219.

which, on the same principle, will be transmitted to the whole section ed ; and hence the resulting pressure exerted on the section ed is equal to the weight of a column of water whose base equals this section, and whose height equals the sum of the heights of the first and second cylinders. The same course of reasoning may be extended to the sections ig , pn , and also to the base, rm . Hence the pressure on the base, rm , is equal to the weight of a column of water whose base equals this base, and whose height equals the sum of the heights of all the cylinders, or om .

This demonstration is evidently independent of the number of strata, and must therefore hold when this number is infinite and the vessel conical. It is also evident that it is independent of the form of the vessel. It would hold if the vessel, remaining conical, were placed in an inverted position, or for a vessel of any shape whatsoever. We may therefore conclude, as the general result of this discussion, that *the pressure exerted by a liquid on the horizontal base of the containing vessel is equal to the weight of a column of this liquid whose base equals the base of the vessel, and whose height equals the depth of the liquid in the vessel.*

The fact, that the pressure exerted by a liquid on the bottom of the vessel containing it is independent of the form of the vessel, may be demonstrated experimentally by means of the apparatus represented in Fig. 220, which was invented by Haldat, and is known by his name. It consists of a bent glass tube, ABC , at one end of which, A , is a brass cap, to which may be screwed either of the glass vessels M and P . There is also a cock by which the liquid in the vessel may be drawn off. In order to make the experiment, we fill the bent tube with mercury, and then screw into its place the larger of the two vessels, which we fill with water. This presses up the mercury in the branch C , and we mark the level to which it rises by means of the ring a . We also mark the level of the water in the vessel by means of the index-rod c , which we push down until it just touches the surface. We then draw off the water, and, having replaced the vessel M by the smaller vessel P , we fill this with water to the same height as marked by the index, when we find that the mercury rises in the branch C to precisely the same level as before. As the effect produced by the pressure of the water in the two cases is the same, we have a right to conclude that the two pressures are equal. This pres-

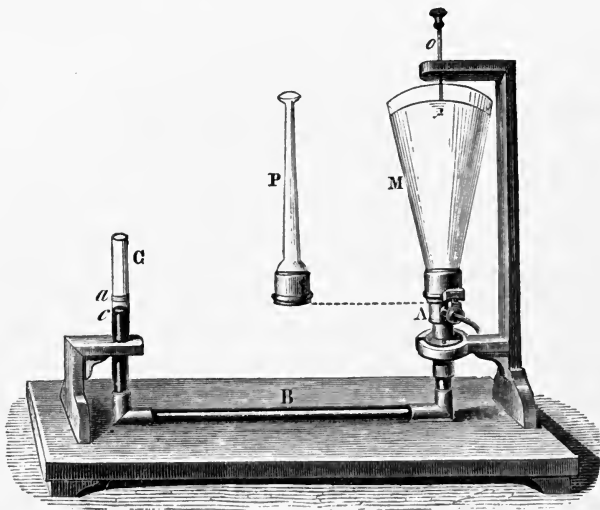

Fig. 220.

sure, then, is independent of the form of the vessel or of the quantity of water ; and, since the base of the vessel is the same in both cases, (that is, the surface of the mercury in the tube *A*,) and the height of the liquid also the same, it is evident that the equality of pressure is a necessary result of the principle before proved.

(124.) *Upward Pressure.* — If we consider any given section of liquid, as *p n*, Fig. 219, it is evident that the particles on this section are compressed by the weight of the liquid above them, and hence must be exerting pressure in every direction, and just as much upward pressure as downward pressure. If, then, we immerse in the liquid a cylindrical body, such as *c d*, Fig. 221, it is plain that the particles of water in contact with the base, *d*, of the cylinder, being in a compressed condition, must exert an upward pressure on the base of the cylinder equal to the pressure they exert on the section of liquid next below them. This

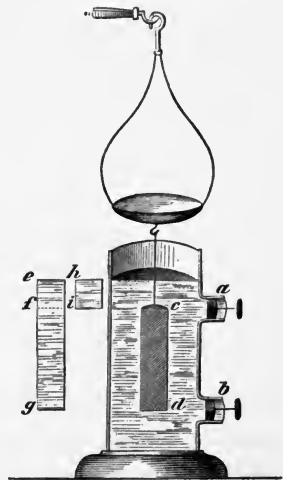

Fig. 221.

pressure, by the last section, is equal to the weight of a column of liquid having the same base as the cylinder, and having a height equal to the depth of the section below the surface of the liquid.

(125.) *Pressure on the Sides of a Vessel.* — This same course of reasoning may also be extended to the pressure exerted by a liquid against the sides of the containing vessel. It is evident, for example, that the particles of the liquid in contact with the

piston *b*, Fig. 221, are in a state of tension caused by the pressure of the weight of liquid above them. They are therefore exerting pressure in all directions, and hence also against the surface of the piston in directions which are perpendicular to that surface. Now the pressure of any one particle is, by the principle of (123), equal to the weight of a column of similar particles whose height is equal to the depth of this particle below the surface. And since the total pressure against the piston is equal to the sum of the pressures of the separate particles, it follows that *the total pressure is equal to the weight of a*

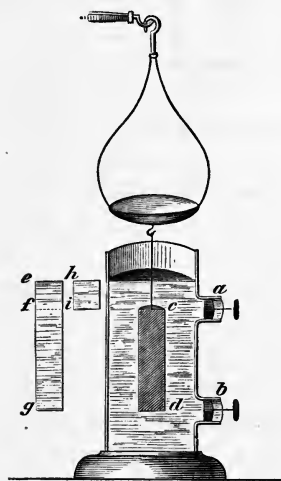

Fig. 221.

column of liquid, the area of whose base is equal to the area of the surface of the piston, and whose height is equal to the mean depth of the various particles below the surface. This mean depth, in the example under consideration, is evidently the depth of the centre of the piston, and hence *e g* is a column of liquid whose weight is equal to the pressure. In the same way, the pressure against the piston *a* is equal to the column represented by *h i*.

It is easy to extend this demonstration to any portion of the sides of a vessel, whether plane or curved. It can also easily be proved that the mean depth of the various particles of liquid in contact with any surface is in every case equal to the depth of the centre of gravity of these particles.

Were the pressure exerted by each of the particles of water in contact with the piston (Fig. 221) the same, the centre of pressure (121) would, as in Fig. 215, coincide with the centre or

figure. This, however, is not the case; the particles below the level of the centre of the piston, being at a greater depth, exert a greater pressure than those above this level. Hence the point of application of the parallel forces which they exert, (being nearest to the greater forces [20],) must be below the centre of figure. In any similar case, the position of the centre of pressure is below the centre of gravity of the particles composing the section against which the pressure is exerted, and it can always be found by calculation when the form of the surface is known.

(126.) *Generalization.* — The separate results at which we have arrived in the last three sections may be generalized as follows: *The pressure exerted by a liquid on any section whatsoever is equal to the weight of a column of the liquid, the area of whose base is equal to the area of the section, and whose height is equal to the depth of the centre of gravity of the section below the surface of the liquid.*

(127.) *The pressures exerted by two liquids on equal sections at equal depths are proportional to the specific gravities of these liquids.* It follows, from the last section, that the two pressures are equal to the weights of equal columns — and hence of equal volumes — of the two liquids. But it follows from (69), that the weights of equal volumes of two liquids are to each other as their specific gravities, and hence the pressures exerted by them on equal sections at equal depths must be in the same proportion.

If we represent by S the area of any section in square centimetres, by H the depth of the centre of gravity in centimetres, we have, by geometry, for the volume of the column of liquid whose weight represents the pressure, $V = H \cdot S$, in which V stands for a certain number of cubic centimetres. But we know by [56], that $W = V \cdot \text{Sp. Gr.}$, and hence, if we represent the pressure exerted on any section by \mathcal{F} , we have

$$\mathcal{F} = W = H \cdot S \cdot (\text{Sp. Gr.}) \quad [78.]$$

For any other section, having the same area and at the same depth, we have

$$\mathcal{F}' = H \cdot S \cdot (\text{Sp. Gr.})'; \quad [79.]$$

and, comparing,

$$\mathcal{F} : \mathcal{F}' = (\text{Sp. Gr.}) : (\text{Sp. Gr.})'. \quad [80.]$$

(128.) *Hydrostatic Paradox.*—It is evident from (123), that the pressure of a liquid on the bottom of the containing vessel

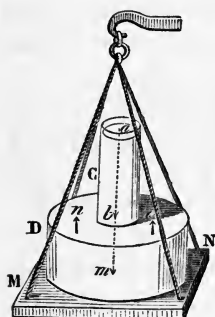

Fig. 222.

may be very much greater than the weight of liquid it contains. For example, the pressure of the liquid on the bottom of the vessel *D C*, Fig. 222, is the same as if its diameter were equal throughout to that of the lower part; and from this it would seem to follow, that, if the vessel were placed in the pan of a balance, *M N*, it ought to produce the same effect as a cylindrical vessel of the same weight, containing the same height of water, and having throughout the diameter of the part *D*. But it has

been shown, that the liquid presses on the walls *n o* as well as on the bottom, and, since this pressure is in an upward direction, it will tend to make the vessel rise, while the pressure on the bottom tends to make it fall. The difference of these two pressures is all that is exerted on the pan of the balance, and this in every case is just equal to the weight of the vessel and that of the liquid which it contains.

This fact is usually called the *Hydrostatic Paradox*. It is, however, evidently no paradox, but only a necessary consequence of the mechanical condition of liquid matter.

Equilibrium of Liquids.

(129.) In order that there should be a condition of equilibrium in a liquid mass, it is essential that each particle of the liquid should be pressed on all sides equally. This principle—the first statement of which is attributed to Archimedes—is a necessary consequence of the mobility of liquid particles. For, suppose that any one particle were not pressed on all sides equally, it is evident that, being free to move, it must move in the direction of the greatest pressure, and there would not be an equilibrium (28).

When a liquid mass under the influence of gravity is supported in a vessel, it is essential, in order that each particle may be pressed on all sides equally (in other words, in order that there may be a condition of equilibrium), that two conditions should be fulfilled, which we will now consider.

1. *The surface of the liquid must be perpendicular at each point to the direction of gravity; that is to say, it must be horizontal.*

To prove this, let us suppose that the surface of the liquid has any other form, as in Fig. 223. It is then evident, that the force of gravity acting on any particle, m , and represented by the line mp (31), will be decomposed into two others (35). One of these, represented by mq , is normal to the surface at the point m , and, being balanced by the resistance of the fluid particles, would not cause motion. The second component is tangent to the surface, and, not being balanced, tends to move the particles in the direction mf . Hence, under these circumstances, there could not be an equilibrium. If, however, the surface is horizontal, the tendency of the force of gravity is solely to sink the particles under the surface, and since all the particles at the surface are solicited equally by this force, the equilibrium is maintained.

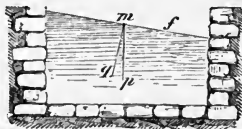

Fig. 223.

It follows from this, that the surface of still water is horizontal when its extent is so limited that we can regard the directions of the forces of gravity as all parallel (44). Such is not, however, the case with the surface of the ocean when at rest, or of a large sea. For since this surface must be perpendicular at every point to the *plumb-line*, and since all plumb-lines, if extended, pass approximatively through the centre of the earth, it follows that the surface must be sensibly spherical (60).

The principle just illustrated is only a particular case of a more extended principle, which may be thus stated: —

When a liquid mass is in equilibrium, the resultant of all the forces acting at any point of its surface is normal to the surface at that point.

2. *The pressure must be equal over the whole surface of any horizontal section.* The necessity of this condition is easily shown. For suppose this not to be the case, then there must be somewhere on the same horizontal section — for example, pn , Fig. 219 — two adjacent particles which are not equally pressed by the superincumbent liquid. But two such particles must exert, in consequence of their elasticity, an unequal pressure on each other, a condition which is evidently not consistent with a state of equilibrium.

At the surface of a liquid the pressure must be everywhere zero, and hence, in a state of equilibrium, the surface must be horizontal; so that the first condition may be regarded as a special case of the last.

This condition is also a particular case of a general principle, which may be thus stated:—

Any liquid mass in equilibrium may be regarded as consisting of an infinite number of laminae, normal at each point of their surface to the resultant of all the forces which act at this point, and sustaining at every point exactly the same pressure.

It is a consequence of this principle, that any liquid mass, which is not acted upon by external forces, will take the form of a sphere in consequence of the mutual attraction of its own particles. In this case, the infinitely thin laminae are concentric spherical surfaces, and the resultant of all the forces acting on any particle in every case passes through the centre of the sphere, and is normal to the spherical surface on which the point is situated. By no other form than the sphere would the conditions of equilibrium be satisfied.

Observation confirms this result of theory. Drops of water or mercury, so small as not to be sensibly deformed by their own weight, take a spherical form when placed on surfaces they do not wet. The rain-drop also is spherical, and in like manner the drops of melted lead become spherical while falling in the shot-towers. But the theory is still more beautifully illustrated by an experiment devised by Plateau.

By mixing alcohol and water, a liquid can be obtained having the same density as oil. If, now, we add drops of oil to the liquid, these drops, as we shall soon see, are in the same condition as if they had no weight, and in conformity with the theory take a spherical form. By carefully introducing the oil, a sphere of considerable size can be formed, suspended in the alcoholic fluid. Plateau succeeded in giving to this liquid sphere a rotation by means of very simple machinery, and found that, by regulating the velocity, he could cause it to become flattened at the poles, to throw off rings and satellites, and thus in various ways illustrate the nebular hypothesis of Laplace.

(130.) *A liquid when in equilibrium always maintains the same level in vessels communicating with each other.*— This familiar fact is illustrated by Fig. 224, which represents four ves-

sels, *A*, *B*, *C*, *D*, communicating through the tube *mn*, in all of which the liquid stands at the same level. That this must necessarily be the case, is easily shown. Consider any vertical section in the tube *mn*, separating the liquid in *D* from that in *C*, and let us denote the area of its surface by *S*. Now it is evident that this section can be in equilibrium only when the pressures on its two faces are equal. The pressure on the face towards *D* is, by [78], $\mathcal{F} = S \cdot H \cdot (\text{Sp. Gr.})$, in which *H* is the depth of the centre of gravity of the section below the level of the liquid in *D*. The pressure on the face towards *C* is, in like manner, $\mathcal{F} = S \cdot H' \cdot (\text{Sp. Gr.})$, in which *H'* equals the depth of the centre of gravity below the level of the liquid in *C*. Since these two pressures are equal when there is an equilibrium, it follows that $H = H'$, which demonstrates the principle in question.

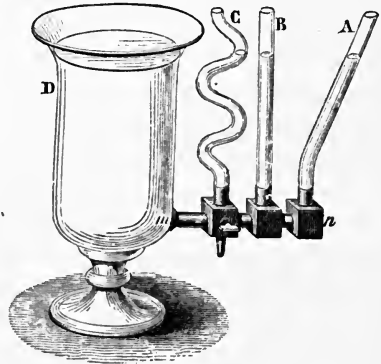

Fig. 224.

(131.) When two vessels communicating together are filled with different liquids, which will not mix or combine chemically with each other, the heights of the two liquid columns when in equilibrium are inversely proportional to the specific gravities of the liquids. This principle may be illustrated by means of the apparatus represented in Fig. 225. It consists of two tubes, *m* and *n*, connected together by a smaller tube below. The lower portion of both tubes is filled with mercury, and on the surface of the mercury in the tube *n* rests a column of water, *AB*. If now we conceive a horizontal line, *BC*, drawn across the apparatus from the surface of the mercury at *B*, it is evident, from the

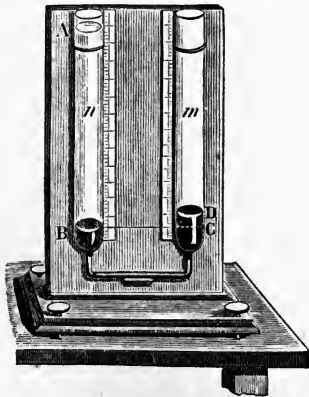

Fig. 225.

last section, that the liquid below this line is in equilibrium; and hence it follows, that the column of water BA is just balanced by the column of mercury DC . On measuring these two heights, it will be found that DC is thirteen and a half times smaller than AB ; and by referring to the table of specific gravities, it will be found that the specific gravity of mercury is thirteen and a half times greater than that of water; or, in other words, the heights are inversely proportional to the specific gravities.

The truth of this principle can easily be proved. If we represent the surface of the mercury at B by S , and the height of the column of water BA by H , the specific gravity of water by *Sp. Gr.*, then by [78] the pressure on the surface is $\mathcal{F} = S \cdot H \cdot (\text{Sp. Gr.})$. In the same way, the pressure of the column of mercury, CD , is $\mathcal{F}' = S' \cdot H' \cdot (\text{Sp. Gr.})'$, where S' is the area of the section at C , H' the height of the column CD , and $(\text{Sp. Gr.})'$ the specific gravity of the mercury. Now, it follows from (120), that there can be an equilibrium only when the pressures exerted on the two surfaces at B and C are proportional to the area of these surfaces, or when $\mathcal{F} : \mathcal{F}' = S : S'$. Substituting the value of \mathcal{F} and \mathcal{F}' , we find that when this is the case,

$$H \cdot (\text{Sp. Gr.}) = H' \cdot (\text{Sp. Gr.})', \quad [81.]$$

or

$$H : H' = (\text{Sp. Gr.})' : (\text{Sp. Gr.}).$$

Hence, there can be an equilibrium only where the heights of the two columns are inversely as the specific gravities of the liquids.

(132.) *Spirit-Level.* — We have seen that the surface of a liquid at rest is always horizontal, that is to say, perpendicular to

the direction of gravity.

We have, therefore, in this fact a ready means of determining the horizontal plane. The spirit-level, which is used for this purpose, consists of a tube of glass (Fig. 226) very slightly curved, and filled with alcohol,* leaving only a



Fig. 226.

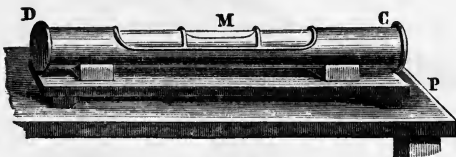

Fig. 227.

* Alcohol does not freeze even at the lowest temperatures.

small bulb of air, which always tends to occupy the highest part. The tube is hermetically sealed, and mounted on a brass or wooden stand, *D C*, Fig. 227, the base of which is carefully adjusted, so that when it rests on a horizontal plane, *P*, the air-bubble, *M*, shall rest just at the middle of the tube.

(133.) *Artesian Wells*. — The tendency of water to seek its own level is illustrated by all seas, lakes, springs, and rivers, which are so many vessels connecting with each other. One of the most remarkable of this class of illustrations is the Artesian well, named from the old province of Artois, in France, where these wells were first made. They are narrow tubes sunk in the earth to various depths, in which the water frequently rises many feet above the surface of the ground.

The principle of the Artesian well is illustrated by Fig. 228. The crust of our globe is formed of numerous strata, some

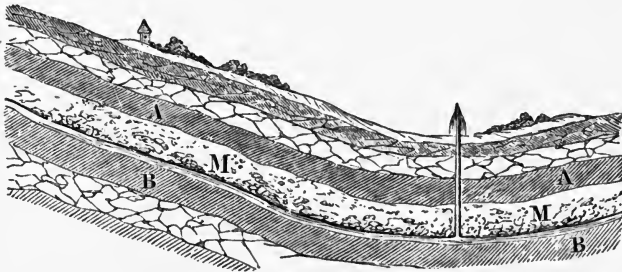

Fig. 228.

of which are permeable to water, like sand and gravel, while others, such as clay, are impermeable. Let us suppose, then, that in a geological basin we have an alternation of such strata, for example, two beds of clay-rock, *A* and *B*, enclosing a bed of some permeable material, *M*, as sand; and let us also suppose that the sand bed comes to the surface at some higher level (Fig. 229), where it will receive the rain-water. This water will filter through the sand and collect under the geographical basin, without being able to rise to the surface, on account of the clay bed *A*. But if we sink a tube through this bed, it is evident



Fig. 229.

that the water will rise to a height as much above the soil as is the level at which it stands in the peculiar reservoir formed by the clay beds.

These wells are sunk with a peculiar form of auger, which is worked within an iron tube, the tube being driven down as fast as the auger descends. One of the most remarkable of these wells is that of Grenelle, on the outskirts of Paris. It is 548 metres deep, and yields 3,000 litres of water each minute. The water has a constant temperature of 27° C.

(134.) *Salt Wells.* — An illustration of the principles of section (131) is furnished by the mode in which salt wells are worked in some parts of Germany. It not unfrequently happens, that beds of rock-salt occur in the midst of impermeable strata (see Fig. 230). It can then be extracted

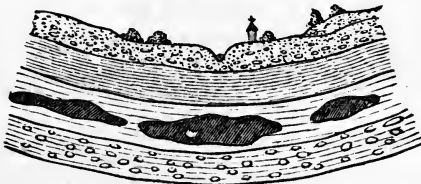

Fig. 230.

in the following way. An Artesian well (Fig. 231) is first sunk to about the middle of the bed. Within this well is enclosed a smaller tube of copper, descending to the bottom of the bed of salt, and therefore considerably lower than the iron tube forming the sides of the well. The lower end of the copper tube is closed, but it is perforated with little holes to the height of a few metres, which allow the water, but not dirt, to enter. From some convenient source fresh water is made to flow into the well, and descends outside of the copper tube to the salt bed. It

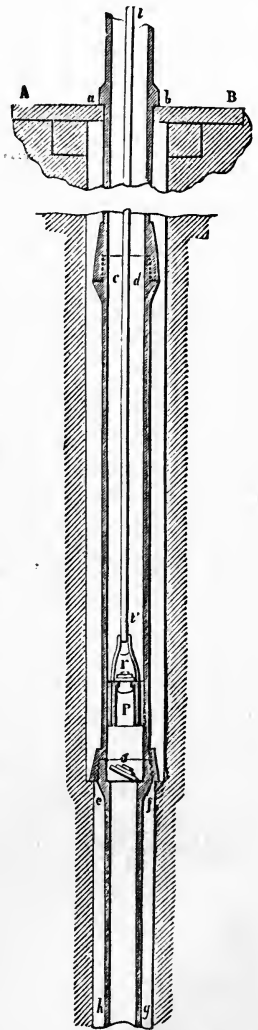

Fig. 231.

dissolves the salt, and the heavy brine sinks to the bottom of the bed, where it finds the lower end of the copper tube. This tube then fills with salt water; but the brine does not rise to the surface of the soil, but only to such a level that the column of brine in the interior copper tube shall be in equilibrium with that of water in the annular space outside. The specific gravity of saturated brine is about 1.20, that of water being 1; hence, if we represent the heights of the two columns by H and H' , we shall have $H : H' = 1.20 : 1$. If, then, the depth of the well is 200 metres, the brine will rise $\frac{1.00}{1.20} \cdot 200 = 166$, and consequently to a level 34 m. below the surface of the soil. Through this distance it is raised by a pump.

Buoyancy of Liquids.

(135.) *Principle of Archimedes.* — *All liquids buoy up solids immersed in them with a force equal to the weight of the liquid displaced.* This very important fact was discovered by Archimedes, and is generally known under the name of the *Principle of Archimedes*. It is generally stated that the discovery was made by this renowned philosopher of antiquity while reflecting on the buoyancy of the water on his own body when he was bathing; and he is said to have been so much elated by the discovery, that he rushed from the bath through the streets of Syracuse, exclaiming, *Εύρηκα! εύρηκα!*

The principle of Archimedes may be illustrated by means of the apparatus represented in Fig. 232. The brass cylinder B is made so as to fit accurately the brass cup A . In experimenting with the apparatus, the cylinder and cup, having been suspended to one pan of a balance arranged for the purpose, are carefully poised, by placing weights in the opposite pan; the cylinder is then immersed in water, as represented in the figure. In consequence of the buoyancy of the liquid, the pan containing the weights will preponderate. According to the principle, this buoyancy is equal to the weight of the water which the cylinder has displaced. But from the construction of the apparatus, the cup A will hold exactly this amount of water; and hence, if the principle is correct, the equilibrium will be restored on filling the cup A with water, — and this we find to be the case. The same result would also be obtained with alcohol, or with any other liquid.

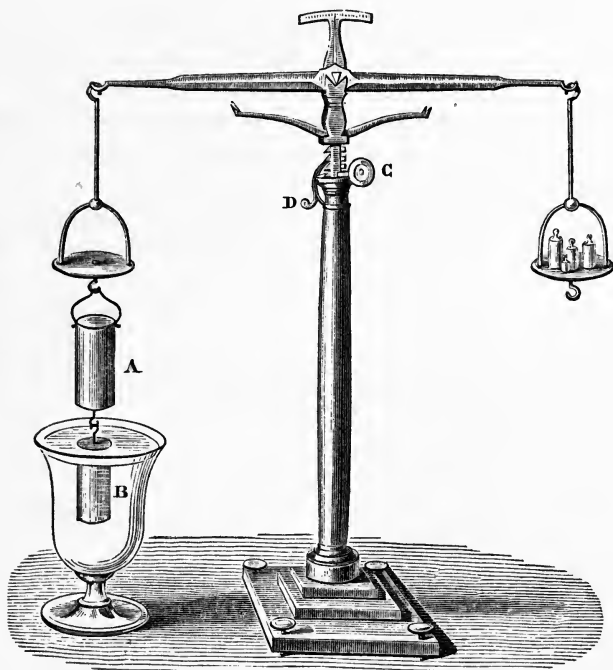

Fig. 232.

It appears, then, that the cylinder is buoyed up by a force equal to the weight of the liquid which it displaces. But this

statement expresses only one half of the truth ; for it is a necessary result of the equality of action and reaction, that the upward pressure of the water on the cylinder must be accompanied by an equivalent downward pressure of the cylinder on the water ; or, in other words, not only that the cylinder loses in weight, but also that the water gains the weight which the cylinder loses. In order to illustrate this fact, we can

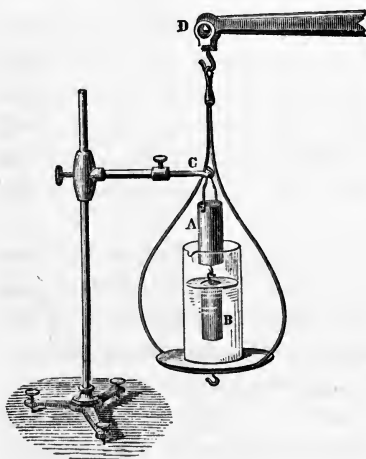

Fig. 233.

arrange the experiment as represented in Fig. 233. We first balance the vessel of water, and then immerse in the liquid the brass cylinder, supported as represented in the figure. The water will be found to have *gained* in weight, and in order to restore the equilibrium it will be necessary to remove from the vessel sufficient water to just fill the cylinder *A*.

(136.) *Demonstration.* — The principle of Archimedes is a necessary consequence of the law enunciated in (126), as can easily be proved. Let us, in the first place, suppose that the body immersed in the liquid is a right cylinder, as *cd*, Fig. 234, suspended so that its bases shall be horizontal. Consider now the pressure exerted by the liquid at any one point on the side of this cylinder. By (121) the direction of this pressure is normal to the surface at this point. But, as is well known, this normal, if produced, will coincide with the diameter of the circular section of the cylinder which would be made by a horizontal plane cutting the cylinder at the point in question. Now, as the other end of this diameter is in contact with the liquid, and at the same depth below its surface, it is evident that this point will sustain a pressure equal in amount and opposite in direction to that sustained by the first point. These two pressures will consequently balance each other, and, since the same holds true of every other similar point, it follows that the whole pressure of the liquid on the convex surface of the cylinder is in equilibrium.

It is different, however, with the pressure on the two horizontal bases. The pressure exerted on the base *d* is, by (126), equal to the weight of the liquid cylinder represented by *eg*, and the pressure on the base *c* to the weight of the liquid cylinder *hi*. There is, therefore, an excess of upward pressure equal to the weight of the liquid cylinder *fg*, which is equal in size to the cylinder *cd*. The cylinder, then, is buoyed up with a force equal to the weight of liquid displaced.

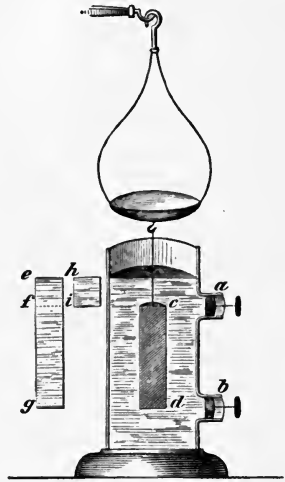

Fig. 234.

(137.) This demonstration may readily be extended to a body of any form whatsoever. Let $s s' s''$ be the body, and $o x, o y, o z$ three co-ordinate axes perpendicular with each other, to which we can refer position. The pressure exerted by a liquid on any

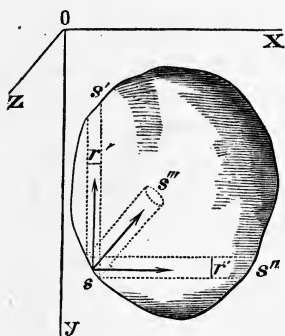

Fig. 235.

infinitely small element of surface, s , is by [78] $\mathcal{F} = s \cdot H \cdot (\text{Sp. Gr.})$. This pressure, which by (121) is normal to the surface, may be resolved into three forces, at right angles to each other and parallel to the co-ordinate axes. Representing the normal by p , and the angles which it makes with x, y, z , as $\frac{p}{x}, \frac{p}{y}, \frac{p}{z}$, we have, for the three components, $\mathcal{F}' = \mathcal{F} \cos \frac{p}{x}$, $\mathcal{F}'' = \mathcal{F} \cos \frac{p}{y}$, and $\mathcal{F}''' = \mathcal{F} \cos \frac{p}{z}$. Substituting for

\mathcal{F} its value given above, the three components become

$$\mathcal{F}' = H \cdot (\text{Sp. Gr.}) \cdot s \cos \frac{p}{x}; \quad [82.]$$

$$\mathcal{F}'' = H \cdot (\text{Sp. Gr.}) \cdot s \cos \frac{p}{y}; \quad [83.]$$

$$\mathcal{F}''' = H \cdot (\text{Sp. Gr.}) \cdot s \cos \frac{p}{z}. \quad [84.]$$

But $s \cos \frac{p}{x}$ is the projection of the surface s on the plane of $y z$, and this projection is equal to the right section of an infinitely small cylinder parallel to the axis of x . Representing the area of this section by r'' , we have, for the value of the first component, $\mathcal{F}' = H \cdot (\text{Sp. Gr.}) \cdot r''$. But this pressure will obviously be balanced by the pressure exerted on the element of surface, s'' , which, decomposed in the same way, will give a component also equal to $H \cdot (\text{Sp. Gr.}) \cdot r''$, and parallel to the axis of x , but acting in the opposite direction. It can easily be shown that the same is true of the component parallel to the axis of z . This will be balanced by an opposite and equal component of the pressure exerted on the element s''' . Let us, lastly, consider what will be the effect of the component parallel to the axis of y . In the value of \mathcal{F}'' [83], the quantity of $s \cos \frac{p}{y}$ is the projection of the surface s on the plane of $x z$. This projection is equal to the right section of the vertical cylinder $s s'$.

Representing the area of this section by r' , we have, for the value of the vertical component, $\mathcal{F}'' = H (\text{Sp. Gr.}) r'$, a force which tends to raise the body. This force is in part balanced by the pressure exerted on the element s' . By decomposing this force, it will be found that the vertical component which exerts a downward pressure in the direction $s' s$, is equal to $\mathcal{F}_2 = H' (\text{Sp. Gr.}) r'$. The vertical cylinder of the body $s' s$ is then buoyed up by a force equal to the difference of these two values, that is, $\mathcal{F}'' - \mathcal{F}_2 = (H - H') (\text{Sp. Gr.}) r'$, which is the weight of a column of liquid of the same volume as the cylinder.

By extending the same course of reasoning to each of the infinitely small elements of surface which the body presents, we should decompose the body into an infinite number of vertical cylinders similar to $s' s$, each of which is buoyed up by a force equal to the weight of its own volume of liquid. The whole body is of course buoyed up by a force equal to the sum of the forces acting on the elementary cylinders, that is, by a force equal to the weight of the liquid which it displaces.

(138.) The correctness of the principle of Archimedes can be proved in another way, which more directly connects it with the condition of equilibrium which exists among the particles of all liquids when at rest. Consider, for example, any cubic centimetre of the liquid contained in the vessel, Fig. 236, such as $A B$. Since the liquid is at rest, it is evident that this liquid cube is exactly sustained in its position by the pressure of the surrounding particles. But the mass of liquid, of which it consists, has weight; and it is therefore also evident, that the liquid cube is sustained because it is buoyed up by a force which is just equal to its weight. Let us now suppose the liquid cube to be suddenly solidified without changing its volume; it is evident that it will be buoyed up by the same force as before; for no change has taken place either in the position or the conditions of the surrounding particles. Whatever, therefore, may be the substance or weight of the solid cube, it will be buoyed up by a force equal to the weight of one cubic centimetre of the liquid in which it is immersed. This demonstration can evidently be extended to any other body, of whatsoever size or shape.

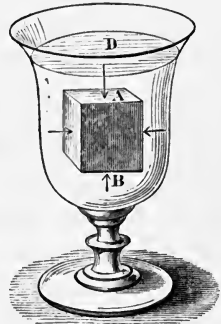

Fig. 236.

(139.) *Centre of Pressure.* — It has been proved (45), that the resultant of all the forces which gravity exerts on the particles of a body is a single force — represented by the weight of the body — directed vertically *downwards*. And it has further been proved (46), that this force may always be regarded as applied at the centre of gravity, whatever position the body may assume. Now, since the supposed liquid cube (Fig. 236) is exactly supported, it follows that the resultant of all the pressures which it receives from the surrounding particles of liquid must also be a single force equal to the weight of the cube, but directed vertically *upwards*. Moreover, if our ideal cube could be turned in the liquid, it would evidently still remain in equilibrium, in whatever position it might be placed. Since in all possible positions the resultant of the forces of gravity may be regarded as applied at the centre of gravity, it follows

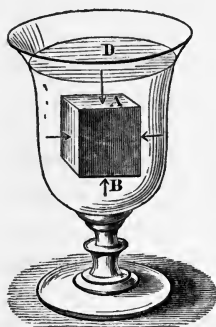

Fig. 236.

that in the different positions the resultant of all the pressures may also be regarded as applied at the same point. The same point, then, which is common to all the resultants of the forces of gravity in the different positions which a body may assume, is common, also, to all the resultants of pressure; in other words, the centre of gravity of our liquid cube is also the centre of pressure.

If, now, we replace the ideal cube of liquid with a cube of brass having the same size and volume, it is evident that the conditions of the particles exerting the pressure have not been changed. Hence the resultant of the pressures exerted by these particles will still be a force acting vertically upwards; and, further, in any position which the brass cube may assume, the direction of this resultant will pass through what would be the centre of gravity of a liquid cube of the same form and volume. This common point, through which the resultant of the pressure passes, in any position of the brass cube, is its *centre of pressure*. We have made use of a brass cube in this discussion, merely to give distinctness to our conceptions; but it is evident that the same reasoning would apply to a body of any shape whatsoever. In any case, *the centre of pressure is always the same point which*

was previously the centre of gravity of the liquid which has been displaced by the body.

If the body is homogeneous and entirely immersed in water, the centre of pressure coincides with the centre of gravity of the body. If, however, the body is not homogeneous, — if, for example, it is loaded on one side, — then the centre of gravity will no longer coincide with the centre of pressure; because it will not coincide with the centre of gravity of a liquid body of the same shape and volume.

(140.) *Floating Bodies.* — If the weight of a body is less than that of the liquid which it displaces, then, the buoyancy being greater than the weight, the body will rise to the surface of the liquid, and float. On the other hand, if the weight of a body is greater than that of the liquid which it displaces, it will sink. Moreover, since the specific gravities of any two substances are to each other as the weights of equal volumes of these substances, it is also true that a homogeneous solid will float when its specific gravity is less than that of the liquid, and that it will sink when these conditions are reversed.

An iron bar sinks in water, but floats in mercury, because a given volume of iron weighs less than the same volume of mercury, and more than the same volume of water. For a similar reason, a piece of boxwood will float in water, but sink in alcohol. The bar of iron, however, can be made into a hollow vessel, which will float on water; and, in the same manner, boxwood can be made to float on alcohol. The volumes of the bodies will thus be increased without increasing the weight, and since the weight of the liquid they displace is now greater than their own weight, they will float. Steamships are frequently made of iron, and loaded with heavy machinery; but nevertheless, since their whole weight is less than that of the water which they displace, they float. The specific gravity of the human body is very nearly the same as that of water, and can readily, therefore, by a little effort, be kept at the surface in the act of swimming. By increasing slightly the volume of water displaced, without increasing sensibly its weight, the body will float without effort. Most persons can expand the chest, by a little effort, sufficiently to make the specific gravity of the body less than that of water, and it is well known that good swimmers can float their bodies by lying back on the surface of the water and expanding the chest. This is

also the theory of life-preservers, which are bags filled with air, or pieces of cork worn under the arms. They so far increase the volume of the body as to make the specific gravity of the life-preserver and the body together, as a whole, less than that of water.

The large floating tanks, called *camels*, which are used to lift large vessels over the sand-bars that obstruct the mouths of many harbors, are an ingenious application of the same principle. These tanks, which are closed on all sides and water-tight, having been filled with water, are fastened under the sides of the vessel. The water is then pumped out, when the tanks rise, and raise the vessel with them. A similar contrivance, called a *floating dock*, is very much used in the United States for raising ships completely out of water, for repairs. It consists of a large platform, on which the ship is to rest, beneath which are hollow and water-tight tanks, so loaded that, when full of water, they will sink. The platform is, in the first place, sunk to the depth of several fathoms, and the ship to be raised is then floated over it. The water is now pumped out of the tanks beneath the platform, which then rises, and raises the vessel with it.

(141.) *Equilibrium of Floating Bodies.* — When a body is at rest, floating on the surface of a liquid, there must be an equilibrium between the weight of the body and the buoyancy of the liquid. Hence it follows, from (135), that *the weight of the liquid actually displaced by a floating body is equal to its own weight.* We can always determine the weight of a ship by measuring the volume which is below the water-level, and multiplying this by the specific gravity of the liquid. This will, by [56], give the weight of water displaced, which, as we have just seen, is the same as the weight of the ship. We can also determine the weight of the cargo by determining the volume of water displaced by the ship both before and after loading. The difference between these two volumes, multiplied by the specific gravity of the liquid, will give the weight of the cargo.

The centre of pressure of a floating body is, by (139), the same point as the centre of gravity of the fluid it displaces. It is obviously, therefore, an entirely different point from the centre of gravity of the body, and must always be below this point when the body is a homogeneous solid. For example, in Fig. 237, the centre of gravity of the homogeneous floating body *a b c d* is

the point G . The centre of pressure, P , is the centre of gravity of the liquid displaced, and this is obviously below the centre of gravity of the whole body. When the floating body is not homogeneous, the centre of gravity may be below the centre of pressure. For example, if we should attach to the bottom of the body $a b c d$ a piece of lead, this would sink the body still deeper in the water, and thus raise the centre of pressure, while at the same time it would lower the centre of gravity, and thus might change the relative position of the two points.

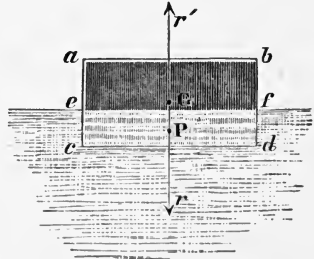

Fig. 237.

In order that a floating body should be in equilibrium, it is not only necessary that it should displace its own weight of liquid,

but it is also essential that the centres of gravity and pressure should be situated on the same vertical. If, as in Fig. 238, the two points are not situated on the same vertical, then the resultants of the forces of gravity and pressure will be represented by two opposite vertical forces, as Pq and Gr . Since these forces are equal, they will neither tend to

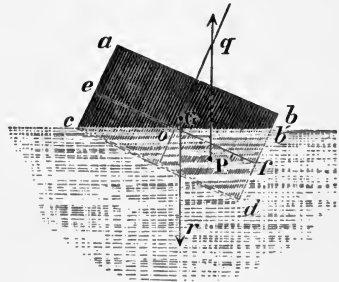

Fig. 238.

raise nor depress the body in the liquid; but nevertheless, as the two forces form a couple (38), they will tend to rotate the body. Hence, although the body will neither rise nor fall, it will turn in the liquid until the centre of pressure falls in the same vertical with the centre of gravity, but in such a way that the amount of water displaced by the body shall be always the same.

(142.) *Stable and Unstable Equilibrium.* — When the centres of pressure and gravity are in the same vertical, there will be a condition of equilibrium, but this equilibrium may be either *stable*, *unstable*, or *neutral*. The equilibrium is said to be *stable* when, on turning the floating body slightly in the water, it tends to return to its first position; it is said to be *unstable*, when, under these circumstances, it continues to turn until it passes

into a new condition of equilibrium; and it is said to be neutral, when it will remain at rest in any position indifferently.

The condition of a floating body is always stable when the centre of gravity is below the centre of pressure. The truth of this statement is an immediate consequence of the principles of the last section. The centre of pressure is a point at which the whole upward pressure of the liquid may be regarded as concentrated. It may therefore be considered as the point of support of the floating body; and it has already been shown (48), that the condition of a body is stable when the centre of gravity is below the point of support. It does not follow, however, that the condition is necessarily unstable when the centre of gravity is above the point of support. In this case, the stability of the body depends upon the position of a variable point, which is called the *metacentre*; and the equilibrium is still stable, when the centre of gravity is below this point. The position of the metacentre depends on the form and position of the body. We shall only be able to point out its position in the case of one of the simplest solids; but this example will serve to illustrate the general principle.

Let us suppose, then, that the floating body is a homogeneous rectangular prism (Fig. 239). The centre of gravity will then

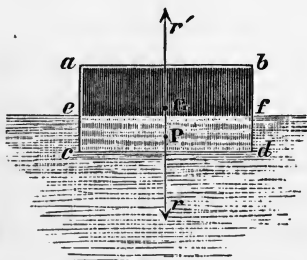

Fig 239.

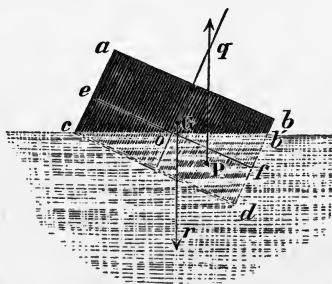

Fig. 240.

be the same as the centre of its figure, or G , and the centre of pressure the centre of gravity of the part immersed in the liquid, a variable point, depending on the position of the body. If, now, when it is floating on its broadest side, we turn it through the angle $e o c$ (Fig. 240), the portion represented by the triangle $e o c$ is raised out of the liquid, and that represented by $b' o f$ submerged; and since the quantity of water displaced must be the

same in every position of the body, it follows that the portion $e o c$ is equal to the portion $b' o f$. But now the form of the submerged portion is entirely changed, and the centre of gravity of the submerged portion, which is the centre of pressure, is also changed, and moved to the point P' . If in this position we draw through the point P' a perpendicular, it will intersect the perpendicular drawn through the point P in the previous position, namely, $O q$, at a point q , and this point is the *metacentre*. In the case before us, the metacentre is above the centre of gravity; and it is evident from the figures, that the couple formed by the resultants of the forces of gravity and of the pressure tends to restore the floating body to its first position (Fig. 239).

Let us now suppose that the rectangular prism is floating on its narrow side, as in Fig. 241; and that, as before, we turn it to

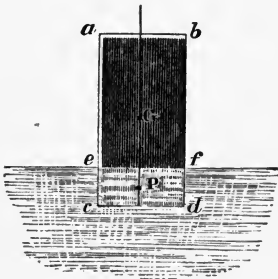

Fig. 241.

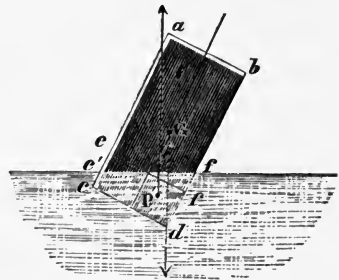

Fig. 242.

the right through a small angle. The centre of pressure will then be shifted to a new position, at the right of the plane of symmetry (Fig. 242). If, now, we erect a perpendicular, it will intersect the perpendicular drawn through the centre of pressure in the previous position, at a point q , below the centre of gravity; and it can easily be seen that the couple formed by the force of gravity and the pressure will tend to turn the body still further, and it will only come to rest when it falls back into the position of stable equilibrium, floating on its broad side, as in Fig. 239.

What has now been illustrated in the case of a rectangular prism, is true of all floating bodies. In general, the metacentre may be defined as *the point where the vertical passing through the centre of pressure in the position of equilibrium, meets the vertical drawn through the new centre of pressure after the body*

has been slightly displaced from this position. A floating body is in a stable condition when the metacentre is above the centre of gravity, and unstable when this condition of things is reversed. When the centre of gravity is below the centre of pressure, the metacentre must evidently always be above the centre of gravity, and, as before shown, this condition is always stable. It is also evident, from the above discussion, that the stability of a floating body is the greater the broader the submerged part and the lower the position of the centre of gravity.

It is of great importance to pay attention to the conditions of stable equilibrium in the construction and loading of ships. Vessels which are used to transport passengers or light cargoes require to be ballasted, by depositing immediately above the keel a quantity of heavy matter, such as stones or pigs of iron. The centre of gravity may thus be brought so low, as to give the vessel such stability that no lateral force of the wind acting on its sails can capsize it. So, also, the heaviest part of a cargo should always be deposited in the lowest possible position, in order that its centre of gravity may be immediately over the keel. When this is the case, any inclination of the vessel causes the centre of gravity to rise; and to accomplish this requires a force proportional to the weight of the vessel, and to the height through which the centre is elevated.

The equilibrium of a boat may be rendered unstable by the passengers standing up in it; and this is not unfrequently the cause of accidents to light sail-boats.

If the centre of gravity of a vessel be not directly over the keel, the vessel will incline to that side at which it is placed; and if this displacement is considerable, danger may ensue. The rolling of a vessel in a storm may so derange the ballast or cargo, as to throw the vessel on her beam-ends.

(143.) *Neutral Equilibrium.* — In some cases, the position of the centre of pressure is not changed by any change of position of the body which is compatible with displacing its own weight of fluid. In such a case, the body will float in equilibrium in any position indifferently, and is said to be in a condition of neutral equilibrium. A sphere of uniform density is an example of this; for in whatever position it floats, the part immersed is always a segment of the sphere of precisely the same magnitude and shape, so that the centre of pressure has always the same posi-

tion with reference to the centre of gravity of the sphere. Consequently, the sphere will float indifferently in any position in which it may be placed.

Methods of determining Specific Gravity.

(144.) The specific gravity of a substance has been defined as the ratio of its weight to that of an equal volume of pure water at 4° C., — the temperature at which the volume of the solid is measured being 0° C. As most of the methods used for determining specific gravity are illustrations of the principles of hydrostatics, we will briefly describe them in this connection, reserving, however, for the chapter on Weighing and Measuring, the practical details of the subject.

(145.) *First Method. Specific-Gravity Bottle.* — The most obvious method of determining the specific gravity of a substance is to weigh equal volumes of the substance and of water, and then divide the first weight by the last. When the substance is a liquid, this method is readily applied. We use for the purpose a small glass bottle, such as is represented in Fig. 243. The bottle is closed by a perforated ground-glass stopper of peculiar construction, terminating in a fine tube, on which is marked, with a file, a point to which the bottle is to be filled at each experiment. The bottle, whose tare has been previously ascertained, is first of all filled with pure water, and the stopper inserted, when the water rises in the glass tube. The excess of water above the mark is now removed with a piece of bibulous paper, and the bottle carefully weighed. By subtracting from this weight the tare of the bottle, we have the weight of a given volume of water, which is thus ascertained once for all. If, then, we wish to obtain the specific gravity of any other liquid, we fill the bottle with this liquid in the same way as before, and weigh it; then, having subtracted the weight of the bottle, we have the weight of a volume of this liquid equal to the volume of the water. Representing these two weights by W' and W , we have, by definition,



Fig. 243.

$$(\text{Sp. Gr.}) = \frac{W}{W'}$$

If we repeat this process at different temperatures, we obtain different results, owing to the expansion both of the liquids and of the glass. It is, therefore, essential to observe carefully the temperature of the liquids at the time of filling the bottle, and then to calculate, by means of tables prepared for the purpose, what would have been the result had the temperature of the water been at 4° C. and that of the substance at 0° C. This is called *reducing the results to the standard temperature*, and the method of making the reduction will be described in the chapter just referred to.

The specific-gravity bottle may also be applied to determining the specific gravity of solids, when they can be broken into small pieces. For this purpose, we take a specific-gravity bottle and determine the weight of the bottle when filled with water, as before described. Call this weight W_1 . We then introduce into the bottle a known weight of the solid, W , and fill up the remainder of the bottle with water. The weight of the bottle, solid and water, which we then ascertain, we will represent by W_2 . It is then evident that the weight of water displaced by the solid is $W' = W_1 + W - W_2$, and hence we have

$$(\text{Sp. Gr.}) = \frac{W}{W_1 + W - W_2}. \quad [86.]$$

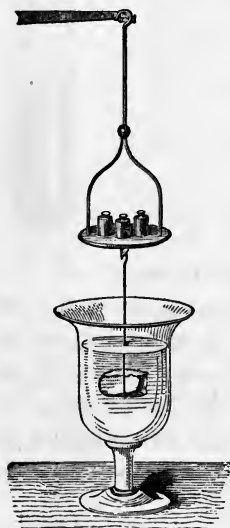

Fig. 244.

Here, as before, it is necessary to reduce the results obtained to the standard temperature.

(146.) *Second Method. The Hydrostatic Balance.*—We suspend the body by a fine thread to the pan of a balance (Fig. 244), and, having equipoised it by means of a tare in the other pan, immerse it in water, as represented in the figure. The weight which it loses, being exactly equal to that of the water which it displaces, is the weight of a volume of water equal to that of the body which we wish to find. Hence, in order to determine this weight, we have only to add weights to the pan from which the body is suspended, until the equilibrium is es-

tablished. It is evidently essential to the accuracy of this method, that the water used should be pure, and the thread so fine that we can, without sensible error, neglect the weight of water which it itself displaces.

Representing by W the weight of the body, and by W' the weight required to restore the equilibrium, we have, by definition,

$$(\text{Sp. Gr.}) = \frac{W}{W'}. \quad [87.]$$

The value thus obtained must be reduced to the standard temperature.

This method may also be applied to liquids as well as to solids. For this purpose we prepare a closed glass tube, and enclose in it sufficient mercury to sink the tube beneath any liquid, with the exception of the two heaviest, mercury and bromine. To this tube we attach a fine platinum wire, as in Fig. 245, which represents the apparatus of its full size. We commence by determining once for all, by the method just described, the weight of the volume of water at 4° C. which the glass tube displaces. This we may call C , as it is a constant quantity for each apparatus. In order, now, to determine the specific gravity of a liquid, we suspend the tube to the pan of a balance, and, having equi-
poised it by placing a weight, prepared for the purpose, in the other pan, immerse it in the liquid. The amount of weight required to restore the equilibrium is the weight of the volume of this liquid which the tube displaces, and the weight of the same volume of water at 4° C. is known to be C . Hence the specific gravity of the liquid is $\frac{W}{C}$. This value must be corrected for the temperature at which the experiment is made.



Fig. 245.

(147.) *Third Method. Hydrometers.* — In this method, the balance is not used, but its place is supplied by floating bodies of peculiar construction, called *hydrometers*. A few of these we will now describe. They may, for convenience, be divided into two classes, — Hydrometers with a Constant Volume, and Hydrometers with a Constant Weight.

HYDROMETERS WITH A CONSTANT VOLUME.

1. *Nicholson's Hydrometer.* — This instrument is represented in Fig. 246. It consists of a hollow, cylindrical vessel, *B*, made usually of sheet brass or tinned iron. To the lower end of this vessel is fastened a cone filled with lead, *C*, the base of which forms a pan on which the body whose specific gravity is to be determined is placed. The object of the lead is to load the apparatus so that the centre of gravity may be below the centre of pressure, which, as we have seen (142), is a condition of stable equilibrium. To the top of the vessel is fastened a wire, which supports the pan *A*, and on this wire is marked a fixed point, *o*.

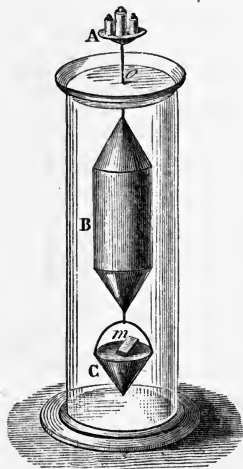

Fig. 246.

In using this apparatus, we commence by determining the weight which, placed in the pan *A*, will sink the hydrometer to the fixed point *o*. This is a constant quantity for the same apparatus, and may be represented by *C*. Let us suppose that in any given case it is 125 grammes, and that it is required to determine the specific gravity of sulphur. We take a piece of sulphur, weighing less than 125 grammes, and place it on the pan *A*, and then add weights until the hydrometer sinks again to the fixed point *o*. If it requires 55 grammes to sink it to the fixed point, it is evident that the weight of the sulphur is $125 - 55 = 70$ grammes. Having determined the weight of the sulphur in the air, it only remains to determine the weight of an equal volume of water. For this purpose, we raise the hydrometer, and, without disturbing the weights, shift the piece of sulphur to the pan *C*, and replace the instrument in the water. It will not, of course, sink to the fixed point; because the piece of sulphur, which is now submerged, is buoyed up by a force equal to the weight of its volume of water. If, now, we add weights to the pan *A*, until the hydrometer again sinks to the point *o*, we shall find that 34.4 grammes are required. This is then the weight of its volume of water, and the specific gravity is $\frac{70}{34.4} = 2.03$. Representing the successive

weights described above by C , W , and W' , we have in every case (*Sp. Gr.*) = $\frac{C - W}{W'}$. If the instrument is to be used for substances lighter than water, a perforated cover is adapted to the pan C , to prevent them from rising to the surface of the liquid.

2. *Fahrenheit's Hydrometer.* — This instrument (Fig. 247) is used for determining the specific gravity of liquid, and differs from the one just described only in being made of glass, and in having no lower pan. In using this instrument, we commence by weighing it in a balance. Let us call its weight C . Then, having placed it in water, we determine the amount of weight required to sink it to a fixed point, marked on the stem, which we will represent by c . The sum of these constant weights, or $C + c$, is, by (141), equal to the weight of the water displaced. We then float the hydrometer in the liquid whose specific gravity we wish to find, and determine the weight required to sink it in this liquid to the fixed point. Call this weight W . Then $C + W$ is equal to the weight of the liquid displaced, and since $C + c$ and $C + W$ are the weights of the same volumes of water and the liquid, the specific gravity of the liquid is easily found; since



Fig. 247.

$$(\text{Sp. Gr.}) = \frac{C + W}{C + c}. \quad [88.]$$

HYDROMETERS WITH A CONSTANT WEIGHT.

In the two hydrometers just described, the volume of the instrument, which is submerged, remains constant during the experiment, and the specific gravity is determined from the amount of weight required to keep the volume constant under different circumstances. The hydrometers in most general use are constructed on a different principle. In these the weight is constant, and the specific gravity of a liquid is determined by measuring the volume of this liquid which the instrument displaces when floating in it. The weight of this volume is, by (141), the same as the weight of the instrument. If, then, we represent by V' the volume of water which the instrument displaces when floating in this liquid, and by V the volume of any

other liquid which it displaces, it is evident that the volumes V and V' of the two liquids have the same weight, namely, that of the hydrometer. But it follows from [56], that when the weights of different volumes of two liquids are equal, $V \cdot (\text{Sp. Gr.}) = V' \cdot (\text{Sp. Gr.})'$. When one of the liquids is water, $(\text{Sp. Gr.})' = 1$, and we obtain, for the specific gravity of the other liquid,

$$(\text{Sp. Gr.}) = \frac{V'}{V}. \quad [89.]$$

From this it appears, that, when we know the volumes of equal weights of water and any given liquid, we can find the specific gravity of the liquid by dividing the volume of the water by the volume of the liquid.

3. *Gay-Lussac's Volumeter.* — This is the best instrument of its class. In its simplest form (Fig. 248), it consists of a glass

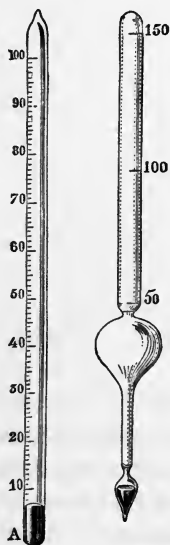

Fig. 248

Fig. 249.

tube closed at both ends, which is graduated into parts of equal capacity. The size of the parts is unimportant, it being only necessary that they should all be equal. The divisions are numbered from 1 to 100, or to 150, as the case may require, commencing at the lower end of the tube. Before the tube is finally closed, it is loaded with mercury, so that, when floating on water, it will sink to the 100th division on the scale; or, in other words, so that it will displace 100 measures of water. If, now, we float it on sulphuric acid, it will only sink to the 54th division. Hence 100 measures of water and 54 measures of sulphuric acid have the same weight, and the specific gravity of sulphuric acid is, therefore, $\frac{100}{54} = 1.85$. If we float the hydrometer on alcohol, it will sink to the 125th division. Hence the specific gravity of alcohol is $\frac{100}{125} = 0.80$. Since a definite specific grav-

ity corresponds to each of the divisions of the scale, it is usual to calculate these, and inscribe them on the scale in place of the simple numbers denoting the volume. The instrument, when so prepared, is generally called a *densimeter*. As there are no liquids which have a less specific gravity than 0.60, and only two (mercury and bromine) which have a greater specific

gravity than 2, it is evident that the divisions on the scale need only extend from 50 to 166. It is not usual, however, to have the whole scale on a single instrument, and, as a general rule, the scale is divided over three separate hydrometers. The first one, for liquids lighter than water, is graduated from 100 (corresponding to the specific gravity 1.00), near the middle of the tube, to 166 (corresponding to 0.60), at the top of the tube; the second, for saline solutions, is graduated from 100 (corresponding to 1.00), at the top of the tube, to 75 (corresponding to 1.33), near the middle; finally, the third instrument is graduated from 75 (corresponding to 1.33), at the top of the tube, to 50 (corresponding to 2.00), near the middle of the tube. In graduating each instrument, it is so loaded that it shall sink in water to the 100th division of the centesimal scale, and in all cases the specific gravities are subsequently calculated, and inscribed on the scale against each division.

It is more usual to give to the hydrometer the form represented in Fig. 249. This shortens the instrument very greatly, since the volume of the long tube in Fig. 248 is here replaced by a short bulb. The principle of the two forms of the instrument is precisely the same, but it is more difficult to graduate the second pattern. The easiest method is the following. If the instrument is to be used for liquids heavier than water, we first load it with mercury until it sinks to a point *A*, near the top of the tube, which we mark 100. We next float it in a liquid of known specific gravity, for example, 1.333, and it will sink to a point *B*. Now, by [85], $1.333 = \frac{100}{x}$, and $x = 75$. This division is, therefore, the 75th, and we divide the space between the two into 25 equal parts, and continue the divisions of the same size to the base of the stem. Each of these divisions will then be $\frac{1}{100}$ of the whole volume of the apparatus below the 100th division first marked at *A*. If the instrument is to be used for liquids lighter than water, we adjust it so that the 100th division shall be at the base of the stem, and then, by floating the instrument in alcohol of known specific gravity, determine a higher point, and then divide the stem as before.

4. *Baume's Hydrometer*. — This hydrometer belongs to the same class with that of Gay-Lussac, but it is graduated in a manner which is entirely arbitrary, and does not indicate the specific gravity of the liquid. There are two methods used in graduat-

ing it, according as it is to be used for liquids heavier or lighter than water. In the first case, it is loaded so that it will sink in water to a point *A*, near the top of the stem, which we mark 0° . A second point is now obtained by floating the instrument in a solution of fifteen parts of common salt in eighty-five parts of water. This solution having a greater specific gravity than pure water, the instrument rises until the level of the liquid stands at a point *B*, which we mark 15° . Lastly, we divide the distance



Fig. 250.

between *A* and *B* into fifteen equal parts, and continue the divisions to the bottom of the stem of the same size as one of these parts. It is essential that the diameter of the stem should be the same throughout. This instrument is called *Pèse-Sels*. To prepare a hydrometer for liquids lighter than water, Baume floated the hydrometer in a solution of ninety parts of water and ten parts of common salt, and marked the point to which it sank as 0° . He next floated the instrument in water, and marked this point 10° . The interval between these points he divided into ten equal parts, and continued the divisions of the same size to the top of the tube. This instrument is

called *Pèse-Liqueurs*. Although the graduation of Baume is entirely arbitrary, yet this hydrometer is in more general use than any other. It is principally used for determining when a solution or an acid has reached the proper degree of concentration. For example, it has been found by experiment, that in a well-manufactured syrup the *pèse-sels* of Baume stands at 35° when the liquid is cold, and also that in the strongest sulphuric acid it stands at 66° ; so that the instrument enables the manufacturer to tell when his syrup or acid has reached the proper strength. The instrument, therefore, serves as a useful indicator in the arts, but it has no scientific value. Corresponding to each degree of the Baume scale is a definite specific gravity, which can be found by referring to appropriate tables, as can also those corresponding to the degrees of the scales of Cartier and Beck, which, like that of Baume, are purely arbitrary.

5. *Gay-Lussac's Alcometer*. — This is a kind of hydrometer, which is used for measuring the strength of alcoholic liquids.

The form of the instrument is precisely the same as that of Baume; but the graduation, which is made at 15° , is different. The scale on the stem is divided into one hundred degrees, each of which represents one per cent of pure alcohol in volume. The hydrometer sinks to 0° in pure water, and to 100° in pure alcohol. If in any given alcoholic liquid it sinks to 30° , the liquid contains 30 per cent by volume of pure alcohol. The instrument is graduated by floating it in liquids of known strength, and marking the points on the stem to which it sinks. It is only accurate at the temperature of 15° . If the temperature is different from this, the indications of the instrument must be corrected by means of tables, which have been prepared for the purpose.

There are a great variety of other hydrometers, which are graduated so as to give the strength of milk, beer, vinegar, and other liquids. They are all similar in principle to the alcometer, and do not require description.

6. *Rousseau's Hydrometer*. — All the hydrometers which have been described require a sufficient amount of liquid to fill a glass of some size; but there are many cases in which it is desirable to ascertain promptly the specific gravity of a liquid, when only a few grammes of it can be obtained. The form of hydrometer represented in Fig. 251 has been contrived by Rousseau for this purpose. The general form of the instrument is similar to the others which have been described; but it differs in having on the top of the stem a small cup, *A*, which holds the liquids to be experimented upon. On the side of this cup is a mark which indicates a capacity of one cubic centimetre.

In order to graduate the instrument, it is floated in pure water at 4° , and loaded with mercury until it sinks to a point, *B*, marked at the base of the stem, which is the zero of the scale. The cup *A* is next filled up to the mark with distilled water at 4° , or, what amounts to the same thing, a weight of one gramme is placed in the cup. The instrument is so constructed that it will then sink to a point near the middle of the stem, which is marked 20° . The interval be-



Fig. 251.

tween these divisions is now divided into twenty equal parts, and the divisions are continued to the top of the stem. Since this has exactly the same size throughout, each division corresponds to one twentieth of a gramme, or 0.05 gram.

According to this graduation, if we wish to obtain the density of any liquid, — bile, for example, — we fill the cup with the liquid to the point marked on the side. The instrument will now sink, perhaps, to the 20.5 division on the stem. The weight of one cubic centimetre of bile is, then, $0.05 \times 20.5 = 1.025$ gram. Since the weight of the same volume of water at 4° is one gramme, the specific gravity of bile is $1.025 \div 1 = 1.025$. In

general, then, the specific gravity of a liquid is found with this instrument by multiplying 0.05 by the number of the division to which it sinks in water, when loaded with one cubic centimetre of the liquid.

The indications of all hydrometers are very much influenced by capillary attraction, and the more so the more delicately they are constructed. They are not, therefore, instruments of precision; but they are useful, since they give rapidly approximate results.

(148.) *Fourth Method.*

— A fourth method of finding the specific gravity of a liquid, which may be advantageously used under certain circumstances, is illustrated by Fig. 252. It depends on the principle of the equilibrium of liquids in connected vessels (131). The apparatus consists of

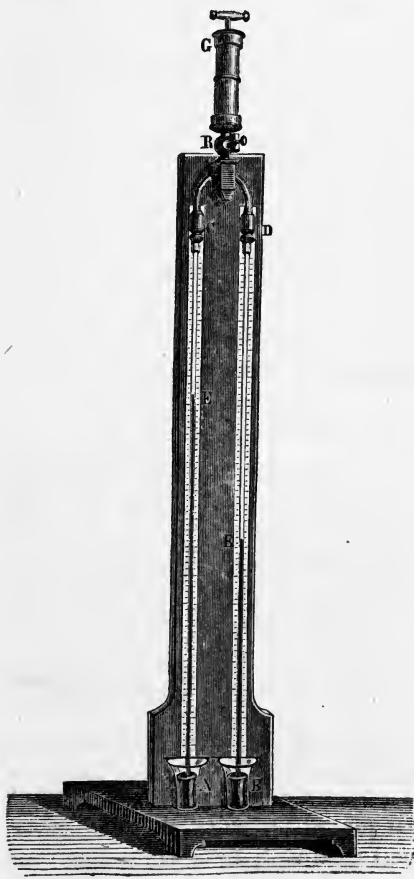

Fig. 252.

two tubes connected above with each other and with the chamber of an air-syringe. The lower ends of these tubes dip, the one into a glass of water, and the other into a glass containing the liquid whose specific gravity is required. On partially exhausting the air from the top of the tubes by means of the syringe, the liquids will rise in the two tubes. If, now, we close the stopcock connecting with the syringe, the liquids will stand permanently at a certain height in either tube. Moreover, it is evident, from the construction of the apparatus, that the two columns of liquid are in equilibrium with each other. Using, then, the notation of (131), we have, from [81],

$$H : H' = 1 : (\text{Sp. Gr.}), \text{ or } (\text{Sp. Gr.}) = \frac{H'}{H}; \quad [90.]$$

that is, the specific gravity of the liquid is found by dividing the height of the column of water by that of the liquid. The heights of the columns may be measured either by means of a scale on the tube, or by a cathetometer (see Fig. 196). If the liquid were alcohol, for example, and the height of the water column measured 60 c.m., the height of the alcohol column would be found to measure 75 c.m. Hence, the specific gravity of alcohol is $\frac{60}{75} = 0.80$.

PROBLEMS.

Buoyancy of Liquids.

106. A man, exerting all his force, can raise a weight of 50 kilog. What would be the weight of a stone (*Sp. Gr.* = 2.5) which he could just raise under water?

107. How much force in kilogrammes would be required to raise under water a mass of asphaltum (*Sp. Gr.* = 1.10) weighing 500 kilogrammes?

108. How many kilogrammes will 100 kilogrammes of cast-iron (*Sp. Gr.* = 7.25) weigh under water?

109. How much will the same amount of iron weigh under alcohol (*Sp. Gr.* = 0.798)?

110. If a given piece of gold be balanced by its weight of brass in a vacuum, what addition must be made to the brass so that they may be in equilibrium when immersed in water? *Sp. Gr.* of Brass 8.55; of Gold 19.36.

111. How much force in kilogrammes would be required to sustain under mercury at 0° a cubic decimetre of platinum? The specific gravity of platinum is 21.5; that of mercury, 13.598.

Floating Bodies.

112. How much bulk must a hollow vessel of copper fill, weighing one kilogramme, which will just float in water?

113. How much bulk must a hollow vessel of iron occupy, weighing 10 kilogrammes, which sinks one half in water?

114. A boat displaces 10 m^3 of water. What is the weight of the boat?

115. A cube of wood, weighing 100 kilogrammes, sinks three quarters in water. What is the specific gravity of the wood, and what is the size of the cube?

116. What portion of a cube of solid iron (*Sp. Gr.* = 7.7) will sink in mercury (*Sp. Gr.* = 13.6)?

117. A life-boat contains 100 m^3 of wood, whose specific gravity is equal to 0.8, and 50 m^3 of air, whose specific gravity is 0.0012. When filled with fresh water, what weight of iron ballast, whose specific gravity is 7.645, must be thrown into it before it will begin to sink?

118. If the specific gravities of a man, of water, and of cork be 1.120, 1.000, and .240 respectively, find what weight of cork must be connected to a man, weighing 75 kilogrammes, that he may just float in the water.

119. Determine the weight of a hydrometer, which sinks as deep in rectified spirits, whose specific gravity is 0.866, as it sinks in water when loaded with 4 gram.

120. A ship, sailing into a river, sinks 2 c. m., and, after discharging 12,000 kilogrammes of her cargo, rises 1 c. m.; determine the weight of the ship and cargo, the specific gravity of sea-water being to that of fresh as 1.026 is to 1.

121. If a solid, whose specific gravity = 6, float in a liquid, whose specific gravity = 15, determine the proportion of the parts immersed.

122. If a globe of wood, when placed in a vessel of water, rise 5 c. m. above the surface, but, when placed in a liquid whose specific gravity is 0.80, rise only 3 c. m. above the surface of the liquid, determine the diameter of the globe.

123. Having given the specific gravities of iron and water, determine what proportion the thickness of a hollow iron globe must bear to its diameter, that it may just float in water.

124. A parallelepiped of ice, whose three dimensions are 10.5 m., 15.75 m., and 20.45 m., is floating in sea-water on its broadest face; the specific gravity of sea-water is 1.026, and that of ice 0.930. Required the height of the parallelepiped above the surface of the water.

125. A cone, 1.5 m. high and 1.2 m. in diameter at the base, is floating on its base in a liquid in a vertical position, and sinks in it 20 d. m. How much of the liquid is displaced by the cone? If the cone is inverted, and made to float on its apex, how deep will it then sink?

126. A hollow cylinder of iron plate is 2.5 m. in diameter and 1.75 m. high. The plate is 1 c.m. thick, and its specific gravity 7.79. Will it float on water, and if so, how deep will it sink when its axis is vertical?

127. A cube of lead measures 4 c.m. on each side. It is required to sustain it under water by suspending it to a cube of cork. What must be the size of a cube of cork which just sustains it, assuming that the specific gravity of cork equals 0.24, and that of lead 11.35?

Elasticity of Liquids.

128. A cubic metre of water is submitted to a pressure of 15 atmospheres. How great is the condensation? and what is the specific gravity of the condensed liquid?

129. At a depth in the ocean of a little over 5 kilometres, the pressure amounts to 500 atmospheres. What is the specific gravity of the water at that depth, assuming that the specific gravity of sea-water is 1.026, and the compressibility 0.0000436?

Hydrostatic Press.

130. In the hydrostatic press are given the diameters of the two cylinders d and d' , and the force applied to the pump F . Determine the pressure produced.

131. In the hydrostatic press, suppose the diameters to be 4 c.m. and 80 c.m. respectively, the length of the pump-handle to be 1 m., and the distance of the pump from the fulcrum of the handle 10 c.m. Determine in what proportion the pressure exerted is increased.

Pressure exerted by Liquids in Consequence of their Weight.

It is assumed, in the following problems, that liquids are incompressible, and hence that their specific gravity is not increased, however great may be the pressure to which they are exposed.

132. The whole pressure on the bottom of a tub of water, the radius of which is 30 c.m., is 50 kilogrammes. What is the depth of the water in the pail?

133. What is the pressure exerted by the water on every square centimetre of the base of a cylindrical vessel, in which the liquid stands at the height of 10.336 m. above the base? If the water in the vessel were replaced by mercury, how high must the liquid stand, so that the pressure should be the same as before?

134. The horizontal and circular bottom of a flask, 15 c.m. in diameter, is filled with mercury to the depth of 20 c.m. How great is the pressure on the bottom?

135. What height must a column of water have, which will exert a pressure of 1,000 kilogrammes on every square decimetre?

136. A cubical vessel is filled with water, and into its side a bent tube

is inserted, filled with water, and communicating with the water in the vessel. Determine the pressure on the top of the vessel, the vertical height of the extremity of the tube above the vessel being (m) times the height of the vessel.

137. A sphere, 10 c. m. in diameter, is sunk to the depth of 100 m. in a fresh-water lake. Determine the total pressure exerted on its surface.

138. A cylinder, 15 c. m. in diameter and 20 c. m. high, is sunk so that its centre is at the depth of 1 m. below the surface of the water. Determine the total pressure exerted on its surface.

139. A hollow cone, 10 c. m. in diameter at the base and 5 c. m. high, is filled with water. Determine the pressure on the base and on the convex surface. Centre of gravity of convex surface is in the axis of the cone at $\frac{1}{3}$ of the altitude from the base.

140. A cylindrical vessel, 10 c. m. in diameter and 10 c. m. high, is filled with water. Determine the pressure on the base and on the convex surface.

141. A hollow cone, without a bottom, stands on a horizontal plane, and water is poured in at the vertex. The weight of the cone being given, how far may it be filled so as not to run out below?

142. A hemispherical vessel, 10 c. m. in diameter, without a bottom, stands on a horizontal plane. When just filled with water, the liquid begins to run out at the bottom. Determine the weight of the vessel.

143. A straight line is just immersed vertically in a liquid. Required to divide it into three portions, which shall be equally pressed.

144. Compare the pressures on the three sides of an equilateral triangle, just immersed in a liquid in such a manner that one side may be perpendicular to its surface.

Specific Gravity.

145. Determine the specific gravity of absolute alcohol from the following data :—

Weight of bottle empty,	4.326 gram.
“ “ filled with water at 4°,	19.654 “
“ “ filled with alcohol at 0°,	16.741 “

146. Determine the specific gravity of sulphuric acid from the following data :—

Weight of bottle empty,	4.326 gram.
“ “ filled with water at 4°,	19.654 “
“ “ filled with sulphuric acid at 0°,	28.219 “

147. Determine the specific gravity of lead shot from the following data :—

Weight of bottle filled with water at 4°,	19.654 gram.
“ shot,	15.456 “
“ bottle, shot, and water,	33.766 “

148. Determine the specific gravity of gold from the following data:—
 Weight of gold in air, 4.213 gram.
 Loss of weight in water, 0.2205 “
149. Determine the specific gravity of hammered copper from the following data:—
 Weight of copper in air, 1.809 gram.
 “ “ under water, 1.608 “
150. Determine the specific gravity of saltpetre from the following data:—
 Weight of saltpetre in air, 1.216 gram.
 “ “ under alcohol, 0.734 “
 Specific gravity of alcohol, 0.792 “
151. Determine the specific gravity of ash wood from the following data:—
 Weight of wood in air, 25.350 gram.
 “ “ a copper sinker, 11.000 “
 “ “ wood and sinker under water, 5.100 “
 Specific gravity of copper, 8.950 “
152. A sphere of platinum weighs in air 84 gram., and in mercury 31 gram. What is the specific gravity of platinum?
153. A piece of metal weighs 5.219 gram. in air, 4.132 gram. in water, and 4.009 gram. in a given liquid. What is the specific gravity of the metal and of the liquid?
154. A body, *A*, weighs in air 7.55 gram., in water 5.17 gram., in another liquid 5.35 gram. What is the specific gravity of the body and of the liquid?
155. A body weighs 14 gram. in a vacuum and 9 gram. in water; another weighs 8 gram. in a vacuum and 7 gram. in water. Compare their specific gravities.
156. A glass ball, weighing 10 gram., loses 3.636 gram. in water, and 2.88 gram. in alcohol. What is the specific gravity of alcohol?
157. A glass ball, weighing 10 gram. and whose *Sp. Gr.* = 2.75, weighs, under rape-seed oil, 6.658 gram. What is the specific gravity of this oil?
158. A glass ball, as above, weighs under water 6.364 gram., and under another liquid 7.12 gram. What is the specific gravity of this liquid?
159. A volumeter, whose stem is exactly cylindrical, sinks in a liquid whose *Sp. Gr.* = 1.1 to a point *b*, and in pure water at 4° C. to a point *a*. The distance from *a* to *b* is 4 c. m. How far from *a* must the divisions be placed to which the hydrometer will sink in liquids whose *Sp. Gr.* = 1.01, 1.02, 1.03, 1.04, 1.05.
160. A similar volumeter sinks in a liquid whose *Sp. Gr.* = γ to a point *b*, and in a liquid whose *Sp. Gr.* = γ' to a point *a*, higher on the stem. What is the specific gravity of a liquid in which it sinks to an intermediate point, *d*, when $bd = \lambda$, and $ab = l$.

161. A column of water 1.55 m. high is in equilibrium with a column of liquid 2.17 m. high. What is the specific gravity of the liquid?

Miscellaneous.

162. An alloy of gold and silver weighs 10 kilogrammes in air, and 9.375 kilogrammes in water. What are the proportions of gold and silver? The specific gravity of gold = 19.2, of silver = 10.5.

163. An alloy of copper and silver weighs 37 kilogrammes in the air, and loses 3.666 kilogrammes when weighed in water. What are the proportions of silver and copper?

164. The specific gravity of zinc is 7, and that of copper 9, nearly. What amounts of zinc and copper must be taken to form an alloy weighing 50 gram., and having a specific gravity equal to 8.2, assuming that the volume of the alloy is exactly the sum of the volumes of the two metals?

165. Required the specific gravity of a mixture of 18 kilogrammes of sulphuric acid and 8 kilogrammes of water, assuming that the specific gravity of the acid is equal to 1.84, and that the volume of the mixture is condensed $\frac{1}{3\frac{1}{2}}$.

166. Into a cylindrical vessel with a horizontal base 10 c. m. in diameter, there are poured 12 kilogrammes of mercury. At what height will the liquid rise in the cylinder? The specific gravity of mercury is 13.596.

167. How much mercury will a conical vessel hold which is 87 c. m. high and 46 c. m. in diameter at the base?

168. A cylinder of oak wood is 30 c. m. in diameter and 2.5 m. long; the specific gravity of the wood is 1.17. What is the volume and the weight of the cylinder?

169. A cylindrical vessel is 36.9 c. m. high, and 24.6 c. m. in diameter, interior measure. How much alcohol of specific gravity 0.863 will the cylinder contain?

170. Leaves of gold are made only 0.001 m. m. in thickness; the specific gravity of gold equals 19.632. How much surface can be covered with 10 gram. of gold?

171. A cast-iron ball weighs 12 kilogrammes; the specific gravity of cast-iron is 7.35. What is the radius of the ball?

172. What is the diameter of a platinum wire which weighs 28 gram. for each metre of length? The specific gravity of platinum is 22.06.

173. A silver wire 125 m. long weighs 6 gram.; the specific gravity of silver is 10.474. What is the diameter of the wire?

174. In a capillary tube is contained a column of mercury, weighing 0.500 gram., which measures 13.700 c. m. at 0° C. What is the diameter of the tube?

175. A wire 0.785 m. long, and weighing 0.364 gram., loses 0.017 gram. when weighed under water. What is the diameter of the wire?

III. CHARACTERISTIC PROPERTIES OF GASES.

(149.) *Mechanical Condition of Gases.* — The peculiar properties of a gas seem to depend on the fact, that the repulsive forces existing between its particles are greater than the attractive forces (78). Consequently, the particles of a gas tend to recede from each other, and were it not for extraneous causes the gas would expand — so far as is known — indefinitely into space. This natural tendency of gases is restrained on the surface of our globe by the pressure which the atmosphere exerts in consequence of its weight; but when this pressure is removed, the expansive tendency becomes at once manifest. The air which is contained in the India-rubber bag (Fig. 253), for example, is prevented from expanding by the pressure of the atmosphere on its exterior surface. If, however, we place the bag under the receiver of an air-pump, and remove the pressure by exhausting the air, the bag will at once expand; and this expansion will continue until the expansive tendency of the air is balanced by the elasticity of the bag.

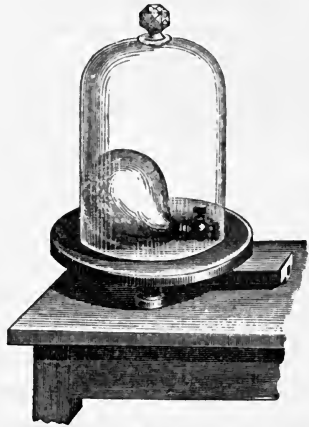

Fig. 253.

The force with which a gas tends to expand is called its *tension*; and it is evident that, when in a state of rest, the *tension* of a gas must be exactly equal to the pressure to which it is exposed; for were this not the case, the force which was in excess would cause a motion in the particles, which is inconsistent with the supposition. It appears, therefore, that in a gas, as in a liquid, the particles are in a condition of equilibrium; the only difference being, that in a liquid the equilibrium exists between the attractive and repulsive forces in the liquid itself, but in the gas, between the excess of repulsive forces in the body and an external pressure. In consequence of this condition of equilibrium, the particles of gases are endowed with perfect freedom of motion, and gases are therefore *fluids* (117). Moreover, since they are both elastic (77) and ponderable (7), it follows that all those

properties which are the necessary consequence of these mechanical conditions must belong to gases as well as to liquids. These, as before (119), naturally divide themselves into two classes: first, those which are independent of the action of gravity; and, secondly, those which depend upon it. As these properties have been so fully discussed in the case of liquids, it will only be necessary to extend the principles already established to the case of gases.

Properties Common to Gases and Liquids.

(150.) *Pressure which is independent of the Action of Gravity.* — Let us now suppose that the vessel (Fig. 254) already described (120) is filled with air, instead of water. As this air

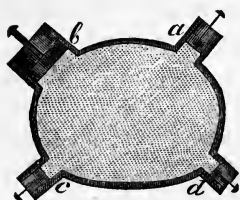

Fig. 254.

is in a permanent state of tension, it will, in consequence of its elasticity, exert pressure in all directions; and it is evident, from the same course of reasoning used in the case of water (120), that the pressures it exerts against the pistons *a, b, c, d* will be proportional to their areas. In like manner, the same will be true of any portion of the interior surface of the vessel,

and also of any ideal section in the interior of the vessel. If two sections are equal, they will receive equal pressures; if unequal, the pressures will be proportional to their areas.

If the air in the interior of the vessel is in the same condition as the external atmosphere, it is evident, from what has been said, that the pressure of the air on the interior surface of the vessel will be exactly balanced by the pressure of the atmosphere on the outside. The piston, therefore, being pressed equally on their inner and outer surfaces, will have no tendency to move. This being the condition of the air in the vessel, let us suppose that we condense the air still further, by pressing in one of the pistons; it is evident that we shall thus develop a greater elasticity in the particles, and each particle will in consequence exert a greater pressure. The *increased* pressures now exerted against the inner surfaces of the pistons will be proportional to the number of gaseous particles in contact with them, or, in other words, proportional to their areas. The pressures on the inner surfaces being also greater than those on the outer surfaces, the

pistons will tend to move out with forces varying in the same proportion.

From these considerations, it appears that *gases, like liquids, transmit pressure equally in all directions*; the only difference being this, that in our experiments on gases we start with a certain initial pressure due to their permanent elasticity. Gases, like liquids, will transmit pressure through long tubes and through any passages, however circuitous, provided only that there is a line of gaseous particles. A good example of this is furnished by the gas-pipes of large cities. Any pressure applied at the gasometer is transmitted almost instantaneously through hundreds of miles of pipe distributed in a most circuitous manner over several square miles of area. The close resemblance which gases bear to liquids is also shown by the fact that they transmit pressure from one to the other indifferently. We shall have occasion to notice several examples of this farther on.

Since the proof used in (121) applies to gases as well as to liquids, it follows that *the line indicating the direction of the pressure exerted by any gaseous particle against the section with which it is in contact, is always a perpendicular to this section at the point of contact.*

(151.) *Pressure depending on the Action of Gravity.* — The facts in regard to the pressure exerted by liquids in consequence of their weight are, as we found in sections (123) to (129), all necessary consequences of the one fundamental property, that they transmit pressure equally in all directions; and it therefore follows, that each of these facts must be true of gases. Let us commence with an ideal case. Suppose a closed cylindrical vessel, several kilometres high, filled with air of the same density through its whole extent, and rising vertically from the surface of the globe. It would be true of such a vessel, that *the pressure exerted by the air on the base of the cylinder, or on any portion of its side, or, in fine, on any section whatsoever, would be equal to the weight of a column of air, the area of whose base is equal to the area of the section, and whose height is equal to the vertical distance of the centre of gravity of the section from the top of the cylinder.* Moreover, the pressure on any given section would be entirely independent of the form or size of the vessel, provided only that the height remained the same.

This last circumstance is one of great importance, because it

enables us to extend our conclusions at once to the case of the atmosphere. The atmosphere is a mass of air retained upon the surface of the globe by the force of gravitation, and rising to a height which is estimated at the lowest at forty-seven kilometres. It is supposed to have, like the ocean, a definite surface, which, when at rest, is perpendicular at each point to the direction of gravity. It partakes of the rotation of the globe on its axis, and would remain at rest relatively to terrestrial objects were it not for local causes, which produce winds and disturb at each moment its equilibrium. Neglecting these disturbances, we may regard the atmosphere as a gaseous ocean in equilibrium covering the earth to a certain level, and exerting the same effects of pressure as if it were a liquid having a very small density. It follows, therefore, that each particle of the air exerts a pressure equal to the weight of a vertical line of superincumbent particles rising to the surface of the atmosphere. This pressure will be constant on surfaces at the same level; it will increase as we descend in the atmosphere, and diminish as we rise in it. At any one position, it will be equal on surfaces of the same area, whatever may be their direction; and on surfaces of unequal area it will be in proportion to the extent of the areas. It will be the same in the interior of any vessel or room as in the outer air, provided only there is a connection with the exterior atmosphere by some aperture, however small. Finally, the air will buoy up all bodies immersed in it with a force which will be equal to the weight of the volume of air displaced. As the validity of these conclusions has already been established in regard to liquids, it will only be necessary, in the case of gases, to illustrate the general facts by a few experiments.

(152.) *Pressure of the Atmosphere.* — The pressure exerted by the atmosphere on all bodies near the surface of the globe is exceedingly great, amounting, as we shall soon prove, to over one kilogramme on every square centimetre of surface, and to about 16,000 kilogrammes on the surface of the body of a man of ordinary stature. But since this pressure is exerted equally in all directions, and since the cavities of the body are filled either by air or other gases, which exert a pressure on the one surface of its delicate membranes exactly equal to that exerted on the other, this great pressure is not perceptible, and indeed was not known to exist until it was discovered by Torricelli in 1643. If, how-

ever, by any means, we can remove the pressure from one side only of a membrane, then the pressure on the other side will become evident.

We can readily remove the pressure from the interior surface of a vessel, by removing the air by means of an air-pump (175), and thus removing the fluid medium through which the pressure is transmitted. For example, if we remove the air from the cylindrical glass vessel which is represented in Fig. 255, resting on the plate of an air-pump, we shall also remove the pressure from the lower surface of the thin animal membrane which covers and closes the cylinder from above. Then the great pressure on the upper surface, being no longer balanced, will exert its full effect, first, by depressing

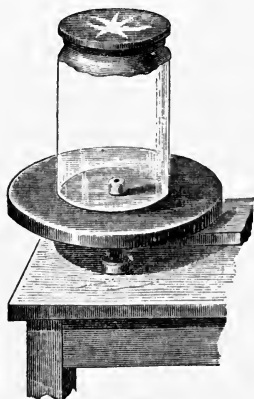

Fig. 255.

the membrane, and afterwards by bursting it, if it be not too strong.

That the pressure of the atmosphere is exerted upwards as well as downwards, may be further illustrated by means of the apparatus represented in Fig. 256.

It consists of a glass vessel supported on a tripod stand, having a large opening below, and a small tubulature above. The lower opening is closed by a bag of India-rubber cloth, as represented in the figure, and the tubulature is connected with an air-pump by means of a flexible hose. On exhausting the air, the bag is pressed up into the glass vessel with sufficient force to raise the heavy weight which is attached to it by means of a leather strap. By modifying the apparatus, it is easy to show that the pressure is exerted, not only upwards and downwards, but also in all directions. These various forms of apparatus, however, only demonstrate the existence of pressure. They do not enable us to measure it.



Fig. 256.

(153.) *Buoyancy of the Air.* — The general fact, that air, like liquids, buoys up all bodies immersed in it, may be illus-

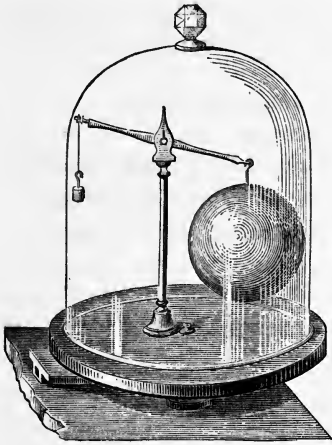

Fig. 257.

trated by means of the apparatus represented in Fig. 257. It consists of a closed globe suspended to one arm of a delicate balance, equipoised by a weight suspended to the other. The two are in equilibrium in the air, but only because the globe, being larger than the weight, is buoyed up by a greater force. If, now, the apparatus is placed upon the plate of an air-pump and covered with a glass bell, we shall find, on removing the air, that the globe will preponderate, as is shown in the figure. By removing the air, we increase the ap-

parent weight both of the globe and of the counterpoise by just the weight of the air displaced by each; but as the globe is much the largest, we increase its weight more than that of the smaller brass counterpoise, and hence the result. If we allow the air to re-enter the bell, it will buoy up the globe, as before, so much more than the counterpoise, as to restore the equilibrium.

(154.) *Weight of a Body in Air.* — An important consequence of the principle just illustrated is evident. The balance does not give us the true relative weight, W , of a body, but a slightly different weight, depending on the weight of air displaced by the body compared with the weight of air displaced by the brass or platinum weights used in weighing. As the volume of these weights is generally less than that of the body, the weight indicated by the balance is almost always too small; but when the volume of the weights is greater than that of the body, the weight indicated by the balance is too large. When the two volumes are equal, the balance will indicate the same weight in air as in a vacuum. It is easy to ascertain the correction which it is necessary to add to or subtract from the weight of a body in air, in order to obtain its true weight.

It must be remembered that the brass and platinum weights

which are used in delicate determinations of weight are only standard when in a vacuum (64). Let us, then, represent the various values as follows :—

W' = weight of the body in air as estimated by standard weights, and also the weight of the standard weights themselves in a vacuum.

V' = volume of the standard weights in cubic centimetres.

V = volume of the body in cubic centimetres.

w = weight of one cubic centimetre of air at the time of the weighing.

W = weight of the body in a vacuum, — which we wish to find.

We can now easily deduce the following values :—

$V' w$ = buoyancy of air on the weights.

$V w$ = buoyancy of air on the body.

$W' - V' w$ = actual weight of standard weights in air.

$W - V w$ = actual weight of body in air.

Since these weights just balanced each other, we have

$$W - V w = W' - V' w, \text{ or } W = W' + w (V - V'). \quad [91.]$$

The correction $w (V - V')$, which must be made to the weight determined by a balance in air in order to obtain the weight in a vacuum, is evidently additive when the volume of the body is greater than that of the weights, and subtractive when these conditions are reversed. When the volumes are equal, the correction becomes 0.

In all ordinary cases of weighing, the correction is so small that it may be neglected without sensible error ; but it becomes of the greatest importance in determining the weight of a gas. In such cases, we have to determine the weight of a large glass globe when completely vacuous and when filled with gas ; and it not unfrequently happens that the buoyancy of the air is greater than the weight of the gas itself, and it is always a considerable part of it. If the buoyancy of the air is the same when the globe is weighed in its vacuous condition and when filled with gas, it would not affect the weight of the gas, which would be obtained by subtracting the first weight from the last. But, unfortunately, the buoyancy is constantly changing ; and it is therefore necessary to determine the amount carefully at each weighing, and reduce the weights of the globe in the two conditions to what they would be if the experiments had been made in a vacuum.

When the temperature is 0° C. and the barometer stands at 76 c. m., and when the air contains neither vapor of water nor carbonic acid, w is equal to 0.001293 gram. Were the atmosphere always in this condition, nothing would be easier than to calculate the actual weight of a body from the weight found by weighing in this normal atmosphere. But this is far from being the case; for the temperature, the pressure, and the composition of the atmosphere are changing at each moment, and the value of w varies with all these atmospheric changes. We shall hereafter show in what way the value of w may be ascertained, at any given time, when the condition of the atmosphere is known.

It is frequently possible to conduct the process of weighing in such a way that the correction for the buoyancy of the atmosphere,

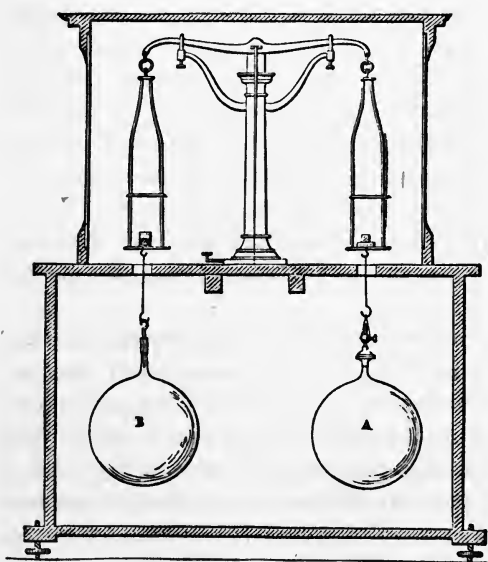

Fig. 258.

always somewhat uncertain, may be avoided. For example, in weighing a gas, instead of equipoising the glass globe when empty, by means of ordinary weights, we may equipoise it by means of a second globe, hermetically closed, and having the same volume as the first, in the manner represented in Fig. 258. It is evident that in this case, whatever may be the buoyancy of the atmosphere, it

will equally affect both globes, and we shall only have to consider the buoyancy of the air on the small weights necessary to restore the equilibrium after the globe is filled with the gas to be weighed; but this is so small that it may always be neglected.

(155.) *Balloons*. — If the weight of a body is less than that of the gas which it displaces, it is evident that the body will rise in the gas; and hence the phenomena of floating bodies, which we have

already studied in the case of liquids (140), must be repeated in the case of gases. It is not difficult to construct a body which shall be, taken as a whole, specifically lighter than air, and which will therefore rise in the atmosphere as wood rises in water. Hydrogen gas is $14\frac{1}{2}$ times lighter than air, and by enclosing a large volume of this gas in a light bag made of oiled silk, called a *balloon*, we shall have a body which will displace a weight of air much greater than its own weight. For example, let us suppose that the balloon, when fully inflated, forms a sphere two metres in diameter. It is easy to calculate that it will contain 4.1887902 m^3 of hydrogen, which will weigh 374.436 gram. Neglecting the volume occupied by the material of the balloon, it will displace an equal volume of air, weighing 5,418.75 gram. The difference between these weights, or 5,044.31 gram., will represent the excess of the buoyancy of the air over the weight of the hydrogen; and hence, if the balloon and its attachments weigh less than this, it will, when inflated with hydrogen, rise in the atmosphere. The difference between the weight of the balloon inflated with hydrogen and that of the air displaced by it is termed the *ascensional force* of the balloon. If the balloon is ten metres in diameter, and weighs 100 kilogrammes, it would have an ascensional force of 530.5 kilogrammes, and therefore sufficient to raise a car with several passengers into the atmosphere.

In practice, a balloon is never at first more than two thirds filled with hydrogen; because, as it rises in the atmosphere, the gas rapidly expands, and it is necessary to allow for this expansion. Moreover, the hydrogen used is mixed, to a greater or less extent, with air and vapor, which greatly increase its weight. These causes diminish the ascensional force to such an extent, that in practice the ascensional force of a balloon ten metres in diameter would not be more than one half of what it is estimated above.

Since the introduction of coal-gas as an illuminating material, this is almost exclusively used for inflating large balloons. The specific gravity of this gas is on an average about 0.5, and it is only, therefore, about twice as light as air. Hence, in order to obtain the same ascensional force with coal-gas as with hydrogen, it is necessary to use very much larger balloons. When the specific gravity of a gas is given, it is easy to calculate the ascensional force which in any given case may be obtained with it.

Let us represent by d and d' the specific gravities of air and the gas to be used, referred to water [58]; by W , the weight of the material of the balloon and its attachments; and by V , its volume when inflated. Then, by [56], we have for the weight of the gas in grammes Vd' , and for the weight of the air it displaces Vd . Neglecting, for the moment, the weight of the balloon itself, we should have for the ascensional force $V(d - d')$. Subtracting the weight of the balloon and its attachments, we have, for the total ascensional force F ,

$$F = V(d - d') - W. \quad [92.]$$

If the balloon is a sphere of which R is the radius, then we should have for the value of V , when the balloon was fully inflated, $\frac{4}{3} \pi R^3$, and for the value of F ,

$$F = \frac{4}{3} \pi R^3 (d - d') - W. \quad [93.]$$

When the gas used is pure hydrogen, $d = 0.00129363$, and $d' = 0.00008939$. Substituting these values, and also for π its well-known value, the expression becomes

$$F = 0.00504431 R^3 - W, \quad [94.]$$

in which R stands for a certain number of centimetres, and W for a certain number of grammes.

As we live at the bottom of the ocean of air which surrounds the globe, we cannot, from the nature of the case, imitate with it the condition of a vessel floating on the surface of the water; but with other gases this condition of things may be, at least in a small way, very nearly approached.

The large fermenting-vats of breweries and distilleries are almost constantly filled with carbonic acid gas, which, being heavier than the air, remains in the tank, and has a surface like that of water, although it is not quite so definite. By exploding a little gunpowder in the gas, and thus filling it with smoke, the surface becomes distinctly visible. A very illustrative experiment can be made at such vats, by allowing soap-bubbles, blown with a common tobacco-pipe, to fall on the gas thus clouded. They will for a few moments float on the surface, and illustrate in a most striking manner the analogy between gases and liquids.

Differences between Liquids and Gases.

(156.) We shall fail to give an accurate idea of the nature of a gas, if, after having dwelt upon the analogies between liquids and gases, we do not point out those qualities which distinguish these two conditions of matter.

1. *Difference of Specific Gravity.* — The most obvious difference between gases and liquids is to be found in their relative weight. A litre of water weighs 1,000 grammes, and the weight of the same volume of other liquids varies from 600 to 3,000 grammes, leaving out of account mercury and other metals, when in a melted state, which are much heavier. Between these limits we find almost every possible gradation. One litre of air weighs 1.294 gram., and the weight of one litre of other gases varies between 0.089 gram. and 20 gram. There is, therefore, a wide gap between the lightest liquid and the heaviest gas, but yet this difference is one entirely of degree; and although this gap is not filled by any known substance in its normal condition on the globe, yet Natterer, in his experiments on the condensation of gases,* must have had atmospheric gas in every degree of density between its ordinary density and that of water.

2. *Compressibility.* — Gases are also distinguished from liquids by being far more compressible. When by means of a piston we attempt to condense a liquid, we find that we can only reduce its volume very slightly.* But this almost insensible diminution of volume develops a very great elasticity; for it is only necessary to reduce the volume one forty-five-millionth to produce a resistance equal to the pressure of our atmosphere. It is different with gases. When, for example, we press down a piston into a cylinder containing air (Fig. 51), it is necessary to reduce the volume to one half in order to double the resistance, and to one third in order to treble it. As the pressure is increased, the volume of a gas is diminished almost in the same proportion; as the pressure is diminished, on the other hand, the volume of the gas is proportionally increased. For this reason, gases are frequently called compressible, and liquids incompressible fluids; but here again the difference is one of degree rather than of kind.

This difference of compressibility gives rise to an important dif-

* Poggendorff, *Annalen*, XCIV. 436.

ference of condition between the atmosphere, regarded as an ocean of gas, and the liquid oceans of our globe. As we descend in the ocean, although the pressure increases with great rapidity, yet the density of the water is not materially increased. It is very different with the atmosphere. As we rise in this ocean of gas, the air becomes less dense in proportion as the pressure is diminished, and when at a height of about 5,520 m. the pressure is reduced one half, the density is also reduced one half. On the other hand, when we descend into mines, and the pressure from above is increased, the density of the air increases in the same proportion. The atmosphere does not, therefore, like the sea, consist of a fluid of nearly uniform density throughout, but its density very rapidly diminishes as we rise above the surface of the globe. It would not, then, be possible to have a cylindrical vessel filled with air of uniform density throughout its whole height, as we supposed in (151). Such a condition of things is wholly ideal, and was introduced merely for the sake of illustration. Were the atmosphere, like the sea, of nearly uniform density, its height would be only about eight kilometres, instead of forty-seven, as already stated. The pressure exerted by such an ideal fluid would be precisely the same as that exerted by the atmosphere; so that, while merely studying the pressure on the surface of the earth, we may conceive of the pressure as exerted by a fluid of uniform density, without committing any material error; but it must be remembered that the real state of the case is very different. We shall return to this subject in a future section.

3. *Permanent Elasticity.* — We have already dwelt at some length on this property of gases, which distinguishes them pre-eminently from liquids (149); but even here the difference is not so strongly marked as it would at first sight seem. A simple experiment will illustrate this point, and at the same time make the distinction between the two fluid conditions of matter clearer.

Let us take, then, a volume, V , of water, contained in a vessel of much greater capacity, and let us suppose that its temperature is 100° , and that it is exposed to a given pressure, for example of ten atmospheres. If, now, we diminish the pressure successively by one atmosphere each time, the volume V will increase by a very small amount, represented by $V\mu$, at each operation. As

soon, however, as the pressure is reduced to one atmosphere, this law of expansion ceases abruptly, and the water, without any intermediate transition, takes a volume 1,200 times greater than before, changing into a gas having all the properties of air, and preserving these properties at any pressure less than one atmosphere.

We may now reverse this experiment. Let us, then, increase the pressure upon this gas formed by water; we shall find that, when the pressure is doubled, the volume of the gas will be reduced one half, but as soon as the pressure exceeds one atmosphere it will suddenly take a volume 1,200 times smaller than before, and a density 1,200 times greater, collecting in the lower part of the vessel in a liquid form. After this, it can be compressed but very slightly by increasing pressures. We have taken, as an example, water at 100° , because the change of state which it undergoes at this temperature is a familiar fact to every one. We might have cited sulphurous acid gas, which liquefies at -10° , or carbonic acid gas, which liquefies at -78° ; but whatever might be the body examined, the result would be the same.

What has now been stated in regard to gases may be summed up in a few words. They are bodies constituted, like liquids, of molecules which repel each other, bodies which transmit pressure equally in all directions, which arrange themselves under the influence of gravity in strata whose density and elasticity increase as we descend, which buoy up all bodies immersed in them with a force equal to the weight of the fluid displaced, and in which the laws of the equilibrium of floating bodies are reproduced. These are the analogies. On the other hand, they are bodies having a very small density, obeying a special law of compressibility, and which, when submitted to a sufficient pressure, change into liquids.* Such, then, are the characteristic properties of gases; but before studying these more in detail, we must consider the mode by which the pressure of a gas may be accurately measured.

THE BAROMETER.

(157.) *Experiment of Torricelli.* — Before the middle of the seventeenth century, the phenomena which we now refer to the pressure of the air were explained by a principle invented

* We shall hereafter learn that there are some gases which have not been liquefied.

by the Aristoteleans, namely, that "Nature abhors a vacuum." These ancient philosophers noticed that space was always filled with some material substance, and that, the moment a solid body was removed, air or water always rushed in to fill the space thus deserted. Hence they concluded that it was a universal law of nature that space could not exist unoccupied by matter, and the phrase just quoted was merely their figurative expression of this idea. When, for example, the piston of a common pump was drawn up, the rise of the water was explained by declaring that, as from the nature of things a vacuum could not exist, the water necessarily filled the space deserted by the piston.

This physical dogma served the purposes of natural philosophy for two thousand years, and it was not until the seventeenth century that men discovered any limit to Nature's horror of a vacuum. Even as late as 1644, Mersenne speaks of a siphon which shall go over a mountain, being then ignorant that the effect of such an instrument was limited to a height of ten metres. This limit appears to have been first discovered by Galileo. Some Florentine engineers, being employed to sink a pump to an unusual depth, found that they could not raise water higher than ten metres in the barrel. Galileo was consulted, and he is said to have replied, that Nature did not abhor a vacuum above ten metres. However this may be, it appears that Galileo did not understand the cause of the phenomenon, although he had previously taught that air has weight; and it was left for his pupil, Torricelli, to discover the true explanation. Torricelli reasoned that the force, whatever it is, which sustains a column of water ten metres high in a cylindrical tube, must be equivalent to the weight of the mass of water sustained; and consequently, if another liquid were used, heavier than water, the same force could only sustain a column of proportionally less height. The weight of mercury being $13\frac{1}{2}$ times greater than that of water, Torricelli argued that, if the force imputed to the abhorrence of a vacuum could sustain a column of water 10 metres high, it could only sustain a column of mercury $13\frac{1}{2}$ times lower, or about 76 c. m. high. This led to the following experiment, which has since become so celebrated in the history of science.

Torricelli took a long glass tube, open at one end, such as *dc*, Fig. 259, and, having filled it with mercury, closed the open end with his thumb, and, inverting the tube, plunged this end into

a basin of mercury. On removing his thumb, the mercury, instead of remaining in the tube, fell, as he expected, and after a few oscillations came to rest at a height of about 76 c. m. above the level of the mercury in the basin. The correctness of his induction having been thus completely verified, Torricelli soon discovered the real nature of the force which sustained both the water in the pump and the mercury in his tube.

This experiment excited a great sensation among the scientific men of Europe; but, as might have been expected, the explanation given of it by Torricelli was very generally rejected. It was opposed to a long-established dogma, and Nature's horror of a vacuum could not be so easily overcome. The celebrated Blaise Pascal, however, had the sagacity to perceive the force of Torricelli's reasoning, and devised an *experimentum crucis* which put an end to all

controversy on the subject. "If," said Pascal, "it be really the weight of the atmosphere, under which we live, that supports the column of mercury in Torricelli's tube, we shall find, by transporting this tube upwards in the atmosphere, that in proportion as it leaves below it more and more of the air, and has consequently less and less above it, there will be a less column sustained in the tube, inasmuch as the weight of the air above the tube, which is declared by Torricelli to be the force which sustains it, will be diminished by the increased elevation of the tube." * Accordingly, Pascal carried the tube to the top of a church-steeple in Paris, and observed that the height of the mercury in the tube fell slightly; but, not satisfied with this

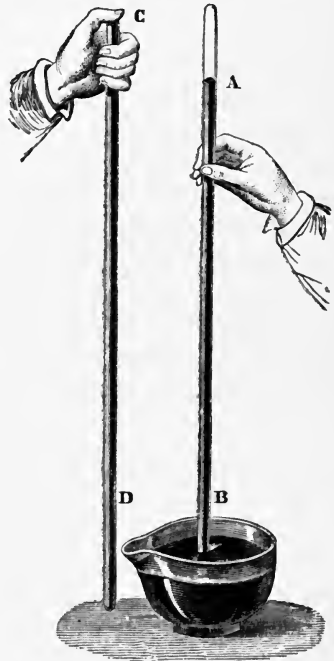

Fig. 259.

* Lardner's Hand-Book of Natural Philosophy.

result, he wrote to his brother-in-law, who lived near the high mountain of Puy de Dôme, in Auvergne, to make the experiment there, where the result would be more decisive. "You see," he writes, "that if it happens that the height of the mercury at the top of the hill be less than at the bottom, (which I have many reasons to believe, though all those who have thought about it are of a different opinion,) it will follow that the weight and pressure of the air are the sole cause of this suspension, and not the horror of a vacuum: since it is very certain that there is more air to weigh on it at the bottom than at the top; while we cannot say that Nature abhors a vacuum at the foot of a mountain more than on its summit." M. Perrier, Pascal's correspondent, made the observation as he desired, and found a difference of nearly eight centimetres of mercury, "which," he replies, "ravished us with admiration and astonishment."*

Pascal still further varied and extended the original experiment of Torricelli, and deduced the theory of the equilibrium of liquids and gases, which he left almost perfect.

(158.) *Theory of the Barometer.* — It is hardly necessary to state that the tube of Torricelli is the instrument which is now so well known as the *Barometer*. This name, indeed, is derived from two Greek words, *βαρύς* and *μέτρον*, which indicate its use as a measure of the pressure of the air. The theory of the barometer can be readily deduced from the principles of the equilibrium of fluids, already established. The mercury is sustained in the tube by the pressure of the air on the surface of the mercury in the basin. Let us consider how much of this pressure is effective in producing the result.

Consider, then, a section made across the tube at the level of the mercury in the basin. All the liquid below this level is evidently in equilibrium (130 and 131). Represent the area of the surface of the mercury in the basin by S' , and that of the section of the tube by S . The pressure, \mathcal{F}' , exerted by the air on S' , is transmitted through the liquid mercury to S . The pressure thus exerted on the under face of the section will be, by [77], as many times less than \mathcal{F}' as S is less than S' , or $\mathcal{F} : \mathcal{F}' = S : S'$, and $\mathcal{F} = \mathcal{F}' \frac{S}{S'}$. For example, if $S' = 100 \text{ c. m.}^2$ and $S = 1 \text{ c. m.}^2$,

* Whewell's History of the Inductive Sciences, Vol. II. pp. 67, 68.

then $\mathcal{F} = \mathcal{F}' \frac{1}{100}$. The pressure, therefore, which is exerted by the air on the lower face of this section is the same as that it would exert if applied directly to the section itself. As this pressure just sustains a column of mercury whose height we may represent by H , it is evidently just equal to the pressure exerted by this column on the upper side of the same section. But by [78] this pressure is equal to $H \cdot S$. (*Sp. Gr.*). Substituting, then, for *Sp. Gr.*, the value for mercury at 0° , or 13.596, we have for the pressure of the air on a given surface, S , the value,

$$\mathcal{F} = 13.596 \cdot S \cdot H, \quad [95.]$$

in which H denotes the height of the mercury in the barometer at 0° . For any other height we should have $\mathcal{F}' = 13.596 \cdot S \cdot H'$, and, comparing the two equations, we obtain

$$\mathcal{F} : \mathcal{F}' = H : H'; \quad [96.]$$

that is, the pressure of the air on a given surface is proportional to the height of the barometer column. We may, therefore, use the height of the barometer as a measure of the pressure, in the same way that we use an arc as a measure of an angle, or weight as a measure of mass. The height is not the same sort of quantity as the pressure, but it is sufficient for any measure that it should be proportional to the quantity measured. It is therefore customary to speak of the pressure of the air as amounting to so many centimetres of mercury; meaning thereby, that it will support a column of mercury of that height. The use of the barometer is not confined to measuring the pressure exerted by the atmosphere. We may use it for measuring the pressure exerted by any gas; and here, as before, we speak of the pressure as amounting to so many centimetres of mercury. When the pressure is equivalent to seventy-six centimetres of mercury, we say that it is equal to one atmosphere. When two, three, or four times as great as this, we say that it is equal to two, three, or four atmospheres.

It is always easy to reduce pressure expressed in centimetres of mercury to weight. For this purpose, it is only necessary to substitute in [95] the values of H and S in the given case, and the result will be the amount of pressure in grammes. For example, in the air the height of the barometer column is, on the

average, 76 c. m. Substituting this value, and also for S , 1 c.m.^2 , we obtain

$$f = 1,033.296 \text{ gram. ;} \quad [97.]$$

which is the pressure exerted by the atmosphere on every square centimetre of surface. The height of the barometer column varies on the surface of the earth from about 72 c. m. to 78 c. m., and hence the pressure on the square centimetre varies from 978.9 grammes to 1,060.5 grammes. The total pressure exerted by the atmosphere on large objects is therefore exceedingly great; that on a man of ordinary stature amounts, as already stated, to about 16,000 kilogrammes.

Having studied the theory of the barometer, we will now examine a few of the most useful forms of the instrument, premising that the essential parts are a tube over seventy-six centimetres long, a basin of mercury, and a graduated scale for determining the height of the column.

(159.) *Regnault's Barometer.* — The simplest and most accurate form of the barometer is the one represented in Fig. 260, which was invented by Regnault. The basin of mercury is formed by an iron trough, which is divided by a partition into two parts; but the partition does not rise to the top of the trough, and is covered by the mercury which fills the basin. The basin is supported on a shelf, attached to the lower part of a wooden plank, to which the glass tubes are securely fastened by means of clamps. This plank is itself immovably fastened to a brick wall. The barometer tube at the left of the figure dips into the left-hand compartment of the trough. The tube on the right is called a *manometer*, and its use will soon be explained. The height of the mercury in the barometer is measured by means of the cathetometer, represented on the right-hand side of the figure, which is placed on a firm support in front of the instrument. In order to obtain the measure with the greatest possible accuracy, a vertical screw, M , with two points and of a known length, is attached to the basin, as represented in the figure. At the moment of observation, we lower the screw by turning it on its axis until the lower point just touches the mercury. This contact can be obtained with the most perfect precision, for until it takes place the observer sees at the same time the point and its image reflected by the mercury. The two seem to approach each other until

contact is attained, and the surface of the mercury is seen depressed the moment this point is passed. The contact obtained,

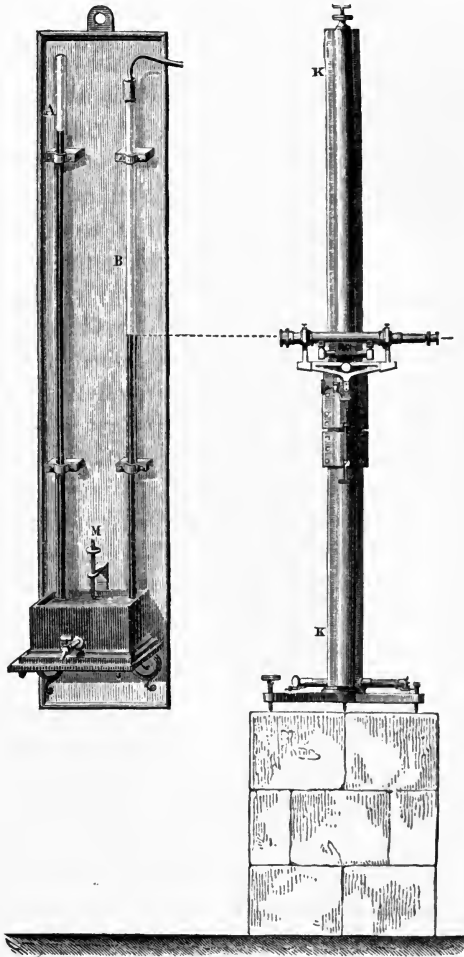

Fig. 260.

we measure the distance, with the cathetometer, between the upper surface of the mercury in the tube and the upper point of the screw, and we have only to add to this length the known length of the screw. Of all barometers this one is the simplest, and of all methods of measuring the height of the column the one just described is the best. We thus measure directly the vertical height, and it is no matter whether the instrument is in-

clined or not. We thus avoid instrumental errors; and, moreover, with a good cathetometer, the difference of level can be determined within the fiftieth part of a millimetre.

(160.) *Barometer of Fortin.* — It is not always possible to fix a barometer permanently to a wall in the way just described.

For example, in using the instrument for measuring the heights of mountains, it is necessary that it should be portable; and without diminishing materially the accuracy, it is important to simplify the method of measuring the height of the mercury column. The barometer of Fortin (Fig. 261) satisfies completely all these requirements. The glass tube is enclosed, for protection, in a brass case, towards the upper part of which

two longitudinal openings are provided opposite to each other for observing the height of the mercury column, by means of a scale graduated on the case, as represented in Fig. 262. A vernier, *BC*, moves up and down in the opening, and its position can be carefully regulated by means of the rack



Fig. 261.

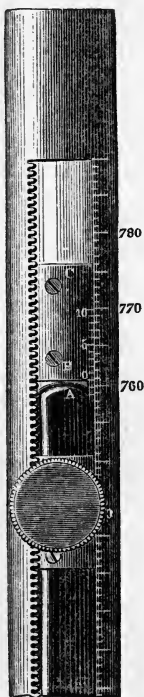

Fig. 262.

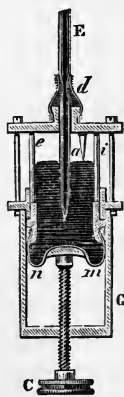

Fig. 263.

and pinion work represented in the figure. To the lower end of the case is fastened, by a screw, the reservoir of mercury, in which the glass tube dips, as represented in Fig. 263. This reservoir is formed principally by a cylinder of glass cemented at both ends to wooden caps surmounted by brass mountings, which last are kept in place by three long screws (Fig. 261). The bottom of the reservoir is formed by a leathern bag, *m n* (Fig. 263), which can be raised or lowered by the screw *C*. To the

cover of the cylinder is fastened an ivory pin, α , whose point corresponds exactly to the zero of the scale graduated on the case. The reservoir is closed above, also, by a leathern cover, firmly tied both to the glass tube and the wooden cap, which, while it prevents the mercury from escaping when the barometer is reversed, nevertheless gives free passage to the air. All the parts of the reservoir are represented in Fig. 264, in perspective, unscrewed and inverted.

In using this barometer, it is first suspended by the ring C , so that the instrument may swing freely, when, like a plumb-line, it will come to rest with the scale perfectly vertical. Next, the level of the mercury in the reservoir is brought to correspond with the point of the ivory pin, by turning the screw C (Fig. 263) in one direction or the other. This coincidence can be attained with great accuracy in the way already described in the last section. Since the level of the mercury in the basin now coincides with the zero of the scale graduated on the brass case, it only remains to read off the height of the column of the mercury in the tube by means of the scale at its side. For this purpose, the vernier is raised or lowered by means of the thumb-screw until its lower edge is just tangent to the convex surface of the mercury in the tube (Fig. 262). This adjustment can also be obtained with great accuracy by suspending the barometer in front of a light wall, sighting across the front and back edge of the brass tube carrying the vernier, which moves within the brass case of the instrument. It only remains, then, to read on the scale the position of the vernier, to obtain the height of the barometer within a tenth of a millimetre.

A great advantage of this form of barometer is the facility and safety with which it may be transported. By raising the screw C sufficiently, the whole interior of the tube and reservoir may be



Fig. 264.

filled with mercury, and then the instrument may be reversed and transported from place to place without danger; and even if the tube is accidentally broken, it is always possible, with a little skill, to replace it.

A thermometer is always attached to the barometer, since the height of the mercury column varies slightly with the temperature; for heat, by expanding the mercury, changes slightly its specific gravity, and on this the height of the column depends. The standard temperature which has been adopted is 0° C., and all barometrical observations are corrected so as to reduce them to the standard temperature. A table for applying this correction will be found in most works of meteorology,* and the method of calculating it will be explained in the chapter on Heat. A second correction is also required for capillarity, the nature of which will be explained in a future section. This correction, however, is a constant quantity for the same instrument, and is generally allowed for by the instrument-maker † in adjusting the scale of the instrument.

(161.) *Common Barometer.*

— Having described at length the two most useful and accurate forms of the barometer, it will not be necessary to do more than allude to the numerous modifications of the instrument which have been devised by Gay-Lussac and other physicists, for the purpose of obviating the correction for capillarity. They will be found described at length in the large works on physics. A very common form of barometer, which is much used as a

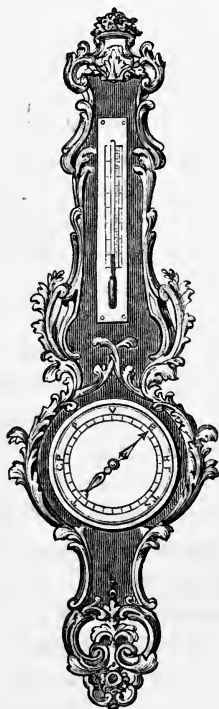

Fig. 265.



Fig. 266.

* See Guyot's Meteorological Tables, published by the Smithsonian Institution.

† Good barometers, like the one described, are made by Green, of New York.

weather-indicator, is represented in Fig. 265. The glass tube has the form of a siphon, as represented in Fig. 266. When the mercury falls in the barometer, it must of course rise to a proportional height in the short arm of the siphon, and it raises a float resting upon it. This float is fastened to a cord which passes round a wheel, *O*, and is attached to a weight, *P*, on the other side. The motion of the float thus communicates motion to the wheel, and this, in its turn, moves the index over the dial-plate of the instrument. Such barometers admit of no precision, and are of little value except as ornaments.

A variety of barometer depending on the laws of elasticity has already been described (104), and is represented in Fig. 267.

Another form of barometer, differently constructed, but depending on the same principle, is the *aneroid* barometer*, invented by M. Vidi. Both of these barometers, on account of their small volume and the absence of any fragile material in their construction, are very portable. They are very sensible, and more regular in their indication than the common mercury barometers, especially when the differences of pressure are not great; but they cannot be relied upon where high scientific



Fig. 267.

accuracy is required. They can, however, be highly recommended as common house or ship barometers. Since the elasticity of the metal of these barometers is liable to change with long use, it is important to adjust the instruments from time to time, by comparing them with a standard mercury barometer. In case of disagreement, they can easily be made to accord, by turning a screw provided for the purpose.

(162.) *Uses of the Barometer.* — The barometer is, without question, one of the most useful instruments in the hands of the chemist. The volumes of the gases on which he experiments are liable to considerable variations, depending on changes in the

* From *ἀ* and *νερός*, without moisture, since the instrument is constructed without any liquid.

pressure of the atmosphere; the boiling points of liquids are also materially influenced by them; and it is therefore essential to observe the height of the barometer at each experiment, and to correct the results by reducing them to that which would have been obtained had the barometer stood at 76 c. m. at the time of observation. These uses of the barometer will all be explained in future sections of this volume, and it is not therefore necessary to dwell upon them here. As a meteorological instrument, the barometer is the most important means of investigating the laws of the changes which are constantly taking place in the atmosphere, — a problem which is of the greatest interest to mankind. This atmosphere, as has been already stated, may be regarded as a great liquid sea, and its waves are constantly rolling over our heads. When the crest of one of its immense tidal waves is over the barometer, the instrument rises, and when the depression follows, the barometer falls; and thus, by watching the height of the mercury column, we are able to follow changes in the atmosphere which would otherwise escape notice. For many years the height of the barometer has been registered at stated hours, night and day, at a large number of meteorological stations all over the world; and although but few general results have been obtained, yet sufficient has been learned to warrant us in expecting much in the future.

The mean height of the barometer during a year at any one place is constant; but it varies at different latitudes, gradually increasing from the equator to the thirty-sixth parallel, and thence diminishing to the pole. During the same day, the barometer undergoes very regular oscillations, which are greatest at the equator. According to Humboldt, at the equator there are two maxima, at ten o'clock, morning and evening, and two minima, at four o'clock, morning and evening; the amplitude of the oscillation during the day amounting to 2.55 m. m., but that during the night, from four o'clock in the evening to four o'clock in the morning, being only 0.84 m. m. The same oscillations are noticed all over the torrid zone; but in the temperate zone they have a less amplitude, and are more masked by accidental changes. But nevertheless, by comparing the means of a large number of observations continued during a long interval, they can be detected, and nearly at the same hours. It has been further discovered that their amplitude is variable, being greater in summer than in winter.

Besides these regular oscillations, the barometer in temperate climates is liable to apparently irregular changes, produced by storms in the atmosphere. As a general rule, it may be stated that during fair weather the barometer is high, while it is generally very much depressed during a rain-storm. So, also, a sudden fall of the barometer usually indicates the approach of a storm; and, on the other hand, the clearing up of a storm is frequently preceded by a rise in the mercury column. Hence one of the most valuable uses of the instrument, in forewarning the navigator of the approach of a storm. Those who have studied the indications of the barometer know that they are frequently at fault, and that they are only probably correct. It is hardly necessary to add, that the words "Fair," "Rainy," etc., which are frequently placed against certain points of the scale of common barometers, have no further foundation in fact than what has just been stated, and are therefore simply useless. Sufficient has now been said to show the importance of barometric observations in meteorology, and we must refer to the works on this science for the details of the subject.

Mariotte's Law.

(163.) *Statement of Mariotte's Law.*—We have already stated that gases obey a special law of compressibility. This law was discovered independently by the Abbé Mariotte in France, and by the famous English philosopher Boyle, during the last half of the seventeenth century. It may be thus stated: *The volume of a given weight of gas is inversely as the pressure to which it is exposed*; that is, the greater the pressure, the smaller is the volume, and the less the pressure, the larger is the volume. This may be illustrated by an India-rubber bag holding one litre of air or any other gas. This is exposed to a pressure, under the ordinary conditions of the atmosphere, of a little over one kilogramme on every square centimetre of surface. If this pressure is doubled, the volume of the bag will be reduced to one half; if trebled, to one third, etc. On the other hand, if the pressure is reduced to one half, the volume will be doubled; if to one third, the volume will be trebled,* etc. The principle is expressed in mathematical language by the proportion,

$$V : V' = H' : H, \quad [98.]$$

* We suppose the bag to have no elasticity.

in which H and H' are the heights of the barometer which measure the pressure to which the gas is exposed under the two conditions of volume V and V' .

It follows from [52], that the density of a given weight of gas is inversely as the volume, or $V : V' = D' : D$; and by comparing this proportion with the last, we obtain

$$D : D' = H : H'; \quad [99.]$$

or the density of a gas is proportional to the pressure to which it is exposed. Moreover, since the weight of a given volume of gas is proportional to the amount of matter which it contains (its density), and its density, as just proved, proportional to the pressure, it follows that *the weight of a given volume of gas is directly as the pressure to which it is exposed*; or

$$W : W' = H : H'. \quad [100.]$$

These three proportions are very important, and will be constantly referred to in the following pages. The student must be careful to notice, that in [98] the weight of gas is supposed to be constant and the volume to vary, and in [100] the volume is supposed to be constant and the weight to vary. It is unnecessary to add, that, as the volumes of gases vary also with the temperature, the law of Mariotte is true only so long as the temperature remains constant.

The variations in the pressure of the atmosphere, amounting at times to one tenth of the whole, necessarily cause equally great changes in the volume of gases which are the objects of chemical experiment. Hence, in order to compare together different volumes of gas, it is essential that they should have been measured when exposed to the same pressure. A standard pressure has therefore been agreed upon, that measured by seventy-six centimetres, to which the volumes of gases measured under any other pressure must always be reduced.

(164.) *Experimental Illustration.* — The law of compressibility of gases may be readily illustrated by the following experiments, which were devised by Mariotte himself.

For pressures greater than the atmosphere, we use the apparatus represented in Fig. 268, which consists of a glass tube bent in the form of a siphon, closed at the end B , and fastened to a wooden support. At the side of each arm of the bent tube is

placed a graduated scale, the zero point of the two scales being on the same horizontal line. The scale at the right of the long arm indicates centimetres, and measures the heights of the mercury columns, while that at the left of the short arm measures the volume of confined gas in the closed end of the tube. In commencing the experiment, mercury is poured into the tube at the end *C*, and by inclining the apparatus is brought, with a little manipulation, to stand at the zero point on both scales. The volume of air confined in the tube *AB* is now evidently exposed to the pressure of the atmosphere, which is equivalent to about 76 c. m. of mercury. If, now, we pour mercury into the tube *C* until the difference of level of the mercury in the tubes is 76 c. m., the confined air will be exposed to a pressure of two atmospheres, and its volume will be reduced one half, as is represented in the figure. If the tube were sufficiently long, so that we could make the difference of the two columns equal to 152 c. m., the volume would be reduced to one third. Were the difference made equal

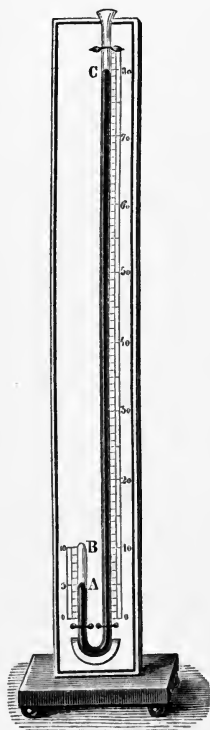

Fig. 268.

to three or four times 76 c. m., the volume would be reduced to one fourth or one fifth.

For pressures less than an atmosphere, we use the apparatus represented in Fig. 269, consisting of a barometer tube divided into cubic centimetres, and a deep mercury cistern, to the side of which is fastened a scale divided into centimetres for measuring the differences of level. The experiment is commenced by filling the barometer tube nearly to the top with mercury,

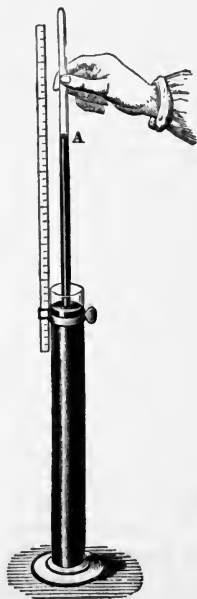

Fig. 269.

leaving a space of only ten cubic centimetres filled with air. The tube, being closed with the thumb and inverted, is sunk in the mercury cistern until the mercury in the tube and the cistern stands at the same level and at the tenth division on the tube. The confined air in the tube, measuring in volume ten cubic centimetres, is now evidently exposed to the pressure of the atmosphere, which we will suppose equivalent to 76 c. m. of mercury. If, now, we raise the tube in the reservoir, the level of the mercury in the tube will rise above that in the cistern, as represented in the figure. The confined air is now exposed to a less pressure than 76 c. m. by exactly the difference of level; because, as can easily be seen, the pressure of the atmosphere is in part expended in supporting the column of mercury, and only the remainder of its pressure is exerted on the confined air. When, therefore, the height of the column of mercury in the tube above the mercury level in the cistern is 38 c. m., the pressure on the confined air is $76 - 38$ c. m., or one half of an atmosphere, and its volume will be found to have doubled. When the difference of level is equal to $50.666+$ c. m., the pressure on the confined air is $76 - 50.666+ = 25.3+$ c. m., or one third of an atmosphere, and its volume will be found to have trebled. When the difference of level is equal to 57 c. m., the air is exposed to the pressure of only one fourth of an atmosphere, and its volume will be found to have quadrupled.

(165.) *History of Mariotte's Law.* — The law of the compressibility of gases, as established by Mariotte,* was for a long time received as absolute and invariable; for although Boyle† and Musschenbroek ‡ found that the compressibility diminished with the pressure, on the other hand Sulzer§ and Robinson|| found that it increased with the pressure; and these obviously inaccurate results do not appear to have diminished the general confidence in the law. In 1826, Oersted and Swendsen ¶ repeated the experiments of Mariotte, extending their investigation

* Œuvres de Mariotte, (La Haye, 1740,) Tom. I. p. 152.

† Boyle's Defence of his Doctrine touching the Spring and Weight of the Air. Works, Vol. I. (folio.)

‡ Cours de Physique, (Paris, 1759,) Tom. III. p. 142.

§ Mémoires de l'Académie de Berlin, 1753, p. 116.

|| System of Mechanical Philosophy, Vol. III. p. 637. Also, Encyclopædia Britannica, Article *Pneumatics*, Vol. XVI. p. 700.

¶ Edinburgh Journal of Science, Vol. IV. p. 224.

to pressures of eight atmospheres, and apparently confirmed the accuracy of the law; for although the numbers they obtained indicate a greater compressibility than would accord with the law, yet they attributed the differences to errors of observation. They afterwards extended their investigation to greater pressures than eight atmospheres; but the method of experimenting* which they employed was too rude to establish the absolute accuracy of the law, although it was sufficiently exact to show that the law was approximatively true up to very high pressures.

At the time when the law was thus universally admitted as absolutely accurate, M. Despretz † investigated the subject from a new point of view. Without questioning the law in regard to air, he merely sought to ascertain whether all gases obeyed exactly the same law, or whether, when submitted to the same pressure, they indicated different degrees of compressibility. His experiments were conducted in the following way. He took a number of cylindrical tubes, closed at the top and of the same height, and filled one of them with air, but the rest with different gases. These were then arranged side by side, standing in a res-

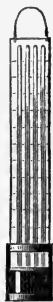

Fig. 270.

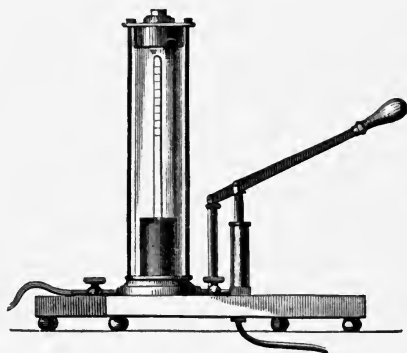

Fig. 271.

ervoir of mercury, and supported against a graduated scale, as represented in Fig. 270. The apparatus thus arranged was in-

* They condensed the air, by means of a force-pump, into the chamber of an air-gun. Then by means of a balance they determined the weight of air introduced, and, knowing the volume of the chamber, they easily calculated its density. Lastly, they determined the elastic force of the condensed air with the aid of a *safety-valve*. This valve was closed by a weight acting on the arm of a lever; and in the experiments the weight was moved along the arm until the elastic force of the confined air raised the valve.

† *Bullet. des Sciences, Sect. I. Tom. VIII. p. 325. Also, Annales de Chimie et de Physique, 2^e Série, Tom. XXXIV. pp. 335, 448.*

troduced into a glass cylinder full of water, similar to that represented in Fig. 271. This cylinder is connected with a small force-pump, by which water may be forced into it, and a pressure thus exerted on the surface of the mercury in the basin. Before commencing the experiment, the level of the mercury is made the same in all the tubes as in the basin, so that the gases they contain are submitted to the pressure of the atmosphere. On increasing the pressure by forcing water into the cylinder, it is evident that, if the gases all obeyed Mariotte's law, they would all suffer the same amount of condensation; for example, when the pressure had reached two atmospheres, the volume of each gas would be reduced to one half, and so on. Moreover, since the tubes are perfectly cylindrical, an equal condensation would be indicated by an equal rise of the mercury; and therefore, if the law were general, the level of the mercury would be the same in all the tubes, however great the pressure. It is evident, also, that, if the law is not absolutely general, the apparatus was exceedingly well calculated to detect the discrepancy; since a very slight difference in the level of the mercury could easily be distinguished. In fact, Despretz found, on increasing the pressure progressively, that the mercury rose in each tube, but rose unequally. Carbonic acid gas, sulphide of hydrogen, ammonia gas, and cyanogen, were compressed under the same circumstances more than air, and the difference increased as the pressure was augmented. With hydrogen, on the other hand, a contrary effect was observed. This gas acted like air until the pressure rose to fourteen atmospheres; but under greater pressure than this it was compressed less than air, and consequently maintained a greater volume.

These experiments, in which errors are almost impossible, — since the gases are placed under identically the same conditions, — proved that the law as enounced by Mariotte is not universal, and that each gas has a special law of compressibility.* More recently these results have been confirmed by Pouillet,† who constructed an apparatus on a similar principle, by which he was enabled to continue the experiment up to very great pressures.

* Oersted, *loc. cit.*, had previously noticed that sulphurous acid gas was condensed more than air, when submitted to the same pressure in an apparatus very similar to that described above; but he attributed the phenomena he noticed to a partial condensation of the gas to a liquid, and not to a deviation from Mariotte's law.

† Pouillet, *Elements de Physique*, 5^{me} edition, Tom. I. p. 339.

The experiments of Despretz had proved that the law of Mariotte was not general; but it was still supposed to hold true of air, and of the gases of which air consists. This opinion was soon after apparently confirmed by the celebrated investigation of Arago and Dulong on the elastic force of steam at high temperatures, made under the direction of the French Academy of Sciences, at the request of the government.

As a preliminary to the main object, these distinguished physicists determined the amount of diminution of volume of atmospheric air under increasing pressure up to twenty-seven atmospheres. The method which they employed was precisely the same as that of Mariotte. The volume of the air was measured in a vertical glass tube one hundred and seventy centimetres long, graduated into parts of equal capacity, and forming the short arm of an inverted siphon. The pressure was exerted by means of a column of mercury in a glass tube twenty-six metres high, forming the longer arm of the siphon; and it was determined by measuring the difference of level of the mercury in the two tubes.

Although this apparatus was precisely similar in principle to that of Mariotte, it was a vast improvement upon it, and would stand in the same relation to Mariotte's simple tube that a modern chronometer does to a common watch. If we had space, it would be interesting to describe the apparatus in detail, in order to illustrate the advance which was made in experimental science during the century and a half which had elapsed since the death of Mariotte in 1684; but we must refer the student to the original memoir,* which was presented to the French Academy of Sciences on the 30th of November, 1829.

Arago and Dulong made three different series of observations. In each they commenced with the gas in the measuring-tube under the pressure of an atmosphere, and condensed it progressively by increasing the column of mercury in the long tube until it attained the height of several metres; and after each increase of pressure they measured the volume of the gas and the difference of level of the mercury in the two tubes. In one of these series of experiments, the temperature of the gas was kept constant (at 13°) during the whole time, and the pres-

* Mémoires de l'Académie des Sciences, Tom. X.; and Annales de Chimie et de Physique, 2^e Série, Tom. XLIII. p. 74.

sure increased to twenty-seven atmospheres. It was the best of the three, and we have copied the results in the following table : —

Pressure in Atmospheres. (Approximate.)	Pressure in Centimetres of Mercury.	Volume Observed.	Volume Calculated.	Difference.	Proportion to Observed Volume.
1.00	76.000	501.300			
4.75	361.248	105.247	105.470	+0.223	0.0021
4.94	375.718	101.216	101.412	+0.196	0.0019
5.00	381.228	99.692	99.946	+0.254	0.0025
6.00	462.518	82.286	82.380	+0.094	0.0011
6.58	500.078	76.095	76.193	+0.098	0.0013
7.60	573.738	66.216	66.417	+0.201	0.0030
11.30	859.624	44.308	44.325	+0.017	0.0004
13.00	999.236	37.851	38.132	+0.281	0.0074
16.50	1,262.000	30.119	30.192	+0.073	0.0024
17.00	1,324.506	28.664	28.770	+0.106	0.0037
19.00	1,466.736	25.885	25.978	+0.093	0.0036
21.70	1,653.490	22.968	23.044	+0.076	0.0033
21.70	1,658.440	22.879	22.972	+0.093	0.0040
24.00	1,843.850	20.547	20.665	+0.118	0.0059
26.50	2,023.666	18.833	18.872	+0.039	0.0020
27.00	2,049.868	18.525	18.588	+0.063	0.0035

The first column gives the pressure approximately in atmospheres equal each to seventy-six centimetres of mercury. The second gives the exact pressure, as observed by measuring the difference of level, and subsequently corrected for temperature and the compressibility of mercury. The third column gives the observed volume of gas in the measuring-tube under the given pressure, which was kept at the same temperature during the whole series of experiments. The fourth column gives the volume which the gas would have under the given pressure if Mariotte's law were absolutely true. The fifth column gives the difference between the observed and calculated volumes. And, finally, the sixth column gives the proportion of these differences to the observed volume. It will be noticed that the differences are in all cases very small, seldom greater than one two-hundredth of the observed volume, and frequently almost nothing. Moreover, it will also be noticed that, although the differences are always in the same direction, indicating in every case a greater compression than that required by Mariotte's law, yet the proportion of these differences to the observed volume does not increase

with the pressure, as would naturally be expected, if they were owing to an actual deviation from the law.

As in any investigation of natural phenomena it is impossible to measure quantities with absolute accuracy, a limited amount of error in the observations is to be expected; and since the differences just mentioned are very small, it was natural to conclude that they would have disappeared if the measurements could have been made with absolute accuracy. So concluded Dulong and Arago, and it was generally conceded that the validity of the law of Mariotte in regard to air had been fully established by their investigations. There were, nevertheless, strong grounds for questioning the accuracy of this conclusion. In the first place, there was no reason, in the nature of things, for supposing that the law of Mariotte was absolutely true; and since it was not exact in the case of so many gases, it was reasonable to conclude that it was not absolutely so in the case of the air. In the second place, the volumes observed by Dulong and Arago were in every case less than the calculated volumes, a fact not sufficiently accounted for by the construction of their apparatus, though they were inclined to believe that it was. Then, lastly, their method of experimenting was open to serious objections. They measured the volume of the air, by means of a graduated scale at the side of the tube, with a degree of accuracy which was evidently entirely independent of the volume occupied by the gas in the tube, whether large or small. At the commencement of the experiment, this volume occupied a length of nearly two metres; and hence any error which could be made in reading the scale would be an insensible portion of the whole; but when, at the end of the experiment, the pressure was equal to thirty atmospheres, the volume occupied in the tube a length of only one fifteenth of a metre, so that the same error in reading the scale would now correspond to a portion of the whole volume thirty times as great as before, and might be very important.

The results of Dulong and Arago were not destined long to remain the last word of physical science on this subject. The French government, in 1841, ordered a revision of the principal laws and numerical data connected with the theory of the steam-engine. This work was intrusted to Victor Regnault, and the results of his investigation occupy nearly the whole of the twenty-first volume of the *Memoirs of the French Academy of Sciences*.

This volume is a monument of scientific industry and skill, and marks an epoch in the history of physical science. Among the other numerical data, Regnault carefully redetermined the amount of diminution of volume of atmospheric air under increasing pressure. He repeated the experiments of Dulong and Arago with a greatly improved apparatus, and extended his investigations to other gases. It will not be possible, in this textbook, to enter into a description either of the method or of the apparatus employed. Suffice it to say, that, although they were similar in general to those adopted by Dulong and Arago, they differed in one important detail. Instead of keeping the quantity of the gas in the measuring-tube constant during the whole experiment, as his predecessors in the same line of investigation had done, he continually forced fresh gas, by means of a condensing-pump, into the measuring-tube as the pressure increased, and thus had the volume of gas in the tube the same preparatory to each measurement. The apparatus was so delicately constructed, that he could measure the difference of level of the mercury in the two tubes to nearly the half of a millimetre, and also the volume of the gas in the measuring-tube with as great an accuracy at the highest as at the lowest pressures. We would most earnestly recommend the student to examine the original memoir of Regnault,* as one of the best examples of a successful scientific investigation on record. From the results which Regnault obtained, the following table has been calculated : —

Volumes.	Pressures.					
	Air.	Difference.	Carbonic Acid.	Difference.	Hydrogen.	Difference.
	m.	m.	m.	m.	m.	m.
1	1.0000	+0.0000	1.0000	+0.0000	1.0000	-0.0000
$\frac{1}{5}$	4.9794	+0.0206	4.8288	+0.1722	5.0116	-0.0116
$\frac{1}{10}$	9.9162	+0.0838	9.2262	+0.7738	10.0560	-0.0560
$\frac{1}{15}$	14.8248	+0.1752	13.1869	+1.8131	15.1395	-0.1395
$\frac{1}{20}$	19.7198	+0.2802	16.7054	+3.2946	20.2687	-0.2687

This table supposes that a given volume of gas is taken, not, as usual, under the atmospheric pressure, but under an initial pressure represented by a column of mercury one metre in height, and then, by increasing the height of the column of mercury, successively condensed to one fifth, one tenth, one fifteenth, and one

* Mémoires de l'Académie des Sciences, Tom. XXI. p. 329.

twentieth of its primitive volume. It is evident, that, if Mariotte's law were invariable, it would require, in the case of any gas, pressures corresponding to columns of mercury respectively five, ten, fifteen, and twenty metres high to produce this result. Now, in the table, opposite to each volume, are given the heights of the columns of mercury in metres, which are actually required, as deduced from the experiments of Regnault on air, carbonic acid, and hydrogen. In the case of air and carbonic acid, it will be noticed that less pressure is required than that indicated by the law. In the case of hydrogen, on the other hand, more is required. We might put these results in a form similar to that of the table on page 294, and give opposite to each pressure the observed volume and the calculated volume. It would then appear that air and carbonic acid are condensed more by a given pressure, and hydrogen less, than the amount required by Mariotte's law.

It appears, then, from these experiments, that Mariotte's law is not an exact expression of the truth, even for air. The deviation from the law in the case of air, however, is exceedingly small, and it required all the precautions with which Regnault guarded his experiments to detect and measure it. In a theoretical point of view, this deviation is of the greatest importance; but in the practical application of Mariotte's law in the manometer, and in the determination of the volumes of gases, it may be entirely overlooked.

By carefully examining the table on page 296, it will be noticed that the deviation from the law, in the case of all three of the gases, increases rapidly with the increase of the pressure. This is the general law in regard to all gases which have been studied. Hence we may conclude that, as the pressure diminishes and the gas expands, the deviation from the law of Mariotte becomes gradually less, until, at an infinite degree of expansion, this law would be the exact expression of the truth. Regnault did not, however, extend his experiments to pressures less than that of the atmosphere, because the precision of his method was not sufficient to detect at such pressures any deviation from the law.

The table will also lead us to another important conclusion. On comparing the numbers of hydrogen and of air, it will be found, as we have already remarked, that they deviate from

the law of Mariotte in opposite directions. Starting from a state of infinite expansion, at which both would exactly obey, as just stated, the law, it would be found, on gradually increasing the pressure, that the volume of the air diminished in a greater proportion, but that of hydrogen in a less proportion, than the pressure. Here, then, are two gases, one varying from the law on one side, and the other on the opposite side. Between these two we may conceive of a gas which should have a compressibility exactly conforming to the law. This hypothetical gas being taken as the limit, we have on the one side a class of gases; comprising air, nitrogen, oxygen, carbonic acid, etc., which have a greater and constantly increasing compressibility, and on the other side a single gas, hydrogen, forming a class by itself, and having a less and constantly diminishing compressibility. The law of Mariotte may, therefore, be regarded as a limit, not realized in nature, from which the different gases deviate on either side more or less, according to their nature, as well as according to the pressure to which they are exposed.

Some experiments of Regnault seem to show that the class to which a gas belongs depends upon the temperature. He noticed that, although carbonic acid, as shown by the table, deviates very markedly from the law of Mariotte at the temperature of 0° , yet that it conforms almost precisely to it at the temperature of 100° . He also noticed a similar fact in regard to air, which was found to deviate from the law much less at an elevated temperature than at the ordinary temperature of the atmosphere; and he concludes that a temperature could easily be attained, at which the deviation would become insensible to our means of observation. He even thinks it probable, that, at a very high temperature, the air would again deviate from the law of Mariotte, but in the opposite direction, namely, that in which hydrogen deviates at the ordinary temperature.*

Generalizing these observations, it is supposed that the same would be true of all the gases belonging to the first class. As the temperature is increased, it is supposed that their compressibility would gradually diminish, and that they would finally conform exactly to Mariotte's law, at different temperatures, determinate for each one. If the temperature were pushed

* Mémoires de l'Académie des Sciences, Tom. XXI. p. 403.

beyond this limit, it is supposed that they would deviate anew from the law, but in an opposite direction, passing over into the class of gases of which at the ordinary temperature we have but one example, hydrogen. On the other hand, since hydrogen possesses at the ordinary temperature of the air the character which those gases have at a high temperature, it is natural to conclude that, by lowering the temperature sufficiently, we should bring this gas to the condition in which they exist at the ordinary temperature. We should expect to find, that, at a certain degree of cold, it would conform exactly to the law of Mariotte; and that, at a still lower temperature, it would deviate from that law again, but in an opposite direction. It must be admitted, however, that, although these conclusions are in conformity with the analogies of science, they are based upon too slight experimental data to make them of much value; and further experiments on the compressibility of gases at high temperatures are among the most important desiderata of this branch of science.

Within the last few years, further experiments on the condensation of air, nitrogen, oxygen, hydrogen, and oxide of carbon have been made by Natterer with a very powerful condensing-apparatus, with which he has been able to exert a pressure of nearly three thousand atmospheres. Even with this immense pressure, he did not succeed in condensing these gases to liquids; but, on the contrary, he found that the compressibility in all the five cases was *less* than that required by Mariotte's law. From his results, the following table* has been calculated by interpolation:—

Pressure in Atmospheres.	Number of Volumes condensed into One.				
	Hydrogen.	Oxygen.	Nitrogen.	Air.	Oxide of Nitrogen.
1	1	1	1	1	1
50	50	50	50	50	50
100	98	100	99	100	100
500	396	439	381	396	412
1,000	623	595	519	527	544
1,354	..	657
1,500	776	..	590	607	617
2,000	899	..	611	661	669
2,500	977.5	..	684	704	708
2,790	1008	..	705	726	727

* This table is taken from Liebig und Kopp, Jahresbericht für 1854, Seite 88. For the full results, see Wien Acad. Ber. XIL 199, or Pogg. Ann., XCIV. 436.

Opposite to the number of atmospheres of pressure is given for each of the five gases the number of volumes which are condensed by the different pressures into one volume. In other words, these numbers represent the number of volumes into which one volume of the condensed gas would expand, if allowed to expand freely under the pressure of the atmosphere. If the gases followed the law of Mariotte, the number of volumes would always be equal to the number of atmospheres of pressure. According to these experiments, the number is very much less than this, showing that at these high pressures the compressibility is very greatly diminished. It will be noticed that these results are in accordance with those of Regnault in regard to hydrogen, but directly opposite to them in regard to the other gases. Since, however, the experiments of Naterer were conducted in a manner not calculated to give accurate numerical results, they require further confirmation.

We have dwelt at some length on the history of Mariotte's law, both because it furnishes one of the best examples of refined scientific investigation, and also because it illustrates in a very forcible manner the character of a very large class of the so-called *laws of nature*. The compressibility of gases was in the first place studied with a comparatively rude apparatus, and a simple law was discovered, which was accepted as the absolute truth. Later, when the methods of investigation had become more accurate, it was found that the law was not general, but it was still maintained in regard to air, until finally the refined experiments of Regnault proved that it failed here also. Still the law remains as an ideal truth towards which nature tends, but which is never fully reached, and we can even trace the action of the agents which produce the perturbations. So is it with most physical laws. They are not relations realized with mathematical exactness, but ideal truths always more or less false in each particular case. In another place,* the author has termed this class of laws, which are merely expressions of external phenomena, *phenomenal laws*. In some few cases, as in the law of gravitation, we have been able to go behind the phenomena to their proximate cause; and in such cases the very variations have been seen to be necessary consequences of the law itself. So, possibly, it will be with

* Memoirs of the American Academy of Arts and Sciences, Vol. V. p. 369.

the law of Mariotte, when we understand the constitution of the gaseous condition of matter. But even in regard to the law of gravitation, there always have been residual phenomena unexplained by the law, and so probably there always will be; until, as we go on widening our generalizations, the last generalization of all brings us into that Presence of which all natural phenomena are the direct manifestation.

(166.) *Limit to the Compressibility of Gases.* — It has been shown that all gases, when submitted to pressure, are, with one exception, compressed to a smaller volume than that calculated from the law of Mariotte; and we have also seen that the deviation from the law increases rapidly with the pressure. With most gases, however, experiments prove that the compressibility does not increase indefinitely; but that, when the pressure reaches a certain point, the gas changes into a liquid. This change of state takes place suddenly, but it is preceded by the increase of the compressibility of the gas, which has just been noticed, and which becomes very rapid as the point of condensation is approached. Some persons have been led by this fact to the opinion that the deviation from the law of Mariotte is owing to a partial liquefaction of the gas; but the experiments of Regnault and Despretz, already cited, tend to disprove this theory. The pressure under which the condensation to the liquid state takes place depends upon the nature of the gas, and also especially on the temperature. We shall, therefore, defer the consideration of this subject to the chapter on Heat.

Application of Mariotte's Law.

(167.) *Pressure of the Atmosphere at different Heights.* — Having become familiar with Mariotte's law, we are prepared to study the variation of pressure as we rise in the atmosphere, which has been already noticed in (156. 3). This question is evidently one of great importance; because, if we can discover the law by which the pressure varies, we can easily deduce from two observations of the barometer made at different heights the difference of level of the two stations.

It is evident, from the nature of the case, that the density of the atmosphere must vary constantly with the elevation above the surface of the earth, and hence that it is not absolutely the same at any two levels, however near to each other. Neverthe-

less, for convenience, we will suppose that the atmosphere consists of a series of very thin concentric layers, having a common thickness, which we will represent by d ; and that the density is uniform throughout each layer, changing abruptly as we pass from one to the next. Moreover, in order to reduce the question to its simplest form, we will suppose that the temperature of the atmosphere at the different elevations is the same, and at 0° C. We may now represent the different quantities to be used in our problem thus:—

d = the common thickness of the concentric layers.

$x_1, x_2, x_3 \dots x_n$ = the distances of the lower surfaces of the successive layers from the centre of the earth.

$H_1, H_2, H_3 \dots H_n$ = the heights of the barometer in the successive layers.

$(Sp. Gr.)_1, (Sp. Gr.)_2 \dots (Sp. Gr.)_n$ = the specific gravity of the air in the successive layers, referred to mercury.

We have, then, for the thickness of the first layer, $x_2 - x_1 = d$, and for the fall of the column of mercury in the height of the first layer, $H_1 - H_2$. It is therefore evident, that a column of atmospheric air equal to $x_2 - x_1$ supports a column of mercury equal to $H_1 - H_2$. Now, since the air acts in all respects, so far as regards pressure, like a liquid of a very small specific gravity (151), it follows that the proportion [81] is true for these two columns of air and mercury. Representing, then, the specific gravity of mercury by unity, we have

$$\begin{aligned} H_1 - H_2 : x_2 - x_1 &= (Sp. Gr.)_1 : 1, \\ \text{or} \quad (Sp. Gr.)_1 &= \frac{H_1 - H_2}{x_2 - x_1} = \frac{H_1 - H_2}{d}. \end{aligned} \quad [101.]$$

Moreover, since the pressure is proportional to the density [99], it is also proportional to the specific gravity; and we have, for any two layers, such as the first and the n th,

$$\begin{aligned} (Sp. Gr.)_1 : (Sp. Gr.)_n &= H_1 : H_n, \\ \text{or} \quad (Sp. Gr.)_1 : H_1 &= (Sp. Gr.)_n : H_n. \end{aligned}$$

Representing by C a constant quantity, we may evidently put

$$(Sp. Gr.)_1 = C H_1, \quad \text{and} \quad (Sp. Gr.)_n = C H_n. \quad [102.]$$

The value of C depends upon the latitude of the place and on the conditions of the atmosphere, as will hereafter be shown.

Comparing the two values of (*Sp. Gr.*)₁, [101] and [102], we obtain

$$\frac{H_1 - H_2}{d} = C H_1, \quad \text{or} \quad H_2 = H_1 (1 - C d).$$

By the same course of reasoning we should obtain

$$\frac{H_2 - H_3}{d} = C H_2, \quad \text{or} \quad H_3 = H_2 (1 - C d) = H_1 (1 - C d)^2.$$

We can in like manner readily form the following table:—

$$\begin{array}{ll} x_1 & = 0, & H_1 = H_1. \\ x_2 - x_1 & = d, & H_2 = H_1 (1 - C d) = H_1 (1 - C d). \\ x_3 - x_1 & = 2d, & H_3 = H_2 (1 - C d) = H_1 (1 - C d)^2. \\ x_4 - x_1 & = 3d, & H_4 = H_3 (1 - C d) = H_1 (1 - C d)^3. \\ \cdot & \cdot & \cdot \\ x_{n+1} - x_1 & = nd, & H_{n+1} = H_n (1 - C d) = H_1 (1 - C d)^n. \end{array}$$

The values $d, 2d, 3d \dots nd$, which represent the elevations above any given level, are evidently terms of an increasing arithmetical progression; and the values of $H_1, H_2, H_3 \dots H_n$, which represent the pressures at these elevations, are evidently terms of a geometrical progression, — since each value is formed from the preceding by multiplying by the constant quantity $(1 - C d)$. Moreover, since the value of this quantity is less than unity, the progression is decreasing.

From the equation $H_{n+1} = H_1 (1 - C d)^n$, we can easily obtain a formula for calculating the difference of elevation from the height of the barometer at any two stations. Taking the logarithms of the two members, this equation becomes

$$\begin{aligned} \log H_{n+1} - \log H_1 &= n \log (1 - C d), & \text{or, developing,} \\ &= n \frac{1}{M} \left(- C d - \frac{1}{2} C^2 d^2 - \frac{1}{3} C^3 d^3 - \dots \right). \end{aligned}$$

We have assumed that the common thickness of the atmospheric layers (d) was only very small. We may now pass at once to the actual condition of the atmosphere by making d infinitely small. The $d^2, d^3 \dots$, being all infinitely less than d , may be taken at zero, and the equation becomes

$$\log H_{n+1} - \log H_1 = - n d \frac{C}{M};$$

or, changing the signs of all the terms,

$$\log H_1 - \log H_{n+1} = n d \frac{C}{M};$$

from which can be easily deduced

$$nd = \log \frac{H_1}{H_{n+1}} \cdot \frac{M}{C}.$$

In this formula, nd is obviously the sum of the thicknesses of the infinitely thin layers between the levels of the two stations, and is therefore the quantity required. We will represent it by x . M is the modulus of the common tables of logarithms, or 2.302585.* C is the constant already mentioned. H_{n-1} is the height of the barometer of the upper station, which we can more conveniently represent simply by h ; and H_1 the height at the lower station, which we can more conveniently represent by H . The formula then becomes

$$x = \log \frac{H}{h} \cdot \frac{M}{C}. \quad [103.]$$

The constant, C , in this equation is a quantity which, multiplied by the height of the barometer, will give the specific gravity (relatively to mercury) of the air in which the barometer is immersed [102]. We shall hereafter have occasion to show that the weight of one cubic centimetre of air, and hence also its specific gravity, varies not only with the pressure H , but also with the elastic force of the vapor which it contains, with the temperature, and with the intensity of the force of gravity at the place of observation. All these circumstances must, therefore, modify the value of the constant C . If, however, we reduce the conditions to their simplest form, and suppose that the temperature is 0° C. at both stations, that the place of observation is on the parallel of 45° , and that the atmosphere is one half saturated with vapor, we have, for the value of the constant, $\frac{M}{C} = 18,336$ metres; and, neglecting the variation of the intensity of gravity with the elevation, [103] becomes †

$$x = \log \frac{H}{h} 18336 = \log H 18336 - \log h 18336; \quad [104.]$$

* Some writers use as M the reciprocal of this value.

† It is evident that these conditions are never realized in the atmosphere. The temperature diminishes very rapidly as we ascend; and the force of gravity varies with the elevation, as well as with the latitude of the place of observation. In the practical application of this method in determining differences of level, it is necessary to pay regard to all these circumstances. The eminent mathematician La Place calculated a formula for finding the value of x , in which all the causes which may modify the pres-

in which H and h denote the height of the barometer in millimetres. If, further, we suppose that the lower station is at the sea level, and that the barometer at this level is at its mean height, or 760 m. m., the formula becomes

$$x = 52,822.6 \text{ metres} - \log h \ 18336. \quad [105.]$$

sure of the different layers of the atmosphere have been considered. In this formula, the letters denote the following values:—

H = height of barometer at the lower station.

T = temperature of barometer at the lower station.

t = temperature of the air at the lower station.

h' = height of barometer at the upper station.

T' = temperature of barometer at the upper station.

t' = temperature of the air at the upper station.

λ = latitude of the place of observation.

x = in the fourth factor the approximate height determined from the previous factors.

The formula of La Place is then as follows:—

$$x = [\log \overset{1.}{H} \ 18336 - \log \overset{2.}{h'} \ 18336 - (T - T') \overset{3.}{1.2843}] \times \begin{cases} \left(1 + \frac{2(t+t')}{1000}\right), \\ \left(1 + 0.00265 \cos 2\lambda\right), \\ \left(1 + \frac{x + 15926}{6366198}\right), \end{cases}$$

which does not differ materially from the complex equation of the *Mécanique Celeste* (Œuvres de La Place, Tom. IV. p. 328, Paris, 1845). The terms and factors of the formula have been numbered for the sake of reference. The first two terms are the same as in [104], and give the approximate elevation. The third term is a correction for the difference of temperature of the mercury columns at the stations. The corrected altitude is now to be multiplied by three factors. The first (marked 4) corrects it for the difference of temperature of the air at the two stations; the second (5), for the variation of gravity with the latitude; and the third (6), for the variation of gravity with the elevation. The calculation of the value of x is rendered exceedingly easy by means of a set of tables, originally prepared by Oltmans, which are given in the *Annuaire du Bureau des Longitudes* of Paris. Similar but more extended tables, calculated by Delcros, Guyot, and Loomis, are contained in the collection of Meteorological Tables prepared by Professor Arnold Guyot, and published by the Smithsonian Institution.

M. Babinet (*Comptes Rendus de l'Académie des Sciences* for March, 1857) has proposed a modification of La Place's formula, which dispenses both with the use of logarithms and with tables of any kind. The notation is the same as before, but the two barometers are supposed to be reduced to the same temperature, and the small correction for the latitude is omitted. The modified formula is as follows:—

$$x = 16,000 \text{ metres} \frac{H_0 - h_0}{H_0 + h_0} \left(1 + \frac{2(t+t')}{1000}\right).$$

In using this formula, the two heights of the barometer must first be reduced to zero, and it will then give accurate results for elevations of less than 1000 metres, and approximate results even for much greater elevations. For further information on this

From this formula, it is easy to calculate the pressure and specific gravity of the atmosphere at different elevations, on the assumption that its condition is as just supposed; and by means of it the following table has been constructed.

Pressure and Specific Gravity of the Air at increasing Altitudes.

Metres above the Sea.	Bulk of equal Weight of Air.	Specific Gravity. Air at 76 c. m. = 1	Height of Barometer.
0	1 c. m. ³	1	76.00
5,520	2 "	$\frac{1}{2}$	38.00
11,040	4 "	$\frac{1}{4}$	19.00
16,560	8 "	$\frac{1}{8}$	9.50
22,080	16 "	$\frac{1}{16}$	4.75
27,600	32 "	$\frac{1}{32}$	2.38

This table illustrates the fact already stated on page 303; for while the elevation above the sea level increases in an arithmetical progression, the height of the barometer and the specific gravity diminish in a geometrical progression. Dr. Young has calculated that, if the air continues to diminish in specific gravity according to the law indicated in the above table, one cubic inch of air, of the mean specific gravity at the earth's surface, would, at a distance of four thousand miles from the earth (a distance

subject, we would refer the student to the excellent collection of tables by Professor Guyot, already mentioned.

In taking observations of the barometer for the purpose of measuring heights, certain precautions are indispensable, in order to obtain good results. If the horizontal distance between the stations is considerable, it is necessary to make the two observations simultaneously, in order to eliminate the effect of the accidental changes to which the barometer is liable; or, if this is impossible, to return to the first station, and ascertain whether the pressure has changed in the interval. If it has, the observation should be rejected. But even this method of observing will not eliminate the effects of the regular changes, because these are not necessarily the same at the two stations, and do not take place at precisely the same moment, especially when the difference of elevation is considerable. The same is also more or less true of the accidental changes. In order to eliminate all these causes of error, it is best to make a great number of observations simultaneously at both stations, and to take the mean; and this course is essential when the two stations are several miles apart. For example, in finding the elevation of a place above the sea level, it is best to take the barometric mean of the place, calculated from observations extending over several years, and compare it with a similar mean taken at the sea level. In the tropics, where the accidental variations barely exist, and where the regular variations follow well-known laws, accurate results can be obtained by taking successive observations at the different stations. With good instruments and careful observation, the difference of level can be ascertained, from the formula of La Place, within a metre.

equal to the earth's radius), fill the whole orbit of Saturn ; and, on the other hand, if a mine could be dug forty-six miles deep into the earth, that the air at the bottom would be as dense as quicksilver.

It has already been stated, that there is probably a limit to the upper surface of our atmosphere, as definite as that of the surface of the ocean. At this elevation, the repulsive force of the particles is supposed to be balanced by their gravitation towards the earth. If we assume that, at this point, the repulsive force is equal to a column of mercury one millimetre high, we can easily calculate the height of the atmosphere. The second term of the second member of [105] disappears, since $\log 1 = 0$, and we obtain $x = 52,822.6$ metres. But this assumes that the temperature is the same at this high elevation as at the surface, namely, 0° . The probability is that the temperature is about -60° C. We must, therefore, make a correction for this difference, amounting, as follows from La Place's formula, (see note, p. 304,) to 0.12 of the whole, which reduces the height to 46,483.9 metres.

Instruments illustrating the Properties of Gases.

(168.) *Manometers.* — This name (derived from $\mu\alpha\nu\acute{o}\varsigma$, *rare*, and $\mu\acute{\epsilon}\tau\rho\nu$, *measure*) is applied to a class of instruments which are used for measuring the elastic force or pressure of confined gases and vapors. Of the numerous forms of the manometer, we shall describe but three.

1. For pressures less than the atmosphere, the most convenient form of manometer for the laboratory is that represented in Fig. 272, at the side of the barometer. It consists simply of a tube, open at both ends. The lower end dips into a reservoir of mercury, and the upper end connects, by a flexible hose, with the vessel containing the gas or vapor whose pressure we wish to measure. If the gas exerts no pressure, or, in other words, if there is a vacuum in the vessel, it is evident that the mercury will stand at the same height in the tube as in the barometer ; and, on the other hand, if the gas exerts pressure, the mercury will be depressed by the exact amount of this pressure. By measuring with a cathetometer the difference of level in the barometer and manometer tubes, we can ascertain the exact amount of the pressure, or tension, of the confined gas.

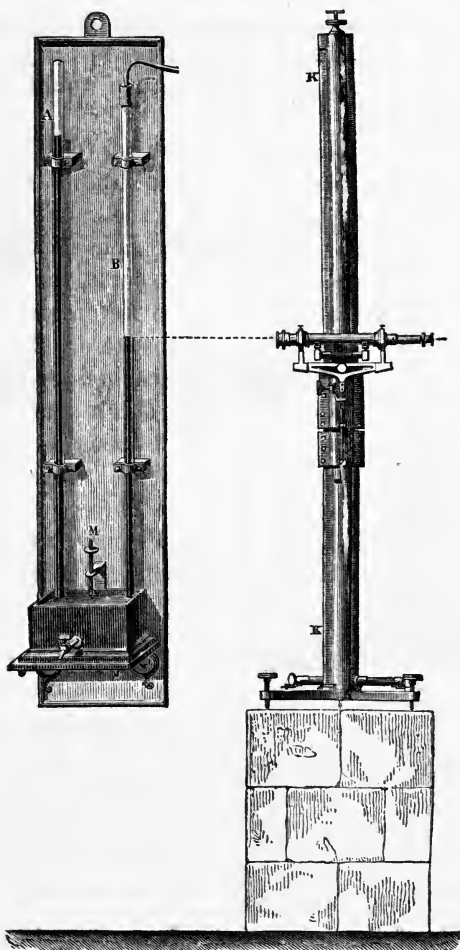

Fig. 272.

2. The form of manometer represented in Fig. 273, which we owe to Regnault, may be used both for pressures greater and less than that of the atmosphere. It consists of two glass tubes, $g h$ and $i k$, which are cemented into an iron U, (made as represented in Figs. 276, 277, and 278,) and form together an inverted siphon. Between the two arms of the siphon, and forming a part of the iron U, is placed a three-way cock, whose construction is sufficiently explained by the figures. According to the position which we give to this cock, we may either open or close the communication between the glass tubes, or vent the mercury

from either tube alone, or from both together, at pleasure. The tube *i k* is open at the top, and the mercury column which it contains receives the pressure of the atmosphere. The tube *g h*

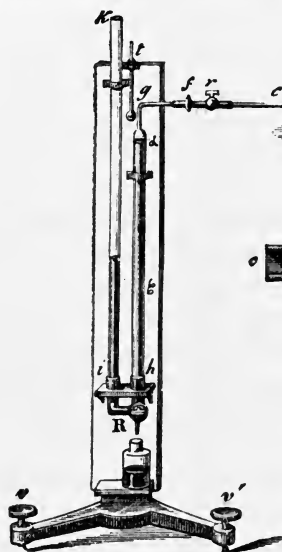

Fig. 273.

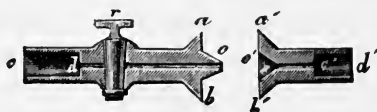

Fig. 274.

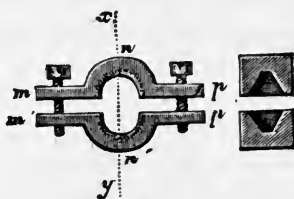

Fig. 275.

terminates in a capillary tube, which is bent at right angles, and connected with the vessel, *a b*, containing the gas or vapor whose elasticity we wish to measure, by a connection of peculiar construction, and admirably adapted for experiments of this kind. To the end of the tube *b g* is cemented the steel cap *a' b' d'*, which is represented in Fig. 274. The face of this cap is formed

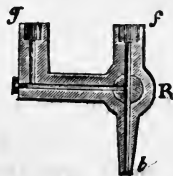

Fig. 276.

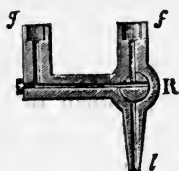

Fig. 277.

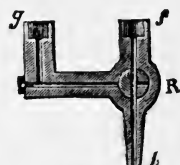

Fig. 278.

by a plane surface, *a' b'*, and by a hollow cone, *o'*. On the other hand, the face of the stopcock which closes the reservoir has exactly a reverse form, and the two are carefully ground together. In order to secure a joint which is absolutely hermetic, it is only necessary to press the two together by means of

a brass collar (Fig. 275), which is tightened by means of the screws, after having interposed a little melted India-rubber. The elasticity of the gas in the reservoir *a b* is measured by the difference of the level of the mercury in the two arms of the tube, and by the height of the barometer. If the level is the same, then it is evident that the elasticity is exactly equal to the atmospheric pressure, and is measured by the height of the barometer. If the level is higher in the tube *h g* than in *i k*, then the elasticity is measured by the height of the barometer less the difference of level. On the other hand, if the level is highest in the tube *i k*, then the elasticity is measured by the height of the barometer plus the difference of level. Representing the elasticity by f , the height of the barometer reduced to 0° by H_0 , and the difference of level, also reduced to the standard temperature, by h_0 , we have in every case

$$\text{f} = H_0 \pm h_0. \quad [106.]$$

3. The form of manometer just described, although an exceedingly accurate instrument, cannot be conveniently used when the elasticity is greater than two atmospheres, because,

when the difference of level exceeds 76 c. m., the tube *i k* must be made inconveniently long, and the instrument becomes difficult to manage. Where great accuracy is not necessary, we can then use with advantage a form of the manometer which is represented in Fig. 279, and which is based on Mariotte's law; for although, as we have seen, this law is not rigorously true, even in regard to air, yet the deviation is so small that it may be regarded as exact for all practical purposes.



Fig. 279.

This third form of manometer consists of a *cylindrical* glass tube, closed at the top and filled with dry air. The lower end of the tube passes through the collar of a cast-iron reservoir, and dips under the surface of the mercury, with which it is in part filled. At the side of the reservoir is an opening which connects by the tube *A* with the closed vessel or boiler containing the gas or vapor whose elastic force is to be measured.

The whole apparatus is fastened to a wooden plank for convenience and security.

The quantity of the air contained in the glass tube is such that, when the opening at *A* communicates with the atmosphere, the mercury stands at the same level in the tube and reservoir. Consequently, opposite to this level on the plank is marked the figure 1. If, now, a pressure is transmitted through *A* equal to two atmospheres, the mercury will rise in the tube until the tension of the confined air, added to the pressure of the mercury column, just balances it. Were it not for the weight of the mercury, it would rise to just one half of the height of the tube; but in fact it rises to somewhat less, because a part of the pressure is supported by the mercury column itself. In like manner, if the pressure is increased to four atmospheres, the mercury does not rise to three quarters of the height of the tube, because the pressure is in part sustained by the column of mercury, and is not, therefore, all transmitted to the confined gas. It is easy to calculate the exact point to which it will rise when the height of the tube is known, and to graduate the instrument by inscribing the number of atmospheres at the side of the tube. This instrument is not sufficiently delicate for high pressures; for, the volume of the air becoming smaller and smaller, the divisions become proportionally close together.

The metallic manometer of Bourdon, based on the elasticity of metals, has been already described (104).

(169.) *Pneumatic Trough.* — This simple contrivance, which we owe to Dr.

Priestley, for collecting and transferring gases, is one of the most valuable instruments of chemistry. It consists usually of a rectangular trough, made of glass or of any other suitable material, in

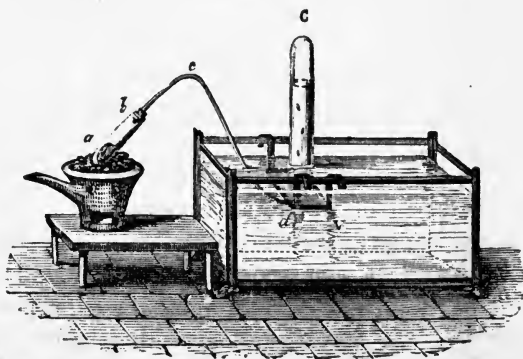

Fig. 280.

which is suspended a shelf, as represented in Fig. 280. The

shelf is perforated with one or more holes, and its under surface is concave. When in use, the trough is filled with water to a level which is one or two inches above the shelf. In order to collect a gas, a glass jar or bell is first filled with water, and then placed on the shelf with its mouth downwards and over the hole. The tube conducting the gas is now adjusted so that its mouth shall open under the shelf, when the gas, as it escapes, will bubble up and displace the water sustained in the jar by the pressure of the air. After one jar is filled with gas, it may be moved to one side, and its place supplied with another, previously filled with water, as before; or the jar may be removed from the trough by sliding under its open mouth, still immersed in water, a plate. On lifting the plate from the trough, it will hold sufficient water to retain the gas in the bell standing on it. We can also readily transfer gases from one jar to another by filling the jar to receive the gas with water, placing its mouth over the hole in the shelf, and then pouring up the gas from the other jar.

A very simple pneumatic trough may be made with an earthen-

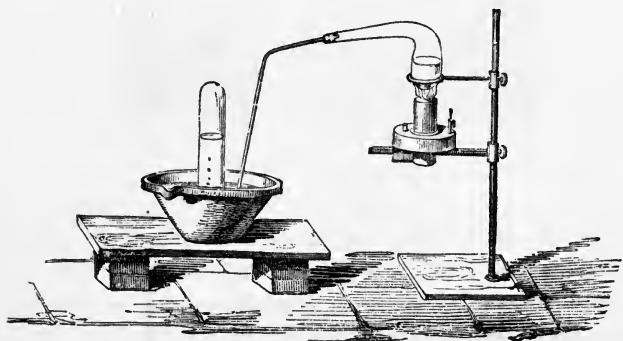

Fig 281.

ware basin of water, as represented in Fig. 281. The jar in which the gas is to be collected can be readily put in its place in the following way. It is first filled with water, and a glass plate pressed with the hand over the mouth. It is then inverted, the mouth plunged under the water of the basin, and the glass plate removed. The mouth of the jar may be conveniently supported on an inverted



Fig. 282.

saucer, in which two holes have been perforated, as represented in Fig. 282. Through the hole at the side passes the end of the tube conducting the gas.

There are many gases which are absorbed by water, and in experimenting on these we use a trough filled with mercury. Such a trough is represented in Fig. 283, and two vertical sections of the same in Fig. 284. On account of the cost of mercury, the mercury trough is made in such a form as to economize as far as possible the metal. In other respects, it is precisely similar to the water-trough, and does not require a detailed description.

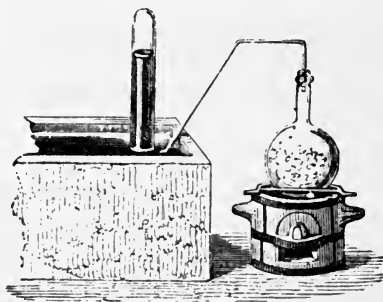

Fig. 283.

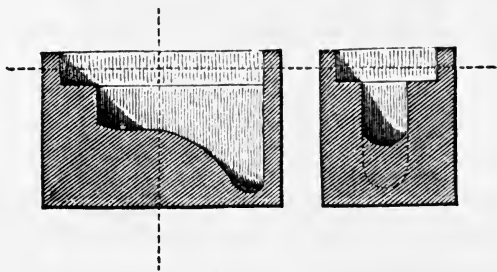

Fig. 284.

In measuring the volume of a gas standing in a graduated bell over the pneumatic trough, it must be remembered that the gas is not exposed to the pressure of the atmosphere as indicated by the barometer, except when the level of the liquid is the same both in the bell and in the trough. When the level is higher in the bell, then the pressure exerted on the gas is evidently measured by the height of the barometer H_0 less the height of a column of mercury h_0 , which is equivalent to the difference of level. If the trough is filled with mercury, this height is equal to the difference of level; if with water, we can always easily find, by [81], the height of the column of mercury, which is equivalent to the difference of water level, or, more readily, by inspection from Table XIX. Let us call this difference of level, reduced to centimetres of mercury at 0°C. , h_0 . In order, then, to reduce the

volume of gas to the standard pressure of 76 c. m., we have, by [98], the proportion

$$V : V' = H_0 - h_0 : 76, \quad \text{or} \quad V = V' \frac{H_0 - h_0}{76}. \quad [107.]$$

The difference of level may always be measured by a cathetometer, or more rudely by a graduated scale. We can also avoid this measurement by sinking or raising the bell in the trough until the level is the same in both (see Fig. 285). This is not, however, so accurate a method.

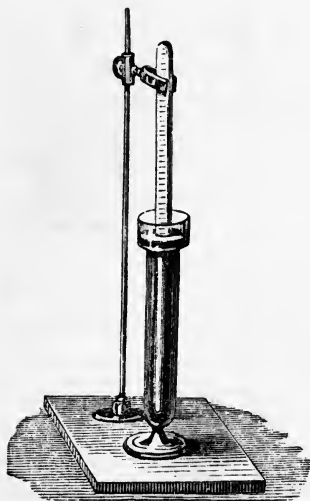

Fig. 285.

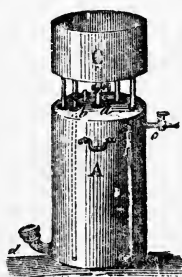

Fig. 286.

(170.) *Gasometers*. — These are instruments for collecting and preserving larger volumes of gas. They have various forms, but that represented in Fig. 286 is one of the most useful. It consists of a closed and air-tight cylindrical vessel, *A*, made of copper or zinc, which is surmounted by a basin, *C*. This basin is supported on the cylinder by five columns of copper, two of which, *a* and *b*, are hollow, and furnished with stopcocks. The tube *a* opens at once into the the top of the cylinder; but the tube *b*, on the contrary, descends quite to the bottom. At *c*, there is a small stopcock for drawing off the gas; and at *d*, a short curved tube, which can be hermetically closed by the screw-plug *k*.

In order to use the instrument, we commence by pouring water into the basin *C*, having first closed the opening *d*, and opened the stopcocks *a* and *b*. The water now flows into the cylinder by the long tube *b*, and the air escapes by the tube *a*, and we continue pouring water into *C* until the cylinder *A* is

completely filled, when we close the stopcocks *a* and *b*. In order, now, to fill the cylinder with gas, we open the tubulature *k*, and introduce the mouth of the tube connecting with the vessel from which the gas is evolved. The pressure of the air sustains the water in the gasometer, and the gas, as it bubbles up, collects in the upper part, displacing the water, which slowly flows from the tubulature. When the evolution of gas has ceased, we remove the tube and close the tubulature *d*.

If now we open the cock *b*, a portion of the water from the vessel *C* descends into the cylinder, and the confined gas is compressed by the force of a column of water equal in height to the difference of level of the water in the two vessels *A* and *C*. Hence, on opening the cock *c*, the gas will flow out, and its place will be supplied with water from the vessel *C*. Or, if we wish to fill a bell with gas, we first fill it with water, cover the mouth with a glass plate, and, having inverted it in the vessel *C*, place it over the tube *a*. On opening the cock, the gas will rise into the bell and displace the water it contains, while an equivalent amount of water will descend by the tube *b* into the cylinder.

(171.) *Safety-Tubes.* — These tubes, which are frequently connected with chemical apparatus for the purpose of avoiding explosions, or preventing the mixing of liquids which the vessels composing the apparatus contain, are excellent illustrations of the properties of gases. Let us suppose, for example, that we are preparing chlorine gas from hyperoxide of manganese and chlorohydric acid, in the flask *A* (Fig. 287), and that connected with this flask by the bent tube *a b c* is a test-glass filled with a solution of caustic soda, on which we wish the gas to act, and which absorbs it rapidly. So long as the chlorine is evolved with great rapidity the process goes on with regularity, and the gas bubbles up through the solution.

The elastic force of the chlorine gas in the flask is evidently greater than the pressure of the atmosphere; because it balances not only the atmospheric pressure on the solution of caustic soda, but also a column of this solution whose height, *a* (Fig. 287), is equal to the difference of level between the surface of the liquid in the test-glass and the open mouth of the gas-

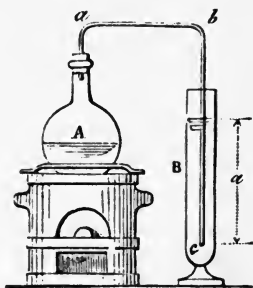

Fig. 287.

tube c . The pressure of the atmosphere is measured by H_0 , the height of the column of mercury which it supports. We may also measure the pressure exerted by the column of liquid a in the same way; for when we know its specific gravity, it is easy, by [81], to find the height of a column of mercury which would exert the same pressure. Let h_0 represent the height of this column of mercury, and $(Sp. Gr.)$ and $(Sp. Gr.)'$ the specific gravities of mercury and the solution respectively; we shall have $a : h_0 = (Sp. Gr.) : (Sp. Gr.)'$, and $h_0 = a \frac{(Sp. Gr.)'}{(Sp. Gr.)}$. Then the elastic force of the gas in the balloon is equivalent to a column of mercury whose height equals the sum of H_0 and h_0 , or

$$h = H_0 + a \frac{(Sp. Gr.)'}{(Sp. Gr.)}. \quad [108.]$$

Let us suppose, now, that from any cause, such as the exhaustion of the materials, or the cooling of the flask, the evolution of chlorine ceases; it is evident that, if the solution continues to absorb the gas contained in the flask A , the elastic force of this gas will constantly diminish, and the pressure of the atmosphere, remaining constant, will cause the liquid to rise in the tube $b c$. If the experimenter is present, he can prevent accident by uncorking the flask; but if the absorption continues, the greater part of the solution may be pressed over into the flask, and the experiment defeated.

Such an accident can be prevented by adjusting to the flask the safety-tube efg , having the form represented in Fig. 288. Into this tube we pour a quantity of the same liquid which is contained in the flask, and which in the present case would be chlorohydric acid. When the process is going on regularly, and the gas is escaping from the mouth of the tube c , the tension of the gas in the flask will raise a column, h , of chlorohydric acid in the tube fg , which must necessarily exert a pressure equal to this tension less the pressure of the air on the top of the column. Hence by [108]

this pressure is measured by a column of mercury which equals $a \frac{(Sp. Gr.)'}{(Sp. Gr.)}$. Moreover, if $(Sp. Gr.)''$ represents the specific

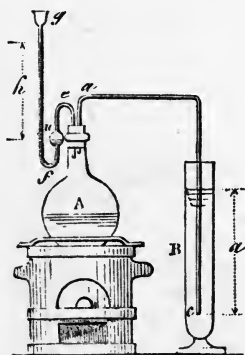

Fig. 288.

gravity of the acid, a column of mercury exerting an equivalent pressure will also be equal to $h \frac{(\text{Sp. Gr.})''}{(\text{Sp. Gr.})}$, and we shall have

$$h \frac{(\text{Sp. Gr.})''}{(\text{Sp. Gr.})} = a \frac{(\text{Sp. Gr.})'}{(\text{Sp. Gr.})}, \quad \text{or} \quad h = a \frac{(\text{Sp. Gr.})'}{(\text{Sp. Gr.})''}. \quad [109.]$$

If now the evolution of gas ceases, and the tension of the gas in the flask becomes less than the pressure of the atmosphere, as before, the liquid will rise in the tube $b c$. But it will also fall in the tube $g f$; and if the parts are properly proportioned, the chlorohydric acid will fall to the lowest point, f , of the safety-tube, before the solution reaches the point b , when air will enter the flask by the safety-tube and prevent any accident. A bulb is blown, at the point u , sufficiently large to hold all the liquid contained in the tube $f g$; and the air, in entering the flask, bubbles through the liquid in this bulb.

This safety-tube is also a security against the bursting of the flask. It not unfrequently happens, in experiments similar to the one just described, that the mouth of the exit-tube becomes clogged by a deposition of solid matter. If, now, the evolution of gas continues, the pressure rapidly increases on the interior of the flask, and soon becomes greater than the thin walls of the vessel can resist, when an accident would result. A safety-tube effectually prevents such a possibility; for when the tension of the gas becomes much greater than the pressure of the atmosphere, the liquid will be driven out of the safety-tube, and the gas can then escape freely into the atmosphere.

The safety-tube also enables us to introduce liquids into the flasks during the experiment, without removing the cork.

When the vessel used for making gas is a retort, the safety-tube may be attached to the exit-tube, as represented in Fig. 289. This peculiar form of safety-tube is called *Welter's tube*, from the name of the chemist who invented it.

In making hydrogen or carbonic acid, we frequently use a two-necked bottle, such as is

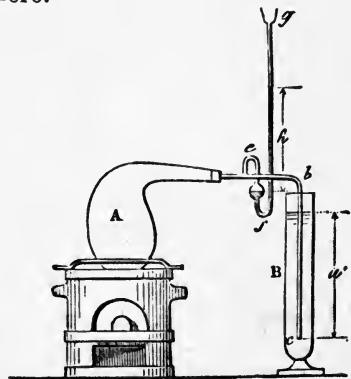

Fig. 289.

represented in Fig. 290. The safety-tube may then be a simple straight tube surmounted by a funnel, and dipping a few millimetres below the surface of the liquid in the bottle. If, as be-

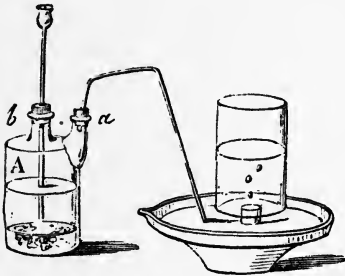

Fig. 290.

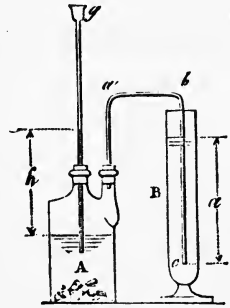

Fig. 291.

fore, we pass the gas into some solution contained in a test-glass (Fig. 291), the tension of the gas in the bottle will raise a column of liquid, h , in the safety-tube, whose height will bear the same proportion to that of the column a (Fig. 289) which the specific gravity of the liquid in the test-glass has to that in the bottle.

It not unfrequently happens, that we wish to transmit the same gas through a series of flasks containing the same or different solutions. Let us suppose that we used the arrangement of three-necked bottles represented in Fig. 292, containing solutions

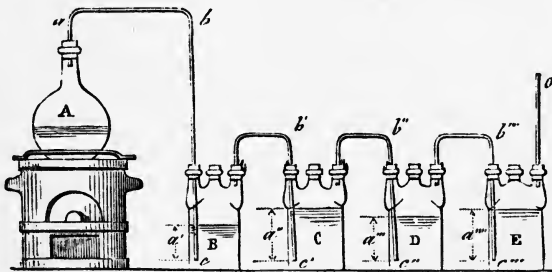

Fig. 292.

which absorb the gas evolved from the flask A , and let us examine what would be the tension of the gas in the successive jars. The gas in the jar E communicates directly with the atmosphere through the tube o , and its tension is therefore represented by the height of the barometer, or H_0 . The tension of the gas in the jar D must evidently be measured by the height H_0 plus the height of a column of mercury which is equivalent to the column

of the liquid in the jar E , indicated by a'''' in the figure. In like manner, the tension of the gas in the jar C will be equal to the tension in D plus a quantity which is measured by a column of mercury equivalent to a'''' ; and so on for C and B . Finally, the tension of the gas in the flask will be equal to the tension in B plus a quantity which is measured by a column of mercury equivalent to a' . If, then, we represent the specific gravities of the liquids in the four bottles by d' , d'' , d''' , and d'''' , and that of mercury by δ , we shall have for the equivalent mercury columns, $a' \frac{d'}{\delta}$, $a'' \frac{d''}{\delta}$, $a''' \frac{d'''}{\delta}$, and $a'''' \frac{d''''}{\delta}$. The measures of the tension of the gas in the four bottles and the flask are, then, as follows:—

In the bottle E H_0 .

$$" \quad " \quad D \quad H_0 + a'''' \frac{d''''}{\delta}.$$

$$" \quad " \quad C \quad H_0 + a'''' \frac{d''''}{\delta} + a''' \frac{d'''}{\delta}.$$

$$" \quad " \quad B \quad H_0 + a'''' \frac{d''''}{\delta} + a''' \frac{d'''}{\delta} + a'' \frac{d''}{\delta}.$$

$$\text{In the flask } A \quad H_0 + a'''' \frac{d''''}{\delta} + a''' \frac{d'''}{\delta} + a'' \frac{d''}{\delta} + a' \frac{d'}{\delta}. \quad [110.]$$

If, now, the evolution of gas ceases in the flask, while the absorption continues in the bottles, it is evident that there will be a transfer of liquid from right to left through the bottles, and from the first bottle to the flask; or, on the other hand, if either of the tubes bc, $b'c'$, should become clogged, the pressure would increase indefinitely in the apparatus, until one of the vessels in front of the obstruction bursts. This would usually be the flask, because it is weaker than the rest. Both of these dangers may be avoided, by arranging the apparatus with safety-tubes, as represented in Fig. 293; for then, if the pressure in the bottles or flask becomes considerable, a portion of the liquid will be forced out at these tubes; or, on the other hand, if it becomes much less than that of the atmosphere, air will bubble in through the same channels.

When the gas is flowing freely from the flask through the apparatus, and bubbling in each bottle, it is easy to calculate the heights to which the liquid will rise in the safety-tubes, since the tension of the gas in the different parts of this apparatus must be the same as in the other. For example, the tension of the gas in D is measured by $H_0 + a'''' \frac{d''''}{\delta}$; but it

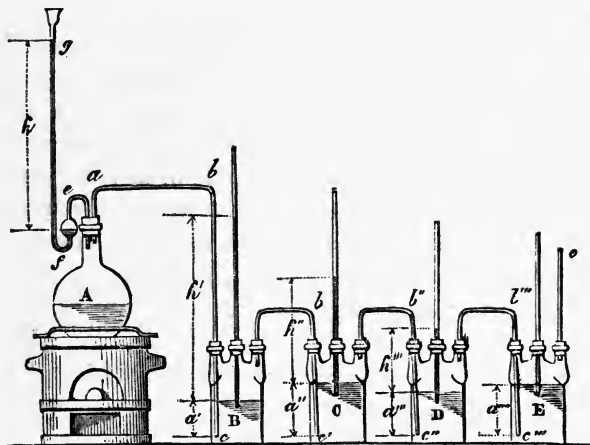

Fig. 293.

must also be measured by H_0 plus a column of mercury equivalent to the column of liquid h''' in the safety-tube. This column of mercury, as is evident from what has been said, is equal to $h''' \frac{d'''}{\delta}$; and hence we have $h''' \frac{d'''}{\delta} = a'''' \frac{d''''}{\delta}$,

$$\text{or} \quad h''' = a'''' \frac{d''''}{d'''}$$

And in like manner we can easily find

$$h'' = a''' \frac{d'''}{d''} + a'''' \frac{d''''}{d''}$$

$$h' = a'' \frac{d''}{d'} + a''' \frac{d'''}{d'} + a'''' \frac{d''''}{d'}$$

$$h = a' \frac{d'}{d} + a'' \frac{d''}{d} + a''' \frac{d'''}{d} + a'''' \frac{d''''}{d} \quad [111.]$$

The apparatus thus constructed is usually called *Wolf's apparatus*.

(172). *Siphon*. — The principle of this well-known instrument is illustrated by Fig. 294. The siphon-tube abc is filled with the same liquid as the two beaker-glasses in which its ends are dipped, and the liquid is sustained in the tube by the pressure of the air. If the level of the liquid in the two vessels is on the same horizontal plane, it is evident that the columns of liquids in the two legs of the siphon will



Fig. 294.

have the same vertical height, and will be in equilibrium. If, however, the liquid stands at a lower level in one vessel than in the other, as in the figure, then the two columns of liquid in the legs of the siphon will not have the same height, and a difference of pressure will result, corresponding to the difference of level.

In order to ascertain what will be the result of this difference of pressure, take a section through the tube at the highest point, b , and consider the amount of pressure on the two faces of this section. On the face towards the vessel a , this pressure is equal to the pressure of the atmosphere (measured by the height of the barometer), or H , less the pressure of a column of the liquid used whose height is equal to the difference of level between b and the surface of the liquid in the vessel a . Let us represent the height of a column of mercury which is equivalent to that of the liquid by h_0 , and the surface of the section by s . We shall then have, for the pressure on this surface of the section, the value

$$\mathcal{F} = s (H_0 - h_0). \quad [112.]$$

On the surface of the section towards the vessel c , we have for the pressure a value

$$\mathcal{F}' = s (H_0 - h'_0); \quad [113.]$$

in which h'_0 represents the height of a column of mercury which is equivalent to a column of the liquid used whose height is equal to the difference of level between b and c . When the level of the liquid is the same in both vessels, it is evident that $h_0 = h'_0$. Hence the pressures on the two surfaces are equal, and, as already stated, there will be an equilibrium. If the level in the vessel c is lower than in a , then $h_0 < h'_0$, and $H_0 - h_0 > H_0 - h'_0$. There will, therefore, be an excess of pressure in the direction of the vessel c equal to $h'_0 - h_0$, which will cause a constant flow of liquid in the direction of the greatest pressure. This flow will continue until $h_0 = h'_0$, or until the level is the same in both vessels. If the vessel c is removed, then h'_0 represents the height of a column of mercury equivalent to a column of the liquid used whose height equals the vertical distance between the mouth of the tube and b . If this mouth is below the level of the bottom of the vessel a , it is evident that h_0 can never equal h'_0 ; and hence the flow in this case will continue until the surface of the liquid in the vessel falls below the mouth of the tube at a . It is evident, that, other things being equal, the velocity of the flow will

depend on the difference between h'_0 and h_0 . In the ordinary method of using a siphon, as represented in Fig. 294, this difference is constantly diminishing; and hence the velocity of the flow is constantly diminishing.

The siphon is frequently employed in the laboratory for decanting liquids. Before using the instrument, it is necessary to fill it with the liquid to be decanted. If this liquid is water, the siphon is easily filled by closing the end of the short leg with the finger, and, after inverting the instrument, by pouring in water at the other end, the air being allowed to escape from the short leg by lifting for a moment the finger. When the tube is filled, it can easily be reversed, and the end, still closed with the finger, plunged under the liquid in the vessel; when, on removing the



Fig. 295.

finger, the water will begin to flow. The siphon can also be filled by dipping the end of the short leg in the liquid, and sucking out the air from the other leg with the mouth. In the laboratory, the siphon is frequently used for decanting corrosive liquid; and it is then necessary to resort to various contrivances for filling it. The one represented in Fig. 295, which can easily be made of glass tubes and cork, is one of the best. The short leg is plunged, as usual, into the liquid. The end of the long leg is then closed by the finger, which can be protected by a piece of India-rubber, and the air is sucked out by the mouth applied at

the end of the side tube. As soon as the liquid descends into the enlargement at the end of the long leg, the finger is withdrawn.

(173.) *Mariotte's Flask*. — It is sometimes important to obtain with the siphon a uniform flow of liquid. This can be easily secured by means of the apparatus represented in Fig. 296, called *Mariotte's flask*. It consists of a bottle with two necks, into one of which a straight tube, and into the other a bent tube, have been adjusted air-tight, both reaching nearly to the bottom of the bottle. The siphon-tube is filled by blowing in air through the straight tube, when the flow continues of uniform velocity until the surface of the liquid in the bottle has fallen to the level $b c d$, the air constantly entering the bottle by the straight tube at b .



Fig. 296.

It can easily be shown that the flow in this case must be uniform in velocity. Consider, as before, a section through the siphon-tube at the highest point.

The pressure on the surface of this section towards o is evidently

$$\mathcal{F}' = s (H_0 - h'_0); \quad [114.]$$

where h'_0 is the height of a column of mercury equivalent to a column of the liquid used whose height equals the vertical distance from o to the centre of gravity of the section.

The surface of the section towards c is evidently exposed to the pressure exerted by the confined air on the surface of the liquid in the bottle, less the pressure of a column of the liquid whose height equals the vertical distance between this surface and the centre of gravity of the section. If we represent the tension of the confined air by \mathfrak{f} , and the height of a column of mercury equivalent to the column of liquid by h''_0 , we easily obtain for the pressure on the surface of the section,

$$\mathcal{F} = s (\mathfrak{f} - h''_0).$$

When the apparatus is in use, and air is freely entering through b , it is evident that the pressure of the atmosphere at b is balanced by the pressure of the confined air on the surface of the liquid, and by the pressure of the column of liquid above b .

Representing the equivalent of this column in centimetres of mercury by h''_0 , and the height of the barometer by H_0 , we obtain $H_0 = \mathfrak{H} + h''_0$; and by substitution,

$$\mathfrak{F} = s [H_0 - (h''_0 + h'''_0)]. \quad [115.]$$

Subtracting from this value [114], we obtain

$$\mathfrak{F} - \mathfrak{F}' = s [h'_0 - (h''_0 + h'''_0)]. \quad [116.]$$

The value $h''_0 + h'''_0$ represents the height of a column of mercury equivalent to a column of the liquid used whose height equals the vertical distance between c and the centre of gravity of the section. As this height remains constant, and is independent of the height of the liquid in the bottle, it is evident that the difference of pressure [116] which determines the velocity of the flow will also be constant. It is also evident that the difference of pressure is always equal to a column of the liquid used whose height equals the difference of level between b and o .

A very useful application of Mariotte's bottle is represented in Fig. 297. It is frequently necessary, in the laboratory, to wash

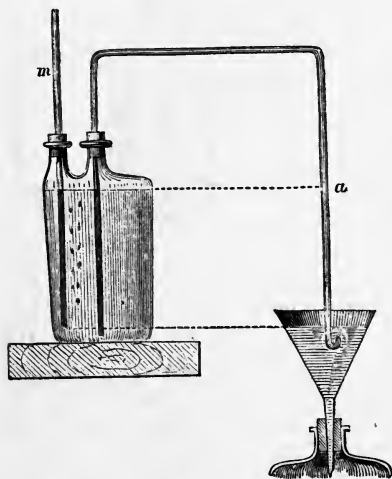

Fig. 297.

for several hours, or even days, a precipitate which has been collected on a filter. This is done by keeping the filter constantly full of water, which slowly percolates through the porous mass on the filter, and washes out everything which is soluble. Mariotte's bottle furnishes an automatic machine, by which the water in the filter can be maintained at a constant level. The disposition of the apparatus is sufficiently explained by the figure. The difference of level

between b and o is made very small, and the water flows from the bottle to the filter, until the level rises to the lower dotted line in the figure. Then the flow ceases, but recommences as soon as the level falls.

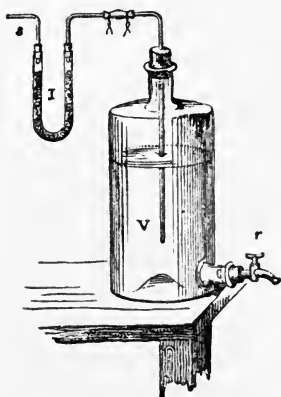

Fig. 298.

The principle of Mariotte's bottle is also applied to produce a uniform flow of air through the tube apparatus which is frequently used in chemical analysis. Fig. 298 represents what is termed an *aspirator jar*. The tube, which passes air-tight through the cork in the neck, has a free communication with the atmosphere, and the current of air is caused by the flow of water from the cock at *r*. The velocity of the flow of water from the cock, other things being equal, depends upon the pressure exerted on a section of the stopcock; and it can easily be seen that this will be the same until the level of the water in the jar has fallen below the mouth of the tube *V*.

(174.) *Wash-Bottle*. — This simple instrument (Fig. 299), which is so much used in the laboratory, is one of the most useful applications of the properties of gases. By condensing the air over the water in the bottle, by blowing in at the tube *a*, the liquid is forced out at *o* in a fine jet, which can be directed at pleasure.

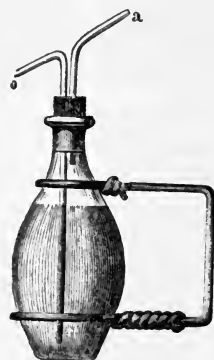

Fig. 299.

Machines for Rarefying and Condensing Air.

(175.) *The Air-Pump*. — One of the simplest forms of the air-pump is represented in Fig. 300. It consists of a hollow brass cylinder, in which a piston moves readily up and down by a handle attached to the piston-rod above. The inner surface of the cylinder is perfectly smooth and true, so that the piston, which is formed of yielding materials, moves air-tight through its whole course. Moreover, the under surface of the piston fits exactly the bottom of the cylinder, so that, when the piston is in the lowest position, there can be no air between it and the cylinder bottom. The upper end of the piston is closed by a brass cover, through which the piston-rod passes freely, and the atmosphere

has free access to the upper surface of the piston. The lower end of the cylinder opens into a narrow tube, which connects, at one end, with the glass bell on the plate of the air-pump through the

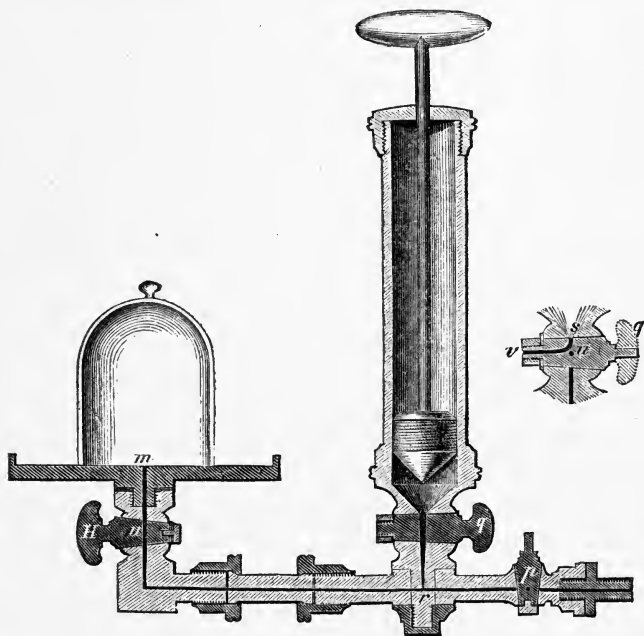

Fig. 300.

stopcock *u*, and at the other, with the atmosphere through the stopcock *p*. Just below the bottom of the cylinder there is placed a stopcock of peculiar construction. The core of the cock is bored with two holes, one of which has the same position as in ordinary stopcocks, and as is shown in the figure. The position of the second is shown in the small section at the side. When the cock has the position indicated in the main figure, there is a direct connection between the interior of the cylinder and the glass bell. If the cock be now turned through ninety degrees, till it takes the position shown in the small section, the connection with the glass bell will be closed, and direct communication with the atmosphere opened through the channel *s v*. The channel *r m* opens in the centre of a round plate made of brass, or, still better for chemical uses, of glass. This plate is ground on its upper surface perfectly plane. The lower edges of the glass

bell-receivers are also carefully ground, and may be made to adhere air-tight to the plane by interposing a little oil.

The principle of the air-pump can now be easily explained. Let us suppose that the piston is in its lowest position, and that the stopcock is in the position represented in the figure. If now we draw up the piston by the hand, the air contained in the bell-receiver and in the tube connecting it with the cylinder will expand until it fills the cylinder; and its volume being thus increased, its density will be proportionally diminished. Let us next turn the stopcock q into the position represented in the section. The bell is thus hermetically closed, but a connection is opened between the cylinder and the atmosphere. Now, on pressing down the piston, all the air in the cylinder will be forced into the atmosphere. The stopcock may then be turned back to its first position, and the same motion repeated, which will further rarefy the air in the bell; and thus the process may be continued until the required degree of exhaustion is obtained.

(176.) *Degree of Exhaustion.* — It is obvious that the effect of the air-pump depends upon the expansive force of air, and that each motion of the piston is accompanied with a certain amount of expansion of the air in the bell. This amount is evidently determined by the size of the cylinder, as compared with that of the bell and the tube leading to it. With these data, we can easily calculate the degree of exhaustion after each stroke of the piston.

Let us then represent the volume of the bell-receiver and of the tube connecting it with the cylinder by V ; and that of the cylinder itself, when the piston is at its highest position, by v . Let us suppose that the piston starts from its lowest position, and let us take the quantity of air contained in the receiver and the tube as unity. When now the piston is raised, the volume occupied by this quantity of air (taken as unity) becomes $V + v$. When the stopcock is turned and the piston lowered, the volume v is expelled, which is a portion of the original quantity (or unity) represented by $\frac{v}{V+v}$. The piston is now in its initial position, and the quantity of air remaining in the receiver and tube, after the first stroke, is

$$1 - \frac{v}{V+v} = \frac{V}{V+v}. \quad [117.]$$

Reversing the stopcock, and raising again the piston, this quantity of air, $\frac{V}{V+v}$, occupying the volume V , expands to the volume $V+v$. When the piston descends, the volume v is expelled, which is $\frac{v}{V+v}$ of the whole, or of $\frac{V}{V+v}$; that is, $\frac{vV}{(V+v)^2}$ of unity. There remains, therefore, after the second stroke,

$$\frac{V}{V+v} - \frac{vV}{(V+v)^2} = \frac{V^2}{(V+v)^2}. \quad [118.]$$

At the third stroke of the piston, the same proportion of the air now remaining is expelled as before; and there is consequently left, after the third stroke,

$$\frac{V^2}{(V+v)^2} - \frac{vV^2}{(V+v)^3} = \frac{V^3}{(V+v)^3}. \quad [119.]$$

In like manner there will remain, after the n th stroke,

$$\frac{V^{n-1}}{(V+v)^{n-1}} - \frac{vV^{n-1}}{(V+v)^n} = \frac{V^n}{(V+v)^n}. \quad [120.]$$

If, for example, the volume of the receiver is equal to ten litres, and that of the cylinder to one litre, we shall have, for the amount of air left after the fiftieth stroke, $\frac{10^{50}}{11^{50}} = 0.0085$ of the original quantity.

Since the value of [120] never can become zero until $n = \infty$, it is evident that we can never, even theoretically, by means of the air-pump, exhaust the whole of the air. Nevertheless, theoretically we ought to be able to approach a perfect vacuum indefinitely by continuing the process for a sufficiently long time. Practically, however, the limit is soon reached; and even with the best pumps, we can never obtain a degree of exhaustion greater than that when $\frac{1}{10000}$ th of the original quantity of air is left in the receiver. It is not difficult to explain the cause of the discrepancy between the theoretical and the practical results.

In any machine, however well made, there must be a number of joints which are never absolutely hermetical. There are frequently, even in the metal itself, imperceptible pores which transmit air. During the first few strokes of the piston, this minute leakage produces no perceptible effect; but when we attain a high degree of exhaustion, the air enters by these minute crevices as fast as we can remove it by the pump.

But besides this imperfection, the capability of the instrument is limited in still another way. In calculating the degree of exhaustion, we supposed that at each descent of the piston the whole of the air was expelled from the cylinder; and this would be the case, if the base of the piston adhered exactly to the base of the cylinder. In practice, however, there is never an absolute adhesion; and a small amount of air remains between the two, which no force applied to the piston is able to expel. When, therefore, after working the pump for some time, this small amount of air, expanded through the whole interior of the cylinder, exerts a pressure equal to that of the air remaining in the receiver, it is evident that the air from the receiver can no longer expand into the cylinder, and the pump will cease to exhaust. But although a perfect vacuum can never be obtained with an air-pump, yet a sufficient degree of exhaustion for all practical purposes is easily attained.

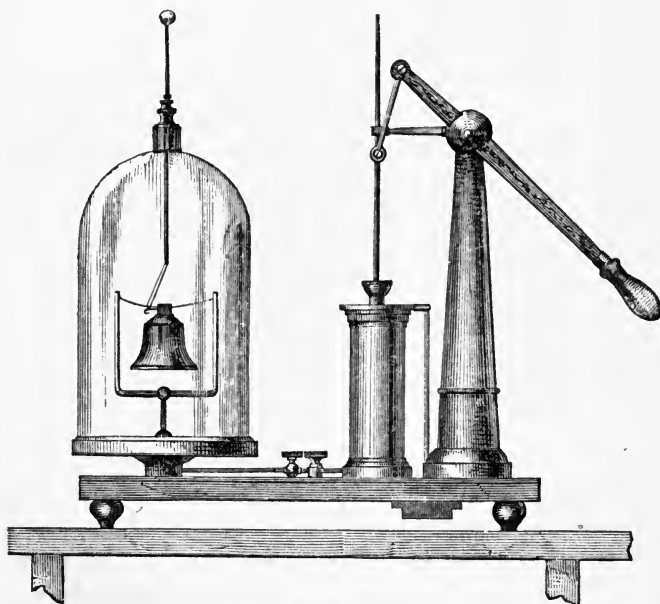

Fig. 301.

(177.) *Air-Pump with Valves.* — The form of air-pump described in (175) is exceedingly simple in its construction, and not liable to get out of order. It is therefore well adapted for use in

the chemist's laboratory, where it is exposed to vapors which are likely to injure any delicate valves. It is open, however, to two serious objections. In the first place, the stopcock *g* must be turned by the hand at each stroke of the piston; and although this motion may be obtained by means of cranks and levers, yet this machinery renders the instrument unnecessarily complicated. In the second place, the piston must be raised through the whole length of each stroke, against a great pressure of air, which

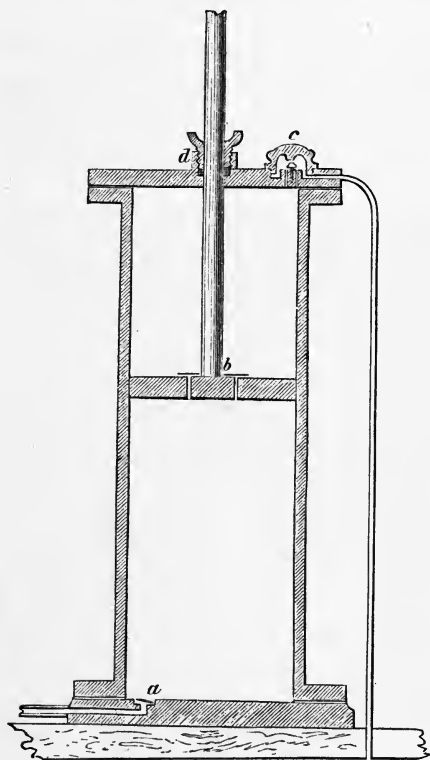

Fig. 302.

rapidly increases as the exhaustion proceeds, an objection which would be very serious in a large pump, rendering a great force necessary to work it. Both of these difficulties are overcome in the pump represented in Fig. 301. A section of this pump is represented in Fig. 302, and the details of the upper valve in Fig. 303.

In this air-pump there are three valves, all opening upwards: one at the bottom of the cylinder, covering the mouth of the tube connecting with the receiver (*a* in Fig. 302); one at the top of the piston, *b*, covering the holes perforated through it; and, finally, one at the top of the cylinder, *c*, covering

the aperture which opens into the atmosphere. The piston-rod passes through a packing-box, *b*, in which it moves air-tight, and the power is applied to the piston-rod by means of a lever, which facilitates the working of the pump. Let us now suppose that we start with the piston at the bottom of the cylinder, and proceed to raise it. The air from the receiver expands

into the empty space thus formed in the cylinder, raising the valve *a*. As now the piston descends, the valve *a* closes and prevents the air from returning to the receiver; and this air passes up, through the holes in the piston, into the upper part of the cylinder, raising the valve *d*. When next the piston rises, this same air, now in the upper part of the cylinder, is forced out into the atmosphere by raising the valve *c*. At the same time, a fresh amount of air from the receiver expands into the space below the piston, which air is forced out by the next stroke at the valve *c*, as before, and thus continuously.

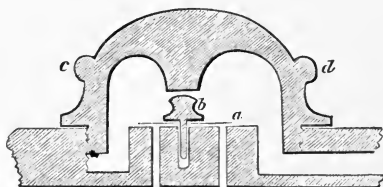

Fig. 303.

It is evident from the construction, that, as the piston rises, the air above it is gradually condensed, and the valve *c* does not open until the density of the air is equal to that of the atmosphere. During the first few strokes, the force required to raise the piston is considerable; but as the exhaustion proceeds, the effort necessary becomes less and less, until at last only sufficient force is required to overcome the friction, and a sudden pressure at the end of the stroke to expel the air condensed at the top of the cylinder. In pumps like the one represented in Fig. 300, the size of the piston and cylinder is necessarily very limited; because, if the area of the piston exceeds a very limited extent, the pressure of the air on the upper surface becomes so great, as the exhaustion proceeds, as to require an impracticable amount of force to work the pump. With pumps of the construction just described, this pressure is in great measure removed; and it is possible to increase very greatly their size advantageously. Figure 304 is a representation of a large air-pump of this description, made by Ritchie,* of Boston. The piston is 10 c. m. in diameter, and the length of the stroke 26 c. m. The ground brass plate is 37 c. m. in diameter, and admits of as large a bell-receiver as can be readily made. The efficiency of the pump depends in great measure upon the valves. These are best made

* The two representations of air-pumps, Fig. 301 and Fig. 304, are from the catalogue of Mr. E. S. Ritchie, a very expert philosophical-instrument maker of Boston.

of delicate oil-silk. The details of the upper valve of the pump, as made by Ritchie, are shown in Fig. 303. The oil-silk disk, *a*,

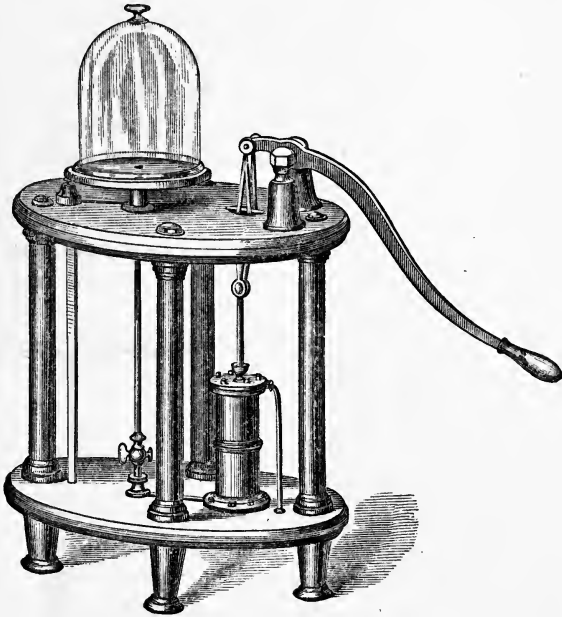

Fig. 304.

is kept in its place by the pin *b*, and the whole is protected by the dome-shaped covering *c d*. The tube at the side discharges the air, and the oil which escapes with it is conducted into a reservoir placed below the basement of the pump. This pump is furnished with a manometer similar in principle to the one represented in Fig. 272, by which the degree of exhaustion can be ascertained. It is represented in the figure on the left-hand side of the pump.

Besides those already enumerated, there is obviously another limit to the degree of exhaustion which can be obtained with this pump. This arrives when the elasticity of the air left in the receiver is insufficient to raise the lower valve *a*, Fig. 302. In order to overcome this difficulty, the lower valve in the French form of air-pump* is opened and shut mechanically. Babinet

* For a description of the French form of air-pump, see any of the French works on physics.

has still further improved the French air-pump, by so connecting the two barrels that, after a certain degree of exhaustion has been attained, the second is made to exhaust the first. There can be no doubt that a higher degree of exhaustion can be obtained with the French pump, thus arranged, than with the pump just described ; but this gain is hardly compensated by the greater complexity and consequent liability to derangement, more especially since a sufficient degree of exhaustion for all practical purposes can be obtained without these complications.

(178.) *Condensing-Pump.* — This instrument is just the reverse of the air-pump, and it is used for increasing the density of air in a receiver, while the air-pump is used for diminishing it. Any air-pump may be converted into a condensing-pump by changing the direction of all the valves. For example, we may use the pump represented in Fig. 300 as a condensing-pump. Starting with the piston at the bottom of the cylinder, we give the stopcock the position represented in the section at the side. Then, on raising the piston, the air enters at *v* and fills the cylinder. We now turn the cock into the second position, when, on pushing down the piston, this air is forced into the receiver. We can then reverse the stopcock and repeat the process, until the required degree of condensation is obtained. Instead, however, of placing the receiver on the brass plate, as before, we screw it on beyond the stopcock *p*, opening this stopcock, and closing the stopcock *u*.

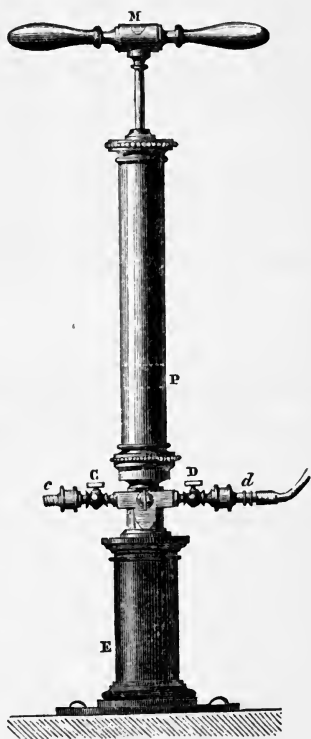

Fig. 305.

The most convenient form of condensing-pump for the laboratory is represented in Fig. 305. It consists of a cylinder, and a piston, which is moved by the handle *M*. The two valves, which are both at the bottom of the cylinder, are represented in section in

Fig. 306. They are made to fit exactly the conical openings at the bottom of the cylinder, and are kept in place by very delicate

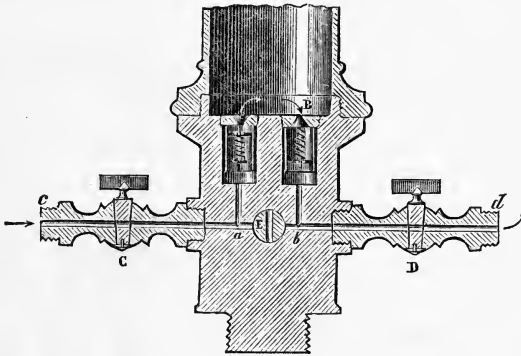

Fig. 306.

spiral springs. When the piston rises, the valve *A* opens and admits the air through the tube *ca* into the cylinder. On the other hand, when the piston descends, the valve *A* closes, while *B* opens, and the air is forced out, through the tube *bd*, into the receiver placed at *d*. It is evident, that if two receivers are connected with the pump, one at *c* and the other at *d*, the air will be exhausted from one and condensed in the other. The pump may, therefore, be used either for condensing or rarefying. In using the pump, it is fastened firmly to a table, or some other solid support, and the handle *M* is moved up and down alternately with the two hands.

This simple machine is sufficient for almost all purposes. If, however, a more powerful apparatus is required for condensing gases into large reservoirs, it is best not to increase the size of the pump; but to combine several cylinders, connecting them all with the same receiver. The piston-rods of all these cylinders can be united by cranks to one axis, and a handle connected with a fly-wheel can be used to give this axis a regular and uniform motion.

(179.) *Water-Pump*. — Entirely analogous in its principle to the air-pump is the common water-pump, a glass model of which is represented in Fig. 307. It consists also of a hollow cylinder, in which moves a piston, *B*. It has two valves, both opening upwards; one at the bottom of the cylinder, covering the mouth of the tube leading to the water of the well, and the other at the

top of the piston, covering the hole with which it is pierced. If the piston and valves are sufficiently tight, this pump will act as an air-pump, and on moving the piston by the handle *P* alternately up and down, it will exhaust the air from the tube *A*. But since the end of the tube dips under water, the pressure of the air will force up the water until it fills both the tube and the cylinder below the piston. Then, on lowering the piston, the water in the cylinder will raise the valve *o*, and pass above the piston. Afterwards, on raising the piston, this water will be lifted and discharged into the pipe *C*, while a fresh quantity of water will be forced up by the atmospheric pressure through the valve *S*. Thus, at each stroke of the piston, a quantity of water is lifted equal to the capacity of the cylinder less the volume occupied by the piston itself. If the piston and valves are not sufficiently tight to pump out the air, they can be made so by pouring a little water into the pump. This is what is called the *drawing of water*, and the philosophy of this well-known process is evident.

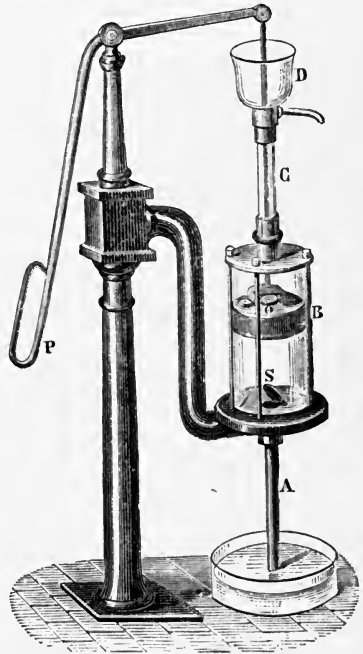

Fig. 307.

It follows from this description, that the pump will not work, if the bottom of the piston, in its highest position, is over ten metres above the level of the water in the well; and it was an attempt of some Florentine engineers to raise water in the suction-tube of a pump above this height, which led to the discovery of the pressure of the atmosphere. On account of the imperfections of the valves and piston, a pump will seldom work in practice higher than eight metres. The height of the tube *C*, in which the water is lifted by the piston, may be very considerable, and the whole height through which the water is raised by the pump is frequently very much over ten metres; but the difficulty of working

a pump, and keeping it in order, increases very rapidly with the height of the column of water which is lifted.

PROBLEMS.

Unless otherwise stated, the temperature in all the following problems is to be taken as 0° C., and the height of the barometer at 76 c. m.

Weight of a Body in Air.

176. A mass of metal, whose *Sp. Gr.* = 11.35, weighs 0.575 gramme in a vacuum. How many milligrammes will it lose when weighed in air?

177. A brass weight (*Sp. Gr.* = 8.55) weighs in a vacuum one kilogramme. How many milligrammes does it lose when weighed in air?

178. A body loses in carbonic acid gas 1.15 gramme of its weight. What would be the loss of its weight in air and in hydrogen?

179. A body loses 7 grammes of its weight in air; how much of its weight would it lose in carbonic acid and in hydrogen?

180. What is the weight of hydrogen contained in a glass globe whose surface is equal to 10 $\overline{\text{m.}}^2$?

181. A glass globe from which the air has been exhausted weighs 254.735 gram. When full of air, it weighs 289.621 gram. When full of another gas, 308.078 gram. What is the capacity of the globe, and what is the specific gravity of the gas?

182. A glass globe 30 c. m. in diameter, filled with air, and hermetically sealed, is balanced in the atmosphere by brass weights amounting to 356.225 gram. How much would it weigh in a vacuum? How much would the globe weigh in a vacuum, if it were opened so that the air could be exhausted from the interior? *Sp. Gr.* of brass 8.55, and of glass 3.33.

183. A glass globe hermetically sealed weighs in the air 25.236 gram. and gains in a vacuum 0.632 gram. What is its diameter?

Buoyancy of Air.

184. What is the ascensional force of a balloon one metre in diameter, three quarters filled with hydrogen, when the balloon itself weighs one hundred grammes?

185. Calculate the ascensional force of a spherical balloon made of prepared silk and filled with impure hydrogen, knowing that the balloon itself weighs 63,620 gram., that the prepared silk weighs 250 gram. the square metre, and that a cubic metre of impure hydrogen weighs 100 gram.

186. What would be the ascensional force of a spherical balloon seven metres in diameter, two thirds filled with hydrogen, when the balloon and attachments weigh twenty kilogrammes?

187. The material of a balloon containing 1229 c. m.^3 weighs 1.5 gram. The balloon is filled with hydrogen, whose specific gravity referred to water is 0.00009003. The specific gravity of the surrounding air is 0.0013105. Will the balloon rise in the atmosphere?

188. The material of a spherical balloon and its attachments weighs 400 kilogrammes. This balloon is 15 m. in diameter, and is three fourths filled with gas whose specific gravity equals 0.0005. The specific gravity of the surrounding air is 0.0013. What is the ascensional force of the balloon?

Barometer.

189. When the surface of a column of mercury in a barometer stands at 76 centimetres above the mercury in the basin, with what weight is the atmosphere pressing on every square centimetre of surface? *Sp. Gr.* of mercury = 13.596.

190. To what difference of pressure does a difference of one centimetre in the barometric column correspond?

191. When the water barometer stands at ten metres, what is the pressure of the air if the temperature is 4° ?

192. How high would an alcohol barometer, and how high a sulphuric-acid barometer, stand under the same circumstances, disregarding in each case the tension of the vapor? *Sp. Gr.* of alcohol = 0.8095; *Sp. Gr.* of sulphuric acid = 1.85.

193. When the mercury in a barometer stands 75.2 c. m., with what weight is the atmosphere pressing on every square centimetre of surface? How high would barometers stand under the same circumstances, filled with liquids of the following specific gravities, viz. 1.12, 1.45, 2.36, 3?

194. When the mercury barometer stands at 76 c. m., what must be the length of a water barometer inclined to the horizon at an angle of 30° ?

195. If a barometer, having its lower end immersed in a basin of mercury, be suspended from the beam of a balance, and weighed, is its weight altered by weighing it again when inverted and containing the same quantity of mercury as before?

Pressure of the Atmosphere.

196. When the barometer stands at 76 c. m., how great is the pressure of the air upon a plane surface having an area of one square metre?

197. The body of a man of ordinary stature exposes a surface of about one square metre. How great a pressure does the body sustain when the barometer stands at 72 c. m.? If the barometer rises to 78 c. m., how great is the increase of pressure?

198. When the barometer stands at 72 c. m., how great is the pressure of the air on a sphere whose radius is equal to 6675 c. m.?

199. When the barometer stands at 76 c. m., what is the pressure exerted in the vertical direction on a sphere 125 c. m. in diameter?

Mariotte's Law.

In all these problems the law is to be regarded as invariable.

200. A volume of hydrogen gas was measured and found to be equal to $250 \overline{\text{c. m.}}^3$. The height of the barometer, observed at the same time, was 74.2 c. m. What would have been the volume if observed when the barometer stood at 76 c. m.? What would be the volume at an elevation at which the barometer stands at 56 c. m.?

201. A volume of nitrogen gas measured $756 \overline{\text{c. m.}}^3$ when the barometer stood at 77.4 c. m. What would it have measured if the barometer had stood at 76 c. m.?

202. A volume of air standing in a bell-glass over a mercury pneumatic trough measured $568 \overline{\text{c. m.}}^3$. The barometer at the time stood at 75.4 centim., and the surface of the mercury in the bell was found, by measurement, to be 6.5 c. m. above the surface of the mercury in the trough. What would have been the volume had the air been exposed to the pressure of 76 c. m.?

203. A volume of air standing in a tall bell-glass over a mercury pneumatic trough measured $78 \overline{\text{c. m.}}^3$. The barometer at the time stood at 74.6 c. m., and the mercury in the bell at 57.4 c. m. above the mercury in the trough. What would have been the volume had the pressure been 76 c. m.?

204. What would be the answers to the last two problems, had the pneumatic trough been filled with water instead of mercury?

205. The specific gravity of air at 0° and 76 c. m. referred to water is 0.00129206. What is the specific gravity when the barometer stands at the following heights, viz. 72.65 c. m., 74.23 c. m., 75.54 c. m., 77.82 c. m.?

206. The specific gravity of carbonic acid gas at 0° and 76 c. m. referred to water is 0.00196663. What is the specific gravity when the barometer stands at the heights given in the last problem?

207. A glass globe 10 c. m. in diameter hermetically sealed weighs 45.120 gram. when the barometer stands at 74.5 c. m. What would it weigh if the barometer stood at 76 c. m.?

208. A glass globe hermetically sealed, 30 c. m. in diameter, suspended to one pan of a balance, is poised by 325.422 grammes in brass weights when the barometer stands at 76.21 c. m. After several hours it is found to have lost in weight 0.022 gram. What is now the height of the barometer, supposing the temperature not to have changed? Sp. Gr. of brass 8.55.

209. A glass globe hermetically closed was found to weigh 354.567 gram. when the barometer stood at 73 c. m., and to weigh 353.917 gram. when the barometer stood at 77 c. m. What is the diameter of the globe?

210. A glass globe 25 c. m. in diameter contains how many grammes of hydrogen at the following pressures, viz. 72.2 c. m., 74.6 c. m., 76 c. m., 77.2 c. m.?

211. Two glass globes are connected by a tube in which there is a stopcock. In the first globe there are 250 c. m.³ of air at a tension of 2 c. m. In the second, 340 c. m.³ of air at a tension of 10 c. m. After opening the stopcock, what will be the tension in both globes?

212. Into an exhausted jar having a capacity of 60 litres there have been poured 30 litres of nitrogen at the pressure of 72 c. m., 15 litres of oxygen at the pressure of 64 c. m., and 5 litres of carbonic acid gas at the pressure of 78 c. m. What is the elastic force of the mixture?

213. A glass globe contains 8.548 gram. of air. It is afterwards filled with protoxide of nitrogen whose *Sp. Gr.* = 1.52, that of air being unity. What is the weight of the gas, 1st. when the tension of the two gases is the same, 2d. when the tension of the air is 76 c. m. and that of the protoxide of nitrogen 78 c. m.?

214. A glass globe weighs, when completely empty, 152.475 gram.; full of air, it weighs 168.386 gram., and full of another gas, 157.235 gram. What is the *Sp. Gr.* of the gas, supposing the pressure the same at all the weighings? Also, what correction must be made if the pressure was 76 c. m. during the weighing of the globe, 77 c. m. during the weighing of the air, and 74 c. m. during the weighing of the gas? The tension of the air and gas in the balloon is supposed to be 76 c. m., and the temperature is supposed invariable at 0°.

Atmosphere.

The following problems may be solved by Babinet's formula. See note to page 304.

215. Find the difference of level of two stations from the following data:—

Height of barometer at lower station reduced to 0° C.,	755 m. m.
Temperature of air “ “	15° C.
Height of barometer at upper station reduced to 0° C.,	695 m. m.
Temperature of air “ “	10° C.

216. Find the difference of level of two stations from the following data:—

Height of barometer at lower station reduced to 0° C.,	730 m. m.
Temperature of air “ “	20° C.
Height of barometer at upper station reduced to 0° C.,	635 m. m.
Temperature of air “ “	15° C.

217. Find the height of Mount Washington above sea level from the following observations of Prof. Arnold Guyot, Aug. 8, 1851, 4 P. M.:—

Height of barometer at Gorham reduced to 0° C.,	740.70 m. m.
Temperature of air at Gorham,	22°.25
Height of barometer near the summit of Mount Washington reduced to 0° C.,	608.93 m. m.
Temperature of air at summit,	10°.30
Barometer at Gorham above sea level,	251 m.

Air-Pump.

218. The capacity of the cylinder of a pump is one tenth of that of the receiver. What will be the tension of the air in the receiver after 1, 2, 3, 4, 5, 10, and 40 strokes of the piston, the original tension being 76 c. m.?

219. The capacity of the cylinder of a pump is one third of the capacity of the receiver. After how many strokes of the piston will the tension of the air in the receiver be reduced to $\frac{1}{25}$ of its primitive amount?

220. If the air in the receiver of an air-pump is by two strokes of the piston made four times rarer than it was at first, what is the ratio of the capacity of the receiver to that of the barrel?

221. If in an air-pump the density before is to the density after three strokes of the piston as 35 is to 8, determine the ratio of the capacity of the receiver to that of the barrel.

222. If, in an air-pump similar in construction to Fig. 300, an interval be left between the piston and the base of the cylinder at the lowest possible position of the piston, determine the density of the air in the receiver after n strokes and after an infinite number.

223. The piston of a common pump is 6 c. m. in diameter, and the vertical height of the mouth from the surface of the water in the well is 6.250 m. How great is the intensity of the force required to raise the piston, assuming that there is no gain by leverage? Is there any gain in power in the use of a pump over a bucket in raising water?

224. What are the conditions under which the common pump will not draw, when the piston does not descend to the fixed valve?

225. If a body when placed under the receiver of a given air-pump weighs a gram., and after n strokes weighs b gram., determine the weight of the body in a vacuum; and, supposing the specific gravity of the body known, determine the specific gravity of the air in the receiver at first.

Miscellaneous.

226. A cylinder, the height of which is 6 c. m. and the radius of the base 1 c. m., is filled with atmospheric air. To what depth will a piston sink in the cylinder which weighs 10 kilogrammes? To what depth would it sink if it weighed 1000 kilogrammes?

227. In the cylinder described in the last example, a piston is forced down 2 c. m.; determine the pressure of the confined air. Determine also the pressure of the air when it is forced down 5.64 c. m.

228. Calculate the total weight of the atmosphere in kilogrammes, supposing the height of the barometer 76 c. m., and the radius of the earth considered as a sphere equal to 6,366 kilometres. Calculate also the volume of an equivalent mass of gold, knowing that the *Sp. Gr.* of gold = 19.363, and that of mercury = 13.596.

229. If the altitude of the mercury in a barometer placed in an ordinary diving-bell be observed at the beginning and end of a descent, determine the depth descended.

230. Determine the tension of the rope by which an iron diving-bell is suspended at any depth below the surface.

231. If a cylindrical tube 152 c. m. long be half filled with mercury, and then inverted, determine how high the mercury will stand when the barometer stands at 76 c. m.

232. Having given the quantity of air left in a barometer tube before immersion, find the height at which the mercury is supported after immersion.

233. If in an imperfectly filled barometer tube, of which the length is 80 c. m., the mercury stands at 74 c. m., when in a well-filled tube it stands at 76 c. m., determine at what height it will stand in the imperfect one when it stands at 70 in the perfect one.

234. Two barometers of the same given length, l , being imperfectly filled with mercury, are observed to stand at the heights H and H' on one day, and h and h' on another. Determine the quantity of air left in each, supposing the temperature invariable.

235. A bell partly filled with gas is standing over a pneumatic trough. Its interior diameter is 6 c. m.; its weight, one kilogramme; and the level of the mercury in the bell is 22.8 c. m. above the level of the mercury in the trough. Neglecting the weight of the gas, how much force in grammes is required to sustain the bell in its position, supposing that no portion dips under the mercury, and that the temperature is at 0° ?

236. A body of known specific gravity is floating between two immiscible fluids, whose specific gravities are also given. Determine the portion immersed in each.

237. A cylinder of known specific gravity and magnitude floats with its axis vertical in a vessel of water. What will be the effect of removing the atmospheric pressure?

238. An hydrometer similar to Fig. 248 is divided into 150 parts of equal capacity, and so constructed that when *in vacuo* it sinks in pure water at 4° C. to the 100th division. When immersed in sulphuric acid, at the standard temperature and pressure, it sinks to the 54th division. To what point would it sink were the experiment made *in vacuo*, and what is the true specific gravity of the acid?

MOLECULAR FORCES BETWEEN HETEROGENEOUS MOLECULES.

(180.) *Adhesion*.—Having studied the phenomena caused by the action of molecular forces between *homogeneous molecules*, as manifested in the characteristic properties of solids, liquids, and gases, we come next to consider those phenomena which are caused by the action of molecular forces between *heterogeneous molecules*. As we have already seen, the molecular forces are either attractive or repulsive (78). To the attractive force, when exerted between homogeneous molecules, like those of the same body, whether it be solid, liquid, or gaseous, we give the name of *cohesion* (79). But when the attractive force is exerted between heterogeneous molecules, like those of different bodies, and still does not produce any chemical change, we call it *adhesion*. It must not, however, be supposed that these attractive forces are essentially different in the two cases. The distinction between cohesion and adhesion is only made for the sake of classification, and it is at least possible that they are merely different manifestations of the one force of universal gravitation already considered.

The phenomena of adhesion are quite numerous, and they can be most conveniently classified according to the mechanical condition of the masses of matter between which the force acts. We will, therefore, consider in order the phenomena caused by the action of,—

First, solids on solids (*cements*).

Secondly, solids on liquids (*capillarity, solution*).

Thirdly, solids on gases (*absorption of gases*).

Fourthly, liquids on liquids (*liquid diffusion, osmose*).

Fifthly, liquids on gases (*solution of gases*).

Sixthly, gases on gases (*gaseous diffusion*).

. *Solids on Solids.*

(181.) *Adhesion between Solids*.—Many of the most familiar phenomena of daily life are owing to the attractive forces which exist between heterogeneous particles of solids. Thus the particles of dust floating in a room adhere to the ceiling in opposition to the force of gravity. In like manner, the particles of chalk adhere to the vertical surface of a blackboard, and the

particles of plumbago abraded from a lead pencil adhere to a sheet of writing-paper. So also the adhesion of paint to wood or canvas, that of the tin amalgam to the backs of glass mirrors, and that of gold-leaf to picture-frames, belong to the same class of phenomena. The numerous important applications of india-rubber in the chemical laboratory furnish still further illustrations of adhesive force.

India-rubber adheres very strongly to glass, and this property renders it invaluable for making stoppers to glass bottles and airtight joints between glass tubes. The common method of uniting together glass tubes in adjusting chemical apparatus consists in stretching over the ends of the tubes a short tube of india-rubber called a connector, *e f*, (Fig. 308,) so that the ends of the two glass tubes shall meet within it. On binding the india-rubber to the glass by means of a silk cord or fine copper wire, the adhesion is sufficient to resist the action of most gases, unless the pressure is considerably greater than that of the atmosphere. These connectors can easily be made of the required dimensions from sheet india-rubber. We apply a strip of india-rubber previously softened by heat, to the glass tube, as represented in

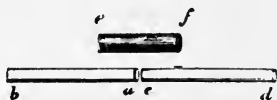

Fig. 308.

Fig. 309, and then cut the two edges with a pair of scissors, which should have broad, flat blades, and be perfectly clean. The cut edges immediately unite, and

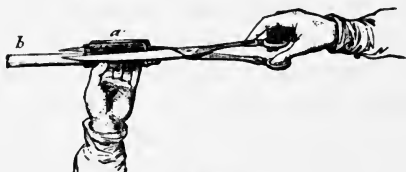

Fig. 309.

the union can be made more solid by pressing them together between the thumb-nails. The india-rubber connector will adhere at first firmly to the glass tube, but it can be easily removed after dipping the tube into water. The water is drawn up between the glass and the india-rubber by capillary attraction, and the adhesion is destroyed.

(182.) *Cements*.—The use of cements not only illustrates the existence of an attractive force between the molecules of heterogeneous solids, but also the additional fact, that the strength of this force varies with the nature of the solids. In order to unite two pieces of wood, we first fit together carefully

the surfaces to be joined, and then interpose between these surfaces, perfectly cleaned, a thin layer of melted glue. When the glue hardens, it firmly cements together the two pieces of wood, — first, by the adhesion between the glue and the wood, and, secondly, by the cohesion between the particles of the glue itself. This same glue, however, would fail to cement together pieces of glass or of stone, because the adhesion of glue to these solids is much feebler than its adhesion to wood; but fragments of glass and porcelain may be united by some resinous material, such as shellac, and those of stone and brick by mortar or some calcareous cement.*

It is evident that in all these cases the phenomena of adhesion are mixed with those of cohesion. The adhesion only takes place at the surfaces, where the heterogeneous particles are brought in contact, while the particles of the solids, and those of the cement, are alike held together by the force of cohesion. The thinner the layer of cement, the more perfectly does it fulfil its office, since, when a thick mass is used, the unequal expansion of the different solids in contact, caused by changes in temperature, tends to destroy the cohesion of the particles of the cement. It not unfrequently happens that the adhesion between the particles of a cement and the bodies which it unites, is greater than the cohesion which holds together the particles of the body itself. On attempting to separate two pieces of wood along a glued seam, we often see a film of wood split off adhering to the surface of the glue; and the feat of splitting a bank-note is accomplished by cementing it firmly between two flat surfaces, and then forcibly separating them, when, the cohesion of the paper being feebler than the adhesion of the cement, the paper is split through the middle.†

Solids and Liquids.

(183.) *Adhesion of Liquids to Solids.* — That the surfaces of solids are generally wetted when dipped into a liquid is a fact universally known, and it is self-evident that the liquid molecules are held to the solid surface by a mutual attraction between

* For a description of the various cements used in the laboratory, the student is referred to the works on chemical manipulations by Faraday, Morfit, and others.

† Miller, Elements of Chemistry, page 59.

the liquid and solid particles. The strength of this attraction, which is much greater than is generally supposed, can be made evident by a simple experiment. If a disk of glass is suspended to the pan of a hydrostatic balance, and, having been exactly counterpoised by weights in the opposite pan, is applied to the surface of a liquid capable of wetting it, it will be found necessary to add a very considerable weight to the counterpoise in order to separate the disk. Moreover, when the separation takes place, the disk will be found wet, showing that the separation has been between the particles of liquid, and not between the solid and liquid surfaces, and indicating that the adhesion was greater than the cohesion of the liquid.

In experiments made by Gay-Lussac, at a temperature of 8° , with a circular plate 118.366 m. m. in diameter, 59.4 gram. were required to separate it from water, 31.08 to separate it from alcohol (Sp. Gr. = 0.8196), and 34.1 to separate it from oil of turpentine. It was also found that the substance and thickness of the plate had no influence on the result, proving, as before, that the force overcome by the weight was the cohesion between the particles of the liquid, and further showing that the distance through which the force acted was less than the thickness of the liquid film which remained adhering to the plate. These numbers cannot, however, be regarded as a direct measure of the relative cohesion of the three liquids, as could easily be shown by a further examination of the conditions of the experiment.

Adhesion also exists between liquids and such solid surfaces as they have not the power of wetting. Gay-Lussac found that a disk of glass adhered to the surface of mercury with a very considerable force. In an experiment made as just described, with a disk of glass 118 m. m. in diameter, resting on the surface of a basin of mercury, it required in one case 296 gram., and in another 158 gram., to effect a separation, the amount of weight required depending on the manner in which the surfaces were applied to each other. In these experiments, when the surfaces were parted, the separation took place between the mercury and the glass, indicating that the weight overcame the adhesion of the heterogeneous particles, and not the cohesion of the liquid, as in the other experiments. Moreover, the force required to effect the separation was no longer independent of the material of the disk.

(184.) *Capillary Attraction*.—When a solid body is partially immersed in a liquid, the force of adhesion produces important modifications in the laws of liquid equilibrium as already enunciated. Thus, for example, if we dip the end of a fine glass tube, 2 or 3 millimetres in diameter, into water, the liquid will not maintain the same level within and without the tube as required by the principle of (130), but will be elevated in the interior of the tube, and maintained at a height which is very considerably above the exterior level, and which is the greater the smaller the diameter of the tube. Moreover, the surface of the water does not remain horizontal near the walls of the tube, as

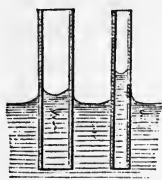

Fig. 310.

required by (129), but on the outside it curves towards the tube, as represented in Fig. 310, and in the interior it assumes a concave form, which, for tubes less than 2 millimetres in diameter, is sensibly hemispherical. If now we dip the end of the same tube into liquid mercury, we shall obtain a result equally opposed to the laws of liquid equilibrium, but of a reversed order.

The column of mercury in the interior of the tube will be depressed below the outside level, and its surface will assume a convex shape, which for a small tube is as before sensibly hemispherical, while on the outside the surface of the liquid will curve from the tube, as if repelled by it (Fig. 311). By repeating these experiments with different liquids, and with tubes of various kinds, we shall obtain results like the first whenever the liquid has the power of wetting the walls of the tube, and results like the second when the reverse is the case; while in some few cases (as, for example, when the tube is polished steel, and the liquid is alcohol) the level will not



Fig 311.

be changed, and the surface of the liquid will remain horizontal both within and without the tube. These phenomena are termed in general *capillarity*, and the curved surfaces which the liquids assume in the proximity of solid bodies are called, respectively, concave and convex *meniscuses*. In studying this subject, we will first consider what changes the molecular forces must be expected to produce *a priori* in the laws of liquid equilibrium, and afterwards we will examine the phenomena and see how closely

be changed, and the surface of the liquid will remain horizontal both within and without the tube. These phenomena are termed in general *capillarity*, and the curved surfaces which the liquids assume in the proximity of solid bodies are called, respectively, concave and convex *meniscuses*. In studying this subject, we will first consider what changes the molecular forces must be expected to produce *a priori* in the laws of liquid equilibrium, and afterwards we will examine the phenomena and see how closely

the facts coincide with our theoretical deduction. Let us commence with the simplest case possible, and consider how the surface of a liquid must be disturbed by the contact of a solid bar.

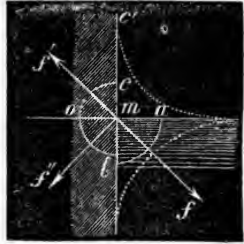

Fig. 312.

Take, for example, a liquid particle, m (Fig. 312), in contact with a solid bar, dipping under the surface of any liquid. This particle is evidently acted upon by the force of gravity, g , and by three other forces. The first of these, f , is the resultant of the attractive forces exerted by the *liquid* particles included in the quarter-sphere $m a b$. The other two, f' and f'' , are the resultants of the attractive forces exerted by the *solid* particles included in the two quarter-spheres $m o c$ and $m o b$, the radius of the sphere in each case being the insensible distance through which the molecular forces can act. We can now decompose each of these three forces into a vertical and a horizontal component. Considering the components which act in the directions $m a$ or $m b$ positive, we shall have for the horizontal components (35),

$$f \cos 45^\circ, \quad -f' \cos 45^\circ, \quad -f'' \cos 45^\circ;$$

and remembering that $f'' = f'$, we shall also have for the single resultant of the three horizontal components $(f - 2 f') \cos 45^\circ$. In like manner, for the vertical components, including gravity, we shall have,—

$$g, \quad f \cos 45^\circ, \quad -f' \cos 45^\circ, \quad f'' \cos 45^\circ,$$

and for the single vertical resultant, $g + f \cos 45^\circ$. Let us next inquire what will be the direction of the final resultant of the horizontal and vertical forces, whose values are

$$(1.) (f - 2 f') \cos 45^\circ; \quad (2.) g + f \cos 45^\circ. \quad [121.]$$

It is evident that the vertical force must always be positive, and hence directed downwards; but the direction of the horizontal force will depend on the relative values of f and f' , that is, on the relative strength of the cohesive and adhesive attractions. There may be three cases, according as f is less than, is greater than, or is equal to $2 f'$. We will consider each case separately.

1st. When $f < 2 f'$. If the cohesive force is less than twice the adhesive force, then the horizontal force [121. 1] is negative, and the resultant of this force with the vertical force [121. 2] will

fall within the angle $b m o$, and take, for example, the direction $M R$ (Fig. 313).

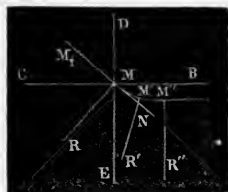

Fig. 313.

Now, since the surface of a liquid must at every point be normal to the resultant of all the forces acting at that point (129), it follows that the liquid surface will be drawn up towards the solid bar, so as to be perpendicular to the line $M R$, and tangent to the line $M N$, making with the bar an angle $D M N$, which is constant for the same substances, and is called the angle of contact.

If next we consider the liquid particles $M' M''$, &c. adjacent to M on the surface of the liquid, it is evident that on account of their greater distance they will be acted upon less strongly by the solid bar, and hence the resultants $M' R'$, $M'' R''$, &c. will approach more and more nearly the vertical, with which they will soon coincide. Thus it appears that the liquid surface, which must be at each point perpendicular to these resultants, will be curved up towards the bar, but will become horizontal at a certain small distance from it. It is easy to see that, if a second bar is dipped into the liquid parallel to the first, the surface of the liquid between the bars will take the form of a concave cylindrical surface, in case the bars are sufficiently near together, and that in a tube it would take the form of a concave meniscus, formed by the revolution of the curve $M M' M''$ round the axis of the tube.

2d. When $f > 2f'$. If the cohesive force is greater than twice the adhesive force, then the horizontal force [121. 1] is positive, and consequently directed towards the liquid. Hence

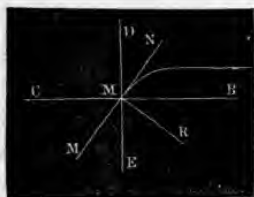

Fig. 314

the resultant of this force and the vertical force [121. 2] will fall within the angle $a m b$ (Fig. 312), taking, for example, the direction $M R$ (Fig. 314), and the surface of the liquid will be perpendicular to this resultant, making with the solid bar an angle $D M N$ less than 90° . Moreover, for the particles M', M'' ,

&c. adjacent to M on the surface of the liquid, it can be proved that the resultants of the molecular forces and gravity will approach the vertical nearer and nearer the farther we recede from the bar, and will soon coincide with it. Hence it follows that

the liquid surface will, in this case, be convex, taking the form of a convex cylinder between two parallel bars, and of a convex meniscus in a fine tube.

3d. When $f = 2 f'$. When the cohesive force exactly equals twice the adhesive force, then the horizontal force [121. 1] becomes zero, and the resultant of all the molecular forces and gravity, acting on the particle m , coincides with the vertical. In this case alone the surface of the liquid is horizontal, even to the line of contact with the solid bar, and consequently, likewise, horizontal between two bars, or in the interior of a tube.

(185.) *Form of the Meniscus.* — It is evident from the last section, that the exact form of the meniscus, and the angle of contact, depend upon the relative values of f and $2 f'$ [121], and hence upon the nature of the solids and liquids used. The conditions are changed, however, when, as is usual in such experiments, the solid bar or tube has been previously rinsed with the liquid. In such cases the action takes place between the particles of the thin film of liquid covering the solid, and those of the same liquid into which it is dipped, the solid itself serving only to sustain the liquid film, and it is then found that the result is entirely independent of the nature of the solid. Moreover, when the solid has not been previously moistened, the phenomena are rendered very irregular by the film of air which covers the surface of the bar or tube, and which it is almost impossible to remove without moistening the whole surface. So also, when the liquid has not the power of wetting the solid surface, as in the case of mercury and glass, there may be a film of air between the two of sufficient thickness to keep the liquid particles beyond the sphere of action of the adhesive force. In such cases the form of the liquid surface will be determined by the action of the cohesive force alone, and this action will be entirely similar to that which gives to the rain-drop its spherical form (129).

Since it has been observed that the surface of a liquid in a tube is concavé when it wets the walls of the tube, and convex when it has not the power of thus wetting them, it follows from the last section that a liquid will wet a solid surface when the force of cohesion between its particles is less than twice the force of adhesion of these particles to the solid.

(186.) *Pressure exerted by the Molecular Forces.* — Having seen how the molecular forces may modify the form of a liquid

surface, and produce either a concave or a convex meniscus, let us further inquire how the form of the surface may modify the law of liquid pressure already enunciated (126). In discussing the subject of liquid pressure, caused by the force of gravity (123 *seq.*), we left out of view any action which might be exerted by the molecular forces emanating from the liquid particles themselves. This leads us into no error, so long as the surface of the liquid is horizontal; but when, as in capillary tubes, this surface is curved, the action of the molecular forces can no longer be disregarded. In order to investigate the manner in which the molecular forces may influence the pressure

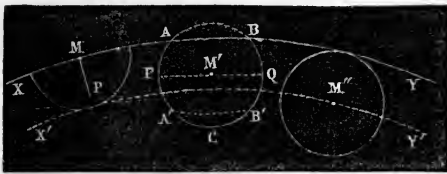

Fig. 315.

exerted by a liquid mass, terminated by a given surface, XY (Fig. 315), let us study the action which they would exert on any particle taken on or near this surface. If this molecule is *on the*

surface, as M , it will evidently be attracted by all the particles of liquid comprised within the hemisphere described round the point M , with a radius equal to the *distance of sensible attraction*, and it is easy to see that the resultant of all these attractive forces will be in the direction MP , normal to the surface. If the molecule is *within the surface*, as at M' , then the active portion of the liquid will be the mass enclosed by the *sphere of sensible attraction*, ABC . This may be divided into three parts by an equatorial plane, PQ , and by a surface, $A'B'$, symmetrical with AB , and equidistant from the equator. The attraction exerted by the portion $ABPQ$ is evidently balanced by the equal and opposite attraction exerted by $A'B'PQ$, so that the result is the same as if the molecule were only attracted by the portion $A'B'C$. The resultant of all the attractive forces exerted by the particles contained in this portion of the sphere is evidently much less than before, but still it is normal to the surface. Finally, if we take a molecule, M'' , at a distance from the surface equal to the radius of sensible attraction, it is evident that the attractive forces acting upon it will balance each other. If then we draw a surface, $X'Y'$, parallel to XY , and at a distance from it equal to the radius of sensible attraction, we shall have com-

prised between these two surfaces a liquid film whose particles are under the influence of forces acting perpendicularly to the surfaces, and exerting an effect similar to that of gravity. There must then result from the action of these molecular forces a pressure, which will be transmitted in all directions, according to the principle of (120), and whose effect must be added to those of gravity and atmospheric pressure.

(187.) *Amount and Effect of the Molecular Pressure.*—

Let us now inquire whether the form of the surface exerts any influence on the amount of the molecular pressure. For this purpose let us take a molecule, M' (Fig. 316), at a distance below the surface, $M' H$, less than $M' C$, the radius of sensible attraction, and consider what will be the relative amount of molecular pressure exerted by this molecule,—1st, when the surface is plane; 2dly, when it is concave; and 3dly, when it is convex.

If the surface is plane, as $A B$, the attraction exerted by the liquid mass $A B P Q$ is balanced by that of $A' B' P Q$, and the only force which produces pressure is the attraction exerted by $A' B' C$. Let us represent the value of this force by A .

If now the surface is concave, as $D E$, it is evident that the only portion of the liquid within the sphere of sensible attraction, whose attractive force is not neutralized, is the portion $D' E' C$, cut off by a surface $D' E'$, drawn symmetrically to $D E$. Since this liquid mass is less than $A' B' C$, the attractive force which it exerts must be less by an amount we will call B , and it is evident that the value of B will increase as the radius of curvature of the surface diminishes. The value of the force which is exerted in molecular pressure may then be represented by $A - B$, when the surface is concave.

If, lastly, the surface is convex, as $K L$, and we draw $K' L'$ symmetrical with this, it is equally evident that the active portion of the liquid is now $K' L' C$; and since this mass is greater than $A' B' C$, the value of the molecular pressure may be represented by $A + B'$, when the surface is convex.

Since what has been shown to be true of the pressure exerted

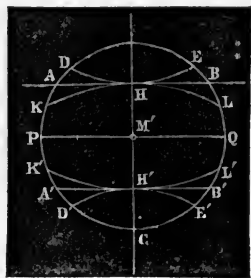

Fig 316.

by the molecule M' is true of all the molecules contained in the thin film bounded by the surfaces $X Y$, and $X' Y'$ (Fig. 315), it follows that, when the surface of a column of liquid is concave, it exerts a less pressure, and conversely, when the surface is convex, it exerts a greater pressure than when it is plane, assuming always that the radius of curvature of the surface is comparable with the radius of sensible attraction.

(188.) *Effects of Molecular Pressure.*—It is now easy to see in what way the molecular pressure may modify the principle of (130), when one of the vessels is very small. Let us

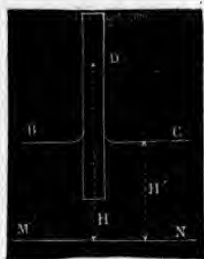

Fig. 317.

suppose, then, that we have a fine tube of glass, dipping into a liquid (Fig. 317). By the principles of hydrostatics, the level of the liquid should be the same within and without the tube, because it is a necessary condition of equilibrium that the pressure on any given section, as $M N$, should be the same, whether exerted by the column of liquid in the tube, or by the liquid mass outside, and this can only be when

$$S . H . (Sp. Gr.) = S . H' . (Sp. Gr.) \quad [122.]$$

or when $H = H'$ (compare 130). This equation, however, only has regard to the pressure exerted by liquids in consequence of their weight, although, as we have just said, the molecular forces exert a pressure themselves whose effect must be added to that of gravity. As the surface of the liquid outside the tube is horizontal, the molecular pressure transmitted by it to the section $M N$ may be represented by A , and the whole pressure on the section will be $S . H . (Sp. Gr.) + A$. If, however, the liquid wets the tube, the interior surface will be concave, and the pressure transmitted from the interior of the tube to the section will be $S . H' . (Sp. Gr.) + (A - B)$. Evidently there can only be an equilibrium when

$$S . H . (Sp. Gr.) + A = S . H' . (Sp. Gr.) + (A - B),$$

or

$$H' = H + h; \quad [123.]$$

that is to say, when the level in the tube is above the level outside. The difference of level, h , measures the difference of

pressure, B , caused by the concavity of the surface.

If the liquid does not wet the tube (Fig. 318), then the interior surface will be convex, and the pressure transmitted from the interior of the tube to the section will be $S \cdot H' \cdot (Sp. Gr.) + (A + B')$. We shall then have equilibrium when

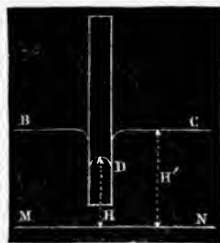

Fig 318.

$$S \cdot H \cdot (Sp. Gr.) + A = S \cdot H' \cdot (Sp. Gr.) + (A + B'),$$

or

$$H' = H - h'; \quad [124.]$$

that is to say, when the level in the tube is below the level outside; and here, as before, the difference of level measures the difference of pressure, which is caused in this case by the convexity of the surface.

Between these two conditions there is a third, in which the liquid surface is level within the tube. In this case it is evident that the molecular pressures will balance each other, and there can be equilibrium only when $H' = H$, or when the level is the same within and without the tube.

These results, which we have now deduced theoretically, are fully confirmed by observation; for we find, as has already been stated (184), that a concave meniscus is always accompanied by an elevation of the liquid column in a capillary tube, and a convex meniscus by a corresponding depression. The phenomena of capillarity may be illustrated not only by means of a simple tube, as represented in Figs. 310 and 311, but also by a siphon tube, one of whose branches is very small, while the other is at least 20 millimetres in diameter (Figs. 319 and 320). The depression or elevation of the liquid in the smaller tube becomes then very evident, and can easily be measured. A number of these tubes may be mounted together for comparison, as represented in Fig. 321.

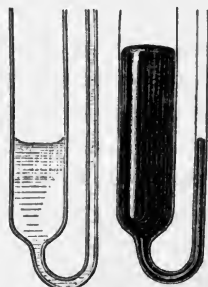

Fig 319.

Fig. 320.

These phenomena are entirely independent of the pressure

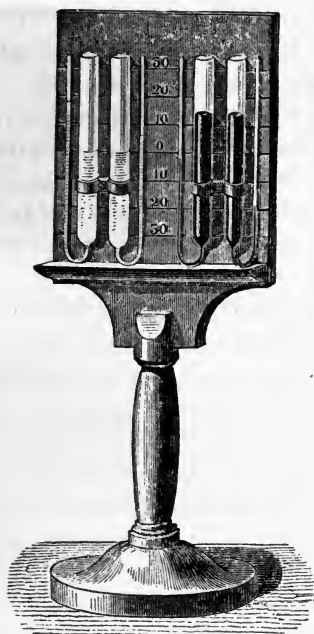

Fig. 321.

to which the apparatus is exposed. They are the same in compressed air as in a vacuum, and are not influenced by the thickness of the walls of the tube. They vary, on the other hand, with the material of the tube, and with the nature of the liquid. When, however, the tube has previously been wet with the liquid, the phenomena are also entirely independent of the material of which it is formed, and at any given temperature vary only with the nature of the liquid and the diameter of the tube.

If we take tubes of the same diameter, and dip their ends in different liquids, capable of moistening the walls, we find that the heights to which the liquid columns are elevated differ very greatly. If the tube is 1.3 m. m. in diameter, the height is 23.1 m. m. for water, 9.8 m. m. for oil of turpentine, 7.07 m. m. for alcohol, and still less for ether. It is essential in these experiments that the tubes should be previously cleaned, and carefully rinsed out with the liquid to be used. Otherwise the phenomena are also influenced by the material of the tube, and are rendered very irregular by the film of air adhering to the surface. This is especially true when the liquid has not the power of wetting the surface, and the order of the phenomena is reversed. The amount of depression in such cases not only varies with the nature of the tube and of the liquid, but, moreover, it is not the same for the same tube and liquid under different circumstances. For example, in the case of mercury and glass, the form of the meniscus, and the depression of the mercury column, which depends upon this form, vary so greatly with the impurity of the metal, the presence of the air, and the nature of the glass, that it is not possible to calculate the amount from any general measurements, but it is necessary to de-

termine it by experiment for each particular instrument. Thus, in the same tube the mercury column will be more depressed in a vacuum than in the air, especially when the air is moist. So, also, mercury which has been boiled in the air forms a less convex meniscus than mercury which has been boiled in an atmosphere of hydrogen or carbonic acid. And lastly, a small amount of oxide dissolved in the mercury may even invert the order of the phenomena, causing it to assume a plane, or even a slightly concave surface.

In determining the amount of pressure from the height of a mercury column in a barometer tube, or in other forms of tube-apparatus used in experiments on gases, it is important to correct the observations for the capillary depression; but since, from the causes just stated, the amount is uncertain, it is best either to use tubes so large that it is rendered insensible, or else so to arrange the apparatus that the effect of capillarity in one arm of a siphon is balanced by an equal effect in the other. In the barometers of Regnault and Fortin the amount of depression is a constant quantity, and is determined once for each instrument (159 and 160); but even in a well-made barometer the surface of the mercury is liable to changes, which alter the form of the meniscus, and consequently cause a variation in the amount of depression. The convexity of the meniscus can generally be restored by tapping on the glass; but when the surface of the mercury is badly soiled, it is necessary to refill the tube.

(189.) *Numerical Laws.* — Although the theory of capillarity, as thus far developed, explains and predicts the general order of the phenomena, it does not yet enable us to calculate the amount of the elevation and depression in different tubes. This, as we have seen, varies with the nature of the liquid, and, when the walls of the tube have not been previously moistened with the liquid, also with the nature of the tube. But assuming that all other conditions are equal, let us investigate the relation between the capillary effect and the size of the tube.

For this purpose let us take the simple case of a capillary tube (Fig. 322) dipping in a mass of liquid which is capable of wetting its surface, and which consequently rises in its bore to a



Fig. 322.

mean height AB . In the first place, it is evident that the mass of the tube just above this level must attract the liquid molecules below, and that there will thus result a vertical force, which will tend to raise the liquid column. Since this force is proportional to the number of solid particles within the sphere of attraction, and hence to the perimeter of the tube, we may represent it by the expression pa , in which a is a constant quantity depending on the nature of the tube and the liquid, and p the perimeter of the tube. If now, in the second place, we consider the portion of the tube between AB and CD , it is equally evident that the attractive forces exerted by the solid particles will balance each other, and can therefore produce no effect either in elevating or depressing the column. Finally, the molecules of the tube placed just above CD will attract the particles situated just below in the prolongation of the liquid column, and will evidently exert a force tending to raise this column, which equals, as before, pa , and which added to the first gives us $2pa$ as the whole value of the upward pressure.

But we have thus far left out of view the liquid mass below the end of the tube. If we conceive of the solid tube as prolonged by a tube of liquid, $CDMN$, it is evident that the liquid particles forming the walls of this tube will attract those of the liquid column just above CD , and will thus exert a force tending to depress it. Representing by a' a constant depending on the nature of the liquid, we shall have for this downward force the value pa' , and for the whole vertical force the value $p(2a - a')$, a force which will raise or depress the column according as $(2a - a')$ is positive or negative. This force must evidently be equal to the weight of the column of liquid which it elevates or depresses; and since this weight may be found by multiplying together the area of the section of the tube, s , the height of the column, h , and the specific gravity of the liquid, *Sp. Gr.*, we obtain

$$p(2a - a') = s \cdot h \cdot (\text{Sp. Gr.}),$$

or

$$h = \frac{p}{s} \cdot \frac{2a - a'}{\text{Sp. Gr.}} = \pm \frac{p}{s} a'', \quad [125.]$$

in which last $a'' = \frac{2a - a'}{\text{Sp. Gr.}}$, and is constant so long as the liquid and substance of the tube are the same.

If the tube is cylindrical, $\frac{p}{s} = \frac{4\pi D}{\pi D^2} = \frac{4}{D}$ and $h = \pm \frac{4}{D} a''$. For another tube of the same material, but different diameter, D' , we obtain $h' = \pm \frac{4}{D'} a''$, whence we deduce

$$\pm h : \pm h' = D' : D, \quad [126.]$$

or in words, *The elevations or depressions of a given liquid in cylindrical tubes of the same material, but of different diameters, are inversely proportional to the diameters of the tubes.*

If the tube has a rectangular section, the perimeter is equal to $2(m + n)$, the lengths m and n being those of the sides of the rectangle, and we have $\frac{p}{s} = \frac{2(m + n)}{m n}$. When the length of one side is infinite, we have also $n = \infty$, $\frac{p}{s} = \frac{2}{m}$, and $h = \pm \frac{2}{m} a''$, from which we can deduce

$$\pm h : \pm h' = m' : m. \quad [127.]$$

The case supposed is evidently that of two plates parallel to each other, and separated by a distance m . Hence *the elevation or depression of a given liquid between two parallel plates is inversely proportional to their distance apart.*

If, lastly, we compare the effect produced by a cylindrical tube when $h = \pm \frac{4}{D} a''$, and that by parallel plates when $h' = \pm \frac{2}{m} a''$, we obtain the proportion

$$h : h' = 2m : D, \quad [128.]$$

by which we find, that when $m = D$, then $h = 2h'$, or in words, *The variation of level caused by two plates is one half of that caused by a tube of the same nature, whose diameter is equal to the distance between the plates.*

(190.) *Verification of the Laws. First Law.* — It follows from [126], that, if the first of the three numerical laws, which have thus been deduced theoretically, is correct, the product of the elevation or depression of the liquid column into the diameter of the tube must be always a constant quantity for the same liquid. That this is approximatively, at least, the case, is shown by the following table, taken from Jamin's *Cours de Physique*,

to which we are indebted also for the general method followed in the discussion of this subject.

	Diameter D .	Elevation h .	Product $D h$.
	m. m.	m. m.	
Water,	{ 1.29	23.16	29.87
	{ 1.90	15.58	29.60
Alcohol,	{ 1.29	9.18	11.84
	{ 1.90	6.08	11.55
Parallel Plates and Water, .	1.069	13.57	14.52

This law is not, however, exact, when the diameter of the tube is so large that we can no longer neglect the curvature of the surface which terminates the liquid column (we assume always that the height of the column is measured to the lowest point of the concavity, or to the highest point of the convexity). When the diameter of the tube is not greater than one or two millimetres, the surface is approximatively hemispherical, and we can then easily estimate the amount of deviation. If, as above, we represent by h and h' the heights of two columns of the same liquid in tubes of different diameters, measured to the lowest point, n , of a concave meniscus, it is evident that, in order to obtain exactly the weight of these liquid columns, we must add to the weights of the liquid cylinders $s \cdot h \cdot (Sp. Gr.)$ and $s' \cdot h' \cdot (Sp. Gr.)$ the weight of liquid above the point n . The volume of this liquid is evidently equal to the difference of volume between a hemisphere and a cylinder of the same diameter and of a height equal to the radius of the hemisphere. Using the notation of the last section, we find for this volume the value $\frac{1}{2} D^3 \pi - \frac{1}{2} D^3 \pi = \frac{1}{24} D^3 \pi$, and for the total weights of the liquid columns the values $\frac{1}{4} D^2 \pi \left(h + \frac{D}{6} \right) (Sp. Gr.)$, and $\frac{1}{4} D'^2 \pi \left(h' + \frac{D'}{6} \right) (Sp. Gr.)$, and by the same course of reasoning as before [125], we deduce

$$\pm \left(h + \frac{D}{6} \right) : \pm \left(h' + \frac{D'}{6} \right) = D' : D. \quad [129.]$$

The double sign \pm is used, because, as can easily be proved, the proportion is equally true when the meniscus is convex. Hence it follows, that, when the tubes are not more than one or two millimetres in diameter, the law of inverse proportions is correct, when we add to the observed heights one sixth of the diameter

of the tube, the correction required for the meniscus; and observation confirms this result of theory.

When the tubes are very small, and the elevations or depressions correspondingly large, we can neglect the very small value $\frac{D}{6}$, and regard the law as accurate without this correction. When, however, the tubes are extremely small, a new cause of deviation from the law is introduced. In experiments on capillarity, as already stated, we can obtain constant results only when the surfaces of the tubes have been previously moistened with the liquid to be used, and the results are then the same as if the experiment were made with a liquid tube of less diameter, the solid wall serving only to support the liquid particles. If the tube is one or two millimetres in diameter, the thickness of the liquid film may be neglected; but when the tube is very small, this thickness sensibly diminishes its effective size, and we should therefore expect that it would raise a liquid column to a greater height than that required by the law, as we find to be the case.

When, on the other hand, the tubes are more than three millimetres in diameter, the surface of the liquid column differs so considerably from that of a hemisphere, that the proportion [129] no longer holds true, and the deviation from the law becomes very large. Even in such cases, however, the heights to which liquids will rise can be calculated when the precise form of the meniscus is given; but the methods are too complicated for an elementary treatise.

Second Law. — The second law of (189) can be verified by a very instructive experiment. If we take two glass plates, united by hinges at one side, and, having very slightly opened these hinges, dip the ends of the plates, as represented by Fig. 323, in colored water, we find that the liquid rises between these plates to a variable height, depending on the interval which separates them, its upper surface taking the form of a curve, known in geometry under the name of an equilateral hyperbola. Let us inquire whether the form of this curve does not furnish a confirmation of the law under discussion.

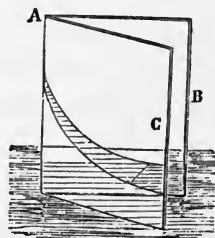

Fig. 323.

We may evidently regard the two glass plates as consisting of an infinite number of infinitely narrow parallel strips, as shown by Fig. 324. If then the law is correct, it follows [127] that the heights to which the liquid is elevated, at any two points, will be proportional to the interval between the plates at these points, so that



Fig. 324.

at every point we must have $h = \frac{2 a''}{m}$. If now we take for the axis of y the vertical line of intersection of the two planes, and for the axis of x the line of contact of the water level with one of them, we shall have (Fig. 325), $MP = h = y$, $AP = x$, and $PQ = m = Cx$, in which C is a constant quantity depending on the angle between the planes.

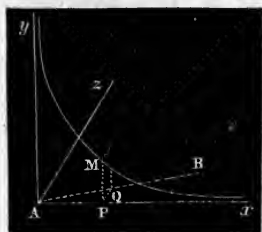

Fig. 325.

Substituting these values in $h = \frac{2 a''}{m}$, we obtain $y = \frac{2 a''}{Cx}$,

$$\text{or } xy = \frac{2 a''}{C} = \text{a constant,}$$

which is the equation of an equilateral hyperbola referred to its asymptotes as co-ordinate axes. Since this is the curve which the liquid surface always assumes, it is evident that the second law is verified by the experiment.

Third Law.—When the ends of two parallel glass plates, maintained at a small distance from each other, are dipped into water, and the difference of level measured, it has been found that the product of the distance between the plates by the elevation of the liquid is one half of that obtained with glass tubes. This fact is shown in the table on page 358, and verifies the third law.

(191.) *Influence of Temperature on Capillary Phenomena.*—The general expression for the elevation or depression of the liquid column in a capillary tube [125] may be written

$$\pm h = \frac{4}{D} \cdot \frac{2 a - a'}{(Sp. Gr.)};$$

and it is evident that any cause which changes either the specific gravity of the liquid, or the relative values of the cohesive and adhesive forces, will produce variations in the value h . Hence an increase of temperature, which diminishes the specific

gravity by expanding the liquid, would of itself alone increase the elevation or depression of the column; but since this increase of temperature produces changes in the molecular forces, and hence affects the value of the term $2a - a'$, we find that the elevation or depression, instead of increasing with the temperature, actually diminishes. This decrease is not, however, simply proportional to the temperature, but follows much more complicated laws. The following table shows the height at which the different liquids enumerated stand at 0° C. in a tube two millimetres in diameter, together with the coefficient of correction for temperature, which, multiplied by t , the number of degrees above 0° , gives the amount in millimetres to be deducted from the height at 0° , in order to find the height of the capillary column at the temperature required. The last column gives the limits of temperature between which the formulæ hold true.

	Sp. Gr. at 0° .	h m. m.			Limits of Temperature.
Water,	1.0000	15.332	$-0.0286 t$		0 to 82
Ether,	0.7370	5.400	$-0.0254 t$		-6 to 35
Olive Oil,	0.9150	7.461	$-0.0105 t$		15 to 150
Oil of Turpentine,	0.8902	6.760	$-0.0167 t$		17 to 137
Alcohol,	0.8208	6.050	$-0.0116 t$	$-0.000051 t^2$	0 to 75
Sulphuric Acid,	1.840	8.400	$-0.0153 t$	$-0.000094 t^2$	12 to 90

(192.) *Spheroidal Condition of Liquids.* — When the adhesion of a liquid to a solid surface is more than twice as great as the cohesion between its particles, it spreads over the surface of the solid and wets it (185). If, however, the force of adhesion is less than this, the liquid forms in drops, which roll round on the solid surface like drops of mercury on glass, or drops of water on oiled paper. The form of these drops is determined by the action of three forces; first, the cohesion of the particles of the liquid, secondly, the adhesion of the liquid to the solid, and lastly, gravity. When very small, the drops are sensibly spherical; but as they increase, the sphere becomes flattened by the action of gravity, and they assume a spheroidal shape. Hence liquids, under these circumstances, are said to be in a spheroidal condition. Since most solid surfaces are wet by water, alcohol, and similar liquids, the spheroidal condition is their exceptional state; but it is familiar to us in the cases just mentioned, and in several others. As the effect of heat is to diminish both the

cohesive and adhesive forces, we can easily conceive how it may so far alter their relative values as entirely to change the relations of a liquid to a solid surface. This result is readily obtained with water, alcohol, and similar liquids, which, at the ordinary temperature, wet metallic surfaces.

It will hereafter be shown, that we cannot heat a liquid in the open air above its boiling point, and hence we cannot diminish the cohesive force, except to a limited extent; while, on the other hand, we can heat the metals to a far higher temperature, and thus diminish the adhesion, until the force becomes less than twice that of cohesion, when the liquid will assume the spheroidal state. Thus, for example, if water is dropped into a metallic vessel heated above 171° C., it rolls along the surface of the metal like mercury on glass, and remains in that state until the temperature falls to 142° ; then it moistens the metallic surface, and evaporates rapidly. Alcohol acts in the same way when the temperature of the vessel is above 134° , and ether when it is above 61° . The temperature of the liquid itself, under these circumstances, is nearly constant, being always several degrees below its boiling point: thus 96.5 is the temperature of water, 75.8 that of absolute alcohol, 34.2 that of ether, and -10.5 that of liquid sulphurous acid. The temperature of the liquid may therefore be several hundred degrees below that of the metallic vessel, as is well illustrated by liquid sulphurous acid, which in the spheroidal state retains a temperature 10.5 degrees below the freezing point of water, even when the metallic crucible containing it is visibly red-hot. If water is slowly dropped into this singular liquid under these circumstances, it is at once congealed, thus exhibiting the apparent paradox of freezing water in a red-hot crucible.

One of the most instructive illustrations of the spheroidal condition of water is the rude method used in laundries for testing the degree of heat of a flat-iron. If a drop of water let fall upon it does not boil, but runs along the surface of the metal, the iron is considered sufficiently hot; but if the drop adheres, and rapidly boils away, the temperature is known to be too low. We shall have occasion to return to this subject in the chapter on Heat.

(193.) *Examples and Illustrations of Capillarity.* — One of the most familiar examples of capillary action is seen in the wicks of lamps and candles. These consist of very fine

vegetable tubes, through which the oil or melted combustible is elevated to the flame, and supplied as fast as it is burnt. This same principle also influences the circulation of the liquid juices in the porous tissues of organized beings, and it is the principal means by which water, with the substances it holds in solution, is supplied to the growing plant. It is the capillary action, which, during the droughts of summer, draws up to the surface of the soil the water necessary for vegetation, which had penetrated into it during the heavy rains of spring. When the water holds salts in solution, these are deposited as it subsequently evaporates, forming those incrustations which are frequently seen on the brick walls of old houses and on the surfaces of saltpetre beds.

The laws of capillary action furnish the explanation of many other remarkable phenomena. A platinum wire will float on the surface of mercury, although its specific gravity is very much greater than that of the liquid metal. So also a very fine metallic wire, which has been slightly greased by passing it between the fingers, can be made to float upon water, and the same is true of many metallic powders. This singular result is explained by the fact, that the floating body is not wet by the liquid, and consequently there forms around it a meniscus, which displaces a large volume of liquid in comparison with that of the solid; and since the volume of water thus displaced weighs as much as the floating body, it cannot sink. There are some insects which walk on the surface of water, but which would almost entirely sink in the liquid were it not that the capillary depression formed by their extended feet (which are kept from being wet by a greasy coating) displaces a weight of water equal to that of the insect.

(194.) *Absorption*.—The power which porous solids, like wood, cloth, paper, or animal membrane, possess of absorbing liquids, is also a phase of capillary action. These solid bodies are filled with minute channels, into which the liquid is drawn with great force, as before explained. We may gain an idea of the intensity of this force by reflecting that in a tube 1 millimetre in diameter it is measured by a column of water 30 m. m. high, and hence in a tube $\frac{1}{10}$ millimetre in diameter by a column of water 3 metres in height. Now since the minute channels with which these porous solids are filled are as small as this, or even smaller, it is evident that they will absorb water with an almost

irresistible force ; hence the difficulty of pressing out the liquid when it has once been imbibed. In many cases the absorption of a liquid is attended with an increase of volume, and the intensity of the capillary force is rendered evident by the expansive power which is thus exhibited. A common method of splitting granite rock consists in drilling a number of holes along the line of fracture. and subsequently plugging them up with dry wood. Water is then poured over the plugs, which expand and split the stone.

The amount of liquid absorbed by a given solid varies with the nature of the liquid used ; thus it has been found that 100 parts by weight of the dried bladder of an ox absorbed in twenty-four hours

268	parts of pure water,
133	“ water saturated with common salt,
38	“ alcohol, 84 per cent.
17	“ bone oil.

It has also been found, that, if the bladder saturated with oil is soaked in water, the oil is after a while entirely replaced by water, and by as much water as the bladder is capable of absorbing. These facts indicate not only that porous solids exert an unequal attraction for different liquids, but also that they attract most powerfully those of which they absorb the greatest volume.

In connection with these facts may be mentioned the singular property which many kinds of charcoal possess, of absorbing coloring-matters and other organic principles. Thus, if water colored by litmus is shaken up with pulverized charcoal, nearly the whole of the coloring-matter will be retained by the charcoal, and, on filtering, the liquid will run through colorless. A variety of charcoal called bone-black possesses this power in a high degree, and is used for removing the color from the brown syrups in the process of refining sugar. The syrups are filtered through a layer of charcoal twelve or thirteen feet in thickness, contained in a tall iron cylinder, and are thus obtained perfectly colorless. Bone-black is prepared by calcining bones in close vessels, and does not contain more than one tenth or one twelfth of its weight of charcoal ; the remainder consists of earthy matter, chiefly phosphate of lime. Whether the peculiar property under consideration is due to the charcoal alone, or whether it is also shared by the earthy salts, is not known. Other animal substances, especially

dried blood, furnish when calcined a charcoal, which, if well washed, is even more efficacious than bone-black, and the addition of carbonate of potash to the mass before calcining still further increases the decolorizing power of the charcoal.

The absorbing power of charcoal is not, however, confined to the coloring principles alone. Many inorganic substances when in solution, especially of feeble solubility, are absorbed in the same way. Professor Graham has shown that this is the case with the metallic oxides when dissolved in potash or ammonia, and with arsenious acid when dissolved in water. It is also true of most organic extractive matters. Thus, if porter is filtered through lampblack, it will be found to have lost the greater part of its bitterness, as well as its color, and in the preparation of organic extracts much of the active principle is lost, if, as is not unfrequently the case, the liquid is digested with animal charcoal for the purpose of removing the color.

(195.) *Solution.* — When the adhesion of a liquid to a solid is sufficiently strong to overcome the force of cohesion, the solid enters into solution; that is, it diffuses throughout the mass of the liquid, without destroying its transparency. Thus salt or sugar dissolves in water, resins dissolve in alcohol, fats dissolve in ether, and most of the metals dissolve in mercury. The solvent power of a given liquid for different solids varies almost indefinitely. Thus sulphate of baryta is almost insoluble in water; sulphate of lime dissolves in the proportion of about one part in 400 parts of water, and sugar in one third of its weight of water, while hydrate of potassa may be dissolved in this liquid to almost any extent.

If we add a solid body, in successive portions, to a liquid capable of dissolving it, we find that the first portions disappear very rapidly, but each succeeding portion dissolves less rapidly, until at length a point is reached when the solid is no longer dissolved. The liquid is then said to be saturated with the particular solid. It would appear that the adhesion of the liquid had the power of overcoming the cohesion of the solid to a limited extent, until the two forces were in a condition of equilibrium. A liquid, however, which is saturated with one substance may still continue to dissolve others.

The solvent power of a given liquid for the same solid, as a general rule, varies very greatly with the temperature. Since

heat tends to weaken the force of cohesion, we should naturally expect that it would increase the solvent power of a liquid, and we find that in most cases it does. There are, however, many striking exceptions to this rule. Thus water at the freezing point dissolves nearly twice as much lime as it does when boiling; and in like manner sulphate of lime, citrate of lime, sulphate of lanthanum, and several other substances, are known to be more soluble in cold than in hot water.

The increase of solubility with the temperature is very unequal in different cases. The solubility of common salt scarcely increases between 0° and 100° . Thus 100 parts of water dissolve at the ordinary temperature 36 parts of common salt, and at the boiling point a little over 39 parts. With a few salts the increase of solubility is exactly proportional to the temperature, and may be represented by the general formula, $S = A + Bt$, in which A represents the solubility at 0° , and B the increase of solubility for each degree of temperature. This is the case with the following three salts. One hundred parts of water dissolve at t° ,

of Sulphate of Potash,	$S =$	^{Parts.} 8.36	$+ 0.1741 t,$
“ Chloride of Potassium,	$S =$	29.23	$+ 0.2738 t,$
“ Chloride of Barium,	$S =$	32.62	$+ 0.2711 t.$

In most cases, however, the solubility increases more rapidly than the temperature. This is the case with common nitre, as may be seen in the following table, in which the solubilities both of nitre and chloride of potassium are given side by side for every 20° between the freezing and boiling points of water.

<i>Chloride of Potassium.</i>			<i>Nitre.</i>		
Temperature.	Parts of Salt in 100 of Water.	Difference.	Temperature.	Parts of Salt in 100 of Water.	Difference.
0°	29.23		0°	13.32	
20	34.70	5.47	20	31.70	18.38
40	40.18	5.48	40	63.97	32.27
60	45.66	5.48	60	110.33	46.36
80	51.14	5.48	80	170.25	59.92
100	56.62		100		

Since the solubility of a salt is always some function of the temperature, it can in every case be expressed by the general formula, into which every algebraic function may be developed :

$$S = A + Bt + Ct^2 + Dt^3 + \&c. \quad [130.]$$

In this formula, A is the solubility at 0° , and $B, C, D, \&c.$ are empirical coefficients, which can be easily calculated in any given case from the results of experiment. Thus, for example, 100 parts of water dissolve at the temperature t an amount of nitre represented by

$$S = 13.32 + 0.5738t + 0.017168t^2 + 0.0000035977t^3,$$

and of nitrate of baryta an amount

$$S = 5.00 + 0.17179t + 0.0017406t^2 - 0.0000050035t^3.$$

The values of the coefficients of the powers of t are calculated by substituting in the general equation [130] the value of A , and also the values of S and t , for each temperature at which the solubility has been determined. We shall thus obtain as many separate equations as there are separate determinations, and, by combining them together according to the well-known methods of algebra, we can easily calculate the coefficients required. It is evident that we can only ascertain as many coefficients as there are equations, and also that the resulting formula is purely empirical, and can only be trusted for temperatures between those at which the experiments were made.

The solubility of a salt at different temperatures can be also expressed graphically, according to the method of analytical geometry, as represented in Fig. 326. The horizontal axis,

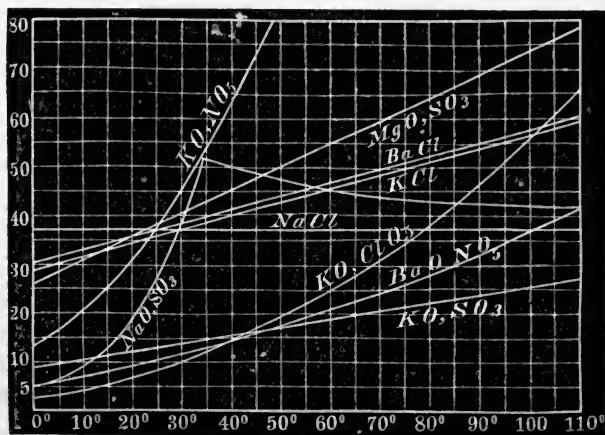

Fig. 326.

which corresponds to the axis of abscissas, is divided into equal parts, which indicate degrees of temperature, and the vertical

axis, which corresponds to the axis of ordinates, is also divided into equal parts, which indicate the number of grammes of salt soluble at the given temperatures in 100 parts of water. In order to form the curve, we fix as many points as possible from the experimental data, and then through the points thus determined we draw a line, which is the curve required. We can now, by inspection, easily determine the solubility of the salt at any temperature which is within the limits of our experiments. Suppose, for example, we wish to know the solubility of nitre at 40° , we follow up the vertical line marked 40° until it crosses the curve; and then, opposite to the point of intersection, we find on the axis of ordinates the number 64, indicating that at this temperature 64 parts of salt dissolve in 100 parts of water. Such curves convey at a glance a general idea of the law which the solubility of a given salt follows, and also the relative solubility of different salts at any given temperature. Thus it will be noticed that the curve of common salt is a straight line parallel to the horizontal axis, indicating that its solubility does not vary with the temperature. The curves of chloride of barium and chloride of potassium are also straight lines, inclined at a certain angle to the horizontal axis, showing that the increase of solubility is directly proportional to the temperature. The curve of sulphate of magnesia is also a straight line, but more inclined to the horizontal than the last, proving that the solubility of this salt increases proportionally to the temperature, but at a more rapid ratio than that of the last two. The curves of nitrate of baryta, of chlorate of potassa, and of nitrate of potassa, indicate that their solubility increases more rapidly than the temperature, and according to very different laws. Lastly, it will be noticed that the order of relative solubility of the three salts, sulphate of potassa, nitrate of baryta, and chlorate of potassa, is completely inverted in passing from 35° to 55° .

The relative solubility of chemical compounds is one of the most important circumstances in determining chemical changes; and it can be easily seen how important these tables of curves must be to the chemist. Unfortunately, full determinations of the solubility of substances at different temperatures have only been made in a few cases, and these have been mostly limited to solubility in water.

From a knowledge of the solubility of a solid in one liquid, we can draw no conclusions in regard to its solubility in an-

other, and this is also true in regard to the law according to which the solubility changes with the temperature. This generally differs entirely for different liquids, even when the solid is the same, and must therefore be determined separately for each.

In several cases the solubility of substances has been determined both above and below their melting point; but no sudden change of solubility has been noticed at this point, as might have been expected. Thus the melting points of spermaceti, paraffine, and of several other similar solids, are below the boiling point of alcohol, so that we can determine the solubility of these substances in alcohol, both above and below their melting points. In each case, the solubility has been found to increase gradually throughout the whole range of temperature, and the melting of the solid does not appear by itself alone to produce any change.

(196.) *Determination of Solubilities.*—In order to determine the solubility of a substance at a given temperature, a saturated solution is first prepared at the temperature required. This may be prepared in one of two ways. We may either keep the liquid in contact with a large excess of the solid for a long time, at the given temperature, until it has dissolved all that it can, or we may prepare a saturated solution at a slightly higher temperature, and, after having cooled it to the required temperature, keep it at that point until the excess of the solid has been deposited. Experiments have proved that we obtain the same result by both methods; but in employing the second, it is necessary to take certain precautions. It has been observed, that a liquid, when not in contact with the solid particles themselves, will retain in solution an amount of the solid which is greater than it can normally dissolve at the given temperature. But if a few crystals of the solid are dropped into it, the excess will be at once deposited. Violent agitation favors the separation, but we cannot in any case be certain that the excess has been completely removed until after several hours.

Having prepared a saturated solution, by either of these processes, we next transfer a quantity of it to a tared flask, and carefully determine its weight, which should be about 50 grammes. We then evaporate the liquid by placing the flask over a sand-bath or a small furnace, as represented in Fig. 327, taking care to keep the neck of the flask, which should be quite long, in-

clined at an angle of about 45° , in order to prevent loss by spitting. The evaporation is continued until both the water of crystallization and that of solution have been driven off, and the salt left in an anhydrous condition. The last traces of moisture are best removed by blowing into the flask a stream of dry air, through a glass tube attached to the nozzle of a pair of bellows. When the flask is cold, we weigh it, and thus obtain the weight of the anhydrous salt which the solution contained, and from

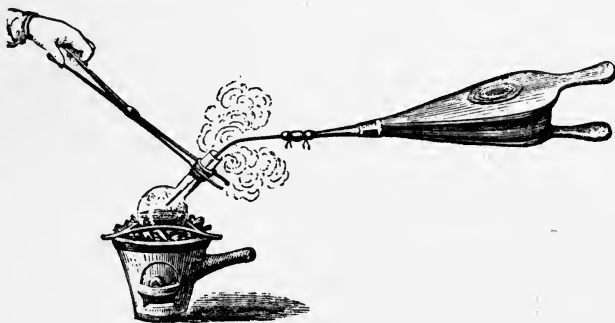

Fig. 327.

this weight it is easy to calculate the weight of salt dissolved by 100 parts of water at the given temperature.

Let us represent the weight of solution used in our experiment by W , and the weight of dry salt obtained by W' . $W - W'$ is then the weight of water which dissolves a weight W' of the anhydrous salt. The amount of salt which 100 parts of water will dissolve may then be ascertained by the proportion, $W - W' : W' = 100 : X$, from which we get $X = 100 \frac{W'}{W - W'}$. If the salt contains water of crystallization, we shall wish to calculate from the weight of the anhydrous residue the weight of crystallized salt which 100 parts of water dissolved at the temperature of the experiment. Let us represent by w the weight of water of crystallization with which the weight W' of anhydrous salt combines. $W' + w$ then evidently represents the weight of crystallized salt which was dissolved in the weight of water $W - (W' + w)$. Hence we get the proportion, as before, $W - W' - w : W' + w = 100 : X$, and $X = 100 \frac{W' + w}{W - W' - w}$, the amount of crystallized salt which will dissolve at the given temperature in 100 parts of water.

Instead of evaporating the solution, it is frequently more convenient to determine the weight of salt dissolved by precipitating one of its constituents, as in the ordinary method of chemical analysis. Thus the amount of sulphate of soda in a solution may be ascertained by precipitating the sulphuric acid as sulphate of baryta, and afterwards collecting and weighing the precipitate in the usual way; and the same method may be followed with any sulphate. In like manner, the solubility of any chloride in water may be determined by precipitating the chlorine as chloride of silver. In either case, from the weight of the precipitate we can easily calculate, by the rules of stoichiometry, the weight of salt which was in solution, whether in an anhydrous or a crystalline condition. When a salt is easily decomposed by heat, this chemical method of determining its solubility is always to be preferred.

(197.) *Solution and Chemical Change.*—Solution is generally regarded as merely a mechanical separation of the particles of a solid, which are diffused through the liquid solvent. Thus, when sugar dissolves in water, its particles are diffused throughout the liquid; but they are not supposed to undergo any essential change, for the syrup retains the sweetness of the sugar, and on evaporation yields solid sugar, with all its peculiar properties. So also a solution of camphor in alcohol partakes of the properties of both substances, and when evaporated deposits the solid camphor entirely unchanged. Such a change is supposed to be entirely mechanical, and to differ widely from true chemical combination, in which the properties of the combining substances are entirely merged and lost in those of the compound. Thus, when we add lime to dilute nitric acid, it apparently dissolves, as sugar dissolves in water, and the result is a clear solution; if, however, we examine the solution, we find that the properties of lime have disappeared, and on evaporating it we obtain, not lime, but a new substance called nitrate of lime. These examples would seem to indicate that there is a very marked distinction between solution and chemical combination, and this conclusion is apparently confirmed by the fact, that whereas chemical combination takes place most easily between those substances which are most unlike, solution generally occurs most readily when the solvent is more or less closely allied in its properties to the body dissolved; thus mercury dissolves the metals, alcohol

the resins, and oils dissolve the fats. But if, instead of comparing these extreme cases, we study the whole range of chemical phenomena, we shall find that the distinction between solution and chemical combination is by no means so clearly marked, and that it is impossible to say where the one ends and the other begins. In many cases, what seems to be an example of simple solution can be shown to be a mixed effect, at least, of solution and chemical combination; and between this condition of things, where the evidence of chemical combination is unmistakable, and a simple solution like that of sugar in water, we have every degree of gradation. To such an extent is this true, that the facts seem to justify the opinion that solution is in every case a chemical combination of the substance dissolved with the solvent, and that it differs from other examples of chemical change only in the weakness of the combining force. There are many remarkable phenomena connected with the solution of salts in water, which are probably caused by the intervention of chemical affinity.

There are but few anhydrous salts which dissolve in water without entering into chemical combination with it; in such cases we obtain, not, properly speaking, a solution of the anhydrous salt, but a solution of a compound of the anhydrous salt and water. Thus, for example, if we dissolve anhydrous sulphate of soda in water, every 44.2 parts of the salt combine with 55.8 parts of water, and we obtain a solution, not of Na O, SO_3 , but of $\text{Na O, S O}_3 \cdot 10 \text{HO}$; and on evaporating the solution at the ordinary temperature, crystals of the hydrated salt are deposited. The water which is thus combined with the salt is termed water of crystallization. It is combined in definite proportions, but is united by so feeble an affinity, that it is entirely driven off when the crystallized salt is heated to 33° in the open air. It is true that it is difficult, and frequently impossible, to ascertain the condition in which a salt exists when in solution, and that the condition in which it is deposited on evaporation is not necessarily the same as that in which it was dissolved. Even in the case just cited, it is impossible to determine with certainty whether the hydrated salt exists as such, in solution, or whether it is first formed at the moment of crystallization. Several facts, however, seem to support the first hypothesis.

On examining the curve of solubility of anhydrous sulphate of soda (Fig. 328), it will be noticed that the solubility rapidly

increases with the temperature up to 33° , where it reaches its maximum, and then diminishes as the temperature rises above this point. Such a sudden break in the continuity of the curve as this is inexplicable, at least with our present knowledge, if we suppose that the water holds in solution one and the same body throughout the whole range of temperature; while it is easily explained, if we assume that the composition of the salt in solution changes with the temperature; — for if, as would naturally be the case, the solubility of the salt is different in its hydrated

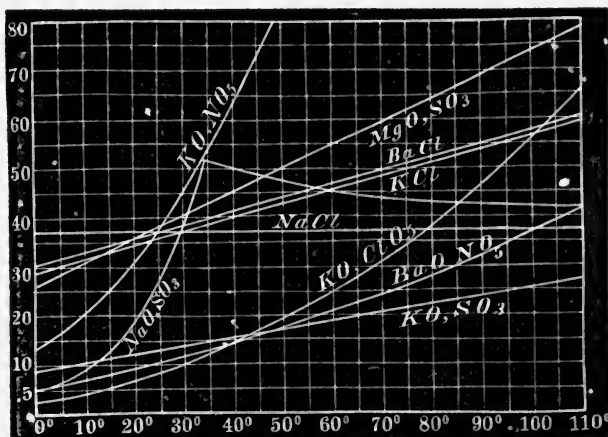

Fig. 328.

and its anhydrous conditions, the sudden change in its solubility may be caused by a change of composition commencing at a particular point. That this is the case with sulphate of soda is substantiated by the fact, that the sudden change in the law of its solubility takes place at 33° , the temperature at which the hydrated salt loses its water in the air. It is not supposed, however, that the change of composition is completed at that temperature, but only that it commences at that point, and becomes more complete as the temperature rises. Below 33° , the change of solubility is owing to the natural effect of heat in increasing the solubility of the hydrated salt. Above 33° , the change is a mixed effect of the cause just mentioned and of the change of the hydrated into the less soluble anhydrous salt.

It is obvious, from what has been stated, that the curve of solubility of anhydrous sulphate of soda given in Fig. 328 is a

pure fiction, since below 33° it is $\text{Na O}, \text{SO}_3 \cdot 10 \text{HO}$, and not $\text{Na O}, \text{SO}_3$, which is in solution; and the same is true also of sulphate of magnesia and chloride of barium, both of which form crystalline compounds in water. Indeed, in order that such a curve should be a representation of actual facts, it is essential to know in what condition the salt exists in solution at each temperature, and to calculate the solubility solely for the hydrate which is known to be present. A separate curve should then be constructed for each definite compound, between the limits of temperature at which it is known to exist. This has been done in the case of sulphate of soda, by Loewel,* who has determined separately the solubility of the three compounds $\text{Na O}, \text{SO}_3$, $\text{Na O}, \text{SO}_3 \cdot 7 \text{HO}$, and $\text{Na O}, \text{SO}_3 \cdot 10 \text{HO}$, between the limits of temperature at which they are capable of existing. His numerical results are given in the table on page 375,† and from them the curve may easily be drawn.

In the case of the two hydrates, the table gives in each instance the amount of anhydrous salt corresponding to the hydrate dissolved, and by comparing the three columns headed "anhydrous salt," it will be seen that the amount of $\text{Na O}, \text{SO}_3$ which 100 parts of water will dissolve at 20° , for example, varies very considerably with the condition of hydration in which it exists. It will also be noticed, that the change of solubility for each compound follows a uniform law throughout; the solubility increasing with the temperature in the case of the two hydrates, and diminishing with the temperature in that of the anhydrous salt. It is the combination of these two phenomena which causes the seeming irregularity in the curve of anhydrous sulphate of soda, as determined by Gay-Lussac, and represented in the figure above. Similar irregularities, which have been observed in seleniate of soda, carbonate of soda, and many other salts, are probably to be explained in the same way, although the subject has not been as yet sufficiently investigated to furnish the data for a satisfactory conclusion in all cases.

Loewel, whose memoirs on the solubility of sulphate of soda we have just cited, has investigated with equal care the solubility of a few other salts.‡ In the case both of carbonate of soda

* *Annales de Chimie et de Physique*, Tom. XXIX. p. 62; Tom. XXXIII. p. 334.

† *Ibid.*, Tom. XLIX. p. 32.

‡ *Ibid.*, Tom. XXXIII. p. 334; Tom. XLIII. p. 405; Tom. XLIV. p. 313.

SOLUBILITY OF SULPHATE OF SODA, DETERMINED BY GAY-LUSSAC.		SOLUBILITY OF SULPHATE OF SODA, IN EACH OF ITS THREE MOLECULAR CONDITIONS, DETERMINED BY LOEWEL.							
Tempera- tures.	100 Parts of Water hold in Solution, when saturated,		SALT CRYSTALLIZED WITH 10 HO.						
	Anhydrous Salt.	Salt crystallized with 10 HO.	100 Parts of Water hold in Solution, when saturated,						
Tempera- tures.	100 Parts of Water hold in Solution, when saturated,		SALT CRYSTALLIZED WITH 7 HO.						
	Anhydrous Salt.	Salt crystallized with 10 HO.	Anhydrous Salt.	Salt crystallized with 7 HO.					
Tempera- tures.	100 Parts of Water hold in Solution, when saturated,		SALT CRYSTALLIZED WITH 10 HO.						
	Anhydrous Salt.	Salt crystallized with 10 HO.	Anhydrous Salt.	Salt crystallized with 10 HO.					
0	A.	B.	C.	D.	E.	F.	G.	H.	I.
0.00	5.02	12.16			5.02	12.16	19.62	44.84	59.23
11.67	10.12	26.33			9.00	23.04	30.49	78.90	112.73
13.30	11.74	31.29			13.20	35.96	37.43	105.79	161.57
17.91	16.73	48.15	53.25	371.97	16.50	48.41	41.63	124.59	200.00
25.05	28.11	99.08	52.76	361.51	19.40	58.35	44.73	140.01	234.40
28.76	37.35	160.92	51.53	337.16	23.00	98.48	52.94	188.46	365.28
30.75	43.05	215.02	51.31	333.06	30.00	109.81	54.97	202.61	411.45
31.84	47.37	269.07	50.37	316.19	40.00	184.09			
32.73	50.65	321.16	49.71	305.06	50.76	323.13			
33.88	50.04	310.50	49.53	302.07	55.00	412.22			
40.15	48.78	290.00	48.78	290.00					
45.04	47.81	275.34	47.81	275.34					
50.40	46.82	261.36	46.82	261.36					
59.79	45.42	242.89	45.42	242.89					
70.61	44.35	229.87	44.35	229.87					
84.42	42.96	213.98	42.96	213.98					
103.17	42.65	210.67	42.65	210.67					

and sulphate of magnesia, he found, very remarkably, that the solubility not only differed for the different hydrates, but also was different for the different states of the same hydrate. Thus the salt $\text{NaO}, \text{CO}_2 \cdot 7 \text{HO}$ can be obtained in two different conditions or allotropic modifications, which we may distinguish as *a* and *b*, the salt *a* crystallizing in rhombohedrons, the salt *b* in tabular prisms. Loewel observed that the solubility of the salt was very different in these two modifications, that of *a* being nearly twice as great as that of *b*. The table on page 377, which has been taken from the original memoir,* gives the solubility at different temperatures, not only of these two modifications, but also of the ordinary crystallized carbonate of soda, which contains ten equivalents of water of crystallization. In the case of each salt, the corresponding amounts of anhydrous salt are given for the sake of comparison.

This table illustrates even in a more marked manner than the last the fact on which we have insisted so strongly in this section, that the solubility of a salt varies not only with the temperature, but also with its state of hydration; and it illustrates an additional fact, that the solubility may also be altered by a mere change of molecular condition, without any change in composition. Phenomena analogous to those just described were also observed by Loewel in the case of sulphate of magnesia, but for the details in regard to them we must refer to the original memoir.†

(198.) *Supersaturated Solutions.*—Water is said to be supersaturated when it contains in solution more of a salt than it would dissolve if presented to the salt at the given temperature. That saturated solutions do not at once deposit the excess of salt which they hold in solution, when cooled to a lower temperature, is a fact familiar to every one who has experimented on this subject; but there can be also no doubt that the prominent examples, which are frequently cited as illustrations of this fact, are to be referred to the intervention of the force of chemical affinity in a manner similar to that explained in the last section.

If we prepare a boiling saturated solution of sulphate of soda in a glass flask, and, having corked the flask while the solution is boiling, allow it to cool to the temperature of the air, it may be

* *Annales de Chimie et de Physique*, Tom. XXXIII. p. 334.

† *Ibid.*, Tom. XLIII. p. 405.

Temperature	SATURATED SOLUTIONS OF Na O, CO ₂ . 10 HO contain,		SATURATED SOLUTIONS OF Na O, CO ₂ . 7 HO b contain,			SATURATED SOLUTIONS OF Na O, CO ₂ . 7 HO a contain,		
	In 100 Parts of Water of Anhydrous Salt.	In 100 Parts of Water of Salt crystallized with 10 HO.	In 100 Parts of Water of Salt crystallized with 7 HO b.	In 100 Parts of Water of Salt crystallized with 10 HO.	In 100 Parts of Water of Anhydrous Salt.	In 100 Parts of Water of Salt crystallized with 7 HO a.	In 100 Parts of Water of Salt crystallized with 10 HO.	
	A.	B.	C.	D.	E.	F.	G.	H.
0	6.97	21.33	20.39	58.93	84.28	31.93	112.94	188.37
10	12.06	40.94	26.33	83.94	128.57	37.85	150.77	286.13
15	16.20	63.20	29.58	100.00	160.51	41.55	179.90	381.29
20	21.71	92.82	38.55	122.25	210.58	45.79	220.20	556.71
25	28.50	149.13	38.07	152.36	290.91			
30	37.24	273.64	43.45	196.93	447.93			
38	51.67	1142.17						
104	45.47	539.63						

kept for months without crystallizing; but the moment a glass rod or a crystal of Glauber's salt is dipped into it, the whole mass becomes semi-solid from the sudden formation of crystals, which ray out from the solid nucleus in every direction. This singular phenomenon was formerly supposed to be similar to what is frequently observed during the freezing of water and the solidifying of monohydrated acetic acid, melted phosphorus, and many other substances. It is well known that these liquids, if kept perfectly still, may be cooled several degrees below the melting point without losing their liquid condition, but that if disturbed when in this state, they at once become solid. These phenomena have been referred to the inertia of the particles, which tends to retain the substance in a liquid condition below the usual temperature, and the same explanation has been extended to the sudden crystallization of sulphate of soda, as above described.

Loewel, in the memoir already referred to,* has investigated this subject with great care. He found that, if a supersaturated solution of sulphate of soda is cooled to a low temperature, it deposits crystals containing seven equivalents of water, which are much more soluble than the ordinary crystals of Glauber's salt † ($\text{Na O, SO}_3 \cdot 10 \text{ HO}$). From this fact he concluded that the so-called supersaturated solution is not a *supersaturated* solution of Glauber's salt, but merely a *saturated* solution of the more soluble hydrate ($\text{Na O, SO}_3 \cdot 7 \text{ HO}$). That the solution is not at all changed by the deposition of the crystals $\text{Na O, SO}_3 \cdot 7 \text{ HO}$, is proved by the fact, that, if it is exposed to the air or touched by a glass rod, it becomes suddenly semi-solid from the deposition of Glauber's salt. These, and a large number of additional facts which Loewel ‡ has observed, all tend to sup-

* Annales de Chimie et de Physique, Tom. XXIX. p. 62.

† See table on page 375.

‡ In a more recent memoir, Loewel inclines to the opinion, that sulphate of soda always dissolves in water as an anhydrous salt, and hence that in a solution made with $\text{Na O, SO}_3 \cdot 10 \text{ HO}$, or $\text{Na O, SO}_3 \cdot 7 \text{ HO}$, none of the water is combined chemically with the salt as water of crystallization. Such a change of views does not, however, seem to be a necessary inference from the facts cited, and, as he admits, the new hypothesis leaves the unequal solubilities of the different hydrates entirely unexplained. The author, therefore, does not think it necessary to change the opinion expressed above in the text, although it is true that these later investigations of Loewel seem to show that at certain temperatures sulphate of soda exists in the so-called supersaturated solutions in an anhydrous condition. See Annales de Chimie et de Physique, (3^e Série,) Tom. XXIX. p. 32, and compare Jahresbericht der Chemie, &c. für 1857, S. 321. See also an article by Dr. Hugo Schiff, Ann. der Chem. und Pharm., Band CXL S. 68.

port the conclusion, that in the so-called supersaturated solution of sulphate of soda the salt exists in solution combined with seven equivalents of water, and does not crystallize until some circumstance causes it to combine with three equivalents more of water, and to change into the less soluble compound which we have called Glauber's salt. What the circumstances are which produce this singular change, or in what way they act, we do not yet fully understand. Some very remarkable facts in connection with it have been noticed by Loewel and others. Thus a glass rod, if heated and afterwards cooled, loses its power of causing the crystallization. Alcohol, if poured into the flask so as to form a layer over the solution, generally causes it to crystallize; but if previously boiled, it no longer produces this effect. It slowly, however, withdraws the water from the solution, and causes it to deposit crystals of $\text{Na O, SO}_3 \cdot 7 \text{HO}$; and it was in this way that Loewel obtained the largest and purest crystals of this hydrate. The opinion has been advanced by Lieben,* that it is the dust floating in the air, or adhering to the glass rod, which causes the sudden crystallization of supersaturated solution; and he has endeavored to show that neither the air nor a solid body will produce the effect after they have been freed from dust, by heating, by washing with sulphuric acid, or by any other means. This theory, although ingenious, and supported by experiment, does not meet all the facts of the case, and the subject requires further investigation.

The phenomena of "supersaturated" solutions, which are so marked in the case of Glauber's salt, have also been noticed in the case of carbonate of soda, of sulphate of magnesia, of acetate of soda, of chloride of calcium, and of many other salts.† In some of these cases, they are to be explained as in the case of Glauber's salts, by the formation of a hydrate more soluble than the one dissolved, while in others they may be caused by the formation of a more soluble modification of the same hydrate; but the whole subject is still involved in great obscurity.

Solids on Gases.

(199.) *Absorption of Gases by Porous Solids.*—If a piece of well-burnt boxwood charcoal is plunged while red-hot under mercury, and when cold passed up into a jar of gas confined over

* Wien. Acad. Ber., XII. 771 and 1087.

† See the memoirs of Loewel, just cited.

the same liquid, it will be found to absorb the gas to a greater or less extent, varying with the nature of the gas used. According to Saussure's experiments, one cubic centimetre of charcoal will absorb the number of cubic centimetres of the different gases given in the following table:—

Absorption of Gases by Charcoal.

Ammonia, 90 c. m. ³ Chlorohydric Acid, 85 " Sulphurous Acid, 65 " Sulphide of Hydrogen, 55 " Protoxide of Nitrogen, 40 " Carbonic Acid, 35 "		Olefiant Gas, 35 c. m. ³ Carbonic Oxide, 9.4 " Oxygen, 9.2 " Nitrogen, 7.2 " Marsh Gas, 5.0 " Hydrogen, 1.7 "
--	--	---

In some cases the volume of the gases thus condensed is less than that which they would occupy in a liquid state, and as a general rule, the more readily a gas can be condensed to a liquid, the greater is the volume absorbed by the charcoal. It will also be noticed, that the above results follow very nearly the same order as the solubility of the gases in water.

A piece of freshly burnt charcoal, if exposed to the air, condenses the gases and moisture of the atmosphere to such an extent, that its weight frequently increases one fifth in a few days. The presence of condensed air in common wood charcoal can easily be made evident by plunging it under hot water. The heat of the water expands the confined air, which is thus driven out of the pores of the wood, and bubbles up through the water. Owing to this absorbing power of charcoal, water saturated with many gases may be freed from them by filtering it through ivory-black. Water impregnated with sulphide of hydrogen may be in this way so perfectly purified, that its presence cannot be detected either by the nauseous odor or by the ordinary tests.

This power of absorbing gases is not confined to charcoal, but belongs in a greater or less degree to other porous solids. The following table gives the number of cubic centimetres of different gases absorbed respectively by one cubic centimetre of Meerschäum, plaster of Paris, and silk, when the temperature is 15° and the pressure of the air 73 c. m. By comparing this table with the last, it will be noticed that not only the absolute quantities of the gases absorbed are different for different solids, but also that the relative power of absorption of these solids for the different gases is different in every case.

Absorption of Gases by Meerschaum, Plaster of Paris, and Silk.

	Meerschaum.	Plaster of Paris.	Silk.
Ammonia,	15. c. m. ³		78.1 c. m. ³
Protoxide of Nitrogen,	3.75 "		
Carbonic Acid,	5.26 "	0.43 c. m. ³	1.1 "
Oxide of Carbon,	1.17 "		0.3 "
Oxygen,	1.49 "	0.58 "	0.44 "
Nitrogen,	1.60 "	0.53 "	0.13 "
Hydrogen,	.44 "	0.50 "	0.3 "

In like manner the metals in the state of fine powder, lead, iron, and platinum, for example, absorb gases in very large amounts. The finely divided platinum called platinum-black, which is obtained by precipitating a solution of chloride of platinum with alcohol, absorbs, according to Doebereiner, 250 times its own volume of oxygen. The latent heat which is set free by this great condensation is sufficient to ignite the metallic mass. Platinum sponge, and even platinum plate, possess the same power, although to a less degree, and it is probable that all solid surfaces exert a similar influence to a limited extent.

The absorption of gases by solids is very greatly influenced both by the temperature and the pressure to which they are exposed. The higher the temperature, the smaller is the amount of gas absorbed, and the most efficient means of expelling the gas from a porous solid is to expose it to a red heat. It is however uncertain whether even in this way we can remove all the gas condensed on the surfaces of solid substances, and at all events to do this requires a considerable time. Charcoal and other porous solids absorb the largest amount of gas only after a prolonged ignition in a vacuum. In filling a barometer tube the mercury is boiled in the tube in order to remove the air and moisture, not only from the mercury, but also from the surface of the glass.

The greater the pressure to which a gas is exposed, the greater is the quantity which is absorbed by a solid; but then the quantity does not increase so rapidly as the pressure. On the other hand, under a diminished pressure a solid body absorbs a less quantity of gas, but a greater volume. Hence it is not possible by means of an air-pump to remove all the air from a porous solid.

If a porous body, which is saturated with one gas, is put into

a different gas, it gives up a portion of the gas which it had first absorbed, and takes in its place a quantity of the second. Sometimes the presence of one gas increases the power of a solid for absorbing a second. Thus charcoal saturated with oxygen will absorb more hydrogen, and charcoal saturated with hydrogen will absorb more nitrogen, than it would if the other gas was not present. But as a general rule, the presence of one gas diminishes the power of a solid for absorbing others. Thus charcoal, which after ignition will absorb thirty-five times its volume of carbonic acid, will only absorb about fifteen times its volume if it has been previously exposed to the atmosphere, and thus saturated with air and moisture.

From the analogous constitution of liquids and gases, we should naturally expect that solids would act on these two forms of fluid matter in an analogous way. The same adhesive force which attracts liquids to the surfaces of solids we should expect would also attract gases; and, moreover, since gases are very compressible, we should further expect that the adhesion would condense the gas upon the surface in proportion to the strength of the attraction. Moreover, as in the case of liquids, we should expect that the amount of gas adhering to the surface or absorbed into the pores of a solid would vary with the nature both of the solid and of the gas, with the extent of the surface, with the fineness of the pores, and, lastly, with the temperature, becoming less as the temperature rose.

The phenomena just described, it will be noticed, coincide perfectly, as far as they go, with these natural inferences, thus showing that they are merely phases of adhesion and capillary action. The force of surface attraction, and hence the amount of gas absorbed, varies even more markedly than in the case of liquids, both with the nature of the solid and that of the gas. It varies also with the extent of the surface; and, other things being equal, it is greatest with porous bodies or fine powders, which expose the greatest surface; finally heat, which lessens the attractive force, diminishes the amount of gas absorbed by a solid, as it does the amount of liquid. There are, it is true, phenomena connected with the adhesion of gases to solids which liquids do not present, but these are such as may be supposed to arise from the special law of compressibility, which all gases obey.

The phenomena described in this section, like those both of

capillarity and solution, are greatly influenced, it will be noticed, by the chemical nature of the bodies concerned, and in fact pass by insensible gradations into those which we should class among purely chemical changes. Like most phenomena which occupy the debatable ground between chemistry and physics, they present great complexity, and are difficult to investigate, so that our knowledge in regard to them is exceedingly incomplete.*

There are many phenomena besides those of absorption which are connected with the adhesion of gases to solids. The fact that iron filings, and many other fine powders, sifted over the surface of water, will float, though very much heavier than the liquid, has already been mentioned. This was then explained by the principles of capillary action. The water is prevented from wetting the solid, and therefore forms around the particles a concave meniscus which buoys them up. But it is solely the thin film of air adhering to these particles which prevents them from becoming wet, when they would at once sink. The same is true also of the platinum wire floating on mercury, and of other seemingly paradoxical phenomena. In all cases, if the liquid is boiled, the film of air is removed and the paradox disappears.

Liquids on Liquids.

(200.) *Liquid Diffusion.*—As a general rule, the adhesion between the particles of different liquids is so much greater than the cohesion between their own molecules, that they may be mixed together in any proportion. This is not, however, always the case; for after the liquids have been mixed to a limited extent, the cohesion may balance the adhesion, and the liquids will then be mutually saturated. Thus ether and water cannot be mixed indefinitely, and if shaken up together, they will separate in a great measure on being allowed to stand, the water dissolving only about one eighth or one tenth of its bulk of ether, and the ether dissolving about the same amount of water. So also the volatile oils, if shaken up with water, separate from it almost entirely if the mixture is allowed to stand, although the water retains in solution a sufficient amount to acquire the flavor and odor of the essence.

* See a recent paper by Quincke, Pogg. Ann., CVIII. 326.

The tendency of liquids to mix with each other has been termed liquid diffusion, and can be made evident by a simple experiment. A tall glass jar is about two thirds filled with a solution of blue litmus, and then, by means of a tube funnel reaching to the bottom, oil of vitriol is cautiously poured in, so as to occupy the lower portion of the jar. The plane of separation of the two liquids will be at first distinctly marked. But this will soon disappear: the colored water will sink, and the acid will rise, until the two liquids have become perfectly incorporated. This will require, however, two or three days, and, if watched at intervals, the progress of the diffusion may be traced by the gradual change of color in the water from blue to red, commencing at the bottom and slowly progressing towards the top. A similar experiment can be made with alcohol, or with brine, and water; also with oil of turpentine and alcohol, and indeed with almost any two liquids which differ considerably in their specific gravities. By coloring one of the liquids, the process may be readily traced.

(201.) *Experiments of Professor Graham.*—The subject of liquid diffusion has been investigated with care in regard to saline solutions, and we are chiefly indebted to Professor Graham of London for our knowledge on the subject. His experiments were made with a very simple apparatus. "It consisted of a set of phials of nearly equal capacity, cast in the same mould, and further adjusted by grinding to a uniform size of aperture. The

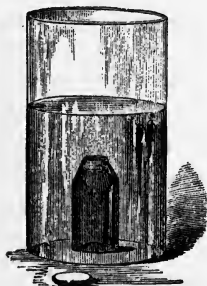

Fig. 329.

phials were 3.8 inches high, with a neck 0.5 inch in depth, and aperture 1.25 inch wide, capacity to base of neck equal to 2080 grains of water, or between 4 and 5 ounces. For each diffusion-phial a plain glass water-jar was also provided, 4 inches in diameter and 7 inches deep."* (Fig. 329.)

The diffusion-phial was in the first place filled with the saline solution to the base of the neck, or, more accurately, to a level exactly half an inch below the ground surface of the lip. The neck was then filled with distilled water, and a light float

* *Graham's Elements of Chemistry*, edited by Watts, Vol. II. p. 604.

placed upon the surface. Thus prepared, the phial was transferred to the jar, which was then filled with water to the height of an inch above the mouth of the phial, which was opened by the floating of the cover. This required about 20 ounces of water. The apparatus was then left undisturbed, and kept at a constant temperature for several days. At the end of the required time, the diffusion was interrupted by closing the mouth of the phial with a ground-glass plate, and the amount of salt diffused ascertained, by evaporating the water in the jar to dryness, and weighing the residue.

From these experiments, and a number of others made in a similar manner, the following important conclusions have been deduced.

1. With solutions of the same substance, but of different strengths, the quantity of salt diffused in equal times is proportioned to the quantity in solution. For example, four solutions of common salt were prepared, containing, respectively, 1, 2, 3, and 4 parts of salt to 100 of water. The experiments continued for eight days, and the quantities diffused were respectively 2.78 grains, 5.54 grains, 8.37 grains, and 11.11 grains. These numbers are almost exactly proportional to the first.

2. With solutions of different substances of the same strength, the quantity diffused varies with the chemical nature of the substance. This is shown by the following table, which gives the weight in grains of the substance diffused in eight days, from solutions containing, in each case, 20 parts of the solid dissolved in 100 parts of water, and exposed to a temperature of 60°.5 F.

Diffusion of Solids in Solution.

Substances used.	Sp. Gr. at 60° F.	Weight in Grains diffused.
Sulphate of Magnesia,	1.185	27.42
Chloride of Sodium,	1.126	58.68
Nitrate of Soda,	1.120	51.56
Oil of Vitriol,	1.108	69.32
Sugar-Candy,	1.070	26.74
Barley Sugar,	1.066	26.21
Starch Sugar,	1.061	26.94
Gum Arabic,	1.060	13.24
Albumen,	1.053	3.08

The substances have been arranged in the order of the specific gravities of the solution, and the table also shows that there is no apparent connection between the amount of diffusion and the specific gravity of the solution.

3. If, instead of comparing together, as in the last table, the amounts of different substances diffused in equal times, we compare together the times required for the equal diffusion of these same substances, we discover some remarkable numerical relations. There exist classes of equi-diffusive substances, and, as a general rule, those substances which have an analogous chemical composition, and crystallize in closely allied forms, have equal rates of diffusion. Several such groups have been distinguished, and the rate of diffusion in each group is connected with the rate of diffusion in the other groups by a simple numerical relation, as is shown in the following table. The first column gives the number of the group, with the name of the most characteristic substance belonging to it. The second gives the relative diffusion of these substances in equal times, in other words, the rate of diffusion. The third gives the times of equal diffusion; and the fourth, the squares of these times, which stand to each other very nearly in the simple relation expressed in the last column.

Groups.	Rate of Diffusion.	Times of Equal Diffusion.	Squares of Times.	Ratio.
1. Chlorohydric Acid,	1.000	3.960	15.682	2
2. Hydrate of Potash,	0.800	4.950	24.502	3
3. Nitrate of Potash,	0.565	7.000	49.000	6
4. Nitrate of Soda,	0.462	8.573	73.496	9
5. Sulphate of Potash,	0.400	9.900	98.010	12
6. Sulphate of Soda,	0.326	12.125	147.015	18
7. Sulphate of Magnesia,	0.200	19.800	392.040	48

4. The rate of diffusion increases with the temperature, but increases in an equal proportion for all substances, so that the ratio between the diffusion of different bodies is the same for all temperatures.

5. If two substances, which do not combine chemically and have different rates of diffusion, are placed in the diffusion-phial, they may be partially separated by the process of diffusion, since the more diffusible passes out the most rapidly, although the relative rate of diffusion may be somewhat changed.

Chemical decomposition may be even effected in this way, one ingredient of the compound diffusing more rapidly than the other.

From a solution of bisulphate of potash saturated at 20°C , there were diffused in fifty days 31.8 parts of bisulphate of potash, and 12.8 parts of hydrated sulphuric acid. From a solution of 8 parts of anhydrous alum in 100 parts of water there were diffused in eight days, at $17^{\circ}.9\text{C}$., 5.3 parts of alum and 2.2 parts of sulphate of potash; and other similar examples might be cited.*

6. The diffusion of a salt into the solution of another salt takes place with nearly the same velocity as into pure water, at least when the solutions are dilute. Here, as in all experiments on liquid diffusion, uniformity of action takes place only in dilute solution. As the solution becomes saturated, the cohesion of the particles of the solid appears to introduce irregularities.

7. "The velocity with which a soluble salt diffuses from a stronger into a weaker solution, is proportional to the difference of concentration between two contiguous strata." This law has been experimentally demonstrated by Frick in the case of chloride of sodium, but it cannot as yet be regarded as completely established.†

(202.) *Osmose*.—When two liquids are separated by a porous diaphragm, diffusion may still take place, although the phenomena are modified in a remarkable manner by the presence of the septum. This is best illustrated by means of the apparatus called an osmometer. It may be constructed in various ways, but as represented in Fig. 330 it consists of a membranous bag or bladder opening into a glass tube, to which it is fastened hermetically. The bladder is filled with a concentrated solution of common salt, and suspended in a jar filled with pure water. Since the animal membrane is readily penetrated by the water, it is evident that the water on the one side, and the salt solution on the other, must be in direct contact, and hence a diffusion of

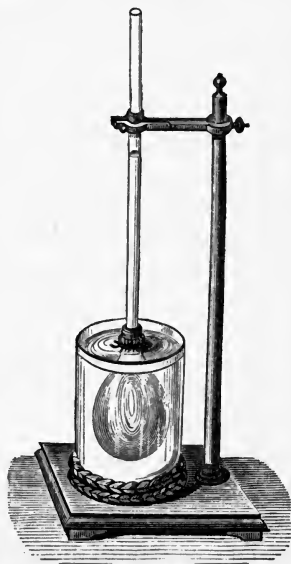

Fig. 330.

* Graham's Chemistry, Vol. II. p. 614.

† Ibid., p. 610.

the salt must take place, following the laws of liquid diffusion enunciated in the last section. We should, therefore, expect that the salt would pass out into the water of the jar, as we find to be the case; but the remarkable fact in connection with this experiment is, that a volume of water enters the bladder which is very much greater than could be introduced by simple liquid diffusion, amounting in some cases to several hundred times that of the salt displaced, the liquid slowly rising in the glass tube of the osmometer until it attains a very considerable height. The flow of water through the membrane is termed osmose, and the unknown power which produces it, osmotic force. It is a force of great intensity, capable of supporting a column of water several metres high. The first important phenomenon to be studied in this connection is this remarkable flow of water. The movement of the salt in the opposite direction appears to follow the laws of liquid diffusion, and, according to Graham's experiments, is not influenced by the presence of the membrane, unless it is quite thick.

We have supposed that the bladder in this experiment contained a solution of common salt; but we may use in its place alcohol, or solutions of cane sugar, of Glauber's salt, and of many other saline bodies, with precisely the same result. The conditions of osmose appear to be, that the liquids are capable of mixing, and that the membrane or septum which separates them has a greater adhesion for one liquid than for the other.

When the osmose takes place between water and solutions of salts, the quantity of salt which passes through the membrane into the water is always replaced by a definite quantity of water, and the ratio obtained by dividing the last quantity by the first has been termed the osmotic equivalent of the salt. This ratio varies with the nature of the salt, and also, to some extent certainly, with that of the membrane. It moreover increases with the temperature, but it appears to be independent of the density of the solution. The osmotic equivalent for Glauber's salts, for example, when the pericardium of the calf is used as the septum, was found by Hoffmann* to be 5.1.

The action of the septum in osmose has been explained in various ways. The simplest explanation which has been given

* Untersuchungen über das endosmotische Aequivalent des Glaubersalzes. Giessen, 1858.

is based on the unequal adhesion of the two liquids to the porous septum. Let us suppose that the septum is a piece of the bladder of an ox, and that on one side it is in contact with alcohol, and on the other with water. As was stated (194) the membrane has a very much greater attraction for water than for alcohol, and would therefore absorb the first to the entire exclusion of the second, were it not for the adhesion between the two liquids. In consequence of this, the alcohol is slowly diffused through the water contained in the membrane, which thus becomes saturated with greatly diluted alcohol. Hence, on the side of the membrane towards the alcohol, nearly pure water is in contact with strong alcohol, and a rapid diffusion of the first into the last necessarily results. The place of the water thus escaping is supplied by fresh water, and a current of water is thus established flowing in towards the alcohol. On the side of the membrane towards the water, we have, on the other hand, very dilute alcohol in contact with water, so that, although diffusion takes place, it is very much less rapid than that in the opposite direction. The flow of the water is then the result of two forces, — first, the excess of the attraction of the bladder for water over its attraction for alcohol, and, secondly, the diffusive force between the two liquids; while the flow of the alcohol is due to the diffusive force alone, and must therefore be less rapid.

This subject of osmotic action has also been carefully investigated by Professor Graham, who has established several important facts in relation to it.

The most remarkable conclusion is, that all substances may be divided into two classes, which he names crystalloids and colloids. The first class are capable of crystallizing, and as a general rule they form perfectly fluid solutions, which have a decided taste. The second class, on the other hand, are incapable of crystallizing, and give insipid viscid solutions, which readily form into jelly. Hence the name *colloid*, from *κόλλη*, glue. Moreover, while crystalloid bodies, like sugar or salt, diffuse with comparative rapidity, the colloids, such as gum, starch, caramel, gelatine, and albumen, are characterized by a remarkable sluggishness and indisposition to diffusion. This fact is made evident by the following table, and it will be noticed that sulphate of magnesia and cane-sugar, which are among the least diffusible of crystalline bodies, diffuse seven times as rapidly as albumen, and fourteen times as rapidly as caramel, both well-marked colloids.

Approximate Times of Equal Diffusion.

Hydrochloric Acid	1.
Chloride of Sodium	2.33
Cane-Sugar	7.
Sulphate of Magnesia	7.
Albumen	49.
Caramel	98.

Upon this marked difference of qualities, Graham has based a most valuable method of separating the two classes of bodies from each other, which he terms *dialysis*. A shallow tray is prepared by stretching parchment paper (which is itself an insoluble colloid) over one side of a gutta-percha hoop, and holding it in place by a somewhat larger hoop of the same material. The solution to be dialysed is poured into this tray, which is then floated on pure water in a shallow dish, the volume of the water being from six to ten times greater than that of the solution. Under these conditions, the crystalloid will diffuse through the porous septum into the water, leaving the colloid on the tray, and in the course of one or two days the separation will have taken place more or less completely.

The value of this process, both in chemistry and pharmacy, can be readily understood. In examining organic mixtures for poisons, it affords a ready means of separating the mineral acids and the vegetable alkalis (all crystalline bodies) from the vegetable colloids, with which they are mixed, and which would obscure their chemical reactions; and again it furnishes an equally efficient means of freeing silicic acid, caramel, albumen, and other colloid bodies, from saline impurities, which it is very difficult, if not impossible, to remove in any other way. It is not essential for the success of this process that the solution of the colloid should remain fluid, for even after the solution has set into a firm jelly the diffusion will continue apparently as rapidly as before.

The best-known colloid bodies, such as gum, starch, fruit-jelly, and glue, — the type of the class, — are substances of organic origin, and this condition of matters seems to be especially adapted in the plan of creation for forming the tissues of living beings; but there are also many inorganic colloids, and one at least which plays a very important part in the mineral kingdom. The soluble form of silicic acid is a true colloid. It can readily be obtained by pouring a solution of silicate of soda into diluted hydrochloric acid, the acid being maintained in great excess. When, now, the resulting liquid is placed on a dialyser, the excess of hydrochloric acid and the common salt formed by the chemical reaction, together with a small amount of silica, diffuse into the water below, leaving on the tray a solution containing the great mass of the silica in a pure condition.

In this way a solution can readily be obtained containing 10 or 12 per cent of silica. Such a solution gelatizes spontaneously in a few hours even at the ordinary temperature, and immediately when heated. The more dilute the solution the longer it can be kept without change, and a solution holding only one per cent of silica is practically unalterable by time. In a like manner Professor Graham has obtained alumina, sesquioxide of iron, sesquioxide of chromium, and stannic, meta-stannic, titanitic, tungstic, and molybdic acids, dissolved in water in a colloidal condition, and presenting properties similar to those of silicic acid in the same state. All these substances usually exist in the crystalline condition. The colloid condition is an abnormal state, and in all colloids there is usually a tendency to approach the crystalloid form. The water of crystallization in a crystalloid is represented in a colloid by what has been called water of gelatinization.

Liquids on Gases.

(203.) *Adhesion of Liquids to Gases.*

—The adhesion of liquids to gases is exemplified by the familiar fact, that, when liquids are poured from one vessel to another, bubbles of air are carried down with the descending stream, which rise and break upon the surface of the liquid. The adhesion of water to air is a force of considerable power, and is applied in some places for producing the constant blast which is required for working an iron forge. In Fig. 331 is represented the machine which is used for this purpose at some iron forges in Catalonia. Water is discharged from the reservoir *A*, into which it flows from a higher level,

into the tube *B*, through a conical orifice, *aa*. The openings *cc* admit air to the upper part of the tube *B*,

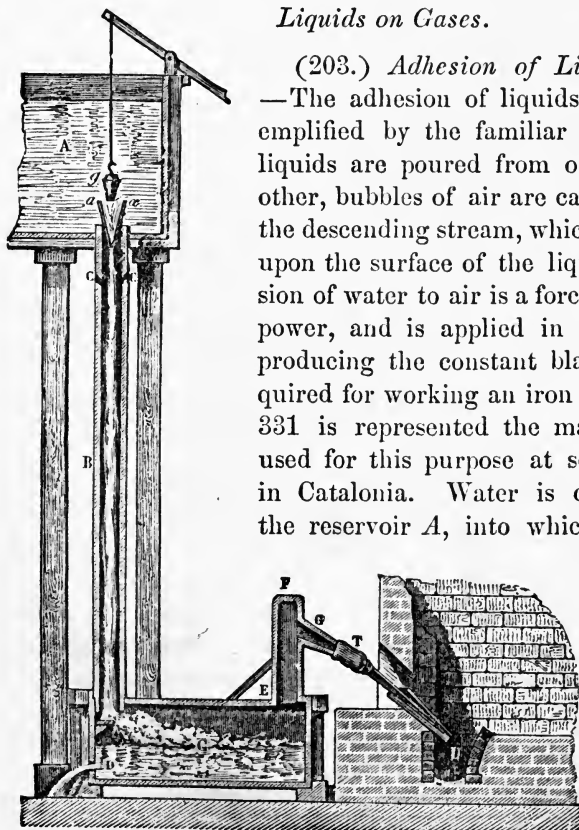

Fig. 331.

which is carried down by the stream of water into the reservoir *C*, and then forced through the tube *EFG* and the *tuyère TU* into the crucible of the forge. The stream of water is broken on a projecting ledge, and escapes by the opening *D*. By raising or lowering the stopper *g*, the quantity of water which falls, and hence also the intensity of the blast, can easily be regulated.

An aspirator for establishing a current of gas through various forms of chemical apparatus, founded on the principle of this blast machine, has been described by M. W. Johnson.* It consists merely of a tube ten or twelve inches in length, attached by means of an india-rubber connector to a water-cock. Near the top of this tube there is a lateral tubulature, which is connected by an india-rubber hose with the vessel through which the air is to be drawn. When the water-cock is partially opened, a very uniform and abundant current of gas is drawn in at the lateral opening, and its velocity can be regulated by varying the length of the tube.

(204.) *Solution of Gases.*—Another effect of adhesion, still more important in its chemical relations than the one just considered, is the absorption of gases by water and other liquids. Water has the power of dissolving all gases, although in very different proportions, varying from one thousand times its own volume, in the case of ammonia, to only about one fiftieth of its volume, in that of nitrogen.

The amount of gas dissolved by a liquid on which it exerts no chemical action depends upon, —

- 1st. The peculiar nature of the gas and the absorbing liquid.
- 2d. The pressure to which the gas is exposed.
- 3d. The temperature.

The *volume of a gas* (reduced to 0° and to 76 c. m. pressure) which is absorbed by one cubic centimetre of a liquid under the pressure of 76 c. m. is called the *coefficient of absorption*. This coefficient of absorption varies with the temperature, but for any given temperature it is a constant quantity for the same gas and liquid. The coefficients of absorption at 0° of a few of the best known gases are given in the following table, both for water and for alcohol : —

* Journal of the Chemical Society of London, Vol. IV. p. 186.

Name of Gas.	Volume in $\overline{\text{c. m.}}^3$ absorbed by one $\overline{\text{c. m.}}^3$ of	
	Water.	Alcohol.
Nitrogen,	0.02035	0.12634
Hydrogen,	0.01930	0.06925
Oxygen,	0.04114	0.28397
Carbonic Acid,	1.79670	4.32950
Sulphide of Hydrogen,	4.37060	17.89100
Sulphurous Acid,	68.86100	328.62000
Ammonia,	1049.60000	

(205.) *Variation of the Coefficient of Absorption with the Temperature.*—In a solid, the force which the solvent power of a liquid has to overcome is that of cohesion; in a gas, on the other hand, it is that of repulsion; and we should therefore naturally expect, contrary to what is true of solids, that the solubility of gases would diminish with the increase of the temperature. This we find to be the case, and, with a few exceptions, the solubility of a gas is greater the lower the temperature. As in the case of solids, however, the law of the variation depends upon the nature of the gas, and must therefore be determined for each special case. In Table VII. of the Appendix, the coefficients of solubility of the most familiar gases are given for different temperatures within the limits of ordinary observation. By comparing together the results of observation at different temperatures, we can obtain, as in the case of the solubility of solids, interpolation formulæ by means of which the coefficients may be calculated for other temperatures within certain restricted limits. Thus in the case of the absorption of nitrogen by water, the results of five experiments were as given in the following table from Bunsen's Gasometry.*

No. of the Experiment.	Temperature. Degrees Cent.	Coefficients found.	Coefficient from Formula.	Difference.
1	4.0	0.01843	0.01837	—0.00006
2	6.2	0.01751	0.01737	—0.00014
3	12.6	0.01520	0.01533	+0.00013
4	17.7	0.01436	0.01430	—0.00006
5	23.7	0.01392	0.01384	—0.00008

By combination of the experiments 1, 2, 3; 2, 3, 4; 3, 4, 5, we obtain the interpolation formula

* Gasometry, by Robert Bunsen. Translated by Roscoe. London. 1857.

$$e = 0.020346 - 0.00053887t + 0.000011156t^2, \quad [131.]$$

by means of which the numbers of Table VII. may be calculated. For the interpolation formulæ by which the coefficients of absorption of other gases may be calculated, as well in alcohol as in water, we must refer the student to the excellent work of Professor Bunsen already cited, from which Table VII. has been taken.

To the general law that the solubility of a gas diminishes with the increase of the temperature, there are several exceptions. Thus, the coefficient of absorption of oxygen in alcohol is constant at 0.28397 for temperatures between 0° and 24°, and the same is true also for hydrogen in water. So also one volume of water at 5° absorbs less chlorine gas than at 8°; but here, as in similar cases, the apparent exception to the law is caused by the intervention of chemical affinity. Chlorine forms at 0° a definite crystalline compound with water, and the solubility of this solid increases with the temperature up to 10°. Above this temperature the crystalline hydrate cannot exist, the chlorine dissolves as a gas, and its solubility follows the general law, diminishing with the temperature.

Although the solubility of a gas increases as the temperature falls, yet at the moment the liquid freezes, the absorbed gas is almost entirely set free. During the freezing of water the air dissolved separates from it, forming bubbles in the ice. So also the oxygen which is absorbed in large quantity by melted silver is evolved when it solidifies. But when at the freezing point the dissolved gas forms a definite compound with the water, it sometimes happens that no gas is evolved when the water freezes, as is the case with the solution of chlorine just mentioned.

(206.) *Variation of the Solubility of a Gas with the Pressure.* — This variation follows a very simple law. *The quantity of gas* absorbed by a liquid varies directly as the pressure which the gas exerts upon it.* If now, instead of considering the quantity of gas absorbed, we consider the volume absorbed under any given pressure, it follows, from Mariotte's law, that this volume must be the same in all cases. Thus, for example, at 0° one cubic centimetre of water absorbs 1.797 $\overline{\text{c. m.}}^3$ of carbonic

* By the term *quantity of a gas* is always to be understood the number of cubic centimetres measured at 0° C. and under a pressure measured by 76 c. m. of mercury.

acid gas, whatever may be its pressure. If the pressure is 76 c. m., the quantity of gas absorbed measures, at the standard temperature and pressure, exactly 1.797 c. m.^3 . If now the pressure is doubled, the volume of gas absorbed is the same as before, but *the quantity* (measured at 0°C. and 76 c. m.) will be found equal to twice 1.797 or 3.594 c. m.^3 , and the same is true for all pressures within the limits at which Mariotte's law holds good. (165.) It is true that the law has not been demonstrated experimentally except in a few cases and within very restricted limits, but it is highly probable that it is as constant as that of Mariotte. Representing by V_0 and V_0' the *quantities* of a given gas absorbed by a given volume of liquid corresponding to the pressures H_0 and H_0' , we have for the mathematical expression of this fundamental law of gasometry the proportion

$$V_0 : V_0' = H_0 : H_0'. \quad [132.]$$

The principles of this section are illustrated by the apparatus represented in Figs. 332 and 333, used for saturating water with carbonic acid gas under pressure (soda-water). It is made of earthenware;

and the two chambers *A* and *B*, as shown in the section, are connected together by the fine tube *a b*. Through the neck of the apparatus at *u*, water is introduced into the upper chamber, *B*, which is then closed by a screw plug. Through this plug passes a tube, *p i*, closed by a valve



Fig. 332.

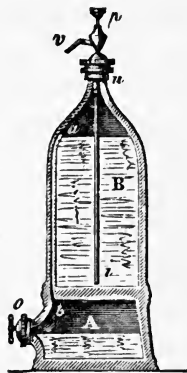

Fig. 333.

stopcock, by means of which the water may be drawn off when saturated with gas. Through a tubulature at *o*, which can also be closed by a screw plug, the materials for making carbonic acid gas (bicarbonate of soda, tartaric acid, and water) are introduced into the lower chamber, *A*. The gas, as it is evolved, escapes through the tube *b a* into the upper part of the chamber *B*, where it comes in contact with the surface of the water, and is in part dissolved, while the rest exerts a pressure upon it

amounting to several atmospheres. On opening the stopcock, the water charged with gas is driven out with force, and the amount of gas dissolved is found to be exactly proportional to the pressure which it exerted on the surface of the water.

When the water thus surcharged with gas is drawn out into a glass tumbler, the excess of gas escapes with effervescence. If the process is closely examined, it will be noticed that the bubbles of gas rise from the sides and bottom of the tumbler, and if, while the water is still saturated, we drop into it a solid body with a rough surface, a piece of bread, for example, there will ensue a brisk effervescence around the body. The cause of this phenomenon is thus explained. The gas, as we have assumed, is held in solution by the adhesion of the liquid particles. In the midst of the water the particles of carbonic acid are surrounded on all sides by particles of liquid, but immediately in contact with the solid they are only attracted on one side by the liquid, since on the other they are in contact with the solid surface. It is evident that the adhesive force, and hence also the solvent power, must be less in the last case than in the first, so that the particles of gas in contact with the solid surfaces will be the first to assume the aeriform condition. These particles uniting together form a small bubble of gas, which, as it rises through the solution, constantly enlarges, and acquires a considerable size before it breaks on the surface. The bubble increases in size as it ascends, because, as is evident, it must have the same effect as a solid body on all the particles of the solution with which it comes in contact, diminishing the adhesive force between the water and gas.

If water saturated with carbonic acid is placed under a glass bell resting on the plate of an air-pump, the carbonic acid will escape from the solution, and collect in the bell, until the quantity remaining in solution corresponds to the pressure exerted by the carbonic acid which has escaped. The presence of air in the bell does not in any way affect the final result, and precisely the same quantity of carbonic acid, and no more, would rise into the bell if the air were completely removed. It is true, however, that, if the bell were exhausted, this quantity would escape instantaneously, while, if it is filled with air, the equilibrium is only attained after a considerable time. The same is true if the bell is filled with other gases than air. Let us now suppose that, after the equilibrium has been attained, a portion of the mixture

of carbonic acid and air is removed by the pump. The pressure which the carbonic acid exerts on the solution will thus be diminished, and more gas will escape from the solution, until the equilibrium between the gas dissolved and the pressure of gas in the bell is again restored. It is evident that the whole gas cannot be removed from a solution by the air-pump, since we can never remove the whole of the gas from the surface of the liquid, and cannot therefore entirely remove the pressure which the gas escaping from the solution exerts. This object, however, can be readily attained by placing at the side of the glass holding the solution another glass, containing some chemical reagent which has the power of absorbing the gas. Thus, if we place under the same bell containing a solution of carbonic acid a concentrated solution of caustic potash, this reagent will keep the bell free from carbonic acid, and reduce the pressure it exerts to nothing, so that the gas will continue to escape from the solution until the whole is removed. If at the same time we exhaust the air with the pump, we shall greatly hasten the process, although the final result is not affected by the presence of the air, or any other chemically inactive gas.

The amount of carbonic acid present in the atmosphere is so small, that it exerts no appreciable pressure; so that, if a solution of this gas is exposed to the atmosphere, the whole of the gas should according to the law escape. This we find to be the case, although, on account of the slow diffusion of carbonic acid into air, it requires a long time before the whole has disappeared. The same must, of course, also be true of solutions of all gases with the exception of those composing the atmosphere.

The most available means of driving out a gas from a solution is boiling. The high temperature diminishes the coefficient of absorption, and moreover the escaping vapor carries away with it the gas from the surface of the liquid, so that the pressure which the gas exerts on this surface is constantly diminishing, and with it also the amount of the gas which the liquid can hold in solution. On this same principle, protoxide of nitrogen can be entirely removed from water by passing through it a current of air.

There are a few gases, such as chlorohydric acid, which have so strong an affinity for water that they cannot be removed by boiling, since, after the solution is reduced to a certain degree

of concentration, the liquid and gas evaporate together as a whole.

(207.) As a general rule, the solubility of a gas is *diminished* by the presence of other substances in the solution. Thus, for example, water containing sulphuric acid or any salt will absorb, in most cases, less gas than when pure. As a necessary consequence, the gas which water holds in solution can in great measure be driven out by the addition of oil of vitriol, or by dissolving in it some salt. So also melted silver, which absorbs from the atmosphere a large volume of oxygen, disengages with effervescence the whole of the dissolved gas, on the addition of an equal weight of melted gold.

Whenever, on the other hand, as is sometimes the case, the solubility of a gas is *increased* by the presence of salts or other substances in solution, this exception to the general rule is apparently caused by the chemical affinity of the dissolved substance. The presence of phosphate of soda increases greatly the solubility of carbonic acid, and the presence of sulphate of copper and sulphate of protoxide of iron, the solubility of oxide of carbon and deutoxide of nitrogen, respectively. It is true that in all these cases the gas can be driven out of the solution by boiling, but nevertheless it is probable that unstable compounds are in each case formed; and this opinion is substantiated in the last case by the very remarkable change of color which the solution of green vitriol undergoes by absorbing deutoxide of nitrogen gas.

The principles of this section, it should be noticed, apply only to solid and liquid bodies, since the coefficient of absorption of one gas is not apparently influenced by the presence in the solution of another gas on which it is chemically inactive. This last principle will be considered in detail in section (209).

(208.) *Determination of the Coefficient of Absorption.*—As has been already stated, the coefficient of absorption is the volume of gas (measured in cubic centimetres at 0° and 76 c. m.) absorbed by one cubic centimetre of liquid. Since this coefficient varies with the temperature, it must be determined for each temperature, or we may determine it with accuracy for several temperatures at suitable intervals, and then from these results deduce an interpolation formula by which we may calculate the coefficient for all intermediate temperatures, and prepare tables like Table VII. of the Appendix. It is only then necessary to inquire how the

coefficient is determined for any given temperature, t . There are, in general, two methods which are used for this purpose.

First Method. — The first method consists in passing a current of the gas through the liquid under experiment, until the last is

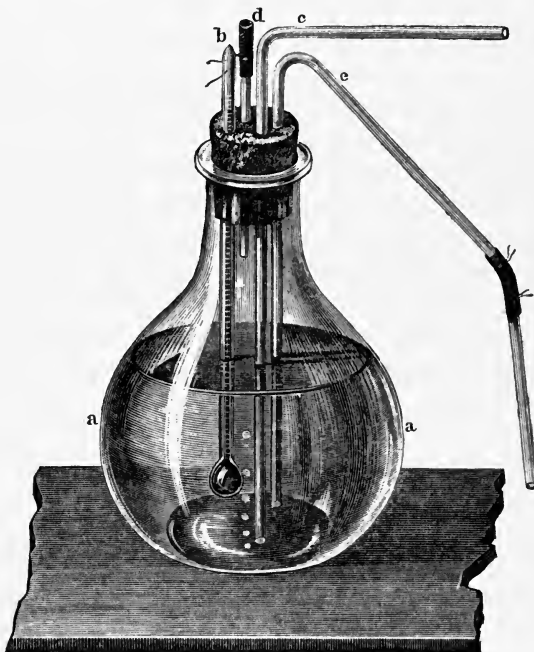

Fig. 334.

saturated; then, having carefully observed the temperature of the solution, transferring with proper precautions a measured volume to a glass beaker, and determining the weight of the dissolved gas by some process of chemical analysis. This method will be better understood if illustrated by an example, and we will select for the purpose the determination of the coefficient of absorption of sulphide of hydrogen in alcohol, which was made by Drs. Schönfeld and Carius, with the apparatus represented in Fig. 334.*

The flask *aa* is closed by a tight cork, through which four holes have been bored. Through the first of these passes a ther-

* See Bunsen's Gasometry, page 160.

mometer, *b*; through the second, the tube, *c*, conducting the gas; through the third, a short tube, *d*, serving as a vent to the gas, and ending in a small india-rubber tube, which can be easily closed by a glass rod; lastly, through the fourth hole passes a siphon tube, *e*. These tubes exactly fit the holes in the cork, so that if the tube *d* is closed while the current of gas is flowing into the flask through the tube *c*, the solution will be forced out through this siphon tube, *e*.

In making the determination, the sulphide of hydrogen was generated from sulphide of iron and dilute sulphuric acid, and, having been washed with water, was passed through alcohol in the flask, which had been previously boiled in order to expel all the air it contained in solution. The alcohol in the mean time was kept at a constant temperature by placing the flask in a water-bath, and this temperature, which was carefully observed by the thermometer *b*, we will call t° . The tube *d* was also left open, so that the sulphide of hydrogen gas, which filled the upper part of the flask, exerted the same pressure on the surface of the alcohol as that indicated by the barometer at the time of the experiment. We will represent this by *H*. At the end of two hours, when it was assumed that the liquid was saturated with the gas, the india-rubber connector at *d* was closed by a glass rod, and the solution, as it was forced out through the siphon *e*, collected in a measuring-glass. The tube *e* was so adjusted as to reach to the bottom of the measuring-glass, and after the glass was full, the solution was permitted to overflow the mouth for some time, and until the upper layers of the liquid, which had been exposed to the air, and consequently lost a portion of their gas, had been replaced by the saturated solution rising from below. The glass was then quickly closed by its stopper, and its contents immediately after transferred to a beaker containing a solution of chloride of copper. The volume of the solution used was, of course, the same as that of the measuring-glass, and we will represent it by *V*. Lastly, the sulphur of the precipitated sulphide of copper was converted into sulphuric acid by nitric acid, and weighed in the usual way as sulphate of baryta. From the weight of sulphate of baryta the weight of sulphide of hydrogen contained in the solution was easily calculated. Represent this weight by *W*, and the known weight of one cubic centimetre of sulphide of hydrogen gas at 0° and 76 c. m. by *w* (Table II.),

and we have all the data for calculating the coefficient of absorption at the temperature of the experiment.

V = volume of solution saturated with H S at t° and H c. m.

W = weight of H S in ditto, at t° and H c. m.

Then by [132],

$$W \frac{76}{H} = \text{weight of H S in ditto at } t^\circ \text{ and } 76 \text{ c. m.}$$

Dividing by w , we get

$$\frac{W}{w} \cdot \frac{76}{H} = \text{volume of H S (measured at } 0^\circ \text{ and } 76 \text{ c. m.) dissolved at } t^\circ \text{ and } 76 \text{ c. m.}$$

It was assumed in this determination that the volume of alcohol underwent no change by absorbing sulphide of hydrogen, so that V represents not only the volume of the solution, but also the volume of the alcohol it contained. Hence, V cubic centimetres of alcohol at t° dissolve $\frac{W}{w} \cdot \frac{76}{H}$ cubic centimetres of sulphide of hydrogen, measured at 0° and 76 c. m. Consequently, the coefficient of absorption, or

$$c = \frac{1}{V} \cdot \frac{W}{w} \cdot \frac{76}{H}. \quad [133.]$$

As is evident, this formula is not only applicable to the particular case under consideration, but may also be used in all similar cases, in which the volume of the liquid is not sensibly altered by dissolving a gas.

If, however, we seek to determine the solubility of sulphurous acid gas in alcohol by the same method, it will be found that the assumption made in the last example is no longer correct, and that it is essential to pay regard to the change of volume. As for the rest, the determination may be conducted in precisely the same manner, only the weight, W , of sulphurous acid gas contained in a measured volume, V , of the solution, must be determined by some special method of chemical analysis. As we cannot conveniently measure the volume of alcohol before the absorption corresponding to the measured volume, V , of the solution, we determine carefully the specific gravity of the alcohol and of the solution, and thus obtain all the data for our calculation.

- V = volume of alcohol saturated with $S O_2$ at t° and H c. m.
 $(Sp. Gr.)$ = specific gravity of ditto.
 $V \cdot (Sp. Gr.)$ = weight of ditto. See [56].
 W = weight of $S O_2$ dissolved at t° and H c. m. in $V \overline{c. m.}^3$ of solution.
 $V \cdot (Sp. Gr.) - W$ = weight of alcohol in $V \overline{c. m.}^3$ of solution.
 $(Sp. Gr.)'$ = specific gravity of alcohol before absorption.

Hence by [56],

$$\frac{V \cdot (Sp. Gr.) - W}{(Sp. Gr.)'} = \text{volume of alcohol in } V \overline{c. m.}^3 \text{ of saturated solution.}$$

w = weight of one cubic centimetre of $S O_2$ gas measured at 0° and 76 c. m.

$\frac{W}{w}$ = volume of $S O_2$ (measured at 0° and 76 c. m.) dissolved in $V \overline{c. m.}^3$ of solution at t° and H c. m.

$\frac{W}{w} \cdot \frac{76}{H}$ = volume of ditto dissolved in $V \overline{c. m.}^3$ of solution at t° and 76 c. m.

Hence $\frac{V \cdot (Sp. Gr.) - W}{(Sp. Gr.)'}$ c. m.³ of alcohol dissolve, at t° and 76 c. m., $\frac{W}{w} \cdot \frac{76}{H}$ c. m.³ of $S O_2$ gas.

Whence

$$c = \frac{W}{w} \cdot \frac{76}{H} \cdot \frac{(Sp. Gr.)'}{V \cdot (Sp. Gr.) - W}. \quad [134.]$$

This formula may be used in all similar determinations of the coefficient of absorption, where the volume of the liquid is sensibly changed by the absorption of the gas. When there is no change of volume, $V = \frac{V \cdot (Sp. Gr.) - W}{(Sp. Gr.)'}$, which, substituted in [134], reduces it to [133].

The method of determining the coefficient of absorption just described is the best whenever the gas dissolves in large quantities in the liquid, and when it is of such a nature that the amount in solution can be readily determined by the methods of chemical analysis. In the practical application of this method, peculiar precautions are required in each special case. For a description of these, we must refer the student to the work of Professor Bunsen, already noticed.

Second Method. — The second method of determining the coefficient of absorption consists in shaking up in a graduated glass tube a measured volume of gas with a measured volume of

liquid, and carefully observing the volume of gas absorbed. A very elegant apparatus for this purpose, called an absorption-metre, is described and figured by Bunsen in his work on Gasometry, and a diagram illustrating its principle is given here in Fig. 335. The gas is collected in the graduated glass tube *aa* over a mercury pneumatic trough, and its volume carefully determined. We will call this volume corrected for temperature, V_0 . At the same time, we observe the height of the barometer, and the height of the surface of the mercury in the tube above the surface of the mercury in the pneumatic trough. The difference of these heights gives us a quantity, H , which is the pressure to which the gas confined in the tube is exposed (169). Next, a volume of liquid from which all the air has been expelled by boiling is passed up into the tube, still standing over the mercury trough. This volume is also carefully observed, and we will represent it by V . The tube is now closed by screwing on to the iron ring *cc* (which is cemented to the tube a short distance from its mouth) the iron cap *bbdd*. The surface *dd* is covered with a piece of sheet india-rubber, which is pressed by the screw against the mouth of the tube, and hermetically closes it. The tube (filled with mercury, gas, and the liquid) is now transferred to the glass cylinder *gg*. This cylinder is cemented to a base *h*, and a rectangular projection *f*, at the bottom of the iron cap, exactly fits a corresponding hole in the upper surface of the base. The cylinder may be closed by an iron lid, which turns on a hinge *i*, and which may be fastened by the thumb-screw *n*. To the under surface of the cover a piece of india-rubber, *m*, is cemented, which, when the cover is closed, presses against the top of the glass tube and keeps it in place. The graduated tube having been introduced and adjusted, mercury is poured into the cylinder until it covers the bottom to the depth of several centimetres, and the rest of the cylinder is then filled with water. The cover is now closed and fastened, and the whole apparatus violently shaken in order to facilitate the solution of

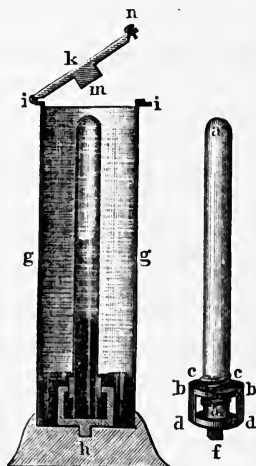

Fig. 335.

the gas. The lid is next opened, and by turning the tube the cap is unscrewed, and the mouth of the tube opened under the mercury, which rises to take the place of the gas which has been absorbed. By turning the tube in the reverse direction the mouth is now closed, and, the cover having been shut down and fastened, the apparatus is again shaken; and this process is repeated until no further absorption of gas is perceptible. When the absorption is completed, the volume of gas remaining in the tube is carefully observed. This volume corrected for temperature we will call V'_0 . The pressure H' , to which the gas is exposed, can now be calculated from the height of the barometer, the difference of level of the mercury in the tube and in the cylinder, and, lastly, the heights of the columns of water in the two vessels. These quantities having been carefully observed, we commence the calculation by finding from Table XIX. the equivalents of the two water columns in centimetres of mercury. Representing these values by h' and h'' , the difference of level of the mercury by h , and the height of the barometer by H , we have for the value of the pressure $H' = H - h + (h' - h'')$. A thermometer placed within the cylinder gives the temperature of the water, and hence the temperature at which the coefficient is determined. We have now determined all the data required for calculating the coefficient.

V_0 = volume of gas before absorption, at 0^0 and pressure H c. m.

$V_0 \frac{H}{76}$ = " " " " " " 76 c. m.

V'_0 = " " after " " " " H' c. m.

$V'_0 \frac{H'}{76}$ = " " " " " " 76 c. m.

$V_0 \frac{H}{76} - V'_0 \frac{H'}{76}$ = reduced volume of gas absorbed under the pressure H' .

By [132],

$\frac{V_0 H}{H'} - V'_0$ = reduced volume of gas absorbed under the pressure 76 c. m. by $V \frac{c}{c. m.}^3$ of liquid.

$$c = \frac{1}{V} \left(\frac{V_0 H}{H'} - V'_0 \right). \quad [135.]$$

In making determinations of the coefficient of absorption by this method, it is necessary to correct the measured tensions of

gas both for temperature and for the tension of vapor, and to reduce the measured columns of mercury to 0° C. The method by which these reductions are made will be explained in the next chapter, and examples illustrating the whole subject will be found in Bunsen's work on Gasometry, already noticed, to which we must refer for further details.

(209.) *Partial Pressure.*— If we conceive of three masses of different gases, occupying the volumes v_1, v_2, v_3 , and each exerting a pressure measured by H , and then suppose that the diaphragms which separate them are removed, the three gases will mix perfectly together, as is well known, until each is equally diffused through the whole space V , which equals $v_1 + v_2 + v_3$, and the mixture will then exert the same pressure as that exerted by each gas separately, or H . It is evident, then, from Mariotte's law (163), that each gas of this mixture must exert, by itself, a pressure which bears the same relation to the whole pressure that the original volume of this gas bears to its expanded volumes. It is easy, then, to calculate that the pressures exerted by the three gases of the mixture are respectively

$$\frac{v_1}{v_1 + v_2 + v_3} H, \quad \frac{v_2}{v_1 + v_2 + v_3} H, \quad \text{and} \quad \frac{v_3}{v_1 + v_2 + v_3} H. \quad [136.]$$

These pressures are called *partial pressures*, in distinction from the *total pressure*, which is equal to the sum of these partial pressures, or

$$H = \frac{v_1}{v_1 + v_2 + v_3} H + \frac{v_2}{v_1 + v_2 + v_3} H + \frac{v_3}{v_1 + v_2 + v_3} H. \quad [137.]$$

If now a volume of liquid, which we will represent by V_1 , is exposed to this gaseous mixture, it will absorb of each gas a quantity which is exactly proportional to the partial pressure which this gas exerts. In other words, the law of (206) holds true in regard to each gas, and the solubility of one gas is not influenced by the presence of the rest.

Representing then by c_1, c_2 , and c_3 the coefficients of absorption of the three gases respectively, and assuming that the total volume of the mixture is so large, or so frequently renewed, that the partial pressures are not altered by the absorption, we can easily calculate that the absolute volume of each gas in cubic centimetres absorbed by the given volume, V_1 , of the liquid, will be, respectively,

and

$$c_1 V_1 \frac{v_1}{v_1 + v_2 + v_3} \cdot \frac{H}{76}, \quad c_2 V_1 \frac{v_2}{v_1 + v_2 + v_3} \cdot \frac{H}{76},$$

$$c_3 V_1 \frac{v_3}{v_1 + v_2 + v_3} \cdot \frac{H}{76}. \quad [138.]$$

The sum of these quantities, or the total volume of mixed gases absorbed, is

$$V_1 \frac{1}{v_1 + v_2 + v_3} \cdot \frac{H}{76} (c_1 v_1 + c_2 v_2 + c_3 v_3). \quad [139.]$$

Dividing each of the quantities [138] by this sum, we shall obtain the composition of the absorbed gas, or, in other words, the amount of each gas composing one volume of the mixed gases dissolved. These are

$$u_1 = \frac{c_1 v_1}{c_1 v_1 + c_2 v_2 + c_3 v_3}, \quad u_2 = \frac{c_2 v_2}{c_1 v_1 + c_2 v_2 + c_3 v_3},$$

$$u_3 = \frac{c_3 v_3}{c_1 v_1 + c_2 v_2 + c_3 v_3}. \quad [140.]$$

If there were but two gases, the values v_3 , u_3 , and c_3 must evidently be cancelled in all the above equations; and, on the other hand, the formulæ may readily be extended to any number of gases by introducing additional terms.

The solution of atmospheric air in water furnishes a good illustration of the principles of this section. Let it be required to determine the absolute volumes of oxygen and nitrogen absorbed by V_1 volume of water at the temperature of 15° . The air is a mixture of oxygen and nitrogen, exerting on the water a variable pressure, which we will assume, at the time of the determination, is 76 c. m.; and its mean composition in volume is

Oxygen,	0.2096	
Nitrogen,	0.7904	[141.]
		1.0000	

The coefficients of absorption at 15° are, by Table VII., of oxygen 0.02989, and of nitrogen 0.01478. The absolute volumes of the two gases absorbed by V_1 volume of water are, then, of oxygen,

$$0.02989 V_1 \times 0.2096 = 0.006265 V_1;$$

and of nitrogen,

$$0.01478 V_1 \times 0.7904 = 0.011682 V_1.$$

The composition of the dissolved gas in one volume is, then, by [140],

Oxygen,	0.3491	
Nitrogen,	0.6509	[142.]
	1.0000	

We can also, evidently, reverse the above calculation, and from the composition of the dissolved gas calculate the composition of the gaseous mixture to which the liquid has been exposed. Representing the denominators of the fractions [140] by A , we easily obtain the values,

$$v_1 = \frac{u_1}{c_1} A, \quad v_2 = \frac{u_2}{c_2} A, \quad \text{and} \quad v_3 = \frac{u_3}{c_3} A, \quad [143.]$$

which are the volumes of the respective gases composing $V \overline{\text{c.m.}}^3$ of the mixture. Dividing each of these quantities by the sum of the whole, we obtain the composition of one volume of the mixture.*

$$w_1 = \frac{\frac{u_1}{c_1}}{\frac{u_1}{c_1} + \frac{u_2}{c_2} + \frac{u_3}{c_3}}, \quad w_2 = \frac{\frac{u_2}{c_2}}{\frac{u_1}{c_1} + \frac{u_2}{c_2} + \frac{u_3}{c_3}},$$

and

$$w_3 = \frac{\frac{u_3}{c_3}}{\frac{u_1}{c_1} + \frac{u_2}{c_2} + \frac{u_3}{c_3}}. \quad [144.]$$

From the composition of the mixture of oxygen and nitrogen dissolved in rain-water, we can easily calculate, by these formulæ, the composition of the air. Evidently, when there are only two gases, the third value, w_3 , and the last term of the denominators of w_1 and w_2 are cancelled.

All the above formulæ are based upon the supposition, that the volume of the gaseous mixture is so large that the partial pressures of its constituent gases are not essentially changed by the absorption. This is true in regard to the atmosphere, as already stated; but when we experiment upon a very limited volume of a gaseous mixture, as in the absorption-tube of apparatus (Fig. 335), such an assumption is far from being correct, and we must then pay regard to the change of composition and of pressure in the gaseous mixture. In order to make the case as simple as possible, let us take a mixture of only two gases, and consider the changes it will undergo by absorption if in contact

* It will afford the student assistance, in following out the course of reasoning in this section, to remember that, in the notation adopted, $v_1 + v_2 + v_3 = V \overline{\text{c.m.}}^3$ of the mixed gases before solution, $u_1 + u_2 + u_3 = 1 \overline{\text{c.m.}}^3$ of the mixed gases in solution, and $w_1 + w_2 + w_3 = 1 \overline{\text{c.m.}}^3$ of the mixed gases before solution.

with a volume of liquid, adopting for the purpose the following notation, and assuming that the volumes of all the gases entering into the calculation are measured at 0° .

V = volume of mixed gases before absorption, measured at pressure H .

V' = volume of mixed gases after absorption, measured at pressure H' .

V_1 = volume of absorbing liquid.

v_1, v_2 = volumes respectively of the two gases in the unit volume of the mixed gases before absorption, so that $v_1 + v_2 = 1 \text{ c.m.}^3$.

u_1, u_2 = volumes respectively of the two gases in the unit volume of the mixed gases remaining unabsorbed, so that $u_1 + u_2 = 1 \text{ c.m.}^3$.

c_1, c_2 = coefficients of absorption of the two gases respectively.

It is now evident that the volume V of the mixed gases contains $v_1 V \text{ c.m.}^3$ of the first gas measured under the pressure H . Under a pressure of 76 c. m. this same volume would measure, by [98], $v_1 V \frac{H}{76} \text{ c.m.}^3$. By the absorption, this *quantity* of gas is divided into two parts: first, a *quantity*, x_1 , which remains undissolved; second, a quantity, x_2 , which dissolves in the liquid; so that we have $x_1 + x_2 = v_1 V \frac{H}{76}$. The value of x_2 may now readily be determined by the laws of absorption, since we know the coefficient of absorption c_1 , and can easily calculate the partial pressure which the gas exerts on the liquid after the absorption. The *quantity* x_1 of gas, if measured at the pressure H' , would equal $x_1 \frac{76}{H'}$; and since the whole volume of mixed gases remaining unabsorbed, or V' , exerts a pressure H' , the partial pressure of the portion of this volume $x_1 \frac{76}{H'}$ must be $\frac{x_1}{V'} 76$. At the pressure of 76 c. m., we know that $V_1 \text{ c.m.}^3$ of liquid absorbs $c_1 V_1 \text{ c.m.}^3$ of the gas. Hence, under the pressure of $\frac{x_1}{V'} 76$ c. m., the same volume of liquid will absorb $\frac{c_1 V_1 x_1}{V'} \text{ c.m.}^3$ of gas. This is the value of x_2 ; and substituting it above, we obtain

$$x_1 + \frac{c_1 V_1 x_1}{V'} = v_1 V \frac{H}{76}, \quad \text{or} \quad x_1 = \frac{v_1 V H}{76 \left(1 + \frac{c_1 V_1}{V'}\right)}. \quad [145.]$$

By a similar course of reasoning, we should obtain, for the volume of the second gas remaining unabsorbed, the value

$$y_1 = \frac{v_2 V H}{76 \left(1 + \frac{c_2 V_1}{V'}\right)}.$$

If, for the sake of abbreviation, we put $A_1 = v_1 V H$ and $A_2 = v_2 V H$, also $B_1 = \left(1 + \frac{c_1 V_1}{V'}\right)$ and $B_2 = \left(1 + \frac{c_2 V_1}{V'}\right)$, we shall have $x_1 = \frac{A_1}{76 B_1}$ and $y_1 = \frac{A_2}{76 B_2}$ and from these we can easily calculate the composition of the unit of volume of the unabsorbed gas, which we shall find to be

$$u_1 = \frac{x_1}{x_1 + y_1} = \frac{A_1 B_2}{A_1 B_2 + A_2 B_1},$$

and

$$u_2 = \frac{y_1}{x_1 + y_1} = \frac{A_2 B_1}{A_2 B_1 + A_1 B_2}.$$

[146.]

(210.) *Analysis of a Mixture of two Gases by the Absorption Meter.* — It is evident, from the computations of the last section, that we can even determine the unknown composition of a gaseous mixture from the change of volume it undergoes by absorption in a known volume of liquid. This leads us to a method of gas analysis, which, under certain circumstances, admits of great accuracy, and enables us to solve problems which cannot be resolved by the ordinary methods of chemical investigation. Let us suppose, then, that we have given the following data, all reduced to 0° C. , as before.

V = the original volume of the gaseous mixture, measured under the pressure H .

V' = the volume of the mixture after absorption, measured under the pressure H' .

V_1 = the volume of absorbing liquid.

c_1, c_2 = the coefficients of absorption of the two gases composing the mixture.

It is required, from these data, to determine the relative proportions of the two gases in the original mixture. Let us represent, then, by the unknown quantities x and y the volumes of the two constituent gases measured under the pressure 1; by x' and y' , the volumes of these gases after absorption measured under the same pressure.

It follows directly from the law of Mariotte, that the volume x' , if measured under the pressure H' , would be $\frac{x'}{H'}$; and since

this volume, after the absorption, is expanded through the whole volume V' , it is evident that the partial pressure it then exerts on the absorbing liquid is as much less than H' as $\frac{x'}{H'}$ is less than V' , and must therefore be equal to $\frac{x'}{V'}$. The volume of the first gas which would be absorbed by V_1 c.m.³ of liquid under the pressure of 76 c.m. and at 0° (when measured at 0° and 76 c.m.) is $c_1 V_1$. As after the absorption the pressure exerted by the first gas on the liquid is $\frac{x'}{V'}$, the volume which is actually absorbed (measured at 0° and 76 c.m.) is, by [132], $\frac{c_1 V_1 x'}{76 V'}$. If this volume is measured under the pressure 1 c.m., it will become $c_1 V_1 \frac{x'}{V'}$. Hence we have

$c_1 V_1 \frac{x'}{V'} =$ the volume of first gas absorbed measured under the pressure 1.

Hence, also,

$$x = x' + c_1 V_1 \frac{x'}{V'} = x' \left(1 + \frac{c_1 V_1}{V'} \right), \text{ or } x' = \frac{x}{\left(1 + \frac{c_1 V_1}{V'} \right)}. \quad [147.]$$

From this value of x' we can easily calculate the partial pressure which the unabsorbed portion of the first gas exerts on the absorbing liquid. If measured under the pressure H' , the volume [147] becomes

$$\frac{x}{H' \left(1 + \frac{c_1 V_1}{V'} \right)};$$

and the partial pressure it exerts is as much less than H' as this volume is less than V' . A simple proportion gives us, for the value of this pressure, $\frac{x}{V' + c_1 V_1}$. In like manner, by a precisely similar course of reasoning, we shall obtain, for the partial pressure exerted by the unabsorbed portion of the second gas, $\frac{y}{V' + c_2 V_1}$. Now, since it is these two pressures which make up the observed total pressure H' , we have

$$H' = \frac{x}{V' + c_1 V_1} + \frac{y}{V' + c_2 V_1}. \quad [148.]$$

Returning now to the condition of the gas before absorption, it is evident that the volume of the first gas, which measures x

under the pressure 1, would measure $\frac{x}{H}$ under the pressure H . Hence the partial pressure which this gas exerted before the absorption was as much less than H as the volume $\frac{x}{H}$ is less than V , and must therefore have been $\frac{x}{V}$. In like manner, we find that the partial pressure exerted by the second gas was $\frac{y}{V}$; so that we also have

$$H = \frac{x}{V} + \frac{y}{V}. \quad [149.]$$

It will be noticed that equation [149] may be derived directly from [148], by making c_1 and c_2 equal to zero, which would be the case where there was no absorption. These equations may also be written in the forms

$$1 = \frac{x}{(V' + c_1 V_1) H'} + \frac{y}{(V' + c_2 V_1) H'},$$

$$1 = \frac{x}{VH} + \frac{y}{VH}.$$

If for the sake of abbreviation we put

$$W = VH,$$

$$A = (V' + c_1 V_1) H',$$

$$B = (V' + c_2 V_1) H',$$

the equations become

$$1 = \frac{x}{A} + \frac{y}{B}, \quad \text{and} \quad 1 = \frac{x}{W} + \frac{y}{W}.$$

By combining the two, we easily obtain

$$\frac{x}{y} = \frac{W - B}{A - W} \cdot \frac{A}{B}; \quad [150.]$$

or, calculating the percentage composition,

$$\frac{x}{x + y} = \frac{W - B}{A - B} \cdot \frac{A}{W}, \quad \text{and} \quad \frac{y}{x + y} = \frac{A - W}{A - B} \cdot \frac{B}{W}. \quad [151.]$$

As an example of this method of analysis, we will take the data obtained in an experiment with the absorption-meter on a mixture of carbonic acid gas and hydrogen, as given by Bunsen.

	Volume.	Pressure. c. m.	Temp.	Volume at 0°.
Gas before absorption,	180.94	53.68	15.4	171.29
Gas after absorption,	122.01	68.09	5.5	119.61
Volume of water,	356.7	
“ “	356.1	
Mean,	<u>356.4</u>	

Hence we obtain

$H =$	53.6800,	$V =$	171.290,
$H' =$	68.0900,	$V' =$	119.610,
$c_1 =$	1.4199,	$V_1 =$	356.400,
$c_2 =$	0.0193,	$W =$	9194.847,
$A =$	42591.3250,	$B =$	8612.568.

And by substituting these values in [151], we get the following percentage composition:—

	By Absorption.	By Eudiometer.
Hydrogen,	0.9206	0.9246
Carbonic Acid,	<u>0.0794</u>	<u>0.0754</u>
	1.0000	1.0000

And it will be noticed how closely these results agree with those obtained by chemical analysis with the eudiometer, which are given at the side for comparison.

By substituting the numerical values in [146], it will be found that the percentage composition of the gas remaining unabsorbed is,

Hydrogen,	0.9829
Carbonic acid,	<u>0.0171</u>
	1.0000

The same method of gas analysis may be extended to mixtures of three or more gases; but when the number of gases exceeds two, the formulæ become quite complex, and the results less accurate.

Gases on Gases.

(211.) *Effusion.*—It has been found by Professor Graham,* that the velocities with which different gases, when under pressure, flow through a minute aperture in a metallic plate, are closely

* Philosophical Transactions, 1846, p. 574.

related to their specific gravities; and to these phenomena has been given the name of *effusion*. In his experiments, the gases were made to flow through an aperture in a very thin metallic plate, not more than one three-hundredth of an inch in diameter, into a bell-glass on the plate of an air-pump, which was kept vacuous by continued exhaustion. The velocity of the flow was found to increase with the degree of exhaustion, (that is, with the pressure,) until it amounted to about one third of an atmosphere; but higher degrees of exhaustion were not found to produce a corresponding increase of velocity; and when the vacuum was nearly perfect, a difference of one inch in the height of the mercury column of the pump-gauge scarcely affected the rate at which the gas entered the bell. Through an aperture in a thin plate, such as described, sixty cubic inches of dry air were found to enter the vacuous or nearly vacuous receiver in one thousand seconds, and in successive experiments the time of passage did not vary more than one or two seconds. The times required for equal volumes of different gases to flow through this aperture were found to be very nearly proportional to the square roots of their specific gravities. Thus, the time required for sixty cubic inches of oxygen to flow through the aperture was observed to be 1,051.9, 1,051.9, 1,050.6, 1,050.2 seconds, in four different experiments. The mean of these numbers is 1,051.1, which bears almost precisely the same relation to 1,000, the time occupied by the same volume of air, as 1.0515, the square root of the specific gravity of oxygen, bears to 1, the square root of the specific gravity of air.

Since the times occupied by equal volumes of different gases in flowing through a fine aperture are *proportional* to the square roots of their specific gravities, it follows that the velocity of the flow must be *inversely proportional* to the square roots of the specific gravities, or *directly proportional* to the reciprocals of these quantities. Representing, then, by T and T' , the number of seconds required by equal volumes of two gases in flowing into a vacuum, we have

$$T : T' = \sqrt{(\text{Sp. Gr.})} : \sqrt{(\text{Sp. Gr.})'}. \quad [152.]$$

Also representing by v and v' the velocity of the flow, (that is, the volume of gas entering the vacuum in one second,) we have, since $T : T' = v' : v$,

$$v : v' = \sqrt{(\text{Sp. Gr.})'} : \sqrt{(\text{Sp. Gr.})} = \frac{1}{\sqrt{(\text{Sp. Gr.})}} : \frac{1}{\sqrt{(\text{Sp. Gr.})'}}. \quad [153.]$$

If we assume that the velocity of air is unity, it follows from [153], that the velocity of any other gas, as compared with air, must be the reciprocal of the square root of its specific gravity, if the principle just enunciated is correct. That this is really the case is shown by the following table, taken from Miller's Chemical Physics. In the last column of this table, headed "Rate of Effusion," the velocities of different gases compared with air as unity are given, as deduced from the experiments of Professor Graham; and it will be noticed that they very closely coincide with the reciprocals of the square roots of the specific gravities given in the fourth column. The coincidence is almost absolute in the case of those gases whose specific gravities vary but slightly from that of the air. With very light or very heavy gases the deviation is much greater; but this can be shown to be occasioned by the tubularity of the aperture, arising from the unavoidable thickness of the metallic plate.

Effusion of Gases.

Gas.	Sp. Gr.	$\sqrt{\text{Sp. Gr.}}$	$\frac{1}{\sqrt{\text{Sp. Gr.}}}$	Velocity of Diffusion.	Rate of Effusion.
Hydrogen,	0.06926	0.2632	3.7994	3.8300	3.6130
Marsh Gas,	0.55900	0.7476	1.3375	1.3440	1.3220
Steam,	0.62350	0.7896	1.2664		
Carbonic Oxide, . .	0.96780	0.9837	1.0165	1.0149	1.0123
Nitrogen,	0.97130	0.9856	1.0147	1.0143	1.0164
Olefiant Gas, . . .	0.97800	0.9889	1.0112	1.0191	1.0128
Binoxide of Nitrogen, .	1.03900	1.0196	0.9808		
Oxygen,	1.10560	1.0515	0.9510	0.9487	0.9500
Sulphuretted Hydrogen,	1.19120	1.0914	0.9162	0.9500	
Protoxide of Nitrogen,	1.52700	1.2357	0.8092	0.8200	0.8340
Carbonic Acid, . . .	1.52901	1.2365	0.8087	0.8120	0.8210
Sulphurous Acid, . .	2.24700	1.4991	0.6671	0.6800	

(212.) *Application of the Law of Effusion.* — The law of effusion, which was verified experimentally by Graham in the case of gases, is true generally of the flow of all fluids, under pressure, through an aperture in a very thin plate. It has been applied by Bunsen* in a process of determining the specific

* Bunsen's Gasometry, p. 121.

gravity of gases, which is exceedingly simple, and of especial value where only a small quantity of the gas can be obtained. The process consists in observing carefully the times required by the same volumes of any given gas and air in flowing through a fine aperture in a thin plate when under the same pressure. Representing these times by T and T' , we have, from [152],

$$(\text{Sp. Gr.}) : (\text{Sp. Gr.})' = T^2 : T'^2 ;$$

since air is the standard of specific gravity, $(\text{Sp. Gr.})' = 1$; and we easily obtain

$$(\text{Sp. Gr.}) = \frac{T^2}{T'^2} . \quad [154.]$$

The apparatus used by Bunsen in these determinations is represented in Fig. 336. It consists of a glass bell, $a a$, holding about seventy cubic centimetres, and closed above by the glass stopcock c . To the neck of the bell, at d , there is adjusted, by grinding with emery, the short tube e , and to the top of this tube there is cemented a small piece of platinum-foil, in which a very fine hole has been perforated. In order that the plate should be as thin, and the hole as fine, as possible, the platinum-foil is first pierced with a very fine cambric needle, and then hammered out with a polished hammer on a polished anvil, until the hole is no longer perceptible to the naked eye, and can only be seen when the plate is held between the eye and a bright light. The edges of the plate are next cut away, so as to leave a small round disk, having the hole in its centre. The diameter of this disk should be a little less than that of the top of the tube, to which it can easily be cemented with a blowpipe. Within the bell, when in use, is placed the glass float, $b b$, made of thin glass, in order that it may be as light as possible. At the top of this float there is a small knob of black glass, β , surmounted by a thread of white glass; and at the points β_1 and β_2 two black glass threads are melted around the stem of the float, which serve as index-marks.

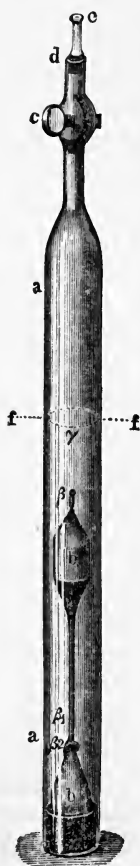

Fig. 336.

In using this instrument, the glass bell, filled with the gas whose specific gravity is to be determined, is depressed in a mercury trough until the index-mark γ , on its side, is on a level with the surface of the mercury. This index-mark is so placed that, when the bell, previously filled with gas, is depressed as just described, the float will be below the surface of the mercury in the trough. The bell is now fastened securely in this position, and the telescope of a cathetometer so adjusted that its axis shall graze the surface of the mercury in the trough, one side of which, being made of glass, enables the observer, looking through the telescope, to see the bell distinctly. The apparatus being thus arranged, the observer opens the stopcock c , and then closely watches the tube through the telescope. After some time, the white thread of the float rises into the field, and forewarns the observer that the black knob will soon appear. The moment this is seen, he commences his observation, and notes the exact number of seconds before the index-mark β_2 appears in the field of his telescope, of the approach of which he is forewarned by previously seeing the mark β_1 .

From the construction of the instrument, it is evident that the time thus observed is the time required for the flow, through the fine hole in the plate e , of a given volume of gas, under a given, although varying, pressure; and, moreover, that this volume and pressure must be the same in all experiments with the same instrument. Hence the squares of the times, in the case of different gases, must be proportional to their specific gravities; so that, having once for all determined the time required by air, we can easily, by means of [154], calculate the specific gravity of any given gas from a single observation of the time of its effusion. It is always best, however, to repeat the observation several times, and take the mean of the results.

The following table will give an idea of the degree of accuracy which can be attained by this process. Column I. gives the mean specific gravities calculated from several effusion experiments on each gas, and Column II. the specific gravities of the same gases calculated from their chemical equivalents.

The agreement between the calculated and the observed results is very satisfactory; so that, although this process is not comparable in accuracy with the direct method of determining specific gravities hereafter to be described, it is nevertheless, on

account of its great simplicity, recommended by Bunsen for use in the arts when only approximate results are required.

Gases.	I.	II.	Differences.
Air,	1.000	1.000	
Carbonic Acid,	1.535	1.520	+0.015
1 vol. C O + 1 vol. C O ₂ ,	1.203	1.244	-0.041
Oxygen,	1.118	1.106	+0.012
1 vol. O + 2 vol. H,	0.414	0.415	-0.001
Hydrogen,	0.079	0.069	+0.010

(213.) *Transpiration.*—The flow of gases under pressure through long capillary tubes presents a class of phenomena entirely different from those of effusion, and has been termed by Graham *Transpiration*. With a tube of a given diameter, Graham found that the shorter the tube, the more nearly the rate of transpiration approximates to the rate of effusion; while, on the other hand, as the tube was lengthened, he observed a deviation from the effusion rate, which was very rapid with the first increase of length, but became gradually less, and reached a maximum when a certain length had been attained. It was therefore necessary, in order to eliminate the effects of effusion from experiments on transpiration, to employ a considerable length of tube; and when this precaution was observed, uniform results were obtained. The length required in any case was found to vary with the diameter of the tube, and also, to a certain extent, with the nature of the gas. The most important conclusions which have been deduced from the researches hitherto made on transpiration are as follows:—

First. The velocity of transpiration of a given gas through a given capillary tube increases directly with the pressure. For example, a litre of air of double the density of the atmosphere, and therefore exerting twice the pressure, will pass through a capillary tube into a vacuum in one half of the time required by the same volume of air of its natural density. This is a very remarkable fact, and it shows that the process of transpiration differs very greatly in character from effusion.

Secondly. With tubes of the same diameter, the velocity of transpiration of a given gas is inversely as the length of the tube. For example, if one hundred cubic centimetres of air will pass through a capillary tube two metres long in ten minutes, a

tube of the same diameter four metres long would allow the passage of only fifty cubic centimetres in the same time.

Thirdly. The velocity of transpiration of equal volumes, *cæteris paribus*, diminishes as the temperature rises.

Fourthly. The velocity of transpiration was found to be the same, whether the tubes were of copper or of glass, or even when a porous mass of stucco was used.

Fifthly. The velocity of transpiration varies with different gases, and appears to be a constitutional property of an aeriform substance, like the density or the specific heat, not depending, as is the case with effusion, on the specific gravity.

Of all gases which have been tried, oxygen has the slowest rate of transpiration; and hence it may be conveniently taken as a standard of comparison for the other gases. In the first column of the following table, the times of transpiration of equal volumes of the best-known gases are given, as compared with that of oxygen; and in the second column, the corresponding velocities of transpiration, which are the reciprocals of the first quantities. In each case the gas was transpired through the same tube, and under precisely the same circumstances of temperature and pressure.

Transpirability of Gases.

Gases.	Times for Transpiration of equal Volumes.	Velocity of Transpiration.
Oxygen,	1.0000	1.0000
Air,	0.9030	1.1074
{ Nitrogen,	0.8768	1.1410
{ Binoxide of Nitrogen,	0.8764	1.1410
{ Carbonic Oxide,	0.8737	1.1440
{ Protoxide of Nitrogen,	0.7493	1.3340
{ Hydrochloric Acid,	0.7363	1.3610
{ Carbonic Acid,	0.7300	1.3690
Chlorine,	0.6664	1.5000
Sulphurous Acid,	0.6500	1.5380
Sulphuretted Hydrogen,	0.6195	1.6140
Light Carburetted Hydrogen,	0.5510	1.8150
Ammonia,	0.5115	1.9350
Cyanogen,	0.5060	1.9760
Olefiant Gas,	0.5051	1.9800
Hydrogen,	0.4370	2.2880

Some very simple relations in the transpirability of different gases may be discovered by examining the above table. Thus,

equal weights of oxygen, nitrogen, air, and carbonic oxide are transpired in equal times; the velocities of nitrogen, binoxide of nitrogen, and carbonic oxide, are equal; the velocity of hydrogen is double that of the three just mentioned; the velocities of chlorine and of oxygen are as three to two. Many other similar cases might be cited; but these relations seem to be merely accidental, and have not as yet been connected with the other properties of the substances. "Professor Graham considers, at present, that it is most probable that the rate of transpiration is the resultant of a kind of elasticity depending upon the absolute quantity of heat, latent as well as sensible, which different gases contain under the same volume, and therefore that it will be found to be connected more immediately with the specific heat than with any other property of gases."*

Lastly. The velocity of transpiration of a mixture of equal volumes of two gases is not always the mean of the velocities of the two gases when separate. For example, the velocity of a mixture of equal volumes of oxygen and hydrogen is 1.110, instead of 1.383, which would be the mean velocity of the two gases.

(214.) *Diffusion*. — The tendency of gases to mix with each other is so strong, that it will overcome the greatest differences of specific gravity; and, contrary to what a superficial consideration would lead us to expect, the more widely two gases differ in specific gravity, the more rapid is the process of intermixture. This process is termed *diffusion*, and may be illustrated by means of the apparatus represented in Fig. 337, consisting simply of two bottles, *A* and *H*, connected together by a long glass tube. If we fill the upper bottle with hydrogen and the lower bottle with chlorine, we shall find, in the course of a few hours, that the two gases have been perfectly mixed together, although the ratio of their specific gravities is three times as great as the ratio of the specific gravity of mercury to that of water. The

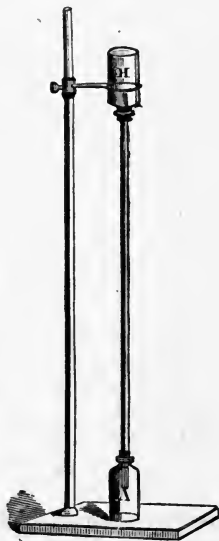

Fig. 337.

* Miller's Elements of Chemistry, Part I. p. 86.

chlorine, although thirty-six times heavier than hydrogen, will be found to have made its way into the upper bottle, as may be seen by its green color, while the hydrogen will have passed downwards into the lower one; and when once mixed, the two gases will never separate, however long they may remain at rest.

What has been shown to be true of hydrogen and chlorine is equally true of all other gases and vapors, which do not act chemically on each other. The only differences observed with different substances are the times required to effect a perfect mixture; but when once made, this mixture, in all cases, continues uniform and permanent. This subject may be still further illustrated by filling two tall, narrow glass bells of equal diameters over a pneumatic trough, the one half full of hydrogen, and the other half full of air, so that the water shall stand at the same level in both. If, now, we pass up a few drops of ether into each jar, the same quantity of ether will evaporate in both, and cause, ultimately, the same depression of the water-level; but the expansion of the hydrogen will take place much the soonest, because, being fourteen and a half times lighter than air, the heavy ether vapor will mix with it more rapidly.

The law which governs the rapidity of gaseous diffusion was discovered by Graham, by means of the apparatus represented in Fig. 338, and called by him a *diffusion tube*. It consists of a glass tube thirty or forty centimetres in length, one end of which is closed by a plug of plaster of Paris, which should be as thin as is consistent with strength. This tube serves as a bell for holding the gas under experiment over the water contained in a tall glass jar; and it may be easily filled without wetting the porous diaphragm, by means of a glass siphon-tube,

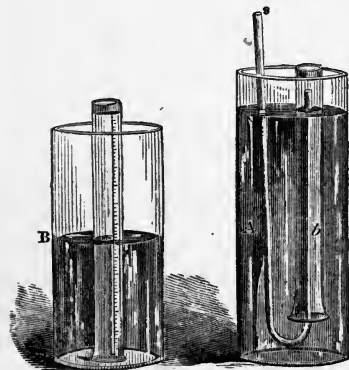

Fig. 338.

as represented in the figure. While filling the tube, the top is closed by means of a glass plate, which has previously been carefully ground with emery on to the upper edge above the plaster

diaphragm. The tube, when filled with gas, should be so supported that the water may be on the same level within and without the tube. If then the glass covering-plate is removed, the gas will be found to mix with the air through the thin plaster diaphragm, the gas passing out into the atmosphere, and the air, on the other hand, entering the tube. The relative velocity of the two currents will be found to depend on the relative density of the gas as compared with air. If the gas is lighter than air, the outer current will be the most rapid, and the water column will rise in the tube to supply the vacuum thus formed; while, on the other hand, if the gas is heavier than air, the inward current will be the most rapid, and the water column will be depressed. If the gas is hydrogen, which is fourteen and a half times lighter than air, the outer current will be so much the most rapid, that in the course of a few minutes the water column, under favorable circumstances, will rise to over one half the height of the tube. In all cases, after a certain time, varying with the specific gravity of the gas and the thickness of the diaphragm, the gas in the tube will have been replaced entirely by a volume of air, which will be greater or less than the original volume of gas, according as the velocity of diffusion of the air is greater or less than that of the gas. By comparing, then, the original volume of the gas with the volume of the air remaining in the tube at the close of the experiment, we shall have at once the relative velocity of diffusion of the two gases. In making experiments for the purpose of determining the velocity of diffusion, it is evidently essential to maintain the water at the same level, both within and without the tube, since otherwise the effects of diffusion would be modified by the hydrostatic pressure.

As an illustration of the method of determining the velocity of diffusion, let us suppose that the tube was filled with 100 c. m.^3 of hydrogen gas, and that at the end of the experiment, during which the surface of the water within and without the tube was carefully maintained at the same level, there remained in the tube 26.1 c. m.^3 of air. It is evident, then, that during the time 100 c. m.^3 of hydrogen escaped from the tube through the porous diaphragm, 26.1 c. m.^3 of air entered. Hence, the velocity of the diffusion of hydrogen is 3.83 times (equal to $100 \div 26.1$) more rapid than that of air. In the same way, all the numbers in the column of the following table headed "Velocity of Diffu-

sion" were found. They in each case indicate the velocity of diffusion as compared with air; and it will be noticed that they very nearly coincide with the velocity of effusion.

Diffusion of Gases.

Gas.	Sp. Gr.	$\sqrt{\text{Sp. Gr.}}$	$\frac{1}{\sqrt{\text{Sp. Gr.}}}$	Velocity of Diffusion.	Rate of Effusion.
Hydrogen,	0.06926	0.2632	3.7994	3.8300	3.6130
Marsh Gas,	0.55900	0.7476	1.3375	1.3440	1.3220
Steam,	0.62350	0.7896	1.2664		
Carbonic Oxide, . .	0.96780	0.9837	1.0165	1.0149	1.0123
Nitrogen,	0.97130	0.9856	1.0147	1.0143	1.0164
Olefiant Gas, . . .	0.97800	0.9889	1.0112	1.0191	1.0128
Binoxide of Nitrogen, .	1.03900	1.0196	0.9808		
Oxygen,	1.10560	1.0515	0.9510	0.9487	0.9500
Sulphuretted Hydrogen,	1.19120	1.0914	0.9162	0.9500	
Protoxide of Nitrogen,	1.52700	1.2357	0.8092	0.8200	0.8340
Carbonic Acid, . . .	1.52901	1.2365	0.8087	0.8120	0.8210
Sulphurous Acid, . .	2.24700	1.4991	0.6671	0.6800	

It appears, then, that the velocity of diffusion of a gas is the same as the velocity of effusion, and hence, like the latter, is inversely proportional to the square root of its specific gravity. In other words, gases expand into each other according to the same law which they obey in expanding freely into a vacuum. This fact has been thought to support the theory of Dr. Dalton, that gases are inelastic towards each other, one gas offering no more permanent resistance to the expansion of another gas than would be presented by a vacuum. Thus, in the experiment with the two bottles (Fig. 337), Dalton supposed that the hydrogen expanded through the space occupied by the chlorine just as if the space were entirely empty; and he explained why the expansion was not instantaneous by the supposition that the particles of chlorine offer the same sort of resistance to the motion of hydrogen as is offered by the stones on the bed of a brook to the running of water. There can be no question that the ultimate result of diffusion is always in conformity with Dalton's theory; and although we may hesitate to assume that gases are in all respects vacua to each other, yet this theory is at present the most convenient mode of expressing the phenomena of diffusion.

If, instead of using a homogeneous gas, we introduce a mixture

of two or more gases into the diffusion-tube, each gas will be found to preserve its own rate of diffusion. Thus, if the mixture consists of hydrogen and carbonic acid, the hydrogen will escape from the tube much more rapidly than the carbonic acid, and a partial mechanical separation of the two gases may thus be effected.

It is not essential that the top of the diffusion-tube should be closed with plaster of Paris. Any dry porous substance, such as charcoal, wood, unglazed earthen-ware, or dried bladder, may be substituted for the stucco; but few of them answer so well.* The diaphragm is best prepared by casting a very thin disk of plaster on a glass plate, and, after it is thoroughly dried, cutting it to the required size with a sharp knife, and cementing the edges with sealing-wax to the inner rim of the tube.

The ascent of a column of water in the tube, when hydrogen is diffused, forms a very striking experiment. This may readily be shown to an audience with a Graham's diffusion-tube about a metre in height and four or five centimetres in diameter, resting the bottom in a pan of colored water. The tube can easily be filled with hydrogen by displacement, and the gas retained in its place by covering the top with a ground-glass plate, which should be removed at the time of the experiment. The same principle can be even more strikingly illustrated by means of an apparatus described by Professor Silliman, Jr., and represented in Fig. 339. It is made by cementing the open mouth of a porous earthen-ware cell (such as are used in a galvanic battery) to the mouth of a glass funnel, and then lengthening the spout by attaching to it a long glass tube of the same diameter. When in use, the apparatus is supported as represented in the figure, so that the end of the tube shall dip into a glass filled with colored water. If, now, we hold over the

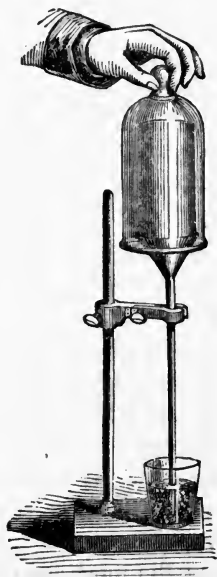

Fig. 339.

* Later experiments have shown that the best material is compressed plumbago. A film of collodion on paper also gives excellent results.

porous cell a bell-glass filled with hydrogen, there will be an immediate rush of air from the tube through the water, because the hydrogen diffuses into the cell nearly four times as rapidly as the air passes out; but upon removing the bell of hydrogen the conditions are reversed, — the hydrogen, which the cell now contains, diffuses into the atmosphere, and the colored water immediately rises into the tube.

As all gases are expanded by heat, and therefore rendered specifically lighter, it follows that the *absolute* velocity of diffusion of any gas (measured by volume) increases with an increase of temperature; but since an elevation of temperature does not increase the rate of diffusion as rapidly as it does the volume of a gas, it is also true that the same weight of any gas will be diffused more rapidly at a low than at a high temperature. It will hereafter be shown that heat expands all gases equally, so that their relative densities are preserved, however great the change of temperature. Hence the *relative* velocities of diffusion, which are given in the table on p. 422, are the same for all temperatures, provided, of course, the gases be heated equally.

This diffusive power of gases is of the greatest importance in preserving the purity of our atmosphere. As it is, the noxious carbonic acid from our lungs, the deleterious fumes from our factories, and the miasmatic emanations from the marshes, are rapidly spread through the atmosphere and rendered harmless by extreme dilution, until they can be removed by the beneficent means appointed for this end. Moreover, the more they differ in density from the air, and the more, therefore, they would tend to separate from it, the stronger is the force by which they are compelled to mix. Were it not for this provision in the constitution of gases, these injurious substances would remain where they were formed, and might produce the most disastrous consequences. If we consider, also, the oxygen and nitrogen of which the atmosphere essentially consists, they differ in density in the proportions of 1105 to 971; but yet they are so perfectly mixed, that the most accurate chemical analysis has been able to detect no difference between the air brought from the top of Mont Blanc and that from the deepest mine of Cornwall. Were the force of diffusion much less than it is, these two gases would separate partially, and the atmosphere be unfitted for many of its important functions.

Bunsen,* who has more recently studied the phenomena of gaseous diffusion, has obtained results which do not coincide with the simple law discovered by Graham, and enunciated above. The discrepancy between the results of these two eminent observers probably arises from the great thickness of the plaster diaphragm in the apparatus used by Bunsen; in consequence of which the phenomena of diffusion were modified by those of transpiration. Compare (213). The same must be true, to a certain extent, of the diffusion-tube of Graham; and the experimental results will probably approach the law in proportion as the thickness of the diaphragm is diminished, actually coinciding with it only when the diaphragm is entirely removed and the gases expand freely into each other.

(215.) *Passage of Gases through Membranes.* — If a bladder half filled with air, and having its mouth tied, is passed up into a bell-glass of carbonic acid standing over water, it will become, in the course of twenty-four hours, fully distended, and may even burst, owing to the passage of carbonic acid gas through the pores of the bladder. This is not, however, a simple phenomenon of diffusion, since the carbonic acid enters the bladder as a liquid dissolved in the water permeating the substance of the membrane, and evaporates from the inner surface of the bladder like any other volatile liquid. A similar transfer takes place with a jar of gas standing on the shelf of a pneumatic trough. The water dissolves, to a slight extent, the gases of the atmosphere, which subsequently evaporate into the jar, while at the same time the gas in the jar slowly passes out, in a similar way, into the atmosphere. For this reason, gases confined over water cannot be kept pure for any length of time. Analogous phenomena have been observed with membranes of india-rubber, a substance which has the power of absorbing many gases to a remarkable extent, especially those which are more easily liquefied. It is probable that the gases are always liquefied in the india-rubber, and pass through it in this condition, evaporating subsequently on the interior surface of the membrane. A similar absorption must take place, to a greater or less extent, with any diaphragm; even with plaster of Paris it is appreciable, and slightly modifies the experimental results of diffusion.

* Bunsen's Gasometry, p. 198.

CHAPTER IV.

HEAT.

(215 bis.) *Theory of Heat.* — All natural substances are, in certain conditions, capable of producing on our bodies peculiar sensations, which we designate by the words *heat* and *cold*. These sensations may result from direct contact with the substance, as when we touch a heated stove; or they may be produced at a great distance from it, as when we are warmed by the radiation from burning fuel or by the rays of the sun.

To the cause of these effects we give the name of heat; but according to the most generally received theory heat is not a distinct agent, but merely an affection of matter, and the phenomena of heat are thought to be caused by the motion of the molecules of which all matter must be supposed to consist. Not only are the molecules of all bodies assumed to be in rapid motion among themselves, but the motion of the molecules is supposed to obey the same laws as the motion of large masses of matter. Moreover, the molecules are assumed to be perfectly elastic, so that motion may be transferred from one molecule to another, as from one billiard-ball to another. Again, when a moving body is suddenly arrested, it is supposed that the motion of the body is distributed among the surrounding atoms; and on the other hand it is inferred that moving atoms may transfer their motion to masses of matter, and the atoms of steam, it is thought, thus impart motion to the piston of the steam-engine.

According, then, to this view, a heated body differs from a cold body only in the fact that its molecules are moving more rapidly within its mass. The moving power of the individual molecules represents what we call the temperature, and this is the measure of the force with which they would impress the nerves of feeling. The higher the temperature, the greater is the moving power, and for the same temperature the molecules of all bodies are assumed to have the same moving power. The zero of absolute cold would be the temperature at which the molecules are at rest, but such a

point has never been reached, even if it is a possible condition of matter. While the moving power of the individual molecules represents the temperature of a body, the total moving power of all the molecules represents the amount of heat which it contains. Quantity of heat, then, is simply quantity of motion; and, as we shall hereafter see, the quantity of motion corresponding to each heat unit is capable of exact measurement.

The transfer of heat from one body to another is simply the transfer of motion from the molecules of the one body to the molecules of the other. This transfer may result either from the direct collision of the molecules, as when one ivory ball strikes another, or it may be effected through the intervention of the ether atoms by which the molecules of all bodies are assumed to be surrounded, the line of ether atoms along which the motion may be supposed to be transmitted, as along a line of ivory balls, representing the rays of heat. Such is thought to be the difference between the conduction and the radiation of heat; although it may be that motion cannot pass even from molecule to molecule except through the contiguous atoms of ether.

The difference between the three states of aggregation of matter, according to the theory we are considering, depends upon the relative freedom of motion of the material molecules. In a gas this motion is wholly unrestrained, and the tension of the gas is supposed to be due to the collision of the atoms against the walls of the containing vessel. If the walls are unyielding, the atoms recoil without losing any moving power, as any elastic ball would rebound from a fixed obstacle (109). When, however, the walls yield to the atomic blows, then the atoms lose a portion of their moving power, and a lower temperature is the result. In both solids and liquids the motion is supposed to be more or less circumscribed by the molecular forces, just as the force of gravitation restrains the motion of the planets and keeps each in a fixed orbit. In the solid the motion is more circumscribed than in the liquid, but in regard to the mode of motion in either case there is no uniformity of opinion. As the temperature of a body increases, the moving power of its molecules may become great enough to overcome the molecular forces, and then the molecules, freed from the restraint which bound them, will move among each other with more or less freedom, the solid changing first into a liquid and afterwards into a gas. Since, however, the molecular

forces can only be overcome by the expenditure of moving power, such a change must be attended with the absorption of heat; and when, on the other hand, in consequence of the reduction of temperature, and consequently of the moving power of the molecules, these are brought again under the influence of the molecular forces, an equivalent amount of heat is set free; just as a stone, which, thrown from the earth, falls again to the ground, acquires, while falling, the same momentum which it lost while rising.

It will hereafter appear that the change of state of aggregation is always accompanied by such an absorption or evolution of heat as the theory predicts. Moreover, it will also appear that the arrest of motion is always attended with the evolution of heat, and that the amount of heat evolved is the exact equivalent of the moving power which has disappeared; as must necessarily be the case, if, as the theory assumes, the moving power is transferred to the neighboring molecules at the moment of collision, and their motion manifests itself in the phenomena of heat.

According to the modern theory of chemistry, equal volumes of all substances in the state of gas contain precisely the same number of molecules, or, what amounts to the same thing, the molecules of all bodies in the state of gas occupy exactly equal volumes. Hence it follows that the weights of the molecules of any two substances must be to each other in the same proportion as the specific gravities of these substances when in the state of gas, or

$$m : m_1 = \text{Sp. Gr.} : \text{Sp. Gr.}'$$

If, then, we assume that the hydrogen molecule shall be the unit in our system of molecular weights, we can easily calculate the molecular weights of all other bodies as compared with that of hydrogen. The molecular weights thus obtained are either the same numbers as those which express in chemistry the combining proportions of the different elements, or else they are some simple multiple of these numbers.

If, now, we represent by V and V_1 the velocities with which the molecules of any two substances in the state of gas are moving at any given temperature, for example, 0° Centigrade, then, since, according to our theory, the moving power of any two such molecules must be the same at the same temperature, we shall have

$$\frac{1}{2} m V^2 = \frac{1}{2} m_1 V_1^2;$$

and from this we can readily deduce the proportion

$$V : V_i = \sqrt{m_i} : \sqrt{m} = \sqrt{\text{Sp. Gr.}'} : \sqrt{\text{Sp. Gr.}}$$

that is, the velocities of the motion of the molecules of any two substances in the state of gas are inversely proportional to the square roots of the weights of these molecules, or to the square roots of the specific gravities of the gases. The diffusion of gases (214) is evidently a necessary result of molecular motion, and the relative velocity of diffusion must be the same as the relative velocity of the molecular motion, and hence must be inversely proportional to the square roots of the specific gravities of the different gases. This is the simple law already enunciated on page 422.

According to the theory here adopted, the value $\frac{1}{2} m V^2$, which represents both the moving power of a given molecule and the temperature of the body of which the molecule is a part, represents also the quantity of heat which that molecule contains. Hence, as all molecules at the same temperature have the same moving power, they must have also the same quantity of heat. It must, therefore, require the same quantity of heat to raise the temperature of a single molecule of any substance the same number of degrees. And if this is true of single molecules, it must be true of equal numbers of such molecules, or, in other words, of weights of different substances which bear to each other the same relation as the weights of their respective molecules. If, then, the weights of two substances, M and M' , are to each other in the same proportion as the weights of the molecules of these substances, m and m' , then the same quantity of heat will raise the temperature of the unequal weights M and M' the same number of degrees. Or, if we represent by S and S' the quantities of heat which are required to raise the temperature of one kilogramme of each of two substances one degree, and by m and m' the relative weights of their respective molecules, then $\frac{1}{m}$ and $\frac{1}{m'}$ will represent the relative number of molecules of each substance in one kilogramme; and since the quantity of heat required must be proportional to the number of molecules, we shall have

$$\frac{1}{m} : \frac{1}{m'} = S : S', \text{ or } m S = m' S'.$$

The quantities S and S' are called the specific heats of the

substances; and hence, according to the theory, the products obtained by multiplying together the specific heats of different substances and their molecular weights (or combining proportions) should be equal. In the case of the chemical elements this is very nearly true; and it would probably be found precisely true for all substances, could the comparison always be made under precisely the same conditions, and when the substances were in the state of gas.

Again, since equal volumes of different gases always contain the same number of molecules, our theory would lead us to anticipate that equal quantities of heat would raise the temperature of the same volume of any gas to an equal extent. This also we find to be true of the permanent gases; and although in the case of the vapors the deviations from this law are apparently very great, yet such deviations are probably owing, in part at least, to the imperfect aeriform condition of these bodies, and also perhaps to the mechanical condition of the molecules themselves, of which our theory has as yet taken no account.

Of the various theories which have been proposed to explain the phenomena of heat, the one here stated is the simplest and the most intelligible, predicting, as well as could be expected, the general order of the phenomena. It must be admitted, however, that, as here stated, this theory is open to grave objections, and, like all theories in science, it should be regarded as a provisional expedient, and not as an established principle. That the phenomena of heat have a purely mechanical cause is most probable, but the mode or the seat of the motion which causes them is wholly a matter of conjecture. We shall discuss the phenomena of heat in this chapter as far as is possible independently of any theory, using for the purpose the ordinary language of science. It must be remembered, however, that much of this language is based on the old theory, now rapidly passing away, which regarded heat as a material, although an imponderable agent. No difficulty, however, will arise, if it is remembered that quantity of heat means simply quantity of motion, and that all terms relating to quantity are as strictly applicable to motion as they are to matter.

(216.) *The Action of Heat on Matter.* — The mechanical effects of heat on matter may be all explained by assuming that heat acts as a repulsive force between the particles, and therefore

opposes the attractive force of cohesion. The first effect of heat on matter, in either of its three states, is to expand it. This may be illustrated by a great variety of familiar facts and experiments. A ball of metal, which exactly fits a ring when cold, will not pass through it when heated. The parts of a wheel are bound together by the contraction of the tire, which is put on while hot. Clocks go slower in summer than in winter, because the pendulum is lengthened by the heat.

Different substances expand unequally for the same increase of temperature. We estimate the expansion either by measuring the increase of length or the increase of bulk. The first is called the *linear expansion*, the second the *cubic expansion*. In the case of solids we generally measure solely the linear expansion, while in the case of liquids and gases we as generally measure solely the cubic expansion. The one, however, can easily be calculated from the other, since the cubic expansion is about three times as great as the linear expansion. The following table will give an idea of the amount of expansion in different substances, and will show that gases expand very much more than liquids, and liquids very much more than solids.

Between the Freezing and Boiling Points of Water :

A rod of zinc	increases in length	$\frac{1}{323}$,	that is,	323 c. m.	become	324.
" lead	"	"	$\frac{1}{351}$,	" 351	"	352.
" tin	"	"	$\frac{1}{516}$,	" 516	"	517.
" silver	"	"	$\frac{1}{524}$,	" 524	"	525.
" glass (crown)	"	"	$\frac{1}{1142}$,	" 1142	"	1143.

Alcohol increases in volume $\frac{1}{9}$, that is, 9 c. m.³ become 10.

Water " " $\frac{1}{23}$, " 23 " " 24.

Mercury " " $\frac{1}{55}$, " 55 " " 56.

Air and the permanent gases expand $\frac{1}{30}$, that is, 30 c. m.³ become 41.

Before, however, we study the phenomena of expansion in detail, it is important to examine the various means by which the effects of expansion are used as a measure of temperature.

THERMOMETERS.

(217.) *Mercurial Thermometer.*—It is obvious that we might use, as the measure of temperature, the effect caused by heat in expanding either solids, liquids, or gases, and thermometers have been constructed of each of these three forms of matter. The expansion of solids, however, is so small, and that of gases so difficult to measure, that their indications are not available for the ordinary purposes for which a thermometer is required; while liquids, on the other hand, having an intermediate degree of expansibility, and their changes of volume being readily measured, are well suited for thermometrical uses. Of the various liquids which might be employed, mercury is much the best, not only on account of the great range of temperature between its freezing and boiling points, but also because its increase of volume is very nearly proportional to the increase of temperature.

In order to make a mercury thermometer, a capillary glass tube is first selected, whose bore is of the same calibre throughout, so that equal lengths of the tube will contain equal volumes of mercury. The uniformity of the bore is readily tested by introducing into the tube a small amount of mercury, and moving this short column gradually from one end to the other, measuring its length in each successive position. This should, of course, be the same in every case; and if not, the tube must be rejected.

The glass tube having been selected, and cut off to the required length, a bulb is blown upon the end by the usual method of glass-blowing, using, however, an india-rubber bag instead of the mouth, in order to avoid moisture. The size of the bulb is varied according to the degree of sensibility required in the instrument; but it is always made large in comparison with the tube, so that a slight expansion of the enclosed liquid will cause it to fill a considerable length of the bore. The form of the bulb may be either spherical or cylindrical. The first is most easily made; but the last, from exposing a greater surface, is more readily affected by changes of temperature. To facilitate the introduction of the mercury, a cup is sometimes cemented to the open end of the tube, although a paper funnel fastened with twine will answer every purpose.

The tube thus prepared is now easily filled with mercury. Holding the tube in a vertical position, we pour mercury into the

cup, and heat the bulb with a lamp in order to expel a portion of the air. On removing the lamp the glass soon cools, and the mercury is forced in by the pressure of the atmosphere, partially filling the bulb. We now again apply the lamp, as represented in Fig. 340, until the mercury boils; and continue the boiling for several minutes, in order that the mercury vapor may drive out all the air and moisture. The lamp is then again removed, when the mercury, pressed in by the atmosphere, descends and fills completely the whole apparatus. The cup is then emptied of the excess of mercury, and the tube just below it drawn out to a narrow neck in the flame of a blowpipe, when the cup may be broken off.

As the tube is now filled with mercury, a greater or less portion of it must be removed, depending on the range to be given to the instrument. This is accomplished by heating the bulb to the highest temperature which

the thermometer is expected to measure, when the excess of mercury is expelled through the minute aperture left in the neck of the tube. The source of heat is now withdrawn; and the moment the column of mercury begins to descend, the flame of a blowpipe directed against the end of the stem hermetically seals the tube. It remains then only to graduate the instrument.

(218.) *Graduation of the Thermometer.* — If the bore is uniform, it is evident that the rise of the mercury in the tube will be proportional to the expansion, so that we have in the thermometer an instrument with which we can measure any change of volume of the included liquid; and if we assume that the expansion is proportional to the increase of temperature, it is evident that it will also serve as a very delicate measure of temperature.

The thermometer is always graduated by means of two fixed temperatures, — those of melting ice and of boiling water. The



Fig. 340.

bulb and the portion of the tube filled with mercury are first surrounded by pulverized ice, and the point to which the mercury falls is marked with a file on the stem (Fig. 341). The thermometer is next immersed in steam escaping freely into the atmosphere, and the point to which the mercury rises marked as before. The temperature of free steam is always approximately the same as that of boiling water, and even more constant, not being affected by many circumstances, such as the nature of the vessel and the presence of impurities, which may change slightly the boiling-point.



Fig. 341.

The apparatus represented in Figs. 342 and 343, invented by Regnault, is admirably adapted for fixing the boiling-point. Its construction is sufficiently evident from the drawing, and does not, therefore, require description. The steam rising

from the boiling water circulates in the direction of the arrows, escaping by the tube *D*; and the object of the double envelope is merely to prevent the steam from condensing in the inner cylinder *A*.

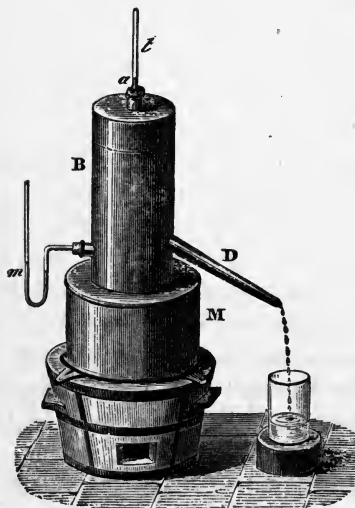

Fig. 342.

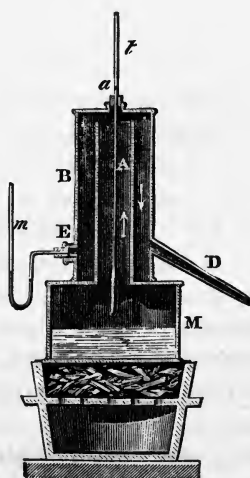

Fig. 343.

Since the temperature of boiling water and of the steam escaping from it varies with the atmospheric pressure, it is evidently essential to pay regard to this circumstance in graduating the thermometer. The fixed point adopted for the graduation is the temperature at which water boils under a pressure of 76 c. m.; and if the barometer, at the time of graduation, indicates a different pressure, it is necessary to make a correction accordingly. This correction is easily calculated, since Wollaston determined that the boiling-point of water increases one Centigrade degree for every increase of pressure measured by 2.7 c. m. of mercury column. In determining the boiling-point with Regnault's apparatus, it is necessary to guard against any accidental variation of pressure in the interior; and for this reason, it is furnished with the manometer-tube *m*.

The two fixed points having been marked on the tube, the distance between them is next divided into equal parts, called *degrees*. Two different scales are used in this country. In the Centigrade scale, which is the one most generally used for scientific purposes, the distance is divided into one hundred degrees, which are numbered from the freezing-point of water. These divisions are continued of the same size both above 100° and below 0°, the last being distinguished by a minus sign; thus, -10° stands for ten degrees below zero. In the Fahrenheit scale, which is used almost exclusively in common life, the distance is divided into one hundred and eighty degrees, which are numbered from a point thirty-two degrees below the freezing-point of water; so that on this scale the freezing-point of water is at 32°, and the boiling-point at $32^\circ + 180^\circ = 212^\circ$.

The Fahrenheit scale originated with an instrument-maker of Dantzic, from whom it is named, and appears to have been based on some theoretical views in regard to the expansion of mercury which have long since been forgotten. It is supposed that the zero was chosen as marking the greatest cold which had been observed at Dantzic, and which Fahrenheit regarded as the greatest possible. We are now, however, able to reduce the temperature of bodies at least one hundred and fifty degrees below the zero of Fahrenheit, so that this zero is far from marking the greatest possible cold; moreover, since cold is merely the absence of heat, and since we cannot remove all the heat from matter, we can never expect to reach the absolute-zero. Indeed, the

whole thermometric scale is to be regarded as purely arbitrary, and may be compared to a chain, extending indefinitely both upwards and downwards. We select some point on the chain, and begin to count the degrees from that. We fix the length of our degrees by selecting a second point, at a convenient distance above the first, and dividing the intervening length into an arbitrary number of equal parts. Thus all is arbitrary; and there is no peculiar virtue in the two points which have been chosen, other than that they can be easily determined with accuracy, and include between them the range of temperature with which we are usually most concerned.

The Centigrade scale has been adopted in this work, not only because it has a decimal subdivision, but also because it is the one most generally adopted in the scientific works both of this country and of Europe. At the end of the book there will be found a table by which the degrees of the Centigrade scale may be converted into those of the Fahrenheit. This reduction can easily be made mentally, since $100^{\circ} \text{C.} = 180^{\circ} \text{F.}$, or $5^{\circ} \text{C.} = 9^{\circ} \text{F.}$; hence $\text{F.}^{\circ} = \frac{9}{5} \text{C.}^{\circ} + 32$. The 32 is added, because the zero of Fahrenheit is 32 Fahrenheit degrees below the zero of the Centigrade. An easy rule for mental calculation is, *Double the number of Centigrade degrees, subtract one tenth of the whole, and add thirty-two*. When the Centigrade degrees are below zero, they are marked with a minus sign; and this sign must be regarded in using the above rule.

Besides the two just mentioned, the scale of Reaumur is also used in some countries of Europe. On this scale the distance between the freezing and boiling points of water is divided into eighty equal parts, but the zero is the same as on the Centigrade. It is, however, never used in this country, and is seldom referred to in scientific works.

In all thermometers, after the length of a degree has been ascertained by dividing the distance between the freezing and boiling points of water into equal parts, the divisions are continued of the same size beyond the two fixed points on either side. This method of graduation occasions a defect in the instrument which must now be noticed.

(219.) *Defects of the Mercury Thermometer.*—It will be obvious, from a moment's reflection, that we do not observe in a thermometer-tube the absolute expansion of mercury, but only

the relative expansion as compared with that of the glass bulb. Did the glass expand as much as the mercury, the column of liquid would evidently remain stationary at all temperatures. If it expanded more than the mercury, an increase of temperature would cause the column to fall. In fact, the expansion of mercury is seven times greater than that of glass; so that its apparent expansion, when enclosed in a glass vessel, is about one seventh less than the absolute expansion. The rise of the column of mercury in a thermometer-tube is, then, a mixed effect of the expansion of the enclosed mercury and of the glass envelope.

It is further evident, that the whole value of the thermometer, as a measure of temperature, rests upon the assumption that the expansion of a given quantity of mercury is exactly proportional to the amount of heat which enters it. If, for example, a given amount of heat, entering the mercury of a thermometer, causes it to expand 0.001 of its volume, and consequently to rise in the stem one centimetre, it is assumed that twice, three times, etc. as much heat will cause it to expand 0.002, 0.003, etc. of its volume, and to rise in the stem 2, 3, etc. centimetres. This assumption is not, however, absolutely correct, for the rate of expansion of mercury gradually increases with the temperature; so that, in the example just cited, twice as much heat will cause the mercury to expand a little more than 0.002, and three times as much heat a little more than 0.003 of its original volume. Or, to take another illustration, let us suppose that a certain amount of heat, entering the mercury of a thermometer, causes the column to rise in the stem one centimetre, which we may suppose, in a given case, to be the length of one Centigrade degree; and let us also suppose that exactly equal amounts of heat enter the same thermometer during successive intervals of time. If the rate of expansion of mercury were uniform, each addition of heat would cause the mercury to rise exactly one centimetre; so that, if the stem were divided into centimetres, each of these would indicate the same accession of heat. As it is, however, the addition of the second quantity of heat causes the mercury to rise a little more than a centimetre, the addition of the third quantity causes a rise still greater than before, and so on. Hence, in order that the degrees of the thermometer may indicate equal accessions of heat, they should slowly increase in length from zero up. In the case of mercury, the rate

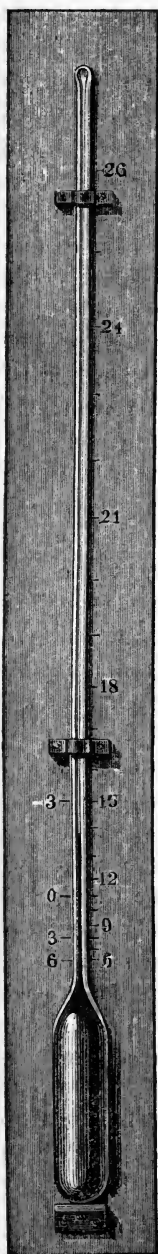

Fig. 344.

of expansion changes so slowly, that the increase in the length of the degrees would not be perceptible to the eye within the usual range of the scale; but if the thermometer is filled with water, whose rate of expansion increases very rapidly, the effect becomes very evident. The water thermometer, represented in Fig. 344, is so graduated that each division on the scale corresponds to an equal amount of heat; and it will be noticed that the degrees near the top of the scale are several times longer than those near the zero point. This, then, is an exaggerated representation of the way in which a mercury thermometer should be graduated, in order to be perfectly accurate; the length of the degrees should slowly increase from the zero point up. In practice, however, as has been described, they are made of the same length. The error, thus caused, is not important between the two fixed points; since, by dividing the given distance into equal parts, we obtain a mean length for the degree, which, although too long for the degrees near the freezing-point, and too short for the degrees near the boiling-point, is exact for the intermediate degrees, and very nearly correct for all. But above the boiling-point the same is not the case; for while the degrees marked on the scale have the same length as those below, the true length of the degree is constantly increasing, until the difference becomes very considerable. Hence a thermometer above the boiling-point always indicates too high a temperature; and, for the same reason, below the freezing-point indicates too low a temperature.

The value of the mercury thermometer as an accurate instrument would not be materially impaired by the facts stated above, since it would always be possible to estimate the amount of deviation in any case, and apply the correction to the observed results. Unfortunately, however,

its indications are also affected by the unequal expansion of the glass envelope. It so happens that the rate of expansion of glass increases quite as rapidly as that of mercury; so that the error induced by the increased rate of expansion of mercury is in part corrected, indeed sometimes over-corrected, by the increasing capacity of the glass bulb. Unfortunately, the rate of expansion differs very considerably in different kinds of glass, and even in the same glass under different circumstances; so much so, that two thermometers, even when constructed with the greatest care, seldom agree for temperatures very much above or below the fixed points. It is thus evident, that, while the expansion of the glass tends to correct the error which would be caused by the unequal expansion of mercury, it nevertheless renders the indications of the thermometer uncertain to a slight extent, and sufficiently to deprive the instrument of that accuracy which is desirable in a scientific investigation.

The facts stated in this section are illustrated by the following table, from the well-known memoir of Regnault* on this subject.

Comparison of Different Thermometers.

Air Thermometer. True Temperature.	Thermometer without Glass.	Thermometer, Flint-glass.	Thermometer, Crown-glass.	Coefficient of Expansion of Mercury.
0	0	0	0	0.000 1790
50.00	49.65		50.20	0.000 1815
100.00	100.00	100.00	100.00	0.000 1830
120.00	120.33	120.12	119.95	0.000 1850
140.00	140.78	140.29	139.85	0.000 1861
160.00	161.33	160.52	159.74	0.000 1871
180.00	182.00	180.80	179.63	0.000 1881
200.00	202.78	201.25	199.70	0.000 1891
220.00	223.67	221.82	219.80	0.000 1901
240.00	244.67	242.55	239.90	0.000 1911
246.30			246.30	
260.00	265.78	263.44	260.20	0.000 1921
280.00	287.00	284.48	280.52	0.000 1931
300.00	308.34	305.72	301.03	0.000 1941
320.00	329.79	327.25	321.80	0.000 1951
340.00	351.34	349.30	343.00	0.000 1962

Column 1 gives the temperatures of the air thermometer taken as the standard, which may be regarded as very close approxima-

* Mémoires de l'Institut, Tom. XXI. pp. 239, 323.

tions to the true temperature. Column 2 gives the corresponding temperatures which would be indicated by a mercury thermometer, graduated in the usual way, if the glass did not expand at all; showing the error which would be caused by the varying rate of expansion of the mercury alone. Column 3 gives the corresponding temperatures indicated by a mercury thermometer made of flint-glass (*cristal de Choissy-le-Roi*), showing that this error is in part corrected by the unequal expansion of the glass bulb. Column 4 gives the corresponding temperatures indicated by a thermometer of crown-glass (*verre ordinaire de Paris*), showing that the indications of thermometers made with different varieties of glass do not necessarily accord. Finally, column 5, giving the coefficients of expansion of mercury at each temperature (250), is added, in order to show how rapidly the rate of expansion increases with the temperature.

It will be noticed that the thermometers agree perfectly at the two fixed points to which they are graduated. Moreover, between these two points the differences are comparatively small, since from the very method of graduation the errors are distributed; but above 100° the differences between the indications of the mercury thermometers and the true temperatures are continually increasing. The variations from the true temperature in the case of the theoretical thermometer without glass are very large. In the flint-glass thermometer the differences are less, because the varying rate of expansion of mercury is partially corrected by that of the glass. In the case of the crown-glass thermometer, there is a singular anomaly. This, on account of the remarkable law of expansion which crown-glass obeys, keeps nearly in accord with the air thermometer up to $246^{\circ}.30$, at which point it coincides with it; but above this point, at which they separate, the differences between the two rapidly increase. It will also be noticed, that the differences between the temperatures indicated by the thermometers of flint and crown glass are quite large; and it is evident that the last are greatly to be preferred in all scientific investigations. Smaller differences have been observed between thermometers made of varieties of crown-glass; but they are not of practical importance when neither of the varieties contains lead.

The facts just stated will be rendered clearer by Fig. 345, which is a geometrical construction of the results given in the

table on page 439. The figures on the horizontal line, or axis of abscissas, stand for the temperatures of an air thermometer; those on the vertical line, or axis of ordinates, for the differences

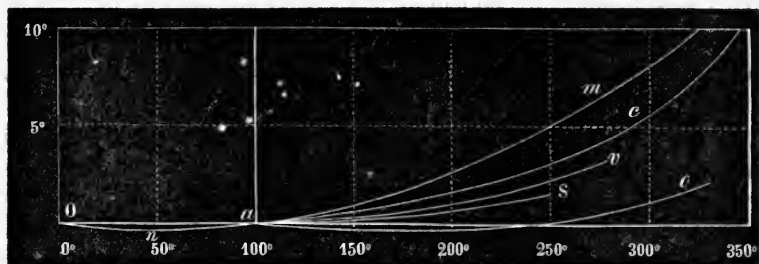

Fig 345.

between the indications of this thermometer and of different mercury thermometers. The curve $Onam$ shows the variations from the true temperature of the theoretical thermometer without glass; and the curves $Onac$, $Onav$, $Onas$, $Onao$, the variations of thermometers made with flint-glass of Choisy-le-Roi, green glass, Swedish glass, and "verre ordinaire de Paris," respectively. The anomaly in the case of the thermometer made with the common Paris glass is beautifully illustrated by the last curve.

(220.) *Change of the Zero Point.* — Mercury thermometers, even when constructed with the greatest care, are liable to error from another cause, which cannot be so easily explained as the one just considered. The zero-point of the thermometer frequently rises on the scale, the displacement amounting at times even to two degrees. By this is meant, that when the thermometer is surrounded by melting ice, as in Fig. 341, the mercury will not sink to the original zero, but only to a point possibly even two degrees above it. According to Despretz, this change may continue for an indefinite period; and it is therefore important to verify the position of the zero-point of a thermometer before using it in an observation where great accuracy is required. If the point has been displaced, the amount of the displacement must be subtracted from the observed temperatures.

Besides this slow rising of the zero-point, sudden variations in its position have been noticed after the thermometer has been exposed to a higher temperature. These variations are sometimes permanent, and at other times merely transient, the zero-point

returning to its original position after the instrument has been cooled for some time. All these facts tend to show, that determinations of temperature with a mercury thermometer are liable to sources of error which cannot always be guarded against; and it is therefore best, when great accuracy is required, to substitute for the mercury thermometer the air thermometer of Regnault, which will be described in a future section.

(221.) *Standard Thermometers.*—The causes of error in the mercurial thermometer already noticed arise from the very nature of the materials, and are inseparably connected even with such instruments as have been constructed with all the refinements of modern science. Ordinary thermometers are liable to errors of construction of a far greater magnitude. It is evident, from the theory of the instrument, that unless the bore of the tube has the same calibre throughout, equal increments in the volume of the mercury will not cause an equal rise of the column in all its parts; and the indications of the instrument, graduated in the usual way, will be more or less erroneous. Now it is seldom, and probably never, the case, that a thermometer-tube has an absolutely uniform bore. Hence, in making a standard instrument, it is essential that the tube should be *calibrated* throughout, and the size of the degrees proportioned to the varying diameter of the tube. This is done by introducing a short column of mercury into the tube, gradually moving it from one end to the other by means of a small elastic bag tied to the open mouth, and dividing the tube into lengths equal to the lengths of the mercury-column. This length is taken so short that the diameter of the tube may be assumed, without appreciable error, not to vary throughout the short distance; and when the tube is graduated, each of these lengths is divided into the same number of equal parts.

Regnault, who has very greatly improved the methods of graduating standard thermometers, uses for the purpose a dividing engine, similar to the one represented in Fig. 346, which is constructed by M. Duboscq, of Paris. It consists of the iron frame *A Q*, in which is mounted the long steel screw *H*. This screw is confined at its two ends by brass collars, in which it turns freely. On the top of the iron frame moves the carriage *B*, to which the tube to be divided is fastened. Motion is communicated to this carriage by the screw *H*, which plays through a

socket fastened to the under side, and therefore invisible in the drawing. By turning the screw, the carriage *b*, and the tube fastened upon it, are moved forward under the graver, *a*, which

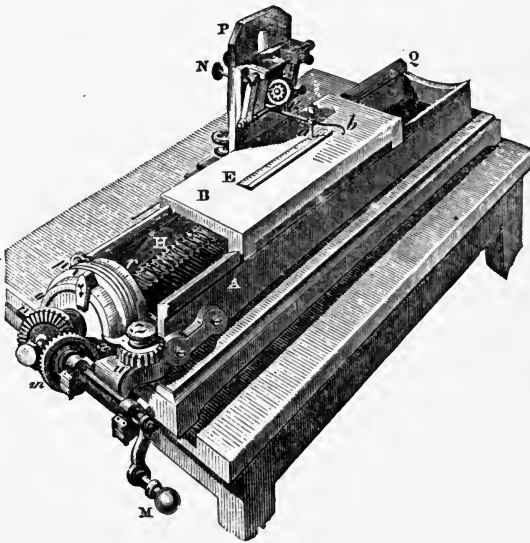

Fig. 346.

is attached to a very ingenious apparatus for regulating the lengths of the division-lines, making every fifth and tenth line longer than the rest. This dividing apparatus is supported on the upright piece of iron, *P*, which is itself firmly fastened to the frame of the engine.

The whole value of the apparatus depends on the long screw, which is made with great care, and its threads so adjusted that one revolution moves forward the carriage exactly one millimetre. Motion is communicated to the screw by the handle *M*, acting through the cogs *m* and *n* on the broad wheel *opr*, and this, in its turn, on a ratchet-wheel fastened to the head of the screw, and moving within the first. The wheel *opr* can revolve in one direction independently of the ratchet-wheel and the screw; but when turned in the opposite direction, a small detent, fastened to the inner surface of its rim, catches in the teeth, and moves the ratchet-wheel and screw with it. The rim of the wheel *opr* is divided on both sides into degrees, and by means of a set of stops its motion can be limited to any number of rev-

olutions, or to any fraction of a revolution. Let us suppose that the stops are so adjusted that the wheel opr can turn through two revolutions and $\frac{54}{1000}$. Starting, then, from the first stop, and turning the handle M until the motion is arrested by the second stop, the screw H will be revolved twice and $\frac{54}{1000}$. Consequently, the carriage B will be moved forward 2.54 millimetres. On now turning the handle M in the opposite direction, the wheel opr will be turned back to its first position, without moving the screw, and then, on reversing the motion, the carriage will be moved forward 2.54 m. m., as before, and so on indefinitely. If at each advance we make a mark with the graver, a , it is evident that our tube will be divided into lengths of 2.54 m. m., or into any other lengths for which we may choose to adjust the stops.

This engine may also be used for measuring the length of divisions already made; only for this purpose a small microscope, furnished with cross-wires, should be attached to the upright, P , at the side of the graver. The microscope having been adjusted so that the cross-wire is just over the first mark on the tube, and the stops which limit the motion of the wheel opr having been removed, the handle M is turned until the cross-wire is exactly over the second mark, the observer carefully noting the number of revolutions and fraction of a revolution required, by means of an index provided for the purpose. Let us suppose 10.75 revolutions are required; then, evidently, the length of the division is 10.75 millimetres.

In using the dividing engine for calibrating a thermometer, the tube is adjusted on the carriage B so that its axis shall be perfectly parallel to the axis of the long screw H . A short column of mercury having been previously introduced into one end, the length of this column is carefully measured as just described, and the position of its two extremities marked with a fine hair-pencil on the tube. Adjusting the cross-wire of the microscope to the head of the mercury-column, this is next pushed forward in the tube through exactly its own length. The length is again measured, and the position of the head of the mercury-column having been marked as before, the same process is repeated until the tube is divided into lengths of equal capacity, and their value known. Each of these lengths is next to be divided into the same number of equal parts, and any convenient number is selected, which shall give to the degrees as nearly as

possible the size required. In order to illustrate the method, let us suppose that the lengths between the pencil-marks are respectively as follows:—

18.45 m. m., 18.39 m. m., 18.32 m. m., 18.24 m. m., 18.15 m. m.,

and that it is decided to divide each length into thirty degrees. The lengths of the degrees in the different divisions will then be, respectively,

0.615 m. m., 0.613 m. m., 0.611 m. m., 0.608 m. m., 0.605 m. m.

This calculation having been made, the tube is covered with a varnish such as is used in etching, and the stops on the wheel *op r* (Fig. 346) so adjusted as to limit its motion to 0.615 of one revolution. The point of the graver is also adjusted to the first pencil-mark, and a cut made through the varnish, exposing the glass. The handle *M* is now turned until its motion is arrested by the stop, and another cut made. The motion of the handle having been reversed, the same process is repeated thirty times, when the point of the graver will have reached the second pencil-mark, and thirty degrees, each 0.615 m. m. in length, are marked on the tube. The adjustment of the stop must now be changed, so as to limit the motion of the wheel to 0.613 of a revolution, and thirty more divisions made; and so on until the graduation is completed, when the tube is removed from the engine, and the figures which serve to number the divisions are marked in with the hand. It only remains, now, to expose the tube to the vapor of fluohydric acid, which corrodes the glass wherever the graver has exposed its surface, and subsequently to verify the work by passing another column of mercury through the tube. This should cover the same number of divisions in any position, and will do so if the graduation has been carefully performed.

The stem of the thermometer thus adjusted, a bulb is blown upon the end, or, what is better, a cylindrical reservoir previously prepared is cemented to it with a blowpipe. The capacity of this reservoir must be proportional to the size of the tube, and to the range of temperature which the thermometer is intended to cover. Let us suppose that it is required that *N* divisions of the thermometer should correspond to 100° C., and we wish to know what must be the size of the reservoir for a given graduated tube. We first weigh the tube, both when empty and when con-

taining a column of mercury which covers an observed number of divisions. This gives us the weight of mercury, w , occupying n divisions of the tube. From this we obtain $N \frac{w}{n}$, the *weight* of mercury which will fill N divisions, and by [56] $N \frac{w}{n (\text{Sp. Gr.})}$, the corresponding *volume*. But this volume represents the expansion which the mercury in the reservoir of our proposed thermometer must undergo when heated from 0° to 100° . Now we know that the apparent expansion of mercury, under these circumstances, is $\frac{1}{5}$ of its volume at 0° . Representing, then, by V the unknown volume of the reservoir, we shall have

$$\frac{V}{65} = N \frac{w}{n (\text{Sp. Gr.})}, \quad \text{and} \quad V = 65 N \frac{w}{n (\text{Sp. Gr.})}. \quad [155.]$$

If the reservoir is spherical, $V = \frac{1}{6} \pi D^3$, from which we can calculate the required diameter; and if it is cylindrical, $V = \frac{1}{4} \pi D^2 h$, from which we can approximatively determine the required length, h , when the diameter is known.

The tube and bulb are now filled with perfectly pure mercury, and the fixed points marked upon it in the usual way, when the thermometer is finished and ready for use. The divisions marked upon a thermometer so constructed are not, of course, degrees of either of the three scales mentioned in (218); but it is always easy to calculate from the indications of this arbitrary scale the corresponding degrees of the Centigrade scale. We ascertain, by observation, the number of divisions on the thermometer between the freezing and boiling points, which we may represent by N , and also the number of the divisions on the arbitrary scale corresponding to the freezing-point (the zero of the Centigrade scale). Represent this number by n , the degrees of the Centigrade scale by C° , and those of the arbitrary scale by A° . We have, then, $N = 100^\circ \text{ C.}$, and $C^\circ = \frac{100}{N} (A^\circ - n)$: Suppose, for example, that there are 354 divisions on the arbitrary scale between the fixed points, and that the freezing-point is at the 132d division from the bottom of the scale; and let it be required to determine to what temperature the 230th division corresponds in Centigrade degrees. We shall have, $C^\circ = \frac{100}{354} (230 - 132) = 27.68$. It is usual to prepare a table for each thermometer thus constructed, giving the temperature in Centigrade degrees corresponding to every division of the tube.

The scale of a standard thermometer should always be engraved on the glass stem, as in Fig. 347; since, if it is engraved on a strip of metal or ivory fastened to the tube, the expansion of the scale introduces new sources of error into the instrument. It is also essential for a good standard, that it should include the boiling and freezing points upon its scale. Where a large range is required, the great length which this involves may be best avoided by making several thermometers with continuous scales, and enlarging the tube of each instrument at those parts which are covered by the scales of the other thermometers of the set. A thermometer so constructed is represented in Fig. 348, although the enlargement is very greatly exaggerated. It is possible in this way to divide each Centigrade degree into twenty parts, and yet include both of the fixed points on the scale.

The length of the degrees of a thermometer, and hence its sensibility to small differences of temperature, depends upon the size of the reservoir as compared with that of the tube, and can be increased by the maker at pleasure. No advantage, however, is gained by increasing the length of the degrees on the stem beyond a limited extent; since, on account of the imperfections of the instruments noticed in the last section, it is useless to subdivide the Centigrade degree into more than twenty parts, and only the most carefully constructed standards will bear as great a subdivision as this. Even when the scale is graduated to twentieths, it is possible for a practised eye to estimate the hundredth of a Centigrade degree.

It is evident that the smaller the absolute size of the bulb, the more rapidly a thermometer will be affected by changes of temperature; and hence it is always best to make the bulb as small as circumstances will permit, and also to give to it a long cylindrical shape, which, for the same volume, exposes a much greater surface for the entrance of heat than a sphere.

The size of the column of mercury in the stem of a thermom-

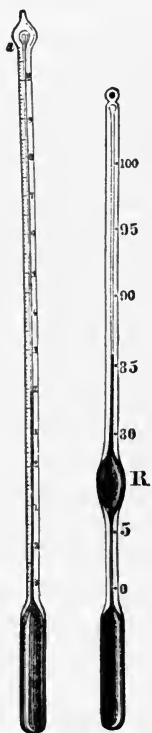

Fig. 347. Fig. 348.

eter is so small, as compared with that of the stem itself, that it is essential, in order to avoid the parallax caused by the thickness of the glass, to place the eye in reading on a level with the surface of the column. The scale of a delicate thermometer is always best read through the telescope of a cathetometer (Fig. 260), placed at a sufficient distance to prevent the heat of the body from affecting the instrument.

(222.) In using a standard thermometer, it is important to immerse both the bulb and the stem in the medium whose temperature is to be measured; for if the stem of the thermometer is exposed to a lower temperature than the bulb, the whole of the mercury will not be equally expanded, and the thermometer will indicate too low a temperature. Since in testing the temperature of a small quantity of liquid this complete immersion of the thermometer is impossible, it is necessary in such cases to add to the observed temperature a small correction, which becomes very important when the temperature of the medium greatly exceeds that of the air.

In order to illustrate the method of calculating the correction, let us suppose that the thermometer is used for testing the temperature of an oil-bath; and that, while the bulb and a portion of the stem are immersed, the greater part of the mercury-column is above the surface of the liquid, as represented in Fig. 401. It is now required to determine how much higher the thermometer would stand if the whole column were exposed to the same temperature as the bulb. For this purpose, we will represent the different quantities entering into the calculations as follows:—

- x = the unknown temperature of the bath.
- t° = the temperature indicated by the thermometer.
- t_1° = the mean temperature of the mercury in the stem, ascertained by placing in contact with it the bulb of a small thermometer at about mid-height of the column.
- θ = the number of degrees which the portion of the mercury-column above the surface of the bath occupies in the thermometer-tube.
- $t^{\circ} - t_1^{\circ}$ = the difference of temperature between the bulb and the stem approximatively.

It is evident that, if the temperature of the mercury above the surface of the bath were increased $t^{\circ} - t_1^{\circ}$, the thermometer

would indicate the true temperature; so that, to find the correction required, we have only to calculate how much a column of mercury measuring θ degrees on the scale will increase in length when its temperature is raised $t^\circ - t_1^\circ$. The apparent expansion in glass of a given volume of mercury, amounting for each degree of temperature to $\frac{1}{6380}$, will amount for $t^\circ - t_1^\circ$ to $\frac{t^\circ - t_1^\circ}{6380}$ of the whole. Hence, a quantity of mercury which fills one degree of a thermometer-tube will fill $1 + \frac{t^\circ - t_1^\circ}{6380}$ degrees of the same tube after its temperature has risen $t^\circ - t_1^\circ$; and in like manner a quantity of mercury which fills θ degrees of a thermometer-tube will fill, after the same rise of temperature, $\theta + \frac{\theta(t^\circ - t_1^\circ)}{6380}$ degrees. In other words, the column of mercury above the surface of the bath would rise $\frac{\theta(t^\circ - t_1^\circ)}{6380}$ degrees, if its temperature were raised to that of the bath. This, then, is the correction required, and we have, in any case,

$$x = t^\circ + \frac{\theta(t^\circ - t_1^\circ)}{6380}. \quad [156.]$$

Since the mean temperature of the mercury-column can never be accurately determined, there is always an uncertainty in regard to the value of the correction; and it is therefore best, when practicable, to avoid the necessity of any by immersing the whole stem in the bath.

(223.) A thermometer indicates temperature by either receiving or imparting heat until its own temperature is the same as that of the body tested. It is therefore evident that, unless the temperature of the body is maintained constant by accessions of heat from some external source, a thermometer will give correct indications only when its own mass bears a very inconsiderable proportion to that of the body. This very obvious fact must be carefully borne in mind while using the instrument; and when the quantity of heat which the thermometer receives or imparts is appreciable, the change of temperature which is thus caused in the body must be calculated, and the observations corrected accordingly. The student will be able to devise methods by which the correction can in any given case be estimated, after studying the sections on Specific Heat.

For further information in regard to the construction and use of

standard thermometers, we would refer the student to the volume of memoirs of Regnault already noticed, and to a note by J. I. Pierre, published in the *Annales de Chimie et de Physique*, 3^e Serie, Tom. V. p. 428.

(224.) *House Thermometers.* — The scales of ordinary thermometers are graduated on strips of wood, metal, or ivory, to which the tube is subsequently attached (Fig. 349). Such thermometers are less fragile and more easily read than those graduated on the stem, and at the same time are sufficiently accurate for determining the temperature of a bath or of a room, and for most meteorological observations. They are not, however, usually graduated from the two fixed points, as described in (218), but by comparison with a standard thermometer. For this purpose, the instrument to be graduated and the standard are dipped together into a bath of water. Care being taken to maintain the water at the same temperature for some time, the number of degrees indicated by the standard is then marked on the stem of the new instrument at the level of the mercury-column. In the same way, by changing the temperature of the bath, several other points are determined. These are subsequently transferred to the strip on which the scale is to be engraved, and the distance between them divided into the number of degrees required.

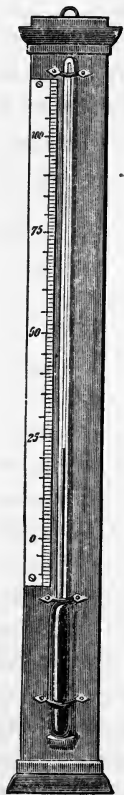

Fig. 349.

It has been found almost impossible to maintain a liquid bath at the same temperature in all its parts for any length of time, when this temperature considerably exceeds that of the air; so that we cannot be certain that two thermometers, dipped into the bath side by side, have been exposed to exactly the same degree of heat. The method of graduation just described ought, therefore, never to be used for an instrument of precision; but it is sufficiently accurate for common house thermometers. These instruments, when well made, may be relied upon to within a Fahrenheit degree between the two fixed points; but beyond these points, and especially below the freezing-point, they are frequently very erroneous. Two thermometers hanging side by side, which have been made by the best

makers with their usual care, will not unfrequently differ several degrees when the temperature is below 0° F., — a fact which accounts for the great discrepancies in the observations of low temperatures.

(225.) *Thermometers filled with other Liquids.* — Mercury boils at 360° C. and freezes at -40° , and the range of a mercury thermometer is necessarily confined within these limits of temperature. Moreover, near its freezing-point the rate of expansion of mercury becomes very irregular, and its indications cannot be relied upon below -36° , or even -35° C. Degrees of temperature above 360° are measured by means of a class of instruments called *pyrometers*, which will be described in connection with the laws of expansion of solids and gases; while for temperatures below -35° , we use thermometers filled with alcohol, or other liquids which do not freeze even at these great degrees of cold.

There is no other liquid which can be compared with mercury in its fitness for filling thermometers. The great range of temperature between its freezing and boiling points, the fact that it does not adhere to the surface of glass, and that it can readily be obtained perfectly pure, are all circumstances which peculiarly adapt it to thermometric purposes. It is true, as we have seen, that the rate of its expansion increases with the temperature; still, between the two fixed points the change is so slight that the indications of the thermometer are not perceptibly affected by it. This is not true of thermometers filled with any other liquid. Such thermometers, when graduated on the same principle as the mercury thermometer, give results which are entirely at variance both with it and with themselves. For example, Deluc obtained the following comparative results with thermometers filled with mercury, oil, alcohol, and water. The numbers in the same vertical column of the table are the temperatures indicated by these several thermometers when immersed in the same bath.

Mercury,	-12.5	-6.25	0	25.0	50.0	75.0	100
Oil,			0	24.1	49.0	74.1	100
Alcohol,	-9.6	-4.90	0	20.6	43.9	70.2	100
Water,			0	5.1	25.6	57.2	100

Similar results were also obtained by M. Pierre, in his very extended investigation of the expansion of liquids, during which he compared thermometers containing twelve different liquids with the mercury thermometer. As is shown by the above table, he found the water thermometer the most defective. Thermometers filled with alcohol or with sulphide of carbon gave less erroneous results; but of all the liquids he examined, common ether, chloride of ethyle, and bromide of ethyle, were least irregular in their rate of expansion, and are therefore best adapted, after mercury, for filling thermometers.

Nevertheless, alcohol thermometers are generally used for measuring very low temperatures. They are graduated by comparison with standard mercury thermometers, in the way described in the last section, taking care to have a large number of points of comparison, which should be as near together as possible. But even when graduated with the greatest care, such thermometers do not give indications which accord with each other, or with a mercury thermometer. Captain Parry, in his Arctic voyages, observed differences of 10° C. between alcohol thermometers of the best makers; and similar facts were noticed both by Franklin and by Kane. These discrepancies unquestionably originated in part from the impurity of the alcohol, or from other errors of construction; but they are also, to a certain degree, inherent in the thermometer itself. An accurate instrument for measuring low temperatures is still one of the great desiderata of science.

(226.) *Maximum and Minimum Thermometers.* — It is frequently desirable to have the means of determining, without the aid of an observer, the highest or lowest temperature which has occurred during the night, or any other interval of time; and for this purpose a great variety of self-registering thermometers have been invented. One of the simplest is that of Rutherford (Fig. 350). This consists of two thermometers, fastened to a plate of wood, or some other material. The tubes of the thermometers are bent at right angles just above the bulbs, as represented in the figure, and the instrument when in use is suspended by a cord, so that the two stems shall be in a horizontal position. The upper thermometer is filled with mercury, and in front of the mercury-column a short piece of iron wire is placed in the tube (seen at *A*), which is pushed forward by the mercury and left at the highest point which the column reaches, thus indi-

cating the maximum temperature. The lower thermometer is filled with alcohol, and the tube contains a small enamel cylinder (seen at *B*), surrounded by the liquid. As the alcohol expands, it readily passes by the enamel cylinder; but when it contracts,

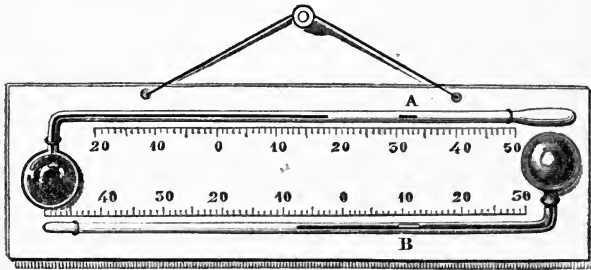

Fig. 350.

the cylinder is drawn back with the receding column, and left at the lowest point, indicating the minimum temperature during the same period. After each observation, the enamel cylinder is brought to the end of the alcohol-column by inclining the instrument; and in like manner the iron wire is restored to the end of the mercury-column by means of a magnet.

The iron wire in the tube of Rutherford's maximum thermometer is liable to become immersed in the mercury, if the instrument is not carefully handled; and when this accident occurs, it is very difficult to remedy the evil without refilling the tube. Negretti and Zambra have invented a maximum thermometer which is not open to the same objections. Between the bend *d*

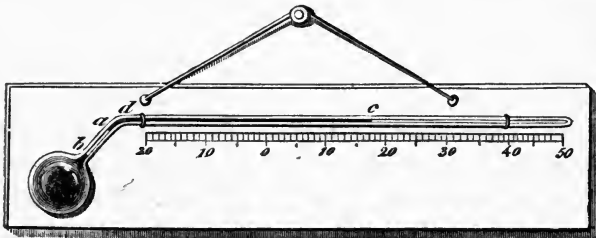

Fig. 351.

and the bulb (Fig. 351) they insert into the tube of the thermometer a small rod of glass, *a b*, which nearly fills the bore. When the mercury expands, it pushes by this obstruction; but when it contracts, the column breaks, leaving the head of the

column at the highest point it had attained. On turning the thermometer, so that its stem shall have a vertical position, the mercury readily passes back to the bulb, in virtue of its weight.

Walferdin's maximum thermometer is represented in Fig. 352. It is made like an ordinary mercury thermometer, only the upper



Fig. 352.

part of its stem is surrounded by a reservoir containing mercury, which is so arranged that, when the instrument is inverted, the end of its tube dips under the mercury in the reservoir. No graduation on the stem is necessary; but before the instrument is to be used, the bulb must be heated until the mercury overflows the end of the tube. It is then inverted; when, on cooling, the mercury rises from the reservoir by mechanical adhesion, completely filling the stem. If the thermometer is now replaced in position, its bulb and tube being full of mercury, it is evident that, as the temperature rises, the mercury will gradually flow over from the tube into the reservoir; and when the temperature subsequently falls, the mercury, contracting, will leave an empty space at the top of the tube. The highest temperature to which the instrument has been exposed is, then, that at which the mercury remaining in the bulb and stem just fills them both completely; and this can be ascertained by comparison with a standard thermometer, placing both in a water-bath, gradually heating it, and observing the temperature indicated by the standard when the mercurial column reaches the top of the stem.

The same principle has been applied by Walferdin for measuring very small differences of temperature. The thermometer for this purpose may be constructed in precisely the same way, only it is made extremely sensitive, so that an expansion corresponding to four Centigrade degrees would raise the mercury-column through the whole length of the stem. The stem is, moreover, very carefully graduated into parts of equal capacity, each division corresponding to a very small fraction of a degree. To show how this thermometer is used, let us suppose that we wish to observe the temperature at which water boils under different atmospheric pressures, where the whole possible variation is between 101° and 98° . We should, in the first place, expose the instrument to a temperature of 101° ,

as indicated by a standard thermometer, and wait until the excess of mercury had overflowed into the upper reservoir. On now allowing the temperature to fall, the mercury-column will rapidly sink in the tube, and at 97° will already have receded into the bulb. The thermometer is now in condition to measure with great accuracy differences of temperature between 98° and 101° ; and in like manner it may be adjusted to any other range of four degrees. If, for example, the division on the stem correspond to thousandths of a Centigrade degree, and we observe a difference in the boiling-point of water under two different pressures equal to fifteen of these divisions, we conclude that the temperature is 0.015 of a degree higher in one case than in the other. Since the quantity of mercury which forms the thermometer differs with the range of the instrument, it is evidently necessary to determine the value, in fractions of a Centigrade degree, of one of its divisions after each adjustment. The form of reservoir represented in Fig. 352 is difficult to make, and there is generally substituted for it a simple enlargement of the upper end of the tube, as represented in Fig. 353. The neck of the bulb *B* is strangled at *C*, so that a slight tap given to the tube while the instrument is cooling causes the column to break at that point, leaving the excess of mercury in the bulb.



Fig. 353.

THERMOSCOPES.

(227.) *Air Thermometers.* — The name thermoscope ($\theta\acute{\epsilon}\rho\mu\eta$, $\sigma\kappa\omicron\pi\acute{\epsilon}\omega$) is a convenient designation for a class of instruments which are used chiefly for detecting slight changes of temperature, and not, like the thermometer ($\theta\acute{\epsilon}\rho\mu\eta$, $\mu\acute{\epsilon}\tau\rho\nu$), for determining its value in degrees. In a large number of thermoscopes, these variations are indicated by the change in volume of confined air, which not only expands very regularly and quickly, but also to a very much greater degree than liquids, for the same increase of temperature. Such instruments are frequently called air thermometers; but they must not be confounded with the air thermometer of Regnault, which gives the most accurate measures of temperature that we can attain.

The air thermometer represented in Fig. 354 is ascribed to Sanctorius, an Italian philosopher of the seventeenth century, and is supposed by some to have been the first instrument used for measuring temperature. It consists of a bulb and tube, whose extremity rests in an open vessel containing colored water, which



Fig. 354.



Fig. 355.

also partially fills the tube. When the bulb is heated, the liquid falls in the tube, and rises when the bulb is cooled. The tube is generally fastened to an upright piece of wood, on which a scale of equal parts is painted. In another form of the same instrument (Fig. 355), the expansion of the air is indicated by the motion of a drop of colored liquid in the stem at *A*. These instruments are evidently affected by the varying pressure of the atmosphere, and are necessarily imperfect.

The same objection does not apply to the differential thermometer of Leslie, used by him in his experiments on the radiation of heat. This consists (Fig. 356) of two bulbs connected together by a glass tube bent twice at right angles. The bulbs contain air, and the connecting tube is half filled with colored liquid, which, when the thermometer is at rest, stands at the

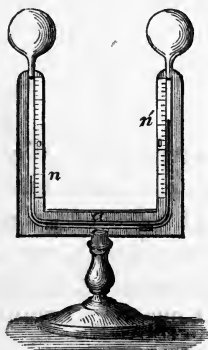

Fig. 356.

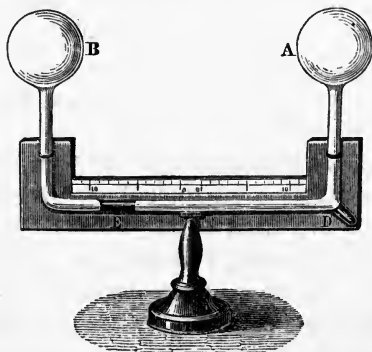

Fig. 357.

same height in the two limbs of the sipnon, and remains in this position so long as the two bulbs are equally heated. Any difference in the temperature of the two bulbs, however, is at once indicated, as represented in the figure, by a difference of level in

the two liquid columns, and can be measured by means of the scales painted on the wooden frame which supports the tube. This is the only thermoscope, of its class, of any scientific value. In a limited number of cases it furnishes an instrument of great utility and delicacy, and its indications are comparable with each other.

Rumford's differential thermometer (Fig. 357) is merely a slight variation of Leslie's, the difference in the temperature of the two bulbs being indicated by the motion of a drop of sulphuric acid along the horizontal tube, which is made somewhat longer than in Leslie's instrument, and surmounted by a scale of equal parts. There are several other forms of air thermometers, but they are not of sufficient importance to require notice.

(228.) *Thermo-multiplier*.—But of all instruments for detecting and measuring slight differences of temperature, by far the most delicate and accurate is the thermo-multiplier of Nobili and Melloni. The principle on which this instrument is based was discovered by Seebeck, of Berlin, in 1822, and may be briefly stated thus.

If two metallic bars, of different crystalline texture and unequal conducting powers, are united at one end by solder, and the point of junction heated, a current of electricity is excited, which flows from the point of junction towards the poorer conductor. Thus, if the junction of two bars of bismuth and antimony (Fig. 358) is heated, and their free ends are connected by wires, the current flows from the antimony to the bismuth at the junction, and from the bismuth to the antimony on the conducting-wire connecting the free ends of the bars. If cold, instead of heat, is applied to the junction, a current is also established, but in the opposite direction. Similar results can be obtained with other metals, which may be arranged in a thermo-electric series in the following order: bismuth, platinum, lead, tin, copper or silver, zinc, iron, antimony. The most powerful combination is formed of those metals which are most distant from each other in the list, and in every case, when the junction is heated, the current flows through the conducting-wire from those which stand first to those which stand last.

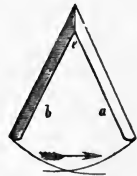

Fig. 358.

The most powerful current is produced, as the above series

shows, by the combination of bismuth and antimony; but a single pair of bars, even of these metals, produces only a very feeble effect. The force of the electric current can, however, be very greatly increased by uniting together several pairs of these bars, as represented at *a b*, Fig. 359, and connecting together the free end of the first bismuth bar with that of the last antimony bar. Such an arrangement is called a *thermo-electric pile*. Since the

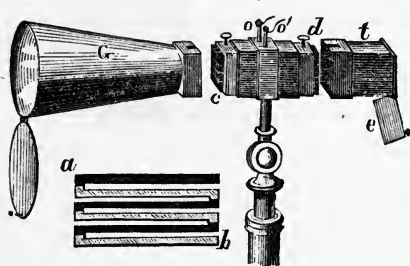

Fig. 359.

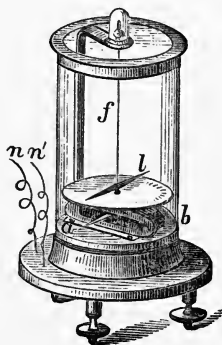

Fig. 360.

force of the current is not found to depend on the size of the bars, they may be made very small; in Melloni's thermo-multiplier thirty pairs of bismuth and antimony bars are packed away in the small brass case, *c d*, Fig. 359, not more than two or three centimetres long. The soldered ends of these pairs, called the *faces of the pile*, are seen at *c* and *d*; and the two cups, *o*, *o'*, called the *poles of the pile*, are directly connected with the free ends of the two terminal bars. Finally, the faces of the pile are protected from any lateral action by a brass cap, *t*, blackened inside, and having a movable screen, *e*, in front, or by a brass cone polished on its interior surface, which serves to concentrate the rays of heat.

When the two faces of the thermo-electric pile are equally heated, no electrical disturbance results; but the slightest difference of temperature causes a flow of electricity through the wire connecting the two poles. The direction of the current is determined by the relative positions of the bars, always following the rule stated above. The force of this current, although much greater than that of the current from a single pair of bars, is still feeble, and can only be detected by a very delicate galvanometer. This instrument will be described in detail hereafter.

It is sufficient, for the present, to state that it is an application of the remarkable facts discovered by Oersted in 1820. This eminent physicist observed, that, if a conducting-wire through which an electric current is passing is placed directly over and parallel to a magnetic needle (Fig. 361), the north pole of the needle is deflected to the right or to the left, according to the direction of the current. If the conducting-wire is placed under the needle, it is also deflected, but in the opposite direction. Hence, if the conducting-wire is formed into a loop, and placed around the needle, and at the same time parallel to it, in such a manner that the current may flow from north to south above the needle, and from south to north below it, the two portions of the wire will conspire to deflect the needle, and the effect of one and the same current will be doubled. By turning the wire again round the needle, the effect of the same current will be quadrupled, and by repeating the turns, as in Fig. 362, the deflecting force may be multiplied to a very great extent; and thus the deflections of a magnetic needle may become the means of detecting a very feeble electric current. The galvanometer represented in Fig. 360 is a direct application of this principle. The conducting-wire, which is covered with silk, is wound round the ivory frame *ab* a great number of times, and terminates at the two ends, *n, n'*. The magnetic needle is suspended, so as to oscillate freely within the ivory frame, by means of a single strand of raw silk, *f*; and when at rest, its axis is parallel to the turns of the conducting-wire. Parallel to the first needle, and immovably connected with it, is a second needle, *l*, which oscillates just above a graduated arc, and thus indicates the amount of deflection. This needle also serves another purpose. Its north pole is placed directly over the south pole of the first needle, and, both being of equal force, the action of the earth's magnetism on one is balanced by its action on the other. A needle so arranged is termed

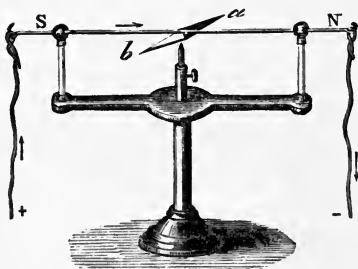

Fig. 361.

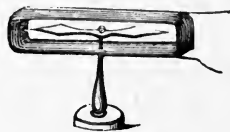

Fig. 362.

Parallel to the first needle, and immovably connected with it, is a second needle, *l*, which oscillates just above a graduated arc, and thus indicates the amount of deflection. This needle also serves another purpose. Its north pole is placed directly over the south pole of the first needle, and, both being of equal force, the action of the earth's magnetism on one is balanced by its action on the other. A needle so arranged is termed

astatic, and will remain in any position in which it may be placed. Moreover, the action of an electric current upon it is not influenced by the magnetism of the earth. The graduated disk just referred to rests on the ivory frame, and is made of copper, which has the effect of deadening the oscillations of the needle. When in use, the two poles of the thermo-electric pile (o, o' , Fig. 359) are connected with the ends (n, n' , Fig. 360) of the conducting-wire, which is wound round the frame of the galvanometer.

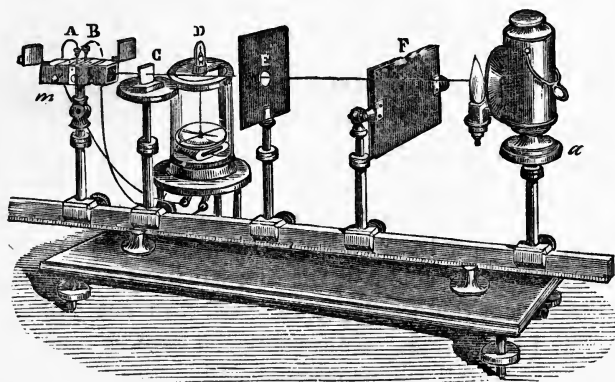

Fig. 363.

The apparatus is so delicate, that the heat of the hand, placed several feet in front of the conical cap G , will be at once perceptible, by deflecting the needle. Moreover, when the deflection is not greater than twenty degrees, the angle of deviation is proportional to the difference of temperature between the faces of the pile, and may therefore be used as a measure of the intensity of the calorific effect produced on one face when the other is exposed to a constant temperature. Beyond twenty degrees, the angle of deviation is no longer proportional to the temperature; but a table can be easily constructed for each instrument, in which, for each degree of deviation, are given the corresponding differences of temperature of the two faces. Melloni does not extend these tables beyond thirty-five degrees, because the slightest change in the position of the axis of suspension of the needle would cause a great error in its indications. A deflection of thirty-five degrees corresponds to a difference of from six to eight degrees in the temperature of the two faces of the pile. The instrument, as mounted for use, with its various screens and appendages, is represented in Fig. 363.

PROBLEMS.

Thermometers.

272. It is required to change into Fahrenheit and Reaumur degrees the following temperatures in Centigrade degrees:—

Temperature of maximum density of water,	+ 3°.87 C.
Boiling-point of liquid ammonia,	—40
“ “ sulphurous acid,	—10
“ “ alcohol,	+75
“ “ phosphorus,	290
“ “ mercury,	360

273. It is required to change into Centigrade and Reaumur degrees the following temperatures in Fahrenheit degrees:—

Melting-point of mercury,	—40° F.
“ “ bromine,	— 4
“ “ white wax,	+158
“ “ sodium,	194
“ “ tin,	442.4
“ “ antimony,	771.8
Incipient red heat,	977
Clear cherry-red heat,	1,832
Dazzling white heat,	9,732

274. How many degrees Centigrade and Reaumur are n° Fahrenheit?

275. How many degrees Fahrenheit and Reaumur are n° Centigrade?

276. At what temperatures do $-x^\circ$ C. equal $-x^\circ$ F.? $-x^\circ$ R. equal $-x^\circ$ F.? $-x^\circ$ C. equal $+x^\circ$ F.? and $-x^\circ$ R. equal $+x^\circ$ F.?

277. The boiling-point was marked on the stem of a mercurial thermometer when the barometer stood at 74.65 c. m.; the distance between this point and the freezing-point, previously determined, was found to be 21.54 c. m. It is required to determine the position of the true boiling-point on the stem with reference to the first.

278. Solve the same problem, representing the height of the barometer by H , and the distance between the freezing-point and the boiling-point by l .

279. In order that a mercurial thermometer may measure temperatures between -40° and $+300^\circ$, how many times must the capacity of the bulb be greater than that of the tube?

280. A thermometer-tube was divided into 1,500 parts of equal capacity, as described in (221). It was then weighed, first when empty, and afterwards when containing a quantity of mercury occupying 73 divisions. The difference of these weights was 0.008 grammes. It is desired that the distance between the fixed points should be divided into about 1,000 parts, and it is required to find the volume of the reservoir

necessary to effect this object. If the reservoir is spherical, what must be its diameter? If it is cylindrical, what must be its length, assuming that its diameter is 0.52 c. m.?

281. After the thermometer of the last problem was made, it was found that the zero-point corresponded to the 230th division from the bottom of the scale, and the boiling-point to the 1,223d. To what temperature does the 765th division correspond? Prepare a table giving the temperature in Centigrade degrees corresponding to every tenth division on the tube.

282. A thermometer was graduated with an arbitrary scale, as above; the zero-point was subsequently found to coincide with the 56th division, and the boiling-point with the 245th division of this scale, when the barometer stood at 74.25. It is required to prepare a table, giving the temperature in Centigrade degrees corresponding to each division of the scale.

283. The temperature of an oil-bath was observed with a mercury-thermometer graduated to Centigrade degrees to be 260° ; the portion of the mercury-column in the stem not immersed occupied 190° , and the mean temperature of this column was 94° . Required the true temperature of the bath.

284. When the thermometer of problem 281 was immersed in an oil-bath, the mercury rose to the 500th division of the scale; the portion of the mercury-column in the stem not immersed occupied 390 divisions, and its mean temperature was $8^{\circ}.4$. Required the true temperature of the bath.

285. Reduce the following temperatures, observed with a mercury-thermometer made of crown-glass, to degrees of the air-thermometer: 260° , 180° , 230° , 200° , 300° , and 320° .

286. The coefficient of expansion of glass for one Centigrade degree is 0.000088482. How great is it for one Fahrenheit degree? How great for one Reaumur degree?

287. The French unit of heat is the amount of heat required to raise the temperature of one kilogramme of water from 0° C. to 1° C.; the English unit is the amount of heat required to raise the temperature of one avoirdupois pound of water from 59° F. to 60° F. What is the relation between the two? (See table, p. 472.)

288. Convert into French units of heat 7.843; 234.62; and 52.796 English units.

289. Reduce to English units 52.34; 1,964.72; 0.6845; and 324.7 French units of heat.

290. Two thermometers are made of the same glass; the spherical bulb of the first has an interior diameter of 7.5 m. m., and its tube a diameter of 0.25 m. m.; the bulb of the second has a diameter of 6.2 m. m., and its tube a diameter of 0.15 m. m. Required the relative size of a degree on each.

SPECIFIC HEAT.

(229.) *Temperature.* — The amount of expansion which a hot body is capable of producing in the air or mercury of a thermometer measures what we term its temperature. This effect is only indirectly connected with the amount of heat which the body contains. If different masses of water, of mercury, of iron, or of wood produce each the same expansion in the air or mercury of the thermometer, we say that they all have the same temperature, although, as we shall hereafter see, they may contain very different amounts of heat. The thermometer, therefore, is an instrument for measuring the temperature of a body, and not the amount of heat which it contains. It gives us, though more accurately, the same kind of information as the sense of touch, indicating that condition of a body which produces the sensation of heat and cold. It gives that information which is alone wanted in the practical affairs of life; for it does not concern us generally, how much heat a body contains, but only what effect its heat will produce on our bodies.

The temperature of a body depends on two conditions: first, on the amount of heat which the body contains; secondly, on the affinity of the body for heat, or, in other words, on the power with which it holds the heat. In illustration of these principles, several well-known facts may be adduced. Two thermometers introduced, the one into a wine-glass and the other into a pail, each of which is filled with water just drawn from a well, will indicate the same temperature in both; simply because, although the water in the pail contains several hundred times as much heat as the water in the wine-glass, it also holds the heat with a proportionally greater force, and therefore gives up no more to the bulb of the thermometer than the smaller amount of water in the wine-glass. Again, two thermometers, introduced, the one into a glass containing a kilogramme of water, and the other into a glass containing a kilogramme of mercury, the glasses having been standing together for some time, will, in like manner, indicate the same temperature in both; for although, as will soon be shown, the water contains thirty times as much heat as the mercury, it holds it with thirty times as much power.

(230.) *Thermal Equilibrium.* — If, as is sometimes the case in a room, the heat is distributed through the different articles

of furniture in proportion to their affinity for the imponderable agent, it is evident that we shall have a condition of thermal equilibrium; for there will be no tendency for the heat to pass from one body to another. If we now bring a thermometer in contact with the various articles of furniture, we shall find that they all have the same temperature. Let us next suppose that the stove suddenly receives an accession of heat; we shall then find that it will indicate a higher temperature than before, because it is in a condition to impart more heat to the mercury of the thermometer. In the course of a short time, however, this accession of heat will be distributed in various ways through the different bodies in the room, in proportion to their relative affinities, when it will be found that all again have the same temperature, although a little higher than before. It therefore appears, first, that when bodies are at the same temperature they are in a state of thermal equilibrium; secondly, that when they are at different temperatures, the warmer will impart heat to the colder until an equilibrium of temperature has been established; that is, until the heat has been distributed through all in proportion to their relative affinities.

(231.) *Unit of Heat.* — In one condition only the thermometer becomes a direct measure of the amount of heat; and that is in the case of the same weight of the same substance. Thus, if we take one kilogramme of water, it is true that, if a given amount of heat will raise its temperature one degree, twice the amount of heat will raise its temperature two degrees, etc. Here, then, we have a unit for measuring amounts of heat; and it has been generally agreed to assume, as the *unit of heat*, the amount of heat required to raise the temperature of one kilogramme of water one Centigrade degree, in the same way that a metre has been taken as a unit of length, and a minute as a unit of time.

(232.) *Specific Heat.* — Assuming, then, this unit of heat, we shall be able to ascertain the relative amounts of heat which different substances contain at the same temperature, or, what amounts to the same thing, their relative affinities for heat. For this purpose, let us in the first place take two vessels, one containing one kilogramme and the other ten kilogrammes of water, and let us expose them both to such a source of heat that equal quantities of heat must enter each vessel during the same time. We

shall find that, when a thermometer in the first vessel indicates that the temperature of the one kilogramme of water has risen ten degrees, a thermometer in the second vessel will have risen only one degree. Since ten units of heat have, by our assumption, entered the water in each vessel, it follows that it requires ten times as much heat to raise the temperature of ten kilogrammes of water one degree as is required to raise the temperature of one kilogramme of water to the same extent. Similar results would be obtained with any other substance, and hence we may conclude that the amounts of heat required to raise the temperature of unequal weights of the same substance one degree, are proportional to these weights.

As a second experiment, we will take five vessels, containing respectively one kilogramme of water, one kilogramme of sulphur, one kilogramme of iron, one kilogramme of silver, one kilogramme of mercury, and we will expose them all to such a source of heat that equal amounts must enter each vessel during the same interval. If, now, we observe thermometers placed in these vessels, we shall find, when the temperature of the water has risen one degree and consequently when one unit of heat has entered each vessel, that the temperatures of the other substances have increased by the number of degrees given in the second column of the following table. By the principle just established, it follows that, if one unit of heat will raise the temperature of one kilogramme of mercury thirty degrees, it will only require one thirtieth as much, or 0.033 of a unit of heat, to raise the temperature of the same weight one degree. In like manner, the fractional parts of a unit of heat required to raise the temperatures of one kilogramme of each of the other substances one degree can be easily calculated, and are given in the third column of the table. This fraction is commonly called the *specific heat* of the substance.

	Temperature.	Unit of Heat.
Water,	1.0	1.000
Sulphur,	4.9	0.203
Iron,	8.8	0.114
Silver,	17.5	0.057
Mercury,	30.0	0.033

Water, then, at the same temperature, contains 4.9 times as

much heat as the same weight of sulphur, 8.8 times as much as the same weight of iron, 17.5 times as much as the same weight of silver, and 30 times as much as the same weight of mercury; and in like manner we should find that, at the same temperature and for equal weights, water contains more heat than any solid or liquid known. Hence, the specific heat of solid or liquid substances is always expressed by fractions. These fractions, as determined by Regnault for the chemical elements, are given in the following table. The numbers in each case denote the fractional part of a unit of heat required to raise the temperature of one kilogramme of the substance one degree. They also represent the relative proportions in which heat is distributed among equal weights of these substances when in the state of thermal equilibrium, and therefore indicate their relative affinities for the imponderable agent.

Specific Heat of the Elements.

Names of Substances.	Specific Heat.	Names of Substances.	Specific Heat.
<i>Preliminary Data.</i>			
Brass,	0.093910	Water,	1.008000
Glass,	0.197680	Oil of Turpentine, .	0.425930
<i>Elements.</i>			
Iron,	0.113790	Platinum plate, .	0.032430
Zinc,	0.095550	“ sponge, .	0.032930
Copper,	0.095150	Palladium,	0.059270
Mercury,	0.033320	Gold,	0.032440
Solid Mercury, . . .	0.032410	Sulphur,	0.202590
Cadmium,	0.056690	Selenium,	0.083700
Silver,	0.057010	Tellurium,	0.051550
Arsenic,	0.081400	Potassium,	0.169560
Lead,	0.031400	Bromine, liquid, .	0.110940
Bismuth,	0.030840	“ solid (—28°),	0.084320
Antimony,	0.050770	Iodine,	0.054120
Tin,	0.056230	Carbon,	0.241110
Nickel,	0.103630	Phosphorus,	0.188700
Cobalt,	0.106960		

(233.) *Determination of the Specific Heat of Solids and Liquids.* — There are two methods usually employed for this purpose. The first method is called the *method of cooling*,

and is based upon the axiom, that the time required for equal weights of different substances to cool through the same number of degrees, under exactly the same conditions, will be proportional to the quantity of heat which they respectively contain, or, in other words, to their specific heat. The only difficulty in applying this principle to practice consists in securing precisely the same conditions for all substances. In order to attain this object, Regnault contrived a very ingenious apparatus, which is described at length in the *Annales de Chimie et de Physique*, 3^e Série, Tom. IX. ; but notwithstanding the utmost precautions and most persevering efforts, this very skilful experimenter could not obtain satisfactory results by this method. We shall not, therefore, enlarge upon it here.

The second method, which is called the *method of mixture*, consists in heating a substance to a known temperature, and then throwing it into a vessel containing a known weight of cold water. The amount of heat communicated to the water will be proportional to the specific heat of the given substance, and gives us the data for calculating it. This last method, which is by far the most accurate of all the methods yet devised, requires further illustration.

Example 1. If we mix one kilogramme of mercury at 20° with one kilogramme of water at 0°, we shall find that the temperature of the mixture will be 0°.639. The water, therefore, has gained 0.639 of a unit of heat. This amount of heat, also, is evidently sufficient to raise the temperature of one kilogramme of mercury from 0°.639 to 20°, that is, through 19°.361. Hence, the amount of heat required to raise the temperature of one kilogramme of mercury one degree must be equal to $\frac{0.639}{19.361} = 0.033$ of one unit.

Example 2. If we mix 0.685 of a kilogramme of sulphur at 60° with 4.573 kilogrammes of water at 12°, we shall find that the temperature of the mixture will be 13°.42. The temperature of 4.573 kilogrammes of water has risen 1°.42, and hence the water has acquired $4.573 \times 1.42 = 6.493$ units of heat. These 6.493 units of heat were sufficient to raise the temperature of 0.685 of a kilogramme of sulphur from 13°.42 to 60°, or through 46°.58. They would, therefore, raise the temperature of one kilogramme of sulphur through $46°.58 \times 0.685 = 31°.9$. Hence, it would require $\frac{6.493}{31.9} = 0.203$ of a unit of heat to raise the tempera-

ture of one kilogramme of sulphur one degree. In like manner all similar problems may be solved.

These solutions may easily be made general, and reduced to an algebraic form, in the following way. Let

W = weight of water. w = weight of substance.
 τ° = temperature of water. T° = temperature of substance.
 θ° = temperature of mixture. x = specific heat required.

Then we shall have,

W = units of heat required to raise temperature of water used one degree.
 $w x$ = units of heat required to raise temperature of substance used one degree.
 $(\theta - \tau)^\circ$ = number of degrees through which temperature of water has been raised.
 $(T - \theta)^\circ$ = number of degrees through which temperature of substance has fallen.
 $(\theta - \tau)^\circ W$ = units of heat water has gained.
 $(T - \theta)^\circ w x$ = units of heat substance has lost.

Since the gain and the loss must be equal, it follows that

$$(T - \theta)^\circ w x = (\theta - \tau)^\circ W;$$

whence

$$x = \frac{(\theta - \tau)^\circ W}{(T - \theta)^\circ w}. \quad [157.]$$

The results obtained from this formula would be accurate, were it not for the fact, that the vessel which holds the water changes its temperature with that of the water, so that the heat lost by the substance not only raises the temperature of the water $(\theta - \tau)^\circ$, but also the temperature of the vessel, by the same amount. If we know the weight of the vessel and the specific heat of the substance of which it is made, we can easily estimate the amount of heat required for this purpose. The vessel used is generally made of brass or silver, very light and brightly polished, so that these data can be readily obtained.

Let w' = weight of the vessel, and c = specific heat of the vessel; then

$w' c$ = amount of heat required to raise its temperature one degree.
 $(\theta - \tau)^\circ w' c$ = amount of heat required to raise its temperature $(\theta - \tau)^\circ$.

Since the heat lost by the substance is equal to that gained by the water plus the amount gained by the vessel, it follows that

$$(T - \theta)^\circ w x = (\theta - \tau)^\circ W + (\theta - \tau)^\circ w' c = (\theta - \tau)^\circ (W + w' c);$$

hence,
$$x = \frac{(\theta - \tau)^\circ (W + w' c)}{(T - \theta)^\circ w}. \quad [158.]$$

If, as is usually the case, the substance is enclosed in a glass tube on a small basket of wire-work, it is also necessary to pay regard to the weight and specific heat of these envelopes in the calculation. Representing, then, by w'' and c' the weight and specific heat of the envelope respectively, we shall have, evidently,

$$(T - \theta)^\circ w'' c' = \text{units of heat the envelope has lost.}$$

Hence we obtain,

$$(T - \theta)^\circ w'' c' + (T - \theta)^\circ w x = (\theta - \tau)^\circ (W + w' c),$$

and also

$$x = \frac{(\theta - \tau)^\circ (W + w' c) - (T - \theta)^\circ w'' c'}{(T - \theta)^\circ w}. \quad [159.]$$

The above method of determining the specific heat of solids and liquids admits of great accuracy, but its practical application requires many precautions and great delicacy of manipulation. Regnault, who adopted this method in his very extended investigations on specific heat, used, in making the determinations, the apparatus represented in Fig. 364.* This apparatus consists, first, of the vessel m , in which the heated substance is mixed with water; secondly, of a peculiarly constructed steam-bath, VPV , by which the substance is previously heated to a known temperature of about 100° .

The substance to be examined is placed in a small basket of brass wire, P . If it is solid, it is broken into small lumps; but if liquid, it is enclosed in tubes of glass, whose weight and specific heat are known. In the axis of the basket there is fastened a small cylinder of wire-netting, which receives the bulb of a delicate thermometer for determining the temperature of the basket and its contents. During the process of heating, the basket is suspended by means of silk cords in the interior of a

* Annales de Chimie et de Physique, 2^e Série, Tom. LXXIII. p. 20.

steam-bath, formed of three concentric cylinders of tin plate. The space P , in which the basket is suspended, is filled with air, and opens below into the chamber M by means of the slide rr , which can be withdrawn at pleasure. The space V is filled with

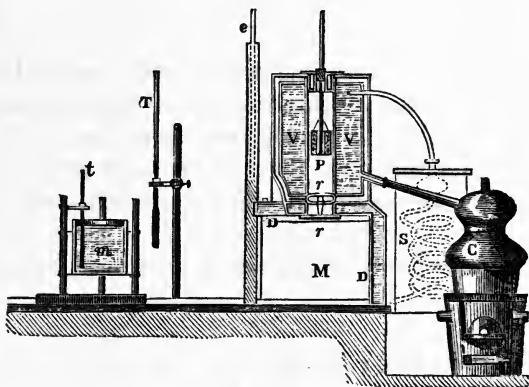

Fig. 364.

steam, which is constantly supplied from the boiler C , and afterwards condensed in the worm s ; and, lastly, the space between the steam-chamber and the outer cylinder is filled with air, which, being a non-conductor, diminishes the loss of heat by the bath, and thus tends to keep its temperature constant.

A cylindrical vessel, m , made of very thin sheet-brass, contains the water with which the substance is to be mixed. It is suspended, by means of silk cords, to a movable support, which slides in a groove, so that the vessel may be readily moved into the chamber M , under the steam-bath. A delicate thermometer, t , gives very accurately the temperature of the water, and a second thermometer, T , that of the air. These thermometers are observed by means of a telescope placed several feet distant, and every precaution is taken to protect them from extraneous influences.

In making a determination of the specific heat of a substance, we wait until the thermometer P indicates a constant temperature, which requires about two hours. Then, in order to be sure that the substance has the same temperature throughout, we wait at least an hour longer, and carefully observe the thermometers t and T . Having removed the screen e , we now push the vessel m into the chamber M , and, withdrawing the slide rr ,

quickly drop the basket containing the substance into the water. The vessel is then at once returned to its former position, and, while an assistant stirs up the water, we observe the elevation of temperature indicated by the thermometer t , which reaches its maximum in one or two minutes.

In calculating the specific heat of a substance from these results by means of [159], it is necessary to take into the account the quantity of heat received by the vessel m from the air or neighboring bodies during the course of the experiment, as well as that which it loses during the same time. The variation of temperature arising from this cause is ascertained by means of a series of preliminary experiments, made under the same conditions as the final determination, and the observed temperature of t corrected accordingly; but as the value of this correction is necessarily somewhat uncertain, it is made very small by reducing as much as possible the duration of the experiments, and also by so regulating the temperature of the water that it may be for an equal length of time above and below the temperature of the air. Moreover, during the few seconds that the vessel of water is in the chamber M , it is protected from the heat of the steam-bath by the cold water which fills the space within the hollow walls DD ; and when outside of the chamber, it is also protected by the screen e .

In order to test the accuracy of this process, Regnault determined the specific heat of water with the apparatus just described. In two experiments, in which the liquid was heated to 97° , he obtained the values 1.00709 and 1.00890, thus showing that the specific heat of water increases with the temperature, and also confirming the accuracy of the method.

(234.) *General Results.* — From the numerous investigations which have been made on the specific heat of solid and liquid substances, several important general truths have been deduced.

First. The specific heat of substances is a distinguishing property, closely connected with their atomic weights or combining proportionals. The relation which exists between these two qualities of matter has already been discussed in (215 *bis*) and will also appear on solving Prob. 292.

Secondly. The specific heat of the same substance increases with the temperature. This is true even in the case of water, which has been selected as the standard to which the specific

heat of other substances is referred. The unit of heat, it will be remembered, is the quantity of heat required to raise the temperature of one kilogramme of water one Centigrade degree. Now it might be supposed that the same quantity of heat would raise the temperature of a kilogramme of water one degree at all parts of the thermometric scale ; but this is not the case : to raise the temperature of one kilogramme of water from 100° to 101° requires, for example, 1.0130 units of heat, and, as a general rule, the amount required is greater the higher the temperature. This is shown by the following table. In the second column, headed *c*, opposite to each temperature, is given the specific heat of water at that temperature ; in other words, the number of units of heat required to raise the temperature of one kilogramme of water from t° to $(t + 1)^{\circ}$. In the third column, headed *C*, are given the mean specific heats for the interval of temperature between 0° and t° .

<i>t.</i>	<i>c.</i>	<i>C.</i>	<i>t.</i>	<i>c.</i>	<i>C.</i>
0	1.0000	1.0000	100	1.0130	1.0050
20	1.0012	1.0005	120	1.0177	1.0067
40	1.0030	1.0013	140	1.0232	1.0087
60	1.0056	1.0023	160	1.0294	1.0109
80	1.0089	1.0035	180	1.0364	1.0133

It will be noticed that, within the ordinary range of atmospheric temperatures, the specific heat of water increases only very slightly ; so that, in determinations of the specific heat of other substances by the method of mixtures, that of water may be regarded as constant between 0° and 20° . But above this temperature the increase of the specific heat of water can no longer be disregarded, and we must therefore modify slightly our definition of the unit of heat. Accurately speaking, *the unit of heat is the quantity of heat required to raise the temperature of a kilogramme of water from 0° to 1° .*

What is shown by the above table to be true of water, is also true of all other solids and liquids. Dulong and Petit made experiments on a number of metals up to 300° , employing the method of mixtures, and obtained the results given in the following table : —

Name of Metal.	Mean Specific Heat.		T.	Name of Metal.	Mean Specific Heat.		T.
	Between 0° & 100°	Between 0° & 300°.			Between 0° & 100°.	Between 0° & 300°.	
Iron,	0.1098	0.1218	332.2	Silver,	0.0557	0.0611	321.3
Mercury,	0.0330	0.0350	318.2	Copper,	0.0949	0.1013	320.0
Zinc,	0.0927	0.1015	328.5	Platinum,	0.0335	0.0355	317.9
Antimony,	0.0507	0.0549	324.8	Glass,	0.1770	0.1990	322.2

In equation [159], the temperature T is supposed to be given, and from it we can calculate the specific heat of the substance; but we may evidently reverse this calculation, and, when the specific heat of the substance is known, use the method of mixtures for determining its temperature. Thus this method furnishes a very simple means of measuring high temperatures. If, for example, we wish to measure the temperature of a furnace, we expose to it a mass of platinum of known weight; and when the mass has acquired the temperature of the furnace, we transfer it to the brass vessel m (Fig. 364), containing a known weight of water, and observe the elevation, taking all the precautions mentioned in the previous section. If the specific heat of the platinum is known, we then have all the elements for calculating the temperature. If it is not known, we can make two determinations with unequal quantities both of platinum and water, and thus obtain two equations, from which we can eliminate the specific heat. Or, since the mean specific heat of platinum is known between 0° and different high temperatures, we can also calculate the temperature of the furnace from an estimate of the value of the specific heat for the unknown temperature, and afterwards use the specific heat corresponding to the temperature thus obtained for calculating a new value of the temperature, which will be more exact. In order to furnish the data for such calculation, M. Pouillet has determined by experiment the mean specific heat of platinum between 0° and different high temperatures, measured by the air thermometer. His results, which are given in the following table, were obtained by the method of mixtures.

Mean Specific Heat of Platinum.

0° to 100°	0.03350	0° to 1000°	0.03728
0 " 300	0.03434	0 " 1200	0.03818
0 " 500	0.03518	0 " 1500	0.03938
0 " 700	0.03602		

The change of the specific heat with the temperature becomes very marked as the solid approaches its melting point; and this is especially the case with those solids which soften before they melt. Hence, in stating the specific heat of a substance, it is important to name the temperatures between which the determination was made.

The specific heat of liquids varies with the temperature to a much greater extent than that of solids. Thus bromine, according to Regnault, has the specific heats 0.10513, 0.11094, 0.11294, between the temperatures -6° and $+10^{\circ}$, 11° and 48° , 13° and 58° , respectively. So, also, oil of turpentine has the specific heat of 0.426 between 15° and 20° , and 0.4672 between 15° and 100° .

Regnault* has also determined the specific heat of a large number of other liquids by the *method of cooling*, which, as he found, gives more accurate results with liquid than with solid substances. Some of the most important of his results are given in the following table. As a general rule, they show that the specific heat increases with the temperature. But the difference between the extreme temperatures is so small, that the slight increase of the specific heat is, in some cases, more than overbalanced by variations arising from other and accidental causes.

Names of Liquids.	Mean Specific Heat.		
	5° to 10° .	10° to 15° .	15° to 20° .
Mercury,	0.0282	0.0283	0.0290
Alcohol at 36° ,	0.6588	0.6651	0.6725
Methylic Alcohol,	0.5901	0.5868	0.6009
Oxide of Ethyle,	0.5207	0.5158	0.5157
Bromide of Ethyle,	0.2164	0.2135	0.2153
Iodide of Ethyle,	0.1587	0.1584	0.1584
Sulphide of Ethyle,	0.4715	0.4653	0.4772
Terebene,	0.4154	0.4156	0.4267
Oil of Citron,	0.4489	0.4424	0.4501
Bichloride of Tin,	0.1421	0.1402	0.1416
Chloride of Silicon,	0.1914	0.1904	0.1904
Chloride of Phosphorus,	0.2017	0.1987	0.1991
Sulphide of Carbon,	0.2179	0.2183	0.2206

It will be noticed that the increase of the specific heat with the temperature corresponds to the increase of the rate of expansion, and it is probable that the two classes of phenomena are

* Annales de Chimie et de Physique, 3^e Série, Tom. IX. p. 336.

closely connected together. The best explanation which we can give of the facts is this. If the volume of a solid or liquid mass of matter remained the same at all temperatures, it is probable that it would require exactly the same quantity of heat to raise its temperature one degree at all parts of the thermometric scale. As, however, both solid and liquid matter are expanded by heat with an irresistible force, a portion of the quantity of heat required to raise the temperature of a given mass one degree is rendered latent in producing this mechanical effect; and since the rate of expansion increases with the temperature, the quantity of heat thus rendered latent, and hence also the specific heat, must be greater at high than at low temperatures.

Thirdly. All substances have a greater specific heat in the liquid than in the solid state. This truth, which is rendered evident by the following table, is probably connected with the fact that the rate of expansion of liquids is greater than that of solids, and hence the quantity of heat absorbed in producing this mechanical effect is also greater.

Name of Substance.	Solid.		Liquid.	
	Interval of Temperature.	Specific Heat.	Interval of Temperature.	Specific Heat.
Lead,	0° to 100°	0.0314	350° to 450°	0.0402
Bromine,	-78 " -20	0.08432	10 " 48	0.1109
Iodine,	0 " 100	0.05412		0.10822
Mercury,	-78 " -40	0.0247	0 " 100	0.0333
Sulphur,	0 " 100	0.2026	120 " 150	0.234
Bismuth,	0 " 100	0.03084	280 " 380	0.0363
Zinc,	0 " 100	0.0956		
Tin,	0 " 100	0.0562	250 " 350	0.0637
Phosphorus,	10 " 30	0.1887	50 " 100	0.212
Water,	under 0	0.502	0 " 20	1.0000
Chloride of Calcium (cryst.),	" 0	0.315	33 " 80	0.555
Nitrate of Soda,	0 to 100	0.27821	320 " 430	0.413
Nitrate of Potassa,	0 " 100	0.23875	350 " 435	0.3319

Fourthly. The specific heat varies with the molecular condition of a substance, and we can say, in general, that all causes which increase the density of a solid diminish its specific heat. Thus the specific heat of artificially prepared sesquioxide of iron diminishes in proportion as its density is increased by calcination, and finally becomes equal to that of the natural iron glance. So also copper, when annealed, has a specific heat equal to 0.09501;

but after its density has been increased by hammering, the specific heat is found to be only 0.09360. On the other hand, the specific heat of tin or lead is not increased by mechanical pressure; but then their density also remains unchanged.

The specific heat of a substance, moreover, is not the same in its different allotropic modifications. The specific heat of carbon, for example, differs very greatly in its three allotropic conditions, as is shown by the following results of Regnault. It will be noticed that in these cases, also, the specific heat diminishes with the density. Similar facts were observed by Regnault* in the case of sulphur and carbonate of lime.

	Specific Gravity.	Specific Heat.
Wood Charcoal,	0.300	0.2415
Graphite,	2.300	0.2027
Diamond,	3.500	0.1469

Fifthly. By referring to the tables on pages 466, 475, it will be seen that liquid water has the greatest specific heat of any of the substances mentioned. In fact, for the same temperature, it contains the greatest amount of heat of any solid or liquid known. This property of water makes the oceans of the globe great reservoirs of heat, and hence the important influence which they exert in moderating and equalizing the climate of islands and continents.

On the other hand, it will be noticed that mercury has a very small specific heat. It is therefore rapidly heated or cooled, and is in this respect also, as in others (225), well adapted for its use in the thermometer.

(235.) *Specific Heat of Gases.* — The determination of the specific heat of gases involves the greatest practical difficulties, and although several extended investigations of the subject have been made by eminent physicists, yet the results obtained have been generally very erroneous. Within a few years, the subject has been reinvestigated by Regnault, and his determinations of the specific heat of the gases are, unquestionably, far more accurate than those of any previous experimenter. Unfortunately, however, as no description of the process employed by Regnault has yet been published, we can only state the general results at which he has arrived.

The specific heat of a gas may be defined in two ways: first,

* Annales de Chimie et de Physique, 3^e Serie, Tom. I. pp. 182 and 202.

as the amount of heat required to raise the temperature of one kilogramme of the gas from 0° to 1° , allowing the gas to expand freely and in such a manner that it shall preserve a constant elasticity; and, secondly, as the amount of heat required to raise the temperature of one kilogramme of the gas from 0° to 1° when the gas is compelled to preserve a constant volume, the tension of course increasing. We may distinguish the specific heats under these two conditions as the *specific heat under constant pressure*, and *specific heat under constant volume*. In the case of liquids and solids we can only determine the specific heat under constant pressure, and in the case of gases it is only this value which can be determined by direct experiment.

(236.) *Specific Heat of Gases under Constant Pressure.*—As preliminary to the determination of the specific heats of the separate gases, Regnault has established two important principles:—

First. *The specific heat of a gas does not vary sensibly with the temperature.* This is illustrated by the following table, which gives the specific heat of air between different limits of temperature.

Interval of Temperature.	Specific Heat.
-30° to $+10^{\circ}$	0.2377
10° “ 100°	0.2379
100° “ 225°	0.2376

It will be noticed that the differences are inconsiderable, and the same was found to be true of other gases.

Secondly. *The specific heat of a gas does not vary with the pressure, and hence is the same for all densities.* Regnault experimented on air and on other gases under pressures which varied from one to ten atmospheres, and found no sensible difference in the quantity of heat which the same weight of a gas lost, when under these different pressures, in cooling the same number of degrees. Nevertheless, he thinks it possible that slight differences may exist.

The specific heats of the different gases and vapors, as determined by Regnault, are given in the following table. The numbers in the column headed “Specific Heat by Weight” correspond to those given in all the preceding tables of specific heats, and denote in each case the number of units of heat required to raise the temperature of one kilogramme of the gas from 0° to 1° , assuming that the gas is allowed to expand freely, and that the pressure is constant.

Specific Heat of Gases and Vapors.

Name of Gas or Vapor.	Specific Heat.		Specific Gravity.
	By Weight.	By Volume.	
<i>Simple Gases.</i>			
Air,	0.2377	0.2377	1.0000
Oxygen,	0.2182	0.2412	1.1056
Nitrogen,	0.2440	0.2370	0.9713
Hydrogen,	3.4046	0.2356	0.0692
Chlorine,	0.1214	0.2962	2.4400
Bromine,	0.0552	0.2992	5.39
<i>Compound Gases.</i>			
Protoxide of Nitrogen,	0.2238	0.3413	1.5250
Deutoxide of Nitrogen,	0.2315	0.2406	1.0390
Oxide of Carbon,	0.2479	0.2399	0.9674
Carbonic Acid,	0.2164	0.3308	1.5290
Sulphide of Carbon,	0.1575	0.4146	2.6325
Sulphurous Acid,	0.1553	0.3489	2.2470
Chlorohydric Acid,	0.1845	0.2302	1.2474
Sulphohydric Acid,	0.2423	0.2386	1.1912
Ammonia Gas,	0.5080	0.2994	0.5894
Marsh Gas,	0.5929	0.3277	0.5527
Olefiant Gas,	0.3694	0.3572	0.9672
<i>Vapors.</i>			
Water,	0.4750	0.2950	0.6210
Alcohol,	0.4513	0.7171	1.5890
Ether,	0.4810	1.2296	2.5563
Cyanohydric Ether,	0.4255	0.8293	1.9021
Chlorohydric Ether,	0.2737	0.6117	2.2350
Bromohydric Ether,	0.1816	0.6777	3.7316
Sulphohydric Acid,	0.4005	1.2568	3.1380
Acetic Acid,	0.4008	1.2184	3.0400
Chloroform,	0.1568	0.8310	5.30
Dutch Liquid,	0.2293	0.7911	3.45
Acetone,	0.4125	0.8341	2.0220
Benzole,	0.3745	1.0114	2.6943
Oil of Turpentine,	0.5061	2.3776	4.6978
Terchloride of Phosphorus,	0.1346	0.6386	4.7445
Terchloride of Arsenic,	0.1122	0.7013	6.2510
Chloride of Silicon,	0.1329	0.7788	5.86
Bichloride of Tin,	0.0939	0.8639	9.2
Bichloride of Titanium,	0.1263	0.8634	6.8360

The specific heat of a substance, whether it be a solid, a liquid, or a gas, is always, properly speaking, the number of units of heat required to raise the temperature of one kilogramme from 0° to 1° ; and the term is invariably used in this sense in relation to both solids and liquids. But in the case of gases some important truths have been discovered by comparing together the amounts of heat required to raise the temperature of equal volumes from 0° to 1° , irrespective of their weight. The number of units required can in any case be readily calculated from the specific heat and the specific gravity of the gas, and this quantity is usually called the *specific heat by volume*.

By referring to Table II., it will be found that one cubic metre of air at 0° , and under a pressure of 76 c. m., weighs 1.29206 kilogrammes. Hence, by [100], one cubic metre of air at 0° , and under a pressure of 58.75 c. m., will weigh exactly one kilogramme; and one cubic metre of any other gas as much more or less than one kilogramme as its specific gravity is greater or less than 1. In other words, the number which stands for the specific gravity also expresses the weight of one cubic metre under the above conditions of temperature and pressure. Now, since the quantity of heat required to raise the temperature of any mass of matter from 0° to 1° may be found by multiplying the specific heat of the substance by its weight (232), it is evident that we can find the quantity of heat required to raise from 0° to 1° the temperature of one cubic metre of any gas under the pressure of 58.75 c. m., by multiplying together the specific heat of the gas and the number representing its specific gravity. For example, the specific heat of hydrogen is 3.4046, and its specific gravity 0.0692. The product of these two numbers equals 0.2356, which is the fractional part of a unit of heat required to raise the temperature of one cubic metre of hydrogen, measured under a pressure of 58.75 c. m., from 0° to 1° . In like manner all the numbers in the column of the last table headed "Specific Heat by Volume" were obtained. These numbers evidently represent the relative quantities of heat required to raise the temperature of equal volumes of different gases from 0° to 1° , and the absolute number of units of heat required to raise the temperature of one cubic metre of the different gases measured under a pressure of 58.75 c. m. from 0° to 1° .

By comparing the numbers, it will be seen that the *specific heats by volume* of the simple gases differ but slightly from each other. Indeed, the difference is so small, that some experimenters have concluded that the specific heats of all the simple gases are the same. The results of Regnault do not confirm this theory; for although the specific heats by volume of oxygen, nitrogen, and hydrogen are by his determinations very nearly equal, those of chlorine and bromine are much greater than the rest, although equal to each other. These differences, moreover, are too large to be accounted for by errors of observation, and probably depend on inherent qualities of the gases themselves.

(237.) *Specific Heat of Gases under Constant Volume.* — It was stated in (234), that a portion of the quantity of heat required to raise the temperature of a given mass of matter one degree was rendered latent in producing the mechanical effect of expansion, and that, if this expansion could be prevented, the same quantity of heat would probably cause the same elevation of temperature at all parts of the thermometer-scale. In the case of solids and liquids it is evidently impossible to verify this theory, since they expand with an irresistible force. We do not meet with the same difficulty in the case of gases. They are easily compressed, so that their volume can be kept constant by enclosing them in an unyielding vessel; and we should therefore naturally expect to be able to put our theory to the test of experiment. Now it is a perfectly well-known fact, that a certain amount of heat is rendered latent in producing the expansion of a given mass of gas, and that, on condensing the gas to its original volume, the same amount of heat is set free. Indeed, the temperature of a confined mass of air can be raised by sudden mechanical condensation sufficiently high to ignite tinder.

If we could measure, then, the quantity of heat set free by mechanical condensation, we should be able to determine the quantity absorbed during the equivalent expansion; and since we know the quantity of heat required to raise the temperature of one kilogramme of gas from 0° to 1° when allowed to expand freely, we should be able to determine the quantity of heat required to raise its temperature from 0° to 1° when confined and not allowed to expand, by simply subtracting the amount absorbed during expansion.

It has been stated that at 0° , and under a pressure of 58.75

c. m., one cubic metre of air weighs one kilogramme; and it has been shown that, in order to raise the temperature of this mass of air one degree, (the pressure remaining the same,) we must impart to it 0.2377 unit of heat. But it is also true that, in consequence of the increase of temperature, the volume of the one kilogramme has increased $\frac{1}{273}$, that is, from 1 to $1\frac{1}{273}$ cubic metres (216). If now, by increasing the pressure, we condense the gas to its initial volume of one cubic metre, a certain amount of heat will be set free, sufficient, as we will assume, to raise the temperature of the kilogramme of air from 1° to $1^\circ.42$. This shows that although 0.2377 unit of heat will raise the temperature of one kilogramme of air only one degree, when allowed to expand under a constant *pressure*, it will raise the temperature of the same mass of air $1^\circ.42$ when confined and preserving a constant *volume*. If, then, 0.2377 unit of heat will raise the temperature of one kilogramme of air $1^\circ.42$, it is easy to calculate how much will be required to raise its temperature one degree by means of the proportion $1.42 : 1 = 0.2377 : x = 0.1674$. This quantity is the specific heat of air under constant volume, and the difference between 0.1674 and 0.2377, or 0.0703 unit, is the amount of heat rendered latent in producing the expansion when the air is under constant pressure.

It is evident from the above illustration, that, if we represent by S the specific heat of a gas under constant pressure, and by t the small increase of temperature which a mass of gas undergoes when condensed $\frac{1}{273}$ of its volume, we can always calculate the specific heat under constant volume, or S' , by the proportion $1 + t : 1 = S : S'$, which gives for the value of S' ,

$$S' = \frac{S}{1 + t}. \quad [160.]$$

An obvious method of determining experimentally the specific heat of a gas under constant volume would then be to condense the gas by mechanical means, and observe the increase of temperature. Such experiments have been made, but the results have been in all cases erroneous, in consequence of the unavoidable loss of heat, which was absorbed by the walls of the containing vessel. — In like manner, when we attempt to determine the specific heat of gases under constant volume by other direct methods, we are met at once by practical difficulties of a similar

kind, and no process has as yet been discovered which will give accurate results. We are therefore obliged to resort to indirect methods; and fortunately such a method is furnished by the principles of acoustics.

By analyzing the condition of an elastic fluid during the transmission of a sonorous wave, Newton obtained, for the value of the velocity of sound in any gas, the expression

$$v = \sqrt{g \cdot \frac{H}{\delta}}; \quad [161.]$$

in which g represents the intensity of gravity, H the height of the barometer, and δ the specific gravity of the gas referred to mercury as unity. This formula gives for the velocity of sound in dry air, at 0° and when $H = 76$ c. m., the value $v = 279.3$ metres, which is less than 332.25 metres, the true value as ascertained by experiment, by over one sixth of the whole. The cause of this great discrepancy between the observed and calculated velocity remained for a long time unexplained, until Laplace showed that the alternate expansion and contraction of the elastic fluid, constituting the sound-wave, must produce a change of temperature, which would increase the velocity of the transmission of the wave itself. In order to take into account the effect thus produced, Laplace multiplied the quantity $g \cdot \frac{H}{\delta}$ in the formula of Newton by the quotient $\frac{S}{S'}$, obtained by dividing the specific heat of the gas under constant pressure by the specific heat under constant volume. As thus corrected, the formula of Newton becomes

$$v = \sqrt{g \cdot \frac{H}{\delta} \cdot \frac{S}{S'}}. \quad [162.]$$

By transformation, we easily obtain from this equation the expression,

$$S' = \frac{g \cdot H \cdot S}{v^2 \delta}, \quad [163.]$$

by which we can calculate the specific heat of a gas under constant volume, when the velocity of sound in the medium and the other constants are known. Now the velocity of sound in air has been several times carefully determined by direct experiment, and is probably known within a metre; and starting from

the velocity in air, the science of acoustics furnishes the means of determining the velocity in other gases. Thus it is that we have been able to determine some of the most refined data connected with the thermal condition of matter, by means of phenomena which at first sight seem entirely independent of the action of heat.

The specific heat *under constant volume* of several gases, as determined by Dulong by means of the method just described, is given in the second column of the following table; but these values must be regarded as only approximations. The corresponding values of specific heat *under constant pressure* are given in the first column, repeated from the table on page 472, for the sake of comparison. The third column shows the difference between the specific heat under the two circumstances, and the last gives the value of $1 + t$ in formula [160].

Specific Heat of Equal Volumes.

Name of Gas.	Under Constant Pressure. <i>S.</i>	Under Constant Volume. <i>S'.</i>	Difference. <i>S — S'.</i>	$1 + t.$
Air,	0.2377	0.1673*	0.0704	1.421
Oxygen,	0.2412	0.1705	0.0707	1.415
Hydrogen,	0.2356	0.1675	0.0681	1.407
Oxide of Carbon,	0.2399	0.1681	0.0718	1.428
Carbonic Acid,	0.3308	0.2472	0.0836	1.338
Olefiant Gas,	0.3572	0.2880	0.0692	1.240

The numbers in the first column of the above table represent the fractional part of one unit of heat required to raise the temperature of one cubic metre of each gas (measured under a pressure of 58.75 c. m.) from 0° to 1° , the pressure remaining constant, the gas being allowed to expand freely, and increasing in volume $\frac{2}{3}$ of a cubic metre. The numbers in the second column represent the corresponding quantity of heat required when the volume is kept constant by increasing the pressure. The difference of these quantities, or $S - S'$, is, then, the quantity of heat absorbed by one cubic metre of each gas, measured as above described, in expanding $\frac{2}{3}$ of its initial volume.

* By using the more recently determined constants, we should obtain, for the value of S' , 0.1678, and for $1 + t$ the value 1.417.

By comparing the quantity of heat thus rendered latent in the case of air with that which remains free, and consequently raises the temperature of the gas, it will be found that they stand to each other very nearly in the proportion of 2 to 5. Hence, of seven units of heat imparted to a mass of free air for the purpose of increasing its temperature,—as, for example, in warming the air of a room,—two units are absorbed in expanding the air, so that the elevation of temperature results entirely from the remaining five.

By comparing the values of $S - S'$, it will be noticed that the quantity of heat absorbed by equal volumes of these different gases, in expanding to an equal extent, is very nearly the same in all cases. Dulong has verified this principle in the case of a large number of gases not included in the above table, and has stated the law in the following simple terms:—

1. *Equal volumes of all gases, measured at the same temperature and pressure, set free or absorb the same quantity of heat when they are compressed or expanded the same fractional part of their volume.*

If the specific heat of the gases were all equal, the same change of volume, and consequently the same absorption or liberation of heat, would cause the same change of temperature. This, however, is not the case, except with oxygen, hydrogen, and nitrogen. The specific heats of the compound gases differ very considerably from each other, and the change of temperature caused by the same change of volume is smaller in proportion as the specific heat of the gas is greater. Hence the second law of Dulong, which should be read in connection with the first.

2. *The variations of temperature which result are in the inverse ratio of the specific heats under constant volume.*

Whether these empirical laws of Dulong are the exact expressions of the truth, or whether they are merely close approximations, remains yet to be ascertained by further investigation.

(238.) *Mechanical Equivalent of Heat.*—The doctrine of the conservation of the physical forces has furnished, through the investigations of Joule on the mechanical equivalent of heat, a most remarkable confirmation of the results of the last section. According to this doctrine, there is an exact equivalency of cause and effect between all the forces of nature. Thus, in the case of heat, it would assume that a given mechanical effect would,

under all circumstances, be accompanied by the absorption of the same amount of heat; and conversely, that the same quantity of heat should, under all conditions, do the same amount of mechanical work — for example, should raise a given weight through the same height — in whatever way it may be applied.

It is a well-known fact, that friction is, under all circumstances, attended with evolution of heat. Now, since friction represents the expenditure of force, it follows that the quantity of heat evolved by friction is the equivalent of the mechanical force expended in overcoming it. Joule was therefore able to fix the mechanical equivalent of heat, by measuring the quantity of heat generated by friction, and comparing this with the power (42) expended in overcoming the friction. The heat was generated by the friction of water, and the apparatus he used for the purpose is represented in Fig. 365. It consisted of a brass paddle-wheel, furnished with eight sets of revolving arms, working between four sets of stationary vanes affixed to a framework, also of sheet-brass. This frame fitted firmly into a copper vessel containing from six to seven kilogrammes of

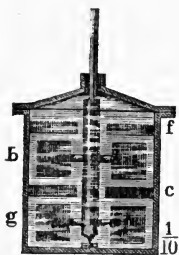

Fig. 365.

water. In the lid of the vessel there were two necks, the first for the axis to revolve in without touching, the second for the insertion of the thermometer. The paddle-wheel was set in motion

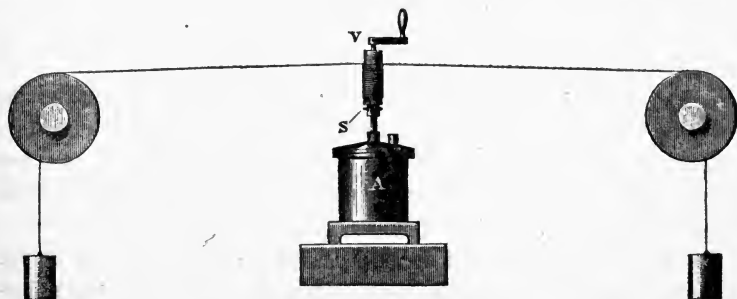

Fig. 366.

by means of two weights connected with its axis by a system of cords and pulleys, as represented in Fig. 366. In making the experiments, the weights were wound up by means of the handle *v*, attached to the wooden cylinder *v s*, and after observing the

temperature of the water in the vessel, the cylinder was fixed to the axis of the paddle, which was then made to revolve by the fall of the weights to the floor of the laboratory, causing a friction against the water in the vessel. The cylinder was then removed from the axis, the weights wound up again, and the friction renewed. After this had been repeated twenty times, the experiment was concluded with another observation of the temperature of the water. The mean temperature of the laboratory was determined by observations made at the beginning, middle, and end of the experiment, and the quantity of heat which the vessel lost by radiation and other causes was determined in every case by means of a second experiment, made under precisely the same circumstances as the first, with the apparatus at rest. It was then easy to calculate, by means of [159], the number of units of heat developed by the friction of the water, since the weights of the copper vessel, of the brass paddle and frame, and of the water, as well as their several capacities for heat, and the increase of temperature caused by the friction of the particles of water, were known. This quantity of heat was, then, evidently the equivalent of the mechanical force expended in moving the paddles and overcoming the friction. In order to estimate the mechanical force thus expended, the value of the weights, the height through which they fell, and the velocity of the fall, were accurately measured.

In one series of experiments, the value of the weights was 406,152 grains, the total fall in inches 1,260.248, and the velocity 2.42 inches per second. The weight, starting from the state of rest, soon acquired the velocity of 2.42 inches, and afterwards moved with a uniform motion until it reached the ground, where the velocity was destroyed. During the uniform motion, it is evident that the intensity of the force of gravity acting on the weights was entirely expended in overcoming the friction of the water (42); but before the motion became uniform, a portion of the force was expended in imparting velocity to the weights. The whole mechanical power expended in overcoming the friction of the water, and thus generating heat, is then the power generated by the force of gravity acting on the mass of the weights through the whole distance fallen, less the power generated by the same force acting through the distance required to impart a velocity of 2.42 inches. By [6], we find that a fall through

0.0076 of an inch would impart a velocity of 2.42; and since the weights were wound up twenty times in each experiment, a fall through twenty times 0.0076, or 0.152 inch, would represent the entire loss due to the increase of velocity. Hence the mechanical power expended in overcoming the friction of the water was a force having the intensity of 406,152 grains, acting through 1,260.096 inches. Compare (63).

We have assumed, in this estimate, that the intensity of the force of gravity was entirely expended in overcoming the friction of the whole; but this was not the case, for a portion of the force was used in overcoming the friction of the pulleys and the rigidity of the cord. This was ascertained by a separate experiment, in which the pulleys and cord were disconnected from the paddle-wheel, to be equal to 2,837 grains acting during the whole time, which, deducted from the value of the weights, gives 403,315 grains for the actual force overcome by the friction. This force, acting through 1,260.096 inches, is equivalent to a force of 6,050.186 pounds acting through one foot, or, using the technical expression, to 6,050.186 foot-pounds. But in order to obtain the whole power overcome by the friction, we must add to this amount 16.928 foot-pounds for the force developed by the elasticity of the string after the weights touched the ground, making the whole mechanical force expended in overcoming friction, and thus developing heat, equal to 6,067.114 foot-pounds, as the mean of all the experiments of the series. The same series of experiments gave, for the mean value of the quantity of heat evolved, 7.842299 English units; * and hence, $\frac{6067.114}{7.842299} = 773.64$ foot-pounds will be the force which is equivalent to one English unit of heat.

In these experiments a portion of the force is used in overcoming the resistance of the air, and, making the correction necessary to reduce the results to a vacuum, and omitting the fraction, we get 772 foot-pounds as the mechanical equivalent, which Joule regards as the most probable value. Similar experiments, in which the friction was produced by an iron paddle-wheel revolving in mercury, and others, in which it was produced by two cast-iron wheels, gave for the mechanical equivalent of heat 774 foot-pounds, — a number which is surprisingly near the first.

* The English unit of heat is the quantity of heat required to raise one avoirdupois pound of water one Fahrenheit degree between 55° and 60°.

We have given the above calculation in English weights and measures, because it is so given in the original memoir,* to which we would refer for further details. In the French system, these results correspond to 423 and 424 kilogramme-metres, or, in other words, the unit of heat is equivalent to a force of 423 kilogrammes acting through one metre.

Let us now see in what way these results of Joule confirm those stated in the last section. It will be remembered that the value of the specific heat of air *under constant volume* was deduced from the velocity of sound. This value furnishes us with all the data required for calculating the mechanical equivalent of heat; and if the doctrine of the conservation of forces is correct, the equivalent calculated from the velocity of sound ought to agree with that determined by Joule from his experiments on friction. Such an agreement would not only confirm the value which has been assigned to the specific heat of air, but it would also tend to confirm the doctrine in question.

Let us suppose that we have a cylinder, the area of whose base equals 1 c. m.^2 , filled to the height of 273 c. m. with air at 0° and under a pressure of 76 c. m. By Table II. the weight of this mass of air would be equal to 0.3531 gramme. If we raise the temperature of this air from 0° to 1° , it will expand $\frac{1}{273}$ of its volume, and will rise in the cylinder one centimetre, thus lifting the weight of the atmosphere on the base of the cylinder — 1,033.3 grammes — through this distance. The quantity of heat required to raise the temperature of 0.3527 gramme of air from 0° to 1° is, by (236), equal to 0.3527×0.000237 , or 0.0000836 unit. Of this amount, a part only is consumed in expanding the air, the rest remaining free and increasing the temperature of the mass of gas. By (237), the part which does the mechanical work is equal to the difference between the specific heat under constant pressure and the specific heat under constant volume. Hence, in the present case, it is equal to [160]

$$0.0000836 - (0.0000836 \div 1.417) = 0.0000246 \text{ unit of heat.}$$

It follows, then, that in the expansion of air 0.0000246 unit of heat will raise 1,033.3 grammes one centimetre, or, what is equivalent to this, one unit of heat will raise 419 kilogrammes one

* Philosophical Transactions, London, 1850, Part I. p. 61.

metre. The difference between this value of the mechanical equivalent of heat and that obtained by Joule (423 kilogramme-metres) is very small, considering the entirely heterogeneous data which enter into the calculation.

Assuming, then, that the doctrine of the mechanical equivalency of heat is established, it follows that the law of Dulong (237) holds in all cases where the same mechanical power, acting on equal volumes of different gases, causes the same amount of condensation. But, as we have seen, this is not always the case; hence the law of Dulong must be subject to the same limitation as that of Mariotte (165). Indeed, the law of Dulong is probably only an imperfect expression of the mechanical equivalency of heat, and is true so far as the same expansion or compression represents the same amount of mechanical work.

PROBLEMS.

Specific Heat.

291. How much heat is required to raise the temperature of

500 kilogrammes of water	from	4° C.	to	94° ?
235 " "	sulphur	"	20°	" 100° ?
336 " "	charcoal	"	5°	" 500° ?
9.467 grammes of alcohol	"	"	3°	" 20° ?
10.234 " "	ether	"	-20°	" 13° ?

292. Calculate the quantity of heat which is required to raise the temperature of the weight of the different elements represented by their chemical equivalents one degree.

293. The following quantities of water were mixed together : —

2 kilogrammes of water	at	10° C.,
5 " "	"	30°,
6 " "	"	20°,
7 " "	"	12°.

What was the temperature of the mixture ?

294. The quantities of water w_1, w_2, w_3, w_4 , at the respective temperatures of $t_1^\circ, t_2^\circ, t_3^\circ, t_4^\circ$, were mixed together. What was the temperature of the mixture ?

295. How much water at 99° and how much water at 11° must be mixed together, in order to obtain 20 kilogrammes of water at 30° ?

296. Determine the temperature of a mixture of one kilogramme of water at 100° and one kilogramme of mercury at 0° ; also of one kilogramme of mercury at 100° and one kilogramme of water at 0° .

297. How many kilogrammes of mercury at 100° must be added to one

kilogramme of water at 0° in order that the temperature of the mixture may be 50° ? Also, how much water at 100° must be added to one kilogramme of mercury at 0° to raise its temperature to 50° ?

298. Equal volumes of mercury at 100° and water at 0° are mixed together. Required the temperature of the mixture.

299. A mass of matter weighing 6.17 kilogrammes at the temperature of 80° is mixed with 25.45 kilogrammes of water at the temperature of $12^\circ.5$. The mixture is found to have the temperature of $14^\circ.17$. What is the specific heat of the body?

300. How many kilogrammes of gold at 45° would be required to raise the temperature of 1,000 grammes of water from $12^\circ.3$ to $15^\circ.7$?

301. The specific heat of an alloy containing one equivalent of lead (103.6 parts) and one equivalent of tin (58.8 parts) was found by experiment to be 0.0407. How does this value correspond with that which may be calculated on the assumption that the alloy is a mechanical mixture of the two metals?

302. The specific heat of sulphide of mercury (Hg S) was found by experiment to be 0.0512. How does this value agree with that calculated on the assumption made in the last problem?

303. A piece of iron weighing 20 grammes at the temperature of 98° is dropped into a glass vessel weighing 12 grammes, and containing 150 grammes of water at 10° . The temperature of the water is thus raised to $11^\circ.29$. Required the specific heat of iron, knowing that the specific heat of glass is 0.19768.

304. The weights of different substances, w_1, w_2, w_3, w_4 , at the respective temperatures $t_1^\circ, t_2^\circ, t_3^\circ, t_4^\circ$, and having the respective specific heats c_1, c_2, c_3, c_4 , are supposed to be mixed together. Required the temperature of the mixture in terms of the other values.

305. Calculate the specific heat of oil of turpentine from the following data: 42.57 grammes of the oil at $33^\circ.7$ were mixed with 470.3 grammes of water at $12^\circ.23$; the temperature of the mixture was found to be $13^\circ.07$; the oil was enclosed in a glass tube weighing 5.25 grammes and having a specific heat equal to 0.177; lastly, the water was contained in a copper vessel weighing 45.25 grammes, and having a specific heat equal to 0.095.

306. A platinum ball weighing 150 grammes is heated to $1,000^\circ$, and then plunged into one kilogramme of water at 10° . After an equilibrium is established, how high is the temperature of the water, assuming that the water receives all the heat which the platinum ball loses? If the water is contained in a brass vessel weighing 200 grammes, how high would be the temperature of the water?

307. A platinum ball weighing 100 grammes, after having been exposed for some time to the heat of a furnace, is thrown into a brass vessel

containing 750 grammes of water at 5° . The weight of the brass amounted to 150 grammes, and the temperature of the water after the equilibrium was established to 15° . What was the temperature of the furnace, assuming that no heat was lost from the vessel and water during the experiment?

308. How much heat is required to raise the temperature of one cubic metre each of air, oxygen, carbonic acid, and hydrogen from 0° to 15° , assuming that the gas is allowed to expand freely, and that the pressure is constant at 76 c. m.

309. A room measures 7 metres by 6 on the floor, and is 4 metres high. How much heat is required to raise the temperature of the air in that room from 5° to 18° when the barometer stands at 76 c. m.? How much heat is lost in expanding the air of the room?

310. How much heat would be required to raise 1,000 kilogrammes of water 100 metres, if the full effect of the heat were realized?

EXPANSION.

(239.) *Coefficient of Expansion.* — It has already been stated (216) that the first effect of heat on matter, in either of its three states, is to expand it; and we have also examined the most important means by which the effects of expansion are used as a measure of temperature. We will now study the phenomena of expansion more in detail; but, first, we will establish a few formulæ by which the amount of expansion can be, in any case, readily calculated.

Linear Expansion. — The small fraction of its length by which a rod of iron, or of any other solid, one metre long, expands, when heated from 0° to 1° , is called the *Coefficient of Linear Expansion* of the solid. A bar of iron one metre long at 0° becomes 1.0000122 at 1° , and the small fraction 0.0000122 is the coefficient of linear expansion of iron. If we assume that the expansion is proportional to the temperature, then a bar of iron one metre long at 0° becomes 1.00122 metres long at 100° , 1.00244 at 200° , 1.0061 at 500° , etc. Hence a bar of iron 26.354 metres long at 0° would become $1.0061 \times 26.354 = 26.515$ at 500° . To make the solution general, let $k =$ coefficient of expansion; then $1 + k =$ increased length of a rod which is one metre long at 0° , when heated to 1° , and $(1 + tk) =$ increased length at t° . Hence $l(1 + tk) =$ increased length of

a rod at t° which is l metres long at 0° . Representing, then, by l' , this increased length, we have

$$l' = l(1 + tk); \quad [164.]$$

by which we can easily calculate the length of a rod of any metal at t° , when its length at 0° and its coefficient of expansion are given. The coefficients of expansion of the solids most frequently used in the arts are given in Table XV.

It is frequently the case that we do not know the length of the rod at 0° , but only at some other temperature, t , and it is required to determine the length at a second temperature, t' , which may be either higher or lower than t . To obtain a formula for the purpose, denote by l the unknown length of the rod at 0° , by l' the known length at t° , and by l'' the required length at t'° . We have then, as above,

$$l' = l(1 + tk), \quad \text{and} \quad l'' = l(1 + t'k).$$

By combining these equations, we obtain

$$l'' = l' \left(\frac{1 + t'k}{1 + tk} \right) = l' [1 + k(t' - t) + \&c.] \quad [165.]$$

All the terms of the quotient after the first may be neglected, because they contain powers of the already very small fraction k .

We have assumed that the expansion of solids is proportional to the temperature, but this is not strictly true; for the rate of expansion of solids, like that of mercury (219), increases, although but very slightly, as the temperature rises. The coefficient of expansion is not, therefore, absolutely the same at all parts of the thermometer-scale; but the difference is so small that we can neglect it, except in the most refined investigations, more especially if we use, not the coefficient observed at any particular temperature, but a mean coefficient obtained by dividing by 100 the total amount of expansion between 0° and 100° , by which means we average the error.

Cubic Expansion. — The small fraction of its volume by which one cubic centimetre of a solid, liquid, or gas increases when heated from 0° to 1° , is called the *Coefficient of Cubic Expansion* of that substance. The coefficient of expansion of mercury, for example, is 0.00018; that is, one cubic centimetre of mercury at 0° becomes 1.00018 $\overline{\text{c.m.}^3}$ at 1° . Assuming then

that the expansion is proportional to the temperature, we obtain, by the same course of reasoning as above, the formula

$$V' = V(1 + t K); \quad [166.]$$

by which the increased volume (V') of any mass of matter may be calculated, when the volume at 0° (V), the temperature (t), and the coefficient of cubic expansion (K), are known. In like manner we easily obtain the formula

$$V'' = V' [1 + K (t' - t)], \quad [167.]$$

which will enable us to calculate the volume of a body at t'° from the volume at t° and the coefficient of expansion.

(240.) *The Coefficient of Cubic Expansion is three times as great as the Coefficient of Linear Expansion.* — The truth of this simple principle, which enables us to calculate one coefficient when the other is given, can easily be proved. For this purpose, let us suppose that we have a cube of glass measuring one centimetre on each edge at 0° ; and let us inquire what will be its increased volume at 1° , assuming that the coefficient of linear expansion is known. At 1° each edge of this glass cube will be $(1 + k)$ c. m. long. Hence the increased volume of the cube will be equal to $(1 + k)^3 = 1 + 3k + 3k^2 + k^3$; but as k is an exceedingly small fraction, k^2 and k^3 may be neglected in comparison without any sensible error, so that the volume of a cube of glass which is one cubic centimetre at 0° becomes $(1 + 3k)$ c. m.³ at 1° . Since by [166] the volume of this same cube at 1° would also be expressed by $(1 + K)$ c. m.³, it follows that $K = 3k$, which was to be proved.

(241.) *The increased capacity of a hollow vessel, in consequence of the expansion of its wall, may be found by calculating the increased volume of a solid mass of the same substance which would just fill the interior of the vessel.* — A moment's reflection will show the truth of this statement. Let the hollow vessel be a glass globe, and let us conceive of it as filled with a solid globe of glass. If this mass be heated, it is evident that the glass vessel will expand just as if it formed the outside shell of a solid globe; the same must be true when the interior core is not present.

Expansion of Solids.

(242.) *Measurement of Linear Expansion.* — The earliest accurate determinations of the coefficients of linear expansion of solids were made by Lavoisier and Laplace with the apparatus represented in perspective by Fig. 367, and in section by Fig. 368. This apparatus consisted of two parts: first, of a copper tank, in which a bar made of the solid whose coefficient was to be determined was heated to a uniform temperature by immersing it in heated oil or water; and, secondly, of four stone posts supporting an ingenious contrivance for measuring the increase of

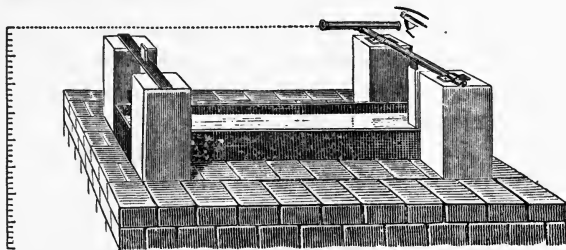

Fig. 367.

length. The solid bar, about two metres in length, rested in the tank on rollers, with one end bearing against an upright immovable glass bar, *F* (see Fig. 368), firmly fastened by cross-pieces to the two stone posts on the left-hand side of Fig. 367, and with the other end bearing against the lever, *D*. The upper end of

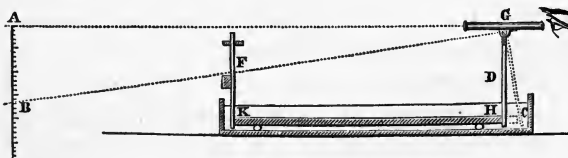

Fig. 368.

this lever was attached to a horizontal axis turning in sockets inserted into the two stone pillars on the right of Fig. 367, and having at one end the telescope, *G*, adjusted with its axis perpendicular to the lever *D*. The telescope was furnished with a micrometer eye-piece, and as it was turned by the expansion of the bar, the cross-wires moved over the divisions of a scale, *A B*, placed in a vertical position at the distance of fifty metres or more from the instrument.

The apparatus was used in the following manner. The bar having been placed in position, the tank was filled with ice-cold water, and the observer noted the division of the scale on which the cross-wire of the telescope was projected. The cold water was then withdrawn by a stopcock, and its place supplied with boiling water. The temperature soon became stationary and was ascertained by thermometers placed at the side of the bar, when the observer again noted the division on the scale with which the cross-wire of the telescope coincided. Knowing, now, the distance AB on the scale over which the cross-wire had moved, also the distance AG of the scale from the axis of rotation of the telescope, and, lastly, the length of the lever GH , it was easy to determine the value of HC , the elongation of the bar. The two triangles ABG and HCG are similar by construction, and we have $HC : HG = AB : AG$, or $HC = AB \frac{HG}{AG}$. The value of $\frac{HG}{AG}$ depends, evidently, on the dimensions of the apparatus. In that used by Lavoisier and Laplace it was about $\frac{1}{744}$, so that $HC = \frac{AB}{744}$, and hence any error in the measurement of AB was divided 744 times in the result.

The length of the bar at 0° being known, and the elongation corresponding to an observed number of degrees having been measured as just described, it was easy to determine the coefficient of expansion by dividing the elongation in fractions of a metre by the length of the bar in metres and by the number of degrees. For example, let us suppose that the length of the bar at 0° was 1.786 m., and that the elongation corresponding to 80° was 0.004; the coefficient of expansion would then be $0.004 \div (1.786 \times 80) = 0.000028$.

Since the experiments of Lavoisier and Laplace, the linear coefficient of expansion of glass and of the metals most used in the arts has been redetermined by a number of physicists, and with various methods; but as these methods do not involve the application of any new principle, it is not important to describe them.

(243.) *Determination of Coefficient of Cubic Expansion.* — We have already seen that the coefficient of cubic expansion is three times that of linear expansion, so that the cubic expansion of a homogeneous solid can always be easily calculated from the

linear expansion. In many cases, however, the coefficient of cubic expansion can be measured with more accuracy than the other, and it is then best to reverse the calculation. The coefficient of cubic expansion of several solids can be determined with great accuracy, by means of a process based on the apparent expansion of mercury, which will be described in (254). It can also be determined in the following manner from the specific gravity of the solid taken at different temperatures:—

Let $(Sp. Gr.)$ and $(Sp. Gr.)'$ represent the specific gravity of the solid at the temperatures t and t' respectively. Also let W represent the weight of the solid mass used in the experiment, V the volume at 0° , and K the unknown coefficient which we wish to determine. We have then, by [166], for the volume of the solid body at t° and t'° , the values $V(1 + tK)$ and $V(1 + t'K)$; by substituting these values in [55] we obtain, for the value of the specific gravity at the two temperatures,

$$(Sp. Gr.) = \frac{W}{V(1 + tK)}, \quad \text{and} \quad (Sp. Gr.)' = \frac{W}{V(1 + t'K)}.$$

Combining these two equations, and reducing, we get for the value of the coefficient of cubic expansion,

$$K = \frac{(Sp. Gr.) - (Sp. Gr.)'}{(Sp. Gr.)' t' - (Sp. Gr.) t}. \quad [168.]$$

Kopp has determined, by the above method, the coefficient of cubic expansion of a number of solids, and his results are included in Table XV.

(244.) *General Results.*—By examining Table XV. it will be seen that the increase of length which a solid bar undergoes when heated from 0° to 100° is at most very small, amounting in the case of zinc, the most expansible of all solids hitherto observed, to only $\frac{1}{347}$ of the length at zero. The difference, however, between different solids is very great, zinc expanding over three times as much as glass for the same increase of temperature.

The relative expansibility of solids seems to be more nearly related to their relative compressibility than to any other physical quality; for we find, as a general rule, that those metals are the most expansible which have the smallest coefficients of elasticity (101) and are therefore most easily compressed. This fact is shown by the two following series, in which the

metals are arranged in the order of expansibility and compressibility : —

Zinc, Lead, Tin, Silver, Gold, Palladium, Copper, Platinum, Steel, Iron, Glass.

Lead, Tin, Gold, Silver, Zinc, Palladium, Platinum, Copper, Steel, Iron, Glass.

Although these two series are not perfectly parallel, they are sufficiently so to indicate a close connection between the two properties. This connection is also seen in the fact, that the diminution of the coefficient of elasticity with the increase of temperature, already noticed (101), is accompanied with a corresponding increase of the rate of expansion.

The increase of the coefficient of expansion between 0° and 100° is hardly perceptible in solids; but when the change of temperature amounts to several hundred degrees, it is necessary to take account of it in delicate physical measurements. This is especially the case with the glass vessels which are used for air thermometers or in determining the specific gravity of vapors; and in order to furnish the necessary data for such experiments, Regnault has determined the mean coefficients of cubic expansion of the common Paris glass, when blown into hollow ware, between zero and different temperatures. His results are as follows : —

Between 0° and 100°	.	.	.	$K = 0.0000$	276.
" " " 150	.	.	.	"	0.0000 284.
" " " 200	.	.	.	"	0.0000 291.
" " " 250	.	.	.	"	0.0000 298.
" " " 300	.	.	.	"	0.0000 306.
" " " 350	.	.	.	"	0.0000 313.

From the fact that the rate of expansion of a solid increases with the temperature, we should naturally infer that the rate for any given solid would be greatest just below its melting-point; and of several solids taken at the temperature of the air, we should expect, other things being equal, that those would be the most expansible which are nearest their melting-points at this temperature, or, in other words, which are the most fusible. This we find, as a general rule, to be true; the easily fusible solids, like zinc and lead, being more expansible than the

difficultly fusible, like iron and platinum: but there is by no means a perfect parallelism between the order of fusibility and that of expansibility; nor ought we to expect it, for different metals are not equally expansible at temperatures equally distant from their melting-points.

(245.) *Expansion of Crystals.* — We have hitherto assumed that solid bodies expand equally in all directions, and this is true of all homogeneous solids; but it is not necessarily the case with crystals. Only those crystals which belong to the Regular System expand equally in all directions. Those belonging to the other systems expand unequally in the direction of the unequal axes. This inequality in the expansion of crystals in the directions of unequal axes can be readily detected, because an alteration in the relative length of the axes must change the interfacial angles of the crystal, which can be measured with great accuracy (96). Professor Mitscherlich,* of Berlin, who has very carefully studied this subject, found that the interfacial angles of all crystals, except those belonging to the regular system, were slightly affected by changes of temperature. The rhombohedral angle of calc-spar, for example, (page 150,) varies eight and a half minutes between the freezing and boiling points of water. Indeed, Mitscherlich has shown that, while a crystal is expanding in length by heat, it may actually be contracting in another dimension. These facts are in entire harmony with the principles of the last section; for, since the elasticity of crystals is different in different directions (108), we should naturally expect that the rate of expansion would be different also.

In investigating the laws of expansion of solids, it is evidently advisable to make choice of crystallized bodies; for when the substance is not crystallized, the expansion of different specimens may not be precisely the same, owing to variations of internal structure. This is probably the cause of the discrepancies which we find between the coefficients of expansion of the same substance as given by different experimenters. These discrepancies, indeed, are the most marked in the case of substances like glass, in which we should naturally expect the greatest variations of structure.

The expansion of glass has been more carefully studied than

* Poggendorff's Annalen, I. 125, X. 137, XLI. 213.

that of any other substance, on account of its use in physical apparatus. Regnault has found, not only that the expansion of glass varies with its composition, but also that it varies with the manner in which it has been worked. Thus, the same glass expands more in the form of a solid rod than in that of a tube, and a large vessel frequently expands at a different rate from a small vessel made of precisely the same material. Indeed, Regnault has shown that the coefficient of the same glass vessel is not always absolutely the same between the same limits of temperature, especially if between two observations it has been exposed to great and sudden thermal changes. These variations are probably due to changes in the molecular condition of the glass, and are similar to those which cause the change in the zero point of the thermometer (220).

It follows from the above facts, that, where very great accuracy is required, it is important to determine the rate of expansion of the actual vessel which is to be used in the experiment.

(246.) *Force of Expansion.*—The force with which a body expands is equal to the resistance which it would oppose to a compression of an equal amount; we have already seen (101) how very great this resistance is. A bar of iron one metre long expands 0.0012 m. if heated 100° . If now we assume that the area of the section of the bar is equal to $2,500 \overline{\text{m.m.}}^2$, and that the coefficient of elasticity of iron is equal in round numbers to 21,000, we can readily calculate by [66] the weight which would be required to compress the bar 0.0012. This weight would be $21,000 \times 2,500 \times 0.0012 = 63,000$ kilogrammes, and it would be necessary to apply this enormous force in order to prevent a bar of iron measuring 5 c. m. on each side from expanding, when heated from 0° to 100° . It is not, therefore, at all wonderful that iron bars used in buildings frequently destroy the masonry they were intended to strengthen, where care has not been taken to allow for the expansion.

The force with which a solid contracts when cooled is equal to that with which it expands when heated. This force was first used at the *Conservatoire des Arts et Métiers*, in Paris, for drawing together the walls of an arched gallery which had bulged outward from the pressure of the roof, and the experiment has since been successfully repeated in several other buildings. Stout iron rods were placed across the building, and their ends

secured to the outside of the walls by means of plates and nuts. Half of the number of rods were then strongly heated by charcoal furnaces, and when they were expanded the plates were screwed firmly up to the walls. As the bars cooled, they contracted and drew the walls somewhat nearer together. The same process was then repeated with the other half of the rods, and so continued until the walls were restored to a perpendicular position.

Applications of this same force may be seen in many of the trades. The wheelwright binds the parts of a wheel together by putting on the iron tire while hot, and allowing it to contract round the wood; and even the large wrought-iron tires round the wheels of locomotive engines are fastened in the same way. The cooper insures the tightness of a cask by surrounding it with heated iron hoops, which, by contracting, unite the staves more firmly; and steam-boilers are riveted with red-hot rivets, which, on cooling, draw the plates together more securely than any other means could.

(247.) *Illustrations.*—The expansion of solids by heat may be illustrated by a great variety of experiments, but we shall only be able to describe a few of the most striking.

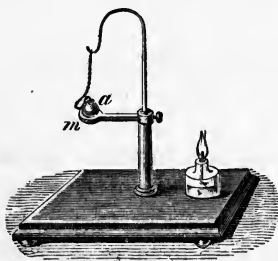

Fig 369.

The cubic expansion may be shown by means of the apparatus represented in Fig. 369. The brass ball *a* is made so that it will just pass through the ring *m*, when both have the same temperature. If then we heat the ball, it will no longer pass through in any position, thus indicating an increase of volume.

In order to illustrate the linear expansion of solids, we make use of a class of instruments called *pyrometers*. One of the simplest and most convenient of these is represented in Fig. 370. It consists essentially of the metallic rod *A*, one end of which is firmly secured to a brass pillar by means of the clamp-screw *B*, while the other end, which is free to expand, plays against the shorter arm of a needle, *K*, moving on a graduated arc. The rod is heated by an alcohol lamp of peculiar construction, and its expansion is rendered visible by the motion of the needle over

the graduated arc. Instruments constructed on the same principle have been employed by Daniels and others for measuring high temperatures ; but since they have been superseded by the

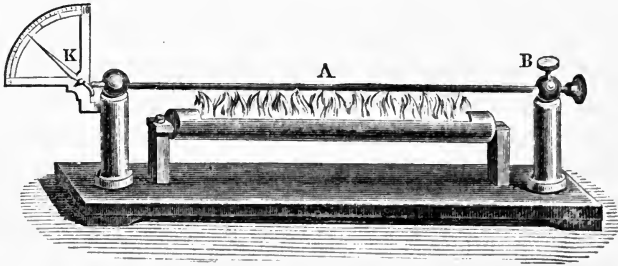

Fig. 370.

far more accurate methods of the present day, it is not necessary to describe them in detail.

The unequal expansion of different metals is best illustrated by a compound bar, made by riveting together two bars of iron and copper at different points through their whole length, as represented in Fig. 371. When such a bar is heated, the copper expands more than the iron, and the bar curves, as represented in Fig. 372, in order to accommodate the inequality of length which thus results.

Fig. 371.

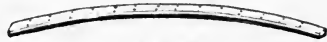

Fig. 372.

If the bar is cooled, it again curves, but in the opposite direction.

The expansion of solids is also illustrated by many phenomena of every-day life. A nail driven into a brick wall becomes loose after a time, because the iron expands in summer and contracts in winter more than the mortar, and thus the opening is enlarged. Clocks go faster in winter and slower in summer, because the pendulum elongates in summer, and consequently vibrates more slowly ; while in winter it becomes shorter, and vibrates more rapidly. The pitch of a piano or harp rises in a cold room, in consequence of the contraction of the metallic strings. A closely-fitting iron gate, which can be easily opened on a cold day, can only be opened with difficulty on a warm day, because both the gate and the adjoining railings have become expanded by the heat. When iron pipes are employed

to conduct steam through a factory, they are never allowed to abut against a wall or other obstacle, which they might injure in expanding; and, for the same reasons, the rails of a railroad are always laid at a little distance apart. A kilometre of rails expands seven metres between -20° and 40° , and this allowance must be made in the construction of the road. When a metal is soft, and its expansion or contraction at all resisted, it may become permanently expanded when repeatedly heated. A waste steam-pipe of lead has been elongated several inches in a few weeks, and the zinc or lead linings of bath tubs are frequently gathered in ridges from the same cause.

The walls of buildings are also sensibly expanded by the action of the sun's rays. Bunker Hill Monument, an obelisk of granite two hundred and twenty-one feet high, moves at the top so as to describe an irregular ellipse with the sun's motion. Professor Horsford, who had an opportunity of studying the action of the sun's rays on this structure, noticed that the movement commenced early in the morning on a sunny day, and attained its maximum in the afternoon. In a cloudy day no motion takes place, and a shower restores the shaft to its position,—showing that the heat which produces the deflection penetrates but a short distance.* A similar fact is also noticed when astronomical instruments are placed on elevated buildings, from the derangement which they undergo by the unequal expansion of the walls.

When hot water is poured on a thick plate of glass, the upper surface is expanded before the heat reaches the under surface of the plate. There is, therefore, an unequal expansion, and the plate tends to bend, like the compound bar, with the hot surface on the outside of the curve; and since the particles of glass do not readily yield to such displacement, the glass breaks. Hence is explained the fact, that hot vessels of glass or porcelain are liable to break when cold water is poured into them, or when set down on a cold surface which is at the same time a good conductor of heat. Such accidents are avoided by resting the vessel on rings of straw, or other poor conductors, and having them made as thin on the bottom as is consistent with the necessary strength.

This effect of heat on glass is used in the laboratory for dividing

* Silliman's Philosophy, p. 329.

glass vessels which have been cracked or otherwise damaged, since a crack once started may be conducted in any direction by means of an iron rod heated to redness, or, still better, by means of a burning slow-match prepared expressly for the purpose.* In like manner the round necks of glass retorts, flasks, and other chemical vessels, can be cut off by means of an iron ring, which is first heated to a red heat in a furnace, and then held for a few moments around the neck. As soon as the neck is thus heated, a few drops of water let fall upon the heated part will cause the neck to crack off.

But by far the most remarkable illustration of the expansion of solids by heat is furnished by the Britannia Tubular Bridge. This bridge consists of two rectangular iron tubes (made of boiler plates firmly riveted together) 1,510 feet $1\frac{1}{2}$ inches long at 32° F., and varying from 23 feet in height at either end to 30 feet at the centre. These tubes, which are placed parallel to each other, are secured permanently to the central stone pier of the bridge, called the Britannia Tower; but at the other points of support they rest on friction rollers, and the free ends move backwards or forwards as the length of each tube changes with the temperature. An increase of temperature of 26° , viz. from 32° to 58° F., gives an increase of $3\frac{1}{4}$ inches in the whole length of the bridge, and the daily expansion and contraction varies from half an inch to three inches, usually attaining its maximum and minimum about three o'clock in the afternoon and morning. Since the tubes are immovably secured in the centre, only one half of this motion is visible at either end. "But the most interesting effect is that produced by the sun shining on one side of the tube or on the top, while the opposite side and the bottom remain shaded and comparatively cool. The heated portions of the tube expand, and thereby warp or bend the tube towards the heated side, the motion being sometimes as much as two and a half inches vertically and two and a half inches laterally."† The same phenomena may be seen at the Victoria Tubular Bridge, recently built at Montreal; but as the tubes of this bridge are

* For a recipe by which these slow-matches may be prepared, see *Mohr's Pharmacy*.

† For a very interesting and detailed account of these phenomena, see the large work on the Britannia and Conway Tubular Bridges, by Edwin Clark, Resident Engineer. 2 vols. and Atlas, London, 1856.

much shorter than those of the Britannia bridge, the extent of the motion is not so great.

(248.) *Applications of the Expansion of Solids.* — Bréguet's metallic thermometer (Fig. 373) is an application of the principle

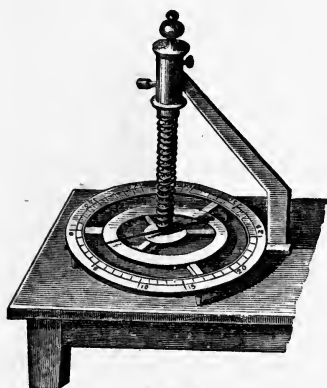

Fig. 373.

of the compound bar. The essential part of the instrument is a spiral, formed of a metallic ribbon which is constructed in the following way. Three small bars, one each of platinum, gold, and silver, are, in the first place, soldered together throughout their whole length. This compound bar is next rolled out in a rolling-mill until it is reduced to a ribbon not more than one sixtieth of a millimetre in thickness, and from one to two millimetres broad.

The ribbon thus prepared is wound into a spiral, having the silver face towards the interior, and this spiral is suspended to the upright arm of the instrument. To its lower end there is fastened a needle, which traverses an arc graduated into Centigrade degrees, and the whole instrument is covered with a glass bell for protection.

Although the ribbon is rolled out to the extreme degree of thinness just stated, yet the continuity of the three metals remains unbroken; so that the spiral may be regarded as consisting of three spirals of different metals united throughout their whole length. The silver spiral, which is the most dilatable, is surrounded, first, by a gold spiral, which expands less than the silver, and lastly by a platinum spiral, which expands the least of all. As the temperature rises, the silver expanding more than the platinum or the gold, each coil of the spiral tends to unbend, and the effect is evidently partially to uncoil the whole, causing the needle to move over the graduated arc from left to right in the above figure. The opposite effect ensues when the temperature falls. The gold band is placed between the two others, because it has an intermediate rate of expansion. Were platinum and silver used alone, the great inequality of their rates of expansion might cause the bands to separate. On account

of the small mass of metal of which the spiral consists, Bréguet's thermometer is exceedingly sensitive to very slight changes of temperature, and may be used in some cases with great advantage.

Some of the most ingenious applications of the expansion of metals are to be found among the numerous contrivances for retaining the pendulums of clocks of an invariable length at all temperatures. One of these, called Harrison's gridiron pendulum, is represented in Fig. 374. The large disk of this pendulum is suspended by a series of steel and brass rods, alternating with each other, and connected at the ends by cross-pieces. The manner in which these are arranged will be best understood by studying the figure, in which the steel rods are distinguished from the brass by being shaded. The length of the pendulum is evidently equal to the sum of the lengths of the steel rods, including the steel ribbon, b , which supports the whole pendulum and bends at each oscillation, less the sum of the lengths of the brass rods. Moreover, it will also be seen, by examining the figure, that, while the expansion of the steel rods lengthens the pendulum, the expansion of the brass rods shortens it. If, then, the lengths of the rods are so adjusted that the expansion in one direction will just balance that in the other, the pendulum will remain of an invariable length. It is easy to determine, approximately, the length required to produce this compensation.

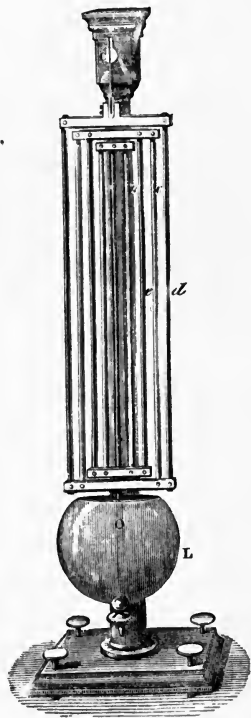

Fig. 374

Representing by L and L' the sum of the lengths of the steel and the brass rods respectively, and by k and k' their coefficients of expansion, we should have, since the amount of expansion is the same in both,

$$L k = L' k'.$$

Moreover, since at the latitude of Paris the length of the seconds pendulum is 0.99394 metre (58), we must also have

$$L - L' = 0.99394.$$

Combining these two equations, and substituting for k and k' their values from Table XV., we should find that the pendulum would remain of an invariable length when the sum of the lengths of the steel rods, or L , = 2.31919 metres, and when the sum of the lengths of the brass rods, or L' , = 1.32525 metres. It is evident, therefore, that compensation could not be effected with fewer rods than are represented in the figure, namely, three of steel and two of brass.

The above calculation, however, only gives approximate results, since the virtual length of the pendulum depends on the position of the centre of oscillation, and may vary, even when the apparent length remains the same (54). In practice, the rods are constructed as nearly as possible of the required length, and the compensation is afterwards completed by varying the position of the weight o , until, after successive trials, the right point is attained.

A clockmaker by the name of Martin effected the compensation in pendulums by means of a compound bar of iron and copper, fixed transversely on the pendulum rod, as represented in Fig. 375. To the ends of this compound bar small weights are attached, movable on a screw, and the bar is so placed that the copper is lowest. Hence, when the temperature rises, its ends

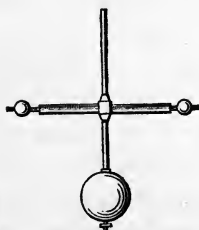

Fig. 375.

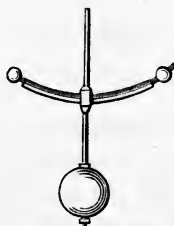

Fig. 376.

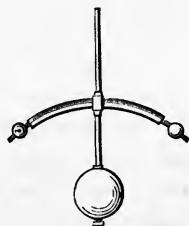

Fig. 377.

curve upwards, as represented in Fig. 376; and, on the other hand, they curve downwards, as in Fig. 377, when the temperature falls. The rising and falling of these masses of matter will evidently change the virtual length of the pendulum, by raising or lowering the centre of oscillation. Moreover, this change will be just the reverse of that caused by the action of heat on the pen-

dulum itself; and, by varying the position of the small weights on the transverse bar, the two changes may be made exactly to counteract each other.

An arrangement precisely similar to that of Martin has long been employed for compensating the balance-wheels of chronometers and watches. It is well known that the motion of a watch is regulated by a balance-wheel, as that of a clock is by the pendulum, and that the oscillations of this balance-wheel are maintained by a fine spiral spring, whose elasticity takes the place of the force of gravity acting on the pendulum of the clock. Now, the duration of an oscillation of a balance-wheel depends on the elasticity of the spring, on the radius of the wheel, and on the mass of matter in its rim. The effect of heat is to increase the radius, and thus to retard the watch by increasing the duration of each oscillation. This effect, however, can be entirely counteracted by the arrangement represented in Fig. 378. The three metallic arcs, *a, a, a*, are each made of two metals, the most expansible being placed outside; and as the temperature rises, they curve in and carry the three small masses of matter, *n, n, n*, nearer to the axis of the wheel, thus diminishing the virtual length of the radius as much as the expansion increased it. The position of the small masses *n, n, n*, in which the effect of expansion is just compensated, is found by trial; and they are adjusted by turning them on the small screws which form the extremities of the arcs.

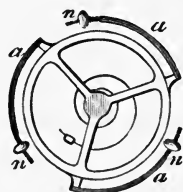

Fig. 378.

Expansion of Liquids.

(249.) *Absolute and Apparent Expansion.* — In considering the expansion of a liquid, it is important to distinguish between the *absolute* expansion and the *apparent* expansion when the liquid is enclosed in a glass vessel. From the very nature of a liquid, it is evident that its absolute expansion cannot be directly observed, but must be determined by indirect methods. It is also evident, that the absolute expansion must be equal, in any case, to the apparent expansion, increased by the amount of expansion of the glass vessel containing the liquid; compare (219) and (241); and hence, when any two of these quantities are known, the third can always be calculated.

(250.) *Absolute Expansion of Mercury.* — The coefficient of absolute expansion of mercury is one of the most important constants of physics; for not only does it enter indirectly into the determination of the expansion of most other substances, — solids, liquids, and gases (254), — but it also has a direct bearing on the theory and use of both the thermometer and barometer (219) and (160). It is therefore essential that this constant should be determined with the greatest care.

The most accurate method of determining the coefficient of absolute expansion of mercury is based upon the principle in hydrostatics (131), that, when two tubes filled with different liquids communicate together, the heights of the two liquid columns if in equilibrium are inversely proportional to the specific gravities of the liquids. What is true of different liquids must also be true of the same liquid at different temperatures; and we can therefore determine the relative specific gravity of mercury at such temperatures by measuring the heights of the mercury-columns in the legs of an inverted siphon, so arranged that each column may be exposed to the temperature required. When the specific gravity at two different temperatures has been thus determined, we can easily calculate the coefficient of expansion by [168].

The apparatus used by Dulong and Petit, who determined the absolute expansion of mercury by the hydrostatic method, is

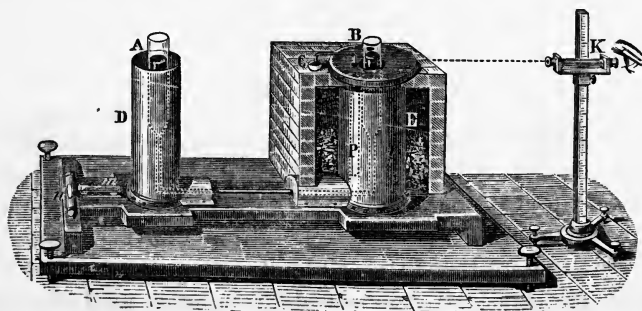

Fig. 379.

represented in Fig. 379. It consisted of two glass tubes, *A* and *B*, supported vertically on an iron basement, and united below by a capillary tube, so as to form together an inverted siphon.

The two tubes were each enclosed in a metallic vessel. The smallest of these, *D*, was filled with pulverized ice, and the other, *E*, contained oil, which was gradually heated by a small furnace, which the figure represents in section, in order to show the construction. Lastly, the tubes were filled with mercury, which preserved the same level in both as long as the tubes were exposed to the same temperature, but which rose in the tube *B* in proportion as it was heated. In making an observation with this apparatus, the bath was first heated to the required temperature, which was indicated by the thermometer *P*, and then the heights of the two columns were measured by the cathetometer *K*.

In order to calculate from such an observation the coefficient of absolute expansion, let us represent by *H* and (*Sp. Gr.*) the height and specific gravity of the mercury-column *A* at 0°, and by *H'* and (*Sp. Gr.*)' the height and specific gravity of the mercury-column *B* at *t*°. Then we have, by [81], $H \cdot (\text{Sp. Gr.}) = H' (\text{Sp. Gr.})'$. Moreover, representing the coefficient of absolute expansion of mercury by *K*, we have, by [166] and [56],

$$(\text{Sp. Gr.}) = (\text{Sp. Gr.})' (1 + K t). \quad [169.]$$

Combining the two equations, we obtain, for the value of *K*,

$$K = \frac{H' - H}{H t}. \quad [170.]$$

By this method, Dulong and Petit found that the mean absolute expansion of mercury between 0° and 100° was $\frac{1}{5550} = 0.00018018$. Regnault has since redetermined this coefficient with an apparatus based on the same principle, but very greatly improved, and has obtained, for the mean value between 0° and 100°, 0.00018153, a number which differs but little from that of Dulong and Petit. The apparatus of Regnault, although very simple in principle, is quite complicated in construction, and it would require more space to describe it than we are able to give; but the student will find it described in full in Regnault's memoir on the subject.*

As has already been stated (219), the coefficient of expansion of mercury increases with the temperature. This is shown by the following table, which contains the results obtained by Regnault.

* Mémoires de l'Académie des Sciences de l'Institut, 1847.

True Temperature by Air-Thermometer.	Mean Coefficient of Expansion of Mercury from 0° to t° .	Actual Coefficient of Expansion from t° to $(t+1)^\circ$.	Volumes of Equal Weights.
0°	0	0.00017905	1.0000000
30	0.00017976	0.00018051	1.0053928
50	0.00018027	0.00018152	1.0090135
70	0.00018078	0.00018253	1.0126546
100	0.00018153	0.00018305	1.0181530
150	0.00018279	0.00018657	1.0274185
200	0.00018405	0.00018909	1.0368100
250	0.00018531	0.00019161	1.0463275
300	0.00018658	0.00019413	1.0559740
350	0.00018784	0.00019666	1.0657440

In the last column of this table we have given the volume to which one cubic centimetre of mercury will expand when heated to the different temperatures indicated in the first column. This volume may be calculated by means of the formula $V = 1 + tk$, whenever the corresponding mean coefficient between 0° and t° (as given in the second column of the table) is known; and for temperatures for which the coefficient has not been determined, it can be ascertained sufficiently near by interpolation. It is convenient, however, to have a single formula by which the volume can be calculated at once for any temperature; and such a formula can be obtained by applying the principle of [130].

Since the volume is always some function of the temperature, it can be expressed by the general formula, into which every algebraic function may be developed,

$$V = A + Bt + Ct^2 + Dt^3 +, \text{ \&c.} \quad [171.]$$

In the present case, A is equal to unity, the volume when the temperature is zero, and the other coefficients can be found by substituting in the general equation [171] the value of A , and also the values of V and t for each temperature at which the volume has been experimentally determined. We shall thus obtain as many equations as there are determinations, and by combining them together according to the well-known methods of algebra we can easily calculate the coefficients required. Making use of Regnault's results, as given in the above table, we should thus obtain for the volume of mercury at any temperature, t , as indicated by an air-thermometer, the value,

$$V = 1 + 0.000179007 t + 0.0000000252316 t^2. \quad [172.]$$

It is unnecessary to add that this formula is purely empirical, and can only be trusted for temperatures within the limits between which the experiments were made.

(251.) *Correction of the Observed Height of the Barometer for Temperature.* — Since the height of a barometer is affected by changes of temperature (160), it becomes essential, before comparing together different observations, to reduce each to the standard temperature of 0° ; in other words, to calculate what would have been the height had the temperature at the time of the observation been at the freezing-point. The principles of the last section furnish us with a ready method of making the reduction.

The pressure of the air being constant, it follows from (158) and [81] that the height of a mercury barometer at different temperatures will be inversely proportional to the specific gravity of mercury at these temperatures. Hence we shall have $H : H' = (Sp. Gr.)' : (Sp. Gr.)$, a proportion in which H and $(Sp. Gr.)$ represent the height of the column and the specific gravity of mercury at 0° , while H' and $(Sp. Gr.)'$ represent the same values at t° . But we also have $(Sp. Gr.) = (Sp. Gr.)' (1 + K t)$, and combining this with the last proportion, we at once deduce $H' = H (1 + K t)$, and

$$H = H' \frac{1}{1 + K t} = H' - H' \frac{K t}{1 + K t}; \quad [173.]$$

or, substituting for K its mean value between 0° and 100° ($0.00018 = \frac{1}{5550}$),

$$H = H' - H' \frac{t}{5550 + t}. \quad [174.]$$

The last term of the above formula is the correction which must be subtracted from the observed height, in order to reduce the observation to zero.

The reduction as thus made, however, would not be quite correct, since we have not taken into account the change in the length of the scale of the barometer caused by the expansion of the material on which it is engraved. If, as in the barometer of Fortin (160), this scale is engraved on the brass casing of the tube, which extends quite down to the cistern, it is easy to make allowance for the effect of its expansion, assuming that the scale agrees with the standard of length at 0° . Let us assume that the divisions on the scale are in centimetres. It is evident that the effect of

heat will be to increase the length of each division, and thus to make the apparent height of the mercury-column less than the real height. If the brass expanded as much as the mercury, the two effects would balance each other, and there would be no correction to make. But this is not the case; and the expansion of the brass scale only in part compensates for the increased height of the mercury-column caused by the change of temperature. Representing by k the coefficient of expansion of brass, we shall have, for the length of each division of the scale at t° , the value $1 + kt$; and since the apparent height of an invariable mercury-column must be inversely proportional to the length of the divisions of the scale, by which it is measured, we deduce the proportion $H : H_0 = 1 : 1 + kt$, in which H and H_0 represent respectively the apparent heights of the column at t° and 0° respectively. Substituting in this proportion the value of H [173], we readily deduce

$$H_0 = H' \frac{1 + kt}{1 + Kt} = H' - H' \frac{(K - k)t}{1 + Kt}. \quad [175.]$$

The second term of the above formula gives a correction, to be subtracted from the observed height of a mercury-column, which eliminates the expansion of the scale as well as that of the column itself, and reduces the observations strictly to 0° . The value of this correction, in centimetres, corresponding to one degree of temperature, is given in Table XVIII. for every five millimetres in the height of the mercury-column from 0.5 c. m. to 100 c. m., and not only for a barometer with a brass scale, but also for a barometer with the scale engraved on the glass tube. The correction for any given temperature is found by multiplying the number from the table opposite to the observed height by the number of degrees. If the degrees are above zero, the correction is to be subtracted from the observed height; if below, to be added to it. This same table, as well as the formula [175], may also be used for reducing to 0° the height of any mercury-column; for example, that in a manometer-tube (168), or in a glass bell over a mercury pneumatic trough (169). If the height of the column is measured by means of a cathetometer, as in Fig. 272, it is equivalent to using a barometer with a brass scale, and the correction must be taken from the column headed "Brass Scale" in Table XVIII. If, on the other hand, it is measured by means of graduation on the glass bell or tube itself, the column headed "Glass Scale" should be used.

(252.) *Apparent Expansion of Mercury.* — The apparent expansion of mercury will evidently vary with the nature of the vessel in which it is enclosed. But since the vessels used for the purpose are almost invariably made of glass, we understand by the term *apparent expansion* the apparent expansion in glass, unless it is otherwise stated. The apparent expansion of mercury in glass can readily be determined experimentally by means of the apparatus represented in Fig. 380. It consists of a cylindrical reservoir opening into a capillary tube, which is drawn out at the end to a fine point, and bent into the form of a hook. The apparatus is in the first place weighed, and then filled with pure mercury, like a thermometer-tube (Fig. 340), taking care to boil the mercury in the reservoir in order to expel the last traces of air and moisture. It is next surrounded with melting ice, the orifice of the tube, *o*, dipping under mercury,



Fig. 380.

which is thus drawn into the apparatus as the temperature falls until the whole is filled with mercury at 0° . Having weighed the apparatus again, and subtracted the weight of the glass, we obtain the weight of the mercury at 0° , which we will represent by W . Finally, we expose the apparatus to a constant and known temperature, t° , (for example, to that of the steam from boiling water,) and collect and weigh the mercury which escapes. Call this weight w ; then $W - w$ is the weight of mercury which just fills the apparatus at t° . We have now all the data required for calculating the apparent coefficient of expansion.

The volume of $W - w$ grammes of mercury at 0° is, by [56], $V = \frac{W - w}{(\text{Sp. Gr.})}$. Neglecting the expansion of the glass, this weight of mercury occupies at t° the same volume which was filled by W grammes of mercury when the temperature was zero; viz. the volume of the apparatus. Hence, the volume of $W - w$ grammes at t° is $V' = \frac{W}{(\text{Sp. Gr.})}$. But if \mathfrak{k} represents the coefficient of apparent expansion, we have, by (239), $V' = V(1 + \mathfrak{k}t)$; and substituting the values of V and V' , we get, by reducing,

$$\mathfrak{k} = \frac{w}{(W - w)t} \quad [176.]$$

Dulong and Petit found, by this method, that the apparent coefficient of expansion of mercury in the common glass of Paris is $\frac{1}{64180}$; but evidently this coefficient depends on the expansion of glass, and is liable to all its variations (245).

(253.) We can also easily determine the apparent expansion of mercury by a thermometer-tube, whose stem has been divided into parts of equal capacity (221). For this purpose, we in the first place ascertain the relation between the volume of the reservoir and that of one of the divisions of the tube in the following way:—

The tube, having been weighed, is partially filled with mercury, and the point on the lower part of the stem at which the mercury stands in melting ice is carefully marked. Now re-weighing the tube, we find the weight of mercury which the tube and bulb contain below this index-mark. Call this weight W . An additional quantity of mercury is then introduced, so that, when the apparatus is again immersed in ice-water, the column stands at the n th division above the mark. A third weighing now gives the weight of mercury occupying, at 0° , n divisions of the tube. Call this weight w ; then $\frac{w}{n}$ is the weight of mercury which fills one division of the tube. Assuming the volume of one division of the tube as our unit of measure, and representing by N' the number of such units of volume which the bulb and tube contain below the index-mark, we have

$$N' = n \frac{W}{w}; \quad [177.]$$

and knowing the number of these arbitrary units of volume below the index-mark on the tube, we can by simple addition or subtraction find the number below any other division. Let us represent this number in general by N .

The bulb and tube having been thus gauged, in order to measure the apparent expansion of mercury we have only to determine the *two fixed points*, as in making a thermometer (218). The number of divisions on the stem between these points is the number of units of volume which N units of volume expand between 0° and 100° . Representing by n the number of divisions between the fixed points, we have, by [166],

$$N + n = N(1 + k 100), \quad \text{whence} \quad k = \frac{n}{100 N}; \quad [178.]$$

which is the coefficient required. This method, although not so accurate in the case of mercury as the one described in the last section, is much the more accurate of the two for other liquids.

(254.) *Relation between the Apparent and Absolute Coefficient of Expansion.* — It has already been stated (249), that the apparent increase of volume of mercury in a glass vessel is equal to the actual increase of volume diminished by the amount of expansion of the glass. A simple algebraic calculation will show that the *apparent coefficient* of expansion of mercury is also equal to the *absolute coefficient* diminished by the coefficient of expansion of the glass. Representing these quantities respectively by \mathfrak{k} , K , and K' , we have, in every case,

$$\mathfrak{k} = K - K' \quad (1), \quad \text{or} \quad K' = K - \mathfrak{k} \quad (2); \quad [179.]$$

so that we can always calculate either coefficient when the other two are known. Now the absolute coefficient of mercury is known with great accuracy, and we can therefore use the processes described in the last two sections for determining the coefficient of expansion of glass. Indeed, this is much the most accurate method we have, and the careful determinations made by Regnault of the coefficients of expansion of different kinds of glass, and of the same glass under different circumstances, were made in this way.

We can also use the method of (252) for determining the coefficient of expansion of any solid not acted on by mercury, when the coefficient of the glass used is known. For this purpose, a weighed amount of the solid (either in fragments or in the form of a bar) is introduced into a glass tube closed at one end, and the other end is then heated in a lamp and drawn out into the form represented in Fig. 380. The tube is next filled with mercury, and the experiment conducted in all respects as described in (252). We shall then have the following data for calculating the coefficient of expansion of the solid: 1. the weight of the solid (W), and its specific gravity (δ); 2. the weight of mercury in the tube at 0° (W'), and its specific gravity (δ'); 3. the weight of mercury in the tube at t° ($W' - w$); 4. the coefficients of mercury and glass (K and K'). Representing also by x the unknown coefficient of the solid, we can easily obtain it from the following equation, remembering that the volume of the tube either at 0° or t° must be equal to the volume of

the enclosed solid *plus* the volume of the mercury it contains at the temperature. See also [56] and [166].

$$\left(\frac{W}{\delta} + \frac{W'}{\delta'}\right)(1 + Kt) = \frac{W}{\delta}(1 + xt) + \frac{W' - w}{\delta'}(1 + Kt). \quad [180.]$$

From this we obtain the value of the coefficient,

$$x = \frac{1}{t} \cdot \frac{\delta w}{\delta' W} + \frac{(\delta' W + \delta W')K'}{\delta' W} - \frac{(\delta W' - \delta w)K}{\delta' W}. \quad [181.]$$

This method of determining the coefficient of expansion of solids admits, in many cases, of great accuracy. It was used by Dulong and Petit for determining the coefficients of cubic expansion of iron, platinum, and copper.

(255.) *Laws of the Expansion of Liquids.* — The fullest investigations on the expansion of liquids have been made by Kopp,* in Germany, and by Pierre,† in France. These experimenters followed essentially the same method. They determined, in the first place, the apparent expansion by means of a thermometer-tube, as described in (253), and afterwards corrected the results for the expansion of the glass. The following are the most important facts which are known in regard to the expansion of this class of bodies.

Liquids, like solids, expand with an almost irresistible force, which may be measured by the mechanical effort required to condense the expanded liquid to its initial volume (118). For the same increase of temperature, all liquids expand more than the most expansible solid. This we should naturally expect, from (244), because liquids are more compressible than solids; and in support of the same principle, we find that the order of expansibility of different liquids is nearly the same as the order of compressibility, although by no means identical with it. It may also be stated as a general rule, but one to which there are many exceptions, that the most expansible liquids are those which have the lowest boiling-points; this is especially true in regard to liquids which are allied in their chemical proper-

* Poggendorff, *Annalen*, Band LXXII. S. 223. Also *Ann. Chem. und Pharm.*, Band XCIV. S. 257; Band XCV. S. 307.

† *Annales de Chimie et de Physique*, 3^e Série, Tom. XV., XIX., XX., XXI., XXXI., XXXIII.

ties. The difference between the coefficients of expansion of different liquids for the extreme cases is very great. Thus, while the coefficient of mercury is only 0.00019 at the boiling-point, that of aldehyde is 0.002025, only one third less than that of air. The amount of expansion of different liquids for the same interval of temperature may therefore differ immensely.

The rate of expansion of all liquids increases with the temperature; but it varies according to different laws with different substances, and these laws appear to be very complicated. Of all liquids, the coefficient of expansion of mercury increases the most slowly, that of water the most rapidly, — the difference between the mean rate of increase in the two cases being (according to Regnault and Kopp) as 28 to 1,408. The following table, which includes also a few of the results of Pierre's investigation, will illustrate these facts.

Name of Liquid.	Coefficient of Expansion at Boiling-Point.	Coefficient of Expansion at 0°.	Mean Rate of Increase between 0° and Boiling-Point, for 1°.	Boiling-Point.
Mercury,	0.000197*	0.000179*	0.028	360°
Chloride of Amyle,	0.001693	0.001171	0.158	101.75
Terebene,	0.001328	0.000896	0.299	161
Ethylie Alcohol,	0.001347	0.001049	0.364	78.3
Methylie Alcohol,	0.001491	0.001185	0.409	63
Bromine,	0.001318	0.001038	0.429	63.04
Terechloride of Phosphorus,	0.001559	0.001129	0.521	78.34
Chloroform,	0.001488	0.001107	0.543	63.50
Amylie Alcohol,	0.001606	0.000890	0.611	131.8
Bromide of Methylie,	0.001559	0.001415	0.782	13
Chloride of Silicon,	0.001978	0.001294	0.896	59
Sulphurous Acid,	0.001820	0.001496†	1.154	-3
Aldehyde,	0.002121	0.001653	1.288	22
Water,	0.000765	0.000000‡		100

It has been found in a few cases, that, starting from the boiling-point, the volumes of liquids belonging to the same chemical group diminish, as the temperature falls, very nearly at the same rate. By this is meant, that, starting with equal volumes of such chemically allied liquids at their boiling-points, the volumes also will be equal at temperatures equally distant from these points. At least, this was observed to be true by Pierre in five

* Calculated from Regnault's formula [172].

† This coefficient of sulphurous acid is taken at $-25^{\circ}.85$.

‡ At 4° or point of maximum density.

separate instances; but unfortunately these groups consisted of only two or three liquids, and hence no general conclusions can be drawn from the facts.

The expansion of most liquids can be represented by a formula of the general form [171], with the same numerical coefficients for all temperatures between the limits of the experiment. The following are the formulæ for alcohol, ether, and oil of turpentine, as calculated by Kopp from the results of his own experiments:—

Alcohol, Sp. Gr. = 0.80950; B. P. = 78°.4; 0° to 79°.6.

$$V = 1 + 0.00104139t + 0.0000007836t^2 + 0.000000017618t^3.$$

Ether, Sp. Gr. = 0.73658; B. P. = 34°.9; 0° to 33°.

$$V = 1 + 0.00148026t + 0.00000350316t^2 + 0.000000027007t^3.$$

Oil of turpentine, Sp. Gr. = 0.884; B. P. = 156°; 9°.3 to 105°.6.

$$V = 1 + 0.0009003t + 0.0000019595t^2 + 0.0000000045t^3.$$

In each case are given the specific gravity, the boiling-point, and the limits of temperature between which the experiments from

which the formula is deduced were made. Strictly speaking, the formula only holds between these limits; but, nevertheless, it can be used without any important error for temperatures a few degrees either above or below the extreme limits, as, for example, to determine the volume of a liquid at the boiling-point.

The law of expansion which any given liquid obeys may also be expressed by means of a curve applying the principle already explained in (195). Fig. 381 represents three such curves, those of mercury, water, and alcohol. Here the numbers on the horizontal axis indicate degrees of temperature, and the numbers on the vertical axis the corresponding amount of expansion, expressed in fractions of the unit of volume. These curves illustrate several of the facts just

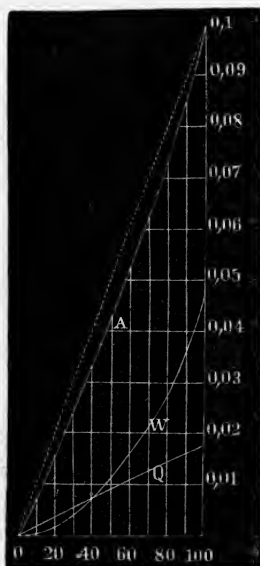

Fig. 381.

stated. It is evident, for example, that alcohol expands much more rapidly than either of the other two liquids. It will also

be noticed, that, although above 40° water expands more rapidly than mercury, yet below this temperature the order is reversed. Moreover, it will be seen that the curve of mercury is a straight line, showing that the amount of its expansion is proportional to the temperature, or, in other words, that the rate is uniform. (The small variation which actually exists is not sensible, on account of the reduced scale of the figure.) The curve of alcohol, on the other hand, bends in towards the vertical axis, indicating that its rate of expansion increases with the temperature; and the curve of water, bending much more strongly, points to a still more rapid variation.

(256.) *Expansion of Liquids above the Boiling-Point.* — It is a well-known fact, that, when a liquid is confined in a strong and hermetically-sealed vessel, its temperature may be raised very greatly above its boiling-point; and it becomes a very interesting subject of inquiry, whether the rate of expansion, which increases so rapidly as we approach this point, increases with equal rapidity above it. This subject has recently been investigated by C. Drion,* and he has arrived at the very remarkable conclusion, that under these circumstances the coefficient of expansion of a liquid not only increases at a constantly accelerated rate, but also that it may even surpass the coefficient of expansion of the gases. The experiments of Drion were made on chloride of ethyle, hyponitric acid, and sulphurous acid, and his results are given in the following table, which shows the coefficients of expansion of all three liquids at the temperatures indicated.

Temperature.	Coefficient of Expansion.		
	Chloride of Ethyle. B. P. = 11° .	Sulphurous Acid. B. P. = -8° .	Hyponitric Acid. B. P. = 22° .
0	0.001482	0.001734	0.001445
20	0.001699	0.002029	0.001596
40	0.001919	0.002371	0.001847
60	0.002202	0.002846	0.002230
80	0.002625	0.003608	0.002768
90	0.002910	0.004147	0.003081
100	0.003250	0.004859	
110	0.003690	0.005919	
120	0.004306	0.007565	
130	0.005031	0.009571	

Coefficient of expansion of air = 0.003665.

* Annales de Chimie et de Physique, 3^e Série, Tom. LVI.

It will be noticed that the coefficients of all three liquids increase with very great rapidity above their boiling-points, and that those of the first two soon exceed the coefficient of air. The same is undoubtedly the case with hyponitric acid; but it was impossible to push the experiment above 90° , because the deep color of the vapor obscured the position of the summit of the liquid column in the thermometer-tube.

These results confirm the following observation made by Thilorier, in 1835, in regard to the expansion of liquid carbonic acid, which has been hitherto received with great mistrust on account of its paradoxical nature, but which is now shown by Drion to be in perfect harmony with the laws of liquid expansion:—

“This liquid presents the strange and paradoxical fact of a liquid more expansible than the gases; in a word, its expansion is four times greater than air, which between 0° and 30° expands only $\frac{30}{67}$, while the expansion of liquid carbonic acid reduced to the same scale amounts to $\frac{116}{67}$.”*

(257.) *Expansion of Water.*—The expansion of water is far more irregular than that of any known liquid, although the total amount of expansion between 0° and 100° is comparatively small.

This fact is shown by the table on page 517, from which it appears that the coefficient of water increases as the temperature rises vastly more rapidly than that of any other liquid mentioned, although this coefficient, even at the boiling-point, is the smallest in the table with the single exception of that of mercury; and not only does the coefficient increase with this unparalleled rapidity, but also the rate of increase varies so irregularly, that it has been found impossible to express the volume of water at different temperatures by any single empirical formula. All this is true of the expansion of water between 10° and 100° , and below 10° the expansion is still more irregular than it was above; for water alone of all liquids has a point of maximum density above its freezing-point (4° C.), and from this temperature it expands, whether it be heated or cooled.

(258.) *Point of Maximum Density.*—This last fact, which is, so far as we know, a unique property of water, and seems to be a special adaptation in the plan of creation, can be very well

* Annales de Chimie et de Physique, 2^e Série, Tom. LX. p. 427.

illustrated by means of the apparatus represented in Fig. 382. The apparatus is essentially a large water thermometer, — a glass flask of about one litre capacity forming the bulb, and the tube being secured by leather packing in a brass cap, which screws into a collar of the same metal, cemented to the neck of the flask (see Fig. 383). The temperature of the water in the flask is given by a thermometer suspended from a hook on the under side of the cap, and the height of the column in the tube is observed by means of a wooden scale divided into millimetres, counting from a zero-point near the lower end.

If this apparatus is placed in a cold room, whose temperature is below the freezing-point, and carefully watched, the column of water in the tube will be seen to fall, until the thermometer in the flask marks about 6° . It will then be at its lowest point; for as the temperature falls still lower, the liquid column

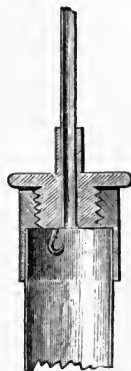

Fig. 383



Fig. 382.

will begin to rise in the tube, and continue to rise until the water freezes, although by keeping the apparatus perfectly still the water may be cooled several degrees below its normal freezing-point before this takes place.

The course of this very remarkable phenomenon may be best represented to the eye by means of a curve. In Fig. 384, the abscissas of the curve *abc* represent degrees of temperature, and the ordinates the corresponding height of the column of water in the tube of the apparatus (Fig. 382), measured from the zero-mark on the scale; and it will be noticed that the curve bends towards the axis of abscissas, reaching its lowest point at the temperature of about 6° . This curve does not, however, represent faithfully the variation in the volume of the water,

since the height of the liquid column in the tube depends on the expansion of the glass as well as on that of the enclosed liquid. But since we know the volume of the glass flask and its coefficient of expansion, it is easy to

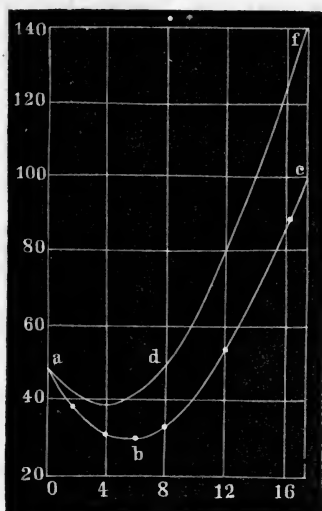

Fig. 384.

calculate the effect produced by its expansion; and thus we can reduce the observed heights of the column of water to what they would be, were the volume of the vessel absolutely constant. If, then, we construct a curve with these corrected heights, we shall obtain the curve *a d f*, which represents accurately the variation in the volume of water between 0° and 16° ; and it will be seen that the liquid has the smallest volume (or is most dense) at 4° .

There is another singular fact connected with this phenomenon. Starting from the point of maximum density, the rate of expansion

of water increases with very nearly equal rapidity, whether we heat or cool the liquid. This is illustrated by the water thermometer (Fig. 385), in which, as before described (219), the degrees have been proportioned to the rate of expansion. In this thermometer, as in the apparatus of Fig. 382, the water will be at the lowest point at 6° , and from this temperature the water will rise whether the instrument be heated or cooled, the length of the degrees in either case rapidly increasing. The temperatures below 6° are marked in the figure on the left-hand side of the scale of the instrument; but here, as before, the phenomenon is obscured by the expansion of the glass, so that the rate of expansion on either side of the point of maximum density cannot be directly compared. It is evident, however, that it increases in both cases with great rapidity; and were the tube and bulb inexpandible, the lowest point on the scale would be 4° , and the degrees on either side would be of equal lengths.

The fact that water has a point of maximum density was first noticed by the Florentine Academicians as early as 1670;

but the phenomenon was first carefully investigated by Lefèvre Gineau, while determining the French unit of weight, at the close of the last century (12). He fixed the point of maximum density, by weighing a mass of brass in water (135) and comparing the loss of weight at different temperatures, — taking care to reduce the results to what they would have been if the volume of the brass had remained absolutely constant. He found that water was most dense at $4^{\circ}.5$ C., and this result was confirmed subsequently by Hallstrom,* who, using essentially the same process, fixed the point of maximum density at $4^{\circ}.1$. Still later, Despretz,† in a very extended investigation, published in 1839, on the expansion of water from -9° to $+100^{\circ}$, also fixed the point of maximum density at 4° . Despretz used in his experiment thermometer-tubes, and measured the change of volume by the method described in (253), correcting, of course, the observed results for the expansion of the glass. These observations were evidently exposed to all the uncertainties connected with the expansion of glass, already noticed (245); and since, near the point of maximum density, the expansion of glass bears a very large proportion to that of water, a small error in the determination of this quantity may have caused an important error in the final result. In order to avoid this source of error, Plücker and Geissler,‡ who have made the most recent investigations on this subject, used thermometer-tubes very ingeniously contrived so that the expansion of mercury should correct that of the glass. They found it, however, impossible to determine with absolute accuracy the point of

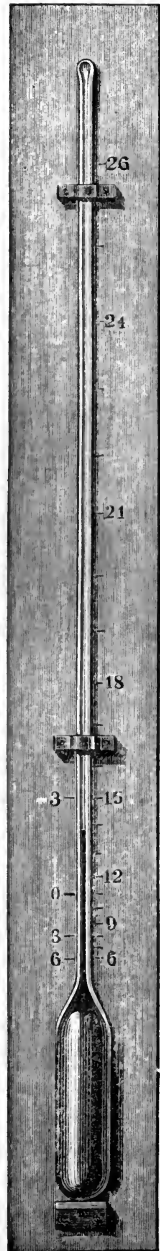

Fig. 385.

* *Annales de Chimie et de Physique*, 2^e Série, Tom. XXVIII. p. 56.

† *Comptes Rendus*, Tom. IV. p. 124; Tom. X. 131.

‡ *Poggendorff's Annalen*, Band LXXXVI.

maximum density by direct observation ; but they concluded that it must be very near $3^{\circ}.8$, and that it might be regarded for all practical purposes as at 4° without sensible error. Indeed, it is impossible with our present methods of observation to fix the point of maximum density within a quarter of a Centigrade degree ; nor is this important, since the volume of water does not vary perceptibly for a degree on either side of this point.

Fig. 386 gives a graphic delineation of the expansion of water between -4° and $+12^{\circ}$, according to the method of analytical

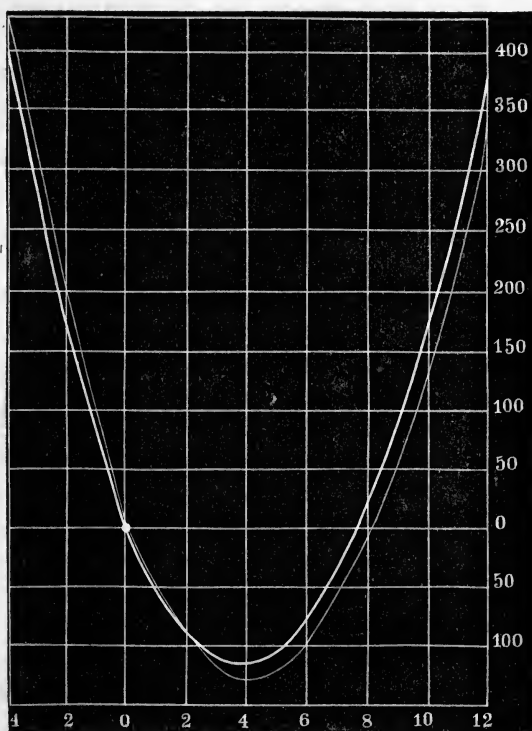

Fig. 386.

geometry. The curve drawn with a heavy line has been plotted from the results of Plücker and Geissler, and that with a light line from those of Despretz. The abscissas of the curves are the degrees of temperature, and the ordinates are the amounts of expansion, — the number on the vertical axis being in each case

so many millionths of the volume at 0° . It will be noticed that the two branches of the curve on either side of the abscissa of 4° are similar, showing, as stated above, that the expansion increases at the same rate from the point of maximum density, whether the water be heated or cooled.

This provision in the constitution of water, that its point of maximum density is four degrees above the freezing-point, is one of great importance in the economy of nature; for were it not for this apparent exception to an otherwise universal law, all the ponds and lakes of our northern climates would be converted every winter into a solid mass of ice. It must be remembered, that all liquids are poor conductors of heat, and that they can only be heated or cooled by a circulation of their particles, by which each in its turn is brought in contact with some hot or cold surface. Hence we cannot cool a liquid by removing the heat from below. The lowest stratum of liquids, it is true, readily yields its heat; but since its density is thus increased, it remains persistently at the bottom, and then its poor conducting power comes into play, and prevents the escape of the heat from the great mass of the liquid above. We can easily, however, cool a liquid by removing the heat from the upper surface, for then the particles of liquid sink as fast as they are cooled, until the whole mass is reduced to a uniform temperature.

Such a circulation as this takes place in every pond as the winter's cold increases, and continues until the temperature of the mass of water has been reduced to 4° ; but as the temperature approaches the point of maximum density, the circulation slackens, and is entirely arrested when that point is fully reached. The surface water cools still lower, and finally freezes; but then the ice, being a poor conductor of heat, and floating on the surface, serves as a cloak to the pond, so that during the coldest winter a thermometer will always indicate a temperature of 4° if sunk only a few feet below the ice.

If water had been constituted like other liquids, the circulation just described would have continued down to the freezing-point, and the ice, being now heavier than the water, would have first formed at the bottom of the pond, and gradually accumulated until the whole mass of water was frozen. On such a body of ice the hottest summers would have produced but little effect; and as now during the winter the water freezes only to the depth

of a few feet, so then during the summer the ice would only have melted on the surface. Thus it is that the order of creation depends on an apparent exception to a general law, so slight and so limited in its extent that it can only be detected by the most refined experiments.

A point of maximum density has not been observed with certainty in any liquid except water; but, nevertheless, it is possible that such a point may exist in a few melted metals, such as cast-iron, antimony, and bismuth, which, like water, expand on becoming solid. These substances, however, are liquid only at high temperatures, at which it is impossible to make accurate measurements. On the other hand, it has been proved in the case of many liquids, which, like olive-oil, contract on solidifying, that there is no point of maximum density.

Despretz has carefully studied* the effect of salts dissolved in water on its point of maximum density. He found, in general, that aqueous solutions have a point of maximum density, which may be, however, below the normal freezing-point of the solution when the quantity of salt dissolved is considerable. The point of maximum density sinks very nearly in proportion to the quantity of salt dissolved, and more rapidly than the freezing-point, so as finally to fall below it (271). A table will be found in the memoir just referred to, giving the point of maximum density, as well as the freezing-point, in solutions of various salts at different degrees of concentration.

(259.) *Volume of Water at different Temperatures.* — Several experimenters, but especially Despretz, Pierre, and Kopp, have determined the volume of the same quantity of water at different temperatures between -15° and 100° ; and then, by means of interpolation formulæ, calculated the volume for every degree between these limits. The volumes and corresponding specific gravities, as thus calculated by Kopp, are given in Table XVI. As already stated, it is impossible to express the volume of water at all temperatures by any single formula; but the following formulæ will give the volume very closely over an interval of twenty-five degrees. The first of these was calculated by Frankenheim from Pierre's experiments, the rest are by Kopp.

* Comptes Rendus, Tom. IV. p. 435.

Between -15° and 0° ,

$$V = 1 - 0.00009417t + 0.000001449t^2 - 0.0000005985t^3.$$

Between 0° and 25° ,

$$V = 1 - 0.000061045t + 0.0000077183t^2 - 0.00000003734t^3$$

Between 25° and 50° ,

$$V = 1 - 0.000065415t + 0.0000077587t^2 - 0.000000035408t^3.$$

Between 50° and 75° ,

$$V = 1 + 0.00005916t + 0.0000031849t^2 + 0.0000000072848t^3.$$

Between 75° and 100° ,

$$V = 1 + 0.00008645t + 0.0000031892t^2 + 0.0000000024487t^3.$$

(260.) *The Coefficient of Expansion of Water.* — We have assumed that the coefficient of expansion of a substance at any given temperature, t , is the small fraction of its volume by which one cubic centimetre of the substance will increase when heated from t° to $(t+1)^{\circ}$; and this assumption is sufficiently correct in the case of most substances, for we may regard the rate of expansion as constant through one degree. The coefficient of expansion of water, however, increases so rapidly, that we cannot without error regard it as absolutely the same even for one degree; and we must therefore define the coefficient of water at any given temperature, t° , as the small fraction of its volume by which one cubic centimetre *would* expand, when heated from t° to $(t+1)^{\circ}$, if the rate of expansion were the same during the interval that it is at t° .

We easily obtain from [166], for the value of the coefficient of expansion at any given temperature, t , the value

$$K = \frac{1}{V} \cdot \frac{V' - V}{t' - t}; \quad [182.]$$

in which V is the volume of the liquid at a given temperature, t , and V' the volume at a temperature, t' , a few degrees higher. This formula, like our first definition, assumes that the coefficient is constant between t and t' degrees. We may evidently, however, conform the formula to the definition just given, by making the interval of temperature $t' - t$ infinitely small. It may then be expressed by $d t$, and the corresponding difference of volume,

or $V' - V$, will be dV . Making these substitutions, [182] becomes

$$K = \frac{1}{V} \cdot \frac{dV}{dt}. \quad [183.]$$

Since now we can easily obtain the value of $\frac{dV}{dt}$ by differentiating one or the other of the values of V on page 527, we can easily calculate the coefficient of expansion of water at any given temperature, by simply dividing this differential coefficient by the value of V for the given temperature, calculated by means of the formulæ just referred to. Such calculations would show that the coefficient of expansion of water varies from zero at the point of maximum density to 0.00076487 at 100°, the rate of expansion increasing far more rapidly than that of any other liquid known.

Expansion of Gases.

(261.) The differences between the amounts of expansion of different gases for the same increase of temperature are far less than with either liquids or solids; indeed, they are so small, that, previous to the refined investigations of Regnault on this subject, the coefficient of expansion of all gases was supposed to be absolutely the same. The annexed table gives the results of Regnault's determinations of the coefficients of expansion of a few of the best-known gases; and it will be noticed that the coefficients of the first four, which have not yet been condensed to liquids, are all sensibly the same, while the coefficients of the last three, all condensible gases, are considerably greater, and the greater in proportion to the readiness with which they may be condensed.

Coefficients of Expansion of Gases.

	Under Constant Volume.	Under Constant Pressure.
Air,	0.003665	0.003670
Nitrogen,	0.003668	0.003670
Hydrogen,	0.003667	0.003661
Oxide of Carbon,	0.003667	0.003669
Carbonic Acid,	0.003688	0.003710
Cyanogen,	0.003829	0.003877
Sulphurous Acid,	0.003845	0.003903

The first four coefficients, those of the constituents of air and water, may be regarded as identical, at least for all practical purposes; and if considered equal to $0.003666+$, the expansion for one hundred degrees will be represented by the vulgar fraction $\frac{1}{30}$, which can be easily remembered. In like manner, the expansion for one degree may be represented very closely by the vulgar fraction $\frac{1}{273}$. Hence 273 c.m.^3 of any permanent gas at 0° become 274 c.m.^3 at 1° ; and if we assume that the expansion is exactly proportional to the temperature, they will become $(273 + t) \text{ c.m.}^3$ at t° . Moreover, representing by V any volume of a permanent gas at 0° , we shall have by [166], for the volume at t° , the expression,

$$V' = V (1 + 0.00366 t). \quad [184.]$$

The values of $(1 + 0.00366 t)$ for every tenth of a degree from -2° to 40° , with their corresponding logarithms, are given in Tables XI. and XII. for convenience of computation.

The coefficient of expansion of a gas may be estimated in two ways. In the first place, we may measure the increase of volume which the gas undergoes, supposing the pressure on the gas to remain constant while the volume expands; or, in the second place, keeping the volume the same, we can measure the increased tension which the gas exerts owing to the increased temperature; and we can then calculate by [98] what would have been the increased volume had the gas been allowed to expand. The difference between these two methods will be better understood by experimental illustration.

In Fig. 387, B is a glass globe holding from 1,000 to 800 c.m.^3 of perfectly dry gas, whose coefficient of expansion is to be measured. This globe is filled by exhausting the air by means of an air-pump, connected by a flexible hose with the tube p , and then allowing the gas to enter through tubes filled with pumice-stone, moistened with sulphuric acid, or with chloride of calcium,

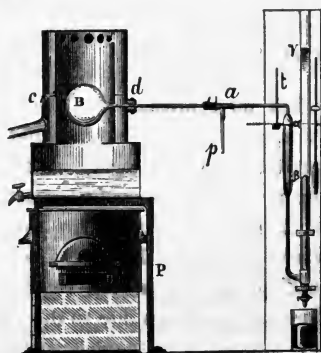

Fig. 387.

two substances which have a very strong attraction for water (see

Fig. 388). The exhaustion is repeated, and fresh gas admitted, twenty or thirty times, until the gas in the globe and the connecting tubes is known to be pure and dry. The connection between the globe and the pump is now closed by turning a *three-way stopcock* at *a*, leaving, however, the connection between the globe and the manometer-tube $\alpha\beta\gamma$ still open. The construction of this manometer has already been described (168, 2). When the apparatus has been thus filled with a gas, the coefficient of expansion may be readily determined by either of the two methods just mentioned.

First Method. We begin the determination by surrounding the globe, supported in a copper boiler, as represented in the figure, with pounded ice, so as to reduce the temperature of the enclosed gas to 0° . We then regulate the quantity of mercury in the manometer so that the columns in the two tubes shall stand at the same height, as, for example, α , which is carefully noted. This is readily effected by either drawing out mercury at the lower stopcock, or by pouring it in at the mouth of the open tube. When the adjustment is perfect, we build a fire under the copper boiler and surround the globe with steam, by which the temperature of the gas is soon raised to 100° . The increased elasticity of the gas due to the increased temperature will drive out a portion into the manometer-tube, forcing down the mercury-column. A quantity of mercury is now drawn off at the lower stopcock, until the columns in the two tubes again stand at the same level. When this is the case, the gas is exposed to the same pressure as before, and we then read off the increased volume by means of graduations on the tube provided for the purpose.

Let us represent the observed increase of volume in this experiment by v , and let us assume that the pressure of the atmosphere, as indicated by the barometer, remained constant at 76 c. m. during the experiment. If now we represent the volume of air in the globe at 0° by V , it is evident that, if heated so that it could expand freely, this volume would become at 100° , $V(1 + K 100)$; an expression in which K is the coefficient of expansion required. In the apparatus before us, however, the excess of gas due to the expansion escapes into the tube $d\alpha\beta$, where it is exposed to a much lower temperature. Call this temperature, which is always carefully observed, t° . The volume of this small amount of gas, had its temperature been maintained at 100° , would evidently have been $v(1 + K [100 - t])$, so that we have the equation

$$V(1 + K100) = V + v(1 + K[100 - t]) \quad [185.]$$

It must be remembered, however, that the glass globe expands as well as the gas, and therefore contains at 100° a larger volume of gas than at 0° . This increased volume can be readily calculated from the coefficient of expansion of glass (K'), and is $V(1 + K'100)$. Substituting this value for V in the second member of [185], we obtain

$$V(1 + K100) = V(1 + K'100) + v(1 + K[100 - t]);$$

which gives, for the coefficient of expansion of gas under constant pressure, the value

$$K = \frac{100VK' + v}{100(V - v) + tv}. \quad [186.]$$

Second Method. In order to determine the coefficient of expansion by the second method, we arrange the apparatus exactly as before, so that the mercury stands at the same level (α , Fig. 387) in both tubes of the manometer when the globe is surrounded by ice. We then, as before, raise the temperature of the globe to 100° ; but instead of allowing the gas to expand into the tube d at α , we pour mercury into the tube β at γ , in order to balance the increased tension of the gas and retain the volume constant. Lastly, we carefully measure, by means of a cathetometer, the difference of height (α, γ) of the mercury columns in the two tubes of the manometer; and, having observed the temperature of the apparatus, reduce the observed height to what it would have been at 0° . Represent this height by h_0 . Knowing now the volume of the globe at 0° (V), the height of the barometer at the time of the experiment (H_0), and the coefficient of expansion of glass (K'), we have all the data required for calculating the coefficient of expansion of air.

When the globe was at 0° , the gas was exposed to the pressure of the atmosphere, or H_0 ; but after the globe had been heated to 100° , the pressure required to retain the volume of the gas the same as before was $H_0 + h_0$. We can now easily calculate from Mariotte's law [98] what would be the volume of this gas if exposed only to the pressure of the atmosphere; in other words, if allowed to expand freely. It will be found to be

$$V' = V \frac{H_0 + h_0}{H_0}. \quad [187.]$$

But by [166] the increased volume of the gas at 100° , or V' , is also equal

to $V(1 + K'100)$, so that $V(1 + K'100) = V \frac{H_0 + h_0}{H_0}$. We must remember, however, that although the volume of the gas has been apparently kept constant during the experiment, it has not been so in reality, owing to the expansion of the glass globe. In consequence of this expansion, the volume of the globe at 100° is $V(1 + K'100)$; and this value should evidently be substituted for V in the second member of the last equation. Making this substitution, we obtain

$$1 + K'100 = (1 + K'100) \frac{H_0 + h_0}{H_0};$$

whence

$$K = K' + \frac{h_0}{H_0} \cdot \frac{1 + K'100}{100}. \quad [188.]$$

In this example, as in the last, we have assumed that the pressure of the atmosphere was constant during the experiment. When this is not the case, certain obvious changes must be made in the formulæ. Moreover, in the practical application of these methods, certain precautions must be taken, which will be found described at length in Regnault's original memoir* on the subject, as well as the peculiar modifications of the apparatus best adapted for each method.

(262.) *General Results* — Regnault found that the two methods just described for determining the coefficient of expansion of gases yielded slightly different results. This will be seen by recurring to the table on page 528. The first column gives the coefficient as determined from the increased elasticity, the volume remaining constant. The second column gives the coefficient as determined from the increased volume, the pressure remaining constant. It will be noticed that the difference between the two results, although very small with the permanent gases, is quite large with those that can be easily reduced to the liquid state, and it will be remembered that it is these very gases which yield most readily to compression, and hence deviate most markedly from the law of Mariotte. Moreover, the fact that, with the exception of hydrogen, the coefficients under constant volume are less than those under constant pressure, is easily explained. In the method employed, the gases are exposed to a greater pressure at 100° than at 0° . By this pressure they are condensed more than we assumed by applying the law of Mariotte

* Mémoires de l'Académie de Sciences de l'Institut, Tom. XXI.

in our calculation as if it were exact, and consequently the effect of the increased temperature is really greater than appears. In other words, the mercury-column h_0 measures, not simply the increased tension of the gas caused by the increased temperature, but the difference between the increased tension and the increased compressibility. In the case of hydrogen, which, unlike all other gases, is compressed less than the law of Mariotte requires, the variation is in the opposite direction. (Compare page 296.)

Regnault also discovered, what indeed might be inferred from the facts already stated, that the coefficients of expansion of all gases except hydrogen increase with the pressure to which they are exposed. The greater the pressure on a mass of gas, and hence the greater its density, the greater is the amount of its expansion for the same difference of temperature; and, on the other hand, the less the pressure and density, the smaller the amount of expansion. The coefficient of expansion in any case increases with the pressure in proportion as the compressibility of the gas deviates from the law of Mariotte, and hence the differences between the coefficients of different gases are the more decided the greater the pressure to which the gases are exposed. On the other hand, as the pressure diminishes, the coefficients of expansion of different gases approach equality; and it is probable, therefore, that all gases in the state of extreme expansion would have the same coefficient. (Compare page 297.)

It appears, therefore, that all gases have the same coefficient of expansion, in so far as they obey the law of Mariotte. In the case of those gases which have not been liquefied, and which conform very closely to Mariotte's law, the coefficients of expansion under the pressure of the atmosphere are sensibly equal, and even in the case of the condensible gases the differences are very small, amounting in no case to more than three units in the fourth decimal figure. We may therefore say that the coefficient of expansion of all gases under the pressure of the atmosphere is equal to 0.0036, within three ten-thousandths.

(263.) *Air-Thermometer.* — We have seen that the defects of the mercury-thermometer arise from two causes; first, the slowly increasing rate of expansion of mercury as the temperature rises, and, secondly, the irregular and uncertain expansion of the glass bulb. Both of these defects may be avoided by using

air as the thermometric material: the first, because the expansion of air is exactly proportional to the temperature; and the second, because the expansion of air is so much greater than that of glass that the irregularities in the expansion of the latter may be overlooked. It is, however, by no means so easy to measure the volume of a gas as that of a liquid. The volume of a liquid is not affected by the changing pressure of the atmosphere, while that of a gas is; so that while a small increase in the volume of a quantity of mercury enclosed in a common thermometer can be measured by the mere inspection of the divisions on the stem, the amount of expansion of a quantity of air confined in a glass bulb, although much larger, can only be determined with certainty by a tedious process, occupying several hours. Thus, although with an air-thermometer we can measure temperatures with accuracy to the hundredth of a Centigrade degree, yet it requires a day to make a single observation. The air-thermometer is, therefore, of no use, except in the few cases which require the very highest degree of scientific precision. In such cases it is an invaluable instrument; but even then, as in all other scientific measurements, the greatest attainable accuracy can only be gained at the cost of time, labor, and skill.

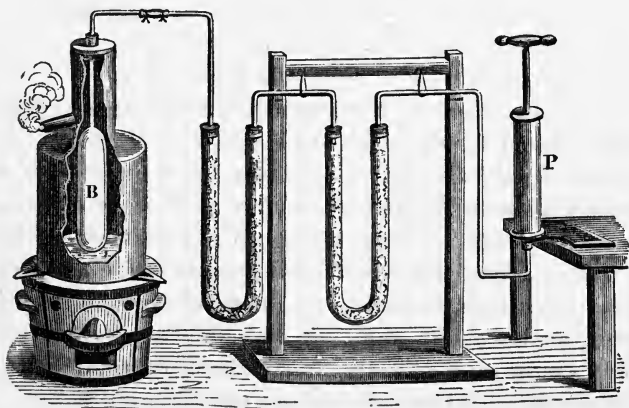

Fig. 388.

(264.) *Regnault's Air-Thermometer.* — The air-thermometer, which is used only in delicate measurements of temperature, is represented in Figs. 388 and 389. It consists of a cylindrical reservoir of glass, *B*, opening into a capillary tube bent at right

angles and drawn out to a fine point. In order to estimate temperatures with this instrument, it is first filled by means of an air-pump and drying-tubes, as shown in Fig. 388, with perfectly dry air, and then exposed to the temperature to be measured, which we will call T° . When an equilibrium of temperature has been established between the thermometer and the heated substance, the fine opening is closed with a blowpipe, and at the same time the height of the barometer is noted, which we will call H_0 . The air in the thermometer is now expanded to the extent corresponding to T° , and the next step is to ascertain the amount of this expansion, since we can easily calculate from this the temperature T° . For this purpose, we place the thermometer upon the metallic support represented in Fig. 389. The reservoir of the thermometer rests upon three brass knobs, and is kept in its place by means of a binding screw. The tube of the thermometer passes through a hole in the centre of the brass stage A , and the end dips under mercury contained in the glass dish C .

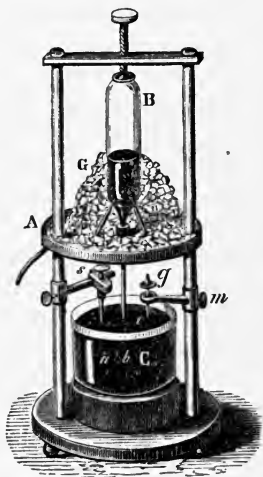

Fig. 389.

The bent end of the tube is adjusted opposite to an iron spoon, a , filled with wax, which can be pushed forward on its support, s , so as to close the end of the tube while under mercury, when necessary. These adjustments having been completed, the tip end of the tube is broken off with a pair of pliers, when the mercury immediately rushes up into the thermometer and partially fills it. The thermometer is next surrounded with pulverized ice, which is piled up on the stage, G ; and when the air in the reservoir has fallen to 0° , the end of the tube a is carefully plugged up by means of the wax in the iron spoon, and at the same time the height of the barometer (H') is carefully noted. The ice is now removed, and when the temperature of the mercury in the thermometer has been restored to that of the air, the height of the mercury in the thermometer above that in the reservoir is carefully measured. We will call it h ; and hence the air in the thermometer, at the moment the tube was plugged

with wax, must have been exposed to the pressure of $H' - h$. This measurement is easily made by means of a cathetometer and the screw g , in the manner previously explained in connection with Regnault's barometer (159).

It is next necessary, in order to determine the temperature to which the thermometer has been exposed, to ascertain, first, the volume of air remaining in the thermometer after contraction, and, secondly, the volume originally contained in it. For this purpose, the thermometer is removed from its support and weighed; call this weight W . The thermometer is then filled completely with mercury at 0° and weighed; call this second weight W' . Lastly, it is completely emptied, and the glass weighed by itself; call this last weight w . We have now all the data for calculating the amount of expansion of the air, and consequently the temperature required. Before commencing the calculation, we must reduce the observed heights of the barometer (H and H') and mercury-column (h) to 0° by the method given in (251). We will call these corrected heights H_0 , H'_0 , h_0 . We can then readily calculate the following quantities.

$W' - w$ = weight of mercury which fills the thermometer at 0° .

$\frac{W' - w}{\delta}$ = capacity of thermometer at 0° when δ = *Sp. Gr.* of mercury.

$\frac{W' - w}{\delta} (1 + K' T)$ = capacity of thermometer at T° , when K' = coefficient of expansion of glass.

$W - w$ = weight of mercury which entered the thermometer on breaking the tip, the temperature of the thermometer being 0° .

$\frac{W - w}{\delta}$ = volume of mercury which entered the thermometer on breaking the tip, the temperature of the thermometer being 0° .

$\frac{W' - W}{\delta}$ = volume of air in the thermometer at the moment of plugging with wax, exposed to a pressure $H'_0 - h_0$ and to a temperature of 0° .

$\frac{W' - W}{\delta} \cdot \frac{H'_0 - h_0}{76}$ = volume which same air would have under 76 c.m. and 0° .

$\frac{W' - W}{\delta} \cdot \frac{H'_0 - h_0}{H_0} (1 + K T)$ = volume which same air would have under H_0 c.m. and T° .

By the conditions of the problem, this volume of air just filled the thermometer at T° and under barometric pressure H_0 ; hence

$\frac{W' - W}{\delta} \cdot \frac{H'_0 - h_0}{H_0} (1 + K T) = \frac{W' - w}{\delta} (1 + K' T)$ = the capacity of thermometer at T° ;

$$\text{or} \quad \frac{1 + K' T}{1 + K T} = \frac{W' - W}{W' - w} \cdot \frac{H'_0 - h_0}{H_0} \quad [189.]$$

$$\text{Put} \quad m = \frac{W' - W}{W' - w} \cdot \frac{H'_0 - h_0}{H_0}, \text{ and } K = 0.00367; \quad [190.]$$

and we have

$$T = \frac{1 - m}{m \cdot 0.00367 - K} \quad [191.]$$

By means of [189] and [190] we can easily calculate the temperature from the experimental data. The coefficient of expansion of glass is the only uncertain element which enters into the calculation. When the thermometers are made of the common crown-glass of Paris, the coefficients of expansion may be taken from the table on page 497, estimating roughly the required temperature, as can easily be done by means of a common mercury-thermometer. When, however, such thermometers cannot be obtained, it is best to have a number made from the same pot of glass, and ascertain carefully the coefficient of expansion of this glass between 0° and every fifty degrees up to 350° . These coefficients can afterwards be used in all experiments with the same set of thermometers.

(265.) By substituting T for 100, we can easily obtain from [186] and [188], by transposition, the value of T in terms of the coefficient of expansion of air; and since this coefficient is accurately known, either of the methods of (261) may be used for determining temperature. The form which has been given by Regnault to the manometric apparatus, when used for this purpose, has already been represented in Fig. 273. The glass tube abc , which serves as an air-thermometer, is closed by a stopcock r , and can be connected to the manometer by a brass collar of peculiar construction, as before described (see Figs. 274 and 275). The air-thermometer having been exposed to the temperature to be measured, the stopcock r having been closed at the moment of observation, and the height of the barometer noted, we can easily determine the temperature in the following way.

In the first place, mercury is poured into the manometer at K until the tube hgf is completely filled, and when the mercury begins to drop from the open end at f , the air-thermometer is connected. The thermometer is now surrounded with melting ice in order to reduce its temperature to 0° , and before the stopcock r is opened, a quantity of mercury is drawn out of the manometer at R , in order to make a great difference of level between the two columns. On opening the stopcock r , a portion of the air in the thermometer passes into the tube gh ; and mercury must be again

poured into the tube $k i$, until the surface of the column in the tube $g h$ coincides exactly with a mark, α , on the side of the tube. The determination is then completed by measuring with a cathetometer the difference of level of the two mercury-columns, noting the temperature of the manometer by means of the thermometer t , and observing the height of the barometer. We have now the following data for calculation, the heights of the mercury-columns having been reduced to 0° :—

H'_0 = height of barometer at the moment of observing the temperature.
 H_0 = height of barometer at the moment of measuring the difference of level.

h_0 = difference of level as measured by the cathetometer.

V = capacity of air-thermometer at 0° .

v = capacity of manometer-tube between f and the mark α .

t = temperature of the manometer at the time of the experiment.

T = required temperature to which the thermometer was exposed.

K = coefficient of expansion of glass.

0.00367 = coefficient of expansion of air.

0.0012921 gram. = weight of one cubic centimetre of air at 0° and 76 c. m.

The volume of air in the air-thermometer and in the manometer-tube, when the value h_0 was measured, was evidently $V + v$; the portion V at the temperature of 0° , the portion v at t° , and the whole under a pressure $H_0 + h_0$ [106]. Reducing by [166] the volume v to what it would be at 0° , and reducing by [107] the sum of the volumes at 0° to what this total volume would be under the normal pressure of the atmosphere, we easily obtain for the weight of this mass of air,

$$0.0012921 \left[V + v \frac{1}{1 + 0.00367 t} \right] \frac{H_0 - h_0}{76}.$$

But we know that this same mass of air at the temperature T (that is, at the moment of closing the stopcock r), and under the pressure H'_0 (the height of the barometer at the time), occupied just the volume of the air-thermometer *at that temperature*, or $V(1 + K T)$. Reducing this volume to what it would be at 0° and 76 c. m., and multiplying this reduced volume by the weight of one cubic centimetre of air, we obtain a second expression for the weight of the given mass of air, which, in the following equation, is put equal to the first:—

$$0.0012921 V \frac{1 + K T}{1 + 0.00367 \cdot T} \frac{H'_0}{76} = 0.0012921 \left[V + v \frac{1}{1 + 0.00367 \cdot t} \right] \frac{H_0 - h_0}{76},$$

or reducing

$$\frac{1 + K T}{1 + 0.00367 \cdot T} = \left[1 + \frac{v}{V} \cdot \frac{1}{1 + 0.00367 \cdot t} \right] \frac{H_0 - h_0}{H'_0}. \quad [192.]$$

All the terms of the second member of this equation are known quantities except V and v , and these can easily be obtained in the following way.

In the first place, we fill the manometer-tube with mercury, as before, and then slowly, by the stopcock R , draw off the mercury into a tared vessel until the surface of the column coincides with the mark a . The weight of this mercury divided by its specific gravity [56] is equal to v . We then attach the air-thermometer (the stopcock r being open), and observe the height of the barometer, H_0 . Since the mercury is at the same level in both tubes of the manometer, the confined volume of air ($V + v$) is of course exposed to the pressure H_0 . We next draw off more mercury at R until the level of the column in the tube hg sinks to a second mark, ϵ . The weight of this mass of mercury divided by its specific gravity gives the volume of the tube between a and ϵ , which we will call v' . Lastly, we measure the difference of level of the mercury-columns in the two tubes of the manometer, which we will call h_0 . At this moment the volume of the confined air is $V + v + v'$, and, assuming that the height of the barometer has not changed during the short interval occupied by the experiment, this volume is exposed to the pressure $H_0 - h_0$. The values $V + v$ and $V + v + v'$ are then the volumes of the same mass of air under the pressures H_0 and $H_0 - h_0$ respectively. Hence, by [98],

$$\frac{V + v}{V + v + v'} = \frac{H_0 - h_0}{H_0}, \quad [193.]$$

and from this equation we can easily deduce the value of V , since all the other terms are known.

(266.) *Air-Pyrometer.* — By substituting for the glass thermometer (abc , Fig. 273) a thermometer made of some refractory substance, the apparatus described in the last section may be used for measuring very high temperatures. Pouillet* employed for the purpose a small globe of platinum at the end of a long and narrow tube of the same metal; but a thermometer made of porcelain, as proposed by Regnault, would be less expensive, and even better adapted to the purpose. In the use of platinum there is a liability to error arising from its power of condensing gases on its surface at the ordinary temperature.

(267.) *The True Temperature.* — It is generally admitted that the expansion of a given mass of air under constant pressure is absolutely proportional to the quantity of heat it receives. If so,

* Comptes Rendus, Tom. III. p. 782.

the temperatures given by the air-thermometer are the true temperatures ; but although this assumption is highly probable, it is impossible, in the present state of our knowledge, fully to establish its truth by experimental proof. Nevertheless, the temperatures given by the air-thermometer are the nearest approach we can at present make to the true temperature, and it is important in all scientific investigations to substitute for the indications of a mercury-thermometer the corresponding temperatures of the air-thermometer. When we know the nature of the glass of the mercury-thermometer, we can readily make the reduction by means of Regnault's table on page 435 ; but since the expansion of glass is always more or less uncertain, it is always best to use the air-thermometer in observing high temperatures if great accuracy is required.

(268.) *Effects and Applications of the Expansion of Air.* — One of the simplest effects of the expansion of air is seen in the action of a stove on the air of a room. The particles of air in contact with the heated iron are expanded, and, becoming thus specifically lighter, rise and give place to the colder particles which flow in from below. Thus a circulation is established by which all the air in the room is finally brought in contact with the source of heat and warmed. Were the air visible, the heated air would be seen to rise from the stove, spread itself over the ceiling, descend along the walls, and flow back over the floor to the stove. In like manner, every furnace-flue, gas-light, or candle, and every human body, would be seen to be the centre of an ascending column of heated air ; indeed, such is the perfect freedom of motion in air, that a single lighted candle will set in motion the whole atmosphere of a quiet apartment. Similar currents are established whenever a door is opened by which a warm room is connected with a cold entry. The heated and lighter air pours out from the room at the top of the door, while the colder air flows in over the door-sill. The flame of a lighted candle may be used (as represented in Fig. 390) to detect the direction of the currents. A current of air may always be noticed flowing towards the sunny side of a building, which supplies the current rising along the heated wall. But by far the grandest exhibition of this aeriform circulation is the trade-winds. These are caused by the unequal action of the sun on different parts of the earth's surface. At the equator, the

strongly heated air rises, and its place is supplied by colder air, which flows in on both sides from the temperate zones; thus currents are established which would blow directly north and south, were it not that the rotation of the globe causes them to deviate from this direction, while other and local causes come in to produce the irregularities which are observed.

The effect of a glass chimney on the flame of a candle is another illustration of the action of heat in expanding air. By the chimney, the heat generated by the burning combustible is confined within the glass walls, and consequently the air surrounding the flame becomes more intensely heated than it would be

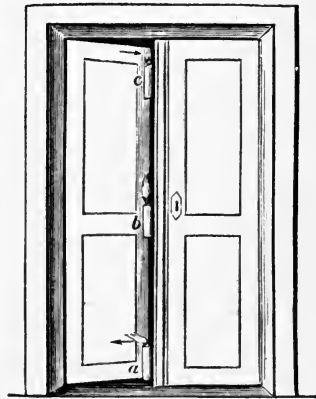

Fig 390

without the chimney. Moreover, the heated air is also confined by the walls of the chimney, and prevented from mixing with the atmosphere, thus forming a column of heated air whose height is equal to the height of the chimney. This column of air will evidently be buoyed up by a force equal to the difference between the pressure of the air at the bottom and at the top of the cylinder, and this force has been shown (136 and 155) to be equal to the weight of a column of the exterior cold air of the same area and height. Hence the heated air will rise, for the same reason that a balloon rises, and with a velocity proportionate to the excess of the buoyancy over its own weight. The quantity of air passing through such a chimney in a given time can readily be calculated, when the area of the section of the chimney, and the difference of temperature between the inner and exterior air, are known.

The draught of an ordinary brick flue is caused in the same way as that in the glass chimney of a lamp. The weight of the column of heated gas CD (Fig. 391) is less than that of the column of exterior air AB , and hence there results an excess of upward pressure which forces the products of combustion up the chimney the more rapidly the greater the difference of weight

between the two masses of gas. A good draught depends on the following obvious conditions:—1. The size of the flue should be

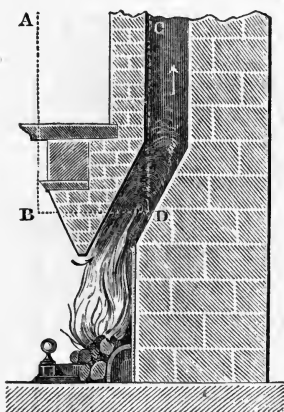

Fig. 391.

proportional to the amount of gas it is required to carry; for if too large, cold currents may descend in the angles of the flue, while a heated one ascends in the axis. 2. The height of the chimney should be as great as possible; for the greater the height, the greater will be the excess of the upward pressure on which the draught depends. 3. The room with which the flue connects should not be so tight that air cannot enter as fast as it escapes by the chimney. 4. Any direct communication between separate flues in adjoining rooms should

be avoided, because, if one flue draws better than the other, a downward current may be established in the last.

Still another application of the ascensional force of heated air is to be seen in the hot-air furnaces which are so universally used in this country for heating buildings. They usually consist of a brick chamber placed in the cellar, connected by the *cold-air box* with the exterior air, and communicating by tin tubes with the different apartments above. The interior of this brick chamber is nearly filled with a large cast-iron stove, constructed of various patterns, so as to expose a large heating surface to the air surrounding it. This heated air ascends, in virtue of its buoyancy, through the tin conducting-tubes, and cold air is pressed in from the outside of the building to supply its place. A furnace of this kind (Chilson's) is represented in Fig. 392, and the arrows indicate the direction of the currents of air.

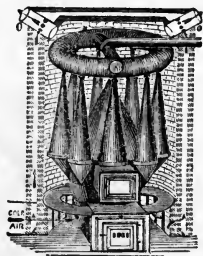

Fig. 392.

The ascensional force of heated air is not only applied in warming buildings, but it is also used for producing ventilation. One of the best arrangements for the purpose, which may be used with great efficiency in connection with a hot-air

furnace, is represented in Fig. 393. The smoke-flue of the furnace, formed by a cast-iron pipe *A*, rises in the centre of a large brick shaft *B*, with which the different rooms of the building connect. The radiant heat of this iron flue heats the air in the shaft, and thus causes a powerful ascending current, which draws in the foul air from the room at the openings *D* and *D*; while at the same time fresh air enters the room from the furnace to take the place of that which is thus removed.

It is evident, from what has already been stated, that a lump of ice sustained near the top of a room would cause a descending current of air, and thus give rise to a circulation in the atmosphere of the apartment similar to that produced by a stove. This principle has been applied in the construction of refrigerators for preserving food in warm weather. One of these (Winship's) is represented in Figs. 394 and 395. The ice is sustained upon a shelf (*DD*) in the upper part of a chest, the hollow walls of which are filled with pulverized charcoal, a very poor conductor of heat. The air enters at a register (*C*), and, coming in contact with the ice, is cooled and falls to the bottom of the chest, where it finds

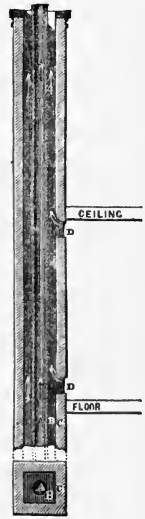

Fig. 393.

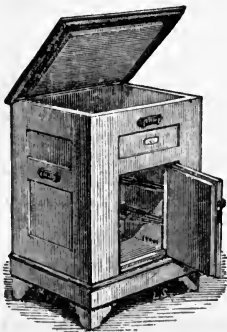

Fig. 394.

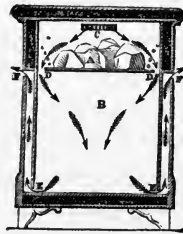

Fig. 395.

egress at *E* between the hollow walls, and finally escapes at *F*. In this way a gentle current of cold air is steadily maintained as long as the ice lasts.

PROBLEMS.

Expansion of Solids.

311. A bar of iron one metre long at 0° is heated to 15° ; what is the increased length of the bar?

312. A bar of railway iron is 3.425 metres long at 20° ; what would be its length at -10° ?

313. In laying the iron rails of a railroad, it is necessary to make an allowance for the expansion of the metal by heat. How much allowance is necessary on a distance of 100 kilometres? How much on a distance of 20 English miles, assuming that the road is laid at a temperature of 5° , and that it is liable to be exposed to a temperature of 20° ?

314. The length of one of the tubes of the Britannia Bridge over the Menai Strait is 1,510 feet $1\frac{1}{2}$ inches at 0° ; what would be its length at 20° ? Determine also the difference of length between -10° and 15° .

315. A bar of metal is 3.930 m. long at 0° and 3.951 m. long at the temperature of 83° . Calculate the coefficient of expansion.

316. A bar 7 m. long made of a metal whose coefficient of expansion is $\frac{1}{735}$ increases in length from the same increase of temperature as much as a bar made of another metal 9 m. long. Required the coefficient of expansion of the second metal.

317. A platinum bar 2 m. in length is divided at one of its extremities into fourths of a millimetre; a copper bar 1.950 m. long placed over the first at 0° differs from it in length 0.050 m., or 200 of the divisions on the platinum bar. Required the temperature of the two bars at which the difference would be equal to 164 divisions on the platinum bar.

318. A pendulum made of brass vibrates seconds at 0° C. How many seconds would it lose each day if the temperature were 20° .

319. It is required to make a compensating pendulum of steel and brass rods, whose constant length shall be 0.50 m. What disposition must be given to these rods, and what must be their lengths, in order to effect the compensation?

320. A brass tube is 5.436 m. long at 20° . How long will it be at 0° ?

321. A plate of sheet-iron has at 0° a superficial area of 560 c. m.^2 . Required its area at 15° .

322. The iron tire of a wheel is 1.123 m. in diameter at a red heat ($1,200^\circ$). What will be its diameter when cooled to 10° ?

323. An iron ball has a diameter of 15 c. m. at 0° . What will be its cubic contents at 100° ?

324. A glass cylinder has a capacity of 100 c. m.^3 at 15° . What will be its capacity at 150° ?

325. With what force does a bar of copper expand, the area of whose section equals 1 c. m.^2 , if heated from 0° to 15° ?

326. The specific gravity of a solid at 5° was found to be 7.788; at 20° it was found to be 7.784. Required the coefficient of expansion of the solid.

Expansion of Liquids.

327. The height of the mercury-column in the tube *A*, Fig. 379, was found to be 54 c. m. The difference of level of the two columns *A* and *B* was found by measurement to be 0.972 c. m. Required the coefficient of absolute expansion of mercury, knowing that the temperature *A* was 0° , and that of *B* 100° .

328. Reduce the following heights of the barometer observed at the annexed temperatures to 0° :—

1.	77 c. m.	$t = 20^{\circ}$ C.	5.	75.85 c. m.	$t = -13^{\circ}.55$ C.
2.	74 "	$t = 10^{\circ}$.	6.	46.23 "	$t = 15^{\circ}.2$.
3.	75 "	$t = 25^{\circ}$.	7.	78.65 "	$t = 14^{\circ}.6$.
4.	73 "	$t = -10^{\circ}$.	8.	75.21 "	$t = -12^{\circ}.3$.

Calculate the reduced height, first, on the assumption that the scale is inexpandible; secondly, on the assumption that the height is measured with a brass cathetometer graduated at 0° ; thirdly, that it is measured on a glass scale also graduated at 0° .

329. Reduce the following barometric observations made at 8° to the temperatures indicated, making the same assumptions as in the last problem:—

1.	76.9 c. m.	$t = 30^{\circ}$.	4.	76 c. m.	$t = -10^{\circ}$.
2.	76.8 "	$t = 29^{\circ}$.	5.	75.9 "	$t = -9^{\circ}$.
3.	76.7 "	$t = 28^{\circ}$.	6.	75.8 "	$t = -8^{\circ}$.

330. A glass cylinder 4 c. m. in diameter is filled at 0° to the height of 0.5 m. with mercury. How high is the centre of gravity at 0° , and how high at 30° over the base of the cylinder?

331. Required the volumes of the following liquids at the temperatures indicated, knowing that the volume at 0° is in each case $100 \overline{\text{c. m.}}^3$:—

Alcohol,	$t = 20^{\circ}$.	Oil of Turpentine,	$t = 100^{\circ}$.
Ether,	$t = 15^{\circ}$.	Water,	$t = 50^{\circ}$.

332. Prepare a table giving the volume of water for each ten degrees from 0° to 100° , the volume at 0° being taken as unity.

333. Construct the curves of expansion of alcohol, ether, and oil of turpentine from the equations on page 518.

334. Construct a curve of expansion for water corresponding to each equation on page 527.

335. A glass flask whose neck has been drawn out to a point contains at 0° $1,000 \overline{\text{c. m.}}^3$ of mercury. Required the weight of mercury which will flow from the flask if its temperature is raised to 100° .

336. A weight thermometer, Fig. 380, contained 254.263 grammes of mercury at 0° ; when heated to 100° , 3.864 grammes of the mercury escaped. What is the apparent coefficient of expansion of mercury? Assuming that the coefficient of expansion of glass is 0.00003, what is the coefficient of absolute expansion?

337. A glass thermometer-tube was carefully calibrated and divided into parts of equal capacity. The weight of mercury which the bulb and tube contained below the 6th division on the stem, measured at 0° , was found to be 20.125 grammes. After introducing an additional quantity of mercury, which filled 25 divisions of the stem at 0° , this weight was increased to 20.156 grammes. Subsequently, in order to measure the apparent expansion of mercury, the two fixed points were carefully determined on the stem. The difference between the two was found to be 250 divisions. Required the coefficients both of absolute and of apparent expansion, using for the coefficient of glass the value given in the last problem.

338. A spherical vessel having an internal diameter equal to two thirds of a metre at 0° , is made of a material whose coefficient of expansion is equal to $\frac{1}{25000}$. Required the weight of mercury which the vessel will hold at 0° and at 25° .

339. A cylinder of brass immersed in water is suspended from the pan of a hydrostatic balance, and counterpoised at 4° . The temperature is then raised to 9° , and it is required to determine the weight necessary to restore the equilibrium. The circumference of the cylinder is 0.135 m.; its height, 0.12 m.

340. A spherical glass vessel, whose diameter is equal to 0.28 m., is filled with mercury at 70° . This mercury is turned into a quantity of water which half fills a cylindrical vessel 0.40 m. high and 0.40 m. in diameter. Required the temperature of the mixture, neglecting the temperature of the glass.

341. Determine the coefficient of expansion of platinum from the following data:—

	Grammes.
Weight of the platinum bar,	198.0
“ “ glass bulb and platinum bar enclosed,	240.5
“ “ “ “ “ when filled with mercury at 0° ,	390.1
“ “ mercury expelled on heating the tube to 100° ,	7.97

This problem can be most readily solved by first calculating the values of $\frac{W}{\delta}$, $\frac{W'}{\delta'}$, and $\frac{W' - w}{\delta'}$, and afterwards substituting these values in [180].

Expansion of Gases.

342. To what temperature must an open vessel be heated before one half of the air which it contains at 0° is driven out? The pressure is assumed to be constant.

343. An open vessel is heated to $1,000^{\circ}$. What portion of the air which the vessel contained at 0° remains in it at this temperature? The pressure is assumed to be constant.

344. A closed glass vessel, which at 0° was filled with air having a tension of 76 c. m., is heated to 500° . Determine the tension of the heated air.

345. Required the temperature at which one litre of air would weigh one gramme, the pressure being 76 c. m.

346. An iron bomb-shell was filled with nitrogen gas at 0° , and after having been hermetically sealed was heated white-hot ($1,300^{\circ}$ C.). Required the tension of the heated gas.

347. Reduce the following volumes of gas, measured at the temperatures and pressures annexed, to 0° and 76 c. m. :—

1. 10 $\overline{\text{c. m.}^3}$ $H = 74$ c. m. $t = 10^{\circ}$. 2. 7.5 " $H = 73$ " $t = 12^{\circ}$. 3. 10 " $H = 80$ " $t = 10^{\circ}$.		4. 12 $\overline{\text{c. m.}^3}$ $H = 38$ c. m. $t = 30^{\circ}$. 5. 11 " $H = 50$ " $t = 20^{\circ}$. 6. 9 " $H = 60$ " $t = -10^{\circ}$.
--	--	---

348. It is required to determine the temperature to which an air-thermometer was exposed from the following data :—

Weight of the glass thermometer,	$w = 25.364$ grammes.
" " thermometer filled with mercury at 0° ,	$W' = 705.164$ "
" " " partially filled with mercury at 0° ,	$W = 251.964$ "
Height of the barometer reduced to 0° ,	$H'_0 = 75.64$ c. m.
" " mercury-column in thermometer,	$h_0 = 13.54$ "
" " barometer at the time of closing thermometer,	$H_0 = 76.22$ "

Ans. $232^{\circ}.7$.

349. It is required to determine the temperature to which the air-thermometer of Fig. 273 was exposed from the following data :—

Height of barometer at the moment of observing the temperature,	$H'_0 = 76.22$ c. m.
" " " " measuring difference of level,	$H_0 = 76.54$ "
Difference of level as measured by a cathetometer,	$h_0 = 40.34$ "
Volume of the air-thermometer at 0° ,	$V = 254$ $\overline{\text{c. m.}^3}$
" " manometer-tube between f and α ,	$v = 20$ "
Temperature of the manometer,	$t = 10^{\circ}$.

Ans. 265° .

350. It is required to determine the volume of the air-thermometer from the following data :—

Weight of mercury above mark α ,	81.600 grammes.
" " between α and ϕ ,	272.000 "
Height of barometer,	76 c. m.
Difference of level of the two columns,	39.4 "

351. A glass tube, the area of whose section is $\frac{1}{100}$ of a square centimetre, is connected, as in Fig. 355, with a glass bulb whose capacity equals $0.75 \overline{\text{c. m.}^3}$. At the temperature of -40° and under a pressure of 76 c. m. the small thread of liquid, A , stands at the lowest part of the tube. It is required to determine how long the tube must be, in order that we may measure with the instrument a temperature of 120° .

CHANGE OF STATE OF BODIES.

1. *Solids to Liquids.*

(269.) *Melting-Point.* — If we heat a solid, the first effect of heat is, as we have seen, to expand it; the second effect is to change its mechanical condition, — to melt it. The temperature at which solids melt differs very greatly for different substances; but it is always constant for the same substance. Moreover, the temperature remains absolutely constant during the whole period of melting. This temperature is termed the *melting-point*.

Melting-Points.

Mercury	—39°	Sulphur	109°
Oil of Turpentine	—10	Alloy (1 Tin, 1 Bismuth)	141
Ice	0	“ (3 Tin, 2 Lead)	167
Lard	+33	“ (8 Tin, 1 Bismuth)	200
Phosphorus	43	Tin	230
Spermaceti	49	Bismuth	256
Potassium	58	Lead	322
Wax (not bleached)	61	Zinc	360
Stearic Acid	70	Antimony	432
Sodium	90	Silver, pure,	999
Fusible metal (5 Pb, 3 Sn, 8 Bi)	100	“ alloyed with $\frac{1}{10}$ gold,	1048
Iodine	107		

(270.) *Vitreous Fusion.* — Most solids, when heated to their melting-point, change at once into perfect liquids; but some, such as platinum, iron, glass, phosphoric acid, the resins, wax, and many others, pass through an intermediate pasty condition before they attain complete fluidity. In such cases the melting-point is not fixed, although, so far as we can judge, a definite temperature corresponds to each stage of the change. The term *vitreous fusion* has been applied to this gradual change of state, because it is a characteristic property of all vitreous substances; and it is when in this intermediate pasty state that glass is worked and iron or platinum forged.

(271.) *Freezing-Point.* — If a substance in the liquid form is cooled below the temperature at which it melts, it again becomes solid, and as a general rule the freezing-point is the same as the melting-point. But in many cases we can cool a liquid several

degrees below its melting-point without its solidifying; thus, by keeping water perfectly still, we can succeed in cooling it to -15° , or even to -17° , before it freezes. If, however, when in this condition, we drop into the water an angular body, like a piece of sand, or gently jolt the vessel containing it, congelation begins at once, and the temperature suddenly rises to 0° . It has already been stated (258) that water continues to expand when cooled below 0° , while ice under the same circumstances contracts. Despretz has followed its expansion to -20° .

This singular phenomenon seems to be caused by the inertia of the particles of the liquid, and is exhibited to a still greater degree in viscid liquids, like the fats, where, on account of the imperfect fluidity, the inertia is greater. Such liquids uniformly do not *begin* to freeze until they are cooled several degrees below the melting-point; but as soon as the change commences, the temperature at once rises to this point.

It has been noticed that the phenomenon just described is most readily produced when the liquid is enclosed in a capillary tube, and this circumstance has been thought to explain the fact that plants and many of the lower animals frequently seem to resist the action of frost without any apparently adequate protection; for, as is well known, their liquid juices circulate through exceedingly minute capillary vessels.

(272.) *Effect of Salts on the Freezing-Point of Water.* — The freezing-point of water is depressed by the presence of salts in solution. Thus sea-water freezes at about -3° , and a saturated solution of common salt must be cooled as low as -20° before freezing. The freezing-points of various saline solutions at different degrees of concentration have been given by Despretz in a memoir already referred to (258). In all these cases pure ice is formed by the freezing, and a more saturated solution of the salt is left. The change may in fact be regarded as a process of crystallization, in which the water crystallizes out, leaving the salt behind. In like manner, alcohol, which when mixed with water very greatly reduces the freezing-point, is entirely eliminated from it in the process of freezing. Hence weak alcoholic liquids like wine or beer may be concentrated by exposing them to cold and removing the layers of ice as they form.

To the same class of phenomena belongs the fact, that the melting-point of several alloys is lower than that of either of the

metals of which they consist. The most remarkable example of this kind is Rose's fusible metal, consisting of two parts bismuth, one part tin, and one part lead, which melts between 95° and 98° , although the melting-points of its constituents are all between 235° and 334° . The following table, which gives the melting-points of several alloys of tin and lead, furnishes another example of the same fact. The lowest melting-point corresponds to an alloy of three equivalents of tin and one equivalent of lead. Compounds of two equivalents of sulphur and three equivalents of phosphorus, of two equivalents of bismuth and three equivalents of tin, show similar relations.

Percentage Composition.		Melting-Point.
Tin.	Lead.	
100	0	235°
73.7	26.3	194
69.3	30.7	189
63.0	37.0	186
53.2	46.8	196
36.2	63.8	241
15.9	84.1	289
0	100	334

(273.) *Effect of Pressure on the Melting-Point.* — Since the effect of an external pressure must be to resist the expansive force of heat, we might naturally expect that it would tend to raise the melting-point. That this is indeed the fact is shown by the following table, which gives the results of experiments made by Mr. Hopkins* on this subject.

Pressure in Atmospheres.	Melting-Point.			
	Spermaceti.	Wax.	Sulphur.	Stearine.
1	51.1	64.7	107.2	67.2
520	60.0	74.7	135.2	68.3
793	80.2	80.2	140.5	73.8

On the other hand, it has been shown by Professor Thompson that the effect of pressure on water is exactly opposite to that just described. He found that a pressure of 8.1 and 16.8 atmospheres caused a depression of the freezing-point of $0^{\circ}.059$ and $0^{\circ}.129$. But it will be shown in the next section, that, while the

* Silliman's American Journal, Second Series, Vol. XIX. p. 140.

volume of the substances on which Mr. Hopkins experimented increases by melting, that of water diminishes. We should, therefore, expect an opposite result in the two cases; in fact, not only the general effect of the pressure, but also the amount to which the melting-point of ice is depressed by it, are in accordance with the theory. Indeed, the phenomenon was predicted by Professor Thompson* on purely theoretical grounds, and the experimental results since obtained have agreed very closely with his predictions.

(274.) *Change of Volume.* — At the moment of melting there is a sudden change of volume, which is usually an expansion; but in the case of water and a few metals the effect is a condensation. This subject has been carefully investigated by Kopp,† who used in his experiments the simple apparatus represented in Fig. 396. The small test-tube *a a*, containing the substance to be examined, was placed within a somewhat larger tube of the same shape; and this, having been filled with water or some other suitable liquid, was closed by a cork provided with a capillary glass tube divided into parts of equal capacity. It is evident that any change of volume of the solid in the tube *a a* could be measured by the rise or fall of the enclosed liquid in the capillary tube. In practice, the apparatus was heated at the side of a thermometer in an oil-bath, so arranged that the temperature could be kept constant for a few minutes at any point, and at each stationary point the temperature and the height of the liquid in the capillary tube were observed. The weight of the substance and of the liquid used (commonly water) having been previously determined, and the rate of expansion of glass and of the liquid being known, and also the volume of the tube between any two divisions, it was easy to calculate the volume of the substance at each observed temperature, and of course to measure the change of volume which took place at melting. Some of the results obtained by Kopp are represented in Figs. 397, 398, 399, and 400. Here, as in Figs. 381 and 386, the abscissas of



Fig. 396.

* Philosophical Magazine, 1850, Vol. XXXVII. p. 123.

† Annalen der Chemie und Pharmacie, Band XCIII. s. 5.

the curves indicate degrees of temperature, and the ordinates the corresponding volumes of the substance, the volume at 0° being taken as unity. Solid phosphorus (Fig. 397), it will be noticed,

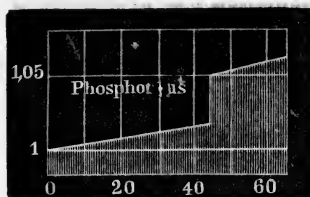

Fig. 397.

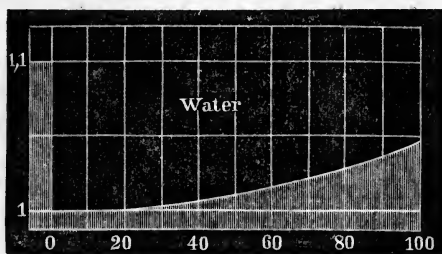

Fig. 398.

expands very regularly, like other solids, until it reaches 44° , its melting-point, when a sudden expansion, amounting to about 0.035 of the original volume, takes place. After melting, the expansion continues, with tolerable regularity, as before. Ice, on the other hand (Fig. 398), which, so long as it remains solid, is expanded by heat, suddenly contracts in melting, — the contraction amounting to about 0.1 of the volume of the water at

0° . After melting, the water expands according to the laws before stated, but the total amount of expansion between the freezing and boiling points is less than one half as great as the contraction in melting. Hence ice will float on water, even when at the boiling-point. The expansion of water in freezing takes place with irresistible force. Thick iron bomb-shells have been burst by exposing them to great

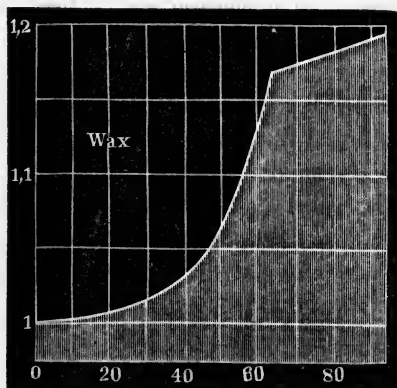

Fig. 399.

cold when filled with water and tightly plugged.

The law of the expansion of wax while melting is shown by the curve in Fig. 399. Since wax does not change suddenly into a liquid, but passes through an intermediate pasty condition, we should not expect to find a point of sudden expansion. As the

curve indicates, the expansion is very rapid during the melting, and vastly more rapid than the expansion above 64° , the point at which the wax becomes perfectly liquid.

Fig. 400 represents the curve of stearine, which is exceedingly irregular. The substance has in fact two melting-points. It melts first at 50° , and this change is attended with a sudden condensation. But as the temperature rises higher, the substance again thickens, owing undoubtedly to a change in its molecular condition; and this new condition of stearine melts at 60° , when the change is attended with a sudden expansion.

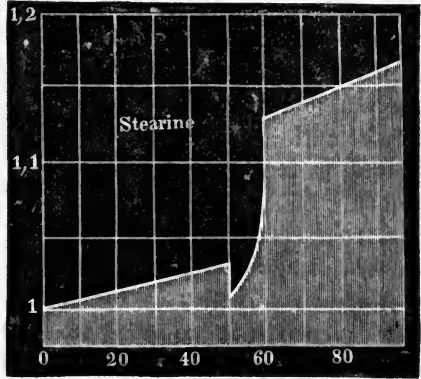

Fig. 400.

Besides water, the only substances known to expand in solidifying, which do not contain water as a chief constituent, are cast-iron, bismuth, antimony, and a few alloys, such as type-metal, brass, and bronze. These metals and alloys all give sharp casts, because the expansion, which takes place when the metal *sets*, forces it into the minute cavities of the mould; and on this fact depend many of their useful applications in founding.

(275.) The melting of solids, like their expansion, may be explained by the expansive force exerted by heat. When this expansive force becomes equal to the cohesive force, we evidently have a condition of matter in which the particles are in perfect equilibrium between two forces, and are therefore free to move at the slightest impulse; in a word, we have the condition of liquidity. We may define, then, a liquid as that condition of matter in which the cohesive force is balanced by the expansive force of heat. With a few exceptions, all solids which can bear the requisite change of temperature without undergoing chemical change, may be melted. Many substances which are generally regarded as infusible — such, for example, as platinum, flint, and siliceous minerals — readily melt before the compound

blowpipe, or between the poles of a powerful galvanic battery. Carbon is, indeed, almost the only substance which has not yielded to these high temperatures; and it is probable that even this will be melted when the means of obtaining still higher temperatures shall be discovered.* There are, however, a great number of substances, especially organic compounds, which cannot be melted, because they are decomposed by the action of heat. Thus wood, when heated, is decomposed into certain gases and acid vapors, which escape, and, into carbon, which is left behind. In like manner carbonate of lime (chalk), when heated, is decomposed into carbonic acid gas and lime at a temperature below its point of fusion. If, however, we prevent the gas from escaping, by confining the carbonate of lime in a gun-barrel hermetically closed, it can be melted in a furnace fire.

As, with very few exceptions, all solids may be melted, we have every reason to infer that all liquids might be frozen if a sufficient degree of cold could be attained. There are, however, several liquids which have never yet been frozen. Such, for example, are sulphide of carbon, alcohol, and several others of organic origin; but even alcohol becomes very thick and oily when exposed to the intense cold produced by a mixture of solid carbonic acid and ether.

(276.) *Determination of the Melting-Point.* — The melting-point is an important physical property of a substance, and the chemist has frequent occasion to determine it. The simplest method is to heat the solid in a convenient vessel until it begins to melt, and then test the temperature with a thermometer before it is fully melted. It is always well, however, also to reverse the experiment, and, by cooling down the liquid, test the temperature while it is freezing. But if there is a difference between the two temperatures, the melting-point should be taken as the physical constant rather than the freezing-point, for the reasons already stated (271).

The apparatus represented in Fig. 401 will be frequently found very convenient for determining the melting or freezing point of many organic substances, especially when only a small quantity

* Both Silliman and Despretz have obtained evidence of the partial fusion and volatilization of carbon, when exposed to the action of a galvanic battery of great intensity. For a description of the best means of producing intense furnace heat, see a memoir by Deville, *Annales de Chimie et de Physique*, 3^e Série, Tom. XLVI. p. 182.

is available for the experiment. It consists of a water or oil bath, made with two beaker glasses (one supported within the other, as represented in the figure), so that the conduction of heat from the lamp to the inner vessel may be as uniform as possible. A thermometer in the inner glass gives the temperature of the bath at each instant, and the substance under experiment, enclosed in a capillary glass tube, is immersed in the bath at the side of the thermometer. By slowly heating and then cooling the bath, it is easy to catch the exact point at which the solid melts and the liquid again freezes; and the experiment can readily be repeated a great number of times.

(277.) *Heat of Fusion.* — It has already been stated, that while a solid is melting the temperature remains the same. This fact can be easily verified

by watching a thermometer immersed in a tumbler filled with melting ice, when it will be found that the thermometer will stand at 0° until the whole of the ice has disappeared. During all this time, which may be several hours, heat has been continually entering the water from the air, and the question naturally arises, What has become of this heat? The answer is, that it has been used up in melting the ice.

In order to study this phenomenon more closely, let us take two vessels, the first containing one kilogramme of ice-cold water, and the second, one kilogramme of coarsely pulverized ice. A thermometer placed in each vessel will indicate that both the ice and the water have exactly the same temperature, viz. 0° . Let us now expose both to such a source of heat, that the same amount of heat must enter each vessel during the same time. It will be found that the thermometer in the first will remain stationary while the ice is melting; but the thermometer in the second will gradually rise. If at the moment the last particle of ice has melted we examine the two thermometers, we shall find that the one in the first vessel marks still 0° , while that in the second has risen to 79° . From the definition of the unit of heat (231), it follows that 79 units of heat must have entered both

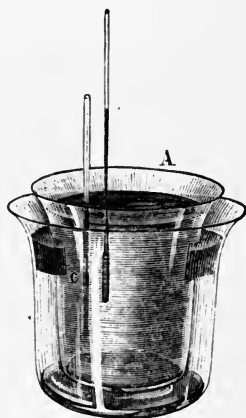

Fig. 401.

vessels. This heat has not raised the temperature of the first, because it has all been consumed in melting the ice. The difference, then, between one kilogramme of ice at 0° and one kilogramme of water at the same temperature is 79 units of heat.

The same truth may be illustrated in another way. If we take one kilogramme of water at 79° , and one kilogramme of ice at 0° , and mix the two together, we shall find, on testing the water with a thermometer after the ice has melted, that its temperature is 0° . What then has become of the 79 units of heat that the kilogramme of water contained? It is evident that they have disappeared in the melting of the ice. What is true of ice and water is also true of other substances. All solids, in melting, absorb a large amount of heat, without any corresponding change of temperature. The heat which is thus absorbed is sometimes called the *heat of fusion*, but more frequently the *latent heat* of the liquid, because it is not sensible to the thermometer. The heat of fusion of a few solids is given in the following table:—

	Melting-Point.	Heat absorbed by 1 kilogramme in melting.
Ice,	$0^{\circ}.0$	79.25 units.
Phosphorus,	$44^{\circ}.2$	5.03 “
Sulphur,	$115^{\circ}.2$	9.37 “
Lead,	$326^{\circ}.2$	5.37 “
Bismuth,	$266^{\circ}.8$	12.64 “
Tin,	$237^{\circ}.7$	14.25 “
Silver,	999°	21.07 “
Zinc,	$415^{\circ}.3$	28.13 “

The principle under discussion is well illustrated by the so-called *freezing mixtures*. The most common of these is a mixture of equal parts of snow or pounded ice and salt, which produces a degree of cold of about -16° . The salt causes the ice to melt and the water dissolves the salt, so that both become liquid, and in consequence a large amount of heat is absorbed. This mixture is used, as is well known, for freezing ice-creams. A much more powerful freezing mixture is formed by mixing together three parts of crystallized chloride of calcium, previously cooled to 0° , and two parts of snow. A degree of cold may be thus produced equal to -45° , and sufficient to freeze mercury.

The solution of most salts in water is attended with the ab-

sorption of heat, because the salt, in dissolving, changes from a solid to a liquid condition. Nitre, for example, cools the water in which it is dissolved eight or ten degrees. One part of chloride of potassium dissolved in four parts of water also cools the water about the same amount. The depression of temperature is frequently more considerable when we dissolve the salt in an acid liquid instead of pure water. A very convenient method of freezing water without the use of ice consists in mixing together finely pulverized Glauber's salt and the common muriatic acid of commerce. The salt dissolves to a greater extent in the acid than in water, and a depression of temperature results which may amount to 28° . An apparatus (Fig. 402) is constructed at Paris for freezing water by this process, and it is found to require

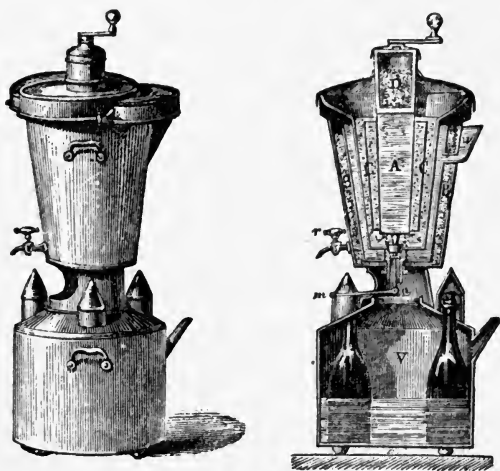

Fig. 402.

about six kilogrammes of Glauber's salt and five kilogrammes of muriatic acid to freeze five kilogrammes of water. The freezing mixture is placed in the cylindrical chamber *C*, while the hollow walls of this chamber, as well as the interior cylinder *A*, are filled with the water to be frozen. The crank at the top of the apparatus serves to turn the cylinder *A* and the vanes attached to it, by which means the acid and salt are kept constantly mixed and the surfaces of contact renewed. After the ice forms, the freezing mixture is drawn off into the lower chamber *V*, where it may be further used for cooling bottles of wine.

As the change of state from solid to liquid is attended with the absorption of a definite amount of heat, we should naturally expect that, when the fluid changes back again to a solid, the same amount of heat would be evolved. That this is really the case, may be proved by reversing the experiments just described.

If we take two vessels, the first containing one kilogramme of water at 79° , and the second, one kilogramme of water at zero, and expose them to the air during a cold winter day, so that equal amounts of heat shall escape from both during any given time, we shall find that the temperature of the water in the first vessel will immediately fall, while that of the water in the second vessel will remain stationary. In the mean time, however, the water in the second vessel will begin to freeze; but so long as the water remains liquid, the temperature will continue stationary at zero. If at the moment the last particle of water has frozen, and before the temperature begins to fall, we observe the temperature of the water in the first vessel, we shall find that the thermometer stands exactly at zero. Evidently, then, 79 units of heat have escaped from the water in the first vessel. The same amount also must have escaped from the water in the second vessel. Why, then, has it not changed the temperature? Simply because it is the heat of fusion, which has been given up by the water in changing into ice.

In like manner, as the solution of a salt in water is attended with absorption of heat, so the separation of a salt from its state of solution (the process of crystallization) is attended with evolution of heat. As a general rule, however, the crystallization is so slow, that the heat escapes as fast as it is liberated, and therefore does not raise sensibly the temperature of the mass. We can, however, so arrange the experiment as to make it very perceptible. We prepare for this purpose a supersaturated solution of Glauber's salt, as described in (198), and when the solution is cold make it crystallize suddenly by uncorking the flask. On grasping the flask with the hand as soon as the crystallization has been completed, it will be found that its temperature has risen very perceptibly, thus proving that crystallization is attended with liberation of heat.

As a last illustration of the principle under discussion, we may cite the well-known process of slaking lime in the preparation of mortar. If we add to one kilogramme of quicklime one half

a kilogramme of water, the lime rapidly combines with the water and falls into a loose white powder, a portion of the water at the same time escaping as steam. The water is thus changed, by entering into combination with the lime, from the liquid to the solid state; and, as we might anticipate, a great amount of heat is suddenly evolved. The elevation of temperature which is thus caused is sometimes sufficiently high to inflame gunpowder. The heat which is liberated in this process is not, however, wholly caused by the solidifying of the water. A portion of it results from the chemical combination between the lime and the water, in accordance with the general law that chemical combinations are attended with the evolution of heat.

The quantity of heat which becomes latent during the fusion of solids is ascertained by pouring a known weight of the melted solid, at its melting-point, into a mass of water whose weight and temperature are known. The temperature of the water will evidently be increased by the addition of the amount of heat which the liquid gives out in solidifying, plus the amount which the solid gives out in cooling from the melting-point to the increased temperature of the liquid. This last quantity may be easily calculated when the specific heat of the solid is known. From the increased temperature and weight of the water, we can also easily calculate the amount of heat which the water has gained; and then the difference between these two quantities will be the amount of heat which the liquid gave out in solidifying,—in other words, the heat of fusion. The method may be made clear by an example.

In order to determine the latent heat of melted tin, 25 grammes of the liquid metal at its melting-point (238°) were poured into 1,500 grammes of water at 15° . After an equilibrium of temperature was established, a thermometer dipping in the water indicated $15^{\circ}.45$. Hence it followed that the water had gained in temperature $15^{\circ}.45 - 15^{\circ} = 0^{\circ}.45$, and must therefore have absorbed $0.45 \times 1.5 = 0.675$ units of heat (231). On the other hand, the tin had lost in temperature $238^{\circ} - 15^{\circ}.45 = 222^{\circ}.55$; and, since the specific heat of tin is equal to 0.0562 (page 466), it must have given out, in cooling from the melting-point after solidifying, $222.55 \times 0.025 \times 0.0562 = 0.313$ units of heat. Subtracting this quantity from 0.675, we find that the amount of heat given out, in solidifying, by 25 grammes of tin, is equal to 0.362 units; and a simple calculation will show that

one kilogramme of the melted metal would give out, under the same circumstances, 14.48 units of heat, — a quantity which, by definition, is the heat of fusion of the substance. This result corresponds with the number given in the table on page 556.

A general formula for such calculations may be readily derived. Using the notation of (233), and also representing the specific heat of the substance by N , and the required heat of fusion by x , we shall have

$$W(\theta - t) = w \cdot N \cdot (T - \theta) + wx;$$

that is, the heat which the water has gained, $W(\theta - t)$, is equal to the heat which the solid has lost in cooling from its melting-point, $w \cdot N(T - \theta)$, plus the heat which the liquid lost in solidifying, $w x$. From this equation we get the value

$$x = \frac{W(\theta - t) - w \cdot N \cdot (T - \theta)}{w}. \quad [194.]$$

Here, as in determining the specific heat of a substance, it is necessary to take into account the heat absorbed by the vessel in which the experiment is conducted, and also the heat lost by radiation and from other causes. In order to insure that the temperature of the liquid is at its melting-point when poured into the water, it is best to pour it from a vessel which still contains some of the unmelted solid, since so long as any of the solid remains unmelted the temperature of the mass is constant at the melting-point. In other respects, the experiment may be conducted precisely as in determining the specific heat of a substance by the method of mixture (233), so that further details are unnecessary.

(278.) *Person's Law.* — It has already been stated (234) that the specific heat of the same substance is greater in the liquid than in the solid state, and by referring to the table on page 475 it will be seen that the difference, which is very considerable in the case of non-metallic substances, is very slight in the case of metals. Moreover, it has also been stated that a liquid may sometimes be cooled several degrees below the normal freezing-point without solidifying; and it is a possible, although not a probable supposition, that under certain circumstances a liquid might be reduced to the lowest possible temperature without

undergoing this change. Let us now assume that at N degrees below zero we should reach the lowest possible temperature, or *absolute zero*, a condition in which bodies would contain absolutely no heat, and let us suppose that we start at this temperature with one kilogramme of any given substance in the solid condition, and one kilogramme of the same substance in the liquid condition. Also let us represent by C the specific heat of the liquid, by C' the specific heat of the solid, and by T° the normal freezing or melting point of the substance. If then we assume — as we may without any great probable error — that the specific heat does not vary between the absolute zero and T° , it follows (232) that $(N + T) C$ units of heat would be required to raise the temperature of the one kilogramme of the substance in the liquid condition from the absolute zero to the melting-point, and that $(N + T) C'$ units of heat would be required to raise the temperature of the one kilogramme of the substance in the solid condition to the same extent. Furthermore, it is evident that the first of these expressions represents the actual quantity of heat which one kilogramme of the substance at the melting-point contains in the liquid state; and the second, the quantity of heat which one kilogramme of the same substance contains at the same temperature in the solid state. The difference between these quantities is, then, the number of units of heat which would be required to convert one kilogramme of the substance at the melting-point from the solid to the liquid state; or, in other words, the heat of fusion. Representing the heat of fusion by L , we have $L = (N + T) C - (N + T) C'$, which may be written

$$L = (N + T) (C - C'). \quad [195.]$$

If, then, the theory on which this formula is based is correct, it follows that the heat of fusion of a substance is equal to the difference in the specific heat in the two states of aggregation, multiplied by the number of degrees above the absolute zero at which the substance melts. By giving to N the value of 160° , Person found that the heat of fusion of many non-metallic substances calculated by the above formula agreed almost precisely with the results of direct experiment, as is shown by the following table: —

Name of Substance.	Melting-Point.	Specific Heat in		Latent Heat.	
		Solid State.	Liquid State.	Observed.	Calculated.
Water, . . .	0°	0.504	1.0000	79.25	79.20
Phosphorus, .	44.2	0.1788	0.2045	5.034	5.243
Sulphur, . . .	115	0.20259	0.234	9.868	9.350
Nitrate of Soda,	310.3	0.27821	0.413	62.975	63.4
Nitrate of Potassa,	339	0.23875	0.33186	47.371	46.462

The agreement between the observed and calculated results is certainly remarkably close, and sustains so far the theory on which the formula is based, and the necessary inference from it, that the absolute zero is at 160° below the Centigrade zero. Whether, however, we accept the theory or not, it is evident that the formula [195] is the expression of an empirical law with which the observed facts very closely agree.

(279.) This law of Person, however, only holds true in regard to non-metallic substances. In the case of the metals, where the difference in the specific heat in the two states of aggregation is exceedingly small, it entirely fails. The cause of this failure Person explains as follows.

The amount of heat absorbed by a solid in melting is not solely the quantity necessary to supply the excess of specific heat in the liquid over that in the solid state; because, in addition, a certain quantity of heat is required to overcome the cohesive force by which the particles of the solid are held together (275). In the case of non-metallic substances, where the tenacity is comparatively slight, the quantity of heat required to overcome the cohesion is so small that it may generally be neglected; and the heat absorbed in fusion very nearly corresponds to the increased specific heat in the liquid state. In the case of the metals, on the contrary, the amount of heat required by the increase in the specific heat is very small, and almost the entire heat of fusion is used in overcoming the very great tenacity of these substances. Hence, Person argues that the amounts of heat required to melt one kilogramme of each of the different metals must be proportional to the work to be done; in other words, to the power which must be used in overcoming the cohesion between the particles comprised in the unit of weight. This power would be measured by the coefficient of elasticity, were it not that in determining this

constant (101) we do not have regard to equal weights. It is evidently, however, a function of this coefficient, and Person represents it by the expression $K \left(1 + \frac{2}{\sqrt{\delta}}\right)$, in which K is the coefficient of elasticity, and δ the specific gravity of the metal. Representing also by K' the coefficient of elasticity of a second metal, and by L and L' the corresponding heat of fusion, we obtain the proportion

$$L : L' = K \left(1 + \frac{2}{\sqrt{\delta}}\right) : K' \left(1 + \frac{2}{\sqrt{\delta}}\right). \quad [196.]$$

This formula is the expression of a second law which may be thus stated: *The heat of fusion of metals is sensibly proportional to their coefficients of elasticity corrected for the difference of density.*

If we substitute, in [196], for L' , K' , and δ' , the known values for zinc, taken as a standard of comparison, we obtain for the heat of fusion of any other metal the value,

$$L = 0.001669 K \left(1 + \frac{2}{\sqrt{\delta}}\right); \quad [197.]$$

and the heat of fusion, calculated by this formula, agrees very well with the observed result. As the value of L [195] is based on the assumption, that the heat required to overcome the tenacity of the solid may be neglected, so [197] is founded on the assumption that the specific heat of a metal is the same in the liquid as in the solid state. Evidently, however, the true value of L , in any case, should include both terms, — that depending on the specific heat, as well as that depending on the tenacity. Hence we obtain Person's general formula for the heat of fusion of all solids,

$$L = (160 + T) (C - C') + 0.001669 K \left(1 + \frac{2}{\sqrt{\delta}}\right). \quad [198.]$$

In the case of the metals the first term may be neglected, and in the case of non-metallic substances the same is true of the second term. There are substances, however, for which both terms have definite values; but we have not the experimental data in regard to them which would enable us to test the formula.

We may then admit that the heat of fusion consists of two parts, one of which is used in overcoming the force of cohesion, the other furnishing the additional specific heat required in the liquid state.

We have been able to give in this section only a very imperfect abstract of Person's remarkable investigations on this subject, and we must refer the student for further information to the original memoirs.*

(280.) *Absolute Zero.* — If Person's theory is correct, the absolute zero, as we have seen, is situated 160 degrees below the Centigrade zero. This theory is not a little confirmed by the remarkable results obtained by Pouillet,† with an instrument called an *actinometer*, in regard to the temperatures of the celestial space. If we eliminate the effects of the rays of the sun, it is evident that the temperature of the space around the earth must be very near the absolute zero; for this space is traversed only by the rays of the stars, which, coming from such immense distances, are exceedingly feeble; and Pouillet has concluded, from his experiments and from various terrestrial phenomena, that this temperature must be between the limits of -175° and -115° , at the same time fixing on -142° as the most probable value. On the other hand, Clément and Désormes fixed on -273° as the absolute zero, on the ground that, since the permanent gases expand for each degree of temperature $\frac{1}{273}$ of their volume at 0° , the amount of contraction when the temperature was reduced to -273° would be equal to the initial volume, and the gases would cease to exist. Moreover, since a gas heated from 0° to 273° doubles its volume, they thought it evident that the quantity of heat added must be equal to that contained in the primitive volume.

Even if matter can exist without heat, which there is great reason to doubt, it is impossible to predict what would be its condition under such circumstances. It is supposed by some, who hold the atomic theory, that the molecules of matter would be brought into absolute contact, and that phenomena of a new and unexpected nature would appear. The violent explosion experienced by Chenot, while submitting silver in powder to a pressure of

* Annales de Chimie et de Physique, 3^e Série, Tom. XXI., XXIV., XXVII.

† Comptes Rendus, Tom. VII. p. 56.

three hundred atmospheres in an hydraulic press, is frequently cited in this connection. But these are mere assumptions, for we are as yet far from having realized experimentally an absolute zero of heat. The lowest temperature ever observed in the arctic region is -57° , and the lowest we can artificially produce is -140° ; at these temperatures several liquids still retain their fluid condition, which could hardly be the case if we had removed the greater part of the heat which they contain.

Change of State. — Liquids to Gases.

(281.) *Boiling-Point.* — It has been shown, that, when a solid is heated to such a temperature that the expansive force of heat between its particles is equal to the cohesive force, it melts. If the liquid be now heated above its melting-point, the expansive force will become greater than the cohesive force, and by continuing to raise the temperature we shall finally attain to a point where the excess of expansive force is equal to the atmospheric pressure. Then we have the condition of a gas, and a phenomenon presents itself which we term *boiling*. Bubbles of gas form beneath the surface of the fluid, and rise tumultuously through its mass.

This phenomenon can best be studied by heating water in a glass flask over the flame of a spirit-lamp. The first action of the heat is to expand the portion of the liquid immediately in contact with the bottom of the vessel, which, becoming specifically lighter, rises and gives place to colder water, which is heated and rises in its turn; and thus a circulation is established by which each particle of liquid is brought, in its turn, in contact with the heated surface. As the temperature of the mass rises, the air which is dissolved in the water separates in bubbles on the inner surface of the flask (compare page 396), and these, when they have attained sufficient size, disengage themselves and escape through the liquid. They are followed by bubbles of steam, which form on the heated surface of the flask, where, in consequence of the close proximity of the source of heat, the temperature is higher than that of the mass of the liquid; but as the bubbles rise through the cooler water above, they are condensed, and the shock produced by the sudden collapse gives rise to a peculiar

noise, an instance of which appears in the singing of a tea-kettle. After the whole mass of water has been heated to 100° , the bubbles of steam are no longer condensed, but rise to the surface and break, allowing the steam to escape; and as the tension of this steam is equal to the pressure of the air, it drives out the air from the upper part of the flask, and takes its place.

What is so familiar in the case of water, is equally true of other liquids. There is for each a temperature at which the expansive force of heat becomes equal to the pressure of the air, and at which this phenomenon of boiling invariably appears. This temperature, which is constant for the same substance under the same atmospheric pressure, is called the *boiling-point*. As the boiling-point varies with the atmospheric pressure, it is necessary, in describing the boiling-point of a substance, to state the pressure under which it was observed. In the following table, the boiling-points of some of the best-known liquids are given for the mean pressure of 76 c. m. :—

Boiling-Points under the Pressure of 76 c. m.

Protoxide of Nitrogen,	—105 ^o	Alcohol,	78 ^o
Carbonic Acid,	—78	Water,	100
Cyanogen,	—22	Nitric Acid (1.42),	120
Sulphurous Acid,	—10	Oil of Turpentine,	157
Chloride of Ethyle,	+11	Phosphorus,	290
Common Ether,	35	Sulphuric Acid (1.843),	325
Sulphide of Carbon,	47	Mercury,	350
Bromine,	63	Sulphur,	440
Chloroform,	63		

The influence of pressure upon the boiling-point of liquids may be illustrated by a great variety of experiments. If we place a glass of lukewarm water under the receiver of an air-pump and exhaust the air, the water will at once begin to boil violently. The same experiment may be tried even more simply in the following way.

Take a glass flask, to which a cork has been carefully fitted, fill it about one half full of water, and heat the water to boiling by means of a spirit-lamp. When the water is boiling rapidly, and the upper part of the flask is filled with steam, remove the lamp and quickly insert the cork. If now the flask is inverted

and cold water poured upon it, as represented in Fig. 403, the boiling will be renewed, and continue for some time.

This apparent paradox of boiling water by cold is thus explained. The cold water condenses the steam, producing a vacuum in the upper part of the flask, and, the pressure of the atmosphere being thus removed, the water continues to boil at a greatly diminished temperature. In the experiment of Leslie, hereafter to be described, water is made to boil at its freezing-point. Common ether boils under the receiver of an air-pump, from which the air has been partially exhausted, with explosive violence, even at the lowest natural temperatures. Such experiments as these may be multiplied indefinitely.

The ordinary variations of atmospheric pressure exert a very sensible influence on the boiling-point of water. The extreme heights of the barometer observed at Paris for the last thirty years have been 71.9 c. m. and 78.1 c. m. Under the first pressure, water boils at $98^{\circ}.5$, under the second, at $100^{\circ}.8$; so that the boiling-point is liable to a variation of about two degrees at that place. Hence the importance of regarding the height of the barometer in determining the boiling-point on the scale of the thermometer (218). Much greater variations in the boiling-point than these arise from differences of pressure at different elevations on the earth's surface. At the city of Quito, which is at an elevation of 2,908 metres above the level of the sea, and where the mean barometric pressure is equal to 52.7 c. m., water boils at $90^{\circ}.1$. At the city of Mexico, at an elevation of 2,277 metres and under a pressure of 57.2 c. m., it boils at $92^{\circ}.3$. Boiling water is not, therefore, equally hot at all places of the earth. At high elevations, as at Quito, for example, its temperature is much too low for cooking many substances which can be cooked at one hundred degrees.

It follows from the facts already stated, that a difference of pressure of 0.25 c. m. will cause a difference in the boiling-point of water of one tenth of a degree; so that from the boiling-point



Fig. 403.

of water, determined with accuracy, we can ascertain the pressure of the atmosphere at the time. An instrument has been constructed for this purpose, consisting essentially of a very delicate thermometer, made with an enlargement in the centre of the stem, as represented in Fig. 348. Its scale is limited to five or six degrees around the freezing-point and eight or ten degrees around the boiling-point, and each degree is subdivided into one hundred parts. This instrument is much more portable than a barometer, but on account of the shifting of the zero point, to which even the most carefully constructed thermometers are liable, it is much inferior to it in accuracy. A metallic vessel and a lamp for boiling the water accompany the instrument (Fig. 404).

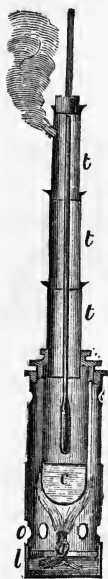

Fig. 404.

(282.) *Variations of the Boiling-Point.* — The boiling-point of liquids is influenced by other circumstances, whose action is not so readily explained as that of the atmospheric pressure. Thus a substance dissolved in a fluid more volatile than itself increases the boiling-point in proportion to the amount dissolved. Water, for example, which boils at 100° when pure, boils only at a considerably

higher temperature when it contains salt in solution, viz. : —

			Boiling-Point.
Water saturated with Common Salt,	.	.	109°
“ “ “ Nitrate of Potash,	.	.	116
“ “ “ Carbonate of Potash,	.	.	135
“ “ “ Nitrate of Lime,	.	.	151
“ “ “ Chloride of Calcium,	.	.	179

Substances, however, held simply in suspension, like shavings of wood or earthy particles, do not alter the boiling-point.

Again, Gay-Lussac observed that water boiled in a glass vessel at a higher temperature than in a metallic vessel; and, more recently, Marcet has established, first, that water boils in a glass vessel coated with sulphur or gum-lac at a temperature a little less than in a metallic vessel; secondly, that in a glass vessel the boiling-point of water is 1° or $1^{\circ}.25$ higher than in a metallic vessel; thirdly, that after sulphuric acid has been boiled in a

glass flask, the boiling-point is increased to a much greater extent than before, this increase sometimes amounting to five or six degrees. By throwing into the water, in either of these cases, pieces of metal, the boiling-point is at once reduced to 100° . The same variation of the boiling-point in glass vessels takes place with other liquids as well as water, and with some of them to a much greater extent. It is only in metallic vessels that the boiling-point is regular.

It follows from what has been said, that in any case the expansive force of the vapor formed during boiling is equal to the pressure to which the liquid is exposed, and it is also true, that the temperature of the vapor is the same as that of the boiling liquid. Two thermometers, the bulb of one dipping under the surface of a boiling liquid, and the other immersed in the vapor just above it, will, therefore, always indicate the same temperature, unless the boiling-point has been unnaturally increased by one of the causes just mentioned.

(283.) *Determination of the Boiling-Point.* — The causes mentioned in the last section, which influence the temperature of the boiling liquid, do not affect at all, or affect very slightly, the temperature of the vapor which rises from it. This at once adjusts itself to the pressure of the atmosphere, and is always constant for the same liquid under the same pressure. Hence the temperature of the vapor is more fixed than that of the liquid, and it is for this reason that, in graduating a mercury-thermometer, the tube is exposed to the steam from boiling water, and not dipped into the liquid itself. So also, in determining the boiling-point of other liquids, it is always best to measure the temperature of the vapor, and not that of the liquid, taking care that the pressure of the atmosphere is transmitted freely to its surface while boiling. The arrangement represented in Fig. 405 is very well suited to this purpose, the size of the glass boiler being adapted to the circumstances of the case. When the liquid under experiment is very costly, all

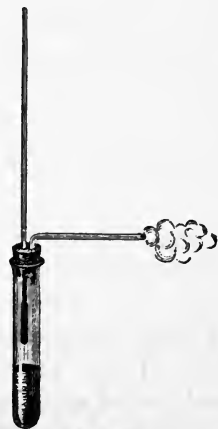

Fig. 405.

loss can be avoided by connecting the exit-tube with a Liebig's condenser (see Fig. 416).

(284.) *Formation of Vapor of Low or High Tension.* — The vapors or gases which are formed during the boiling of liquids have always the same tension as the atmospheric air, and are therefore able to retain their gaseous condition when exposed to its pressure. It is the formation of vapors of this kind that we have considered in the preceding sections. Liquids, however, yield vapors both of a lower and of a higher tension than that of the atmosphere, and we propose next to consider the conditions and laws under which these are formed.

In order to make the conditions as simple as possible, let us suppose a vessel having the capacity of one cubic metre, and let us dispose in it a barometer and thermometer, so that we can observe the tension and temperature of the confined gas. Moreover, let us pour into it a few kilogrammes of water and perfectly exhaust the air. If now we expose this vessel to various temperatures, it will be found, first, that for every given temperature a certain fixed weight of water will evaporate, and, secondly, that the vapor thus formed will have a certain definite tension which is invariable for that temperature. If we increase the temperature, the weight of the vapor formed will be greater, and the tension greater. If we diminish it, the weight will be less and the tension less, provided always that some liquid water remains in the vessel. The table on the opposite page gives for each temperature, first, the weight of vapor in grammes which the cubic metre will contain, and, secondly, the tension of the vapor.

By inspecting this table, several remarkable facts will be discovered. It will be seen, in the first place, that a very sensible amount of water will evaporate even at a temperature of ten degrees below the freezing-point, when, of course, the water in the vessel is in the state of ice. In the second place, it will be noticed that the tension of the vapor is less than the pressure of the atmosphere for all temperatures under 100° , and greater than the pressure of the atmosphere for all temperatures above 100° ; so that for all temperatures under 100° the pressure exerted by the vapor on the inner surface of the vessel is less than the atmospheric pressure on the outside, while for all temperatures over 100° it is greater. In the third place, it will be noticed that at 100° the tension is exactly equal to 76 c. m., the

Tension of the Vapor of Water, according to Regnault.

Tempera- ture.	Tension in Centimetres.	Weight of 1 Cubic Metre.	Tempera- ture.	Tension in Centimetres.	Weight of 1 Cubic Metre.
—10	0.2078	2.284	+33	3.7410	35.336
9	0.2261	2.476	34	3.9565	37.249
8	0.2456	2.679	35	4.1827	39.252
7	0.2666	2.897	40	5.4906	50.700
6	0.2890	3.129	45	7.1391	64.884
5	0.3131	3.377	50	9.1982	82.302
4	0.3387	3.640	55	11.7478	103.51
3	0.3662	3.920	60	14.8791	129.13
2	0.3955	4.219	65	18.6945	159.84
—1	0.4267	4.535	70	23.3093	196.38
0	0.4600	4.871	75	28.8517	239.59
+1	0.4940	5.212	80	35.4643	290.31
2	0.5302	5.574	85	43.3041	349.53
3	0.5687	5.957	90	52.5450	418.27
4	0.6097	6.363	95	63.3778	497.64
5	0.6534	6.795	100	76. = 1 At.	588.73
6	0.6998	7.251	120.6	2 Atmosph.	1115.8
7	0.7492	7.735	133.9	3 "	1618.9
8	0.8017	8.247	144.0	4 "	2106.1
9	0.8574	8.789	152.2	5 "	2581.9
10	0.9165	9.362	159.2	6 "	3048.0
11	0.9792	9.967	165.3	7 "	3506.5
12	1.0457	10.606	170.8	8 "	3957.7
13	1.1062	11.181	175.8	9 "	4402.6
14	1.1906	11.992	180.3	10 "	4843.3
15	1.2699	12.746	184.5	11 "	5278.6
16	1.3536	13.539	188.4	12 "	5709.8
17	1.4421	14.375	192.1	13 "	6136.4
18	1.5357	15.255	195.5	14 "	6560.4
19	1.6346	16.182	198.8	15 "	6979.6
20	1.7391	17.157	201.9	16 "	7396.4
21	1.8495	18.184	204.9	17 "	7809.3
22	1.9659	19.263	207.7	18 "	8220.3
23	2.0888	20.398	210.4	19 "	8628.6
24	2.2184	21.590	213.0	20 "	9034.0
25	2.3550	22.843	215.5	21 "	9437.4
26	2.4988	24.156	217.9	22 "	9838.1
27	2.6505	25.538	220.3	23 "	10235.5
28	2.8101	26.985	222.5	24 "	10632.9
29	2.9782	28.504	224.7	25 "	11026.6
30	3.1548	30.095	226.8	26 "	11419.6
31	3.3405	31.762	228.9	27 "	11809.2
32	3.5359	33.509	230.9	28 "	12198.3

pressure of the atmosphere. This is the boiling-point of water, the temperature at which bubbles of steam can form beneath the surface and rise to the top without being condensed. Lastly, it will be noticed that above 100° the tension of the vapor increases very rapidly with the temperature; so that at $121^{\circ}.4$ it is equal to 2 atmospheres, or twice the pressure of the atmosphere, and at $201^{\circ}.9$ to 16 atmospheres. Steam of greater tension than the atmospheric pressure is called *high-pressure steam*, and it is this condition of steam which is found above the water in a steam-boiler, and which is used with so much effect in the steam-engine.

(285.) *Dalton's Apparatus*.—The experiment described above, for determining the tension and weight of a cubic metre of the vapor of water at different temperatures, was merely devised for simplicity of illustration. In order to obtain even approximate results, it is necessary to experiment in a different manner and on a very much smaller scale. The tension of the vapor of water between 0° and 100° can be measured quite accurately by means of a common barometer-tube. If the tube is filled with mercury and inverted, as described in (157), the column of mercury will stand in the tube at the height of 76 c. m., more or less, above the mercury in the basin, according to the varying pressure of the air. Suppose, now, that we fill the tube again with mercury, only adding at the top a few drops of water, and invert it as before. The water will of course rise to the surface of the mercury, and a portion of it, varying with the temperature, will evaporate into the vacuum above. This vapor will exert a certain pressure, and depress the mercury-column; the amount of the depression will be equal to the difference between the present height of the column and that of the barometer at the beginning of the experiment. Moreover, it will be exactly the same as the height to which the vapor would raise the mercury of a barometer, if immersed in it, and will therefore be the measure of the tension.

The apparatus used by Dalton in his determinations of the tension of the vapor of water, and based on the principles just explained, is represented in Fig. 406. It consists of two barometer-tubes dipping into the same basin of mercury. The first of these tubes, *B*, is a perfect barometer. The second, *A*, is a barometer with a small amount of water above the mercury-column. These two tubes are enclosed in a tall glass cylinder, standing in

the basin of mercury and filled with water, whose temperature can be regulated by means of the furnace below. This temperature, observed by means of the thermometer *T* conveniently disposed, is of course the common temperature of the two barometers and of the vapor at the top of the second. In order, then, to determine the elastic force of this vapor, it is only necessary to measure the difference of height of the two columns, since this height reduced to 0° is the measure of its tension.

The apparatus of Dalton can be used so long as the elastic force of the vapor does not exceed the pressure of the atmosphere. When the tension is equal to 76 c. m., the surface of the mercury-column will be depressed to the level of the mercury in the basin, and the experiment is at an end. In order to continue the determination above this point, we

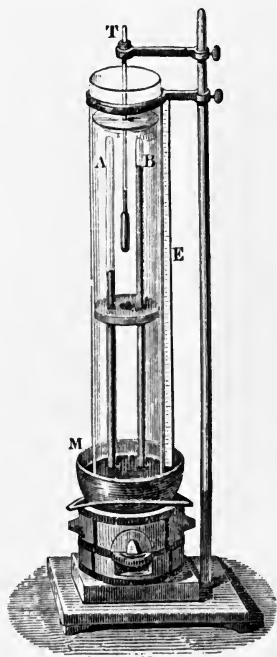

Fig. 406.

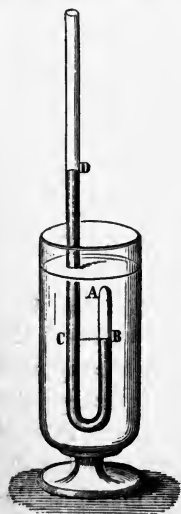

Fig. 407.

can use a siphon-tube, inverted and closed at the shorter end, as represented in Fig. 407. The tube is filled with mercury, with the exception of a small amount of water above the mercury in the shorter branch, and heated in an oil-bath. The tension of the vapor is evidently equal, at each moment, to the pressure of the atmosphere increased by the weight of the column *C D*.

On account of the difficulty of preserving a constant and uniform temperature throughout the whole height of the cylinder of water, the method of Dalton is not calculated to give accurate results, although in a modified form it was used by Regnault with great success for temperatures between 0° and 60°. The two

forms of apparatus just described may, however, be used for illustration with advantage; only in this case it is as well to substitute for the water some more volatile liquid.

(286.) *Marcet's Globe*.—The tension of the vapor of water above 100° may be roughly estimated by means of the apparatus



Fig. 408.

represented in Fig. 408. It consists of a stout brass globe containing water, and serving as a boiler. Through a tight packing-box passes a glass manometer-tube of about a metre in length, whose lower end opens under mercury resting on the bottom of the brass boiler. The globe has also two other openings; one of these may be closed by a stopcock, and through the other passes the tube of a thermometer, having its bulb within the globe. On commencing the experiment, the water is boiled for some time in order to expel all the air, and the stopcock is then closed. At this moment the temperature of the steam is 100° , and the tension 76 c. m. more or less, according to the pressure of the air. As soon, however, as the steam is prevented from escaping freely, the temperature of the globe will begin to rise, and at the same time the tension of the confined steam will increase, raising the mercury in the manometer-tube. For any temperature indicated by the thermometer, the corresponding tension of the vapor will be found by adding to the

height of the barometer for the time being the height of the mercury in the tube, measured by a scale provided for the purpose. This apparatus, like the last, is only calculated for illustration, and yields but approximate results.

(287.) *Apparatus of Gay-Lussac*.—For measuring the tension of the vapor of water below zero, Gay-Lussac employed the apparatus represented in Fig. 409. It consists, like the apparatus of Dalton, of two barometer-tubes filled with mercury, the open ends dipping under mercury in the same basin; one of these, *A*, which is straight, and perfectly freed from air and moisture by boiling the mercury in the tube, serves to measure the pressure of the air; the other contains a few drops of water above

the mercury-column, and its closed end is bent so that it can be surrounded by a freezing mixture, as represented in the figure. A thermometer, *t*, indicates the temperature of the vapor above the mercury-column, and the tension of this vapor, corresponding to each temperature, is readily determined by measuring with a cathetometer the difference of level of the mercury in the two tubes *A* and *C*. It will be noticed at once, that only a portion of the vapor in the tube *C* is exposed to the freezing mixture; but it is an established principle of hygrometry, that, *when the temperatures of two vessels communicating with each other are unequal, the tension of the vapor is the same in both, and is always that which corresponds to the lowest temperature.* The application of this principle in the above method is evident.

(288.) *Apparatus of Regnault.*—The accurate determination of the tension of the vapor of water at high temperatures is attended with great difficulties; but on account of the importance of the subject, arising from its connection with the steam-engine, no subject has been the object of more careful scientific investigation. It was first carefully investigated, in 1830, by a commission of the French Academy, consisting of Arago and Dulong; and more recently it has been reinvestigated by Regnault with his usual perseverance and skill. The results of his investigations were published in the twenty-first volume of the *Mémoires de l'Académie des Sciences*, to which we have so frequently had occasion to refer in these pages. Indeed, the determinations made by Regnault of the compressibility of gases (165), of their coefficients of expansion (261), and of the coefficients of expansion of mercury and glass (250 and 254), were merely preliminaries to this main investigation.

For temperatures below 60°, Regnault made use of the same method as Dalton, but modified his apparatus so as to avoid the

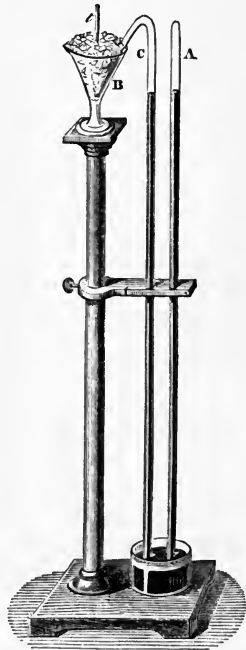

Fig. 409.

cause of error mentioned in (285). The apparatus, as thus modified, is represented in Fig. 410. The open ends of the two barometer-tubes t and t' dip into the same basin of mercury, which is furnished with an adjusting-screw, O , similar to that described in (159). The upper ends of these tubes

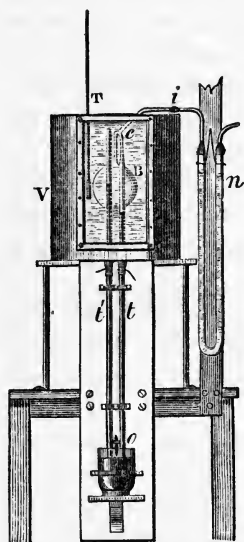

Fig. 410.

are enclosed within a cylindrical vessel, V , made of sheet-metal, and provided with a glass front, through which the height of the mercury-columns may be observed. The tubes pass through tubulatures in the bottom of the vessel, and are secured in their places by india-rubber connectors. The vessel V is filled with water, and its temperature is readily kept constant and uniform, at any point below 60° , by means of a spirit-lamp and by constant agitation.

In one series of experiments, Regnault employed two simple barometer-tubes, one filled with perfectly dry mercury, and the other containing, in addition, a small quantity of water above the mercury-column. For each temperature of the bath as indicated by the thermometer, T , he determined the difference of level of the mercury in the two barometer-tubes. This height reduced to 0° was evidently the measure of the tension of the vapor.

In another series of experiments, he connected with the upper end of the barometer-tube t , by means of a copper connector, a glass globe, B , having a capacity of about 500 c.m.^3 . A branch of this connector, $e i$, served also to connect the globe with an air-pump, through a U tube, n , filled with pieces of pumice-stone moistened with sulphuric acid; but before finally adjusting the apparatus, a small glass bulb, completely filled with water and hermetically sealed, was introduced into the glass globe. After the adjustments were completed, the interior of the globe was first perfectly dried by exhausting the air, and allowing it to re-enter a great number of times through the tubes e, i, n . It was then exhausted for the last time as perfectly as possible, and

the tube *i* hermetically sealed by the flame of a blowpipe. The globe was next surrounded by melting ice, and the tension of the small amount of air left in it carefully determined by measuring with a cathetometer the difference of level of the mercury in the two barometers. The ice having been removed, some pieces of burning charcoal were now brought near the bottom of the globe, so as to break the glass bulb within and liberate the water, which at once evaporated, and filled the globe and the upper part of the barometer-tube *t* with vapor. It only remained then to fill the vessel *V* with water, and to heat the bath to different temperatures, when the depression of the column of mercury, measured in the usual way, gave the tension of the vapor corresponding to each temperature.

It has been already stated, that the use of the apparatus just described is limited to temperatures below 60° . In order to determine the tension of the vapor of water at higher temperatures, Regnault resorted to an entirely different method. We have before seen (282) that the temperature of the vapor rising from a boiling liquid is the same as that of the liquid, and that its tension is always equal to the pressure to which the liquid is exposed. By boiling water, then, under different pressures, and determining the temperature at which it boils, we shall have at once the tension of the vapor corresponding to each temperature. The apparatus represented in Fig. 411 was used by Regnault for this purpose. It consists of a copper boiler, *C*, connected by the tube *AB* with a large globe, *M*, and further connected by the flexible hose *HH'* with an air-pump, by which the pressure on the surface of the water in the boiler may be varied at pleasure. This steam, as it rises from the boiler, is condensed in the tube *AB*, which is kept surrounded by cold water for the purpose, and the temperature of the globe *M* is also retained at a constant point in a similar way. The pressure under which the water boils is accurately measured by the manometer *O*, and the temperature at which it boils, when under this pressure, is determined with equal accuracy by means of four thermometers, whose indications serve to correct each other. They are inserted into iron tubes closed at the bottom and filled with mercury, which pass hermetically through the top of the boiler and descend to different depths in the steam and water it contains.

The method of using the apparatus will be made clear by an example. Let us suppose, then, that we wish to measure the tension of the vapor of water at temperatures between 150° and 100° . We should, in the first place, connect the hose HH' with a condensing-pump, and force air into the globe and boiler until

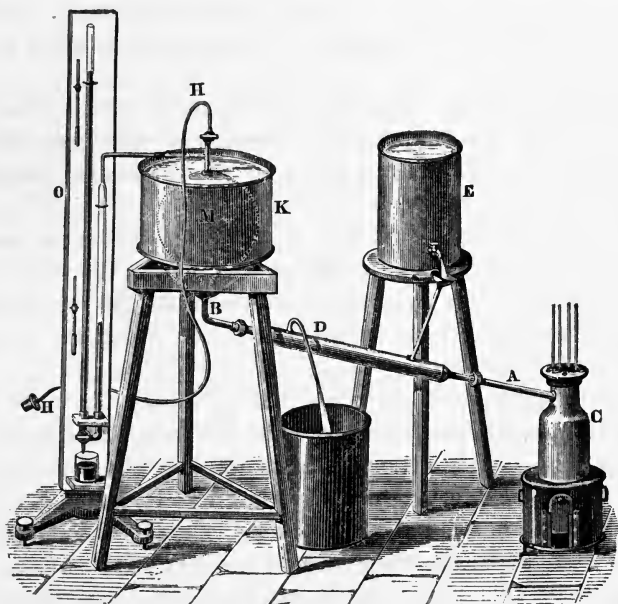

Fig. 411.

the manometer indicated a pressure in the interior of about four atmospheres. We should then, by means of a charcoal-furnace, boil the water in the vessel C , taking care so to regulate the heat that the steam will condense in the tube AB as fast as it forms in the boiler. When this is the case, the height of the manometer will remain constant during the whole course of the experiment, provided, of course, that the pressure of the atmosphere does not vary. The tension of the steam forming in the boiler can now easily be determined, for it must evidently be equal to the height of the barometer added to the difference of level of the two mercury-columns of the manometer. The temperature of the steam corresponding to this tension is then ascertained, by merely inspecting the thermometers connected with the copper boiler. Let us suppose that the difference of level of

the mercury-column of the manometer when reduced to 0° is found to be 254.524 c. m., and that the height of the barometer at the time, also reduced to 0° , is 76.209 c. m. The tension of the steam is then equal to 330.733 c. m. On inspecting the four thermometers, they were found to indicate respectively $147^{\circ}.50$, $147^{\circ}.49$, $147^{\circ}.54$, and $147^{\circ}.35$, the mean of the four being equal to $147^{\circ}.48$, which we take as the true temperature. Hence it follows that at $147^{\circ}.48$ the tension of the vapor of water is equal to 330.733 c. m.

Having determined, as just described, the tension of the vapor of water at one temperature, we should next diminish the pressure on the surface of the water in the boiler, by allowing a portion of the air to escape from the globe. The boiling-point of the water would at once fall, and we should then measure the tension and temperature corresponding to the new conditions; and by repeating this process several times, we should be enabled to fix the tension and corresponding temperature at several points between 150° and 100° .

The apparatus just described was constructed by Regnault chiefly to test the method on which it is based, and to discover the causes of error to which the method is liable. The apparatus actually used in the determination of the tension of the vapor of water at temperatures above 100° , although on precisely the same principle, was constructed on a very much greater scale, and capable of sustaining a very great pressure. The copper boiler had a capacity of about 70 litres, and its walls, 5 millimetres thick, were strengthened by bands of iron. The glass globe *M* of Fig. 411 was replaced by a very strong copper chamber, having a capacity of 280 litres, and this was connected with the boiler by a tube arranged exactly as in the smaller apparatus. The upper part of the chamber was also connected, on the one side with a pump for condensing air, and on the other with a manometer. This manometer was the same as that used by Regnault in his experiments on the compressibility of gases, to which we have already referred in connection with that subject (page 296). We have not space, however, to enter into a detailed description of the apparatus. This will be found in Regnault's original memoir. Suffice it to say, that every precaution was taken to secure accuracy which physical science could suggest, both in the apparatus and in the method of experimenting. Regnault

was able to experiment with this apparatus up to a pressure of twenty-eight atmospheres. Unfortunately, at thirty atmospheres one of the bolts which fastened the iron bands broke, in consequence of the distention of the boiler, and it was thought imprudent to continue the experiments.

(289.) *Discussion of the Results.* — By the methods described in the last section, Regnault determined the tension of the vapor of water at different temperatures between -32° and 230° . The intervals of temperature between the numerous determinations were necessarily very irregular, the precise temperature in each case depending on accidental circumstances. This is shown by the following table, which gives the results of a few only of the observations made by Regnault: —

Temp.	Tension.	Temp.	Tension.	Temp.	Tension.	Temp.	Tension.
$-32^{\circ}.84$	0.028	$*42^{\circ}.61$	6.322	$*125^{\circ}.71$	177.895	$*194^{\circ}.42$	1034.427
-12.53	0.161	58.62	13.905	153.90	394.486	212.20	1486.818
0.00	0.454	$*76.49$	30.671	$*167.40$	555.483	221.33	1779.011
$+20.51$	1.781	$*99.92$	75.790	185.67	857.242	230.50	2112.700

From these results, however, we can easily determine the tension corresponding to any other temperature between the limits of observation by either one of two methods.

The first method is to make a *geometrical construction* of the results of the experiments similar to that which is given in Fig. 412. In this figure, the abscissas of the curve *abcd* are the degrees of temperature; the ordinates are the corresponding tensions in atmospheres. The curve is constructed through the points indicated on the figure by dots, and these were fixed by the observations marked with a star in the above table. By means of this curve we can evidently ascertain at once the tension at any intermediate temperature, and prepare a table similar to that on page 571. The scale of Fig. 412 is, however, altogether too small to furnish even approximate results; but on the plate accompanying Regnault's memoir the same curve will be found drawn on a scale which is suitable for the purpose. The curve, even as drawn in our figure, will, however, convey to the mind a far better conception of the rapidity with which the tension of the vapor of water increases with the temperature, than could be given by a column of numbers.

The second method of determining the tension at temperatures

intermediate between those at which it has been actually observed, consists in using empirical formulæ similar in principle to those which we have previously employed to express the solubility of salts in water, or the rate of expansion of liquids at different temperatures. At least thirty such formulæ have been proposed at different times for the purpose, which agree, with more or less accuracy, with different sets of observations. The determinations of Regnault agree very nearly with the following exponential formula proposed by Biot:—

$$\log \mathfrak{f} = A - B \alpha^x - C \beta^x,$$

in which [199.]
 $x = t + 20^\circ.$

The five constants of this formula were calculated by Regnault

from 5 observed values of t and \mathfrak{f} , taken at intervals of sixty degrees

between -20° and 220° , and were found to be

$$\begin{aligned} A &= 6.2640348 \\ \log B &= 0.1397743 \\ \log C &= 0.6924351 \\ \log \alpha &= 9.9940493 \\ \log \beta &= 9.9983438 \end{aligned}$$

By means of this formula we can calculate the tension of the

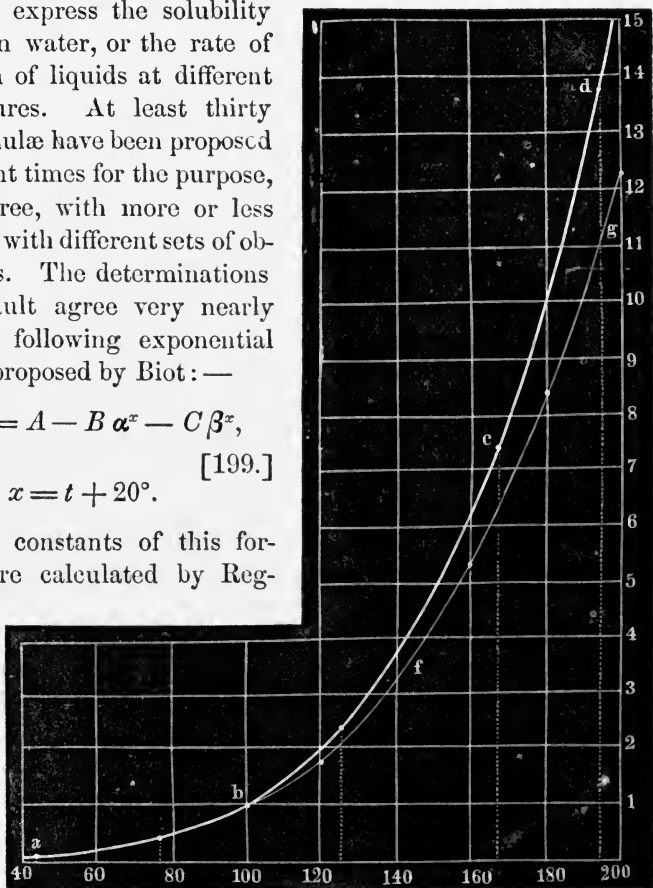

Fig. 412.

vapor of water at any temperature within the limits of the observations, with as great accuracy as that of the experimental data on which the formula is based; but, like other empirical formulæ, it cannot be relied upon if the temperature much exceeds these limits on either side. In calculating the table on page 571, Regnault used the formula and constants just given for all temperatures between 100° and 230° , but for lower temperatures he found it best to use two similar formulæ with different constants.

(290.) *Formation of Vapors of different Liquids.* — The laws of the formation of the vapor of water, which have been enunciated in the last few sections, also hold true for the vapors of other liquids. If instead of water we should introduce into the vessel of one cubic metre capacity assumed in (284) a small amount of alcohol, ether, sulphide of carbon, or any other liquid, it would be found that for any given temperature a certain fixed weight of each of these liquids would evaporate, and that the vapor formed would have a certain fixed tension. If the temperature were increased, more liquid would evaporate into the cubic metre, and the atmosphere of vapor formed would have a greater tension; and if the temperature were diminished, both the weight of the cubic metre of vapor and its tension would be less. Furthermore, the tension of the vapor at different temperatures could be determined by the same methods used in the case of water, and we could make for each liquid a table similar to that on page 571. Regnault* has furnished us with such a table for five of the most familiar liquids. This table, which gives, however, only the tensions of the vapors, will be found on the opposite page. The weight of one cubic metre of each vapor can readily be calculated for each temperature by means of the formulæ which will be developed in the next chapter.

It has already been stated (282), that at the boiling-point the tension of the vapor of any liquid is exactly equal to the pressure of the atmosphere, and Dalton supposed that at temperatures equally distant from their respective boiling-points the vapors of all liquids were approximatively equal in tension. If this principle (which is usually known under the name of Dalton's law) were true, we could easily calculate from the tension of the vapor of water that of any other liquid. Suppose, for example, it was required to find the tension of the vapor of ether at 50° , which is 15°

* Comptes Rendus, Tom. XXXIX. p. 301.

Temperature.	Alcohol.	Ether.	Sulphide of Carbon.	Chloroform.	Oil of Turpentine.
-21	0.312				
20	0.334	6.92			
16	5.88		
-10	0.650	11.32	7.90		
0	1.273	18.23	12.73	. . .	0.21
+10	2.408	28.65	19.93	13.04	0.23
20	4.40	43.48	29.82	19.02	0.43
30	7.84	63.70	43.46	27.61	0.70
40	13.41	91.36	61.75	36.40	1.12
50	22.03	126.80	85.27	52.43	1.72
60	35.00	173.03	116.26	73.80	2.69
70	53.92	230.95	154.90	97.62	4.19
80	81.28	294.72	203.05	136.78	6.12
90	119.04	389.90	262.31	181.15	9.10
100	168.50	492.04	332.13	235.46	13.49
110	235.18	624.90	413.63	302.04	18.73
116	. . .	707.62
120	320.78	. . .	512.16	381.80	25.70
130	433.12	. . .	626.06	472.10	34.70
136	702.92
140	563.77	46.23
150	725.78	60.45
152	761.73
160	77.72
170	98.90
180	122.50
190	151.47
200	186.56
210	225.12
220	269.03
222	277.85

above its boiling-point. According to the above principle, this tension is the same as that of the vapor of water at 115° , or 126.9 c. m., a number which differs but very slightly from that determined by actual experiment, and given in the foregoing table. It has been shown, however, by the investigations of Regnault, that Dalton's law is not absolutely rigorous, and at large distances from the boiling-point is so far from coinciding with the facts, that it cannot be relied upon except for furnishing the first rough approximation to the actual tension of a volatile liquid.

It follows at once from the law of Dalton, that at any given temperature different liquids may have very unequal tensions,

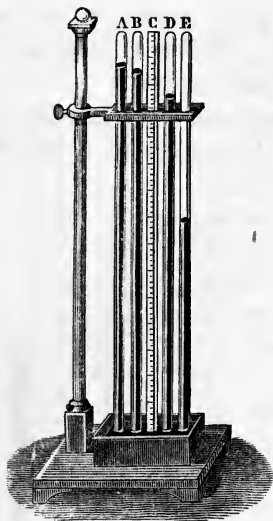

Fig. 413.

and, moreover, that in any one case the tension must be the greater the lower the boiling-point and hence the more volatile the liquid. These facts may be illustrated by means of the apparatus represented in Fig. 413. It consists of four barometer-tubes, all dipping into the same basin of mercury. The first at the left is a perfect barometer, and therefore indicates the pressure of the air; but the others contain a few drops of some volatile liquid above the mercury-column. The tension of the vapor of these liquids is measured, of course, by the depression of the mercury; this will be found to be greater

in proportion as the boiling-point is lower.

(291.) *Maximum Tension of Vapors.* — The vapor of any liquid which forms in a confined space and *in the presence of an excess of the liquid*, has always the greatest tension which the vapor can have at the given temperature. To recur, for example, to our previous illustration: at the temperature of 20° , there would form in the vessel described in (284) a cubic metre of vapor weighing 17.155, and having a tension equal to 1.739 c. m., provided only an excess of water were present. Now this is the greatest tension which the vapor of water can have at 20° . If by mechanical means, as by sinking a piston in a cylinder, we attempt to increase the elasticity of the vapor without changing the temperature, we find that it is at once condensed to liquid water, and that its tension remains constant at 1.739 c. m. until all the vapor has disappeared. On now raising the piston, the space will be filled again with vapor; but so long as a drop of water remains in the cylinder, the tension of this vapor will still be equal to 1.739 c. m. If, however, after all the water has evaporated, we still continue to enlarge the capacity of the cylinder, then the vapor will act like a gas, and its tension will diminish, in accordance with the law of Mariotte; compare (156.3) and (163). In the above illustration we have assumed that the temperature of the vessel was constant at 20° ; but the same principle

is equally true at all temperatures and for all liquids, and all the tensions given in the tables on pages 571 and 583 are the maximum tensions possible at the respective temperatures.

This principle may be illustrated experimentally by means of the apparatus represented in Fig. 414. It consists of a barometer-tube and a deep mercury cistern, in which the tube can be entirely immersed. In order to mount the apparatus, the tube is, in the first place, nearly filled with mercury, which is boiled to expel the air, and then the rest of the tube filled with ether. On inverting the tube and plunging the open end under the mercury of the cistern in the usual way, the ether rises to the top of the tube, and a part remains liquid, while the rest forms a vapor which, at the ordinary temperature of the air, depresses the mercury-column about 36 c. m.; so that the mercury stands in the tube at 40 c. m., instead of 76 c. m., above the level of the mercury in the cistern. The tension of ether vapor at the ordinary temperature is consequently 36 c. m. If now we attempt to increase the tension of this vapor, and consequently diminish its volume, by sinking the tube in the cistern (Fig. 414), we shall find that a portion of the vapor will condense; but the mercury-column will remain at the same height in the tube, proving that the vapor which is still uncondensed has the same elasticity as before. On continuing to depress the tube, it will be found that the height of the mercury-column, and consequently the tension of the vapor, will remain absolutely the same until the last bubble has been condensed. This proves that 36 c. m. is the maximum tension which the vapor of ether can be made to assume at the ordinary temperature of the air.

(292.) *Gases and Vapors.*—The principles of the last section furnish a convenient ground of distinction between gases and vapors. It is usual to apply the term *vapor* to such aeriform

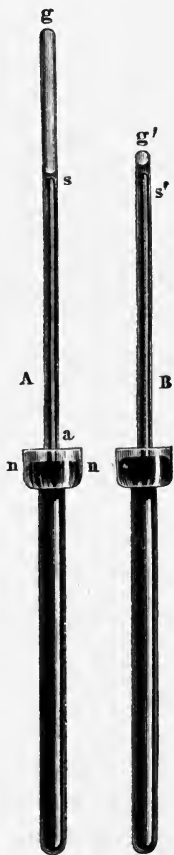

Fig. 414.

substances as are easily condensed, either by pressure or by cold, into liquids, and which, under the ordinary conditions of atmospheric temperature and pressure, exist in the liquid state. This definition, however, is purely artificial, and makes no *essential* distinction between a gas and a vapor; and we therefore prefer to distinguish by the word *vapor* the peculiar condition of aeriform matter when it is at the point of maximum tension. According to this definition, a vapor is a condition of aeriform matter which obeys the law of Mariotte when its volume is increased, but which, if the volume be diminished, is in part changed into a liquid; a gas, on the other hand, is a condition of aeriform matter which obeys the law, whether its volume be increased or diminished. We may also define a vapor as that condition in which a gas exists the moment before its change of state.

This distinction between a gas and a vapor will be made clearer by pursuing still further the illustration of the last section. Let us suppose that we have a cylindrical vessel exposed to the temperature of 130° , and filled with steam having a tension equal to 98.956 c. m. By referring to Table IX. of the Appendix, it will be seen that the maximum tension of the vapor of water at 130° is 203.028. Now, if there were in the vessel a supply of water, the liquid would continue to give off vapor until this tension was attained. But we will assume that there is no liquid water present, and that the cylinder is filled with expanded steam. Under these circumstances, the steam must retain the tension of 98.956 c. m. so long as both the temperature and the volume remain unchanged.

If now, keeping *the temperature constant*, we increase the capacity of the cylinder by raising the piston, the steam will expand, and its tension will diminish in accordance with Mariotte's law. When the volume is doubled, the tension will be found to be 49.478 c. m.; when quadrupled, the tension will be reduced to 24.739 c. m.; and in any case we can find the tension corresponding to the increased volume by the proportion *

$$V : V' = \mathfrak{H}' : \mathfrak{H}. \quad [200.]$$

* This equation is merely [98], substituting \mathfrak{H} and \mathfrak{H}' for H and H' . The student must be careful to bear in mind that the tension of a gas is always equal to the pressure to which it is exposed (149). We here leave out of the account any deviation from Mariotte's law, which, nevertheless, may be very considerable as the point of condensation is approached (165 and 166).

Moreover, when the volume has been only so far increased that the tension of the steam has been reduced to 76 c. m., it is then in the same condition as that in which a gas (like sulphurous acid, for example) exists at the ordinary temperature. It will sustain the pressure of the atmosphere, and, were the temperature of the laboratory as high as 130° , it might be collected over a mercury trough and transferred from one jar to another, like any other gas.

Again, if, still keeping the temperature constant at 130° , we now lessen the capacity of the cylinder by sinking the piston, the tension of the confined steam will be increased up to a certain point in accordance with Mariotte's law; in other words, it will manifest all the characters of a gas, and its tension at any degree of condensation may be calculated by the same formula as before. If, however, we continue to sink the piston until the volume of the steam is reduced to a little less than one half of its original volume, and the tension increased to 203.028 c. m., we shall reach a point at which the steam suddenly ceases altogether to obey the law of Mariotte; and if we sink the piston still further, the tension will not increase in the slightest, but a portion of the steam will be changed into water, and this change will proceed until the piston reaches the bottom of the cylinder, the tension all the time remaining constant at 203.028 c. m. It is to this peculiar condition of aeriform matter that we give the name of vapor.

Returning now to the initial condition of the cylinder, when it is filled with steam at the tension of 98.956 c. m., let us vary the temperature, while we keep *the volume absolutely constant*. If we increase the temperature, we shall increase the tension of the confined steam, according to the same law by which the tension of a confined mass of air would be increased under the same circumstances. If, on the other hand, we lessen the temperature, we shall diminish the tension of the confined steam, according to the same law as before, until we reach a temperature at which the tension of the steam is the maximum tension for that temperature. Then, on still further cooling the cylinder, a portion of the steam will change into water, and the tension of the remaining vapor will be found to be the maximum tension corresponding to the reduced temperature.

If we know the tension of a confined mass of gas at any given

temperature, we can always readily calculate its tension for any other temperature, assuming, as we have above, that the volume does not change. Let V represent the volume of a gas which has a tension \mathfrak{f} at t° . The volume of this mass of gas at t'° , if allowed to expand freely, *the tension remaining constant*, would be, by [184], $V(1 + 0.00366 [t' - t])$. If now this increased volume is reduced by pressure again to V , the tension (which was before \mathfrak{f}) will of course be increased, and we shall evidently have the same condition as if the gas had not been allowed to expand. But we have, by [200],

$$V(1 + 0.00366 [t' - t]) : V = \mathfrak{f}' : \mathfrak{f},$$

and hence we obtain for the value of the increased tension,

$$\mathfrak{f}' = \mathfrak{f} (1 + 0.00366 [t' - t]). \quad [201.]$$

Applying now this formula in the example under discussion, we should find that the steam, whose tension was equal to 98.956 c. m. at 130° , would have at 105° a tension of

$$\mathfrak{f} = 98.956 \div (1 + 0.00366 \times 25) = 90.641 \text{ c. m. ;}$$

and on referring to the table, it will be seen that this is the maximum tension which steam can have at 105° . Hence at this point the steam assumes the condition of vapor. By the same formula, it will appear that at 104° the tension of the steam would be 90.334 c. m., but by the table 87.541 c. m. is the maximum tension possible at 104° ; as much vapor will, therefore, be condensed to water as is necessary to reduce the tension to this amount. The same will be true, to a still greater degree, at any lower temperature.

(293.) *Distillation.* — It has now been shown, first, that the tension of the vapor which rises from a boiling liquid is always equal to the pressure of the atmosphere; secondly, that this tension is the maximum tension possible for the temperature, so that if the volume is reduced by mechanical means the tension is not increased, but a portion of the vapor is condensed to the liquid state. From these two facts it follows, as a necessary consequence, that a vapor will be condensed to a liquid by the pressure of the atmosphere, if its temperature falls below the boiling-point of this liquid (except under the conditions hereafter to be considered, when the vapor is diffused through the atmosphere itself).

The process of distillation, which is used in the arts for the purpose of separating a volatile substance from one that is fixed or less volatile, is a direct illustration of this principle. The simplest apparatus for the purpose is represented in Fig. 415.

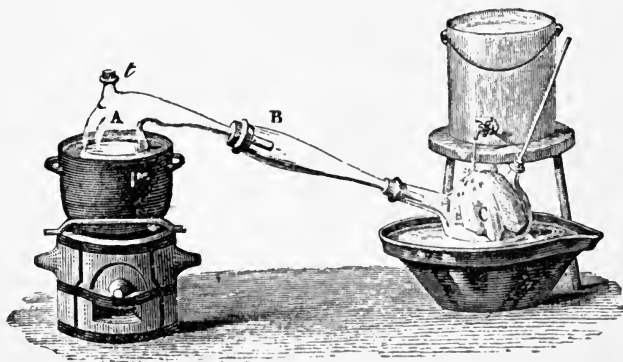

Fig 415

The liquid is boiled in a glass retort, and the vapor which is thus formed is conducted into a receiver, where it is cooled below the boiling-point, and again reduced to the liquid state. Since glass vessels when exposed to a naked fire are liable to break, the body of the retort is usually protected by placing it within an iron pot and surrounding it with sand. Such an arrangement is termed

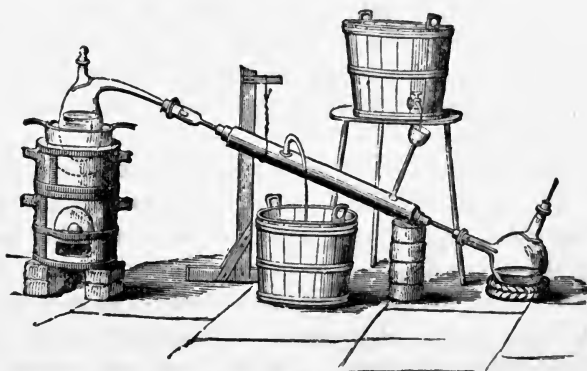

Fig. 416.

a *sand-bath*, or, when water is used in the place of sand, a *water-bath*. Another form of distillatory apparatus is represented in Fig. 416. Here the neck of the retort is connected with what is

usually termed a *Liebig's condenser*. It consists of a tube of glass, which is kept cold by a current of water circulating through a copper cylinder, which surrounds it. In the com-

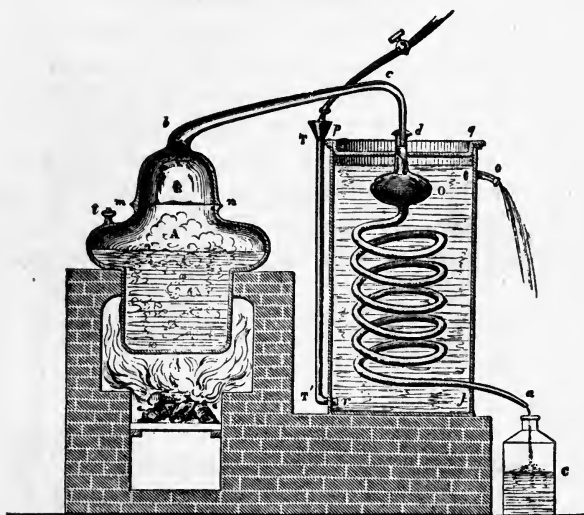

Fig. 417.

mon still, Fig. 417, a large copper boiler supplies the place of the retort, and the vapor is condensed in a spiral tube of copper, called a *worm*, which is kept immersed in a tank of cold water.

Since the boiling-point of a liquid is reduced in proportion as the atmospheric pressure is removed, it is sometimes advantageous



Fig. 418.

to conduct the process of distillation in a partial vacuum. This is especially the case with some organic substances which have a high boiling-point and are decomposed by heat. The apparatus represented in Fig. 418 is adapted

for this purpose. The retort *A* is connected by an hermetically sealed joint with the receiver *B*, and this again, through the tube

r , with an air-pump, by which the pressure on the surface of the liquid in the retort may be very greatly reduced. The same principle is applied in the sugar refineries in order to concentrate syrups at a low temperature (vacuum-pans).

(294.) *Steam-Bath.* — The fact, that the temperature of boiling water and of the steam rising from it is constant at 100° , is frequently applied in the laboratory when it is important to maintain a moderate and constant degree of heat for a length of time. The arrangement which is usually adopted for evaporating liquids at 100° is represented in Fig. 419. The porcelain evaporating-dish rests on the rim of a hemispherical vessel of copper, in which water is kept constantly boiling by means of a spirit-lamp.



Fig. 419.

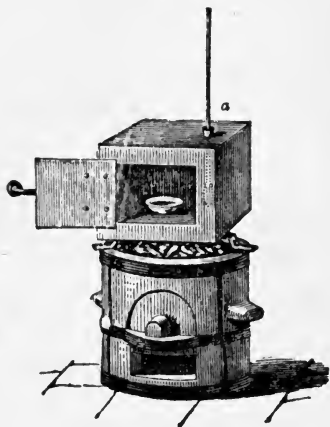

Fig. 420.

For drying precipitates, or for expelling the water of crystallization from a salt, the chemist frequently uses a steam-bath like the one represented in Fig. 420. This is simply a copper oven with double sides, which is maintained at 100° by boiling the water which partially fills the cavity between the inner and outer lining of the oven.

(295.) *Papin's Digester.* — Water, when enclosed in a strong vessel, can be heated, as we have seen, to a temperature very much above 100° ; and this fact is advantageously applied in Papin's Digester, which is very useful in the laboratory when it is required to expose substances to the action of water at a temperature between 100° and 200° for a length of time. It consists

generally of a thick cylindrical vessel of brass, *D*, Fig. 421, closed by a thick cover of the same material, which is kept in its place by the screw *B S*. A safety-valve, *op A*, serves to regulate the pressure, and thus

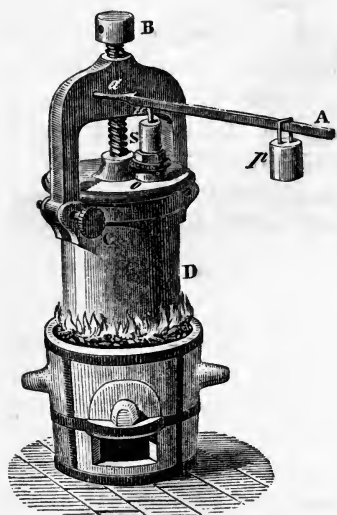

Fig. 421.

the temperature of the water, as well as to insure the safety of the apparatus. The details of the construction of the safety-valve are given in Fig. 440. This digester can also be used with great advantage to produce chemical reactions which could not be readily obtained under the pressure of the air. For this purpose, the substances are sealed up together in glass tubes, and exposed to the temperature of the overheated water, and any interior pressure resulting from the evolution of gas in the tube is more or less balanced by the exterior

pressure of the confined steam.

(296.) *Condensation of Gases.* — There are many substances which boil at so low a temperature that they retain, at the ordinary temperature of the atmosphere and under the usual pressure, the condition of a gas. The boiling-points of a number of such substances are given in the following table: —

Sulphurous Acid,	—10°	Sulphide of Hydrogen,	—73°
Cyanogen,	—20	Hydrochloric Acid,	—80
Ammonia,	—36	Carbonic Acid,	—80
Arsenide of Hydrogen,	—58	Protoxide of Nitrogen,	—87.2

All these substances manifest, at the ordinary temperature of the air, the same physical properties which steam would manifest at 130°, as described in (292); and if in either case the temperature of the gas is reduced below the boiling-point, then the tension of the vapor will be reduced to less than 76 c. m., and the gas will be condensed to a liquid by the pressure of the air, exactly as in the process of distillation.

This fact is illustrated by the common method of preparing liquid sulphurous acid. This gas, which is generated by heating together metallic mercury and strong sulphuric acid in a glass retort (Fig. 422), is passed into a *U* tube surrounded by a mixture of ice and salt, where it collects as a liquid. Had we the means of producing readily a sufficient degree of cold, we might easily condense to liquids the other gases in the same way.

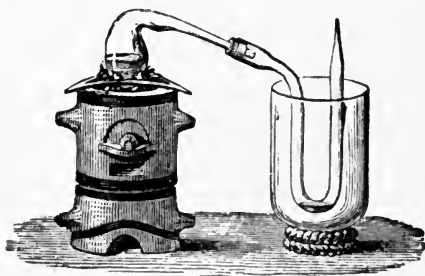

Fig. 422.

For any given temperature, the vapor of each of the substances included in the above table has, like the vapor of water, a definite maximum tension, which it cannot exceed; and if we had the requisite data, we could make out for each one a table of maximum tensions at different temperatures similar to the tables on pages 571 and 583. Bunsen has furnished us with such a table for the first three substances.

Temperature.	Sulphurous Acid. Tension in c. m.	Cyanogen. Tension in c. m.	Ammonia. Tension in c. m.
-37°	74.9
20	...	80	...
15	...	110	...
10	78	141	...
-5	111	173	304
0	148	207	361
$+5$	191	244	426
10	239	283	498
15	293	333	578
20	354	380	667.4
25	420		

Moreover, what was shown in (292) to be true in regard to steam at 130° is equally true of these gases at the ordinary temperature of the air. If, for example, we suppose the cylinder, so often referred to, to be filled with sulphurous acid gas, and maintained at a constant temperature of 15° , we should find, on pressing down the piston, that the tension would increase as the

volume diminished, until it became equal to 293 c. m.; but on still further reducing the volume, the gas would liquefy. The same would be true of cyanogen when the tension became equal to 333 c. m., and of ammonia when it became equal to 578 c. m., assuming, of course, that the temperature of the cylinder is maintained constant at 15° . If the temperature is diminished, the gases cannot acquire so great a tension; if it is raised, the tension may be greatly increased.

These facts may be very elegantly illustrated by means of the apparatus represented in Fig. 423. It consists of an iron cistern,

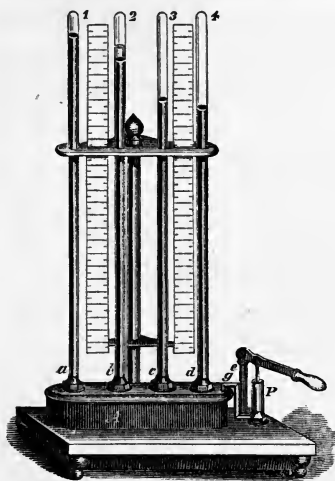

Fig. 423.

A, filled with mercury, and closed on all sides with the exception of five circular apertures through the top. Into four of these may be screwed the iron tubes *a*, *b*, *c*, and *d*, which reach to the bottom of the cistern. These tubes are provided with a broad shoulder, and are screwed down upon lead washers with a wrench, so as to enable the joint to resist a pressure of ten or twelve atmospheres without yielding. Into the open ends of these iron tubes the glass tubes 1, 2, 3, and 4 are cemented. They are about one centimetre in diameter and closed at the top. When the apparatus is in use, one of the

tubes may be filled with air, and the other three with ammonia, cyanogen, and sulphurous acid, respectively. By the fifth aperture, *e*, the interior of the mercury-cistern connects with the force-pump *P*, through the tube *g*; and by this water may be forced in upon the surface of the mercury. The pressure thus exerted will cause the mercury to rise in the several tubes, and as the volumes of the confined gases are diminished, it will be noticed that their tension rapidly increases. This tension, which is evidently the same in all four tubes, is measured by the tube containing air, which serves as a manometer (168. 3). If the temperature of the apparatus is kept constant at 15° , the tension will increase until it is equal to 293 c. m.; then the sulphurous

acid will begin to liquefy, and the tension will remain equal to 293 c. m. until all this gas has disappeared. It will then again increase until it reaches 333 c. m., when the cyanogen will liquefy; and, finally, after this gas has also been reduced to a liquid, the tension will increase again until it becomes equal to 578 c. m., when, last of all, the ammonia will liquefy. If now we remove the pressure by opening the stopcock, which vents the water from the cistern, the liquids will be seen, one after the other, to boil violently, and return to the condition of gas.

Since the tension of a gas is always equal to the pressure to which it is exposed, it follows that any gas will be condensed to a liquid if it is exposed to a pressure which is greater than its maximum tension at the given temperature. The maximum tensions of a number of gases at 0° are approximatively as follows:—

Maximum Tension at 0° C.

	Atmospheres.		Atmospheres.
Sulphurous Acid, . . .	1.53	Chlorine,	8.95
Cyanogen,	2.37	Sulphide of Hydrogen, .	10
Iodohydric Acid, . . .	3.97	Chlorohydric Acid, . .	26.2
Ammonia,	4.40	Protoxide of Nitrogen, .	32
Arsenide of Hydrogen, .	8.80?	Carbonic Acid,	38.5

And if, in either case, the temperature being at 0°, the gas is exposed to a greater pressure than the tension indicated in the table, it will be condensed to a liquid. If the temperature is higher, the pressure required in each case will be greater. If the temperature is lower, the pressure required will be less; and if in either case the temperature is reduced below the boiling-point of the substance, the gas will be condensed, as we have seen, by the pressure of the air alone. It is evident that, in condensing gases to liquids, a great advantage is gained by reducing the temperature as low as the circumstances will permit, and hence it is usual to employ both pressure and cold for the purpose. Several of the processes in use are as follows.

The simplest method of condensing gases consists in generating a large volume of the gas from the proper chemical materials in a confined space. This method was used by Faraday in his original experiments on this subject. He generated the gas in

one end of a strong glass tube, bent at the middle, as represented in Fig. 424, and hermetically sealed. The gas accumulating in the confined space exerted a great pressure against the sides of the tube, and when this pressure became equal to the maximum tension, a portion of the gas was condensed to a liquid. This collected in the other end of the tube, which was immersed in a freezing-mixture to facilitate the process. With this simple apparatus Faraday succeeded in liquefying sulphurous acid, cyanogen, chlorine, ammonia, sulphide of hydrogen, carbonic acid, muriatic acid, and nitrous oxide gases.

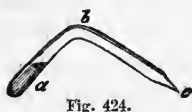

Fig. 424.

The principle of Faraday's condensing tubes was afterwards applied by Thilorier to condensing carbonic acid gas on a large

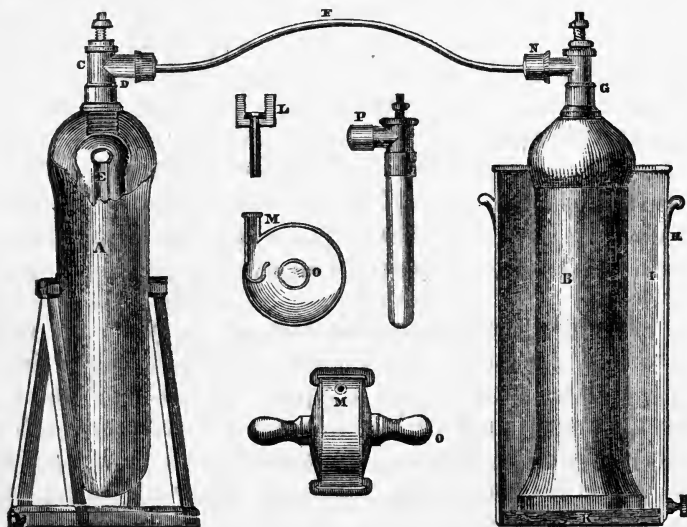

Fig. 425.

scale. The apparatus which he devised for the purpose is represented in Fig. 425. It consists of two cylindrical vessels of iron, made exceedingly strong, and of the capacity of about eight litres each. They are closed by valve stopcocks of peculiar construction, which screw into the necks of the two vessels and can be removed at pleasure. By means of the copper connecting-tube *F*, which can be attached by couplers to the discharging orifice of the valves *D* and *N*, the two cylinders may be united when necessary.

In order to use the apparatus, the valve *C* is removed from the cylinder *A*, called the generator, and a charge is introduced, consisting of one kilogramme of pulverized bicarbonate of soda mixed with a litre of lukewarm water. After this has been poured into the cylinder, a long cylindrical vessel (*E*), containing about 650 grammes of common oil of vitriol, is carefully let down by a hook without spilling. The valve-cock, having been first carefully closed, is now screwed down tightly to the mouth of the generator, which is then turned upon its supporting-pivots so as completely to invert it, and thus mix the acid with the carbonate of soda. The carbonic acid of the salt, which amounts to more than half of its weight, is now rapidly disengaged, and accumulates in the vacant part of the generator, exerting great elastic force. The generator is next connected, as represented in the figure, with the second large cylinder (*B*), which serves as a receiver, and which is surrounded by a mixture of ice and salt. On opening the two valves, the condensed gas rapidly passes over and collects in the cold receiver. The cylinders are then disconnected, after first closing the valves, and, the generator having been carefully emptied, the same process is repeated. After two or three charges have been in this way conveyed into the receiver, the pressure becomes sufficient to liquefy the gas; and after ten or twelve charges the receiver may contain several litres of liquid carbonic acid. The receiver is then finally detached, and the liquid which it contains preserved for use. If this liquid is allowed to flow out into the air, a portion of it evaporates, and, as we should expect, with great rapidity; but, what is more wonderful, the cold caused by the evaporation is so great, that the larger part of the liquid freezes, changing into a white flocculent solid resembling snow. This very remarkable phenomenon will be best studied, however, in connection with the latent heat of vapors. In order to show the substance in its liquid condition, a small quantity may be drawn off from the receiver into the thick glass tube *P*, which is then closed by a valve-cock like that of the receiver itself. It is always dangerous, however, to confine liquid carbonic acid in glass.

Although the apparatus of Thilorier is exceedingly convenient, and yields, with little labor, a large supply of liquid carbonic acid, yet its use is not unattended with danger; and a fatal accident, caused by the bursting of one of the iron generators, at the

School of Pharmacy in Paris, has brought it into general disfavor. The danger arises from the circumstance that the chemical action of the sulphuric acid on the carbonate of soda is

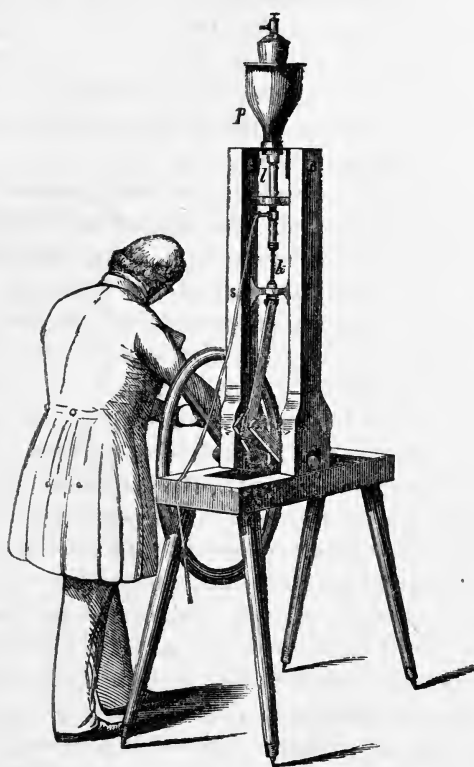

Fig. 426.

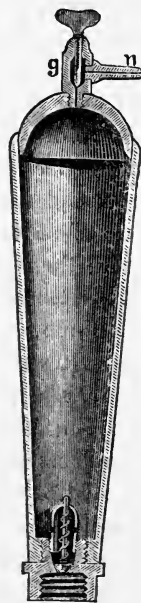

Fig. 427.

attended with the evolution of heat, which raises the temperature of the generator, and very greatly increases the maximum tension of the gas. In the receiver, when surrounded by ice and salt, the tension is comparatively feeble, and all danger may be avoided by condensing the gas with a force-pump directly into the cold receiver. An apparatus for this purpose is constructed both by Natterer, in Vienna, and by Bianchi, in Paris. It consists of a condensing-pump (178), represented at *l* in Fig. 426, which draws the gas from a gasometer through the flexible hose *s*, and forces it into an iron receiver, which is represented in Fig. 427, of one fifth of its usual size. This receiver screws

upon the upper end of the pump-barrel, and it is closed below by a self-acting valve, and above by the valve-cock *g*, as shown in Fig. 427. A crank and fly-wheel facilitate the working of the pump; but it requires several hours of hard work to liquefy only 500 grammes of gas. After the receiver is about two thirds filled with liquid, it is unscrewed from the pump-barrel, and the liquid can then be drawn out by inverting it and opening the valve *g*. This apparatus has been especially used for liquefying nitrous oxide gas.

Professor Faraday succeeded in liquefying several gases which had not been condensed before, by combining the action of intense cold and great pressure, the last obtained with a very powerful condensing apparatus. This apparatus consisted of two condensing syringes. The first had a piston of an inch in diameter, the second of only half an inch; these syringes were connected by a pipe, so that the first syringe forced the gas through the valves of the second, and the second syringe was then used to compress still more highly the gas which had already been condensed by the action of the first, with a pressure varying from ten to twenty atmospheres. The gases were condensed by this apparatus into tubes of green bottle-glass bent at the middle into the form of a U, and closed at the ends with brass caps and stopcocks, securely fastened by means of a resinous cement. The curved portion of the tube was immersed in a bath of solid carbonic acid and ether, and at times a still greater degree of cold, estimated at -110° , was obtained by placing the bath under the receiver of an air-pump and exhausting the air. When exposed to this very low temperature, most of the liquefied gases froze, as is shown by the following table, which contains the results of Faraday:—

Gases not yet Liquefied.	Gases Liquefied, but not Frozen.	Gases Liquefied, and also Frozen.	Melting- Point.
Air.	Olefant Gas.	Bromohydric Acid,	-8°
Oxygen.	Chlorohydric Acid.	Cyanogen,	35
Nitrogen.	Fluohydric Acid.	Iodohydric Acid,	51
Hydrogen.	Fluosilicic Acid.	Carbonic Acid,	58
Oxide of Carbon.	Phosphide of Hydrogen.	Ammonia,	75
Marsh Gas.	Arsenide of Hydrogen.	Sulphurous Acid,	76
Deutoxide of Nitrogen.	Chlorine.	Sulphide of Hydrogen,	86
		Protoxide of Nitrogen,	-100

More recently, Natterer of Vienna, has constructed a vastly more powerful condensing apparatus than that of Faraday, al-

though on a similar principle, by which he has been able to exert a pressure of nearly three thousand atmospheres; but the gases enumerated in the first column of the above table did not yield even to this immense pressure, and indeed were not condensed so much as we should be led to expect from the law of Mariotte. For a description of this apparatus, the student may consult the memoir already referred to (page 299).

The facts of this section all tend to show how completely the mechanical condition of matter depends on the temperature of the globe. If the mean temperature were 100° below the present point, by far the larger number of known gases would be either solids or liquids. To the inhabitants of such a climate (whom we may suppose to use a Centigrade thermometer on which -100° of our scale would be the zero-point), protoxide of nitrogen would be a very volatile liquid, freezing at 0° and boiling at 13° ; cyanogen would be a crystalline solid, melting at 65° and boiling at 80° ; and sulphurous acid would be a solid, melting at 24° and boiling at 90° . On the other hand, were the mean temperature of the globe 100° above the present point, many of our most familiar liquids would be known chiefly as gases. Ether, alcohol, and water would stand very nearly in the same relation in such a climate that sulphide of hydrogen, cyanogen, and sulphurous acid do in ours.

There is every reason to believe that all gases might be condensed to liquids, if a sufficient degree of cold and pressure could be attained; and we ought not to be surprised at the difficulty experienced in liquefying the gases above enumerated, when we remember how very rapidly the maximum tension of vapors increases with the temperature, and how very limited our means of reducing the temperature are, as compared with our means of elevating it. We can easily attain a temperature of $5,000^{\circ}$ C., while we can scarcely reduce the temperature of bodies to -150° . At $1,000^{\circ}$ the maximum tension of the vapor of water would be, unquestionably, equal to many thousand atmospheres, and it would undoubtedly be found as difficult to condense to a liquid the vapor of water in the highly rarefied condition which it would have at that temperature under the mere pressure of the air, as it is now found to condense the so-called permanent gases.

(297.) *Greatest Density of Vapor.* — By referring to the table on page 571, it will be seen that the weight of one cubic metre

of the vapor of water — and hence, also, its density (68) — increases very rapidly with the temperature. This is also shown by the curve *abfg* of Fig. 412. The ordinates of this curve represent the weight of one cubic metre of vapor at the corresponding temperatures indicated by the abscissas, and the distance between any two horizontal lines of the figure corresponds to a difference of weight equal to 588.73 grammes. At 230°.9 the weight of one cubic metre of vapor is already $\frac{1}{82}$ of the weight of a cubic metre of water at 4°, and at the same rate of increase the weight of the vapor at no great elevation of temperature would be equal to that of its own volume of water. At such a temperature water would change into vapor without increasing its volume, provided that a vessel could be made sufficiently strong to bear the immense pressure which it would then exert. The same must also be true of the vapors of other liquids, so that at a temperature more or less elevated the density of the vapor will become equal to the original density of the liquid, which will then change into vapor without increasing its volume.

An approach to these phenomena has been observed by M. Cagniard de la Tour.* He sealed up in a strong glass tube a volume of water equal to about one fourth of the capacity of the tube, and exposed it to a gradually increasing temperature. At a fixed temperature the water entirely volatilized, and the tube appeared empty. This temperature, at which water thus evaporates into a space of about four times its own bulk, is near the melting-point of zinc (360°). So great was the solvent power of water on glass at this high temperature, that it soon destroyed the integrity of the tubes, and a small amount of carbonate of soda was added to the water to diminish this action. As the vapor cooled, a point was observed at which a sort of cloud filled the tube, and in a few moments after, the liquid reappeared almost instantaneously. M. de la Tour made similar experiments with alcohol, ether, and sulphide of carbon, with the following results: —

	Temperature of Disappear- ance.	Volume of Vapor as compared with Volume of Liquid.	Tension of Vapor in Atmospheres.
Alcohol (36° Baumé),	259°	3	119
Ether,	200	2	37
Sulphide of Carbon,	275	2	78

* Annales de Chimie et de Physique, 2^e Série, Tom. XXI, XXII.

The tension of the vapors, as given in the above table, is far less than we should have expected; for, if Mariotte's law held good in these cases, ether should have exerted a pressure equal to about 209 atmospheres, and alcohol of at least 242. Here, then, we have a very marked example of the principle previously enunciated (166), that as the point of liquefaction is approached, the compressibility of a gas deviates more and more widely from the law of Mariotte. The experiments of De la Tour also show, that under these enormous pressures, even before the whole of the liquid has evaporated, the tension of the vapor varies with the proportion which the liquid bears to the space in which it is confined.

(298.) *Smallest Density of Vapor.* — Having seen that the highest limit of the density of vapor is probably at least as great as the density of the liquid from which it is formed, we naturally next inquire, Is there any lowest limit? Do substances continue to evaporate at all temperatures, however low, or is there some limit of temperature at which they cease all at once to emit vapors? By again referring to the table of maximum tensions (page 571), it will be seen that even at 10° below the freezing-point water forms a vapor weighing 2.284 grammes to the cubic metre, and having a tension of 0.2078 c. m.; and even at 20° below the freezing-point it forms a vapor with a tension of 0.1383 c. m. It was formerly supposed that substances which were decidedly volatile at the ordinary temperature continued to emit vapor, however far the temperature might be depressed, although the quantity became less and less, until it was inappreciable to our senses. It was even thought by some, that fixed solids, such as the metals and the rocks, gave out a sensible amount of vapor, so that traces of these substances were always to be found floating in the atmosphere. Some researches of Faraday, however, appear to establish an opposite conclusion. He found that mercury gave out a perceptible vapor during the summer, but none during the winter; and also that some chemical agents which may be volatilized at temperatures above 150° did not undergo the slightest evaporation during four years at the ordinary temperature of the air. The best opinion, therefore, appears to be, that there is for every body a temperature at which it ceases all at once to give out vapor. With mercury, this temperature lies between 4° and 15° .

HEAT OF VAPORIZATION.

(299.) *Latent Heat of Vapor.* — The change of state from liquid to vapor is accompanied with a very great amount of expansion ; thus,

1 $\overline{\text{c.m.}}^3$ of Water	at 100°	forms about	1700 $\overline{\text{c.m.}}^3$ of steam	at 100°.
1 " " Alcohol	" 78.4	" "	485 " " vapor	" 78.4.
1 " " Ether	" 35.6	" "	357 " " " "	35.6.

And, indeed, the heaviest known vapor, that of iodide of arsenic (*Sp. Gr.* = 16.1 as compared with air, or 0.021 as compared with water), is thirty times lighter than the lightest known liquid, eupion (*Sp. Gr.* = 0.633). We should naturally expect that such great expansion would be attended with a large absorption of heat. A single experiment will enable us to illustrate this fact, and also roughly to estimate the amount absorbed in the case of water.

Take a glass flask, and having placed in it one kilogramme of ice-cold water, expose it to such a source of heat that equal amounts of heat shall enter it during equal times. Observe carefully the time which elapses before the water boils. We will assume that it is twenty minutes. Observe also the temperature of the water and of the steam which fills the upper part of the flask. It will be found to be 100°, and both will remain at this temperature until the whole of the water has boiled away. Continue the boiling for fifty-four minutes, and at the end of this time weigh the water remaining in the flask, when it will be found that exactly one half has been converted into steam and escaped. We assumed that it required twenty minutes to boil the water, that is, to raise the temperature of one kilogramme of water from 0° to 100°. During this time, then, one hundred units of heat must have entered the liquid. Hence it follows, that, during the succeeding fifty-four minutes, two hundred and seventy units of heat entered the water ; but this amount of heat has not raised the temperature in the slightest degree, for both the water and the steam have retained, during the whole interval, the constant temperature of 100°. What, then, has become of the heat ? The answer is, that it has been absorbed in converting 500 grammes of water at 100° into 500 grammes of steam at the same temperature. It follows, then, that one kilogramme

of water at 100° absorbs, in changing into steam of the same temperature, 540 units of heat. The latent heat of steam, as well as that of other vapors, can be ascertained with great accuracy by means of the apparatus represented in Fig. 428, contrived by Brix,* of Berlin. It consists of a small glass retort, *R*, connecting with a small metallic cylindrical condenser, *B*. This condenser has an opening into the atmosphere by the tube *L*, and is supported in the centre of a larger cylindrical box, *A*, which is filled with water. A thermometer passing through a tubulature in the cover enables the experimenter to observe the temperature of the water, while by agitating the water with the

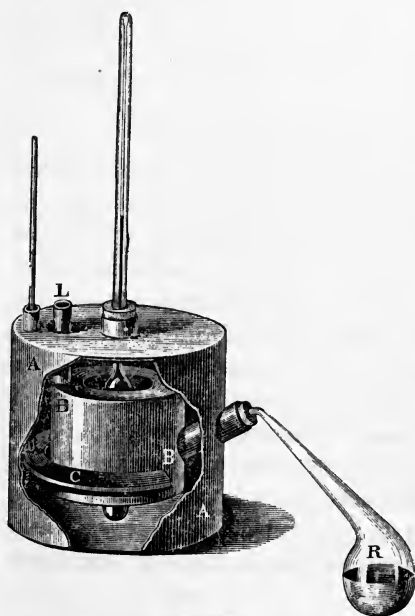

Fig. 428.

metallic disk *C*, its temperature can be rendered uniform throughout. In conducting the experiment, the water around the condenser is first cooled a few degrees below the temperature of the atmosphere; then the vapor is distilled over from the retort until the temperature of the water has risen an equal number of degrees above that of the atmosphere. In this way any loss of heat from the water is avoided, since the apparatus is for an equal length of time warmer and cooler than the air. The weight of vapor condensed is then ascertained by the loss of weight of the retort,

and the amount of heat evolved by its condensation is readily calculated from the weight of the water around the condenser, and the number of degrees through which it has been heated. This amount of heat corresponds to the latent heat of the vapor plus the amount of heat given out by the condensed steam in

* Poggendorff's Annalen, Band LV.

cooling from the boiling-point to the temperature of the condenser. To illustrate this by an example, we will suppose that we know

The weight of water around the condenser,	500 grammes.
The temperature at the beginning of the experiment,	12°.
The temperature at the end of the experiment,	18°.
The weight of the water distilled over,	4.82 grammes.

Hence it follows (231), that

The amount of heat which entered the water equals	3	units.
By (233) the amount of heat required to raise the temperature of 4.82 grammes of water from 18° to 100° is equal to	0.395	“
And hence the quantity of heat given out by 4.82 grammes of steam in liquefying equals	2.605	“
One kilogramme of steam would then set free, in liquefying, 540		“

It is evident that, in these experiments, as in the determination of the specific heat by the *method of mixtures*, it is necessary to take into account the amount of heat absorbed by the metals and glass of which the apparatus is made. This can easily be calculated, since the specific heat of these substances is known, and their weight can be easily determined. The formulæ for similar calculations have already been given [158] and [159], and they can readily be modified by the student for any special case.

By means of the apparatus described above, Brix obtained for the latent heat of the vapors of several well-known liquids the following values.* These values are, in each case, the number of units of heat required to convert one kilogramme of the liquid at its boiling-point into one kilogramme of vapor at the same temperature.

	Latent Heat of equal Weights.	Latent Heat of equal Volumes.	Sp. Gr. of Vapor at Boiling-Point. Air = 1.
Water,	540 units.	315.05	0.451
Alcohol,	214 “	348.26	1.258
Ether,	90 “	265.45	2.280
Oil of Turpentine,	74 “	307.00	3.207
Oil of Lemons,	80 “		

* Determinations of the latent heat of vapors have also been made by Andrews (Quarterly Journal of the Chemical Society, Vol. I. p. 27), by Despretz, and by Favre and Silbermann (Comptes Rendus, Tom. XXIII. p. 524).

Since the number which expresses the specific gravity of a substance is the same as the weight of one litre in kilogrammes, it follows, that, if we multiply the specific gravity of a vapor at the boiling-point (referred to water) by 1,000, we shall obtain the weight in kilogrammes of one cubic metre of this vapor at this temperature; and, furthermore, it follows from what has been said, that, if we multiply this weight by the latent heat of the vapor, we shall have the number of units of heat required to generate from these liquids at their boiling-points one cubic metre of vapor. Making these calculations, we should obtain the numbers given in the above table as the *latent heats of equal volumes*; and it will be noticed that, with the exception of that of ether, these numbers are approximatively equal. The same is also true of other liquids not included in the table; hence we may say, roughly, that the same volume of vapor will be produced from all liquids by the same expenditure of heat. No important advantage, therefore, could be gained by substituting any other liquid for water in the steam-engine.

(300.) *Latent Heat of Steam at Different Temperatures.* — The latent heat of steam has the value given in the above table only when its tension is 76 c.m. and its temperature 100°, which is the case when the steam is formed by boiling water under the normal pressure of the atmosphere. If the tension and temperature of the vapor have greater values than the above, then the latent heat is less than 540 units; and, on the other hand, if these values are less than 76 c. m. and 100°, then the latent heat of the vapor is more than 540 units. Watt concluded, from his experiments, that the same weight of vapor always contained the same quantity of heat, or, in other words, he supposed that the same quantity of heat would convert one kilogramme of water at 0° into one kilogramme of vapor, whatever the tension or temperature of the vapor might be. If this were the case, the sum of the latent and sensible heat of steam would be the same at all temperatures, and we should have for the latent heat the following values: —

Temperature.	Latent Heat of Vapor.	Sum.
0	640 units	640
50	590 “	“
100	540 “	“
200	440 “	“

Among the other numerical data connected with the steam-engine, Regnault has carefully determined the latent heat of steam at different temperatures between 5° and 196° . These experiments were made with an apparatus constructed with every possible refinement, and were conducted with the usual skill of this eminent experimentalist ; but for a description both of the apparatus and of the methods, we must refer the student to the original memoir.* It was proved by this investigation, that the law of Watt, as the principle above stated is frequently called, is far from being an exact expression of the facts, and, like so many other phenomenal laws of nature, can only be regarded as approximatively true (compare page 300). The sum of the latent and sensible heat of steam actually increases, although only very slowly, with the temperature ; and Regnault found that the results of his experiments were very nearly satisfied by the empirical formula

$$\lambda = 606.5 + 0.305 t, \quad [202.]$$

in which λ represents the sum of the latent and sensible heat, while 606.5 is the latent heat of the vapor at 0° , and t the given temperature. By means of this formula, we can very easily calculate the latent heat of the vapor at any temperature. Thus, at 100° we have $\lambda = 637$, and consequently the latent heat is 637 units less the number of units required to raise the temperature of one kilogramme of water from 0° to 100° . By the table on page 472, we find that this amount is equal to $1.005 \times 100 = 100.5$, and, subtracting this quantity from 637, we find the latent heat of steam at 100° to be 536.5 units. In like manner, the other values in the following table have been calculated.

The second column of the table gives the tension of the *vapor* of water in centimetres. The fourth column gives the number of units of heat required to change one kilogramme of water at 0° into one kilogramme of *vapor* at t° . The third column gives the number of units of heat required to change one kilogramme of water at t° into one kilogramme of *vapor* at the same temperature.

* Mémoires de l'Académie des Sciences, Tom. XXI.

Temperature.	Tension.	Latent Heat.	Sum of Latent and Sensible Heat.	Temperature.	Tension.	Latent Heat.	Sum of Latent and Sensible Heat.
0	0.460	606.5	606.5	120	149.128	522.3	643.1
10	0.916	599.5	609.5	130	203.028	515.1	646.1
20	1.739	592.6	612.6	140	271.763	508.0	649.2
30	3.155	585.7	615.7	150	358.123	500.7	652.2
40	5.491	578.7	618.7	160	465.162	493.6	655.3
50	9.198	571.6	621.7	170	596.166	486.2	658.3
60	14.879	564.7	624.8	180	754.639	479.0	661.4
70	23.309	557.6	627.8	190	944.270	471.6	664.4
80	35.464	550.6	630.9	200	1168.896	464.3	667.5
90	52.545	543.5	633.9	210	1432.480	456.8	670.5
100	76.000	536.5	637.0	220	1739.036	449.4	673.6
110	107.537	529.4	640.0	230	2092.640	441.9	676.6

(301.) *Illustrations.* — The fact that heat is absorbed during evaporation is illustrated by many familiar phenomena. The chill which is felt on leaving a bath is caused by the rapid evaporation of water from the surface of the skin, whereby heat is withdrawn from the body. In a similar way, the air of a heated room is cooled by sprinkling water on the floor. This principle also explains how man is enabled to bear the scorching heat of the hottest climates, and even, if properly protected, to enter an oven heated above 100°, his blood not exceeding 40°; a copious perspiration is excited, which removes heat from the body as rapidly as it is received from without. The porous water-jars, which are used in Spain and in Eastern countries to keep liquids cool, also owe their efficacy to the latent heat of vapors. They are made of biscuit earthen-ware, and the water which slowly percolates through the walls and evaporates from the surface withdraws so much heat from the vessel as to retain the temperature of the water considerably below the temperature of the surrounding air. The effect is enhanced by placing the jar in a current of air, which accelerates evaporation. In like manner, the evaporation from the surface of the body is increased in a current of air, and hence the sensation of coolness which a draught produces; while, on the other hand, the oppression which we feel in an atmosphere saturated with moisture arises from the fact that the evaporation is in great measure arrested.

The same principles may also be illustrated by a great variety

of experiments. One of the most striking of these is that of Leslie, in which water is frozen by its own evaporation. A small and shallow pan of water is supported over a dish of sulphuric acid, and under a bell-glass standing on the plate of an air-pump (Fig. 429). On exhausting the air

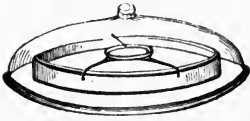

Fig. 429.

from the bell, the heat absorbed by the very rapid evaporation of the water which ensues is so great, that the larger portion of the liquid is converted into ice. The sulphuric acid absorbs the vapor as fast as it forms, and thus accelerates the evaporation.

A similar experiment can be made with the instrument represented in Fig. 430, called the *cryophorus* (frost-bearer). It consists of two glass bulbs, connected together by a long tube, one of which is partially filled with water. In making the instrument, it is hermetically sealed while filled with steam, so that on cooling a vacuum is left above the water, except in so far as the space is



Fig. 430.

filled with vapor. If now the empty bulb is surrounded by a freezing-mixture, this vapor is condensed as fast as it is formed, and a very rapid evaporation ensues from the surface of the water in the first bulb, which soon reduces the temperature of the liquid to the freezing-point. Even more marked effects than these can be obtained by the evaporation of very volatile liquids, like ether or sulphide of carbon. The rapid evaporation of ether poured upon the hand occasions a very distinct sensation of cold, and water can be frozen by the evaporation of ether from the surface of a glass bulb covered with muslin and kept moistened with the liquid. If the evaporation is accelerated by placing the apparatus under the receiver of an air-pump, even mercury can be frozen in this way. Indeed, an apparatus has been invented for making ice in warm countries, by the evaporation of ether in a partial vacuum.

The principles of latent heat can in no way, however, be more strikingly illustrated than with liquid carbonic acid. When this highly volatile liquid is allowed to escape into the air, it evap-

orates with such rapidity, as has been stated, that the larger portion of it almost instantaneously freezes. This frozen carbonic acid can easily be obtained in large quantities by means of the apparatus of Thilorier. From the valve of the receiver *B*, Fig. 425, a tube descends to near the bottom of the vessel, so that, on opening the valve, the liquid is forced out by the tension of the gas in the interior. A cylindrical brass box, *O*, connected with the valve of the receiver by the coupler *L* (which fits in the socket *M*), and so constructed as to break the force of the jet, receives the liquid as it issues from the receiver, and soon becomes filled with solid carbonic acid, which resembles, in its general appearance, freshly fallen snow. This experiment, it will be noticed, is analogous in principle to that of Leslie, in which water was frozen by its own evaporation.

A further illustration of the principles of latent heat is afforded by the fact, that the solid carbonic acid — if in considerable quantity and surrounded by poor conductors — may be kept exposed to the air for hours before it entirely disappears. Although exceedingly volatile, it evaporates only slowly, for the same reason that a bank of snow melts gradually during a warm spring day. The non-conducting nature of the vessel, and of the atmosphere of gas which surrounds it, prevents the absorption of the heat which is necessary for the change of state. If, however, it is brought into close contact with a good conductor, like metallic mercury, the rapidity of its evaporation is greatly accelerated, and the temperature of the substance reduced to that of the solid gas, which has been estimated as low as -90° C. In this way large masses of mercury can easily be frozen. A greater degree of cold can be obtained by mixing the solid gas with a little ether, which forms with it a semi-fluid mass capable of being brought in closer contact with substances, and thus removing their heat more rapidly. A still greater degree of cold was produced by Faraday, by placing this mixture under the receiver of an air-pump from which the air and gaseous carbonic acid were rapidly removed. An alcohol-thermometer placed in this mixture sinks to the temperature of -110° ; at this low temperature the mixture of solid carbonic acid and ether is not more volatile than alcohol at the ordinary temperature.

Similar experiments can be made with the liquid protoxide of nitrogen, which is obtained in Bianchi's apparatus. As this does not freeze so readily as liquid carbonic acid, it can be drawn

out from the condenser in a liquid state, and retains its condition when exposed to the air longer than solid carbonic acid. It can readily be frozen by its own evaporation, and it furnishes the means of producing the lowest temperature yet attained. When mixed with solid carbonic acid and ether, it produces a cold so intense, that absolute alcohol exposed to it assumes the consistency of a thick oil, and a thermometer immersed in a bath formed by mixing this liquid with sulphide of carbon was observed by Natterer to fall to -140° when the bath was placed *in vacuo*.

(302.) *Applications of the Latent Heat of Steam.* — The great amount of heat which steam contains renders it exceedingly valuable in the arts as a heating agent. Water may be heated, and even boiled, in wooden tanks, by *blowing* steam into it, or by causing the steam to circulate through a coil of copper pipe at the bottom of the tank. Buildings, also, are very frequently warmed by the heat of steam. The steam generated in a boiler placed in the basement is conveyed by iron pipes to the different apartments. There it is condensed to water in a coil of iron pipes, or in a condenser of some other form, and the heat thus set free is radiated from the iron surface of the condenser. Steam is likewise used as a source of heat in the process of distillation, especially when the substance to be heated is liable to alteration from too high a temperature. For this purpose, the walls of the still are frequently made double, and the steam admitted between the two. It is sometimes found advantageous to blow the steam through the mass of liquid in the still, in which case the volatile product passes over in vapor mixed with the steam, and the two are condensed together in the worm or receiver. This method is constantly used in the distillation of volatile oils from organic materials. Sometimes the steam is highly heated by passing it through red-hot tubes before it is introduced into the still. In this way the fat acids and many other substances can be distilled, which could not be distilled in the ordinary way. This method is in fact the basis of an important process used in the arts for decomposing tallow and other fats, and extracting from them the fat acids and glycerine, substances which are used in the manufacture of candles and of soap.

(303.) *Spheroidal Condition of Liquids.* — It has already been stated, that when a liquid is dropped upon a heated surface, the temperature being made to vary with the nature of the liquid, it

assumes the spheroidal condition, and rolls round on the surface like globules of mercury on a porcelain plate (Fig. 431). It was also stated, that the temperature of the liquid in this condition is constant, and always below its boiling-point. This fact can be proved by testing the temperature with a thermometer, as



Fig. 431.

shown in Fig. 432. The following table shows in each case, first, the temperature at which the liquid assumes the spheroidal condition in a heated silver capsule; and, secondly, the temperature of the liquid while in this condition:—

	I.	II.	Boiling-Point.
Water,	171°	96.5	100°
Alcohol,	134	75.8	78
Ether,	61	34.2	35
Sulphurous Acid,	—10.5	—10.5	—10



Fig. 432.

When in the spheroidal condition, the globules of liquid have a gyratory motion on the bottom of the capsule, and not only does the liquid not boil, but it evaporates vastly more slowly than when it is in actual ebullition. If the source of heat is removed, the temperature of the capsule will fall until a point is



Fig. 433.

reached at which the liquid wets the metallic surface, and then the liquid will boil violently, and be thrown in all directions with almost explosive violence (Fig. 433). This singular phenomenon can also be shown by pouring a small quantity of water into a thick copper flask intensely heated, and corking the flask while the liquid is in the spheroidal condition. For a time, all remains quiet; but when the flask has cooled sufficiently, the water will be suddenly converted into steam, and the cork thrown out with great violence (Fig. 434).

It has also been proved that a liquid, when



Fig. 434.

in a spheroidal condition, is not in contact with a heated surface. Boutigny was able to see the flame of a candle between a globule of water rendered opaque by lampblack and the heated surface on which it rested (Fig. 435); and, moreover, Wartmann and Poggendorff found that a current of electricity would not pass between the liquid spheroid and the metallic disk.

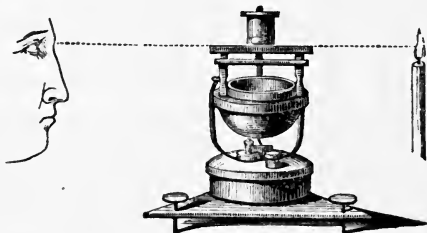

Fig. 435.

The explanation of these singular phenomena has already been in part given. We have seen that, whenever by the action of heat the adhesion of a liquid to the surface on which it rests becomes less than twice as great as the cohesion between the liquid particles themselves, the liquid will no longer moisten the surface, and we can readily conceive that it may be even repelled by it, and with a force sufficiently great to overcome the weight of the liquid mass. That such a repulsion really exists Boutigny proved by two curious experiments. He poured water into a basket made of platinum wire-netting and heated to redness, and found that the liquid did not drop through the interstices. He also whirled round, in a sling, a heated capsule containing a liquid globule in the spheroidal state, and found that the centrifugal force was not able to compel contact. Assuming, then, that the liquid globule is sustained at a small distance above the heated surface by the repulsive force of heat, it is easy to explain the rest. The vapor forming on the lower surface of the spheroid would raise it still further from the heated metal, and, escaping unequally around the contour of the spheroid, would tend to give to it its singular motions. Then, again, since the liquid is not in contact with the source of heat, it can only be heated by radiation. Now a part of the rays of heat will be reflected from the surface of the liquid; and, moreover, the greater part of those which penetrate it will pass through it without being absorbed. It is evident, then, that the spheroid will retain but a small portion of the heat radiated from the walls of the metallic capsule; and since it is all the time losing heat by evaporation,

it is not wonderful that its temperature should be reduced several degrees below the boiling-point.

By following out the principles of this section to their extreme consequences, we are able to produce some very paradoxical effects. It has before been stated, that water may be frozen by pouring it into liquid sulphurous acid while the latter is in the spheroidal condition, although the capsule containing it may be red-hot. So also, by substituting for liquid sulphurous acid the mixture of solid carbonic acid and ether, even mercury, placed within the red-hot capsule in a small platinum crucible, may be frozen with equal certainty. The wonder disappears from these phenomena when we know that these highly volatile liquids are not in contact with the heated surface of the capsule, for they simply produce the same effects in their spheroidal condition that they would under other circumstances. A still more paradoxical result can be obtained with liquid protoxide of nitrogen. For this experiment, the liquid should be drawn into a tube suspended in a bottle containing a few lumps of chloride of calcium, by means of a cork adjusted to the neck. Without this precaution, the moisture of the air would condense as hoar-frost on the tube, and render the wall opaque. If we pour some mercury into this tube, it will sink to the bottom and immediately freeze. On the other hand, if a piece of burning charcoal is dropped in, it will float on the liquefied gas, which will assume the spheroidal condition around it; but, moreover, what is very remarkable, the charcoal will burn with the usual intense brilliancy in the protoxide of nitrogen gas which surrounds it, and we shall thus have in the same test-tube burning charcoal and frozen mercury. But perhaps the most marvellous result is the impunity with which the moistened hand may be dipped into melted lead, or even into molten cast-iron as it flows from the furnace. In these cases the adhering moisture is converted into vapor, which forms an envelope to the skin sufficiently non-conducting to prevent the transmission of any injurious quantity of heat during the short period of the immersion.

STEAM-ENGINE.

(304.) It would lead us beyond the design of the present work to enter upon any detailed description of this wonderful application of the laws of vapors. We shall only be able to point out the general principles of the machine, and to illustrate by figures some of its most important forms. It has already been shown, that when water is confined in a vacuous space, this space becomes filled with vapor, whose tension depends on the temperature, and rapidly increases as the temperature rises. It is the object of the steam-engine to convert this tension into mechanical effect. Every steam-engine must, then, consist of two parts: first, the *boiler*, in which the steam is generated; secondly, the *machine* proper, by which the tension of the steam is made to do mechanical work. We shall do well to examine the various forms which are given to these parts separately.

(305.) *The Boiler.*—The form of the steam-boiler varies very greatly with the purposes to which it is to be applied, and on its proper construction the safe and economical working of the machine in great measure depends. The boiler is the origin of the power; it is where the heat evolved by the burning combustible is combined with water, to reappear in the expansive force of steam. The machine proper merely transmits this force, and, like any other machine, it can neither increase nor diminish it, except so far as the force is expended in overcoming friction or other resistances in the machine itself.

The two chief requisites for a steam-boiler are evidently, first, the strength required to resist the expansive force of the steam without an unnecessary expense of materials; and, secondly, the capability of furnishing the amount of steam required by the engine in any given time, with the smallest possible expenditure of fuel. The boilers are usually made of plates, either of wrought-iron or of copper, riveted together, and, when necessary, are strengthened by cross iron stays in the interior. Copper is the best material, but iron is almost invariably preferred on account of its cheapness. The thickness of the plates is made such that the boiler will resist a very much greater tension than any to which it can ever be expected to be exposed.

It is generally assumed, that, in order to supply a steam-engine,

35 litres of water must be evaporated in the boiler each hour for every horse-power. Now, we know that at least $650 \times 35 = 22,750$ units of heat are required in order to convert 35 kilogrammes of water into steam; and this amount must therefore be transmitted during an hour through the boiler-plates for every horse-power of the engine. But since, even through the best conductors, heat is transmitted with extreme slowness, so large a quantity can only be made to pass by exposing a large surface to the action of the flame. Hence the extent of the *heating surface*, and not the amount of water contained in a boiler, is the measure of its capacity to generate steam. It is the general rule to allow about 1.7 square metres of heating surface, and about 70 square centimetres of grate-bars to every horse-power. Moreover, in order to obtain the full effect of the combustible, it is essential that the heated products of combustion should be kept in contact with the surface of the boiler until the temperature of the smoke is reduced as nearly as possible to that of the water in the boiler. This is accomplished by making the smoke circulate through tortuous flues in contact with the surface of the boiler. The quantity of heat produced by the burning combustible is far, however, from being entirely economized. It has been found, by experiment, that the whole amount of heat evolved by burning one kilogramme of bituminous coal is equal to about 7,500 units, which would change into steam $\frac{7500}{650} = 11.5$ kilogrammes of water, if it all passed through the boiler-plates into the water; but so much heat is lost by incomplete combustion, by radiation, by conduction through the mass of the furnace, and, finally, by the smoke, which must be discharged into the chimney, still heated to between 200° and 400° in order to sustain the draught, that practically one kilogramme of coal will not evaporate more than from five to seven kilogrammes of water with the best constructed furnaces.

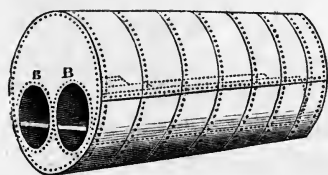

Fig. 436.

The conditions of efficient action just considered are best combined in what is termed the Cornish boiler, which is represented in Fig. 436. It is cylindrical in form, frequently over forty feet in length, and from five to seven feet in diameter, with two flues,

which extend the whole length of the boiler; they are perfectly cylindrical, and of sufficient magnitude to admit a furnace in each. After the heated gases have traversed these iron flues, they are returned around the surface of the boiler by external flues made in the brick-work which supports it. The circuit which the hot gases perform in contact with the boiler surface is, not unfrequently, 150 feet long, and the heating surface exposed to their action over 3,000 square feet. Another form of boiler much used for stationary engines in France is represented in Figs. 437 and 438. This boiler is also cylindrical, but in the

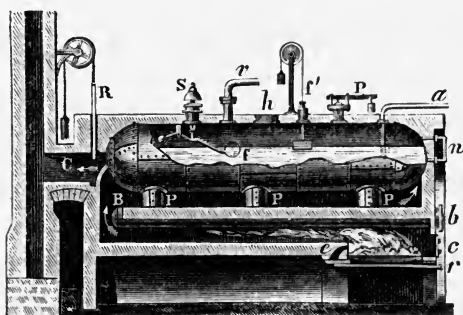

Fig. 437.

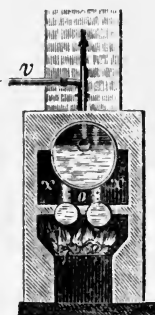

Fig. 438.

place of the internal flues used in the Cornish boiler, the heating surface is increased by means of two *tubes bouilleurs*, *B*, Fig. 437, which are connected with the main cylinder by the vertical tubes *P, P, P*. The flame of the furnace plays directly against the *tubes bouilleurs*; the heated gases are then returned under the main cylinder in the flue *O*, Fig. 438, and are finally discharged into the chimney through the side flues *x, x*, while a damper at *R* serves to regulate the draught.

With a stationary boiler, economy of fuel is, as a general rule, the great desideratum; and in most cases that form can be given to it by which this end is best attained. It is different with the boiler of a steamship or of a locomotive engine. With the first, economy of fuel is also the primary consideration, because, otherwise, long voyages would be impossible; but economy of space must also be considered, and it is therefore essential that the size of the boiler should be restricted to quite narrow limits. With the locomotive, on the other hand, speed is, as a general rule, the great object, and this must be attained at any cost of fuel. But

speed implies a very rapid consumption of steam, since for every revolution of the driving-wheel of a locomotive its two cylinders must be filled and vented twice; hence the chief requisite of a locomotive boiler is, that it should generate the greatest possible amount of steam in a given time. In all cases, the machinist endeavors to combine the requisite conditions as well as the circumstances admit, and the efficiency of his engine depends in great measure on his success. Unfortunately, he is guided almost entirely by empirical rules; and there are few branches of practical art in which so much remains to be determined and improved, and scarcely any which theoretical science has done so little to advance.

The usual form given to the boiler of a locomotive is represented in Fig. 439. The furnace *A*, called the *fire-box*, is within

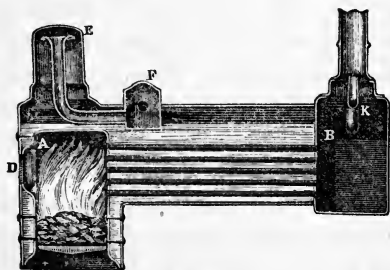

Fig. 439.

the boiler, and surrounded by water except at the door *D* and at the ash-pit. The flame is conducted from this fire-box to the *smoke-box B* through a large number of brass tubes, which are all surrounded by the water of the boiler. There it meets with a jet of steam coming from the cylinders, which

creates a strong draught and drives the waste gases up the chimney. The boiler of a locomotive is surmounted by the steam-dome, *E*; and a tube with a funnel-shaped orifice, opening near the top of this dome, receives the steam and conveys it to the cylinders through *F*. This arrangement prevents, to a great degree, the spray, which rises from the water of the boiler and is mixed with the steam in the upper part of it, from reaching the cylinders; as the steam ascends the steam-dome, this spray falls back, and nothing but pure steam enters the tube.

The steam-boiler is always provided with several appendages for the purpose of regulating the quantity of water, for measuring the tension of the steam, and for preventing the accumulation of a pressure which would endanger the safety of the boiler.

It is essential for the good working of the boiler, that the water should always cover the whole *heating surface*; hence it must be maintained above the level of the flues. The water is supplied to the boiler through the pipe *a* (Fig. 437), which reaches nearly to the bottom. This pipe communicates either with an elevated reservoir, or with a force-pump moved by the engine, the size of the pump being so adjusted that the amount of water forced into the boiler during a given time shall be, as nearly as possible, equal to that which escapes in the condition of steam through the steam-pipe *v* during the same interval. This adjustment, however, is necessarily imperfect; and hence a great variety of inventions, by which the supply of water is regulated automatically, and made to depend on the position of the water-level in the boiler. Various contrivances are in use for indicating to the engineer the height of the water. One of the simplest of these is the glass gauge represented at *n* (Fig. 437). It consists of a thick glass tube firmly cemented into iron caps, by means of which it communicates with the interior of the boiler. It is so placed, that, when the water is at the proper level, the lower end shall open below the surface of the water, and the upper end above it; consequently, the water will always stand at the same level in the tube as in the boiler. Another kind of indicator is represented at *f'*. It consists of a float, which is connected with a counterpoise by a metallic wire passing over a pulley, and through a *packing-box* in the top of the boiler. The position of the level of the water is indicated either by the position of the counterpoise, or by a needle attached to the axis of the pulley, and moving over a graduated disk. Some boilers are also provided with an alarm-whistle, *S*, so arranged that it is opened by the float *f* when the level of the water falls too low.

The tension of the steam in the interior of the boiler is indicated by a manometer, which may be either of those already described (Figs. 104, 273, or 279).

In order to limit the tension of the steam, every boiler is furnished with one or more safety-valves, represented at *P* (Fig. 437), and also in detail in Fig. 440. The valve is kept closed by the weight *P*, acting on the lever *O*, and this weight is so adjusted to the area of the valve, that the valve will open as soon as the tension of the steam exceeds a limited amount. The area of the valve is adjusted to the extent of the heating surface of the

boiler, and to the maximum tension at which the boiler can be worked with safety. It is determined by means of the empirical formula,

$$d = 23 \sqrt{\frac{S}{H - 0.412}},$$

in which d is the diameter of the valve, S the area of the heating surface of the boiler, and H the maximum tension of the steam. It has been found that a valve with the dimensions given by this

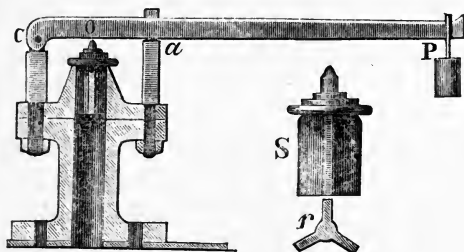

Fig. 440.

formula will allow all the steam to escape which can be generated by the most active fire; but, for greater security, a boiler is generally provided with two valves of these dimensions.

We can also limit the tension of the steam by fixing a limit to its temperature. This can be done by closing a tubulature adapted to the upper part of the boiler with a plate made of fusible alloy, whose proportions have been so adjusted (272) that it shall melt when the steam attains the temperature which corresponds to the maximum tension which the boiler is calculated to sustain. This plate, which is quite brittle, is held in its place by an iron collar, and protected by an iron grating, which enables it to resist the pressure of the steam. The use of these plates, however, is liable to serious objections. They not only render the boiler unserviceable for the time, if they yield, but, moreover, the melting-point of the plate is liable to a change from the eliquation of the more fusible metal.

(303.) *Dimensions of Steam-Boilers.* — As in the last section the dimensions of the steam-boiler were given in French measure, it may be well to add the following English data, taken from the *Encyclopædia Britannica*, Article *Steam-Engine*, premising that by a *horse-power* is meant a force of that intensity which will raise 33,000 pounds one foot per minute, or nearly 2,000,000 pounds one foot per hour.

Conditions for each Horse-Power.

	Ordinary Standard.	Cornish Boiler.
Quantity of water to be evaporated per hour in cubic feet,	1	1
Volume of water in boiler in cubic feet,	10	or more.
Volume of steam in steam-chamber in cubic feet,	10	or more.
Area of fire-grate in square feet,	1	2
Area of heating surface in square feet,	15	60 to 70
Circuit of flues in linear feet,	60	150

Results.

Bituminous coal per hour for each horse-power,	10lbs.	5 $\frac{1}{4}$ lbs.
Water evaporated by each pound of coal,	6 "	11 $\frac{1}{2}$ "
Bituminous coal consumed per hour for each square foot of grate,	10 "	2 $\frac{3}{8}$ "

(307.) *Watt's Condensing-Engine.* — The steam-engine, in its present form, was invented, between the years 1763 and 1769, by James Watt, originally a maker of philosophical instruments in Glasgow. This invention stands without a parallel in the history of the mechanic arts. Perfect almost from its first conception even in its minutest details, it has since received no improvement involving a single principle unknown to Watt. It is true that we have machines at the present day which, not only in magnitude, but also in the perfection of the mechanical details, and in the beauty and simplicity of the combination of the several parts, far exceed any Watt ever saw; but all these improvements have been only the necessary development of his first conception.

Most of the parts of the condensing-engine are shown in Fig. 441, which, although necessarily imperfect in its details, will serve to illustrate the relation of the parts. The most essential part of the machine is the large cast-iron cylinder (shown on the left-hand side of the cut), within which moves the piston *P*. The interior of this cylinder is *turned* on a lathe, so as to be perfectly true, and the sides of the piston are made elastic by what is termed the *packing*, which prevents any leakage of the steam around the edge. The surfaces of this piston receive directly the pressure of the steam; and it is therefore to be regarded as the point of application of the expansive force, and the origin of the motion of the engine. The steam generated in the boiler just described, and conveyed to the machine through the steam-pipe, is first received into the valve-chest *b* through the

aperture *o*, and from this it is admitted alternately into the top and bottom of the cylinder by a sliding-valve, which is moved by the rod *b m*, passing through a packing-box on top of the valve-chest.

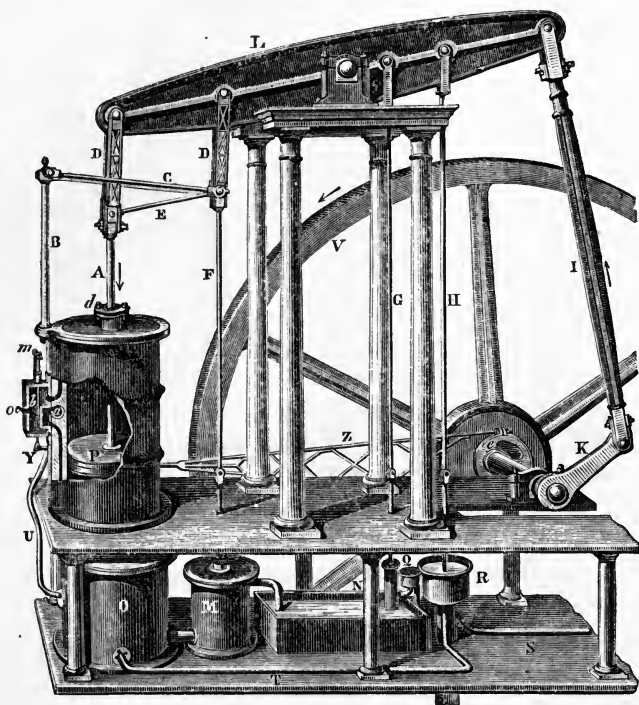

Fig. 441.

The same valve also opens and closes the vent-hole *a*, by which the steam, after having done its work in moving the piston, is discharged alternately from either end of the cylinder through the *eduction-pipe U*. When the valve is in the position represented in Fig. 441, the steam has free access to the upper part of the cylinder, and presses on the top of the piston, while from the space below the piston a vent is opened through the tube *a U*. Consequently the piston falls; but when it reaches the bottom of the cylinder, the position of the valve is suddenly changed to that represented in Fig. 442, and a connection is opened between the upper part of the cylinder and the eduction-pipe, while at the same time the steam is admitted below the piston, whose motion is thus reversed. When the piston reaches the top of the cylin-

der, the position of the valve is again changed; and thus continuously, so that a reciprocating motion is the result. This motion is communicated by the piston-rod *A*, which passes steam-tight

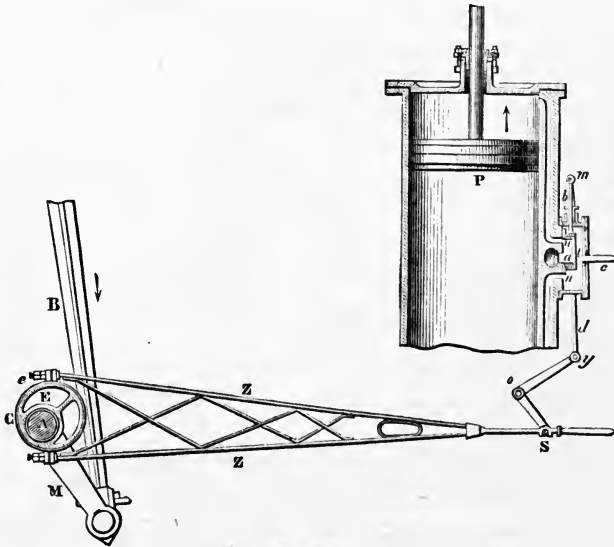

Fig. 442.

through the packing-box *d*, on the head of the cylinder, to one arm of the large lever *L*, called the *beam*, and by the beam it is further transmitted through the *connecting-rod I* to the *crank K*, which turns the *shaft* of the engine, and gives motion to the machinery connected with it.

Fly-Wheel.—When the piston is at the top of the cylinder, the crank is in its lowest position; and, on the other hand, when the piston is at the bottom of the cylinder, the crank is in its highest position. In either of these positions, called the *dead points*, it is obvious that the pressure of the steam can communicate no motion to the crank, and the machine would come to rest were it not for the large iron wheel *V*, called the *fly-wheel*, which is attached to the shaft and revolves with it. This wheel, which has a large mass of matter in its rim, having once received a certain velocity of rotation on its axis, carries by its inertia the crank and piston through the dead points, and brings them into a position in which the power becomes effective.

The fly-wheel, moreover, equalizes the motion of the machine, and gives a uniformity to its action it could not otherwise have, owing to the unequal leverage at which the connecting-rod acts on the crank in its different positions. Then, again, the uniform rotation of the wheel acts back upon the piston through the crank with the happiest effect, bringing the piston slowly to rest at the end of each stroke, and thus preventing the jar which would result from a sudden change in the direction of the motion. Indeed, this whole combination is one of the happiest results of mechanics, and will repay the most careful study. A fly-wheel is only essential in a stationary engine. In the engine of a steamboat or a locomotive, the same effect is produced by the momentum of the moving mass.

Parallel Motion.—The system of jointed rods CDE (Fig. 441), by which the piston-rod is connected with the beam, called the *parallel motion*, is an ingenious invention of Watt to prevent any lateral strain on the former. Since the end of the piston-rod must move in a vertical line, while the end of the beam describes the arc of a circle coinciding with this line only at one point, it is easy to see that they could not be directly jointed together; and it can also be readily shown, by the principle of the composition of forces, that, if they were connected by the rod D alone, a lateral strain would be exerted on the piston-rod which would soon derange the machinery. By means of the system of rods represented in the figure, the end of the piston-rod is suffered to move in a vertical direction, and the lateral force resulting from the decomposition of the motion, in its transmission to the beam, is balanced by the resistance of the rods C and E , called *radius bars*, which are connected by joints to the frame of the engine.

The *parallel motion* of Watt does not completely answer its object, that is, it does not cause the end of the piston-rod to move in an absolutely straight line; and when the stroke of the piston bears a large proportion to the length of the beam, the deviation from a straight line becomes of practical importance. Hence, a large number of other *parallel motions* which have been invented to remedy this defect. One of the simplest contrivances for the purpose, and the one generally used in this country, consists in directing the motion of the piston-rod by a cross-piece sliding in vertical grooves, which are kept in their place by a stiff frame-work.

The Eccentric.— It has already been shown that the connections between the ends of the cylinder and the boiler or vent-tube may be alternately opened and closed by a sliding motion given to the valve ; it now remains to show how this motion is obtained automatically. A wheel (*E*, Fig. 442), called the *eccentric*, is so attached to the main shaft of the engine that its centre does not coincide with the axis of rotation. This eccentric revolves within a metallic ring, *C*, and imparts to it a backward and forward motion, which is transmitted by the arm *Z Z* to a bent lever, *Soy*, and by that to the rods *d* and *b*, which act directly on the valve. The extent of the motion of the valve is easily regulated by the length of the arms of the lever, and the moment at which it begins to move in either direction is determined by the position of the eccentric on the shaft. In starting the engine, or in reversing its motion, the valves are moved by hand, and there is always a handle connected with the lever *Soy* for the purpose. It is not until after the fly-wheel has acquired a certain momentum, that the arm *Z Z* of the *eccentric* is geared on to the lever at *S*. In order to stop the engine, the arm is ungeared and the motion of the valves regulated, as before, by hand. There is no part of the steam-engine on which more ingenuity has been shown than on the valves, and the automatic machinery for opening and closing them. The form of the valve represented in the above figures is the simplest, and is very generally used in small engines ; but in large engines there are frequently four separate valves, which are opened and closed independently.

The Condenser.— If the eduction-pipe *U* (Fig. 441) opened directly into the atmosphere, the engine would work perfectly well with only the parts which have been now described ; only there would be a loss of power : for a portion of the expansive force of steam would be expended in overcoming the pressure of the air. Watt avoided a part of this loss by an application of the well-known law (287), that the tension of any vapor in vessels communicating with each other is always that which corresponds to the temperature of the coldest vessel. He connected the eduction-tube of his engine with a larged closed iron box (*O*, Fig. 441), called the *condenser*, so that whenever by the motion of the valve the orifice of the eduction-tube is opened, the waste steam rushes at once into the cold vessel, leaving a partial

vacuum in the cylinder, against which the fresh steam acts with nearly its full force.

The gain, however, thus obtained is not so great as it would at first sight seem, since a portion of the power thus realized is expended in working the pumps connected with the condenser. In order to produce a sudden condensation of the steam, it is necessary to discharge into the condenser a constant stream of water. This water, forced in by the atmospheric pressure through the pipe *T* (Fig. 441), which ends in what is termed a *rose*, is showered in fine jets through the chamber. The amount of water which it is thus necessary to introduce is at least twenty times as great as the weight of steam condensed, and would soon fill the condenser. Hence the necessity of the pump *M*, worked from the beam of the engine, by which both the hot water and any air that may be mixed with it are rapidly removed, and the water discharged into the *hot well N*. The piston of this pump, called the *air-pump*, has generally about one half of the area and one half of the stroke of the large piston, and the general arrangement of its valves may be seen in Fig. 443. The condenser is usually entirely immersed in a tank of water, called the *cold well*, which is fed, when possible, by an aqueduct, or otherwise by a suction-pump, as *R*, Fig. 441, worked by a rod attached to the beam of the engine, and drawing its water from some neighboring well. Still a third pump is frequently attached to the beam, which draws water from the hot well and forces it into the boiler. The supply of water to the condenser is regulated by a valve so placed as to be at the command of the engineer, and before stopping the machine it is necessary to close this valve.

The machine which has just been described may be regarded as a representative steam-engine. The student must not expect to find the parts of an actual working engine as simple, or combined in the same way, as those represented in Fig. 441; but having once become familiar with the parts, as they are shown in this figure, he will be able readily to recognize them in a working engine, and to trace out the connection of their motions.

(308.) *Single-acting Steam-Engine*.—When the steam-engine is used for pumping water, which was at first its only practical application, its force is required only in raising the pump-rods with their load of water, their own weight being more than

sufficient for their descent. If the piston and pump rods are attached to opposite ends of a working-beam, the force of the steam is only required in pressing the piston down; and there is,

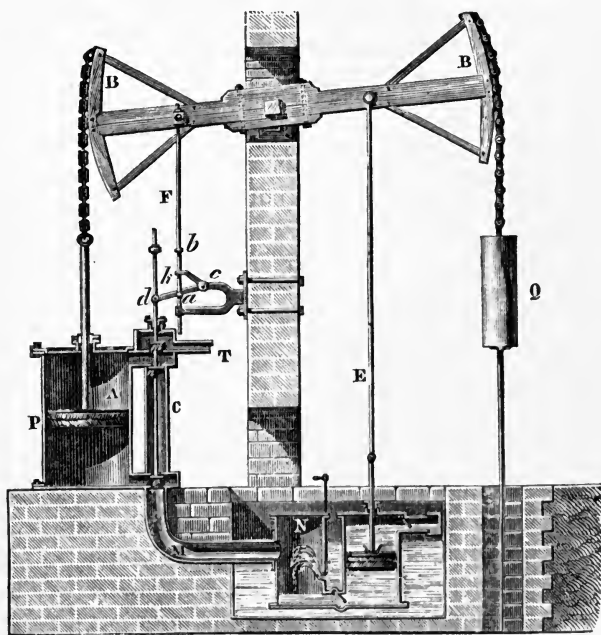

Fig. 443.

therefore, no necessity of admitting the steam to the bottom of the cylinder. Engines constructed for this purpose, in which the steam acts only on one side of the piston, are called *single-acting* engines, to distinguish them from the *double-acting* engines described in the last section. They are generally used for pumping water from mines, and are frequently called *Cornish engines*, because they were brought to perfection in the mining district of Cornwall, in England. A representation of one of these engines is given in Fig. 443.

The steam from the boiler enters the valve-chest by the tube *T*. A rod, *d*, passing through a packing-box in the top of the valve-chest, moves three valves, *m*, *n*, *o*. The valves *m* and *o* open upward, while the valve *n* opens downward. When the valves are in the position represented in the figure, *m* and *o* open and *n* closed, the steam from the boiler exerts its full effect on the upper surface of the piston, and presses it down; but just

before the piston reaches the lowest point of its course, a projection, *b*, on the rod *F*, moved by the beam, strikes the arm of a bent lever, *d c k*, which, acting on the valve rod at *d*, causes it to descend, thus closing the valves *m, o*, and opening the valve *n*, called the *equilibrium valve*. All connection between the cylinder and either the boiler or condenser is now closed; but the two ends of the cylinder freely communicating together, the piston is raised by the weight of the pump-rod *Q*, while the steam passes from the top to the bottom of the cylinder through the tube *C*. As the piston now reaches the top of the cylinder, a second projection, *a*, on the rod *F*, strikes the end of the bent lever and restores the valves to their first position; then the piston descends as before, and so continuously. Parallel motion is obtained in these engines by the very simple arrangement represented in the figure, and the condenser is the same as that described in the last section. The efficiency of these engines is estimated by the number of pounds of water which they are capable of elevating one foot by the combustion of one bushel of coal. This number is termed the duty of the engine. By a careful construction and management of the engine and boiler, this duty has been raised as high as 125,000,000 pounds.

(309.) *The Non-condensing Engine*.—This form of the steam-engine differs from those just described only in this, that it has no condenser, and the steam is vented from the cylinder directly into the atmosphere. Although, for the reasons already stated, it cannot be worked so economically as the condensing engine, it has the advantage of greater simplicity and compactness, and its first cost is much less than that of its more cumbrous rival. It is therefore frequently preferred when these considerations are of more importance than the saving of a few tons of coal. There is nothing peculiar in the construction of this form of engine, and either of the machines just described might be converted into a non-condensing engine by simply cutting off the eduction-tube and disconnecting the pump-rods from the beam. Of this class the most important is the locomotive engine (Fig. 444), and we have selected it as an example. The construction of the boiler of a locomotive has already been described; and since we are now acquainted with the construction of the single parts of a steam-engine, it will only be necessary to point them out in the figure.

X X is the main body of the boiler ; *D*, the lower part of the fire-box ; *Y*, the smoke-box ; *o*, the brass tubes connecting the two ; *O*, the fire-door, by which the fuel is introduced ; *n*, the

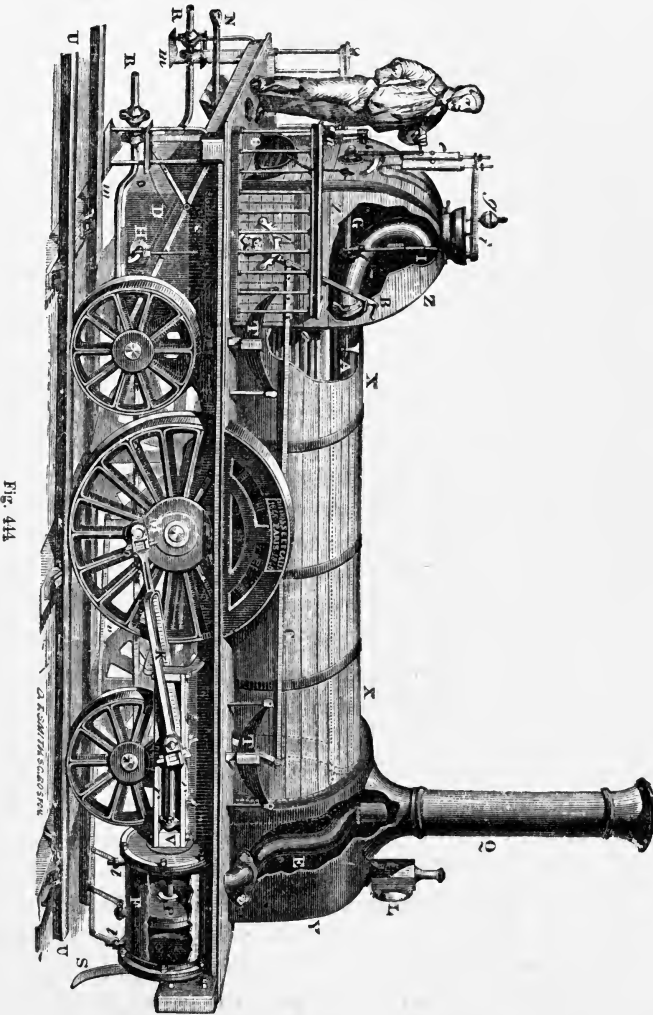

Fig. 414

water-gauge, indicating the level of the water in the boiler ; *H*, the vent-cock, by which the water can be discharged from the boiler ; *R, R*, the feeders which conduct water from the *tender* to two force-pumps (not shown in the drawing), by which it is

forced into the boiler; $Z Z$, the dome of the boiler; i , the safety-valves, which are held in place by spiral springs enclosed in the cases e ; g , the steam-whistle; I , the valve opening into the steam-pipe; G , a rod which controls the motion of the valve. In the drawing, the engineer holds in his hand the lever by which this rod is turned and the valve opened more or less, as circumstances may require; a graduated arc, over which the lever moves, enables him to adjust the valve to any position, and thus to regulate the speed of the engine. A is the steam-tube, which conducts the steam from the top of the dome to the two cylinders; this tube passes through the boiler into the smoke-box, where it branches, as shown by dotted lines in the figure; by this arrangement any condensation of the steam, while passing through the pipe, is prevented. F is one of the cylinders; there is another on the other side of the smoke-box; the steam is admitted into the ends of these cylinders and discharged from them, by means of sliding valves worked by eccentrics on the axle of the driving-wheels; there are generally two sets of these eccentrics placed in opposite positions on the axle, one set for the forward and the other for the backward motion of the locomotive, and so arranged that they can be thrown out of gear or brought into action at the pleasure of the engineer. All this part of the machinery, however, being beneath the boiler, is not visible in the drawing. E is the eduction-tube, by which the steam is discharged from the cylinder into the smoke-pipe Q ; t, t are stop-cocks, by which any water condensed in the cylinders may be vented; P is the piston; V , the packing-box, through which passes the piston-rod; rr are guides, corresponding to the *parallel motion* of the stationary engine, by which the piston-rod is forced to move in a straight line, and any lateral strain prevented; and, finally, K is the connecting-rod, by which the motion of the piston is communicated to the crank M on the axle of the large driving-wheels. In starting the locomotive, as in the other forms of the steam-engine, the valves must be moved by hand; a lever, communicating with the valves by means of connecting-rods, marked B and C in the figure, is always provided for this purpose near the front of the engine. It is only when the train is in motion, and its momentum sufficient to regulate the movements of the machine, that the eccentrics are thrown into gear.

(310.) *Mechanical Power of Steam.* — We can easily calculate the mechanical power generated by the conversion of water into steam from the known increase of volume* which accompanies this change. For this purpose, let us assume that we have a tall cylindrical vessel, open at the top, the area of whose base is one square decimetre. Let us further assume that the cylinder is filled with water at 4° to the depth of one decimetre, and contains, therefore, one litre or one kilogramme of the liquid; and, lastly, let us assume that a piston without weight, and moving steam-tight without friction in the cylinder, rests on the surface of the water. If now we raise the temperature of this cylinder to 100°, and furnish it with a constant supply of heat, the water will change into steam, occupying 1,698.5 times its former volume, and having a tension of 76 c. m., or one atmosphere; which will therefore raise the piston 1,697.5 decimetres under the atmospheric pressure, that is, will raise 103.33 kilogrammes to the height of 169.75 metres. The mechanical power thus exerted is, then, equal to 17,540 kilogramme-metres (compare 238). If we raise the temperature to 120°.6, and furnish a constant supply of heat, as before, the water will change into steam occupying 896.22 times its former volume, and having a tension of two atmospheres. It will, therefore, raise the piston 895.22 decimetres under the pressure of the air, when loaded with an additional weight of 103.33 kilogrammes, thus exerting a mechanical power of $206.66 \times 89.522 = 18,501$ kilogramme-metres. In like manner, the other values given in the fourth column of the following table may be easily calculated: —

Temperature of Steam.	Tension in Atmospheres.	Volume of 1 Kilogramme in Litres.	Power in Kilogramme-metres.	Total Heat absorbed in Evaporation.	Power from 1 Heat Unit in Kilog.-metres.
100.0	1	1,698.5	17,540	637.0	27.53
120.6	2	896.22	18,501	643.3	28.76
144.0	4	474.81	19,583	650.4	30.11
170.8	8	252.67	20,804	658.6	31.59

By comparing the conditions assumed above with those in an actual steam-engine, it will be seen that the power given in the

* The volume of the steam, as compared with that of an equal weight of water at 4°, can always be obtained by dividing the weight of one cubic metre of water at 4° (one million grammes) by the weight of one cubic metre of steam as given in the table on page 571.

above table is the greatest possible power which can be obtained by the conversion into steam of one kilogramme of water at the different temperatures; provided, as we assumed in the description of the steam-engine (307), that the tension of the steam does not change from the time it leaves the boiler until it is discharged into the condenser, and provided, also, that the steam acts against a perfect vacuum. These conditions are never fully realized in practice, so that even with the best regulated machines we only obtain from one half to two thirds of the theoretical effect.

The total number of units of heat required to change one kilogramme of water into steam of one, two, four, and eight atmospheres' pressure, as calculated by [202], is given in the fifth column of the above table, and the sixth column shows the power obtained in each case by the expenditure of one unit of heat. It will be noticed that the power is nearly the same in all cases, and hence it follows, apparently, that no important gain is obtained by the use of steam of high tension. There is, however, a mode of working the steam-engine in which the gain thus effected is very great.

Let us suppose that the boiler is supplying steam of four atmospheres, which, as the table shows, it can supply at only a little greater expenditure of heat (in other words, of fuel) than steam of one atmosphere pressure. If the engine were worked with steam of one atmosphere pressure under the conditions described above, each volume of steam equivalent to the capacity of the cylinder, and weighing, as we will suppose, one kilogramme, will do the work of raising 103.33 kilogrammes through a height equal to the length of the stroke of the piston. Speaking approximately, the same weight of steam of four atmospheres' tension will do an equivalent work during the first quarter of the stroke; for it will raise four times 103.33 kilogrammes through one fourth of the previous height. Suppose, now, that the connection between the cylinder and the boiler is closed at this point, it is evident that the steam will continue to exert an expansive force, although a force lessening gradually as the capacity of the cylinder increases. When the piston has been raised through one half of the stroke, the volume of the kilogramme of steam will have doubled, and its tension have been reduced to two atmospheres; when it has achieved three fourths of the stroke, the

volume will have trebled, and the tension have been reduced to $1\frac{1}{3}$ atmospheres; and even at the end of the stroke, when the volume has quadrupled, the pressure will still be one atmosphere. Here, then, is a very large gain of power without any additional expenditure of fuel. In practice, these conditions are realized by closing the valve admitting steam into the cylinder after a certain fraction of the stroke, by means of various forms of automatic machinery, called *cut-offs*. The actual theoretical advantage gained in any case can readily be calculated. It is evidently the greater, the higher the tension of the steam in the boiler and the sooner it is *cut off* after the beginning of the stroke. In no case, however, is the total practical effect as great as the theoretical power given in the table on page 631. When thus worked, the engine is said to be worked expansively.

We are far from obtaining with the steam-engine the full mechanical equivalent of heat, even when working under the most favorable circumstances. It will be remembered, that, according to Joule's experiments (238), one unit of heat is capable of generating a power equal to 423 kilogramme-metres, which is 13.4 times greater than 31.59 kilogramme-metres, the greatest possible effect which could be obtained with the steam-engine when not worked expansively, even under a pressure of eight atmospheres. Considering, then, that we do not realize, even under the best circumstances, much more than one half of this theoretical effect, it will be seen that we actually obtain with the steam-engine only about one twentieth of the power which the fuel is capable of yielding. To find a more economical means than this of converting heat into mechanical effect, is one of the great problems of the present age.

(311.) *Low and High Pressure Engines.* — As the tension of the steam used in non-condensing engines (309) is necessarily greater than the pressure of the air, they are frequently called *high-pressure* engines, while the condensing engines are known as *low-pressure* engines. These terms, however, do not correctly express their nature, since, although the non-condensing engine must necessarily be worked at a high pressure, yet, as we have just seen, a great advantage is gained by working the condensing engine under a similar pressure; and, in fact, the so-called low-pressure engines are frequently worked under as great a head of steam as the high-pressure engines.

PROBLEMS.

Heat of Fusion.

352. Three kilogrammes of ice at 0° are mixed with 10 kilogrammes of water at 100° . Required the temperature of the mixture after the ice is melted.

353. How much ice at 0° must be added to 200 kilogrammes of water at 16° in order to reduce its temperature to 10° ?

354. Solve the same problem, substituting letters for the numbers.

355. How much ice at 0° is required to cool 10 kilogrammes of mercury from 100° to 0° ?

356. A mass of tin weighing 55 grammes and heated to 100° was enclosed in a cavity made in a block of ice. Required the amount of ice melted.

357. Eight kilogrammes of ice at 0° were mixed with 35 kilogrammes of water at 59° ; after the ice had melted, the temperature of the water was $33^{\circ}.3$. Required the heat of fusion of ice.

358. In order to determine the heat of fusion of lead, 200 grammes of melted lead at the melting-point were poured into 1,850 grammes of water at 10° . After the lead had cooled, the water was found to have acquired a temperature of $11^{\circ}.64$. Required the heat of fusion of the metal.

Tension of Vapors.

359. Before filling a barometer with mercury, a small quantity of water was poured into the tube. How high will the mercury stand in the barometer when the temperature is 20° and the pressure of the air 77 c. m.? Solve the same problem, assuming that alcohol was used instead of water.

360. Determine the height of the mercury-column in a barometer-tube whose walls are moistened with water at the temperatures and pressures indicated below:—

1. $H = 76.22$ c. m. $t = 20^{\circ}$.		4. $H = 77.20$ c. m. $t = 30^{\circ}$.
2. $H = 75.11$ " $t = 40^{\circ}$.		5. $H = 76.54$ " $t = 60^{\circ}$.
3. $H = 74.56$ " $t = 10^{\circ}$.		6. $H = 78.10$ " $t = 100^{\circ}$.

361. Solve the last problem, assuming, first, that chloroform, and, secondly, that oil of turpentine, were used instead of water.

362. Calculate by [199] the tension of the vapor of water at the following temperatures: $-10^{\circ}.24$, $15^{\circ}.45$, $40^{\circ}.25$, $60^{\circ}.58$, $150^{\circ}.5$, and $220^{\circ}.85$.

363. Determine the tension of the vapors of alcohol, of ether, and of chloroform at the following temperatures, assuming that the principle of page 582 is correct: $20^{\circ}.12$, $15^{\circ}.64$, $10^{\circ}.22$, and $5^{\circ}.12$.

364. Determine the boiling-point of water under the following pressures: 74.24 c. m., 55.54 c. m., 34.20 c. m., 10.50 c. m., and 5 c. m.

365. Determine the boiling-points of alcohol under the following pressures: 4.40 c. m.; 163.5 c. m.; 725.78 c. m.

366. A cylindrical vessel at the temperature of $120^{\circ}.6$ is filled with vapor of water having a tension of 100 c. m. What will be the tension of the vapor if its volume is reduced to one half by pushing down the piston? What will be the tension of the vapor if its volume is doubled?

367. A glass vessel is filled with dry steam which at the temperature of 100° has a tension of 54.22 c. m. To what temperature must the vessel be cooled before the steam begins to condense? What will be the tension of the steam, if the vessel is heated to 200° ?

368. In a strong iron vessel, whose capacity equals $5,000 \text{ c. m.}^3$, 15.24 grammes of water are hermetically sealed. Required the tension of the vapor in the interior of the vessel at the following temperatures: 50° , 100° , 160° , 180° , and 250° .

Latent Heat of Vapors.

369. How much free steam must be condensed in order to raise the temperature of 20 kilogrammes of water from 0° to 90° ? How much to raise the temperature of 246 kilogrammes of water from 13° to 28° ?

370. How much vapor of alcohol must be condensed in order to raise the temperature of 5 kilogrammes of alcohol from 15° to 30° ?

371. Twenty-five kilogrammes of free steam condensed in a mass of water raised its temperature from 4° to $61^{\circ}.4$. Required the volume of the water before and after the condensation.

372. How many kilogrammes of ice at 0° would be required to condense 25 kilogrammes of free steam, and reduce the temperature of the water formed to 0° .

373. Calculate the latent heat of steam at the following temperatures: 25° , 32° , 112° , 175° , 198° , and 222° .

374. Calculate how much heat is required to convert one litre of water at 15° into steam at its maximum tension at 130° .

375. How much heat would be evolved by the condensation of one cubic metre of steam of 140° at its maximum tension into water at 20° ?

Steam-Engine.

376. How much mechanical force is generated by the conversion of 25 kilogrammes of water at 0° into steam at 140° , and how much heat is required for the conversion?

377. The piston of a steam-engine has a diameter of 44 c. m., and it moves 1.15 m. each second. Required the weight which the machine can raise to the height of 8 metres in one second, assuming that there is no resistance, and that the tension of the steam is 2.75 atmospheres. Determine, also, the quantity of heat required to furnish the steam employed in producing this effect.

HYGROMETRY.

(312.) *Formation of Vapor in an Atmosphere of Gas.* — If we repeat the experiment with the vessel of one cubic metre capacity described in (284), with only this change, that it is left filled with air, we shall find that the same amount of aqueous vapor will be formed as in a perfect vacuum. For each temperature there will be found to exist simultaneously in the cubic metre, first, an atmosphere of air; secondly, an atmosphere of aqueous vapor, having the weight and tension which are given in the table on page 571. The only difference between the circumstances attending the formation of vapor in air or any other gas, and in a vacuum, is in the time required. The cubic vessel, when freed from air, would be almost instantaneously filled with vapor of the given tension and weight; but in the same vessel filled with air, the vapor would attain its maximum tension and density only after several minutes.

The tension of the mixture of aqueous vapor and air is always equal to the sum of the tensions which each would have if it filled the vessel separately. This tension can then be found for any temperature by adding to the tension of the air, as indicated by a barometer, the tension of aqueous vapor taken from the table of maximum tensions opposite to the given temperature. Thus, if the temperature were 20° , and the barometer indicated a tension of 76 c. m., the tension of the mixture of air and vapor would be equal to $76 + 1.739 = 77.739$, and a barometer immersed in the vessel would stand at that height.

If now we suppose the vessel to be extensible, and exposed on the outside to an invariable pressure of 76 c. m., it is evident that it will be expanded until the tension of the confined mixture is reduced to the same value; and it is frequently a problem of great practical importance to determine what the increased volume will be. In the first place, it is evident that, as the volume of the vessel increases, more water will evaporate, so as to keep the vapor at the maximum tension for the temperature. Hence, in the expanded state, the tension of the vapor will still be 1.739 c. m. It is, therefore, only the air which expands, and as the tension of the mixture in its expanded state is equal by assumption to 76 c. m., it is evident that the tension of the air will be equal to $76 - 1.739 = 74.261$ c. m. Moreover, since the

volume of the air (which is, of course, also the volume of the mixture) must be inversely as its tension in the two conditions, we have, by [200],

$$1 : V' = 74.261 : 76, \quad \text{whence} \quad V' = 1.023 \overline{\text{m.}}^3$$

This solution may easily be made general. Let H_0 represent the invariable pressure to which the gas is exposed, and \mathfrak{H}_0 the tension of water vapor at the given temperature. Then, in the expanded state, the tension of the air is $H_0 - \mathfrak{H}_0$. We have, by substituting these values in [200], $V : V' = H_0 - \mathfrak{H}_0 : H_0$; whence

$$(1.) V' = V \frac{H_0}{H_0 - \mathfrak{H}_0}, \quad \text{and} \quad (2.) V = V' \frac{H_0 - \mathfrak{H}_0}{H_0}. \quad [203.]$$

By means of (1) we can always calculate the increased volume, V' , of a gas when saturated with moisture, if the volume of the dry gas is known; and by means of (2) we can calculate from the measured volume of the moist gas the volume, V , which it would have measured had the gas been perfectly dry. The last problem is one of great importance, and generally presents itself in a form like that of the following example.

A volume of gas confined in a bell-glass over water measures $250 \overline{\text{c.m.}}^3$ when the temperature is 20° and the barometer 76 c. m. What would be the volume if the gas were perfectly dry? By substituting the data given in (203. 2) we obtain,

$$V = 250 \frac{76 - 1.739}{76} = 244.25 \overline{\text{c.m.}}^3. \quad [204.]$$

The formula just employed gives in any case the volume of dry gas for the temperature and pressure at which the volume of the moist gas was observed; only it is necessary to remember, in using the formula, that H_0 represents the pressure to which the mixture of gas and vapor was exposed at the time the volume was measured. This can always be ascertained by the method described in (169). When the volume of dry gas has been in this way determined for any given temperature and pressure, it can easily be reduced to 0° and 76 c. m. by means of [98] and [184].

What has been illustrated above in the case of the vapor of

water, is also true of the vapors of other liquids. The same quantity of liquid will evaporate into a cubic metre, and a vapor will be formed of the same tension and density, whether the space be empty or filled with gas; the only difference being that the liquid will evaporate very much more slowly in the last case than in the first. What is true of one liquid must also be true of any number of liquids; provided only that these do not act chemically on each other, each of them will evaporate and form a vapor of the same tension and density as if the space were a perfect vacuum. At least this is true theoretically, and it would probably be true practically could we enclose the vapor within walls formed by the volatile liquids themselves. But in the glass vessels with which we are obliged to experiment, the result, as above stated, is not perfectly realized. This is apparently owing to an adhesive action of the glass, by which the tension of the vapor is reduced below the maximum tension for the temperature. This subject has been carefully examined by Regnault, and we would refer to his memoir* for further details.

The principles of this section may be summed up in the two following propositions, first enunciated by Dalton, and therefore known as the *Law of Dalton*. The last proposition, however, is only a necessary consequence of the first.

1. *The tension and the amount of the vapor which will saturate a given space at a given temperature are the same, whether the space be completely empty or filled with gas.*

2. *The elastic force of a mixture of gas and vapor is equal to the sum of the tensions which each would have separately.*

This law may be illustrated by means of the apparatus represented in Fig. 445. It consists of a glass tube, *A*, closed at both ends by the iron stopcocks *b* and *d*. The lower stopcock is provided with a side tubulature, into which the tube *B* is cemented, and a graduated scale placed between the tubes serves to measure the relative heights of the columns of mercury they contain. In using this apparatus, the tube *A* is, in the first place, about half filled with dry air, or any other gas from the globe *M*, which can be screwed on to the stopcock *b* in place of the tunnel *C*. The tunnel *C* is provided with a stopcock of a peculiar construction. The plug of the cock, represented at *n*, is not

* Comptes Rendus, Tom. XXXIX. p. 345.

pierced, as usual, completely through, but has simply a small cavity on one side. Having now adjusted the quantity of mercury in the apparatus so that it shall stand at the same height in both tubes, and having poured a quantity of liquid into the tunnel, we open the cock *b* and turn the plug of the cock *a* so that the liquid may be introduced drop by drop into the tube *A*. The confined gas becomes thus saturated with vapor, and, expanding, depresses the mercury-column. We then restore the original volume by pouring mercury into the tube *B*. The tension of the mixture of gas and vapor is now evidently equal to the pressure of the air plus the pressure of the mercury-column *Bo*, thus proving that the tension of the confined gas has been increased by the tension of the vapor. By referring to the tables, it will be found that the increase of tension is exactly equal to the maximum tension of the same vapor in a vacuum, when exposed to the same temperature.

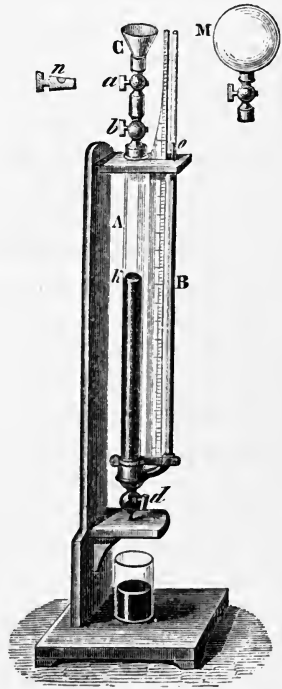

Fig. 445.

(313.) *Hygrometers*. — Every cubic metre of the atmosphere in immediate contact with the earth is, in all respects, similarly situated towards the ponds and rivers of the globe as is the air of the cubic vessel towards the water it contains. Every cubic metre of the atmosphere is capable of holding, for any temperature, the same amount of aqueous vapor, and vapor of the same tension, as the vessel; moreover, water will continue to evaporate into the atmosphere until the vapor has acquired the tension and specific gravity which correspond to the temperature. There are, therefore, around the globe, as in the cubic vessel, two atmospheres, one of air and the other of vapor. When the air has taken up all the vapor which it is capable of holding at the temperature, it is said to be saturated or moist; when less, it is said to be dry. In the last case, it is capable of absorbing

more water, and of course dries up the moisture from substances with which it may be in contact. Thus, if the temperature is 20° , the air is saturated with vapor when it contains in every cubic metre 17.157 grammes (see table on page 571); if it contained only 12.746 grammes it would be dry, since then every cubic metre of air could absorb 4.411 grammes more. But if the temperature falls to 15° , then by the table 12.746 grammes will completely saturate each cubic metre; so that a cubic metre of air containing 12.746 grammes of vapor is saturated when the temperature is 15° , although dry when it is 20° .

The moisture of the atmosphere at any temperature depends, then, not simply on the amount of vapor which it contains, but on the proportion which this amount bears to the whole quantity which it could possibly contain at the given temperature. The fraction which is obtained by dividing the actual weight of vapor in a cubic metre of the atmosphere by the weight which it would contain were it completely saturated with aqueous vapor, is called the *relative humidity*. It follows from Mariotte's law, that the weights of two masses of vapor occupying equal volumes are to each other as their tensions, $W : W' = \mathfrak{H}_0 : \mathfrak{H}'_0$; hence the relative humidity may also be obtained by dividing the tension of the vapor actually contained in the air by the tension the vapor would have if the atmosphere were saturated, that is, by the maximum tension for the temperature, as given in Table X. In order to find, then, the relative humidity of the atmosphere at any given time, we in the first place observe its temperature; and in the second place, we ascertain by experiment the tension of the vapor which it actually contains. The tension is found in the following manner.

If we cool down a cubic metre of the atmosphere, we shall come, sooner or later, to a temperature at which the tension of the vapor is at its maximum. Thus, for example, if the temperature of the atmosphere is 20° , and the tension of the vapor it contains, and which we wish to find, is 1.2699 c. m., we shall, by cooling one cubic metre to 15° , reach a temperature at which 1.2699 c. m. is the maximum tension, and consequently a temperature at which the air will be saturated by the vapor contained in it. If now we cool it below this point, a portion of the vapor will be deposited in the form of mist or dew. The temperature,

then, at which dew would be deposited, were the atmosphere cooled down, is the temperature at which the tension of the vapor contained in it would be at its maximum. This temperature is technically termed the *dew-point*. It can easily be observed in the following way. Take a brightly polished silver cup and fill it with water. Place in it a sensitive thermometer, which will indicate promptly any changes of temperature, and then add ice in small pieces, waiting until one piece is melted before adding another, and constantly stirring the water with the thermometer in order to render the temperature uniform throughout the mass. The silver cup, as it is thus slowly cooled, will cool in its turn the thin layer of air which immediately surrounds it, and sooner or later this air will be reduced to the temperature at which the vapor it contains completely saturates it. At that moment the polished surface of the cup will be dimmed by a deposition of dew. Note carefully the temperature at which this first takes place; and then allow the cup to warm, and note carefully the temperature at which the dimness disappears. The two temperatures should very nearly correspond, and the mean may be taken as the dew-point. Having found the dew-point, we can easily ascertain the relative humidity of the air by means of the table of tensions. Opposite to the dew-point we find the actual tension of the vapor in the atmosphere. Opposite to the temperature of the air at the time of the experiment, we find the maximum tension which the vapor could attain; and since, as we have seen, the weight of vapor is proportional to the tension, we can obtain at once the relative humidity by dividing the first by the last. To illustrate this by an example:—

The temperature of the air is 20° . The dew-point, found as just described, is 15° . What is the relative humidity? The maximum tension of vapor at the dew-point is 12.699 m. m., and this is the actual tension of the vapor in the atmosphere. The maximum tension of vapor at 20° is 17.391 m. m., and this is the tension which the vapor would have were the atmosphere saturated. $\frac{12.699}{17.391} = .73$ is, then, the relative humidity. The atmosphere, therefore, contains 73 per cent of the whole amount it could possibly contain at 20° . From the relative humidity, it is easy to calculate the amount of vapor contained in a cubic metre. By referring to the table, we ascertain the total amount which the cubic metre could contain at the given temperature;

and by multiplying this by the fraction expressing the relative humidity, we ascertain the amount which it actually contains. Thus, in the example just given, the total amount of vapor which one cubic metre of air at 20° can contain is 17.157 grammes. It actually contains only 73 per cent of this amount, that is, $17.157 \times .73 = 12.525$ grammes.

It appears, then, that the determination of the amount of vapor in the atmosphere resolves itself practically into the observation

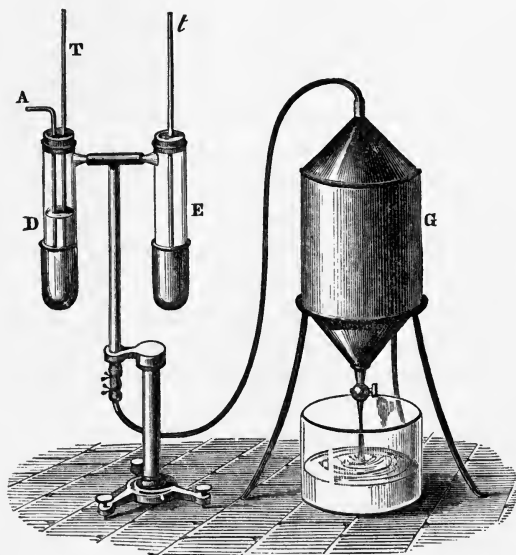

Fig. 446.

of the dew-point. This can be observed with sufficient accuracy, for most purposes, with a thin silver cup and thermometer, as described above; but where greater accuracy is required, the observations can be made more rapidly, as well as with greater certainty, with the hygrometer of Regnault, which is represented in Fig. 446. It consists of two silver thimbles 4.5 c. m. high and 20 m. m. in diameter, made very thin, and brightly polished on the outside. These thimbles are cemented to the bottom of two glass tubes *D*, *E*. Each of these contain thermometers graduated to tenths of a degree, kept in place by corks. Through the cork of the tube *D* passes a small tube, *A*, open at both ends and extending to the bottom of the silver thimble. The upper

part of the tube *D* communicates, through the lateral tubulature and through the stem of the support, with an aspirator, *G*, by means of which air can be drawn through the apparatus. The tube *E*, which does not communicate with the aspirator, contains a thermometer for observing the temperature of the air.

In order to use the apparatus, the tube *D* is half filled with ether; then, on opening the stopcock of the aspirator, the water which it contains flows out, and the air required to supply its place flows in at the tube *A*, bubbling up through the ether. The rapid evaporation caused by this current of air soon cools the temperature of the silver thimble to the dew-point. At the moment a film of moisture appears on the polished surface, the temperature indicated by the thermometer *T* is carefully noted, as well also as the temperature of the air given by the thermometer *t*, and we have then the elements for calculating the relative humidity of the atmosphere. By careful manipulation, the dew-point can be observed with this instrument to one tenth of a Centigrade degree. The second silver thimble, on the tube *E*, serves not only to protect the bulb of the thermometer, but also, by comparison, enables the observer to detect a slight trace of moisture on the surface of the first, which might otherwise be overlooked.

The hygrometer of Daniells, represented in Fig. 447, is based on the same principle as that of Regnault, but is much less delicate in its indication. It consists of two bulbs connected by a siphon-tube, from which the air has been expelled by hermetically sealing the instrument when filled with ether vapor. The bulb *A* is about half filled with ether, and contains the bulb of a small thermometer. Moreover, a zone of the bulb is gilt, and burnished so that the deposition of the dew upon it may be easily perceived. The other bulb is covered with muslin. When an observation is to be made, the muslin is moistened with ether, which is dropped very slowly from a bottle. The evaporation of the

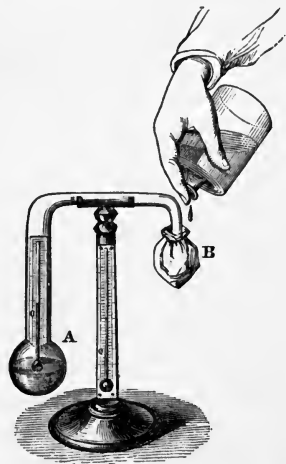

Fig. 447.

ether from the muslin, by cooling the bulb *B* and condensing the vapor of ether which it contains, causes a very rapid evaporation from the surface of the liquid in the bulb *A*. By this means the gilt zone is soon cooled to the dew-point, a deposition of dew indicating when the point is reached. The temperature at which the dew is first deposited is carefully observed by means of the enclosed thermometer, and also the temperature at which it disappears when the temperature of the bulb *A* is afterwards allowed to rise. The two observations should not differ much from each other, and their mean is the dew-point.

The relative humidity of the air may also be estimated, though with less accuracy, from the rapidity with which water evaporates when exposed to it; since, as is evident, the drier the air, the more rapid will be the evaporation. The instrument used for this purpose is called a *psychrometer*, or a *wet-bulb hygrometer*. It consists of two thermometers, the bulb of one of which is covered with muslin and kept constantly moist, while the bulb of the other is dry. The last indicates the temperature of the air; but the first always indicates a lower temperature, owing to the latent heat absorbed by the evaporation of the water from the surface of the bulb, except when the air is fully saturated with moisture. The difference between the two thermometers will be the greater the more rapid the evaporation, that is, the greater the dryness of the air. From the temperatures of the two thermometers we can calculate the tension of the vapor in the atmosphere by means of the empirical formula,

$$x = \mathfrak{f} - \overset{\text{More than } \frac{4}{10},}{\frac{0.429 (\tau - \tau')}{610 - \tau'}} H_0, \quad \text{or} \quad x = \mathfrak{f} - \overset{\text{Less than } \frac{4}{10},}{\frac{0.480 (\tau - \tau')}{620 - \tau'}} H_0;$$

\mathfrak{f} = maximum tension of vapor at lowest temperature.

τ = temperature of dry-bulb thermometer.

τ' = temperature of wet-bulb thermometer.

H_0 = height of barometer.

610 — τ' = latent heat of the vapor of water (compare 300).

x = tension of aqueous vapor at the time of observation.

From the value of x the relative humidity can be easily calculated by dividing by the maximum tension, as before described.

The above are the formulæ of Regnault as modified from the original formula of August. They are in a measure empirical,

and founded on theoretical considerations, for which we must refer to the original memoir. The last formula, as Regnault found, gives accurate results when the air is not more than four tenths saturated. Otherwise, the first should be used. For temperatures below freezing, which suppose the wet bulb to be covered with a film of ice, the value $610 - \tau'$ must be changed to $610 + 79 - \tau = 689 - \tau'$, since the amount of heat required to change ice into vapor is greater by 79 units (the heat of fusion) than that which would be required to change water into vapor of the same temperature and tension. For the value of H_0 , it is generally sufficient to take the mean barometric pressure of the place of observation. In the Meteorological Tables prepared by Professor Arnold Guyot, and published by the Smithsonian Institution, will be found tables by which, from the indications of the psychrometer, the tension of vapor and relative humidity may be ascertained by inspection. As the indications of the psychrometer are discovered by simple inspection, it would entirely supersede all other hygrometers were the formula by which the tension of vapor is deduced from the observed data perfectly trustworthy. They are sufficiently so for the purposes of meteorology, but results obtained with Regnault's hygrometer are in all cases to be preferred.

Still a third class of hygrometers is based upon the fact that many solids swell on imbibing moisture, and contract again on drying. This is the case with most dry organic substances, such as whalebone, wood, parchment, and hair. The hygrometer of Deluc consists of a very thin piece of whalebone, which, in expanding and contracting, moves an index; and a variety of toys, in which a change in the degree of humidity of the air is shown by the motion of a pasteboard figure, are made on the same principle. But the only trustworthy or even approximatively accurate hygrometer of this class is the hair hygrometer of Saussure, as modified by Regnault. It is represented in Fig. 448, and consists essentially of a human hair, *c*, previously freed from fat by being soaked in ether, and so fixed in a copper frame that its expansion and contraction will move a needle over a graduated arc. Each

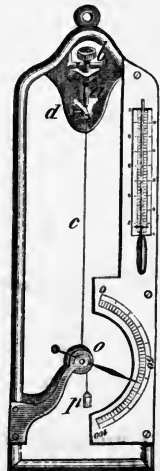

Fig. 448.

instrument is graduated experimentally by placing it in a confined space kept in a known state of humidity by the presence of sulphuric acid of different degrees of strength. Unlike the other hygrometers, this instrument gives at once the relative humidity of the air, and its indications are independent of the temperature. Unfortunately, however, it is liable to variations, and must be adjusted from time to time by means of the solutions employed in graduating it.

The last, but the most accurate, method of determining the amount of vapor in the air, consists in drawing through a tube containing chloride of calcium, or some other powerful absorbent, a measured volume of air, by means of an aspirator. The increased weight of the tube will give at once the weight of vapor contained in the known volume of air. This process is much too complicated, however, to admit of general application; but it may be used to advantage where great accuracy is required, or in verifying the results of the other more expeditious methods.*

(314.) *Drying Apparatus.* — It is frequently necessary in the practice of chemistry to remove from a solid body the moisture adhering to its surface, or otherwise mechanically united with it. This is, generally, readily accomplished by exposing the solid to dry air, into which the moisture evaporates. If the solid will bear the temperature of 100° without undergoing change, we can

use the drying oven already described (294); but if not, we effect the same object at the ordinary temperature by placing the solid under a bell-glass, over a dish containing concentrated sulphuric acid. In this case the rapidity of the evaporation is greatly accelerated by exhausting the air. The arrangement represented in Fig. 449 may be used for this purpose, and also for concentrating solutions of chemical compounds which would be altered by a high temperature. In drying goods on a large scale in the arts, it is important



Fig. 449.

to keep in mind two facts: first, that the capacity of air for holding moisture increases very rapidly with the temperature; and, secondly, that a very considerable time must elapse before

* For a full account of the methods of hygrometry as revised by Regnault, see his "Études sur l'Hygrometrie," *Annales de Chimie et de Physique*, 3^e Série, Tom. XV.

the air is saturated, — the longer, the lower the temperature. An advantage is therefore gained by keeping the air in the drying chamber at as high a temperature as is compatible with the circumstances, and preventing it from escaping until it is absolutely saturated with humidity. In no case, however, can water be evaporated by heated air in a drying stove as economically as in a close boiler.

ORIGIN OF HEAT.

(315.) *Sources of Heat.* — The sun's rays are the great source of heat on the surface of the globe. The amount of heat which thus enters the earth's atmosphere from the sun during a year has been estimated by Pouillet to be equal on an average to 231,675 units for every square centimetre of the earth's surface. In order to give an idea of this quantity, Pouillet states that it would be sufficient to melt a layer of ice enveloping the earth 30.89 metres thick. Of this amount, however, the surface of the earth only receives about two thirds, the rest being absorbed by the atmosphere. Besides the heat which it is constantly receiving from the sun, the earth has also a great store of heat within its own mass, called the *central heat*. It has already been stated, that the spheroidal figure of the earth is probably owing to the fact, that the globe was once a fluid mass; and we have reason to believe that it is so now, with the exception of a comparatively thin crust on the surface. From observations made in mines and Artesian wells, we find that the temperature of the crust rapidly increases as we descend from the surface of the earth. The rate of increase varies in different places, but may be stated, on an average, to be about one degree for every 30 or 40 metres. At this rate of increase, assumed to be the same at all depths, the temperature of the crust at the depth of about 2,700 metres must be that of boiling water, and at a depth of 35 kilometres that of melting iron, while at 70 kilometres all known mineral substances would be in complete fusion. It is probable, therefore, that the thickness of the crust of the earth is not greater than $\frac{1}{150}$ of its radius, and might be represented by a sheet of pasteboard on a large artificial globe. Nevertheless, the conducting power of the crust is so slight, that the effect of the central heat is hardly felt on the surface; and Fourier has calculated

that it does not elevate the mean temperature of the surface more than $\frac{1}{3}$ of a degree.

Besides these constant sources of heat, there are many others which are more or less accidental and intermittent. In general, any motion of the molecules of a body, whether it accompanies a chemical or a physical change, is attended either by an evolution or by an absorption of heat; but in almost every case the heat thus evolved may be traced back, either directly or indirectly, to the sun. The accidental sources of heat may be divided into two classes, the physical and the chemical.

(316.) *Physical Sources.*—Of the physical sources of heat, the most important is friction. Count Rumford succeeded in boiling water by the friction from boring a cannon, and an apparatus has been invented in France for generating steam by means of heat produced in a similar way. It has already been shown (238) that there is an exact equivalence between the heat generated by friction and the mechanical power used in producing it; and it is possible that, where motive power is abundant and fuel expensive, such a machine might be used to advantage.

Another physical source of heat is percussion, as is illustrated by the common flint-lock, and by a number of familiar facts. For example, a small bar of iron may be heated to redness on an anvil by blows of the hammer actively applied, and a bar of lead may even be melted in this way. In like manner all metals, when rolled out into plates, drawn into wire, or submitted to any other mechanical process by which the relative position of their molecules is changed, become more or less heated. The heat evolved in all these cases appears to be due to an internal friction between the particles of the solid, so that this source of heat does not differ essentially from the last.

A third source of heat is mechanical condensation. If we diminish the volume of a body by mechanical means, its temperature is at once raised, and an amount of heat is evolved which is probably in all cases equal to that which would be required to expand the body by an equivalent amount (compare 237). Since both solids and liquids are but slightly compressible, we cannot produce with them any very marked calorific effects by condensation. It is different with gases. They are very compressible, and their temperature can be greatly raised by sudden condensation. This is illustrated by the *fire-syringe* (Fig. 450). It consists of a

cylinder of glass, and of a piston, which closes it hermetically and by which the air it contains may be condensed. On pushing in the piston with a quick and forcible motion, the heat evolved by the condensation of the air raises the temperature sufficiently to inflame a piece of tinder, which is placed in a cavity provided for the purpose on the under side of the piston. This requires a temperature of at least 300° . A bright light is noticed in the cylinder at the moment of the maximum condensation, caused by the burning of a portion of the oil with which the piston is lubricated.

The only other mechanical sources of heat usually enumerated in this connection are the absorption of gases or liquids by porous solids, the change of the state of aggregation of a substance, and electricity. The first of these is probably identical with the one last considered, the heat in every case originating from condensation caused by the adhesion of the liquid or gas to the surface of the solid; the second has already (277 and 299) been studied at length, and the last will be considered in another portion of the work.

(317.) *Chemical Sources.* — All chemical combination is attended with the evolution of heat; indeed, this is the chief source of artificial heat on the surface of the globe. When the combination takes place slowly, as when iron rusts in the air, the heat is dissipated as fast as it is evolved, and does not elevate sensibly the temperature of the combining substances; but when the combination is rapid, the heat accumulates in the bodies and produces the phenomena of combustion. Combustion is, therefore, simply a process of chemical combination, in which heat is evolved so much more rapidly than it is conveyed away through the usual channels, that the temperature of the substances is retained above the point of ignition. All combustion with which we are generally familiar consists in the chemical combination of the burning substance with the oxygen of the air; but we may have phenomena

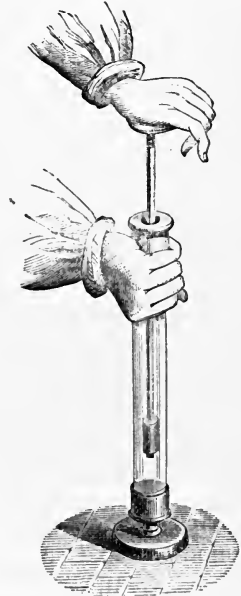

Fig. 450.

of intense ignition without oxygen, as when antimony is dropped in powder into a jar of chlorine, or when phosphorus is mixed with iodine. The quantity of heat evolved during chemical combination varies very greatly with the nature of the substances employed; but it is always constant for the same substances, and is exactly proportional to the weight of each which is used in forming the compound. Thus, for example, from one kilogramme of the following substances there is always evolved the amount of heat indicated in the following table when they combine with oxygen, or, in other words, when they burn.

	Units of Heat.		Units of Heat.
Hydrogen,	34,462	Oil of Turpentine,	10,662
Marsh Gas,	13,063	Ether,	9,027
Olefiant Gas,	11,858	Alcohol,	7,184
Beeswax,	10,496	Wood Charcoal,	8,080
Spermaceti,	10,342	Gas Coke,	8,047
Stearic Acid,	9,716	Native Sulphur,	2,261

It has, moreover, been proved that the amount of heat evolved during chemical combination is precisely the same whether the union be rapid or slow, and also whether the compound be formed at once by direct combination or by several successive processes. But all these subjects can be discussed to much greater advantage after the student is familiar with the laws of chemical combination; we shall, therefore, defer the further consideration of them until then. The same is true, also, of the heat evolved by the processes of animal life; for this is probably due to a slow combustion which takes place in the animal body under the influence of vitality.

PROPAGATION OF HEAT.

(318.) Heat may be transmitted from one body to another through space, as it is transmitted from the sun to the earth, or it may be communicated from particle to particle by direct contact, as when a bar of iron is heated by placing one end in contact with ignited coals. The first of these methods is called *radiation*, the second *conduction*. It is probable, however, that conduction is only a form of radiation, the heat being, in all cases, radiated from particle to particle through the intervening spaces, which may be exceedingly large as compared with the size of the particles themselves (75).

(319.) *Radiation.* — When we stand in the bright sunshine or before a blazing fire, and feel the effect of the rays of heat impinging on our bodies, we are led to perceive that heat is emitted from the surfaces of hot bodies, and that it has the power of traversing space and transparent media like the atmosphere. But it is also probable that rays of heat are emitted from the surfaces of all bodies and at all temperatures, however low, the only difference between hot and cold bodies being that the first radiate more heat than the last. In a room where there is a condition of thermal equilibrium, each object receives as much heat as it radiates, and therefore retains its own temperature. If one object, however, becomes warmer than the rest, — the stove, for example, — then it radiates more heat than it receives, until the equilibrium is again established. This theory explains the apparent radiation of cold, which we feel when standing before a large mass of ice. It is not that the ice radiates cold, since it actually radiates heat; but as the body receives from the ice less heat than it radiates towards it, we feel a sensation of cold.

The phenomena of radiant heat are in all respects similar to those of light, and, as is well known, the rays of both agents are found mixed together in the sunbeam and in the emanations from most luminous objects. Like light, radiant heat is transmitted with an incredible velocity in straight lines, and its intensity diminishes as the square of the distance from the source. If the rays of heat fall on a polished surface they are reflected, and the angle of reflection is always equal to the angle of incidence. If they enter a transparent medium they are refracted, and for the same substance the sine of the angle of refraction always bears a constant ratio to the sine of the angle of incidence. If they are passed through a prism of rock salt, they are divided into rays of different refrangibility, which stand to each other in the same relation as the different colors of the solar spectrum; and, lastly, when reflected or refracted at a certain angle by different substances, the heat rays become polarized and present properties similar to those of polarized light. But yet, although the thermal rays thus closely resemble the rays of light, there are essential differences between the two. It does not follow, because a medium transmits light unchanged, that it will transmit heat with equal readiness; thus, for example, a crystal of alum, even if perfectly transparent to light, is almost opaque to heat; and, on the other hand,

a crystal of smoky quartz, which will hardly transmit a ray of light, is quite transparent to heat. Most solid and liquid media which are transparent and colorless as regards light, act on the rays of heat in the same way that colored glasses act on light; transmitting rays of certain degrees of refrangibility, but not others. Thus, for example, a pane of colorless glass will transmit nearly all the rays of heat from the sun, while it will intercept the greater part of those from a coal fire, and absolutely all the rays which radiate from a steam-pipe heated to 100° ; and the same is true to a still greater degree of water. The only substance which is perfectly transparent to rays of heat from every source is rock-salt, and this can be used in experiments on heat in the same way that glass is used in optical experiments. The phenomena of radiant heat are best explained by the undulatory theory, which assumes that they are caused by undulations in an imponderable medium filling all space; and they cannot be profitably studied until the student is acquainted with the mechanical theory of light. We shall, therefore, notice in this connection only a few familiar facts connected with the subject.

The unequal power which different bodies possess of radiating heat appears to depend on the condition of the surface, and not on the nature of the substance of which the body consists. As a general rule, the greater the density of the substance at the surface, the less is the radiating power of the body. Thus, the burnished surfaces of the metals are the poorest radiators, while the surfaces of paper and similar loose materials are the best. The very best radiator of all is a surface covered with lampblack. If we represent the radiating power of such a surface by 100, that of a silver surface, hammered and well burnished, will be only 3. Those surfaces which radiate heat the best also absorb it the most readily, and it has been proved that the absorbing power of a surface is equal to the radiating power, *if the difference between the temperature of the radiating and absorbing surfaces is not great.* On the other hand, the power which a surface possesses of reflecting heat is always in the inverse ratio of its power of absorption; that is, the best absorbents are the poorest reflectors, and the reverse. Hence heat is best reflected by surfaces of metals which have been hammered and polished; but so entirely does the power of reflecting or absorbing heat reside in the surface, that a sheet of gilt paper answers the purpose of a reflector nearly as

well as a mass of solid gold. The power which a surface has of absorbing heat varies with the nature of the source from which it emanates, while its radiating power remains constant; the two are equal only under the condition above stated. Hence it is not singular that, while the radiating power of any surface is unaffected by its color, the readiness with which bodies absorb the heat of the sun depends, in great measure at least, if not entirely, upon it. This last fact was noticed by Dr. Franklin. He placed pieces of the same kind of cloth, but of different colors, on the snow, where they were equally exposed to the direct rays of the sun. The black cloth absorbed the most heat and sunk deepest into the snow, while the white cloth produced but little effect. The other colored cloths produced intermediate effects; and they may be arranged according to their absorbing powers as follows: black, violet, indigo, blue, green, red, yellow, white.

Numerous illustrations of the above principles may be found in the familiar facts of every-day life. Water can be heated most rapidly in a dull iron kettle, whose bottom is covered with soot, while it can be kept hot longest in a bright silver teapot. The hot air from a furnace is best conveyed to the different apartments of a building in tinned iron pipes, which are poor radiators, while the smoke-pipe of a stove is best made of rough sheet-iron, for the opposite reason. The melting of a bank of snow is accelerated by sprinkling over its surface coal-dust, because its very feeble power of absorption is in that way greatly increased. Light-colored garments are preferable in summer, because they do not readily absorb the solar rays; in winter, when the object is to retain the heat in the body and prevent radiation, the color is unimportant.

The phenomenon of dew, first correctly explained by Dr. Wells, is another beautiful illustration of the principles of radiation. The earth is constantly radiating heat into space. During the daytime this loss is compensated by the constant supply of heat from the sun; but as soon as the sun sets, the supply ceases, while the radiation still continues. Consequently, the temperature of all objects on the surface exposed to the clear sky is rapidly reduced; if their temperature falls below the dew-point (313) of the atmosphere, dew is deposited upon them as on a glass of iced water, or, if the temperature falls below the freezing-point, the dew takes the form of hoar-frost. On cloudy nights, little or no

dew is deposited, because the clouds reflect back the rays of heat to the earth. The same effect is produced by the glass sashes or straw mattings which are used by gardeners to protect young plants from the late frosts of spring. The direct rays of the sun readily pass through the glass during the daytime, but the glass reflects back the heat of less intensity which is radiated from the earth during the night. On windy nights, also, little or no dew is deposited, because the layer of air in contact with the radiating crust of the earth is so frequently renewed that its temperature does not fall to the dew-point; and for the same reason dew is more copiously deposited in a valley or a sequestered dell than on the top of a hill; and it is in such places, also, that the early frosts of autumn are first felt. As we should naturally expect, we find that in any given place the dew is deposited most copiously on the best radiators, which are, at the same time, the poorest conductors; thus, while dew is deposited in abundance on the shrubs and the grass, which derive most benefit from the moisture, it is not wasted on the dry path and road, whose hard, beaten surfaces render them poorer radiators, while at the same time their higher conducting power enables them to withdraw heat from the strata below, and thus in part make good the loss which the radiation may have caused.

“In India, near the town of Hooghly, about forty miles from Calcutta, the principle of radiation is applied to the artificial production of ice. Flat, shallow excavations, from one to two feet deep, are loosely lined with rice straw or some similar bad conductor of heat, and upon the surface of this layer are placed shallow pans of porous earthen-ware, filled with water to the depth of one or two inches. Radiation rapidly reduces the temperature below the freezing-point, and thin crusts of ice form, which are removed as they are produced, and stowed away in suitable ice-houses until night, when the ice is conveyed in boats to Calcutta. Winter is the ice-making season, viz. from the end of November to the middle of February.”*

(320.) *Conduction.* — That dense and compact solids like the metals are good conductors of heat, while light and porous solids like wood and the various textile fabrics are poor conductors, is a matter of common experience. The general fact may be

* Miller's Elements of Chemistry, Part I. p. 201.

illustrated by means of the apparatus of Ingenhousz, represented in Fig. 451. The different rods attached to the front of the brass box, made of various materials, are covered with a thin layer of wax; and on turning boiling water into the box, the wax melts on the rods, after a certain time, to unequal distances, depending on their relative conducting power.

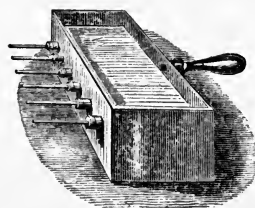

Fig. 451.

If we heat one end of a metallic rod with a lamp, as represented in Fig. 452, the temperature of the different parts of the rod will gradually increase, until a point is reached at which the heat lost by radiation is equal to the heat received from the flame by conduction through the bar. If now we test the temperature

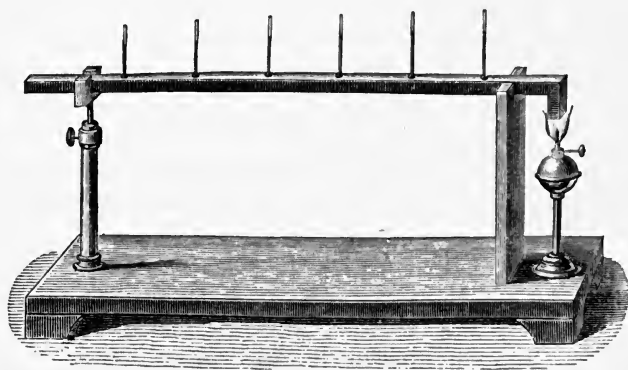

Fig. 452.

of the different parts of the bar by means of thermometers placed at equal intervals, say of one decimetre each, it will be found that it very rapidly decreases as we go from the source of heat; and if the distances from the source of heat increase in an arithmetical progression, the excess of the temperatures of the successive sections of the bar above the temperature of the air will be found to diminish in a geometrical progression. Moreover, it is evident that the rate of decrease will be more rapid in proportion as the conducting power of the bar is more feeble; and we can determine the relative conducting powers of two bars by measuring the distances from the source of heat of the sections which have the same temperature, for it can easily be proved

that the conducting powers are to each other as the squares of these distances. Experimenting in this way, and using a delicate thermo-electric pile for measuring the temperatures of the different sections of the bars, Messrs. Wiedmann and Franz determined the relative conducting powers of various metals, as follows:—

Silver,	100	Steel,	11.6
Copper,	73.6	Lead,	8.5
Gold,	53.2	Platinum,	8.4
Tin,	14.5	Rose's Metal,	2.8
Iron,	11.9	Bismuth,	1.8

The conducting power of stones, brick, and other earthy materials, is very much less than that of the metals, and the conducting power of wood and other organic tissues is so very feeble that they are usually regarded as non-conductors. It may be assumed as a rule, although it has many exceptions, that the denser a body the better it conducts heat.

Homogeneous solids and crystals belonging to the regular system conduct heat equally in all directions; but in crystals not belonging to the regular system, the conducting power varies in the direction of unequal axes. This fact is easily shown by a simple experiment devised by Senarmont. He took two slices of a quartz crystal (Fig. 453), one cut perpendicular to the vertical axis, and the other parallel to it; through the centre of each plate he drilled a small conical aperture for the reception of a silver wire, one end of which, heated in the flame of a lamp, served as a central source of heat. Previously to the application of the heat, he had covered the slices of the crystal with beeswax. He found that on the first the wax melted in the form of a circle round the wire, showing that quartz conducts heat equally in the direction of its equal and lateral axes; but on the second the wax melted in the form of an ellipse, whose longer diameter coincided with the vertical axis of

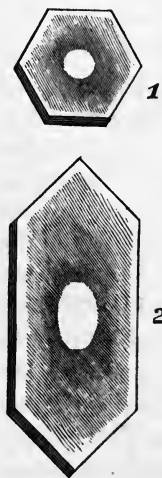

Fig. 453.

the crystal, which proved that the conducting power is greater

in this direction than in the one at right angles to it. Similar facts are also true of organized structures ; thus, wood conducts heat much better in the direction of its fibres than across them.

Count Rumford concluded, from his experiments, that liquids were absolutely non-conductors ; but later experiments have shown that they do conduct heat, but only very imperfectly. Despretz* experimented on a vertical column of water contained in a wooden cylinder one metre high and 21.8 c. m. in diameter, whose upper surface he exposed to a constant source of heat. By means of thermometers passing through tubulatures on the sides of the cylinder, he observed the temperatures of horizontal sections of the liquid at equal distances from each other. At the end of 32 hours the thermometers were stationary, and the differences between the temperatures indicated by the successive thermometers and the temperature of the air were found to form a decreasing geometrical series, as in a solid bar. This experiment proves conclusively that water conducts heat ; but, nevertheless, the conducting power is so feeble, that water may be boiled for many minutes at the top of a test-tube without occasioning the slightest inconvenience to the person who holds the lower end. Gases are still poorer conductors of heat than liquids ; but yet they are not absolutely non-conductors, and they differ very greatly from each other in this respect. This is proved by the fact that a hot body cools more rapidly in an atmosphere of hydrogen than in air, and also by a similar fact, first noticed by Grove, that a platinum wire can be made to glow in air with a feebler galvanic current than it can in hydrogen. In order to heat a mass of liquid or gas, we always apply the heat to the lowest portion of the containing vessel ; then, as already explained (268), currents are established by which the particles are brought into actual contact with the source of heat. This process is sometimes distinguished as a third method of communicating heat, and called *convection*.

(321.) *Illustrations*. — The laws of conduction furnish the explanation of many familiar facts, and receive many important applications both in the arts and in every-day life. Our sensations of heat and cold are very much influenced by the conducting power of the substances with which the body comes in contact.

* Annales de Chimie et de Physique, 3^e Série, Tom. LXXI.

A hearth, for example, feels colder to the bare feet than a wooden floor, and this, again, colder than a woollen carpet, even when all are at the same temperature. The obvious explanation is, that stone is a better conductor than either wood or wool, and therefore removes the heat from the body more rapidly. The body, if properly protected by poor conductors, may be exposed with impunity to air heated to 150° , while it would be burnt by contact with a rod of metal heated to only 50° . The oven-girls of Germany, protected by thick woollen garments, enter without inconvenience ovens where all kinds of culinary operations are going on, although the touch of any metallic articles while there would surely burn them.

Water in pipes laid at a slight depth under ground is not frozen during the severest winter, because the soil is a poor conductor; and iron safes are rendered fire-proof by making them with double walls, and filling the intervening space with non-conducting materials. Doors of furnaces, ladles, and teapots are provided with wooden handles, to protect the hand from the heated metal; and hot dishes are placed on woollen or straw mats, which prevent the polished surface of the table from being scorched. So also vessels of glass or porcelain are heated on a sand-bath, and when removed from the fire are always rested on some non-conductor, as they are liable to crack when suddenly heated or cooled.

The efficacy of clothing in preventing the escape of the heat of the body depends, not only on the non-conducting power of the material itself, but also on that of the air which is imprisoned by it. Hence it is that wool, fur, and eider-down, which retain large bodies of air within their texture, are so well adapted to protect the body against the extreme cold of winter. The order of the conductibility of the different materials used for clothing is as follows: linen, silk, cotton, wool, furs. Accordingly, cotton sheets feel warmer than linen ones, and blankets warmer than either. In summer, coarse linen goods are used, because they allow the heat to escape from the body more readily than other materials; while a dress of fine and close woollen is the best protection from the cold of winter except furs.

It is in consequence of the non-conducting property of gases, that double doors and windows, which include a layer of air between them, are so useful in preventing the heat of our houses

from escaping outwards; and the double walls of ice-houses, refrigerators, or water-coolers, for preventing the heat from entering. For the same reason, snow, which encloses large quantities of air, prevents the escape of the heat from the earth, and limits the penetration of frost. It is a well-known fact, that the ground always freezes deeper in winters without snow than when it abounds. But it is unnecessary to multiply these illustrations further.

(322.) *Coefficient of Conduction.*—The number of units of heat which pass in one second through a solid wall 1 m. m. thick and having an area of $1 \overline{\text{m}}^2$, when the difference between the temperatures of the two faces of the wall is equal to 1° , is called the coefficient of conduction of the substance of which the wall consists. The coefficient of conduction of lead was determined by Peclet by means of a very ingenious apparatus,* and found to be 3.82. From this, the coefficients of conduction of other solids can be calculated when their conductivity as compared with lead is known. We give, in the first column of the following table, the relative conductivity of several solids, as determined by Despretz; and in the second column, the coefficients of conduction, which have been calculated as just described. The results of Despretz, however, are not probably as accurate as those of Wiedmann and Franz, given above.

	I.	II.		I.	II.
Gold,	100.0	21.28	Tin,	30.39	6.46
Platinum,	98.1	20.95	Lead,	17.95	3.82
Silver,	97.3	20.71	Marble,	2.36	0.48
Copper,	89.8	19.11	Porcelain,	1.22	0.24
Iron,	37.4	7.95	Baked Clay,	1.14	0.23
Zinc,	36.3	7.74			

When the coefficient of conduction is known, we can easily calculate the amount of heat in units which will pass through a given metallic plate in a given time, by means of the following formula, which for want of space we must assume without proof.

$$C = K \cdot S \cdot \frac{t - t'}{E}. \quad [205.]$$

In this formula, K represents the coefficient of conduction, S the

* Annales de Chimie et de Physique, 3^e Série, Tom. II.

area of the plate, E its thickness, and t, t' the temperatures of its two faces. It is evident that the quantity of heat passing through such a metallic plate in a second of time increases in direct proportion with the conductivity of the metal, with the area of the plate, and with the difference of temperature between its faces; and it is also evident that the amount of heat diminishes in direct proportion to the thickness.

It has already been stated (305), that, in making boilers for evaporating water or other liquids, it is necessary to pay regard to the laws of conduction; and it is evident from the above formula that the greater the conducting power of the metals, the larger the area of the heating surface, and the thinner the boiler-plates, the more rapid will be the evaporation. Hence the advantage of copper over iron boilers, and also the reason that water will evaporate so much more rapidly in a silver dish than in one either of glass or porcelain.

CHAPTER V.

WEIGHING AND MEASURING.

(323.) *Recapitulation.* — Most methods of chemical investigation and all processes of *quantitative* chemical analysis involve the accurate determination of the amounts of small masses of matter, either by measure or by weight. The mass of a body, that is, the quantity of matter which it contains, is necessarily invariable; but its weight and its volume are liable to constant variations, arising from changes either of temperature or of the pressure of the atmosphere, and from other causes. It has been one great object of the present volume to develop the principles on which these variations depend, and to study the laws which they obey. We have thus been led to different methods by which the observed volumes and weights of bodies may be reduced to certain assumed standards, such as a temperature of 0° C. and a pressure of 76 c. m.; and it will be the object of the remaining chapter of this volume to illustrate these methods by a few examples.

SOLIDS.

(324.) *Weight.* — The weight of a solid is easily determined by means of the balance. The theory of this instrument has been already given at length (73), and the methods of using it are so simple and obvious that they need not be described in detail.* Were it not for the presence of the atmosphere, the balance would give at once the exact *relative weight* (71) of a body; but weighing the body, as we must, immersed in the air, the difference of the buoyancy which the air exerts on the weights and on the body may make the apparent weight slightly different from the actual weight. We can always, however, reduce the observed weight to the weight *in vacuo* by means of

* For the best methods of manipulating a delicate balance, and for the precautions required in accurate weighing, the student may consult the standard work of Fresenius on *Quantitative Analysis*.

[91], when either the volumes or the specific gravities of both the weights and the body are known. For this purpose, the heights of the barometer and thermometer are observed at the time of weighing, and from these observed data the weight of one cubic centimetre of air (w), required in making the reduction, is easily calculated by [215], or obtained by inspection from Table XIV. In weighing either solids or liquids, however, the correction for the buoyancy of the atmosphere is at best very small, and may be entirely neglected except in the very few cases where the greatest refinement is required; as, for example, in adjusting standard weights. For the method to be followed in such cases, the student will do well to consult the admirable memoir of Professor Miller* on the restoration of the English standards.

(325.) *Specific Gravity.* — The specific gravity of a substance has been defined as the ratio of its weight to that of an equal volume of pure water at 4° , the temperature at which the volume of the solid is measured being 0° . The general methods by which the specific gravity of solids is determined have been already described (144–146), and we have only to consider the methods by which results obtained at other temperatures may be reduced to the standard temperatures.

In order to obtain the specific gravity of a solid, we determine, in the first place, the relative weight (W) of the body; and when very great accuracy is required, the weight observed in the air may be reduced as just described. We next seek, by one of the methods of (145) and (146), the weight of pure water (W') displaced by the body when the temperature of the water is 4° , and that of the solid 0° ; and, lastly, we calculate the specific gravity by dividing the first weight by the last. Practically, the value of W' is always determined at some temperature, t° , higher than the standard temperatures, and the same for both solid and water; and, before using it in calculating the specific gravity, it is necessary to determine what would be its value assuming that the water was at 4° and the solid at 0° . In Table XVI. we have given the specific gravity of water at different temperatures referred to water at 4° as unity. Representing, then, the specific gravity at t° by δ , and also the weight of water displaced respectively at t° and 4° by W_t and W_{4° , we shall

* Philosophical Transactions, Part III. London, 1856.

have, evidently, (assuming that the volume of the solid is invariable,)

$$W_{4^{\circ}} : W_{t^{\circ}} = 1 : \delta, \quad \text{or} \quad W_{4^{\circ}} = W_{t^{\circ}} \frac{1}{\delta}. \quad [206.]$$

But the volume of the solid is not invariable, and it displaces at 0° (the standard temperature for the solid) less water than at t° . Representing the volumes of the solid at 0° and t° by $V_{0^{\circ}}$ and $V_{t^{\circ}}$ respectively, we have, by [166], $V_{0^{\circ}} = V_{t^{\circ}} \frac{1}{1 + Kt}$. Since the two weights of water displaced by the solid when at 0° and t° must be proportional to the volumes of the solid at these temperatures, (assuming now that the temperature of the water is invariably at 4° ,) we shall also have $W_{4^{\circ}} : W'_{4^{\circ}} = V_{t^{\circ}} : \frac{V_{t^{\circ}}}{1 + Kt}$. Hence, and by [206],

$$W'_{4^{\circ}} = W_{t^{\circ}} \cdot \frac{1}{\delta} \cdot \frac{1}{1 + Kt}. \quad [207.]$$

Having thus obtained the weight of water at 4° displaced by the solid at 0° , this value, $W'_{4^{\circ}}$, is to be used in place of W' in [87]. The last factor of [207] is always very nearly unity, and can in most cases be neglected without appreciable error. When the coefficient of expansion is not accurately known, and great accuracy is required, the value of K may be eliminated from [207] by making two determinations of the weight of water displaced at temperatures differing as widely from each other as the circumstances will permit. In very accurate determinations the temperature of the water should be observed to the tenth of a Centigrade degree; and if the value of δ is not given in the table for the observed temperature, it can easily be determined by interpolation. Compare (289).*

* The most accurate method of determining the specific gravity of a solid is the one with the hydrostatic balance (146), which should always be used when the nature of the substance will admit of it. The body is best suspended from the pan of the balance by a single fibre of silk, or by a very fine human hair, and the temperature of the water observed by means of a very delicate thermometer, adjusted so that the bulb may be nearly in contact with the body, and so that the division may be read by a telescope placed outside of the balance-case. When the solid is in powder, it can be supported under water in a small glass cup suspended to the pan of the balance by a platinum wire. In this case, it is necessary to weigh, first, the cup under water, immersed to a point marked on the platinum wire. We then weigh the cup containing

(326.) *Volume.* — The volume of a solid can rarely be determined with accuracy by direct measurement. It is therefore generally calculated from the weight and the specific gravity by means of the formula [56]. Several examples of such calculations have already been given among the problems.

the powder immersed to the same point, taking care that the temperature is the same as before. The difference between these weights is, evidently, the weight of water displaced by the solid at the observed temperature, which must be reduced to the standard temperatures by [207]. Lastly, we wash the powder into a tared beaker-glass, evaporate the water, and determine the weight of the solid. The only objection to this method of experimenting arises from the fact that the resistance of the water to the motion of the cup renders the balance less sensitive and prompt in its indications.

When the solid is in powder, very accurate results can be obtained with a specific-gravity bottle (145). The neck of the bottle should be made with a thick rim, ground square at the top, and the glass stopper should be so fitted as not to have a channel between the two in which water can collect. In order to determine its specific gravity, a known weight, W , of the powder is introduced into the bottle with water, and after the entangled air has been removed by an air-pump, the bottle is suspended in a large beaker of water whose temperature is very slightly higher than that of the room. This temperature, t , is carefully observed by means of a delicate thermometer, whose bulb is placed near the bottle. After an equilibrium is established, the stopper is inserted into the neck of the bottle while it is still under water. The bottle can then be removed, and, after having been wiped dry, weighed at leisure. This is the weight W_2 of [86]. For every specific-gravity bottle, we determine once for all the weight, W_0 , of water which it contains at 0° . This is a constant for that bottle, and from it we can easily calculate the weight of the bottle filled with water at t° , or W_1 , by the formula,

$$W_1 = W' + W_0 (1 + Kt) \delta, \quad [208.]$$

in which W' is the weight of the glass, K the coefficient of expansion of glass, and δ the specific gravity of water at t° , referred to water at 0° as unity, as given by Table XVI. The weight of the water displaced at t° is now determined by the formula

$$W'_{t^\circ} = W_1 + W - W_2,$$

which is then reduced to the standard temperature by [207].

The chemist frequently has occasion to determine the specific gravities of solids which are soluble in water. For this purpose he selects some inactive liquid, such as alcohol, glycerine, or oil of turpentine, and first finds, by one of the methods just described, the weight of this liquid displaced by the body, exactly as when using water, the temperature being carefully observed. He then determines the specific gravity of the liquid used at the same temperature as before, and from these data easily calculates the specific gravity of the solid. The student will be able to devise a formula for the purpose.

In all delicate determinations of specific gravity it is essential to use several grammes of the substance, since otherwise a very small error in the weighing will cause an important error in the result. It is also essential to remove any air which may be entangled in the interstices or cavities of the solid. This can be done either by boiling the liquid in which the solid is immersed, or by placing the vessel containing the liquid and solid under the receiver of an air-pump and exhausting the air.

LIQUIDS.

(327.) *Weight and Specific Gravity.*—The weight of a liquid can be most accurately determined by direct weighing, and the weight of the liquid in the atmosphere may be reduced to the weight *in vacuo* exactly as in the case of solids; only the tare of the flask in which the liquid is enclosed must be taken under the same circumstances of temperature and pressure as those under which the liquid is weighed. Such niceties, however, are very rarely necessary.

The specific gravity of a liquid determined at an observed temperature, t ,* by either of the methods described in (145) and (146), can easily be reduced to the standard temperature when the law of expansion of the liquid is known. For this purpose, we first calculate the volume of the liquid at t° (V_t), the volume at 0° being unity, by means of the empirical formula expressing the law of expansion (255); and since the specific gravity at different temperatures must be inversely as the volume, we have

$$V_t : 1 = (\text{Sp. Gr.})_{0^\circ} : (\text{Sp. Gr.})_t,$$

and

$$(\text{Sp. Gr.})_{0^\circ} = (\text{Sp. Gr.})_t V_t.$$

[209.]

In most cases with which the chemist meets in practice, however, the law of expansion is not known. It is then best to determine by direct experiment the specific gravity of the liquid at the standard temperature. An apparatus invented by Regnault (Fig. 454) may be used with advantage for this purpose. It is merely a specific-gravity bottle, so shaped that it can readily be surrounded by melting ice and the volume of the liquid measured with great accuracy. It is, in the first place, filled, like a thermometer-tube, with the liquid to be examined, which is then cooled to 0° by surrounding the apparatus supported on its stand with pulver-

* By "specific gravity of a liquid at the temperature t " is meant the weight of the liquid divided by the weight of an equal volume of water, the liquid being measured at t° and the water at 4° . In using a specific-gravity bottle (145), we have only to determine for each substance the weight, W , of liquid which exactly fills the bottle at t° . Having previously determined, once for all, the weight of water at 4° which the bottle will contain at the same temperature, we can easily calculate by [166] the weight of water at 4° which the bottle would hold at t° . In using the hydrostatic balance, the results may be reduced in a similar way.

ized ice. After an equilibrium of temperature is established, the

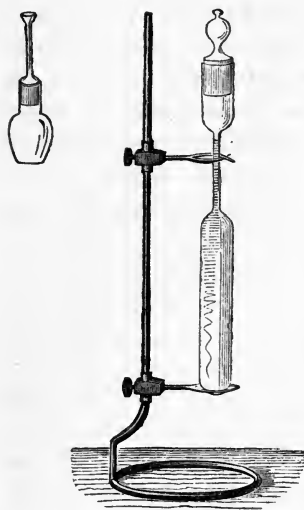

Fig. 454.

excess of the liquid is removed with bibulous paper, until the liquid stands at a point marked on the fine tube which forms the neck of the bottle. The apparatus is now closed with its glass stopper, and it may then be removed from the ice, wiped dry, and weighed at leisure. By subtracting from this weight the tare of the glass and the brass stand, we obtain the weight of liquid which the apparatus holds at 0° , which, divided by the weight of water it contains at 4° (previously determined), gives the exact specific gravity.

(328.) *Volume.* — The volumes of liquids are generally determined by direct measurement. For this purpose a great variety of graduated glasses are used, which are described in detail in most works on Chemical Manipulation or Chemical Analysis.* These instruments for chemical purposes are usually graduated in cubic centimetres, and are only standard at 0° . The process of measurement is, however, seldom so accurate as to make it important to regard the change of volume which the glass undergoes from changes of temperature. The same, however, is not true in regard to the liquid itself; where great accuracy is required, it is important to observe the temperature at which the measurement is made, and to reduce the observed volume to the standard temperature by means of the empirical formula (255), which expresses the law of expansion of the given liquid.

The volume of a liquid can be determined with greater accuracy by [56]; that is, by dividing the weight of the liquid by its specific gravity for the temperature at which the volume is required. This method is frequently used, in chemical investigations, for measuring the volume of a glass vessel. For this pur-

* A very complete description of this class of instruments will be found in Dr. Mohr's *Titrimethode*.

pose, we determine with a delicate balance the weight of mercury or distilled water which the vessel contains at an observed temperature. This weight, divided by the specific gravity of mercury or water for the given temperature, gives the volume of the vessel at that temperature. If the weight is accurate to one centigramme, the volume may thus be measured within the thousandth or the hundredth of a cubic centimetre, according as mercury or water was used in the determination. Knowing now the volume of the vessel at a given temperature, t , and also the coefficient of expansion of glass (245), we can easily calculate by [167] the volume at any other temperature (241).

GASES AND VAPORS.

(329.) *Weight.* — The weights of equal volumes of the best known gases and vapors have been determined with great care by several experimenters, and it is now seldom necessary to repeat the determination. Those of air, oxygen, nitrogen, hydrogen, and carbonic acid were determined by Regnault, and are among the most accurate constants of science. The method which he used will serve to illustrate the general method followed in such cases.

Regnault weighed the gases in a large glass globe, whose volume, V , had been measured in the way just described. In order to avoid the always uncertain correction made necessary by changes in the buoyancy of the atmosphere during the course of the experiments, he equipoised this globe by another globe of the same size and made of the same kind of glass (see Fig. 258); so completely did this simple provision effect its object, that in one experiment he saw the equilibrium maintained during fourteen days, in spite of great change in the temperature, pressure, and moisture of the air. The experiments were conducted in the following way. The globe, having been surrounded with melting ice (Fig. 455), and connected by a lead tube with the manometer $t t'$ and also with an air-pump through the branch tube $a m$, was first filled with perfectly pure and dry gas. This was

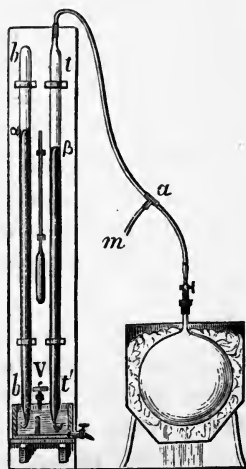

Fig. 455.

effected by exhausting it several times, and, after each exhaustion, connecting it with the vessel in which the gas was generating through a series of U tubes, by which the crude gas was dried and purified. The globe was then exhausted again as perfectly as possible, and the tension of the small amount of gas remaining in it ascertained by measuring the height $\alpha\beta$ with a cathetometer. Represent this by h_0 . This measurement having been made and the stopcock closed, the globe was disconnected from the manometer, removed from the ice, and, having been carefully cleaned, suspended to one pan of a very strong and delicate balance, and counterpoised by a second globe as above described. The globe was then returned to its first position, and the connection having been made as before, it was again filled with the same gas under the pressure of the air. Represent the pressure, as given by the barometer, by H_0 . Lastly, the globe was a second time suspended from the balance, and the increase of weight determined, which we will call W . This evidently was the weight of a volume of gas equal to the volume of the globe measured at 0° , and under a pressure of $H_0 - h_0$. The weight of one cubic centimetre of the gas at 0° , and under a pressure of 76 c. m., was then calculated by the formula,

$$w = W \cdot \frac{1}{V} \cdot \frac{760}{H_0 - h_0}. \quad [210.]$$

The results obtained by Regnault were as follows:—

Name of Gas.	Specific Gravity.	Weight of 1 Litre measured at 0° and 76 c. m.
Air,	1.00000	1.293187
Nitrogen,	0.97137	1.256167
Oxygen,	1.10563	1.429802
Hydrogen,	0.06926	0.089578
Carbonic Acid,	1.52901	1.977414

It was discovered by Gay-Lussac, that all gases combine with each other in very simple proportions by volume. This remarkable law will be considered at length in another portion of this work. It is sufficient for the present to say, that it gives us the means of calculating from the weight of one litre of oxygen the weight of one litre of any other gas when the chemical equivalent and the combining volume are known. In this way the values given in the fifth column of Table II. have been calculated. They are not exactly equal to those obtained by direct experiment, probably because the different gases are unequally compressed by the weight of the atmosphere. The actual weights as observed can always be obtained by multiplying the "specific

gravity by observation," given in Tables III. and IV., by 1.29206. the weight of one litre of air.

The weight of one litre of a vapor at 0° and 76 c. m. is of course a fiction, since all those gases generally known as vapors (292) would be condensed to liquids under these conditions of temperature and pressure. It is convenient, however, in many calculations, to know the weight which one litre of a vapor would have at the standard temperature and pressure, assuming that it could retain its aeriform condition under these circumstances; the weights of the vapors are therefore given in Table II. in connection with those of the gases.

Knowing, then, the weight of one litre, and hence also of one cubic centimetre, of all the more important gases and vapors at 0° and at 76 c. m., when perfectly dry, we can easily calculate from these constants the weight of one cubic centimetre of any of these gases when saturated with aqueous vapor, and at any given temperature and pressure. The following formula for the purpose is easily deduced from [100], [184], and [203], remembering that the weight of one cubic centimetre of any given mass of gas must be inversely as its volume.

$$w' = w \cdot \frac{1}{1 + 0.00366 t} \cdot \frac{H_0 - h}{76}. \quad [211.]$$

This formula gives the weight of the gas only, not including the weight of aqueous vapor mixed with it; if the gas is dry, h becomes 0, and of course disappears. Using the weight of one litre of aqueous vapor at 0° and 76 c. m. given in Table II., we can easily calculate by [211] the weight of one cubic metre of aqueous vapor at different pressures and temperatures. It was in this way that the values given on page 571 were obtained. They are not absolutely accurate, because, as we have before seen, the vapor deviates from the law of Mariotte before reaching its maximum tension, while the formula assumes that it strictly obeys the law.

The weight of one cubic centimetre of a gas depends, to a slight extent, on still another cause not yet considered, namely, the variations in the intensity of the force of gravity over the surface of the earth. What the effect of such variation must be can easily be seen by taking an assumed case. Suppose, then, that the intensity of the earth's attraction were exactly doubled, it is evident that the total weight of the atmosphere, and hence

its pressure, would be doubled. Moreover, the density of all gases exposed to this pressure would be doubled also; and all this change would take place without any variation in the height of the barometer; for although the pressure of the air would be thus increased, the weight of the mercury-column which measures this pressure would be increased in the same proportion. A similar effect to this, although only to a very slight extent, is produced by the small variations in the force of gravity on the earth's surface. Other things being equal, the *relative weight* of one cubic centimetre of a gas at different places is proportional to the force of gravity at these places.

$$w : w' = g : g' \quad \text{and} \quad w' = w \frac{g'}{g}. \quad [212.]$$

The weights determined by Regnault, and given on page 668, are only exact for Paris,* where $g = 9.8096$; but from these the weight for any other latitude or elevation can easily be calculated by [40] and [47]. The weights given in the fifth column of Table II. were calculated for the latitude of the Capitol at Washington ($38^\circ 53' 34''$) and the sea level. They can be reduced for any other place by the following formula, easily derived from [212], [40], and [47]:—

$$w' = w \frac{1 - 0.00259 \cos 2 \lambda}{0.99945 \left(1 + \frac{2h}{6370284}\right)}; \quad [213.]$$

but such reduction is seldom necessary.

(330.) *Specific Gravity of Gases.*—It is usual to refer the specific gravity of gases to air, as a standard of comparison, instead of water, and the specific gravity of a gas may be defined as the ratio of its weight to that of an equal volume of dry air, both being measured at 0° and under a pressure of 76 c. m.

Regnault's Method.—The most accurate method of determining the specific gravity of a gas is due to Regnault. It consists in determining with the apparatus described above (329) the weight of the given gas which a large glass globe will contain at 0° and 76 c. m., and then dividing this weight by that of an equal volume of air previously determined in the same way. This method requires no further description, as the process of determining the weight of the gas has already been given in detail. It admits of great accuracy, and should always be used in normal determinations.

* The latitude of Regnault's laboratory, at Paris, is $48^\circ 50' 14''$, and the elevation above the sea level about 60 metres.

Bunsen's Method. — When, however, the very greatest accuracy is not required, as in the investigations usually made in the laboratory on gaseous bodies, their specific gravity can be obtained by dividing the weight of the gas by the weight of the same volume of dry air taken at the same temperature and under the same pressure. This ratio is, strictly speaking, the specific gravity only when the gas obeys exactly the law of Mariotte, and has the same coefficient of expansion as air; but it is, nevertheless, in most cases near enough for all practical purposes. Bunsen's method* is an application of this principle. He employs, for determining the specific gravity of a gas, a common light flask, *g*, Fig. 456. The vol-

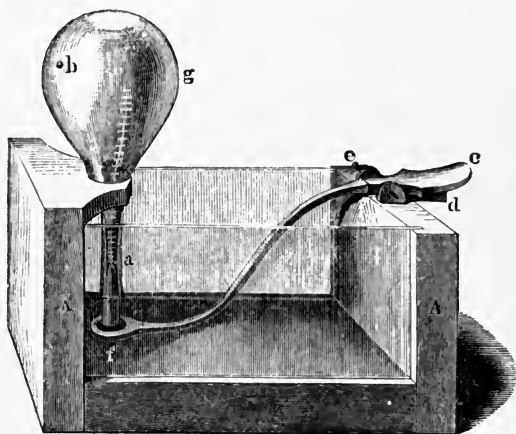

Fig. 456.

ume of this flask should be about 200 or 300 cubic centimetres, and the neck, *a*, thickened before the blowpipe, should be drawn out so as to have an aperture of the thickness of a straw, into which a glass stopper is ground air-tight by means of emery and turpentine. Through this neck, which is furnished with an etched scale in millimetres, mercury is poured by means of a funnel reaching to the bottom of the flask, until the whole is filled. As soon as this is accomplished, the flask is transferred, with its mouth downwards, into the mercury-trough *A A*, and gas is allowed to enter, until the level of mercury in the neck of the flask stands a few millimetres higher than in the trough. In order to prevent the gas from becoming mixed with air, it is evolved from as small a vessel as possible, and allowed to enter the flask through a narrow delivery tube, and in the moist state.† The gas is dried in the flask itself by a small piece of fused

* This description is taken from Bunsen's *Gasometry* (Roscoe's translation), varying only the method of computing the results.

† If the gas under examination corrodes mercury, the flask cannot be filled in this

chloride of calcium, b , which has previously been made to crystallize on the side of the flask by bringing it into contact with a single drop of water and alternately heating and cooling the glass. This small piece of chloride of calcium serves also to free the mercury and the sides of the flask from all adhering moisture. In order to be able to close the flask at any time without warming it with the hand, the little lever cf is employed. On the end of this lever the stopper is so fastened in a cork, that it passes into the neck of the flask without closing it; and the lever is held in its right place by a wedge, d , pushed under the finger-plate c . As soon as the flask has attained the constant temperature, t , of the laboratory,* the volume † of the gas, V , the height of the barometer, H_0 , and the height, h_0 , of the column of mercury in the neck above the level of the metal in the trough, are carefully observed. It is now necessary to determine the weight of this volume V . For this purpose, the wedge d is taken away; the flask g is thereby closed, and by withdrawing the pin e , it can then be removed, together with the lever cf , from the trough. Having disconnected the lever from the stopper, and carefully cleaned the exterior surface

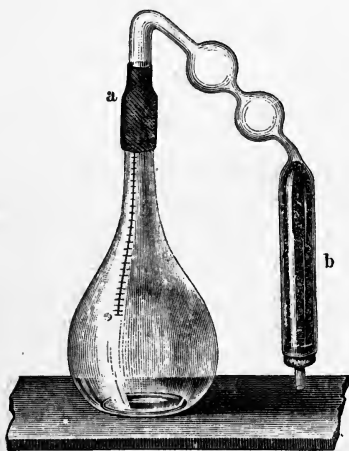

Fig 457.

of the flask, it is then weighed. Let W represent this weight, H'_0 the height of the barometer, and t' the temperature of the balance at the time. The glass stopper is now removed, and replaced by an india-rubber tube, a , Fig. 457, connected with a drying tube, b . The apparatus thus arranged is placed under the receiver of an air-pump, and, by alternately exhausting and admitting the air, the gas in the flask is replaced by dry air. The drying apparatus is then disconnected, and the flask weighed again. Call this weight W' . Since the air has free access both to the inte-

way; but since such gases are almost invariably heavier than air, it can be filled by displacement. The flask being placed in an upright position, and the delivery tube extending quite to the bottom, the gas is allowed to flow in and overflow the mouth until all the air has been expelled. The tube is then slowly withdrawn, the flow of gas still continuing, and the mouth of the flask closed by its stopper.

* These experiments should be conducted in a cellar-room, in which a constant temperature can be maintained for several hours.

† Before using the flask, it is once for all carefully calibrated, and the volume corresponding to each division on the neck inscribed in a table, which is kept with the instrument.

rior and the exterior surface of the flask, it is evident that W' is simply the weight of the glass of the vessel and of the small amount of mercury and chloride of calcium which it contains, less the weight of air which these materials displace. It is also evident that W must be equal to W' increased by the weight of the volume of gas, V , contained in the flask, and diminished by the weight of air displaced by this volume of gas when the flask was weighed. The weight of the gas is, then, equal to $W - W' + W''$; in which W'' is the weight of V cubic centimetres of dry air at t° and H'_0 c. m., calculated by [211]. To obtain the specific gravity, we have now only to divide the weight of the gas by the weight of an equal volume of air measured under the same conditions of temperature and pressure at which the gas was measured, that is, at t° and $(H_0 - h_0)$ c. m. This can also be calculated by [211]. Representing then this last weight by W''' , we have for calculating the specific gravity the three following equations:—

$$\text{Sp. Gr.} = \frac{W - W' + W''}{W''}; \quad [214.]$$

$$W'' = 0.0012921 V \frac{1}{1 + 0.00366 t'} \cdot \frac{H'_0}{76}; \quad [215.]$$

$$W''' = 0.0012921 V \frac{1}{1 + 0.00366 t} \cdot \frac{H_0 - h_0}{76}. \quad [216.]$$

As an example of the method of calculation, we cite the following from Bunsen's work. A determination of the specific gravity of bromide of methyl, with a small flask of about 44 c. m.³ capacity, furnished the following data:—

$$\begin{array}{llll} W = 7.9465 \text{ gram.} & H'_0 = 74.21 \text{ c. m.} & V = 42.19 \text{ c. m.}^3 & H_0 = 74.64 \text{ c. m.} \\ W' = 7.8397 \text{ " } & t' = 6^\circ.2 & t = 16^\circ.8 & h_0 = 2.43 \text{ " } \end{array}$$

<i>Calculation of W''.*</i>		<i>Calculation of W'''.*</i>	
$(1 + 6^\circ.2k)$	ar. co. 9.99025	$(1 + 16^\circ.8k)$	ar. co. 9.97409
$H'_0 = 74.21$	log. 1.87046	$H_0 - h_0 = 72.21$	log. 1.85860
76.	ar. co. 8.11919		8.11919
$V = 42.19$	log. 1.62521		1.62521
0.0012932	log. 7.11166		7.11166
$W'' = 0.052092$	log. 8.71677	$W''' = 0.048837$	log. 8.68875
$W - W' + W'' =$	0.158892		log. 9.20110
	Specific gravity of Bromide of Methyl, 3.253		log 0.51235

* The values of W'' and W''' can be calculated much more rapidly, although with less accuracy, by means of Table XIV.

(331.) *Specific Gravity of Vapors.** — As will appear in another portion of this work, the determination of the specific gravity of vapors is one of the most important processes of practical chemistry. We always make the determinations at a temperature considerably above the boiling-point of the substance; † and since under these circumstances a vapor has all the properties of a gas (292), it follows that its specific gravity may be found by dividing its weight by the weight of an equal volume of air measured under the same conditions of temperature and pressure. The method of determining these two weights usually followed in the case of vapors is precisely similar to that used in the case of gases and described in the last section, and the same formulæ may be used in calculating the results. It differs from it only in the details of the manipulation, and in the fact that, on account of the high temperature to which the vapor is heated, it is necessary to take into account the change in the

* We use the term *vapor* here in its ordinary sense.

† The number of degrees above the boiling-point at which a vapor first acquires fully the properties of a permanent gas varies very greatly with different substances. Thus, under the normal pressure of the air, the vapors of water and alcohol obey the law of Mariotte at a temperature only a few degrees above their boiling-points, while the vapor of sulphur does not obey the law until heated to at least 500° above its boiling-point. Unless the experimenter is confident in regard to the properties of the substance under examination in this respect, it is best to make two determinations of the specific gravity at temperatures differing by twenty or thirty degrees. If the two do not agree within the limit of error of the method employed, it is an indication that the temperature is not sufficiently high. This is illustrated by the experiments of Cahours on the specific gravity of the vapor of monohydrated acetic acid. He found that the specific gravity did not become constant until the temperature rose above 240° C., that is 120° above its boiling-point. The following table contains his results: —

Temp.	Sp. Gr.	Temp.	Sp. Gr.
125°	3.180	200°	2.248
130	3.105	220	2.132
140	2.907	240	2.090
150	2.727	270	2.088
160	2.604	310	2.085
170	2.480	320	2.083
180	2.438	336	2.083
190	2.378		

It is evident that a determination of the specific gravity of the vapor of acetic acid made at a temperature below 240° would have given too large a result, and one which would have been the more erroneous as the temperature was lower. An error of the same kind, made in the determination of the specific gravity of the vapor of sulphur, introduced an anomaly into the simple law of equivalent volumes which has only recently been explained.

capacity of the vessel used. The method may be best explained by an example. Suppose, then, that we wish to ascertain the specific gravity of alcohol vapor.

We take a light glass globe having a capacity of from 300 to 500 $\overline{\text{c.m.}}^3$, and draw the neck out in the flame of a blast lamp, so as to leave only a fine opening, as shown in Fig. 458 at *a*. We then weigh the globe, which

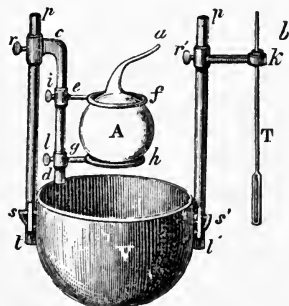

Fig. 458.

gives us the weight W' of [214]. The second step is to ascertain the weight of the globe filled with alcohol vapor at a known temperature and under a known pressure. For this purpose, we introduce into the globe a few grammes of pure alcohol, and mount it on the support represented in the figure. By loosening the screw, *r*, we next sink the balloon beneath the oil contained in the iron vessel, *V*, and secure it in this position. We now slowly raise the temperature of the oil to between 300° and 400° , which we observe

by means of the thermometer, *T*. The alcohol changes to vapor and drives out the air, which, with the excess of vapor, escapes at *a*. When the bath has attained the requisite temperature, we close the opening *a* by suddenly melting the end of the tube at *a* by means of a mouth blowpipe, and as nearly as possible at the same moment observe the temperature of the bath and the height of the barometer. We have now the globe filled with alcohol vapor at a known temperature and under a known pressure. Since it is hermetically sealed, its weight cannot change, and we can therefore allow it to cool, clean it, and weigh it at our leisure. This will give us the weight of the globe filled with alcohol vapor at a temperature *t* and under a pressure *H*. This is the weight W'' of [214]. We also notice the height of the barometer H' and the temperature of the balance-case t' during this second weighing, and when we have measured the capacity of the globe *V*, we can easily calculate by [215] the value of W''' . Knowing now $W - W' + W''$, the weight of alcohol vapor which filled the globe at t° and under a pressure *H* c. m., the next step is to find W''' , the weight of an equal volume of air under the same conditions of temperature and pressure. By (241) the volume of the globe at the temperature *t* was $V(1 + Kt)$, and by substituting this in [216], we get at once, since $h_0 = 0$,

$$W''' = 0.0012932 V (1 + Kt) \frac{1}{1 + 0.00366t} \cdot \frac{H_0}{76}, \quad [217.]$$

by which we can easily determine the weight required. The last step is

to find the capacity of the globe, which, although we have supposed it known, is not actually ascertained experimentally until the end of the process. For this purpose we break off the tip of the tube *a* under mercury, which, if the experiment has been carefully conducted, rushes in and fills the globe completely. We then empty this mercury into a carefully graduated glass cylinder, and read off the volume. We have now all the data for calculating the specific gravity, and the calculation may be conducted precisely as on page 673, only substituting [217] for [216].

We have assumed that the vapor expelled all the air from the globe, and hence that the globe filled completely with mercury on breaking the tip end of the neck. This, however, is rarely the case; there is almost always left in the globe a bubble of air, and sometimes the volume of air remaining is quite considerable. In such cases, however, we may still obtain approximately accurate results; it is only necessary to decant the air into a graduated bell over a pneumatic trough, and measure exactly its volume, *v*, at an observed temperature, *t''*, and under a pressure of *H''*. Its weight, *W*₁, can now be calculated by [215], and from this weight we readily deduce the weight of vapor which the globe contained at the moment of closing its orifice; this weight of vapor was evidently *W* - *W'* + *W''* - *W*₁. The volume which the small amount of air left in the globe occupied at the moment of closing the orifice (that is, at *t*^o and *H* c. m.) can also be calculated from the formula,

$$v' = v \frac{1 + 0.00366t}{1 + 0.00366t''} \cdot \frac{H''_0}{H_0}, \quad [218.]$$

which can readily be deduced from [98] and [184]. The volume of the balloon at this time was, as we have seen, *V*(1 + *Kt*). Hence the volume of the vapor must have been *V*(1 + *Kt*) - *v'*. Substituting this value for *V*(1 + *Kt*) in [217], we get for the weight of the vapor in the globe at the time of closing,

$$W_2 = 0.0012932 [V(1 + Kt) - v'] \frac{1}{1 + 0.00366} \cdot \frac{H_0}{76}; \quad [219.]$$

and for the specific gravity,

$$\text{Sp. Gr.} \frac{W - W' + W'' - W_1}{W_2}. \quad [220.]$$

The results which are thus obtained are not, however, perfectly trustworthy, and it is always best to avoid these corrections by so conducting the experiments that only a very small amount of air at most shall be left in the globe. This end is secured by adapting the size of the globe to the quantity of liquid which is available for the determination.

In calculating the specific gravity of a vapor from the observed data, we

must be careful, in the first place, to reduce all the barometric heights to 0° by Table XVIII. In the second place, the temperature of the bath, as indicated by the mercury-thermometer, must be corrected for the part not immersed [156], and the corrected temperature reduced by the table on page 439 to the true temperature. When great accuracy is required, it is best to measure the temperature of the bath directly with an air-thermometer. This is immersed in the oil at the side of the globe, and the orifices of both thermometer and globe are closed at the same time (264). In computing the results, we use the formula [189], and without actually calculating the temperature, substitute the value of $\frac{1 + Kt}{1 + 0.00366t}$ in [217].

We have assumed that the bath in which the globe is heated is filled with a fixed oil, which is the most convenient liquid if the temperature required does not exceed 250° . When heated above this temperature, the fat oils emit very disagreeable vapors; and for temperatures between 250° and 500° it is necessary to fill the bath with some easily fusible alloy, such as Rose's metal or soft solder. The pressure exerted by the melted metal is necessarily very great, and tends to deform the globe, so that we are obliged to abandon this method of experimenting as soon as the glass begins to soften, which takes place a little above 500° . By slightly modifying the apparatus, however, Regnault has been able to obtain accurate results at temperatures as high as 600° or 650° . His method, which is only used for substances which boil at a very high temperature, is as follows.

The volatile substance is introduced into the cylindrical reservoir $a' b'$ (Fig. 459) of the tube $a' d$, which is made of the most infusible glass, and supported in an iron frame, $m m' m''$, at the side of a similar tube, $a b$. This last tube, which may be closed by the stopcock r , serves as an air-

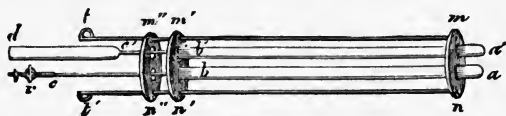

Fig. 459.

thermometer. The two tubes are heated together in an air-bath, made, as represented in Fig. 460, of two or three concentric cylinders of sheet-iron enclosed in an outer cylindrical case of cast-iron. The frame $m m'$ fits the inner cylinder $f g h i$, and when in place the metallic disk $m'' n''$ just closes its mouth, $f i$, leaving the ends of the two tubes projecting in front of the bath. This apparatus is heated in a horizontal position on a semi-cylindrical grate, and so arranged that it can be surrounded with burning coals. The temperature is first rapidly raised; but after the volatile substance has distilled over and the excess has been collected in the cold portion of the tube $c' d$, the temperature is increased very slowly, and before

the glass softens, the process is arrested by closing the stopcock of the air-thermometer and withdrawing the frame with its two tubes from the bath. We now determine the temperature to which the tubes were heated, by

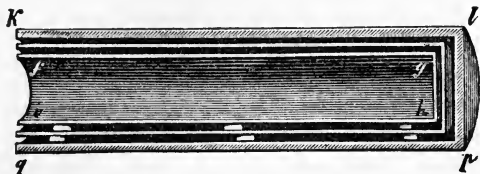

Fig 460.

the method already described in detail (265). We next ascertain the weight of vapor which was contained in the reservoir $a' b'$ at the moment of withdrawing the tube from the air-bath. For this purpose we remove the excess of the substance which condensed in the part of the tube $c' d$, and then weigh the whole tube, first with the substance it contains, and secondly after the substance has been removed. The difference of these weights is the weight of the vapor which filled the reservoir $a' b' c'$ at a known temperature and pressure. Lastly, to find the volume of the reservoir, we determine the weight of water which fills it at a known temperature; and we then have all the data for calculating the specific gravity of the vapor. The formulæ already given may be easily modified for the purpose. If the substance under examination absorbs oxygen at a high temperature, it is best to fill the whole tube $a' d$ with nitrogen, and to adapt with a cork to the open end a small tube drawn to a point.

The use of the air-thermometer (which involves a great expenditure of time) in the determination of the specific gravity of vapors of substances which boil at a high temperature, is avoided in another modification of the general method proposed by Deville and Troost. They use a glass balloon, and heat it in an atmosphere of vapor rising from boiling mercury or sulphur. The temperature of these vapors is so constant, that it is not necessary to use a thermometer,—that of the first at 350° , and that of the second at 440° . For still higher temperatures they use a balloon of porcelain, which is heated in the vapor of boiling cadmium (860°) or boiling zinc (1040°); but for the details of the apparatus and of the method, we must refer to the original papers.*

Method of Gay-Lussac.—The method of determining the specific gravity of vapors just described is liable to one very serious source of error. In order to insure that all the air will be expelled from the globe, it is necessary to use a considerable amount of liquid; and it is evident that any impurity which this liquid may contain will be left behind in the globe, and tend to falsify the weight. This source of

* Comptes Rendus, Tom. XLV. p. 821; also Tom. XLIX. p. 239.

error is entirely avoided by a method invented by Gay-Lussac; but unfortunately the method is applicable only to liquids which boil at a comparatively low temperature. It consists in measuring with accuracy the volume of vapor formed by a known weight of liquid. The liquid is first enclosed in a very thin glass bulb, *A*, Fig. 461, which is hermetically sealed, and the weight of the liquid is determined by weighing the bulb both before and after it has been filled. This bulb is then passed up into a graduated bell-glass, *C*, filled with mercury, and standing in an iron basin also partly filled with the same liquid. Around the bell is placed a glass cylinder, whose lower end, resting in the mercury contained in the basin, is completely closed. This cylinder is filled with water, and the apparatus thus arranged is mounted on a charcoal furnace. The glass bulb is soon broken by the expansion of the liquid, and when the temperature is sufficiently elevated the liquid changes into vapor, which depresses the mercury-column. The heat is still increased until the water in the cylinder boils, when the bubbles of vapor rising through the liquid establish a uniform temperature of 100° throughout the whole mass. We then observe accurately the volume of the vapor and the pressure to which it is exposed. To obtain the last, we subtract from the height of the barometer, H_0 , the difference of level between the surface of the mercury in the basin and that in the bell. This difference of level is measured by a cathetometer with the aid of the levelling-screw *r*. Compare (159). With these data we can easily calculate the specific gravity. We reduce, first, the volume of the vapor to 0° and 76 c. m. by [166] and [107], and we then calculate the specific gravity by [55] and [58]. For the different precautions required in this process, and for the slight variations required under different circumstances, the student is referred to Regnault's Elements of Chemistry, American edition, Vol. II. p. 408.

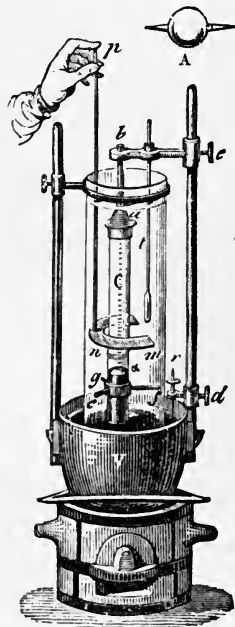

Fig. 461.

(332.) *Volumes of Gases.* — In consequence of the very small density of gases, their volumes can be determined much more accurately by measure than by weight. The measurement of the volume of a gas is effected in eudiometers, or graduated tubes, Fig. 462, which are generally about 2 c. m. in diameter and from 25 c. m. to 80 c. m. long. These tubes are frequently graduated

into cubic centimetres, but it is more accurate to divide them into millimetres and to determine afterwards the corresponding volumes by calibration. The graduation is easily made, with the dividing machine before described, on a thin coating of wax

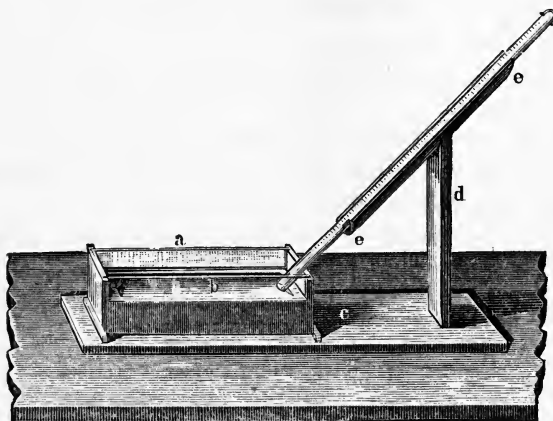

Fig. 462.

spread over the surface of the tube, and the divisions are afterwards etched with hydrofluoric acid. The tube is then calibrated by pouring into it repeatedly the same measured quantity of mercury through a long funnel, and after each addition accurately noting the division to which it rises in the tube. From these data it is easy to calculate the volume corresponding to each graduation; and a table is then prepared, from which these volumes can be subsequently ascertained by inspection. The measurements of gases are best performed over a small mercurial trough, like that represented in Fig. 462, which was contrived by Bunsen, and is admirably adapted to the purpose. The trough has two transparent sides of plate-glass, through which the level of the mercury is easily observed. The eudiometer is first filled with mercury by means of a long funnel reaching to the bottom of the tube; and after closing its mouth, it is inverted and placed in the position represented in the figure, when the gas can readily be introduced from the collecting tubes. When practicable, a drop of water is brought into the head of the eudiometer before filling it with mercury, so that the collected gas may be perfectly saturated with aqueous vapor.

Every determination of the volume of gases requires the following four primary observations:—

1. The level of the mercury in the eudiometer.
2. The level of the mercury in the trough measured on the etched divisions of the eudiometer.
3. The height of the barometer.
4. The temperature.

The eudiometer is first brought to a perpendicular position by means of a plumb-line, and the observations are then made by the help of a small telescope placed at a distance of from six to eleven feet. The axis of the telescope is brought to a horizontal position, and all error from parallax thus avoided. It is unnecessary to add, that the heights of the mercury columns must always be read off at the highest point of the meniscus.

The observed volumes of gas are reduced by calculation to the volumes in a dry state at 0° and under a pressure of 76 c. m. by means of the equation

$$V = V' \frac{H_0 - h_0 - f}{(1 + 0.00366t) 76},$$

which is easily obtained from [107], [184], and [203]. The following measurements, by Bunsen, of a volume of air saturated with aqueous vapor, may serve as an example of the calculation:—

Temperature of the air,	20°.2		c. m.
	c. m.	Height of barometer,	74.69
Lower level of mercury,	56.59	Correction for temperature,	0.25
Upper " " "	31.73	Reduced height H_0 ,	74.44
Difference of level,	24.86	Tension of vapor, f ,	1.76
Reduced height h_0 ,	24.78	$H_0 - h_0 - f$,	47.90

The division 317.3 corresponds to a volume by table of 292.7

Correction for meniscus, 0.4

The corrected volume V' , 293.1

V' , log. 2.46701

$H_0 - h_0 - f$, log. 1.68033

$(1 + 0.00366t)$ by Table XI., ar. co. 9.96902

76, ar. co. 8.11919

Reduced volume $V = 172.01$, log. 2.23555

For the practical details of the methods connected with the manipulation and measurement of gases, we would refer the student to Professor Bunsen's work on Gasometry. This distinguished experimentalist has very greatly improved all these processes, and has given them an accuracy unsurpassed by any of the most refined methods of chemical investigation.

PROBLEMS.

Hygrometry.

378. A glass globe, having been filled at 0° and 76 c. m. partly with air and partly with water, and afterwards sealed, is heated to 100° . Required the pressure exerted on the interior surface of the vessel, provided that there is an excess of water left in the globe.

379. What would be the pressure, if ether were used in the last example instead of water?

380. Into a vacuous vessel, whose capacity equals 2.02 litres, there were introduced one litre of dry air and sufficient water to leave after evaporation 20 c.m.^3 in the liquid state. Required the tension of the mixture of air and vapor in the interior of the vessel at 50° .

381. A given quantity of dry air weighs 5.2 grammes at 0° and 76 c. m. pressure. What would be its volume at 30° and 77 c. m. pressure when saturated with vapor?

382. What is the weight of a cubic metre of air at 30° and 77 c. m. pressure? The relative humidity of the air is assumed to be 0.75.

383. The volumes of air given in the table below were measured when saturated with vapor at the temperatures and pressures annexed. It is required to reduce these volumes to what they would have been at 0° and 76 c. m. pressure, had the gas been perfectly dry.

1. 250 c.m.^3	$H = 75.6 \text{ c. m.}$	$t = 15^\circ$.	4. 500 c.m.^3	$H = 76.3 \text{ c. m.}$	$t = 30^\circ$.
2. 120 "	$H = 25.4$	" $t = 20^\circ$.	5. 725 "	$H = 5.6$	" $t = 20^\circ$.
3. 75 "	$H = 5.6$	" $t = 10^\circ$.	6. 340 "	$H = 78$	" $t = -20^\circ$.

384. The volumes of air given in the following table were measured at 0° and 76 c. m. pressure when perfectly dry. It is required to determine what would have been the volume at the temperature and pressure annexed were the gas saturated with moisture.

1. 200 c.m.^3	$H = 75.4 \text{ c. m.}$	$t = 15^\circ$.	4. 75 c. m.^3	$H = 77.2 \text{ c. m.}$	$t = -10^\circ$.
2. 500 "	$H = 45.5$	" $t = 10^\circ$.	5. 60 "	$H = 80.2$	" $t = -4^\circ$.
3. 25 "	$H = 15.8$	" $t = 13^\circ$.	6. 140 "	$H = 79.4$	" $t = -10^\circ$.

385. In the following problems are given, first, the temperature of the atmosphere, t° ; secondly, the dew-point, t'° . It is required to determine in each case the relative humidity of the atmosphere and the weight of vapor in one cubic metre.

1. $t = 30^\circ$	$t' = 18^\circ$.	4. $t = 30^\circ$	$t' = 28^\circ$.	7. $t = 0^\circ$	$t' = -4^\circ$.
2. $t = 20^\circ$	$t' = 11^\circ$.	5. $t = 25^\circ$	$t' = 20^\circ$.	8. $t = 6^\circ$	$t' = -10^\circ$.
3. $t = 5^\circ$	$t' = 0^\circ$.	6. $t = 10^\circ$	$t' = 6^\circ$.	9. $t = 41^\circ$	$t' = 39^\circ$.

386. In the following problems are given, first, the temperature of the dry-bulb thermometer; secondly, that of the wet-bulb. Required in each case the relative humidity of the air.

- | | | | | | |
|-------------------|-------------------|-------------------|---------------------|--------------------|----------------------|
| 1. $t = 30^\circ$ | $t' = 28^\circ$. | 4. $t = 28^\circ$ | $t' = 26^\circ.7$. | 7. $t = 0^\circ$ | $t' = -3^\circ$. |
| 2. $t = 20^\circ$ | $t' = 12^\circ$. | 5. $t = 15^\circ$ | $t' = 12^\circ.3$. | 8. $t = -5^\circ$ | $t' = -8^\circ$. |
| 3. $t = 10^\circ$ | $t' = 2^\circ$. | 6. $t = 12^\circ$ | $t' = 8^\circ$. | 9. $t = -20^\circ$ | $t' = -20^\circ.8$. |

387. Assuming that the air is four fifths saturated with aqueous vapor at the temperature of 20° , how much water would fall from each cubic metre if the temperature suddenly fell to 11° ?

388. When the temperature of the air was 30° , the dew-point was observed to be at 28° ; the temperature of the air suddenly fell to 20° . How much rain would fall on a square kilometre from a height of 200 metres, assuming that the atmosphere were of uniform density and hygrometric condition throughout the whole height?

Sources of Heat.

389. How much wood charcoal must be burnt in order to evaporate 50 kilogrammes of water, assuming that the water is already at the boiling-point, and that all the heat evolved is economized in the process?

390. How much alcohol must be burnt in order to melt 5 kilogrammes of sulphur, assuming that the sulphur is already at the melting-point, and that the heat is all economized?

391. How much coke would be required to raise the temperature of the air of a room measuring 6 m. \times 7 m. \times 3.5 from 5° to 25° , assuming that none of the heat evolved was lost?

392. How many cubic metres of illuminating gas (marsh gas) must be burnt to raise the temperature of 40 kilogrammes of water from 0° to 100° ? How much, in order to convert the water into steam?

Conduction of Heat.

393. It is required to make a copper boiler by which 100 kilogrammes of water may be evaporated each hour. What must be the extent of boiler surface, assuming that the thickness of the copper is 2 m. m., and that the difference of temperature between the two surfaces of the copper plate is 10° ?

394. If the boiler were made of iron 5 m. m. thick, what must be the extent of the boiler surface?

WEIGHING AND MEASURING.

Specific Gravity of Solids.

395. The specific gravity of zinc was found to be 7.1582 when the temperature of the water was 15° . What would have been the specific gravity at 4° ?

396. The specific gravity of antimony was found to be 6.681 when the temperature of the water was 15° . What would have been the specific gravity at 4° ?

397. The specific gravity of an alloy of zinc and antimony was found from the following data:—

Weight of the alloy,	4.4106 grammes.
“ “ specific-gravity bottle,	9.0560 “
“ “ “ “ full of water at 4°,	19.0910 “
“ “ bottle, alloy, and water at 14°.6,	22.8035 “

398. Find the specific gravity of metallic zinc from the following data:—

Weight of the zinc,	12.4145 grammes.
“ “ bottle,	9.0560 “
“ “ full of water at 18°,	19.0790 “
“ “ zinc and water at 12°.4,	29.7663 “

Volume of Solids.

399. Gold-leaf is made as thin as one ten-thousandth of a millimetre. How great a surface could be covered with 10 grammes of such leaf?

400. A cylinder of iron weighing 21 kilogrammes is 2.5 m. high. What is its diameter?

401. The base of the grand pyramid of Egypt measured 23.48 m. on each side; its original height was 146.18 m. Required its weight, assuming that it was solid, and that the stone of which it is constructed has a Sp. Gr. = 2.75.

402. Required the price of an iron pipe, knowing that its interior diameter is equal to 0.254m., that its thickness equals 0.014 m. and its length 213.4 m. The specific gravity of cast-iron is 7.207, and its price 4 cents a pound.

403. A silver wire 1.5 m. m. in diameter weighs 3.2875 grammes. It is required to cover it with a coating of gold 0.4 m. m. in thickness. What will be the weight of the gold?

Volume of Liquids.

404. What is the volume of 40 kilogrammes of mercury at 100°? If the liquid is contained in a cylindrical vessel 6 c. m. in diameter, how high would it stand above the horizontal base?

405. A glass flask with a narrow neck was weighed full of mercury at the temperature of 10°, and found to weigh 560.234 grammes. The flask itself weighed 84.374 grammes. Required the volume of the flask.

406. Calculate the volume at 0° of the globe employed by Regnault in determining the absolute weight of one litre of air and of other gases from the following data (see Fig. 454):—

Weight of the glass globe at 4°.2 and 75.789 c. m.,	1,258.55 gram.
“ “ “ after having been filled with water at 0°,	11,126.05 “
Temperature of the chamber at the time of weighing,	6°
Height of the barometer at the same time,	76.177 c. m.

Ans. 9,881.06 c. m.³

Weight of Gases.

407. Calculate the weight of one litre of dry air at 0° and 76 c. m. from the following determination by Regnault (329). The globe used was the same as in the last example.

Globe full of Air and surrounded by Ice.

Height of barometer at the time of closing the stopcock, 76.119 c. m.
Weight added to globe to equipoise it in balance (Fig. 258), 1.487 gram.

Globe exhausted of Air and surrounded by Ice.

Tension of air remaining in globe as indicated by the manometer at the moment of closing the stopcock, 0.843 c. m.
Weight required for equipoise, 14.141 gram.

Ans. 12.7744 gram.

408. Calculate the weight of one litre each of hydrogen and carbonic acid at 0° and 76 c. m. from the following determinations of Regnault. The data are given in the same order as in the last problem.

Hydrogen.

Carbonic Acid.

Globe full of gas, $H_0 = 75.616$ c. m.	Globe full of gas, $H_0 = 76.304$ c. m.
$W' = 13.301$ gram.	$W' = 0.6335$ gram.
Globe exhausted, $h_0 = 0.340$ c. m.	Globe exhausted, $h_0 = 0.157$ c. m.
$W'' = 14.1785$ gram.	$W'' = 20.211$ gram.

Ans. 0.88591 gram.

Ans. 19.5397 gram.

409. Reduce the weights obtained from the last two problems to the latitude of 45° and the sea-level. See page 670.

410. Reduce the weights to what they would be at Quito. Latitude, $0^\circ 13'.5$. Elevation above sea-level, 2,908 metres.

411. In the following table are given, first, the volume of the gas; secondly, the pressure to which it is exposed; thirdly, its temperature. Assuming that the gas is saturated with vapor of water, it is required to calculate the weight in each case.

	V.	H.	t.
Air,	245 $\overline{\text{c. m.}^3}$	76.12 c. m.	15° .
Hydrogen,	564 "	64.32 "	12° .
Carbonic Acid,	202 "	45.20 "	4° .
Chlorine,	50 "	75.89 "	30° .
Protoxide of Nitrogen,	465 "	66.23 "	8° .
Steam,	500 "	76.54 "	213° .
Alcohol Vapor,	1,500 "	54.22 "	152° .
Ether Vapor,	250 "	75.20 "	100° .

412. A glass globe weighed, when open to the air, 225.169 grammes; filled with water at the temperature of 0° , it weighed 785.169 grammes. Required the weight of air which the globe would contain at 300° and under a pressure of 77 c. m.

413. What is the weight of one cubic metre of aqueous vapor at its maximum tension at the following temperatures: 10° , 15° , 120° , 200° , and 250° ?

414. What is the weight of the vapor contained in one cubic metre of the atmosphere under the conditions given in problem 385 ?

Specific Gravity of Gases and Vapors.

415. Calculate the specific gravity of hydrogen and carbonic acid at 0° from the data given in problems 407, 408, and 409.

416. Ascertain the specific gravity of alcohol vapor from the following data : —

Weight of glass globe, W' ,	50.8039 grammes.
Height of barometer, H' ,	74.754 c. m.
Temperature, t' ,	18° .
Weight of globe and vapor, W ,	50.8245 grammes.
Height of barometer, H ,	74.764 c. m.
Temperature, t ,	167° .
Volume, V ,	$351.5 \overline{\text{c. m.}^3}$

417. Ascertain the specific gravity of camphor vapor from the following data : —

Weight of glass globe, W' ,	50.1342 grammes.
Height of barometer, H' ,	74.2 c. m.
Temperature, t' ,	$13^\circ.5$.
Weight of globe and vapor, W ,	50.8422 grammes.
Height of barometer, H ,	74.2 c. m.
Temperature, t ,	244° .
Volume, V ,	$295 \overline{\text{c. m.}^3}$

Volume of Gases.

418. A volume of air saturated with moisture gave the following measurements. Reduce to the standard temperature and pressure.

Level of mercury in pneumatic trough,	52.34 c. m.
“ “ eudiometer,	24.25 “
Volume corresponding to 24.25 division,	$350 \overline{\text{c. m.}^3}$
Temperature of the air,	$15^\circ.4$.
Height of barometer,	76.54 c. m.

419. A volume of air saturated with moisture at $3^\circ.1$ and 57.59 c. m. pressure, was found to measure $368.9 \overline{\text{c. m.}^3}$. After absorbing the oxygen with a paper ball moistened with pyrogallate of potash, and drying the residual gas with a ball of caustic potash, it was found to measure $313.8 \overline{\text{c. m.}^3}$, the temperature being $3^\circ.1$ and the pressure 53.58 c. m. Required the percentage composition of the gas.

420. A volume of gas (choke-damp), measured moist at $13^\circ.5$ and 62.40 pressure, was found to be $171.2 \overline{\text{c. m.}^3}$. After absorbing the carbonic acid with a ball of caustic potash and drying the gas, it was found to measure $167.3 \overline{\text{c. m.}^3}$, the temperature being 13.5° and the pressure 61.96 c. m. Finally, after absorbing the oxygen with pyrogallate of potash, and drying, the gas was found to measure, at $13^\circ.9$ and 60.58 c. m. pressure, $147 \overline{\text{c. m.}^3}$. Required the percentage composition of the gas.

A P P E N D I X .

LIST OF TABLES.

Table	*Page
I. Weights and Measures	11
II. Specific Gravity and Weight of One Litre of various Gases and Vapors, calculated for Latitude of Washington from Regnault's Experiments	668
III. Specific Gravity of Gases. (<i>Ann. du Bureau des Long.</i> , 1855.)	
IV. Specific Gravity of Vapors. " " "	
V. Specific Gravity of Liquids. " " "	
VI. Specific Gravity of Solids. " " "	
VII. Coefficients of Absorption of various Gases in Water and Alcohol. (Bunsen.)	392
VIII. Tension of the Vapor of Alcohol. (Regnault.)	582
IX. Tension of Aqueous Vapor from -32° to 230° . (Regnault.)	570
X. Tension of Aqueous Vapor from -2° to 35° . (Regnault.)	570
XI. Value of $1 + 0.00366 t$ between -2° and 59° . (Bunsen.)	528
XII. Value of $1 + 0.00367 t$ between 60° and 299° . (Gerhardt.)	528
XIII. Value of $1 + k(t' - t)$ for Glass. (Gerhardt.)	493, 695
XIV. Weight of One Cubic Centimetre of Air. (Gerhardt.)	673
XV. Expansion of Solids. (Müller.)	496
XVI. Volume of Water at different Temperatures. (Kopp.)	526, 662
XVII. Reduction of Thermometer. (Graham.)	436
XVIII. Reduction of Barometer.	511
XIX. Reduction of Water Column to Mercury. (Bunsen.)	513
XX. Logarithms of Numbers.	
XXI. Antilogarithms.	

* These numbers indicate the pages of the work on which the use of the table is described.

T A B L E S .

T A B L E I .

MEASURES AND WEIGHTS.

ENGLISH MEASURES.

Measures of Length.

THE *inch* is the smallest lineal integer now used. For mechanical purposes it is divided either duodecimally or by continual bisection; but for scientific purposes it is most convenient to divide it decimally. The larger units are thus related to it: —

Mile.	Furlongs.	Chains.	Rods.	Fathoms.	Yards.	Feet.	Links.	Inches.
1	= 8	= 80	= 320	= 880	= 1760	= 5280	= 8000	= 63360
	1	= 10	= 40	= 110	= 220	= 660	= 1000	= 7920
		1	= 4	= 11	= 22	= 66	= 100	= 792
			1	= 2.75	= 5.5	= 16.5	= 25	= 198
				1	= 2	= 6	= $9\frac{1}{11}$	= 72
					1	= 3	= $4\frac{6}{11}$	= 36
						1	= $1\frac{17}{33}$	= 12
.000125	= .001	= .01	= .04	= .11	= .22	= 0.66	= 1	= 7.92

Measures of Surface.

Acre.	Rods.	Square Chains.	Square Yards.	Square Feet.
1	= 4	= 10	= 4840	= 43,560
	1	= 2.5	= 1210	= 10,865
		1	= 484	= 4,356
			1	= 9

Measures of Volume.

Cubic Yard.	Cubic Feet.	Cubic Inches.
1	= 27	= 46,656
	1	= 1,728

Imperial Measure.

The Imperial Standard Gallon contains ten pounds avoirdupois weight of distilled water, weighed in air at 62° Fahr. and 30 in. Barom., or 12 pounds, 1 ounce, 16 pennyweights, and 16 grains Troy, = 70,000 grains' weight of distilled water. A cubic inch of distilled water weighs 252.458 grains, and the imperial gallon contains 277,274 cubic inches.

Distilled Water.									
Grains.	Avoir. lb.	Cubic Inches.	Pint.	Quart.	Galls.	Pecks.	Bush.	Qr.	
8,750 =	1.25 =	34.659 =	1						
17,500 =	2.5 =	69.318 =	2 =	1					
70,000 =	10 =	277.274 =	8 =	4 =	1				
140,000 =	20 =	554.548 =	16 =	8 =	2 =	1			
560,000 =	80 =	2,218.192 =	64 =	32 =	8 =	4 =	1		
4,480,000 =	640 =	17,745.536 =	512 =	256 =	64 =	32 =	8 =	1	

Apothecaries' Measure.

The gallon of the former wine measure and of the present Apothecaries' measure contains 58,333.31 grains' weight of distilled water, or 231 cubic inches, the ratio to the imperial gallon being nearly as 5 to 6, or as 0.8331 to 1.

Gallon.	Pints.	Ounces.	Drachms.	Minims.	Gr. of Dist. Wat.	Cub. Inch.
1 =	8 =	128 =	1024 =	61,440 =	58,333.31 =	231
	1 =	16 =	128 =	7,680 =	7,291.66 =	28.8
		3 1 =	8 =	480 =	455.72 =	1.8
			3 1 =	60 =	56.96 =	0.2

ENGLISH WEIGHTS.

Avoirdupois Weight.

Pound.	Ounces.	Drachms.	Grains.
1 =	16 =	256 =	7000
	1 =	16 =	437.5
		1 =	27.34375

Apothecaries' Troy Weight.

Pound.	Ounces.	Drachms.	Scruples.	Grains.
1 =	12 =	96 =	288 =	5760
	1 =	8 =	24 =	480
		1 =	3 =	60
			1 =	20

FRENCH MEASURES.

Measures of Length.

1 Kilometre	=	1000 Metres.		1 Metre	=	1.000 Metre.
1 Hectometre	=	100 "		1 Decimetre	=	0.100 "
1 Decametre	=	10 "		1 Centimetre	=	0.010 "
1 Metre	=	1 "		1 Millimetre	=	0.001 "

		Logarithms.	Ar. Co. Log.	
1 Kilometre	=	0.6214 Mile.	9.793 3712	0.206 6188
1 Metre	=	3.2809 Feet.	0.515 9930	9.484 0070
1 Centimetre	=	0.3937 Inch.	9.595 1742	0.404 8258

Measures of Volume.

1 Cubic Metre	=	1000.000 Litres.
1 Cubic Decimetre	=	1.000 "
1 Cubic Centimetre	=	0.001 "

		Logarithms.	Ar. Co. Log.	
1 Cubic Metre	=	35.31660 Cubic Feet.	1.547 9790	8.452 0210
1 Cubic Decimetre	=	61.02709 Cubic Inches.	1.785 5226	8.214 4774
1 Cubic Centimetre	=	0.06103 " "	8.785 5226	1.214 4774
1 Litre	=	0.22017 Gallon.	9.342 7581	0.657 2419
1 Litre	=	0.88066 Quart.	9.944 8083	0.055 1917
1 Litre	=	1.76133 Pints.	0.245 8407	9.754 1593

FRENCH WEIGHTS.

1 Kilogramme	=	1000 Grammes.		1 Gramme	=	1.000 Gramme.
1 Hectogramme	=	100 "		1 Decigramme	=	0.100 "
1 Decagramme	=	10 "		1 Centigramme	=	0.010 "
1 Gramme	=	1 "		1 Milligramme	=	0.001 "

		Logarithms.	Ar. Co. Log.	
1 Kilogramme	=	2.20462 Pounds Avoirdupois.	0.343 3337	9.656 6663
1 " "	=	2.67922 " Troy.	0.428 0083	9.571 9917
1 Gramme	=	15.43235 Grains.	1.188 4321	8.811 5679

TABLE FOR THE REDUCTION OF THE BAROMETRIC SCALE.

28 inch.	=	71.1187 c. m.		71 c. m.	=	27.953 inch.		75 c. m.	=	29.528 inch.
29 "	=	73.6587 "		72 "	=	28.347 "		76 "	=	29.922 "
30 "	=	76.1986 "		73 "	=	28.741 "		77 "	=	30.315 "
31 "	=	78.7386 "		74 "	=	29.134 "		78 "	=	30.709 "
		1 inch = 2.539954 c. m.				1 c. m. = 0.3937 inch.				

LOGARITHMS

FOR REDUCING THE MOST COMMON WEIGHTS AND MEASURES.

Measures of Length.

Metre.	Parisian Foot.	Austrian Foot.	Prussian Foot.	English Foot.
0.	0.488 3313	0.500 1723	0.503 2730	0.515 9929
0.511 6687-1	0.	0.011 8410	0.014 9417	0.027 6616
0.499 8277-1	0.988 1590-1	0.	0.003 1007	0.015 8206
0.496 7270-1	0.985 0583-1	0.996 8993-1	0.	0.012 7199
0.484 0071-1	0.972 3384-1	0.984 1794-1	0.987 2501-1	0.

Measures of Surface.

Square Metre.	Parisian Sq. Foot.	Austrian Sq. Foot.	Prussian Sq. Foot.	English Sq. Foot.
0.	0.976 6625	1.000 3445	1.006 5459	1.031 9857
0.023 3375-1	0.	0.023 6820	0.029 8834	0.055 3232
0.999 6555-2	0.976 3180-1	0.	0.006 2014	0.031 6412
0.993 4540-2	0.970 1166-1	0.993 7986-1	0.	0.025 4398
0.963 0143-2	0.944 6768-1	0.963 3588-1	0.974 5602-1	0.

Measures of Volume.

Cubic Metre.	Parisian Cub. Foot.	Austrian Cub Foot.	Prussian Cub. Foot.	English Cub Foot.
0.	1.464 9933	1.500 5168	1.509 8189	1.547 9786
0.535 0062-2	0.	0.035 5230	0.044 8251	0.082 9848
0.499 4832-2	0.964 4770-1	0.	0.009 3021	0.047 4618
0.490 1810-2	0.955 1749-1	0.990 6979-1	0.	0.038 1597
0.452 0214-2	0.917 0152-1	0.952 5382-1	0.961 8403-1	0.

Weights.

Kilogramme.	Austrian Pound.	Prussian Pound.	Eng Troy Pound.	English Pound Avoirdupois.
0.	0.251 8027	0.330 0224	0.428 0208	0.343 3453
0.748 1973-1	0.	0.078 2197	0.176 2182	0.091 5426
0.669 9776-1	0.921 7803-1	0.	0.097 9984	0.013 3229
0.571 9792-1	0.823 7818-1	0.902 0016-1	0.	0.915 3244-1
0.656 6547-1	0.908 4574-1	0.986 6771-1	0.084 6756	0.

TABLE II.

SPECIFIC GRAVITY AND ABSOLUTE WEIGHT OF ONE LITRE OF
SOME OF THE MOST IMPORTANT GASES AND VAPORS.

CALCULATED FOR THE LATITUDE OF WASHINGTON.

Names of Gases.	Equiv. Volume.	Sp. Gr. Observed.	Sp. Gr. Computed.	Weight of 1 Litre = 1,000 c. m. ³	Logarithms.	Ar. Co. Logarithms.
Air,		1	1.00000	1.29206	0.111282	9.888718
Alcohol,	4	1.613	1.58938	2.05357	0.312510	9.687490
Ammonia gas,	4	0.5967	0.58738	0.75893	9.880201	0.119799
Antimony,	1		16.90823	21.84640	1.339380	8.660620
Antimonide of hydrogen,	4		4.33072	5.59554	0.747842	9.252158
Arsenic,	1	10.65	10.36553	13.39285	1.126873	8.873127
Arsenide of hydrogen,	4	2.695	2.69504	3.48215	0.541847	9.458153
Boron,	1		1.50646	1.94643	0.289238	9.710762
Bromine,	2	5.54	5.52827	7.14285	0.853872	9.146128
Bromohydric acid,	4		2.79870	3.61607	0.558237	9.441763
Carbon,	1	0.8469*	0.82924	1.07143	0.029963	9.970037
Carbonic acid,	2	1.52908	1.52131	1.96433	0.293215	9.706785
Carbonic oxide,	2	0.96779	0.96745	1.25000	0.096910	9.903090
Chlorine,	2	2.47	2.45317	3.16964	0.501010	9.498990
Chloride of boron,	4	3.942	4.05636	5.24107	0.719420	9.280580
Chloride of silicon,	3	5.939	5.87380	7.58928	0.880201	9.119799
Chlorohydric acid,	4	1.2474	1.26114	1.62947	0.212045	9.787955
Cyanogen,	2	1.8064	1.79669	2.32143	0.365755	9.634245
Cyanohydric acid,	4	0.9476	0.93290	1.20536	0.081116	9.918884
Ether,	2	2.586	2.55689	3.30363	0.518994	9.481006
Fluorine,	2		1.31297	1.69643	0.229536	9.770464
Fluoride of boron,	4	2.3124	2.34608	3.03127	0.481625	9.518375
Fluoride of silicon,	3	3.600	3.59338	4.64287	0.666786	9.333214
Fluohydric acid,	4		0.69104	0.89286	9.950782	0.049218
Hydrogen,	2	0.06926	0.06910	0.08929	8.950782	1.049218
Iodine,	2	8.716	8.77614	11.33930	1.054586	8.945414
Iodohydric acid,	4	4.443	4.42262	5.71429	0.756962	9.243038
Marsh gas,	4	0.5576	0.55283	0.71429	9.853872	0.146128
Mercury,	2	6.976	6.91035	8.92858	0.950782	9.049218
Nitrogen,	2	0.97137	0.96745	1.25000	0.096910	9.903090
Nitrous oxide,	2	1.5269	1.52028	1.96429	0.293205	9.706795
Nitric oxide,	4	1.0388	1.03655	1.33928	0.126873	9.873127
Olefiant gas,	4	0.9852	0.96745	1.25000	0.096910	9.903090
Oxygen,	1	1.10563	1.10566	1.42857	0.154902	9.845098
Phosphorus,	1	4.42	4.28442	5.53571	0.743174	9.256826
Phosphide of hydrogen,	4	1.178	1.17476	1.51786	0.181231	9.818769
Selenium,	1		5.52827	7.14285	0.853872	9.146128
Silicon,	1		2.90235	3.75000	0.574031	9.425969
Sulphur,	1	2.2	2.21132	2.85714	0.455932	9.544068
Sulphide of hydrogen,	2	1.1912	1.17476	1.51786	0.181231	9.818769
Sulphurous acid,	2	2.247	2.21131	2.85714	0.455932	9.544068
Water,	2	0.6235	0.62193	0.80357	9.905025	0.094975

* Computed from the specific gravity of carbonic acid, observed by Regnault.

TABLE III.

SPECIFIC GRAVITIES OF GASES AT 0° C.; BAROMETER, 76 c. m.

Names.	Specific Gravity by Observation.	Specific Gravity by Calculation.	Observers.
Air,	1.000		[gault.
Oxygen,	1.106	. .	Dumas and Boussin-
Hydrogen,	0.0691	. .	“ “ “
Marsh gas,	0.555	0.559	Thomson.
Methyle,		0.490	
Olefiant gas,	0.978	0.980	Th. de Saussure.
Bicarbide of hydrogen of Faraday,	1.920	1.960	Faraday.
Phosphide of hydrogen,	1.214	1.193	Dumas.
Arsenide of hydrogen,	2.695	2.695	“
Chlorine,	2.470	. .	Gay-Lussac & The-
Oxide of chlorine, or hypochloric acid,	2.340	[nard.
Hypochlorous acid of Balard,	2.980	
Nitrogen,	0.972	. .	Dumas and Boussin-
Protoxide of nitrogen,	1.520	1.525	Colin. [gault.
Deutoxide of nitrogen,	1.0388	1.036	Berard.
Cyanogen,	1.806	1.818	Gay-Lussac.
Chloride of cyanogen,	2.116	“
Ammonia,	0.596	0.591	Biot and Arago.
Oxide of carbon,	0.957	. .	Cruikshank.
Carbonic acid,	1.529	. .	Dumas and Boussin-
Chloro-carbonic acid,	3.399	[gault.
Sulphurous acid,	2.234	. .	Thenard.
Acid, chlorohydric,	1.247	1.260	Biot and Arago.
— bromohydric,	2.731	
— iodohydric,	4.443	4.350	Gay-Lussac.
— sulphohydric,	1.191	. .	Gay-Lussac & The-
— selenohydric,	2.795	Bineau. [nard.
— tellurohydric,	4.490	“
— fluoboracic,	2.371	. .	John Davy.
— fluosilicic,	3.573	. .	“
— chloroboracic,	3.420	. .	Dumas.
Monohydrate of methyle,	1.617	1.601	Dumas and Peligot.
Chlorohydrate of methyle,	1.731	1.737	“ “ “
Fluohydrate of methyle,	1.186	1.170	“ “ “

TABLE IV.

SPECIFIC GRAVITIES OF VAPORS REDUCED BY CALCULATION
TO 0° C., AND BAROMETER 76 c. m.

Names.	Specific Gravity by Observation.	Specific Gravity by Calculation.	Observers.
Air,	1.000		
Bromine,	5.540	5.390	Mitscherlich.
Iodine,	8.716	8.700	Dumas.
Sulphur,	6.617	6.650	"
Phosphorus,	4.420	4.320	"
Arsenic,	10.600	10.360	Mitscherlich.
Mercury,	6.976	6.970	Dumas.
Acid, arsenious,	13.850	13.300	Mitscherlich.
— sulphuric anhydrous,	3.000	2.760	"
— selenious,	4.030	. .	"
— hyponitrous,	1.720	. .	"
— nitric tetrahydrated,	1.270	. .	Bineau.
Yellow chloride of sulphur,	4.700	4.650	Dumas.
Red chloride of sulphur,	3.700	. .	"
Protochloride of phosphorus,	4.870	4.790	"
Chloride of arsenic,	6.300	6.250	"
Iodide of arsenic,	16.100	15.640	Mitscherlich.
Protochloride of mercury,	8.350	8.200	"
Bichloride of mercury,	9.800	9.420	"
Protobromide of mercury,	10.140	9.670	"
Deutobromide of mercury,	12.160	12.370	"
Deutoiodide of mercury,	15.600	15.680	"
Sulphide of mercury (cinnabar),	5.500	5.400	"
Protochloride of antimony,	7.800	. .	"
Protochloride of bismuth,	11.100	10.990	Jacquelain.
Perochloride of chromium,	{ 5.520 } { 5.900 }	5.500	Bineau and Walter.
Bichloride of tin,	9.199	8.990	Dumas.
Solid chloride of cyanogen,	6.390	. .	Bineau.
Bromide of cyanogen,	3.610	. .	"
Chloride of silicon,	5.939	5.959	Dumas.
Camphor,	5.468	5.314	"
Oil of turpentine,	4.763	4.765	"
Benzine,	2.770	2.730	Mitscherlich.
Naphthaline,	4.528	4.492	Dumas.
Chloride of elayle,	3.443	3.450	Gay-Lussac.
Sulphide of carbon,	2.644	. .	"
Alcohol,	1.6133	1.601	"
Ether,	2.586	2.583	"
— acetic,	3.067	3.066	Dumas & Boullay.
— oxalic,	5.087	5.081	" "
— benzoic,	5.409	5.240	" "

Names.	Specific Gravity by Observation.	Specific Gravity by Calculation.	Observers.
Methylic alcohol,	1.120	1.110	Dumas and Peligot.
Sulphate of methyle,	4.565	4.370	" "
Acetate of methyle,	2.563	2.570	" "
Fusel oil,	3.147	3.070	Dumas.
Acetone,	2.019	2.020	"
Mercaptan,	2.326	2.160	Bunsen.
Aldehyde,	1.532	1.530	Liebig.
Oil of bitter almonds,	3.708	Wohler and Liebig.
Hydruret of salicyle,	4.270	4.260	Piria.
Oil of cinnamon,	4.620	Dumas and Peligot.
Oil of cumin,	5.200	5.100	Gerhardt and Ca-
Acid, acetic,	2.770	2.780	Dumas. [hours.
— benzoic,	4.270	4.260	"
— valerianic,	3.680	3.550	Dumas and Stas.
— cyanohydric,	0.947	0.936	Gay-Lussac.
Kakodyle,	7.100	7.280	Bunsen.
Oxide of kakodyle,	7.550	7.830	"
Cyanuret of kakodyle,	4.630	4.540	"
Chloride of kakodyle,	4.560	4.800	"
Water,	0.6235	0.624	Gay-Lussac.

TABLE V.

SPECIFIC GRAVITY OF LIQUIDS AT 4° C.

Name.	Sp. Gravity.	Name.	Sp. Gravity.
Water, distilled,	1.000	Ether,	0.715
Bromine,	2.966	— chlorohydric,	0.874
Mercury at 0° C.,	13.596	— acetic,	0.868
Acid, sulphuric, most concentrated,	1.841	Methylic alcohol,	0.798
— hyposulphuric,	1.347	Fusel oil,	0.818
— nitric fuming,	1.451	Acetone,	0.792
— nitric tetrahydrated,	1.420	Mercaptan,	0.840
— nitric of commerce,	1.220	Oil of turpentine,	0.869
— hyponitric,	1.451	— of citron,	0.847
— chlorohydric concentrated liquid,	1.208	Aldehyde,	0.790
— acetic monohydrated,	1.068	Oil of bitter almonds,	1.043
— acetic, greatest density,	1.079	— of spiræa,	1.173
— oleic,	0.898	— of cumin,	0.969
— cyanohydric,	0.696	— of cinnamon,	1.010
Sulphide of carbon,	1.263	Sea-water,	1.026
Protochloride of sulphur,	1.680	Milk,	1.030
Alcohol, absolute,	0.792	Wine of Bordeaux,	0.994
— greatest density (hyd. of Rudberg),	0.927	— of Burgundy,	0.991
		Olive-oil,	0.915
		Naphtha,	0.847

TABLE VI.
SPECIFIC GRAVITY OF SOLIDS AT 4° C.

1. *Simple Bodies.*

Names.	Specific Gravity.	Observers.
Iodine,	4.948	Gay-Lussac.
Sulphur,	2.086	Leroyer & Dumas.
Selenium,	4.300	
Phosphorus,	1.770	
Arsenic,	5.670	Herapath.
Carbon, { Diamonds, }	3.530	Leroyer & Dumas.
	3.500	
Graphite,	2.500	
Potassium,	0.865	Gay-Lus. and Then.
Sodium,	0.972	" "
Manganese,	8.010	
Iron,	7.788	
— cast,	7.200	
Steel, not hammered,	7.810	
Zinc,	7.190	
Cadmium, hammered,	8.690	
Tin,	7.291	
Cobalt, cast,	7.812	
Nickel, cast,	8.279	
— forged,	8.666	
Molybdenum,	8.600	
Tungsten,	17.600	Frères d'Echuyart.
Chromium,	5.900	
Antimony,	6.720	
Titanium,	5.300	
Tellurium,	6.240	
Uranium,	9.000	Bucholz.
Bismuth,	9.822	Frères d'Echuyart.
Lead, cast,	11.350	
Copper, cast,	8.850	
— rolled or forged,	8.950	
Mercury at 0°,	13.598	
Osmium,	10.000 ?	
Iridium (cast by electric battery),	18.680	Children.
Palladium,	11.300	
— rolled,	11.800	
Rhodium,	11.000 ?	
Silver, cast,	10.470	
Gold, forged,	19.360	
— cast,	19.260	
Platinum,	21.530	
— rolled,	22.060	

2. Binary Compounds.

Names.	Specific Gravity.	Observers.
Acid, silicic, { Quartz hyalin.,	2.653	M.*
	2.615	M.
	2.250	M.
— hydrated boracic (sassoline),	1.480	M.
Lime,	3.150	Boullay.
Chloride of calcium,	2.230	"
Fluoride of calcium (fluor-spar),	3.200	M.
Chloride of barium,	3.900	Boullay.
Chloride of potassium,	1.836	Wenzel.
Iodide of potassium,	3.000	Boullay.
Chloride of sodium,	2.100	Kirwan.
Chloride of ammonium (sal. ammoniac),	1.520	M.
Alumina, { Corundum, sapphire, and ori-		
	ental ruby,	4.160
Emery,	3.900	M.
Acid, arsenious,	3.700	Leroyer & Dumas.
Protoxide of antimony,	5.778	Boullay.
Sulphide of antimony,	4.334	M.
Oxide of silver,	7.250	Boullay.
Sulphide of silver,	7.200	M.
Chloride of silver,	5.548	Boullay.
Iodide of silver,	5.614	"
Deutoxide of mercury,	11.000	"
Protochloride of mercury,	7.140	"
Bichloride of mercury,	5.420	"
Deutoiodide of mercury,	6.320	"
Protoiodide of mercury,	7.750	"
Bisulphide of mercury,	8.124	"
Oxide of bismuth,	8.968	"
Sulphide of bismuth,	6.540	M.
Sulphide of molybdenum,	4.600	M.
Tungstic acid,	6.000	M.
Protoxide of copper,	5.300	Boullay.
Deutoxide of copper,	6.130	"
Protosulphide of copper,	5.690	M.
Deutoxide of tin,	6.700	M.
Protosulphide of tin,	5.267	Boullay.
Bisulphide of tin,	4.415	"
Protoxide of lead (cast),	9.500	"
Peroxide of lead,	9.200	"
Iodide of lead,	6.100	"
Selenide of lead,	7.690	M.
Sulphide of lead (Galena),	7.580	M.
Oxide of zinc,	5.600	Boullay.
Sulphide of zinc (blende),	4.160	M.

* M. Indicates the numbers taken from the "Traité de Minéralogie" of Beudant. The mean has generally been used.

Names.	Specific Gravity.	Observers.	
Peroxide of iron,	5.225	Boullay.	
Magnetic oxide of iron,	5.400	"	
Sulphides of iron, {	Bisulphide of iron		
	(pyrites),	5.000	M.
	Do. (white pyrites),	4.840	M.
	Magnetic pyrites,	4.620	M.
Peroxide of manganese,	4.480	Boullay.	
Sesquioxide of manganese,	4.810	M.	
Red oxide of manganese,	4.722	M.	
Protosulphide of manganese,	3.950	M.	
Peroxide of titanium (rutile),	4.250	M.	

3. Simple Salts.

Names.	Specific Gravity.	Observers.	
Carbonate of Lime, {	Iceland Spar,	2.723	Malus.
	Arragonite,	2.946	Thenard.
Carbonate of magnesia (giobertite),	2.880	M.	
Carbonate of iron (iron spar),	3.850	M.	
Carbonate of manganese,	3.550	M.	
Carbonate of zinc,	4.500	M.	
Carbonate of barytes,	4.300	M.	
Carbonate of strontia,	3.650	M.	
Carbonate of lead (white lead),	6.730	M.	
Sulphate of baryta (heavy spar),	4.700	M.	
Sulphate of strontia (celestine),	3.950	M.	
Sulphate of lead,	6.300	M.	
Sulphate of silver,	5.340	Karsten.	
Sulphates of lime, {	Anhydrite,	2.900	M.
	Gypsum,	2.330	M.
Sulphate of potash,	2.400	M.	
Anhydrous sulphate of soda,	2.630	Karsten.	
Chromate of potash,	2.700	Kopp.	
Chromate of lead (native),	6.600	M.	
Nitrate of potash,	1.930	M.	
Nitrate of baryta,	3.185	Karsten.	
Nitrate of strontia,	2.890	"	
Nitrate of lead,	4.400	"	
Molybdate of lead,	6.700	Gmelin.	
Tungstate of lead,	8.000	"	
Tungstate of lime,	6.000	Karsten.	
Aluminate of magnesia (spinel),	3.700	M.	
Aluminate of zinc (zinc spinel),	4.700	M.	
Silicate of zirconia (zircon),	4.400	M.	
Borate of magnesia (boracite),	2.500	M.	

TABLE VII.
TABLE OF THE COEFFICIENTS OF ABSORPTION OF VARIOUS GASES IN WATER AND ALCOHOL.

Temperature Cent.	NITROGEN		HYDROGEN		OXYGEN		CARBONIC ACID		CARBONIC OXIDE		NITROUS OXIDE		NITRIC OXIDE
	In Water.	In Alcohol.	In Water.	In Alcohol.	In Water.	In Alcohol.	In Water.	In Alcohol.	In Water.	In Alcohol.	In Water.	In Alcohol.	Alcohol.
0	0.02035	0.12634	0.01930	0.06925	0.04114	0.28397	1.767	4.3295	0.03287	0.20443	1.3052	4.1780	0.31606
1	0.01981	0.12593	0.01930	0.06910	0.04007	0.28397	1.7207	4.2868	0.03207	0.20443	1.2605	4.1088	0.31262
2	0.01932	0.12553	0.01930	0.06896	0.03907	0.28397	1.6481	4.1466	0.03131	0.20443	1.2172	4.0409	0.30928
3	0.01884	0.12514	0.01930	0.06881	0.03810	0.28397	1.5787	4.0589	0.03057	0.20443	1.1752	3.9741	0.30604
4	0.01838	0.12476	0.01930	0.06867	0.03717	0.28397	1.5126	3.9736	0.02987	0.20443	1.1346	3.9085	0.30290
5	0.01794	0.12440	0.01930	0.06853	0.03628	0.28397	1.4497	3.8908	0.02920	0.20443	1.0954	3.8442	0.29985
6	0.01752	0.12405	0.01930	0.06839	0.03544	0.28397	1.3901	3.8105	0.02857	0.20443	1.0575	3.7811	0.29690
7	0.01713	0.12371	0.01930	0.06826	0.03465	0.28397	1.3339	3.7327	0.02796	0.20443	1.0210	3.7192	0.29405
8	0.01675	0.12338	0.01930	0.06813	0.03389	0.28397	1.2809	3.6573	0.02739	0.20443	0.9858	3.6585	0.29130
9	0.01640	0.12306	0.01930	0.06799	0.03317	0.28397	1.2311	3.5844	0.02686	0.20443	0.9520	3.5990	0.28865
10	0.01607	0.12276	0.01930	0.06786	0.03250	0.28397	1.1847	3.5140	0.02635	0.20443	0.9196	3.5408	0.28609
11	0.01577	0.12247	0.01930	0.06774	0.03189	0.28397	1.1416	3.4461	0.02588	0.20443	0.8885	3.4838	0.28363
12	0.01549	0.12219	0.01930	0.06761	0.03133	0.28397	1.1018	3.3807	0.02544	0.20443	0.8588	3.4279	0.28127
13	0.01523	0.12192	0.01930	0.06749	0.03082	0.28397	1.0653	3.3178	0.02504	0.20443	0.8304	3.3734	0.27901
14	0.01500	0.12166	0.01930	0.06737	0.03034	0.28397	1.0321	3.2573	0.02466	0.20443	0.8034	3.3200	0.27685
15	0.01478	0.12142	0.01930	0.06725	0.02989	0.28397	1.0020	3.1993	0.02432	0.20443	0.7778	3.2678	0.27478
16	0.01458	0.12119	0.01930	0.06713	0.02949	0.28397	0.9753	3.1438	0.02402	0.20443	0.7535	3.2169	0.27281
17	0.01441	0.12097	0.01930	0.06701	0.02914	0.28397	0.9519	3.0908	0.02374	0.20443	0.7306	3.1672	0.27094
18	0.01426	0.12076	0.01930	0.06690	0.02884	0.28397	0.9318	3.0402	0.02350	0.20443	0.7090	3.1187	0.26917
19	0.01413	0.12056	0.01930	0.06679	0.02858	0.28397	0.9150	2.9921	0.02329	0.20443	0.6888	3.0714	0.26750
20	0.01403	0.12038	0.01930	0.06668	0.02838	0.28397	0.9014	2.9465	0.02312	0.20443	0.6700	3.0253	0.26592
21	0.12021	0.01930	0.06657	0.028397	0.9014	2.9034	2.9034	0.6525	0.6525	0.6525	2.9805	0.26444	
22	0.12005	0.01930	0.06646	0.028397	0.9014	2.8628	2.8628	0.6364	0.6364	0.6364	2.9368	0.26306	
23	0.11990	0.01930	0.06636	0.028397	0.9014	2.8247	2.8247	0.6216	0.6216	0.6216	2.8944	0.26178	
24	0.11976	0.01930	0.06626	0.028397	0.9014	2.7890	2.7890	0.6082	0.6082	0.6082	2.8532	0.26060	

TABLE OF THE COEFFICIENTS OF ABSORPTION OF VARIOUS GASES IN WATER AND ALCOHOL.
(Continued.)

Temperature Cent.	MARSH GAS		OLEFIANT GAS		ETHYL	METHYL	SULPHURETTED HYDROGEN		SULPHUROUS ACID		AMMONIA	ATMOSPHERIC AIR
	In Water.	In Alcohol.	In Water.	In Alcohol.			In Water.	In Alcohol.	In Water.	In Alcohol.		
0	0.05449	0.52259	0.2563	3.5950	0.03147	0.0871	4.3706	17.891	68.861	328.62	1049.6	0.02471
1	0.05332	0.51973	0.2473	3.5379	0.03040	0.0838	4.2874	17.242	67.003	311.98	1020.8	0.02406
2	0.05217	0.51691	0.2388	3.4823	0.02947	0.0807	4.2053	16.606	65.169	295.97	993.3	0.02345
3	0.05104	0.51412	0.2306	3.4280	0.02856	0.0777	4.1243	15.983	63.360	280.58	967.0	0.02287
4	0.04993	0.51135	0.2227	3.3750	0.02770	0.0748	4.0442	15.373	61.576	265.81	941.9	0.02237
5	0.04885	0.50861	0.2153	3.3234	0.02689	0.0720	3.9652	14.776	59.816	251.67	917.9	0.02179
6	0.04778	0.50590	0.2082	3.2732	0.02613	0.0693	3.8872	14.193	58.080	238.16	895.0	0.02128
7	0.04674	0.50322	0.2018	3.2243	0.02541	0.0668	3.8103	13.623	56.369	225.25	873.1	0.02080
8	0.04571	0.50057	0.1952	3.1768	0.02474	0.0644	3.7345	13.066	54.683	212.98	852.1	0.02034
9	0.04470	0.49795	0.1893	3.1307	0.02412	0.0621	3.6596	12.523	53.021	201.33	832.0	0.01992
10	0.04372	0.49535	0.1837	3.0859	0.02355	0.0599	3.5858	11.992	51.383	190.31	812.8	0.01953
11	0.04275	0.49278	0.1786	3.0425	0.02303	0.0578	3.5132	11.475	49.770	179.91	794.3	0.01916
12	0.04180	0.49024	0.1737	3.0005	0.02257	0.0559	3.4415	10.971	48.182	170.13	776.6	0.01882
13	0.04088	0.48773	0.1693	2.9598	0.02216	0.0541	3.3708	10.480	46.618	160.98	759.6	0.01851
14	0.03997	0.48525	0.1652	2.9205	0.02179	0.0524	3.3012	10.003	45.079	152.45	743.1	0.01822
15	0.03909	0.48280	0.1615	2.8825	0.02147	0.0508	3.2326	9.539	43.564	144.55	727.2	0.01795
16	0.03837	0.48037	0.1583	2.8459	0.02121	0.0493	3.1651	9.058	42.073	137.27	711.8	0.01771
17	0.03759	0.47798	0.1553	2.8107	0.02100	0.0480	3.0986	8.650	40.608	130.61	696.9	0.01750
18	0.03687	0.47561	0.1528	2.7768	0.02084	0.0468	3.0331	8.225	39.165	124.58	682.3	0.01732
19	0.03577	0.47327	0.1506	2.7443	0.02073	0.0457	2.9687	7.814	37.749	119.17	668.0	0.01717
20	0.03499	0.47096	0.1488	2.7131	0.02065	0.0447	2.9053	7.415	36.216	114.48	654.0	0.01704
21		0.46867		2.6833			2.8430	7.030	34.986	110.22	640.2	
22		0.46642		2.6549			2.7817	6.659	33.910	106.68	626.5	
23		0.46419		2.6279			2.7215	6.300	32.847	103.77	613.0	
24		0.46199		2.6022			2.6623	5.955	31.800	101.47	599.5	

TABLE VIII.

TABLE OF THE TENSION OF THE VAPOR OF ABSOLUTE ALCOHOL,
ACCORDING TO REGNAULT.*

° C.	Tension.	° C.	Tension.	° C.	Tension.	° C.	Tension.
°	m. m.	°	m. m.	°	m. m.	°	m. m.
0.0	12.73	4.0	16.62	8.0	21.31	12.0	27.19
0.1	12.82	4.1	16.73	8.1	21.45	12.1	27.36
0.2	12.91	4.2	16.84	8.2	21.58	12.2	27.53
0.3	13.01	4.3	16.95	8.3	21.72	12.3	27.70
0.4	13.10	4.4	17.05	8.4	21.85	12.4	27.87
0.5	13.19	4.5	17.16	8.5	21.99	12.5	28.04
0.6	13.28	4.6	17.27	8.6	22.12	12.6	28.21
0.7	13.37	4.7	17.38	8.7	22.25	12.7	28.38
0.8	13.46	4.8	17.48	8.8	22.39	12.8	28.55
0.9	13.56	4.9	17.59	8.9	22.52	12.9	28.72
1.0	13.65	5.0	17.70	9.0	22.66	13.0	28.89
1.1	13.74	5.1	17.82	9.1	22.80	13.1	29.07
1.2	13.84	5.2	17.93	9.2	22.94	13.2	29.25
1.3	13.93	5.3	18.04	9.3	23.08	13.3	29.43
1.4	14.03	5.4	18.16	9.4	23.23	13.4	29.61
1.5	14.12	5.5	18.27	9.5	23.37	13.5	29.79
1.6	14.22	5.6	18.38	9.6	23.51	13.6	29.97
1.7	14.31	5.7	18.50	9.7	23.65	13.7	30.15
1.8	14.41	5.8	18.61	9.8	23.79	13.8	30.23
1.9	14.50	5.9	18.73	9.9	23.94	13.9	30.51
2.0	14.60	6.0	18.84	10.0	24.08	14.0	30.69
2.1	14.70	6.1	18.96	10.1	24.23	14.1	30.88
2.2	14.79	6.2	19.08	10.2	24.38	14.2	31.07
2.3	14.89	6.3	19.20	10.3	24.53	14.3	31.26
2.4	14.99	6.4	19.32	10.4	24.68	14.4	31.45
2.5	15.09	6.5	19.44	10.5	24.83	14.5	31.64
2.6	15.19	6.6	19.56	10.6	24.99	14.6	31.84
2.7	15.29	6.7	19.68	10.7	25.14	14.7	32.03
2.8	15.39	6.8	19.80	10.8	25.29	14.8	32.22
2.9	15.49	6.9	19.92	10.9	25.44	14.9	32.41
3.0	15.59	7.0	20.04	11.0	25.59	15.0	32.60
3.1	15.69	7.1	20.17	11.1	25.75	15.1	32.80
3.2	15.79	7.2	20.30	11.2	25.91	15.2	33.01
3.3	15.90	7.3	20.43	11.3	26.07	15.3	33.21
3.4	16.00	7.4	20.55	11.4	26.23	15.4	33.41
3.5	16.10	7.5	20.68	11.5	26.39	15.5	33.61
3.6	16.21	7.6	20.81	11.6	26.55	15.6	33.82
3.7	16.31	7.7	20.93	11.7	26.71	15.7	34.02
3.8	16.41	7.8	21.06	11.8	26.87	15.8	34.22
3.9	16.52	7.9	21.19	11.9	27.03	15.9	34.42

* This table is calculated from recent experiments of Regnault.

° C.	Tension.	° C.	Tension.	° C.	Tension.	° C.	Tension.
°	m. m.	°	m. m.	°	m. m.	°	m. m.
16.0	34.62	20.0	44.00	24.0	55.70	28.0	70.02
16.1	34.84	20.1	44.27	24.1	56.04	28.1	70.49
16.2	35.05	20.2	44.54	24.2	56.37	28.2	70.89
16.3	35.27	20.3	44.81	24.3	56.70	28.3	71.29
16.4	35.48	20.4	45.08	24.4	57.03	28.4	71.69
16.5	35.70	20.5	45.35	24.5	57.37	28.5	72.09
16.6	35.91	20.6	45.61	24.6	57.70	28.6	72.49
16.7	36.13	20.7	45.88	24.7	58.03	28.7	72.89
16.8	36.34	20.8	46.15	24.8	58.36	28.8	73.29
16.9	36.56	20.9	46.42	24.9	58.70	28.9	73.69
17.0	36.77	21.0	46.69	25.0	59.03	29.0	74.09
17.1	37.00	21.1	46.98	25.1	59.38	29.1	74.53
17.2	37.23	21.2	47.26	25.2	59.73	29.2	74.96
17.3	37.45	21.3	47.55	25.3	60.08	29.3	75.39
17.4	37.68	21.4	47.83	25.4	60.43	29.4	75.82
17.5	37.91	21.5	48.12	25.5	60.78	29.5	76.25
17.6	38.14	21.6	48.40	25.6	61.13	29.6	76.68
17.7	38.36	21.7	48.69	25.7	61.48	29.7	77.12
17.8	38.59	21.8	48.97	25.8	61.83	29.8	77.55
17.9	38.82	21.9	49.26	25.9	62.18	29.9	77.98
						30.0	78.41
18.0	39.05	22.0	49.54	26.0	62.53		
18.1	39.29	22.1	49.84	26.1	62.90		
18.2	39.53	22.2	50.14	26.2	63.27		
18.3	39.77	22.3	50.44	26.3	63.64		
18.4	40.01	22.4	50.74	26.4	64.01		
18.5	40.25	22.5	51.04	26.5	64.37		
18.6	40.49	22.6	51.34	26.6	64.74		
18.7	40.73	22.7	51.64	26.7	65.11		
18.8	40.97	22.8	51.94	26.8	65.48		
18.9	41.21	22.9	52.24	26.9	65.85		
19.0	41.45	23.0	52.54	27.0	66.22		
19.1	41.71	23.1	52.86	27.1	66.60		
19.2	41.96	23.2	53.17	27.2	66.99		
19.3	42.22	23.3	53.49	27.3	67.38		
19.4	42.47	23.4	53.81	27.4	67.77		
19.5	42.73	23.5	54.12	27.5	68.15		
19.6	42.98	23.6	54.44	27.6	68.54		
19.7	43.24	23.7	54.75	27.7	68.93		
19.8	43.49	23.8	55.07	27.8	69.31		
19.9	43.75	23.9	55.38	27.9	69.70		

TABLE IX.

TABLE FOR THE TENSION OF AQUEOUS VAPOR FOR TEMPERATURES FROM -32° TO $+230^{\circ}$, BY REGNAULT.

Temperature.	Tension in Centimetres.	Temperature.	Tension in Centimetres.	Temperature.	Tension in Centimetres.
-32°	0.0320	$+19^{\circ}$	1.6346	$+105^{\circ}$	90.6410
30	0.0386	20	1.7391	110	107.5370
25	0.0605	21	1.8495	115	126.9410
20	0.0927	22	1.9659	120	149.1280
15	0.1400	23	2.0888	125	174.388
10	0.2093	24	2.2184	130	203.028
- 5	0.3113	25	2.3550	135	235.373
0	0.4600	26	2.4988	140	271.763
+ 1	0.4940	27	2.6505	145	312.555
2	0.5302	28	2.8101	150	358.123
3	0.5687	29	2.9782	155	408.856
4	0.6097	30	3.1548	160	465.162
5	0.6534	35	4.1827	165	527.454
6	0.6998	40	5.4906	170	596.166
7	0.7492	45	7.1391	175	671.743
8	0.8017	50	9.1982	180	754.639
9	0.8574	55	11.7478	185	845.323
10	0.9165	60	14.8791	190	944.270
11	0.9792	65	18.6945	195	1051.963
12	1.0457	70	23.3093	200	1168.896
13	1.1162	75	28.8517	205	1295.566
14	1.1908	80	35.4643	210	1432.480
15	1.2699	85	43.3041	215	1580.133
16	1.3536	90	52.5450	220	1739.036
17	1.4421	95	63.3778	225	1909.704
18	1.5357	100	76.0000	230	2092.640

Tension of Vapor of Water, according to Dulong and Arago.

Temperature.	Tension in Atmospheres.	Pressure in Kilogrammes on 1 c. m. ²	Temperature.	Tension in Atmospheres.	Pressure in Kilogrammes on 1 c. m. ²
100°	1	1.033	226.3°	25	25.825
121.4	2	2.066	265.89	50	51.650
135.1	3	3.099	311.36	100	103.3
145.4	4	4.106	363.58	200	206.6
160.2	6	6.198	423.57	400	413.2
172.1	8	8.264	462.71	600	619.8
190.0	12	12.396	492.47	800	826.4
203.6	16	16.528	516.75	1000	1033.0
214.7	20	20.660			

TABLE X.

TABLE FOR THE TENSION OF AQUEOUS VAPOR FOR TEMPERATURES FROM -2° TO $+35^{\circ}$ C, ACCORDING TO REGNAULT.

$^{\circ}$ C.	Tension.	$^{\circ}$ C.	Tension.	$^{\circ}$ C.	Tension.	$^{\circ}$ C.	Tension.
$^{\circ}$	m. m.	$^{\circ}$	m. m.	$^{\circ}$	m. m.	$^{\circ}$	m. m.
-2.0	3.955	+2.0	5.302	+6.0	6.993	+10.0	9.165
1.9	3.985	2.1	5.340	6.1	7.047	10.1	9.227
1.8	4.016	2.2	5.378	6.2	7.095	10.2	9.288
1.7	4.047	2.3	5.416	6.3	7.144	10.3	9.350
1.6	4.078	2.4	5.454	6.4	7.193	10.4	9.412
1.5	4.109	2.5	5.491	6.5	7.242	10.5	9.474
1.4	4.140	2.6	5.530	6.6	7.292	10.6	9.537
1.3	4.171	2.7	5.569	6.7	7.342	10.7	9.601
1.2	4.203	2.8	5.603	6.8	7.392	10.8	9.665
1.1	4.235	2.9	5.647	6.9	7.442	10.9	9.728
1.0	4.267	3.0	5.687	7.0	7.492	11.0	9.792
0.9	4.299	3.1	5.727	7.1	7.544	11.1	9.857
0.8	4.331	3.2	5.767	7.2	7.595	11.2	9.923
0.7	4.364	3.3	5.807	7.3	7.647	11.3	9.989
0.6	4.397	3.4	5.848	7.4	7.699	11.4	10.054
0.5	4.430	3.5	5.889	7.5	7.751	11.5	10.120
0.4	4.463	3.6	5.930	7.6	7.804	11.6	10.187
0.3	4.497	3.7	5.972	7.7	7.857	11.7	10.255
0.2	4.531	3.8	6.014	7.8	7.910	11.8	10.322
-0.1	4.565	3.9	6.055	7.9	7.964	11.9	10.389
0.0	4.600	4.0	6.097	8.0	8.017	12.0	10.457
+0.1	4.633	4.1	6.140	8.1	8.072	12.1	10.526
0.2	4.667	4.2	6.183	8.2	8.126	12.2	10.596
0.3	4.700	4.3	6.226	8.3	8.181	12.3	10.665
0.4	4.733	4.4	6.270	8.4	8.236	12.4	10.734
0.5	4.767	4.5	6.313	8.5	8.291	12.5	10.804
0.6	4.801	4.6	6.357	8.6	8.347	12.6	10.875
0.7	4.836	4.7	6.401	8.7	8.404	12.7	10.947
0.8	4.871	4.8	6.445	8.8	8.461	12.8	11.019
0.9	4.905	4.9	6.490	8.9	8.517	12.9	11.090
1.0	4.940	5.0	6.534	9.0	8.574	13.0	11.162
1.1	4.975	5.1	6.580	9.1	8.632	13.1	11.235
1.2	5.011	5.2	6.625	9.2	8.690	13.2	11.309
1.3	5.047	5.3	6.671	9.3	8.748	13.3	11.383
1.4	5.082	5.4	6.717	9.4	8.807	13.4	11.456
1.5	5.118	5.5	6.763	9.5	8.865	13.5	11.530
1.6	5.155	5.6	6.810	9.6	8.925	13.6	11.605
1.7	5.191	5.7	6.857	9.7	8.985	13.7	11.681
1.8	5.228	5.8	6.904	9.8	9.045	13.8	11.757
1.9	5.265	5.9	6.951	9.9	9.105	13.9	11.832

° C.	Tension.	° C.	Tension.	° C.	Tension.	° C.	Tension.
°	m. m.	°	m. m.	°	m. m.	°	m. m.
+14.0	11.908	+18.0	15.357	+22.0	19.659	+26.0	24.988
14.1	11.986	18.1	15.454	22.1	19.780	26.1	25.138
14.2	12.064	18.2	15.552	22.2	19.901	26.2	25.288
14.3	12.142	18.3	15.650	22.3	20.022	26.3	25.438
14.4	12.220	18.4	15.747	22.4	20.143	26.4	25.588
14.5	12.298	18.5	15.845	22.5	20.265	26.5	25.738
14.6	12.378	18.6	15.945	22.6	20.389	26.6	25.891
14.7	12.458	18.7	16.045	22.7	20.514	26.7	26.045
14.8	12.538	18.8	16.145	22.8	20.639	26.8	26.198
14.9	12.619	18.9	16.246	22.9	20.763	26.9	26.351
15.0	12.699	19.0	16.346	23.0	20.888	27.0	26.505
15.1	12.781	19.1	16.449	23.1	21.016	27.1	26.663
15.2	12.864	19.2	16.552	23.2	21.144	27.2	26.820
15.3	12.947	19.3	16.655	23.3	21.272	27.3	26.978
15.4	13.029	19.4	16.758	23.4	21.400	27.4	27.136
15.5	13.112	19.5	16.861	23.5	21.528	27.5	27.294
15.6	13.197	19.6	16.967	23.6	21.659	27.6	27.455
15.7	13.281	19.7	17.073	23.7	21.790	27.7	27.617
15.8	13.366	19.8	17.179	23.8	21.921	27.8	27.778
15.9	13.451	19.9	17.285	23.9	22.053	27.9	27.939
16.0	13.536	20.0	17.391	24.0	22.184	28.0	28.101
16.1	13.623	20.1	17.500	24.1	22.319	28.1	28.267
16.2	13.710	20.2	17.608	24.2	22.453	28.2	28.433
16.3	13.797	20.3	17.717	24.3	22.588	28.3	28.599
16.4	13.885	20.4	17.826	24.4	22.723	28.4	28.765
16.5	13.972	20.5	17.935	24.5	22.858	28.5	28.931
16.6	14.062	20.6	18.047	24.6	22.996	28.6	29.101
16.7	14.151	20.7	18.159	24.7	23.135	28.7	29.271
16.8	14.241	20.8	18.271	24.8	23.273	28.8	29.441
16.9	14.331	20.9	18.383	24.9	23.411	28.9	29.612
17.0	14.421	21.0	18.495	25.0	23.550	29.0	29.782
17.1	14.513	21.1	18.610	25.1	23.692	29.1	29.956
17.2	14.605	21.2	18.724	25.2	23.834	29.2	30.131
17.3	14.697	21.3	18.839	25.3	23.976	29.3	30.305
17.4	14.790	21.4	18.954	25.4	24.119	29.4	30.479
17.5	14.882	21.5	19.069	25.5	24.261	29.5	30.654
17.6	14.977	21.6	19.187	25.6	24.406	29.6	30.833
17.7	15.072	21.7	19.305	25.7	24.552	29.7	31.011
17.8	15.167	21.8	19.423	25.8	24.697	29.8	31.190
17.9	15.262	21.9	19.541	25.9	24.842	29.9	31.369

° C.	Tension.	° C.	Tension.	° C.	Tension.	° C.	Tension.
	m. m.	°	m. m.	°	m. m.	°	m. m.
+30.0	31.548	+31.0	33.405	+32.0	35.359	+33.0	37.410
30.1	31.729	31.1	33.596	32.1	35.559	33.1	37.621
30.2	31.911	31.2	33.787	32.2	35.760	33.2	37.832
30.3	32.094	31.3	33.980	32.3	35.962	33.3	38.045
30.4	32.278	31.4	34.174	32.4	36.165	33.4	38.258
30.5	32.463	31.5	34.368	32.5	36.370	33.5	38.473
30.6	32.650	31.6	34.564	32.6	36.576	33.6	38.689
30.7	32.837	31.7	34.761	32.7	36.783	33.7	38.906
30.8	33.026	31.8	34.959	32.8	36.991	33.8	39.124
30.9	33.215	31.9	35.159	32.9	37.200	33.9	39.344
34.0	39.565	34.3	40.230	34.6	40.907	34.9	41.595
34.1	39.786	34.4	40.455	34.7	41.135	35.0	41.827
34.2	40.007	34.5	40.680	34.8	41.364		

TABLE XI.

TABLE FOR THE CALCULATION OF THE VALUE OF $1 + 0.00366 t$.

t .	Number.	Log.	t .	Number.	Log.
°			°		
-2.0	0.99268	9.99631	0.0	1.00000	0.00000
1.9	0.99305	9.99697	+0.1	1.00037	0.00016
1.8	0.99341	9.99713	0.2	1.00073	0.00032
1.7	0.99378	9.99729	0.3	1.00110	0.00048
1.6	0.99414	9.99745	0.4	1.00146	0.00063
1.5	0.99451	9.99761	0.5	1.00183	0.00079
1.4	0.99488	9.99777	0.6	1.00220	0.00095
1.3	0.99524	9.99793	0.7	1.00256	0.00111
1.2	0.99561	9.99809	0.8	1.00293	0.00127
1.1	0.99597	9.99825	0.9	1.00329	0.00143
1.0	0.99634	9.99841	1.0	1.00366	0.00159
0.9	0.99671	9.99857	1.1	1.00403	0.00175
0.8	0.99707	9.99873	1.2	1.00439	0.00191
0.7	0.99744	9.99888	1.3	1.00476	0.00207
0.6	0.99780	9.99904	1.4	1.00512	0.00222
0.5	0.99817	9.99920	1.5	1.00549	0.00238
0.4	0.99854	9.99937	1.6	1.00586	0.00254
0.3	0.99890	9.99952	1.7	1.00622	0.00270
0.2	0.99927	9.99968	1.8	1.00659	0.00285
-0.1	0.99963	9.99984	1.9	1.00695	0.00301

z .	Number.	Log.	z .	Number.	Log.
$\overset{\circ}{+}2.0$	1.00732	0.00317	$\overset{\circ}{+}6.0$	1.02196	0.00943
2.1	1.00769	0.00333	6.1	1.02233	0.00959
2.2	1.00805	0.00349	6.2	1.02269	0.00975
2.3	1.00842	0.00365	6.3	1.02306	0.00991
2.4	1.00878	0.00381	6.4	1.02342	0.01006
2.5	1.00915	0.00397	6.5	1.02379	0.01022
2.6	1.00952	0.00412	6.6	1.02416	0.01038
2.7	1.00988	0.00428	6.7	1.02452	0.01054
2.8	1.01025	0.00444	6.8	1.02489	0.01069
2.9	1.01061	0.00459	6.9	1.02525	0.01084
3.0	1.01098	0.00474	7.0	1.02562	0.01099
3.1	1.01135	0.00490	7.1	1.02599	0.01115
3.2	1.01171	0.00506	7.2	1.02635	0.01131
3.3	1.01208	0.00521	7.3	1.02672	0.01147
3.4	1.01244	0.00537	7.4	1.02708	0.01162
3.5	1.01281	0.00553	7.5	1.02745	0.01177
3.6	1.01318	0.00568	7.6	1.02782	0.01193
3.7	1.01354	0.00584	7.7	1.02818	0.01208
3.8	1.01391	0.00600	7.8	1.02855	0.01223
3.9	1.01427	0.00615	7.9	1.02891	0.01238
4.0	1.01464	0.00631	8.0	1.02928	0.01253
4.1	1.01501	0.00647	8.1	1.02965	0.01269
4.2	1.01537	0.00663	8.2	1.03001	0.01284
4.3	1.01574	0.00678	8.3	1.03038	0.01300
4.4	1.01610	0.00694	8.4	1.03074	0.01315
4.5	1.01647	0.00710	8.5	1.03111	0.01330
4.6	1.01684	0.00725	8.6	1.03148	0.01346
4.7	1.01720	0.00741	8.7	1.03184	0.01361
4.8	1.01757	0.00756	8.8	1.03221	0.01377
4.9	1.01793	0.00772	8.9	1.03257	0.01392
5.0	1.01830	0.00788	9.0	1.03294	0.01407
5.1	1.01867	0.00803	9.1	1.03331	0.01423
5.2	1.01903	0.00819	9.2	1.03367	0.01438
5.3	1.01940	0.00834	9.3	1.03404	0.01454
5.4	1.01976	0.00850	9.4	1.03440	0.01469
5.5	1.02013	0.00865	9.5	1.03477	0.01484
5.6	1.02050	0.00881	9.6	1.03514	0.01500
5.7	1.02086	0.00896	9.7	1.03550	0.01515
5.8	1.02123	0.00912	9.8	1.03587	0.01530
5.9	1.02159	0.00927	9.9	1.03623	0.01545

<i>t.</i>	Number.	Log.	<i>t.</i>	Number.	Log.
+10.0	1.03660	0.01561	+14.0	1.05124	0.02170
10.1	1.03697	0.01577	14.1	1.05161	0.02185
10.2	1.03733	0.01592	14.2	1.05197	0.02200
10.3	1.03770	0.01607	14.3	1.05234	0.02215
10.4	1.03806	0.01623	14.4	1.05270	0.02230
10.5	1.03843	0.01639	14.5	1.05307	0.02246
10.6	1.03880	0.01653	14.6	1.05344	0.02261
10.7	1.03916	0.01669	14.7	1.05380	0.02276
10.8	1.03953	0.01683	14.8	1.05417	0.02291
10.9	1.03989	0.01698	14.9	1.05453	0.02306
11.0	1.04026	0.01714	15.0	1.05490	0.02321
11.1	1.04063	0.01729	15.1	1.05527	0.02336
11.2	1.04099	0.01744	15.2	1.05563	0.02351
11.3	1.04136	0.01759	15.3	1.05600	0.02366
11.4	1.04172	0.01775	15.4	1.05636	0.02381
11.5	1.04209	0.01790	15.5	1.05673	0.02396
11.6	1.04246	0.01805	15.6	1.05710	0.02411
11.7	1.04282	0.01820	15.7	1.05746	0.02426
11.8	1.04319	0.01836	15.8	1.05783	0.02441
11.9	1.04355	0.01851	15.9	1.05819	0.02456
12.0	1.04392	0.01867	16.0	1.05856	0.02471
12.1	1.04429	0.01882	16.1	1.05893	0.02486
12.2	1.04465	0.01897	16.2	1.05929	0.02501
12.3	1.04502	0.01912	16.3	1.05966	0.02516
12.4	1.04538	0.01928	16.4	1.06002	0.02531
12.5	1.04575	0.01943	16.5	1.06039	0.02546
12.6	1.04612	0.01958	16.6	1.06076	0.02561
12.7	1.04648	0.01973	16.7	1.06112	0.02576
12.8	1.04685	0.01989	16.8	1.06149	0.02591
12.9	1.04721	0.02004	16.9	1.06185	0.02606
13.0	1.04758	0.02019	17.0	1.06222	0.02621
13.1	1.04795	0.02034	17.1	1.06259	0.02636
13.2	1.04831	0.02049	17.2	1.06295	0.02651
13.3	1.04868	0.02064	17.3	1.06332	0.02666
13.4	1.04904	0.02079	17.4	1.06368	0.02681
13.5	1.04941	0.02095	17.5	1.06405	0.02696
13.6	1.04978	0.02110	17.6	1.06442	0.02711
13.7	1.05014	0.02125	17.7	1.06478	0.02726
13.8	1.05051	0.02140	17.8	1.06515	0.02741
13.9	1.05087	0.02155	17.9	1.06551	0.02756

<i>t.</i>	Number.	Log.	<i>t.</i>	Number.	Log.
+18.0	1.06588	0.02771	+22.0	1.08052	0.03363
18.1	1.06625	0.02786	22.1	1.08089	0.03378
18.2	1.06661	0.02801	22.2	1.08125	0.03393
18.3	1.06698	0.02816	22.3	1.08162	0.03408
18.4	1.06734	0.02831	22.4	1.08198	0.03422
18.5	1.06771	0.02846	22.5	1.08235	0.03437
18.6	1.06808	0.02861	22.6	1.08272	0.03452
18.7	1.06844	0.02876	22.7	1.08308	0.03466
18.8	1.06881	0.02891	22.8	1.08345	0.03481
18.9	1.06917	0.02906	22.9	1.08381	0.03496
19.0	1.06954	0.02921	23.0	1.08418	0.03510
19.1	1.06991	0.02936	23.1	1.08455	0.03525
19.2	1.07027	0.02951	23.2	1.08491	0.03539
19.3	1.07064	0.02965	23.3	1.08528	0.03554
19.4	1.07100	0.02980	23.4	1.08564	0.03568
19.5	1.07137	0.02995	23.5	1.08601	0.03583
19.6	1.07174	0.03009	23.6	1.08638	0.03598
19.7	1.07210	0.03024	23.7	1.08674	0.03612
19.8	1.07247	0.03039	23.8	1.08711	0.03627
19.9	1.07283	0.03053	23.9	1.08747	0.03642
20.0	1.07320	0.03068	24.0	1.08784	0.03656
20.1	1.07357	0.03083	24.1	1.08821	0.03671
20.2	1.07393	0.03098	24.2	1.08857	0.03685
20.3	1.07430	0.03113	24.3	1.08894	0.03700
20.4	1.07466	0.03128	24.4	1.08930	0.03714
20.5	1.07503	0.03142	24.5	1.08967	0.03729
20.6	1.07540	0.03157	24.6	1.09004	0.03744
20.7	1.07576	0.03172	24.7	1.09040	0.03758
20.8	1.07613	0.03187	24.8	1.09077	0.03772
20.9	1.07649	0.03201	24.9	1.09113	0.03787
21.0	1.07686	0.03216	25.0	1.09150	0.03802
21.1	1.07723	0.03231	25.1	1.09187	0.03817
21.2	1.07759	0.03246	25.2	1.09223	0.03831
21.3	1.07796	0.03261	25.3	1.09260	0.03846
21.4	1.07832	0.03275	25.4	1.09296	0.03860
21.5	1.07869	0.03290	25.5	1.09333	0.03875
21.6	1.07906	0.03305	25.6	1.09370	0.03889
21.7	1.07942	0.03320	25.7	1.09406	0.03904
21.8	1.07979	0.03334	25.8	1.09443	0.03918
21.9	1.08015	0.03349	25.9	1.09479	0.03933

<i>t.</i>	Number.	Log.	<i>t.</i>	Number.	Log.
+26.0	1.09516	0.03948	+30.0	1.10980	0.04524
26.1	1.09553	0.03963	30.1	1.11017	0.04538
26.2	1.09589	0.03977	30.2	1.11053	0.04552
26.3	1.09626	0.03992	30.3	1.11090	0.04567
26.4	1.09662	0.04006	30.4	1.11126	0.04581
26.5	1.09699	0.04021	30.5	1.11163	0.04595
26.6	1.09736	0.04035	30.6	1.11200	0.04610
26.7	1.09772	0.04050	30.7	1.11236	0.04624
26.8	1.09809	0.04064	30.8	1.11273	0.04638
26.9	1.09845	0.04079	30.9	1.11309	0.04653
27.0	1.09882	0.04093	31.0	1.11346	0.04667
27.1	1.09919	0.04107	31.1	1.11383	0.04681
27.2	1.09955	0.04122	31.2	1.11419	0.04695
27.3	1.09992	0.04136	31.3	1.11456	0.04710
27.4	1.10028	0.04150	31.4	1.11492	0.04724
27.5	1.10065	0.04165	31.5	1.11529	0.04738
27.6	1.10102	0.04179	31.6	1.11566	0.04753
27.7	1.10138	0.04193	31.7	1.11602	0.04767
27.8	1.10175	0.04208	31.8	1.11639	0.04781
27.9	1.10211	0.04222	31.9	1.11675	0.04796
28.0	1.10248	0.04237	32.0	1.11712	0.04810
28.1	1.10285	0.04251	32.1	1.11749	0.04824
28.2	1.10321	0.04266	32.2	1.11785	0.04838
28.3	1.10358	0.04280	32.3	1.11822	0.04852
28.4	1.10394	0.04295	32.4	1.11858	0.04866
28.5	1.10431	0.04309	32.5	1.11895	0.04881
28.6	1.10468	0.04323	32.6	1.11932	0.04895
28.7	1.10504	0.04338	32.7	1.11968	0.04909
28.8	1.10541	0.04352	32.8	1.12005	0.04923
28.9	1.10577	0.04367	32.9	1.12041	0.04938
29.0	1.10614	0.04381	33.0	1.12078	0.04952
29.1	1.10651	0.04395	33.1	1.12115	0.04966
29.2	1.10687	0.04410	33.2	1.12151	0.04980
29.3	1.10724	0.04424	33.3	1.12188	0.04994
29.4	1.10760	0.04438	33.4	1.12224	0.05008
29.5	1.10797	0.04453	33.5	1.12261	0.05022
29.6	1.10834	0.04467	33.6	1.12298	0.05036
29.7	1.10870	0.04482	33.7	1.12334	0.05050
29.8	1.10907	0.04496	33.8	1.12371	0.05065
29.9	1.10943	0.04510	33.9	1.12407	0.05079

<i>t.</i>	Number.	Log.	<i>t.</i>	Number.	Log.
+34.0	1.12444	0.05094	+37.0	1.13542	0.05516
34.1	1.12481	0.05108	37.1	1.13579	0.05530
34.2	1.12517	0.05122	37.2	1.13615	0.05544
34.3	1.12554	0.05136	37.3	1.13652	0.05558
34.4	1.12590	0.05150	37.4	1.13688	0.05572
34.5	1.12627	0.05164	37.5	1.13725	0.05585
34.6	1.12664	0.05178	37.6	1.13762	0.05599
34.7	1.12700	0.05193	37.7	1.13798	0.05613
34.8	1.12737	0.05207	37.8	1.13835	0.05627
34.9	1.12773	0.05221	37.9	1.13871	0.05641
35.0	1.12810	0.05235	38.0	1.13908	0.05655
35.1	1.12847	0.05249	38.1	1.13945	0.05669
35.2	1.12883	0.05263	38.2	1.13981	0.05683
35.3	1.12920	0.05277	38.3	1.14018	0.05697
35.4	1.12956	0.05291	38.4	1.14054	0.05711
35.5	1.12993	0.05305	38.5	1.14091	0.05725
35.6	1.13030	0.05319	38.6	1.14128	0.05739
35.7	1.13066	0.05333	38.7	1.14164	0.05753
35.8	1.13103	0.05347	38.8	1.14201	0.05767
35.9	1.13139	0.05361	38.9	1.14237	0.05781
36.0	1.13176	0.05375	39.0	1.14274	0.05795
36.1	1.13213	0.05389	39.1	1.14311	0.05809
36.2	1.13249	0.05403	39.2	1.14347	0.05823
36.3	1.13286	0.05417	39.3	1.14384	0.05837
36.4	1.13322	0.05431	39.4	1.14420	0.05850
36.5	1.13359	0.05446	39.5	1.14457	0.05864
36.6	1.13396	0.05460	39.6	1.14494	0.05878
36.7	1.13432	0.05474	39.7	1.14530	0.05892
36.8	1.13469	0.05488	39.8	1.14567	0.05905
36.9	1.13505	0.05502	39.9	1.14603	0.05919
40	1.14640	0.05934	50	1.18300	0.07298
41	1.15006	0.06072	51	1.18666	0.07433
42	1.15372	0.06210	52	1.19032	0.07566
43	1.15738	0.06348	53	1.19398	0.07700
44	1.16104	0.06485	54	1.19764	0.07833
45	1.16470	0.06621	55	1.20130	0.07965
46	1.16836	0.06758	56	1.20496	0.08097
47	1.17202	0.06893	57	1.20862	0.08229
48	1.17568	0.07029	58	1.21228	0.08360
49	1.17934	0.07164	59	1.21594	0.08491

TABLE XII.

TABLE FOR THE CALCULATION OF THE VALUE OF $1 + 0.00367 t$.

<i>t.</i>	log.	Diff.	<i>t.</i>	log.	Diff.	<i>t.</i>	log.	Diff.
60	0.08643	131	100	0.13577	117	140	0.18007	105
61	0.08772	131	101	0.13693	116	141	0.18112	105
62	0.08903	131	102	0.13809	116	142	0.18217	105
63	0.09033	130	103	0.13925	116	143	0.18322	105
64	0.09162	129	104	0.14041	116	144	0.18426	104
65	0.09291	129	105	0.14156	115	145	0.18530	104
66	0.09420	129	106	0.14271	115	146	0.18634	104
67	0.09548	128	107	0.14385	114	147	0.18738	104
68	0.09676	128	108	0.14499	114	148	0.18841	103
69	0.09803	127	109	0.14613	114	149	0.18944	103
70	0.09930	127	110	0.14727	114	150	0.19047	103
71	0.10057	127	111	0.14841	114	151	0.19150	102
72	0.10183	126	112	0.14954	113	152	0.19252	102
73	0.10309	126	113	0.15067	113	153	0.19354	102
74	0.10434	125	114	0.15179	112	154	0.19456	102
75	0.10559	125	115	0.15291	112	155	0.19558	102
76	0.10684	125	116	0.15403	112	156	0.19660	102
77	0.10809	125	117	0.15515	112	157	0.19761	101
78	0.10933	124	118	0.15626	111	158	0.19862	101
79	0.11057	124	119	0.15737	111	159	0.19963	101
80	0.11180	123	120	0.15848	111	160	0.20063	100
81	0.11303	123	121	0.15959	111	161	0.20163	100
82	0.11426	123	122	0.16069	110	162	0.20263	100
83	0.11548	122	123	0.16179	110	163	0.20363	100
84	0.11670	122	124	0.16289	110	164	0.20463	100
85	0.11792	122	125	0.16398	109	165	0.20562	99
86	0.11913	121	126	0.16507	109	166	0.20661	99
87	0.12034	121	127	0.16616	109	167	0.20760	99
88	0.12155	121	128	0.16725	109	168	0.20859	99
89	0.12275	120	129	0.16833	108	169	0.20958	99
90	0.12395	120	130	0.16941	108	170	0.21056	98
91	0.12515	120	131	0.17049	108	171	0.21154	98
92	0.12634	119	132	0.17156	107	172	0.21252	98
93	0.12753	119	133	0.17263	107	173	0.21350	98
94	0.12872	119	134	0.17370	107	174	0.21447	97
95	0.12990	118	135	0.17477	107	175	0.21544	97
96	0.13108	118	136	0.17584	107	176	0.21641	97
97	0.13226	118	137	0.17690	106	177	0.21738	97
98	0.13343	117	138	0.17796	106	178	0.21834	96
99	0.13460	117	139	0.17902	106	179	0.21930	96

<i>t.</i>	log.	Diff.	<i>t.</i>	log.	Diff.	<i>t.</i>	log.	Diff.
180	0.22026	96	220	0.25705	88	260	0.29027	82
181	0.22122	96	221	0.25793	88	261	0.29178	81
182	0.22218	96	222	0.25881	88	262	0.29260	82
183	0.22314	96	223	0.25969	88	263	0.29341	81
184	0.22409	95	224	0.26057	88	264	0.29422	81
185	0.22504	95	225	0.26144	87	265	0.29503	81
186	0.22599	95	226	0.26231	87	266	0.29584	81
187	0.22693	94	227	0.26318	87	267	0.29664	80
188	0.22787	94	228	0.26405	87	268	0.29745	81
189	0.22882	95	229	0.26492	87	269	0.29825	80
190	0.22976	94	230	0.26578	86	270	0.29905	80
191	0.23070	94	231	0.26665	87	271	0.29985	80
192	0.23163	93	232	0.26751	86	272	0.30064	79
193	0.23257	94	233	0.26837	86	273	0.30144	80
194	0.23350	93	234	0.26922	85	274	0.30224	80
195	0.23443	93	235	0.27008	86	275	0.30303	79
196	0.23536	93	236	0.27094	86	276	0.30383	80
197	0.23628	92	237	0.27179	85	277	0.30462	79
198	0.23721	93	238	0.27264	85	278	0.30541	79
199	0.23813	92	239	0.27349	85	279	0.30620	79
200	0.23905	92	240	0.27434	85	280	0.30698	78
201	0.23997	91	241	0.27519	85	281	0.30776	78
202	0.24088	92	242	0.27603	84	282	0.30855	79
203	0.24180	91	243	0.27688	85	283	0.30933	78
204	0.24271	91	244	0.27772	84	284	0.31011	78
205	0.24362	91	245	0.27856	84	285	0.31089	78
206	0.24453	91	246	0.27940	84	286	0.31167	78
207	0.24544	90	247	0.28023	83	287	0.31245	78
208	0.24634	92	248	0.28107	84	288	0.31323	78
209	0.24724	90	249	0.28190	83	289	0.31400	77
210	0.24814	90	250	0.28274	84	290	0.31477	77
211	0.24904	90	251	0.28357	83	291	0.31554	77
212	0.24994	90	252	0.28439	82	292	0.31631	77
213	0.25084	90	253	0.28522	83	293	0.31708	77
214	0.25173	89	254	0.28605	83	294	0.31785	77
215	0.25262	89	255	0.28687	82	295	0.31862	77
216	0.25351	89	256	0.28769	82	296	0.31938	76
217	0.25440	89	257	0.28851	82	297	0.32014	76
218	0.25529	89	258	0.28933	82	298	0.32091	77
219	0.25617	88	259	0.29015	82	299	0.32167	76

TABLE XIII.

Expansion of Glass.

TABLE FOR THE CALCULATION OF THE VALUE OF $1 + K(t' - t)$.

$$K = \frac{1}{2700}$$

$t' - t$.	log.	Diff.	$t' - t$.	log.	Diff.
100°	0.00117		200°	0.00234	12
110	0.00129	12	210	0.00246	12
120	0.00140	11	220	0.00257	11
130	0.00152	12	230	0.00269	12
140	0.00164	12	240	0.00281	12
150	0.00176	12	250	0.00293	12
160	0.00187	11	260	0.00304	11
170	0.00199	12	270	0.00316	12
180	0.00211	12	280	0.00328	12
190	0.00222	11	290	0.00339	11

TABLE XIV.

TABLE FOR THE CALCULATION OF THE WEIGHT OF ONE CUBIC CENTIMETRE OF AIR.

Weight at 0° = 0.0012932. $H_0 = 76$ c. m.

t .	log.	Diff.	t .	log.	Diff.
0°	7.11166		15°	7.08739	151
1	7.11007	159	16	7.08688	151
2	7.10848	159	17	7.08538	150
3	7.10690	158	18	7.08388	150
4	7.10533	157	19	7.09239	149
5	7.10376	157	20	7.08090	149
6	7.10220	156	21	7.07942	148
7	7.10064	156	22	7.07794	148
8	7.09909	155	23	7.07647	147
9	7.09755	154	24	7.07500	147
10	7.09601	154	25	7.07354	146
11	7.09447	154	26	7.07208	146
12	7.09294	153	27	7.07063	145
13	7.09142	152	28	7.06918	145
14	7.08990	152	29	7.06774	144

The following corrections must be added to the above logarithms when the barometer stands higher than 76 c. m., and subtracted from them when it stands lower. The correction for tenths and hundredths of centimetres is found by moving the decimal point one or two figures to the left.

Diff. in c. m.	Corr.	Diff. in c. m.	Corr.	Diff. in c. m.	Corr.
1	0.0057	4	0.0228	7	0.0399
2	0.0114	5	0.0285	8	0.0456
3	0.0171	6	0.0342	9	0.0513

TABLE XV.
EXPANSION OF SOLIDS.

Name of Substance.	Interval of Temperature.	Amount of Expansion.	
		Decimal Fractions.	Vulgar Fract.
<i>Linear Expansion determined by Lavoisier and Laplace.</i>			
English Flint-Glass,	0° to 100°	0.00081166	$\frac{1}{1248}$
Glass tube (without lead),	" " "	0.00087572	$\frac{1}{1142}$
Steel (not hardened),	" " "	0.00107880	$\frac{1}{927}$
Steel (hardened),	" " "	0.00123956	$\frac{1}{807}$
Soft Iron,	" " "	0.00122045	$\frac{1}{819}$
Gold,	" " "	0.00146606	$\frac{1}{682}$
Copper,	" " "	0.00171220	$\frac{1}{584}$
Brass,	" " "	0.00186760	$\frac{1}{535}$
Silver,	" " "	0.00190868	$\frac{1}{524}$
Tin,	" " "	0.00193765	$\frac{1}{516}$
Lead,	" " "	0.00284886	$\frac{1}{351}$
<i>By Dulong and Petit.</i>			
Platinum,	{ 0° to 100°	0.00088420	$\frac{1}{1131}$
	{ 0 to 300	0.00275482	$\frac{1}{363}$
Glass,	{ 0 to 100	0.00086133	$\frac{1}{1161}$
	{ 0 to 200	0.00184502	$\frac{1}{544}$
	{ 0 to 300	0.00303252	$\frac{1}{329}$
Iron,	{ 0 to 100	0.00118210	$\frac{1}{846}$
	{ 0 to 300	0.00440528	$\frac{1}{227}$
Copper,	{ 0 to 100	0.00171820	$\frac{1}{582}$
	{ 0 to 300	0.00564972	$\frac{1}{177}$
<i>By Wollaston.</i>			
Palladium,	0° to 100°	0.00100000	$\frac{1}{1000}$
<i>By Brunner. — Expansion for one Degree.</i>			
Ice,	-6° to 0°	0.0000375	$\frac{1}{177}$

Cubic Expansion determined by Kopp

Substance.	Formula.	Cub. Expan. for 1° C.	Substance.	Formula.	Cub. Expan. for 1° C.
Copper,	Cu	0.000051	Fluor-spar,	CaF	0.000062
Lead,	Pb	0.000089	Aragonite,	CaO, CO ₂	0.000065
Tin,	Sn	0.000069	Calc-spar,	CaO, CO ₂	0.000018
Iron,	Fe	0.000037	Bitter-spar,	{ CaO, CO ₂	0.000035
Zinc,	Zn	0.000089		{ + MgO, CO ₂	
Cadmium,	Cd	0.000094	Iron-spar,	{ Fe (Mn, Mg) O,	0.000035
Bismuth,	Bi	0.000040		{ CO ₂	
Antimony,	Sb	0.000033	Heavy-spar,	BaO, SO ₃	0.000058
Sulphur,	S	0.000183	Celestine,	SrO, SO ₃	0.000061
Galena,	PbS	0.000068	Quartz,	SiO ₃	0.000042
Zinc-blende,	ZnS	0.000036			0.000039
Iron pyrites,	FeS ₂	0.000034	Orthoclase,	{ KO, SiO ₃	0.000026
Rutile,	TiO ₂	0.000032			{ + AlO ₃ , 3 SiO ₃
Tin stone,	SnO ₂	0.000016	Soft soda glass,	0.000026
Iron-glance,	Fe ₂ O ₃	0.000040	Another sort,	0.000024
Magnetic iron ore,	Fe ₃ O ₄	0.000029	Hard potash-glass,	0.000021

TABLE XVI.
VOLUME AND DENSITY OF WATER. — BY KOPP.

Temperature.	Volume of Water (at 0° = 1).	Sp. Gr. of Water (at 0° = 1).	Volume of Water (at 4° = 1).	Sp. Gr. of Water (at 4° = 1).
0	1.00000	1.000000	1.00012	0.999877
1	0.99995	1.000053	1.00007	0.999930
2	0.99991	1.000092	1.00003	0.999969
3	0.99989	1.000115	1.00001	0.999992
4	0.99988	1.000123	1.00000	1.000000
5	0.99988	1.000117	1.00001	0.999994
6	0.99990	1.000097	1.00003	0.999973
7	0.99994	1.000062	1.00006	0.999939
8	0.99999	1.000014	1.00011	0.999890
9	1.00005	0.999952	1.00017	0.999829
10	1.00012	0.999876	1.00025	0.999753
11	1.00021	0.999785	1.00034	0.999664
12	1.00031	0.999686	1.00044	0.999562
13	1.00043	0.999572	1.00055	0.999449
14	1.00056	0.999445	1.00068	0.999322
15	1.00070	0.999306	1.00082	0.999183
16	1.00085	0.999155	1.00097	0.999032
17	1.00101	0.998992	1.00113	0.998869
18	1.00118	0.998817	1.00131	0.998695
19	1.00137	0.998631	1.00149	0.998509
20	1.00157	0.998435	1.00169	0.998312
21	1.00178	0.998228	1.00190	0.998104
22	1.00200	0.998010	1.00212	0.997886
23	1.00223	0.997780	1.00235	0.997657
24	1.00247	0.997541	1.00259	0.997419
25	1.00271	0.997293	1.00284	0.997170
26	1.00295	0.997035	1.00310	0.996912
27	1.00319	0.996767	1.00337	0.996644
28	1.00347	0.996489	1.00365	0.996367
29	1.00376	0.996202	1.00393	0.996082
30	1.00406	0.995908	1.00423	0.995787
35	1.00570			
40	1.00753			
45	1.00954			
50	1.01177			
55	1.01410			
60	1.01659			
65	1.01930			
70	1.02225			
75	1.02541			
80	1.02858			
85	1.03189			
90	1.03540			
95	1.03909			
100	1.04299			

TABLE XVII.

FOR CONVERTING DEGREES OF THE CENTIGRADE THERMOMETER INTO DEGREES OF FAHRENHEIT'S SCALE.

Cent.	Fahr.	Cent.	Fahr.	Cent.	Fahr.	Cent.	Fahr.	Cent.	Fahr.
-100	-143.0	-58	-72.4	-16	+3.2	+26	+78.8	+68	+154.4
99	146.2	57	70.6	15	5.0	27	80.6	66	156.2
98	144.4	56	68.8	14	6.8	28	82.4	70	158.0
97	142.6	55	67.0	13	8.6	29	84.2	71	159.8
96	140.8	54	65.2	12	10.4	30	86.0	72	161.6
95	139.0	53	63.4	11	12.2	31	87.8	73	163.4
94	137.2	52	61.6	10	14.0	32	89.6	74	165.2
93	135.4	51	59.8	9	15.8	33	91.4	75	167.0
92	133.6	50	58.0	8	17.6	34	93.2	76	168.8
91	131.8	49	56.2	7	19.4	35	95.0	77	170.6
90	130.0	48	54.4	6	21.2	36	96.8	78	172.4
89	128.2	47	52.6	5	23.0	37	98.6	79	174.2
88	126.4	46	50.8	4	24.8	38	100.4	80	176.0
87	124.6	45	49.0	3	26.6	39	102.2	81	177.8
86	122.8	44	47.2	2	28.4	40	104.0	82	179.6
85	121.0	43	45.4	- 1	30.2	41	105.8	83	181.4
84	119.2	42	43.6	0	32.0	42	107.6	84	183.2
83	117.4	41	41.8	+ 1	33.8	43	109.4	85	185.0
82	115.6	40	40.0	2	35.6	44	111.2	86	186.8
81	113.8	39	38.2	3	37.4	45	113.0	87	188.6
80	112.0	38	36.4	4	39.2	46	114.8	88	190.4
79	110.2	37	34.6	5	41.0	47	116.6	89	192.2
78	108.4	36	32.8	6	42.8	48	118.4	90	194.0
77	106.6	35	31.0	7	44.6	49	120.2	91	195.8
76	104.8	34	29.2	8	46.4	50	122.0	92	197.6
75	103.0	33	27.4	9	48.2	51	123.8	93	199.4
74	101.2	32	25.6	10	50.0	52	125.6	94	201.2
73	99.4	31	23.8	11	51.8	53	127.4	95	203.0
72	97.6	30	22.0	12	53.6	54	129.2	96	204.8
71	95.8	29	20.2	13	55.4	55	131.0	97	206.6
70	94.0	28	18.4	14	57.2	56	132.8	98	208.4
69	92.2	27	16.6	15	59.0	57	134.6	99	210.2
68	90.4	26	14.8	16	60.8	58	136.4	100	212.0
67	88.6	25	13.0	17	62.6	59	138.2	101	213.8
66	86.8	24	11.2	18	64.4	60	140.0	102	215.6
65	85.0	23	9.4	19	66.2	61	141.8	103	217.4
64	83.2	22	7.6	20	68.0	62	143.6	104	219.2
63	81.4	21	5.8	21	69.8	63	145.4	105	221.0
62	79.6	20	4.0	22	71.6	64	147.2	106	222.8
61	77.8	19	2.2	23	73.4	65	149.0	107	224.6
60	76.0	18	-0.4	24	75.2	66	150.8	108	226.4
59	74.2	17	+1.4	25	77.0	67	152.6	109	228.2

Cent.	Fahr.	Cent.	Fahr.	Cent.	Fahr.	Cent.	Fahr.	Cent.	Fahr.
+110	+230.0	+158	+316.4	+206	+402.8	+254	+489.2	+302	+575.6
111	231.8	159	318.2	207	404.6	255	491.0	303	577.4
112	233.6	160	320.0	208	406.4	256	492.8	304	579.2
113	235.4	161	321.8	209	408.2	257	494.6	305	581.0
114	237.2	162	323.6	210	410.0	258	496.4	306	582.8
115	239.0	163	325.4	211	411.8	259	498.2	307	584.6
116	240.8	164	327.2	212	413.6	260	500.0	308	586.4
117	242.6	165	329.0	213	415.4	261	501.8	309	588.2
118	244.4	166	330.8	214	417.2	262	503.6	310	590.0
119	246.2	167	332.6	215	419.0	263	505.4	311	591.8
120	248.0	168	334.4	216	420.8	264	507.2	312	593.6
121	249.8	169	336.2	217	422.6	265	509.0	313	595.4
122	251.6	170	338.0	218	424.4	266	510.8	314	597.2
123	253.4	171	339.8	219	426.2	267	512.6	315	599.0
124	255.2	172	341.6	220	428.0	268	514.4	316	600.8
125	257.0	173	343.4	221	429.8	269	516.2	317	602.6
126	258.8	174	345.2	222	431.6	270	518.0	318	604.4
127	260.6	175	347.0	223	433.4	271	519.8	319	606.2
128	262.4	176	348.8	224	435.2	272	521.6	320	608.0
129	264.2	177	350.6	225	437.0	273	523.4	321	609.8
130	266.0	178	352.4	226	438.8	274	525.2	322	611.6
131	267.8	179	354.2	227	440.6	275	527.0	323	613.4
132	269.6	180	356.0	228	442.4	276	528.8	324	615.2
133	271.4	181	357.8	229	444.2	277	530.6	325	617.0
134	273.2	182	359.6	230	446.0	278	532.4	326	618.8
135	275.0	183	361.4	231	447.8	279	534.2	327	620.6
136	276.8	184	363.2	232	449.6	280	536.0	328	622.4
137	278.6	185	365.0	233	451.4	281	537.8	329	624.2
138	280.4	186	366.8	234	453.2	282	539.6	330	626.0
139	282.2	187	368.6	235	455.0	283	541.4	331	627.8
140	284.0	188	370.4	236	456.8	284	543.2	332	629.6
141	285.8	189	372.2	237	458.6	285	545.0	333	631.4
142	287.6	190	374.0	238	460.4	286	546.8	334	633.2
143	289.4	191	375.8	239	462.2	287	548.6	335	635.0
144	291.2	192	377.6	240	464.0	288	550.4	336	636.8
145	293.0	193	379.4	241	465.8	289	552.2	337	638.6
146	294.8	194	381.2	242	467.6	290	554.0	338	640.4
147	296.6	195	383.0	243	469.4	291	555.8	339	642.2
148	298.4	196	384.8	244	471.2	292	557.6	340	644.0
149	300.2	197	386.6	245	473.0	293	559.4	341	645.8
150	302.0	198	388.4	246	474.8	294	561.2	342	647.6
151	303.8	199	390.2	247	476.6	295	563.0	343	649.4
152	305.6	200	392.0	248	478.4	296	564.8	344	651.2
153	307.4	201	393.8	249	480.2	297	566.6	345	653.0
154	309.2	202	395.6	250	482.0	298	568.4	346	654.8
155	311.0	203	397.4	251	483.8	299	570.2	347	656.6
156	312.8	204	399.2	252	485.6	300	572.0	348	658.4
157	314.6	205	401.0	253	487.4	301	573.8	349	660.2

TABLE XVIII.
REDUCTION OF MERCURY-COLUMN TO THE FREEZING-POINT.

H.	Glass.	Brass.	H.	Glass.	Brass.	H.	Glass.	Brass.	H.	Glass.	Brass.
c. m.	c. m.	c. m.	c. m.	c. m.	c. m.	c. m.	c. m.	c. m.	c. m.	c. m.	c. m.
0.5	0.00008	0.00008	25.5	0.00436	0.00411	50.5	0.00864	0.00815	75.5	0.01292	0.01218
1.0	0.00017	0.00016	26.0	0.00445	0.00420	51.0	0.00873	0.00823	76.0	0.01300	0.01227
1.5	0.00026	0.00024	26.5	0.00453	0.00428	51.5	0.00881	0.00831	76.5	0.01309	0.01235
2.0	0.00034	0.00032	27.0	0.00462	0.00436	52.0	0.00890	0.00839	77.0	0.01317	0.01243
2.5	0.00043	0.00040	27.5	0.00470	0.00444	52.5	0.00898	0.00847	77.5	0.01326	0.01251
3.0	0.00051	0.00048	28.0	0.00479	0.00452	53.0	0.00907	0.00855	78.0	0.01334	0.01259
3.5	0.00060	0.00056	28.5	0.00488	0.00460	53.5	0.00915	0.00863	78.5	0.01343	0.01267
4.0	0.00068	0.00065	29.0	0.00496	0.00468	54.0	0.00924	0.00872	79.0	0.01352	0.01275
4.5	0.00077	0.00073	29.5	0.00505	0.00476	54.5	0.00932	0.00879	79.5	0.01360	0.01283
5.0	0.00085	0.00081	30.0	0.00513	0.00484	55.0	0.00941	0.00888	80.0	0.01369	0.01291
5.5	0.00094	0.00089	30.5	0.00522	0.00492	55.5	0.00950	0.00896	80.5	0.01377	0.01299
6.0	0.00103	0.00097	31.0	0.00530	0.00500	56.0	0.00958	0.00904	81.0	0.01386	0.01307
6.5	0.00111	0.00105	31.5	0.00539	0.00508	56.5	0.00967	0.00912	81.5	0.01394	0.01315
7.0	0.00120	0.00113	32.0	0.00547	0.00516	57.0	0.00975	0.00920	82.0	0.01403	0.01323
7.5	0.00128	0.00121	32.5	0.00556	0.00524	57.5	0.00984	0.00928	82.5	0.01411	0.01331
8.0	0.00137	0.00129	33.0	0.00565	0.00533	58.0	0.00992	0.00936	83.0	0.01420	0.01340
8.5	0.00145	0.00137	33.5	0.00573	0.00541	58.5	0.01001	0.00944	83.5	0.01429	0.01348
9.0	0.00154	0.00145	34.0	0.00582	0.00549	59.0	0.01009	0.00952	84.0	0.01437	0.01356
9.5	0.00162	0.00153	34.5	0.00590	0.00557	59.5	0.01018	0.00960	84.5	0.01446	0.01364
10.0	0.00171	0.00161	35.0	0.00599	0.00565	60.0	0.01026	0.00968	85.0	0.01454	0.01372
10.5	0.00180	0.00169	35.5	0.00607	0.00573	60.5	0.01035	0.00976	85.5	0.01463	0.01380
11.0	0.00188	0.00177	36.0	0.00616	0.00581	61.0	0.01044	0.00985	86.0	0.01471	0.01388

11.5	0.00197	0.00186	36.5	0.00624	0.00589	61.5	0.01052	0.00993	86.5	0.01480	0.01396
12.0	0.00205	0.00194	37.0	0.00633	0.00597	62.0	0.01061	0.01001	87.0	0.01488	0.01404
12.5	0.00214	0.00202	37.5	0.00642	0.00605	62.5	0.01069	0.01009	87.5	0.01497	0.01412
13.0	0.00222	0.00210	38.0	0.00650	0.00613	63.0	0.01078	0.01017	88.0	0.01506	0.01420
13.5	0.00231	0.00218	38.5	0.00659	0.00621	63.5	0.01086	0.01025	88.5	0.01514	0.01428
14.0	0.00240	0.00226	39.0	0.00667	0.00629	64.0	0.01095	0.01033	89.0	0.01523	0.01436
14.5	0.00248	0.00234	39.5	0.00676	0.00637	64.5	0.01103	0.01041	89.5	0.01531	0.01444
15.0	0.00257	0.00242	40.0	0.00684	0.00646	65.0	0.01112	0.01049	90.0	0.01540	0.01453
15.5	0.00265	0.00250	40.5	0.00693	0.00654	65.5	0.01121	0.01057	90.5	0.01548	0.01461
16.0	0.00273	0.00258	41.0	0.00701	0.00662	66.0	0.01129	0.01065	91.0	0.01557	0.01469
16.5	0.00282	0.00266	41.5	0.00710	0.00670	66.5	0.01138	0.01073	91.5	0.01565	0.01477
17.0	0.00291	0.00274	42.0	0.00719	0.00678	67.0	0.01146	0.01081	92.0	0.01574	0.01485
17.5	0.00299	0.00282	42.5	0.00727	0.00686	67.5	0.01155	0.01089	92.5	0.01583	0.01493
18.0	0.00308	0.00290	43.0	0.00736	0.00694	68.0	0.01163	0.01097	93.0	0.01591	0.01501
18.5	0.00316	0.00298	43.5	0.00744	0.00702	68.5	0.01172	0.01106	93.5	0.01600	0.01509
19.0	0.00325	0.00307	44.0	0.00753	0.00710	69.0	0.01180	0.01114	94.0	0.01608	0.01517
19.5	0.00334	0.00315	44.5	0.00761	0.00718	69.5	0.01189	0.01122	94.5	0.01617	0.01525
20.0	0.00342	0.00322	45.0	0.00770	0.00726	70.0	0.01198	0.01130	95.0	0.01625	0.01533
20.5	0.00351	0.00331	45.5	0.00778	0.00734	70.5	0.01206	0.01138	95.5	0.01634	0.01541
21.0	0.00359	0.00339	46.0	0.00787	0.00742	71.0	0.01215	0.01146	96.0	0.01642	0.01549
21.5	0.00368	0.00347	46.5	0.00796	0.00750	71.5	0.01223	0.01154	96.5	0.01651	0.01557
22.0	0.00376	0.00355	47.0	0.00804	0.00758	72.0	0.01232	0.01162	97.0	0.01660	0.01565
22.5	0.00385	0.00363	47.5	0.00813	0.00767	72.5	0.01240	0.01170	97.5	0.01668	0.01574
23.0	0.00393	0.00371	48.0	0.00821	0.00775	73.0	0.01249	0.01178	98.0	0.01677	0.01582
23.5	0.00402	0.00379	48.5	0.00830	0.00783	73.5	0.01257	0.01186	98.5	0.01685	0.01590
24.0	0.00411	0.00387	49.0	0.00838	0.00791	74.0	0.01266	0.01194	99.0	0.01694	0.01598
24.5	0.00419	0.00395	49.5	0.00847	0.00799	74.5	0.01275	0.01202	99.5	0.01702	0.01606
25.0	0.00428	0.00403	50.0	0.00855	0.00807	75.0	0.01283	0.01210	100.0	0.01711	0.01614

TABLE XIX.

TABLE FOR THE REDUCTION OF THE PRESSURE OF A COLUMN OF WATER TO A COLUMN OF MERCURY.

Pressure of Water, in Millimetres.	Pressure of Mercury, in Millimetres.	Pressure of Water, in Millimetres.	Pressure of Mercury, in Millimetres.	Pressure of Water, in Millimetres	Pressure of Mercury, in Millimetres.
1	0.07	41	3.03	81	5.98
2	0.15	42	3.10	82	6.05
3	0.22	43	3.17	83	6.13
4	0.30	44	3.25	84	6.20
5	0.37	45	3.32	85	6.27
6	0.44	46	3.39	86	6.35
7	0.52	47	3.47	87	6.42
8	0.59	48	3.54	88	6.49
9	0.66	49	3.62	89	6.57
10	0.74	50	3.69	90	6.64
11	0.81	51	3.76	91	6.72
12	0.89	52	3.84	92	6.79
13	0.96	53	3.91	93	6.86
14	1.03	54	3.99	94	6.94
15	1.12	55	4.06	95	7.01
16	1.18	56	4.13	96	7.08
17	1.26	57	4.21	97	7.16
18	1.33	58	4.28	98	7.23
19	1.40	59	4.35	99	7.31
20	1.48	60	4.43	100	7.38
21	1.55	61	4.50	200	14.76
22	1.62	62	4.58	300	22.14
23	1.70	63	4.65	400	29.52
24	1.77	64	4.72	500	36.90
25	1.84	65	4.80	600	44.28
26	1.92	66	4.87	700	51.66
27	1.98	67	4.94	800	59.04
28	2.07	68	5.02	900	66.42
29	2.14	69	5.09	1000	73.80
30	2.21	70	5.17		
31	2.29	71	5.24		
32	2.36	72	5.31		
33	2.44	73	5.39		
34	2.51	74	5.46		
35	2.58	75	5.54		
36	2.66	76	5.61		
37	2.73	77	5.68		
38	2.80	78	5.76		
39	2.88	79	5.83		
40	2.95	80	5.90		

LOGARITHMS AND ANTI-LOGARITHMS.

LOGARITHMS OF NUMBERS.

Natural Numbers.											Proportional Parts.									
	0	1	2	3	4	5	6	7	8	9	1	2	3	4	5	6	7	8	9	
	10	0000	0043	0086	0128	0170	0212	0253	0294	0334	0374	4	8	12	17	21	25	29	33	37
11	0414	0453	0492	0531	0569	0607	0645	0682	0719	0755	4	8	11	15	19	23	26	30	34	
12	0792	0828	0864	0899	0934	0969	1004	1038	1072	1106	3	7	10	14	17	21	24	28	31	
13	1139	1173	1206	1239	1271	1303	1335	1367	1399	1430	3	6	10	13	16	19	23	26	29	
14	1461	1492	1523	1553	1584	1614	1644	1673	1703	1732	3	6	9	12	15	18	21	24	27	
15	1761	1790	1818	1847	1875	1903	1931	1959	1987	2014	3	6	8	11	14	17	20	22	25	
16	2041	2068	2095	2122	2148	2175	2201	2227	2253	2279	3	5	8	11	13	16	18	21	24	
17	2304	2330	2355	2380	2405	2430	2455	2480	2504	2529	2	5	7	10	12	15	17	20	22	
18	2553	2577	2601	2625	2648	2672	2695	2718	2742	2765	2	5	7	9	12	14	16	19	21	
19	2788	2810	2833	2856	2878	2900	2923	2945	2967	2989	2	4	7	9	11	13	16	18	20	
20	3010	3032	3054	3075	3096	3118	3139	3160	3181	3201	2	4	6	8	11	13	15	17	19	
21	3222	3243	3263	3284	3304	3324	3345	3365	3385	3404	2	4	6	8	10	12	14	16	18	
22	3424	3444	3464	3483	3502	3522	3541	3560	3579	3598	2	4	6	8	10	12	14	15	17	
23	3617	3636	3655	3674	3692	3711	3729	3747	3766	3784	2	4	6	7	9	11	13	15	17	
24	3802	3820	3838	3856	3874	3892	3909	3927	3945	3962	2	4	5	7	9	11	12	14	16	
25	3979	3997	4014	4031	4048	4065	4082	4099	4116	4133	2	3	5	7	9	10	12	14	15	
26	4150	4166	4183	4200	4216	4232	4249	4265	4281	4298	2	3	5	7	8	10	11	13	15	
27	4314	4330	4346	4362	4378	4393	4409	4425	4440	4456	2	3	5	6	8	9	11	13	14	
28	4472	4487	4502	4518	4533	4548	4564	4579	4594	4609	2	3	5	6	8	9	11	12	14	
29	4624	4639	4654	4669	4683	4698	4713	4728	4742	4757	1	3	4	6	7	9	10	12	13	
30	4771	4786	4800	4814	4829	4843	4857	4871	4886	4900	1	3	4	6	7	9	10	11	13	
31	4914	4928	4942	4955	4969	4983	4997	5011	5024	5038	1	3	4	6	7	8	10	11	12	
32	5051	5065	5079	5092	5105	5119	5132	5145	5159	5172	1	3	4	5	7	8	9	11	12	
33	5185	5198	5211	5224	5237	5250	5263	5276	5289	5302	1	3	4	5	6	8	9	10	12	
34	5315	5328	5340	5353	5366	5378	5391	5403	5416	5428	1	3	4	5	6	8	9	10	11	
35	5441	5453	5465	5478	5490	5502	5514	5527	5539	5551	1	2	4	5	6	7	9	10	11	
36	5563	5575	5587	5599	5611	5623	5635	5647	5658	5670	1	2	4	5	6	7	8	10	11	
37	5682	5694	5705	5717	5729	5740	5752	5763	5775	5786	1	2	3	5	6	7	8	9	10	
38	5798	5809	5821	5832	5843	5855	5866	5877	5888	5899	1	2	3	5	6	7	8	9	10	
39	5911	5922	5933	5944	5955	5966	5977	5988	5999	6010	1	2	3	4	5	7	8	9	10	
40	6021	6031	6042	6053	6064	6075	6085	6096	6107	6117	1	2	3	4	5	6	8	9	10	
41	6128	6138	6149	6160	6170	6180	6191	6201	6212	6222	1	2	3	4	5	6	7	8	9	
42	6232	6243	6253	6263	6274	6284	6294	6304	6314	6325	1	2	3	4	5	6	7	8	9	
43	6335	6345	6355	6365	6375	6385	6395	6405	6415	6425	1	2	3	4	5	6	7	8	9	
44	6435	6444	6454	6464	6474	6484	6493	6503	6513	6522	1	2	3	4	5	6	7	8	9	
45	6532	6542	6551	6561	6571	6580	6590	6599	6609	6618	1	2	3	4	5	6	7	8	9	
46	6628	6637	6646	6656	6665	6675	6684	6693	6702	6712	1	2	3	4	5	6	7	7	8	
47	6721	6730	6739	6749	6758	6767	6776	6785	6794	6803	1	2	3	4	5	5	6	7	8	
48	6812	6821	6830	6839	6848	6857	6866	6875	6884	6893	1	2	3	4	4	5	6	7	8	
49	6902	6911	6920	6928	6937	6946	6955	6964	6972	6981	1	2	3	4	4	5	6	7	8	
50	6990	6998	7007	7016	7024	7033	7042	7050	7059	7067	1	2	3	3	4	5	6	7	8	
51	7076	7084	7093	7101	7110	7118	7126	7135	7143	7152	1	2	3	3	4	5	6	7	8	
52	7160	7168	7177	7185	7193	7202	7210	7218	7226	7235	1	2	2	3	4	5	6	7	7	
53	7243	7251	7259	7267	7275	7284	7292	7300	7308	7316	1	2	2	3	4	5	6	6	7	
54	7324	7332	7340	7348	7356	7364	7372	7380	7388	7396	1	2	2	3	4	5	6	6	7	

LOGARITHMS OF NUMBERS.

Natural Numbers.											Proportional Parts.								
	0	1	2	3	4	5	6	7	8	9	1	2	3	4	5	6	7	8	9
55	7404	7412	7419	7427	7435	7443	7451	7459	7466	7474	1	2	2	3	4	5	5	6	7
56	7482	7490	7497	7505	7513	7520	7528	7536	7543	7551	1	2	2	3	4	5	5	6	7
57	7559	7566	7574	7582	7589	7597	7604	7612	7619	7627	1	2	2	3	4	5	5	6	7
58	7634	7642	7649	7657	7664	7672	7679	7686	7694	7701	1	1	2	3	4	4	5	6	7
59	7709	7716	7723	7731	7738	7745	7752	7760	7767	7774	1	1	2	3	4	4	5	6	7
60	7782	7789	7796	7803	7810	7818	7825	7832	7839	7846	1	1	2	3	4	4	5	6	6
61	7853	7860	7868	7875	7882	7889	7896	7903	7910	7917	1	1	2	3	4	4	5	6	6
62	7924	7931	7938	7945	7952	7959	7966	7973	7980	7987	1	1	2	3	3	4	5	6	6
63	7993	8000	8007	8014	8021	8028	8035	8041	8048	8055	1	1	2	3	3	4	5	5	6
64	8062	8069	8075	8082	8089	8096	8102	8109	8116	8122	1	1	2	3	3	4	5	5	6
65	8129	8136	8142	8149	8156	8162	8169	8176	8182	8189	1	1	2	3	3	4	5	5	6
66	8195	8202	8209	8215	8222	8228	8235	8241	8248	8254	1	1	2	3	3	4	5	5	6
67	8261	8267	8274	8280	8287	8293	8299	8306	8312	8319	1	1	2	3	3	4	5	5	6
68	8325	8331	8338	8344	8351	8357	8363	8370	8376	8382	1	1	2	3	3	4	4	5	6
69	8388	8395	8401	8407	8414	8420	8426	8432	8439	8445	1	1	2	2	3	4	4	5	6
70	8451	8457	8463	8470	8476	8482	8488	8494	8500	8506	1	1	2	2	3	4	4	5	6
71	8513	8519	8525	8531	8537	8543	8549	8555	8561	8567	1	1	2	2	3	4	4	5	5
72	8573	8579	8585	8591	8597	8603	8609	8615	8621	8627	1	1	2	2	3	4	4	5	5
73	8633	8639	8645	8651	8657	8663	8669	8675	8681	8686	1	1	2	2	3	4	4	5	5
74	8692	8698	8704	8710	8716	8722	8727	8733	8739	8745	1	1	2	2	3	4	4	5	5
75	8751	8756	8762	8768	8774	8779	8785	8791	8797	8802	1	1	2	2	3	3	4	5	5
76	8808	8814	8820	8825	8831	8837	8842	8848	8854	8859	1	1	2	2	3	3	4	5	5
77	8865	8871	8876	8882	8887	8893	8899	8904	8910	8915	1	1	2	2	3	3	4	4	5
78	8921	8927	8932	8938	8943	8949	8954	8960	8965	8971	1	1	2	2	3	3	4	4	5
79	8976	8982	8987	8993	8998	9004	9009	9015	9020	9025	1	1	2	2	3	3	4	4	5
80	9031	9036	9042	9047	9053	9058	9063	9069	9074	9079	1	1	2	2	3	3	4	4	5
81	9085	9090	9096	9101	9106	9112	9117	9122	9128	9133	1	1	2	2	3	3	4	4	5
82	9138	9143	9149	9154	9159	9165	9170	9175	9180	9186	1	1	2	2	3	3	4	4	5
83	9191	9196	9201	9206	9212	9217	9222	9227	9232	9238	1	1	2	2	3	3	4	4	5
84	9243	9248	9253	9258	9263	9269	9274	9279	9284	9289	1	1	2	2	3	3	4	4	5
85	9294	9299	9304	9309	9315	9320	9325	9330	9335	9340	1	1	2	2	3	3	4	4	5
86	9345	9350	9355	9360	9365	9370	9375	9380	9385	9390	1	1	2	2	3	3	4	4	5
87	9395	9400	9405	9410	9415	9420	9425	9430	9435	9440	0	1	1	2	2	3	3	4	4
88	9445	9450	9455	9460	9465	9469	9474	9479	9484	9489	0	1	1	2	2	3	3	4	4
89	9494	9499	9504	9509	9513	9518	9523	9528	9533	9538	0	1	1	2	2	3	3	4	4
90	9542	9547	9552	9557	9562	9566	9571	9576	9581	9586	0	1	1	2	2	3	3	4	4
91	9590	9595	9600	9605	9609	9614	9619	9624	9628	9633	0	1	1	2	2	3	3	4	4
92	9638	9643	9647	9652	9657	9661	9666	9671	9675	9680	0	1	1	2	2	3	3	4	4
93	9685	9689	9694	9699	9703	9708	9713	9717	9722	9727	0	1	1	2	2	3	3	4	4
94	9731	9736	9741	9745	9750	9754	9759	9763	9768	9773	0	1	1	2	2	3	3	4	4
95	9777	9782	9786	9791	9795	9800	9805	9809	9814	9818	0	1	1	2	2	3	3	4	4
96	9823	9827	9832	9836	9841	9845	9850	9854	9859	9863	0	1	1	2	2	3	3	4	4
97	9868	9872	9877	9881	9886	9890	9894	9899	9903	9908	0	1	1	2	2	3	3	4	4
98	9912	9917	9921	9926	9930	9934	9939	9943	9948	9952	0	1	1	2	2	3	3	4	4
99	9956	9961	9965	9969	9974	9978	9983	9987	9991	9996	0	1	1	2	2	3	3	4	4

ANTILOGARITHMS.

Loga- rithms.											Proportional Parts.								
	0	1	2	3	4	5	6	7	8	9	1	2	3	4	5	6	7	8	9
.00	1000	1002	1005	1007	1009	1012	1014	1016	1019	1021	0	0	1	1	1	1	2	2	2
.01	1023	1026	1028	1030	1033	1035	1038	1040	1042	1045	0	0	1	1	1	1	2	2	2
.02	1047	1050	1052	1054	1057	1059	1062	1064	1067	1069	0	0	1	1	1	1	2	2	2
.03	1072	1074	1076	1079	1081	1084	1086	1089	1091	1094	0	0	1	1	1	1	2	2	2
.04	1096	1099	1102	1104	1107	1109	1112	1114	1117	1119	0	1	1	1	1	2	2	2	2
.05	1122	1125	1127	1130	1132	1135	1138	1140	1143	1146	0	1	1	1	1	2	2	2	2
.06	1148	1151	1153	1156	1159	1161	1164	1167	1169	1172	0	1	1	1	1	2	2	2	2
.07	1175	1178	1180	1183	1186	1189	1191	1194	1197	1199	0	1	1	1	1	2	2	2	2
.08	1202	1205	1208	1211	1213	1216	1219	1222	1225	1227	0	1	1	1	1	2	2	2	3
.09	1230	1233	1236	1239	1242	1245	1247	1250	1253	1256	0	1	1	1	1	2	2	2	3
.10	1259	1262	1265	1268	1271	1274	1276	1279	1282	1285	0	1	1	1	1	2	2	2	3
.11	1288	1291	1294	1297	1300	1303	1306	1309	1312	1315	0	1	1	1	2	2	2	2	3
.12	1318	1321	1324	1327	1330	1334	1337	1340	1343	1346	0	1	1	1	2	2	2	2	3
.13	1349	1352	1355	1358	1361	1365	1368	1371	1374	1377	0	1	1	1	2	2	2	3	3
.14	1380	1384	1387	1390	1393	1396	1400	1403	1406	1409	0	1	1	1	2	2	2	3	3
.15	1413	1416	1419	1422	1426	1429	1432	1435	1439	1442	0	1	1	1	2	2	2	3	3
.16	1445	1449	1452	1455	1459	1462	1466	1469	1472	1476	0	1	1	1	2	2	2	3	3
.17	1479	1483	1486	1489	1493	1496	1500	1503	1507	1510	0	1	1	1	2	2	2	3	3
.18	1514	1517	1521	1524	1528	1531	1535	1538	1542	1545	0	1	1	1	2	2	2	3	3
.19	1549	1552	1556	1560	1563	1567	1570	1574	1578	1581	0	1	1	1	2	2	3	3	3
.20	1585	1589	1592	1596	1600	1603	1607	1611	1614	1618	0	1	1	1	2	2	3	3	3
.21	1622	1626	1629	1633	1637	1641	1644	1648	1652	1656	0	1	1	2	2	2	3	3	3
.22	1660	1663	1667	1671	1675	1679	1683	1687	1690	1694	0	1	1	2	2	2	3	3	3
.23	1698	1702	1706	1710	1714	1718	1722	1726	1730	1734	0	1	1	2	2	2	3	3	4
.24	1738	1742	1746	1750	1754	1758	1762	1766	1770	1774	0	1	1	2	2	2	3	3	4
.25	1778	1782	1786	1791	1795	1799	1803	1807	1811	1816	0	1	1	2	2	2	3	3	4
.26	1820	1824	1828	1832	1837	1841	1845	1849	1854	1858	0	1	1	2	2	3	3	3	4
.27	1862	1866	1871	1875	1879	1884	1888	1892	1897	1901	0	1	1	2	2	3	3	3	4
.28	1905	1910	1914	1919	1923	1928	1932	1936	1941	1945	0	1	1	2	2	3	3	4	4
.29	1950	1954	1959	1963	1968	1972	1977	1982	1986	1991	0	1	1	2	2	3	3	4	4
.30	1995	2000	2004	2009	2014	2018	2023	2028	2032	2037	0	1	1	2	2	3	3	4	4
.31	2042	2046	2051	2056	2061	2065	2070	2075	2080	2084	0	1	1	2	2	3	3	4	4
.32	2089	2094	2099	2104	2109	2113	2118	2123	2128	2133	0	1	1	2	2	3	3	4	4
.33	2138	2143	2148	2153	2158	2163	2168	2173	2178	2183	0	1	1	2	2	3	3	4	4
.34	2188	2193	2198	2203	2208	2213	2218	2223	2228	2234	1	1	2	2	3	3	4	4	5
.35	2239	2244	2249	2254	2259	2265	2270	2275	2280	2286	1	1	2	2	3	3	4	4	5
.36	2291	2296	2301	2307	2312	2317	2323	2328	2333	2339	1	1	2	2	3	3	4	4	5
.37	2344	2350	2355	2360	2366	2371	2377	2382	2388	2393	1	1	2	2	3	3	4	4	5
.38	2399	2404	2410	2415	2421	2427	2432	2438	2443	2449	1	1	2	2	3	3	4	4	5
.39	2455	2460	2466	2472	2477	2483	2489	2495	2500	2506	1	1	2	2	3	3	4	4	5
.40	2512	2518	2523	2529	2535	2541	2547	2553	2559	2564	1	1	2	2	3	3	4	4	5
.41	2570	2576	2582	2588	2594	2600	2606	2612	2618	2624	1	1	2	2	3	3	4	4	5
.42	2630	2636	2642	2649	2655	2661	2667	2673	2679	2685	1	1	2	2	3	3	4	4	5
.43	2692	2698	2704	2710	2716	2723	2729	2735	2742	2748	1	1	2	2	3	3	4	4	5
.44	2754	2761	2767	2773	2780	2786	2793	2799	2805	2812	1	1	2	2	3	3	4	4	5
.45	2818	2825	2831	2838	2844	2851	2858	2864	2871	2877	1	1	2	2	3	3	4	4	5
.46	2884	2891	2897	2904	2911	2917	2924	2931	2938	2944	1	1	2	2	3	3	4	4	5
.47	2951	2958	2965	2972	2979	2985	2992	2999	3006	3013	1	1	2	2	3	3	4	4	5
.48	3020	3027	3034	3041	3048	3055	3062	3069	3076	3083	1	1	2	2	3	3	4	4	5
.49	3090	3097	3105	3112	3119	3126	3133	3141	3148	3155	1	1	2	2	3	3	4	4	5

ANTILOGARITHMS.

Logarithms.											Proportional Parts.									
	0	1	2	3	4	5	6	7	8	9	1	2	3	4	5	6	7	8	9	
	.50	3162	3170	3177	3184	3192	3199	3206	3214	3221	3228	1	1	2	3	4	4	5	6	7
.51	3236	3243	3251	3258	3266	3273	3281	3289	3296	3304	1	2	2	3	4	5	5	6	7	
.52	3311	3319	3327	3334	3342	3350	3357	3365	3373	3381	1	2	2	3	4	5	6	6	7	
.53	3388	3396	3404	3412	3420	3428	3436	3443	3451	3459	1	2	2	3	4	5	6	6	7	
.54	3467	3475	3483	3491	3499	3508	3516	3524	3532	3540	1	2	2	3	4	5	6	6	7	
.55	3548	3556	3565	3573	3581	3589	3597	3606	3614	3622	1	2	2	3	4	5	6	7	7	
.56	3631	3639	3648	3656	3664	3673	3681	3690	3698	3707	1	2	3	3	4	5	6	7	8	
.57	3715	3724	3733	3741	3750	3758	3767	3776	3784	3793	1	2	3	3	4	5	6	7	8	
.58	3802	3811	3819	3828	3837	3846	3855	3864	3873	3882	1	2	3	4	4	5	6	7	8	
.59	3890	3899	3908	3917	3926	3936	3945	3954	3963	3972	1	2	3	4	5	5	6	7	8	
.60	3981	3990	3999	4009	4018	4027	4036	4046	4055	4064	1	2	3	4	5	6	6	7	8	
.61	4074	4083	4093	4102	4111	4121	4130	4140	4150	4159	1	2	3	4	5	6	7	8	9	
.62	4169	4178	4188	4198	4207	4217	4227	4236	4246	4256	1	2	3	4	5	6	7	8	9	
.63	4266	4276	4285	4295	4305	4315	4325	4335	4345	4355	1	2	3	4	5	6	7	8	9	
.64	4365	4375	4385	4395	4406	4416	4426	4436	4446	4457	1	2	3	4	5	6	7	8	9	
.65	4467	4477	4487	4498	4508	4519	4529	4539	4550	4560	1	2	3	4	5	6	7	8	9	
.66	4571	4581	4592	4603	4613	4624	4634	4645	4656	4667	1	2	3	4	5	6	7	9	10	
.67	4677	4688	4699	4710	4721	4732	4742	4753	4764	4775	1	2	3	4	5	7	8	9	10	
.68	4786	4797	4808	4819	4831	4842	4853	4864	4875	4887	1	2	3	4	6	7	8	9	10	
.69	4898	4909	4920	4932	4943	4955	4966	4977	4989	5000	1	2	3	5	6	7	8	9	10	
.70	5012	5023	5035	5047	5058	5070	5082	5093	5105	5117	1	2	4	5	6	7	8	9	11	
.71	5129	5140	5152	5164	5176	5188	5200	5212	5224	5236	1	2	4	5	6	7	8	10	11	
.72	5248	5260	5272	5284	5297	5309	5321	5333	5346	5358	1	2	4	5	6	7	9	10	11	
.73	5370	5383	5395	5408	5420	5433	5445	5458	5470	5483	1	3	4	5	6	8	9	10	11	
.74	5495	5508	5521	5534	5546	5559	5572	5585	5598	5610	1	3	4	5	6	8	9	10	12	
.75	5623	5636	5649	5662	5675	5689	5702	5715	5728	5741	1	3	4	5	7	8	9	10	12	
.76	5754	5768	5781	5794	5808	5821	5834	5848	5861	5875	1	3	4	5	7	8	9	11	12	
.77	5888	5902	5916	5929	5943	5957	5970	5984	5998	6012	1	3	4	5	7	8	10	11	12	
.78	6026	6039	6053	6067	6081	6095	6109	6124	6138	6152	1	3	4	6	7	8	10	11	13	
.79	6166	6180	6194	6209	6223	6237	6252	6266	6281	6295	1	3	4	6	7	9	10	11	13	
.80	6310	6324	6339	6353	6368	6383	6397	6412	6427	6442	1	3	4	6	7	9	10	12	13	
.81	6457	6471	6486	6501	6516	6531	6546	6561	6577	6592	2	3	5	6	8	9	11	12	14	
.82	6607	6621	6637	6653	6668	6683	6699	6714	6730	6745	2	3	5	6	8	9	11	12	14	
.83	6761	6776	6792	6808	6823	6839	6855	6871	6887	6902	2	3	5	6	8	9	11	13	14	
.84	6918	6934	6950	6966	6982	6998	7015	7031	7047	7063	2	3	5	6	8	10	11	13	15	
.85	7079	7096	7112	7129	7145	7161	7178	7194	7211	7228	2	3	5	7	8	10	12	13	15	
.86	7244	7261	7278	7295	7311	7328	7345	7362	7379	7396	2	3	5	7	8	10	12	13	15	
.87	7413	7430	7447	7464	7482	7499	7516	7534	7551	7568	2	3	5	7	9	10	12	14	16	
.88	7586	7603	7621	7638	7656	7674	7691	7709	7727	7745	2	4	5	7	9	11	12	14	16	
.89	7762	7780	7798	7816	7834	7852	7870	7889	7907	7925	2	4	5	7	9	11	13	14	16	
.90	7943	7962	7980	7998	8017	8035	8054	8072	8091	8110	2	4	6	7	9	11	12	15	17	
.91	8128	8147	8166	8185	8204	8222	8241	8260	8279	8299	2	4	6	8	9	11	13	15	17	
.92	8318	8337	8356	8375	8395	8414	8433	8453	8472	8492	2	4	6	8	10	12	14	15	17	
.93	8511	8531	8551	8570	8590	8610	8630	8650	8670	8690	2	4	6	8	10	12	14	16	18	
.94	8710	8730	8750	8770	8790	8810	8831	8851	8872	8892	2	4	6	8	10	12	14	16	18	
.95	8913	8933	8954	8974	8995	9016	9036	9057	9078	9099	2	4	6	8	10	12	15	17	19	
.96	9120	9141	9162	9183	9204	9226	9247	9268	9290	9311	2	4	6	8	11	13	15	17	19	
.97	9333	9354	9376	9397	9419	9441	9462	9484	9506	9528	2	4	7	9	11	13	15	17	20	
.98	9550	9572	9594	9616	9638	9661	9683	9705	9727	9750	2	4	7	9	11	13	16	18	20	
.99	9772	9795	9817	9840	9863	9886	9908	9931	9954	9977	2	5	7	9	11	14	16	18	20	

CONSTANT LOGARITHMS.

		Logarithms.	Ar. Co. Logarithms.
Circumf. of circle when $R = 1$,	$\left(\frac{\pi}{2} = 1.5708\right)$	0.196 1199	9.803 8801
“ “ “ “ $D = 1$,	$(\pi = 3.1416)$	0.497 1499	9.502 8501
Area of circle when $R^2 = 1$,	$(\pi = 3.1416)$	0.497 1499	9.502 8501
“ “ “ “ $D^2 = 1$,	$\left(\frac{\pi}{4} = 0.7854\right)$	9.895 0899	0.104 9101
“ “ “ “ $C^2 = 1$,	$\left(\frac{1}{4\pi} = 0.0796\right)$	8.900 7901	1.099 2099
Surface of sphere when $R^2 = 1$,	$(4\pi = 12.5664)$	1.099 2099	8.900 7901
“ “ “ “ $D^2 = 1$,	$(\pi = 3.1416)$	0.497 1499	9.502 8501
“ “ “ “ $C^2 = 1$,	$\left(\frac{1}{\pi} = 0.3183\right)$	9.502 8501	0.497 1499
Solidity of sphere when $R^3 = 1$,	$\left(\frac{4}{3}\pi = 4.1888\right)$	0.622 0886	9.377 9114
“ “ “ “ $D^3 = 1$,	$\left(\frac{\pi}{6} = 0.5236\right)$	9.718 9986	0.281 0014
“ “ “ “ $C^3 = 1$,	$\left(\frac{1}{6\pi^2} = 0.0169\right)$	8.227 5490	1.772 4510
Log. of π^2 ,	$(\pi^2 = 9.86960)$	0.994 2997	9.005 7003
Intensity of gravity at Paris,	$(g = 9.80960)$	0.991 6513	9.008 3487
“ “ “ in Lat. 45° ,	$(g = 9.80604)$	0.991 4937	9.008 5063
“ “ “ on Equator,	$(g = 9.78062)$	0.990 3664	9.009 6336
Length of seconds pendulum at Paris, ($l = 0.99392$)		9.997 3515	0.002 6485
No. of seconds in a day,	(86400)	4.936 5137	5.063 4863
Specific Gravity of Mercury,	(13.596)	1.133 4112	8.866 5888
Mean height of Barometer,	(76 c. m.)	1.880 8136	8.119 1864
Corresponding air pressure on $\overline{\text{c. m.}}^2$,	(1,033.296)	3.014 2248	6.985 7752

INDEX.

- ABSOLUTE WEIGHT.** (*See* Weight.)
Absorption of gases by solids, 379.
 " " " laws of, 381.
 " " by liquids. (*See* Solu-
 of liquids by solids, 363. [bility.)
Absorption-Meter, 402. Analysis of mixed
 gases by, 409.
Acceleration, definition of, 23.
 " of gravity, 65.
Action and reaction, law of, 49.
Adhesion, 342. (*And see* Osmose.)
 " between gases, 412.
 " " liquids, 383.
 " " and gases, 391.
 " " solids, 342.
 " " and gases, 379, 383.
 " " " liquids, 344.
 " phenomena of, classified, 342.
Air. (*See* Atmosphere.)
Air-Pump, with valves, 329.
 " without valves, 325.
 " degree of exhaustion, 327.
Air-Thermometer, 533. (*See* Thermoscope.)
 " Regnault's, 534.
Alcometer, Gay-Lussac's, 254.
Alloys, expansion in solidifying, 553.
 " melting-point of, 550.
Alumina, crystallization of, 120.
Analogies of Nature, 9.
Annealing, 207, 211.
 " of glass, 212.
Antimony, ratio of crystalline axes of, 122.
**Arago and Dulong, experiments on Mari-
 otte's law,** 293.
 " " experiments on tension
 of aqueous vapor, 575.
Archimedes's Law, 235.
 " " demonstration of, 237.
 " " illustration of, 236.
Arsenic, crystallization of, 120.
Arsenious Acid, crystallization of, 120.
Artesian Wells, 233, 647.
Aspirator, 325, 392.
Atmosphere, buoyancy of, 268.
 " dew-point of, 641.
 " effects of expansion of, 540.
 " pressure of, 266, 279.
 " probable limit of, 307.
 " relative humidity of, 640.
 " waves of, 286.
Atomic Theory, 110.
Atoms, size of, Boscovich's opinion of, 110.
 " Newton's opinion of, 110.
Attraction of Earth. (*See* Gravity.)
- Axes of crystals,** 121, 123.
 " lateral and vertical, 122.
 " ratio in crystals of antimony, 122.
 " " " bichromate of pot-
 ash, 124. [122.
 " " " carbonate of lime,
 " " " gypsum, 123. [124.
 " " " sulphate of copper,
 " " " " iron, 123.
 " " " sulphur, 123.
 " " " tin, 122.
 " similar, 125.
BABINET, formula of, 305.
Balance, accuracy and sensibility of, 102.
 " centre of gravity of, how adjusted,
 degree of sensibility of, 105. [101.
 " description of, 100.
 " hydrostatic, 248.
 " regarded as a lever, 101.
 " " " pendulum, 102. [94.
 " spring, indicates absolute weight,
Balloons, 270.
 " ascensional force of, 271.
Barometer, Aneroid, 285.
 " Bourdon's metallic, 190.
 " common, 284.
 " Fortin's, 282.
 " history of, 275.
 " oscillations of, 286.
 " Regnault's, 280.
 " theory of, 278.
 " used in measuring heights, 304.
 " " meteorology, 287.
 " various uses of, 285.
**Barometrical Observations, corrected for ca-
 pillarity,** 284, 355.
 " " corrected for tem-
 perature, 284, 511.
Bevelling, 131.
**Bichromate of potash, ratio of crystalline
 axes of,** 124.
Billiards, illustrative of elasticity, 201.
Bodies, collision of unelastic, 49.
 " " elastic, 196.
Body, definition of, 3.
Boiler. (*See* Steam-Boiler.)
Boiling-Point, determination of, 569.
 " influenced by pressure, 566,
 table of, 566. [577.
 " of water, 565.
 " " effect of salts on, 568.
 " " influenced by con-
 taining vessel, 568.

- Boiling-Point, use in measuring heights, 567.
 Boracic Acid, how used in crystallizing, 120.
 Boscovich's opinion of atomic theory, 110.
 Bourdon. (*See* Barometer and Manometer.)
 Buoyancy of gases, 268.
 " " liquids, 235, 247.
 Bramah's Press, 220.
 Bréguet's Metallic Thermometer, 504.
 Britannia Bridge, expansion of, 503.
 Brittleness, definition of, 205.
 Brix, latent heat of vapors, 604.
 Bronze, tempering of, 212.
 Bunsen, absorption-meter, 402.
 " " solution of gases in liquids, 393.
 " " specific gravity of gases, 671. By effusion, 414.
 " " tension of condensed gases, 593.
 " " volume of gases, 679.
- CAGNIARD DE LA TOUR, experiments on dense vapors, 601.
 Calcite, hardness of faces of, 210.
 " " ratio of crystalline axes of, 122.
 " " rhombohedrons of, 152.
 Capillarity, 346.
 " " absorption of liquids by porous solids, 363.
 " " amount of pressure, 351.
 " " effects of pressure, 352.
 " " form of meniscus, 347, 349.
 " " general phenomena of, 346, 354.
 " " illustrations of, 353, 362.
 " " influence of temperature on, 360.
 " " numerical laws of, 355.
 " " pressure resulting from molecular forces, 349.
 " " verification of laws of, 357.
 Capillary Tubes, height of liquid in, 354.
 " " Plates, 357, 359. [358, 360.
 Carbonate of soda, laws of its solubility, 376.
 " " lime. (*See* Calcite.)
 Carbonic Acid, condensation of, 596, 609.
 Cathetometer, 185, 281.
 Cements, 343.
 Centre of Gravity, properties of, 60.
 " " position of, 61.
 " " oscillation, definition and properties of, 70.
 " " pressure, 220, 240.
 Centigrade Thermometric Scale, 436.
 Centrifugal force, 79.
 " " at equator, 82.
 " " measure of, 80.
 " " modifying gravity, 81.
 Centripetal force, 78.
 Charcoal, absorption of gases by, 380.
 Chemical Change, distinguished from solution, 371.
 " " Physics, definition of, 6.
 Chemistry, how distinguished from Physics, the three questions of, 5. [5.
 Chimney, theory of, 541.
 Cleavage, laws of, 205.
 " " planes of, 119, 204.
 Clock, description of, 72.
 Coefficient of absorption of gases, 392.
 " " compressibility of liquids, 217.
 " " conduction of heat, 659.
 " " cubic expansion, 492.
 " " elasticity, 186.
 " " expansion of gases, 528.
- Coefficient of expansion of water, 527.
 " " " of mercury, 510, 514.
 " " " linear expansion, 491.
 Cohesion, 119, 342.
 Coinage, 208.
 Collision of elastic bodies, 196.
 " " unelastic bodies, 49.
 Column. (*See* Mercury Column.)
 Combustion, heat from, 649.
 Components and Resultants, 38.
 Compressibility of gases, 115, 273, 648.
 " " laws of, 287.
 " " " limit to, 301.
 " " " (*See* Mariotte's Law.)
 " " of liquids, 215.
 " " of matter, illustrations of, 113.
 Condensation of gases, 592. [113.
 " " apparatus of Natterer, 598.
 " " apparatus of Thilorier, 596.
 " " by cold, 593.
 " " by pressure, 594.
 " " Faraday's experiments on, 599.
 " " Faraday's method, 595. [648.
 " " heat resulting from, 595.
 Condensed Gases, boiling-points of, 592.
 " " freezing-points of, 599.
 " " latent heat of, 609. [610.
 " " low temperature from, 593.
 " " maximum tension of, 593, 595. [595.
 Condensing-Pump, 333.
 Conduction of Heat, coefficients of, 659.
 " " illustrations of, 655.
 " " in crystals, 656.
 " " in gases, 657.
 " " " Grove's experiments on, 657.
 " " " in liquids, 657.
 " " " Despretz's experiments on, 657.
 " " " in liquids, Rumford's experiments on, 657.
 " " " in solids, conductors good and bad, 654.
 " " " in solids, experiments of Wiedmann and Franz, 656.
 " " " in solids, Ingenhousz's apparatus, 655.
 " " " in solids, laws of, 655.
 " " " in various metals, 656.
- Co-ordinates, definition of, 20
 Copper, tempering of, 212.
 Cornish Boiler, 616.
 Coulomb, laws of elasticity, 192.
 Couples, definition of mechanical, 47.
 Cryophorus, 609.
 Crystal, axes of, 121.
 " " centre of, 124.
 " " definition of, 121.
 " " parameters of planes of, 124.
 " " planes of, 121.
 " " similar axes of, 125.
 " " " planes of, 126.
 " " size of, 121.
 " " (*See* Form.)
 Crystalline form, 119.

- Crystalline form, identity of, defined, 183.
 " structure, 119.
 Crystallization, process of, 119.
 " water of, 372.
 Crystallography, 119.
 " terms of, 121.
 Crystals, cleavage of, 119, 204.
 " conduction of heat in, 656.
 " determination of, 175.
 " expansion of, 498.
 " groups of, 173.
 " irregularities of, 170.
 " models of, 132.
 " modifications of, 131, 175.
 " " laws governing,
 " simple and compound, 129. [132.
 " symbols of, 128.
 " systems of, 121, 175.
 " twin, 173.
 " (See Form.)
- DALTON'S Apparatus for tension of vapors,
 572.
 " Laws, 638.
 Daniell's Hygrometer, 643.
 Densimeter, 252.
 Density, definition of, 18. (See Mass.)
 " how related to weight, 91.
 Despretz, conduction of heat in liquids, 657.
 " expansion of water, 523, 526, 549.
 " experiments on Mariotte's Law,
 291.
- Dew, theory of, 653.
 Diffusion bottles, 419.
 " tube of Graham, 420.
 " of gases, 419.
 " " Dalton's theory of, 422.
 " " illustrations of, 423.
 " of liquids, 383. [384.
 " " Graham's experiments on,
 " " illustrations of, 384.
 " " laws of, 385.
 " " (See Osmose).
- Dimorphism, 184.
 Distillation, process of, 588.
 Dividing engine, 443.
 Divisibility of matter. (See Matter.)
 Ductility, 205.
 " order of, 207.
- Dulong and Petit, experiments on expansion
 of mercury, 508, 514.
 " specific heat of gases, 483, 489.
 " (See Arago.)
- Dynamics, definition of, 34.
- EARTH, centre of gravity of, 84.
 " eccentricity of, 83.
 " origin of form of, 85.
 " spheroidal figure of, 83.
- Effusion of gases, 412. [413.
 " " " experiments of Graham,
 " " " law of, 414.
 " " " use in determining Sp.
 Gr., 414.
- Elastic bodies, collision of, 196.
 Elasticity, coefficient of, 186.
 " definition of, 115.
 " limits of, 115, 193.
 " limited and unlimited, 115.
 " of compression, 187.
 " " crystals, 195.
- Elasticity of flexure, 187.
 " " applications of, 189.
 " " liquids, 115, 215.
 " " solids, 185.
 " " tension, laws of, 185.
 " " torsion, 191.
 " " " applications of, 193.
 " " " laws of, 192.
 " " perfect and imperfect, 115.
 " " varieties of, 115.
- Elements, chemical definition of, 3.
 Engine, dividing, 443.
 " steam, 615 *et seq.*
- Equilibrium, mechanical, definition of, 34.
 " of floating bodies, 242.
 " of liquids, 228. [62.
 " stable, unstable, and neutral,
 Expansion, coefficient of, 491.
 " force of, 499.
 " by heat, 430.
 " " cubic, 431, 492.
 " " linear, 431, 491.
 " heat absorbed in, 475, 480.
 " of gases, 528.
 " " expansion of air, 540.
 " " air-thermometer, 533.
 " " air-pyrometer, 539.
 " " coefficients of, 528.
 " " general laws of, 532.
 " " methods of determin-
 ing, 530.
 " " liquids, 507.
 " " above the boiling-
 point, 519.
 " " absolute and appar-
 ent, 507.
 " " change of rate with
 temperature, 517.
 " " experiments of Drion,
 519.
 " " experiments of Kopp,
 516.
 " " experiments of Pierre,
 516.
 " " formula for alcohol,
 ether, and oil of
 turpentine, 518.
 " " represented by curves,
 518.
 " " solids, 494.
 " " applications of, 504.
 " " determination of cubic,
 495, 515. [494.
 " " determination of linear,
 case of crystals, 498.
 " " " glass, 497, 498.
 " " experiments of Kopp,
 496.
 " " experiments of La Place
 and Lavoisier, 494.
 " " illustrations of, 500.
 " " order of compressibili-
 ty and expansibility,
 497.
 " " related to fusibility, 497.
 " " variation with temper-
 ature, 497.
 " " mercury, 508.
 " " coefficients of, 510.
 " " correction of barom-
 eter, 511.

Expansion of mercury, determination of absolute, 508.
 " " " determination of apparent, 513. [510.
 " " " empirical formula of, method of determining absolute, Dulong and Petit, 508, Regnault, 509.
 " " " Relation between apparent and absolute, 515.
 " " water, 520.
 " " " curve of, 521, 524.
 " " " coefficient of, 527.
 " " " determination of maximum density, 522.
 " " " empirical formulæ for, 526.
 " " " experiments of Despretz, 523.
 " " " experiments of Plücker and Geissler, 523.
 " " " point of maximum density, 520.
 " " " (See Maximum Density.)
 Extension, definition of, 10.
 " how measured, 11.

FAHRENHEIT, thermometric scale of, 435.
 Faraday, experiments on condensed gases, 595, 599.
 Floating bodies, laws of, 241.
 Fluidity, definition of, 215.
 Force, change of point of application, 38.
 " definition of mechanical, 32.
 " intensity and quantity of, 37, 53.
 " laws governing direction of, 32.
 " living, 52.
 " measure of, 34.
 " moving, 37. (See Momentum.)
 " origin of idea of, 6.
 " synonymous with volition, 7.
 " unit of, 36, 93.

Forces, centre of parallel, 43
 " centrifugal and centripetal, 77.
 " composition of, 38, 42.
 " " parallel, 43, 47.
 " decomposition of, 40.
 " illustration of parallel, 46.
 " parallelogram of, 39.
 " represented by lines, 38.
 " acting in the same direction, resultant of, 39.

Forces, Molecular, 117, 342. [351, 352.
 " " pressure exerted by, 349,
 Form, crystalline, 119, 127.
 " dominant and secondary, 130.
 " essential and accidental, 119.
 " hemihedral, 128.
 " holohedral, 127.
 " principal, 143, 151, 153, 159.
 " tetartohedral, 129, 156.
 " (See Hemihedral and Holohedral.)
 Forms of crystals. Dimetric, 142. Hexagonal, 147. Monoclinic, 163. Monometric, 132. Triclinic, 168. Trimetric, 158.

Formulæ:—
 Absolute expansion of mercury, 509.
 " weight, 87.
 Air-thermometer, 536—539.

Formulæ:—
 Air-pump, 327, 328.
 Analysis of gases by absorption, 411.
 Apparent expansion of mercury, 513, 514.
 Apparent and absolute coefficient of expansion, 515.
 Ascensional force of balloon, 272.
 Barometrical observations corrected for temperature, 511, 512.
 Capillarity, 357, 358.
 Centrifugal force, 80—83.
 Coefficient of expansion and specific gravity, 496. [516.
 Coefficient of expansion of solids, Collision of elastic bodies, 196—198.
 " unelastic bodies, 49—51.
 Compensating pendulum, 506.
 Conduction of heat, 659.
 Correction of thermometric observations, 449.
 Couples, 47.
 Decomposition of forces, 41.
 Density and weight, 91.
 Dimensions of safety-valve, 620.
 Effusion of gases, 415.
 Elasticity of flexure, 188.
 " tension, 186.
 " torsion, 192.
 Expansion by heat, 492, 493.
 " of gases, 529.
 " " determination of, Heat of fusion, 560. [531, 532.
 Hydrometer, 251, 252.
 Intensity of gravity, 65.
 " " at different latitudes, 77.
 La Place's and Babinet's, 305.
 Latent heat of steam, 607.
 Mariotte's flask, 323, 324.
 " law, 287, 288.
 Mass and density, 18.
 Measure of forces, 36.
 Measurement of height by barometer, 304, 305.
 Momentum, 37.
 Parallel forces, 45.
 Parallelogram of forces, 40.
 Pendulum, 68, 69, 73, 75, 76.
 Person's law, 561, 563.
 Power or quantity of a force, 53.
 Pressure of atmosphere, 279.
 " liquids, 219, 227, 232.
 Psychrometer, 644.
 Reduction of thermometric scales, 436, 446.
 " of volumes of gases to standard pressure, 314.
 " of volume of moist gases, 637.
 Relative and absolute weight, 95. [96.
 Relative specific weight and density, Relative specific weight and relative weight, 96.
 Relative weight and mass, 95, 96.
 Safety-tubes, 316, 317.
 Size of thermometer-bulb, 446.
 Solution of gases, 394.
 " of mixed gases, 406, 407, 409.
 Solubility of salts, 367.
 Specific gravity, 247—249, 257.

Formulæ:--

Specific gravity and mass, 92.
 Sp. Gr. and specific weight, 92.
 " and weight, 91.
 " of gases, 673.
 " of liquids corrected for temperature, 665.
 " of solids corrected for temperature, 663.
 " of vapors, 675, 676.
 " referred to air and water, 93.
 " weight and volume, 92.
 Specific heat of gases under constant volume, 481.
 " " method of mixture, 468.
 Specific weight, 90.
 Syphon, 321. [586.
 Tension and temperature of vapors,
 " " volume of vapors, 588.
 " of aqueous vapor, 581.
 Uniform motions, 23.
 Uniformly accelerated motion, 24, 25.
 " retarded motions, 26, 27.
 Variation of gravity with height, 86.
 Velocity of sound, 482.
 Volume of alcohol, etc., 518.
 " of gases, 681.
 " of mercury, 511.
 " of water, 527. [670.
 Weight of gas, reduced for latitude,
 " of one cm^3 of gas, 668, 669.
 " of bodies in air, 269.
 Woolf's apparatus, 319, 320.
 Franklin, on absorption of heat, 653.
 French System of Weights, 89.
 Freezing mixtures, 556.
 " point, 548.
 " " of water, 549.
 " " effect of salts on, 549.
 Friction, heat of, 648.
 Fulcrum, 97.
 Furnace, hot-air, 542.
 Fusion of solids, 548, 553. (See Melting and Freezing Points, and Heat of Fusion.)
 Fusion of solids, vitreous, 548. [557.
 " " change of volume attending,

GALILEO, proposition of composition of velocities, 28.
 Gallon, imperial, 14.
 Gases, absorption of, by solids, 379.
 " compressibility of, 115, 273, 287.
 " condensation of. (See Condensation.)
 " conduction of heat by, 657.
 " definition of quantity of, 394.
 " direction of pressure of, 265.
 " effusion of. (See Effusion.) [115.
 " elasticity of, perfect and unlimited,
 " expansion of. (See Expansion.)
 " fluidity of, 263.
 " formation of vapor in, 636.
 " how distinguished from liquids, 273.
 " " vapors, 585.
 " mechanical condition of, 263.
 " method of weighing, 270.
 " passage of, through membranes, 425.
 " permanent elasticity of, 274.
 " pressure due to gravity, 265.
 " solubility of. (See Solubility.)
 " specific gravity of, 93, 273, 670.
 " tension of, definition, 263.

Gases, transmission of pressure, 264.
 " transpiration of, 417.
 " volume of, 679. (See Weighing and Measuring.)
 " " how reduced to standard pressure, 313.
 " " moist, how reduced, 637.
 " weight of, 270, 667.
 Gasometers, 314.
 Gay-Lussac, solubility of sulphate of soda, 374, 375.
 Geometry, subject-matter of, 11.
 Glass, annealing of, 212.
 " expansion of, at different temperatures, 498, 499.
 Glauber Salts. (See Sulphate of Soda.)
 Gold-Leaf, illustrates divisibility of matter, manufacture of, 206. [109.
 Goniometer, Application, 177.
 " Reflective, 178.
 " Babinet's, 183.
 " Haidinger's, 183.
 " Mitscherlich's, 182.
 " Rudberg's, 182.
 " Suckow's, 183.
 " Wollaston's, 179.
 Goniometry, Miller's method of, 181. [384.
 Graham's experiments on diffusion of liquids,
 " " of gases, 420.
 " " effusion, 413.
 " " osmose, 389.
 " " transpiration, 417.
 Grailich and Pekarek's Sclerometer, 209.
 Gramme, definition of, 89.
 Grassi, on compressibility of liquids, 217.
 Gravitation, law of, 86.
 Gravity, acceleration of, 65.
 " Borda's and Cassini's experiments on, 74.
 " causes of variation of earth's, 77.
 " centre of, 60.
 " definition of, 56.
 " direction of earth's, 57.
 " intensity of, 64.
 " " how measured, 66.
 " " represented by g , 65.
 " irregularities of, 77.
 " measured by pendulum, 73.
 " point of application of earth's, 58.
 " proportional to quantity of matter, resultant of forces of, 59. [65.
 " value of, at different latitudes, 76.
 " varies with distance, 85.
 " (See Specific Gravity.)
 Gypsum, form of crystals of, 174.
 " ratio of crystalline axes of, 123.
 HALLSTROM, expansion of water, 523.
 Hardness, definition of, 208.
 " how measured, 208.
 " of crystals, 209.
 " scale of, 209.
 " sclerometer, 209.
 Heat, a repulsive force, 118.
 " absorbed by expansion, 475, 480.
 " an expansive force, 430.
 " central, 647.
 " definition of, 426.
 " mechanical equivalent of, 484, 633.
 " theories of, 426.
 " (See Conduction, Radiant, & Sources.)

- Heat of Fusion, 555.
 " " freezing mixture, 556.
 " " how determined, 559.
 " " Person's law, 560.
- Hemihedral Forms, 128, 135, 138, 145, 149,
 Hemi-octahedrons, 163. [161, 167.]
 Hemi-prisms, 165.
 Hemitropes, 174.
 Holohedral Form, 127, 133, 142, 147, 158, 163.
 Hopkins, effect of pressure on melting-point,
 Hydrometer, 249. [550.]
 " Baumé's, 253.
 " Fahrenheit's, 251.
 " Nicholson's, 250.
 " Rousseau's, 255.
- Hydrostatic
 " Balance, 248.
 " Paradox, 228.
 " Press, 220.
- Hygrometer, 639.
 " Daniell's, 643.
 " Deluc's, 645.
 " Hair, 645.
 " Regnault's, 642.
 " Saussure's, 645.
 " Wet-bulb, 644.
- Hygrometry, 636.
 " Dalton's laws, 638.
 " dew-point, 641.
 " drying apparatus, 646.
 " formation of mixed vapors, 638.
 " " of vapor in air, 636.
 " relative humidity of air, 640.
 " tension of vapor in air, 636.
 " volume of moist gases, how reduced, 637.
- Hypothesis, how related to law, 7.
- IMPENETRABILITY, definition of, 19.
 India-rubber, adhesion of, 343.
 " used for joints, 343.
- Inertia, definition of, 32.
 Iodine, crystallization of, 120.
- JOULE, mechanical equivalent of heat, 484,
 633.
- KATER, experiments on the pendulum, 12, 71.
 Kilogramme, origin and history of, 15.
 Klino-diagonal axis, 123, 164.
 Kopp, change of volume in fusion, 551.
 " cubic expansion, 496.
 " expansion of liquids, 516.
 " volume of water at different temperatures, 526.
- LA PLACE, formula of, 305.
 " velocity of sound, 482.
- Latent Heat. (*See* Heat of Fusion.)
 Latent Heat of Vapor, 603.
 " " application in case of steam, 611.
 " " Brix's experiments on, cryophorus, 609. [604.]
 " " determination of, 603.
 " " illustrations of, 608.
 " " in equal volumes, 606.
 " " in steam at different temperatures, 606.
 " " Leslie's experiment on, 609.
 " " porous water-jars, 608.
- Latent Heat of Vapor, Regnault's experiments on, 607.
 " " solid carbonic acid, 610.
 " " spheroidal condition of liquids, 611.
 " " Watt's theory, 606.
- Latitude, variation of gravity with, 76.
 " " of weight of gases with, 670.
- Lavoisier and Laplace, measurement of linear expansion, 494.
 Law, criterion of its validity, 8.
 " Dalton's, 638.
 " definition of, 7.
 " Mariotte's, 287.
 " nature of a physical, 7, 300.
 " of gravitation, 86.
 " Person's, 560.
 " relation of, to Divine Mind, 7.
 " Watt's, 606.
- Laws of capillarity, 355.
 " cleavage, 205.
 " crystalline symmetry, 132.
 " diffusion of gases, 420.
 " " liquids, 383.
 " Dulong, 484, 489.
 " elasticity, 186.
 " liquid equilibrium, 229.
 " " pressure, 227.
 " solution of gases, 392.
 " torsion, 192.
 " transpiration, 417.
- Length, units of, English, 11. French, 14.
 Leslie's experiment, 609.
- Lever, arms of, 98.
 " conditions of equilibrium of, 98.
 " general theory of, 97.
 " three kinds of, 97.
- Leverage, definition of, 100.
- Light, plane of polarization rotated by crystals, 162, 167.
- Liquid state, 117.
- Liquids, adhesion to solids. (*See* Solids.)
 " centre of pressure of, 220.
 " characteristic properties of, 215.
 " compressibility of, 114, 216.
 " diffusion of, 383. (*See* Diffusion.)
 " direction of pressure of, 219.
 " elasticity of, 115, 215.
 " expansion of. (*See* Expansion.)
 " how distinguished from gases, 273.
 " laws of buoyancy of, 235-247.
 " " equilibrium of, 228-232.
 " " pressure of, 224-227.
 " mechanical condition of, 215.
 " pressure due to gravity, 223.
 " principle of Archimedes, 235.
 " specific gravity of, 247 *et seq.*, 665.
 " spheroidal condition of, 361.
 " transmission of pressure, 218.
 " volume of, 666. (*See* Weighing and Measuring.)
- Litre, 17.
- Locomotive Boiler, 618.
 " Engine, 628.
- Loewel's experiments on solubility of carbonate of soda, 376.
 " " on solubility of sulphate of soda, 374.
 " " on supersaturated solutions, 378.

- MAKRO-DIAGONAL AXES, 123.**
Malleability, 205.
 " order of, 207. [208.
 " variations with temperature,
Manometer, Regnault's, 308.
 " metallic, of Bourdon, 189.
 " with confined air, 310.
Marcet's Globe, 574.
Mariotte's Flask, 323.
 " Law, application of, 301.
 " " deviations from, 290, 299, 532,
 586, 602.
 " " experiments on, Arago and
 Dulong, 293.
 " " " Despretz, 291.
 " " " Natterer, 299.
 " " " Oersted, 290.
 " " " Regnault, 295.
 " " history of, 290.
 " " illustrations of, 288.
 " " relation to expansion of gas-
 es, 532, 586.
 " " statement of, 287.
Mass, definition of, 18
 " relation to density, 18.
 " unit of, 91.
Matter, compressibility of, 113.
 " definition of, 3.
 " divisibility of, an accidental prop-
 erty, 109.
 " essential nature of, not understood, 3.
 " " and accidental properties
 of, 10.
 " expansibility of, 113.
 " general and specific properties of, 3.
 " illustrations of its porosity, 110.
 " physical and chemical properties, 5.
Maximum density of water, 520.
 " " " effects of salts
 on, 526.
 " " " history of dis-
 covery of, 522.
 " " " important bear-
 ings of, 525.
Measure, English system of, 11. (See Yard.)
 " French system of, its history, 14.
Measuring. (See Weighing and Measuring.)
Mechanics, subject-matter of, 32.
Melting-Point, 548.
 " effect of pressure on, 550.
 " of alloys, determination of,
Meniscus, form of, 347, 349. [554.
Mercurial Thermometers, 432.
 " " arbitrary scale, 446.
 " " calibration of, 443.
 " " change of zero-point,
 441.
 " " comparison of dif-
 ferent, 439.
 " " construction of stan-
 dard, 442.
 " " defects of, 436.
 " " filling of, 433.
 " " graduation of, 433.
 " " observations, how
 corrected, 448.
 " " size of bulb of, 445.
Mercury column, how measured, 280.
 " " expansion of. (See Ex-
 pansion.)
Metacentre, definition of, 244.
Metals, crystallization of, 120.
Metre, an arbitrary measure, 16.
 " origin and history of, 14.
 " subdivisions of, 17.
Mitscherlich, expansion of crystals, 498.
 " goniometer, 182.
Modifications of crystals, 131.
 " " laws of, 132.
Mohs's scale of hardness, 209.
Molecular forces, two classes of, 117. (See
Forces.)
Moment, definition of, 100.
Momentum, definition of, 37.
Motion, a relative term, 21.
 " an essential property of matter, 21.
 " compound, 27.
 " curvilinear, how resulting, 29.
 " origin of idea of, 21.
 " parallelogram of, 27.
 " possible in several directions at once,
 uniform, and varying, 23. [22.
 " uniformly accelerated, 23.
 " " retarded, 26. [598.
NATTERER, apparatus for condensing gases,
 " experiments on compressibility
 of gases, 299.
Newton, discovery of law of gravitation, 87.
 " formula for velocity of sound, 482.
 " opinion on atomic theory, 110.
ORTHO-DIAGONAL AXIS, 123.
Osmometer, 387.
Osmose, 387.
 " explanation of, 388.
 " Graham's experiments on, 389.
 " how allied to chemical affinity, 391.
PARAMETERS of crystalline planes, 124.
Pendulum, amplitude of oscillation, 68.
 " Bessel's experiments on, 76.
 " Borda's and Cassini's experi-
 ments on, 74, 76.
 " centre of oscillation of, 70.
 " definition of, 66.
 " formula of, 68, 69.
 " Harrison's gridiron, 505.
 " how affected by the air, 75.
 " isochronism of, 68.
 " Kater's experiments on, 12, 71.
 " laws of oscillation of, 69.
 " Martin's compensation, 506.
 " measure of force of gravity, 73.
 " " of time, 71.
 " simple and compound, 66, 69.
 " theory of, 67.
 " virtual length of, 70.
Physical changes, how distinguished from
chemical, 4.
 " properties, how distinguished from
 chemical, 5.
Physics, how distinguished from Chemistry,
Planes of cleavage, 119. [5.
 " similar, 126, 175.
 " symbols of crystalline, 128.
 " terminal and basal, 159.
Plumb-Line, use of, 57.
Pneumatic Trough, 311, 680.
Polyhedron, 121.
Polymorphism, 184.
Pores, size of, Herschel's opinion, 113.

- Porosity, 110.
 " Florentine experiments on, 112.
 " illustrations of, 111.
 " implies compressibility, 113.
 Position of a body, how defined, 20.
 " origin of idea of, 20.
 Pound, Troy and Avoirdupois, 90.
 " United States standard, 90.
 Power of a force, 37, 52.
 Pressure of the atmosphere, 266.
 " " measured by barometer, 279.
- RADIANT HEAT, 651.**
 " " absorption of, 652.
 " " analogous to light, 651.
 " " emission of, 653. [653.
 " " Franklin's experiments,
 " " freezing water by radiation, 654.
 " " hot-beds, 654.
 " " laws of, 651.
 " " phenomena of dew, 653.
 " " radiation of cold, 651.
 " " reflection of, 652.
 " " transmission through media, 652.
- Refrigerator, 543.
 Regnault, comparison of thermometers, 439.
 " determination of tension of vapors, 575. [295.
 " experiments on Mariotte's law,
 " " on specific heat, 466,
 [467, 469, 471, 474, 476.
 " hygrometer, 642.
 " hygrometry, 644, 645.
 " latent heat of aqueous vapor, 607.
 " method of weighing gases, 270.
 " specific gravity of gases, 667.
 " " of vapors, 676.
 " weight of gases, 667.
- Relative Weight. (See Weight.)
 " specific weight, 96.
 Rest, a relative term, 21.
 Rhombohedron, 149.
 Rolling-Mill, 206.
 Rumford, conduction of heat in liquids, 657.
 " heat of friction, 648.
 Rupert's Drops, 212.
 Rupture, resistance to, 201.
 " law of, 202.
- SAFETY-TUBES, theory of, 315.**
 " valve, 619.
 Savart, elasticity of crystals, 196.
 Scalenohedron, 153.
 Sclerometer, 209.
 Section, principal, 151, 159.
 Set, definition of, 116, 194.
 Silliman, diffusion apparatus, 423.
 Similar axes, 125.
 " edges, 131.
 " planes, 126, 175.
 " solid angles, 131.
 Siphon, theory of, 320.
 Solid state, 117.
 Solids, absorption of liquids by porous, 363.
 " " of gases by, 379.
 " adhesion between, 342.
 " " to liquids, Gay-Lussac's experiments, 345.
- Solids, characteristic properties of, 119.
 " compressibility of, 113.
 " conduction of heat in, 655.
 " elasticity of, imperfect and limited, fusion of. (See Fusion.) [116.
 " porosity of, 110.
 " specific gravity of, 91, 247, 662.
 " volume of, 664.
 " weight of, 87, 100, 661. (See Weighing and Measuring.)
- Solubility of carbonate of soda, 376, 377.
 " of sulphate of soda, 372 - 375.
 " of gases, causes of variation, 398.
 " " coefficient of absorption, 392.
 " " determination of coefficient, 398.
 " " expression by empirical formulæ, 393.
 " " mixed gases, 405. [394.
 " " variation with pressure, 393.
 " " variation with temperature, 393.
 " " (See Absorption-Meter.)
 " of solids, curves of, 367.
 " " determination of, 369.
 " " empirical formulæ of, 366.
 " " uninfluenced by fusion, 369.
 " " variation with temperature, 365.
- Solution, how distinguished from chemical change, 371.
 " of gases, 392.
 " of solids in liquids, 365.
 " supersaturated, 376.
- Sources of Heat, 647.
 " " central heat, 647.
 " " calculations of Fourier, 647.
 " " chemical, 649.
 " " condensation, 648.
 " " friction, 648.
 " " percussion, 648.
 " " sun, 647.
- Sp. Gravity, 91, 247.
 " bottle, 247.
 " methods of determining, 247 - 257.
 " of gases, 93, 273. [414.
 " " determined by effusion,
 " " referred to air, 93.
 " relation to specific weight in French system, 92.
- Sp. Heat, 464.
 " of gases, 476, 478.
 " " under constant pressure, 477.
 " " under constant pressure, does not vary with temperature or pressure, 477.
 " " under constant volume, 480.
 " " under constant volume, determination from velocity of sound, 482.
 " " under constant volume, Dulong's experiments, 483.
 " " under constant volume, Dulong's laws, 484, 489.

- Sp. Heat of platinum, and determination of high temperatures, 473.
 " of solids and liquids, 466.
 " connected with their chemical equivalents, 471.
 " determination of, 466, 467.
 " greater in liquids than in solids, 475.
 " greatest in water, 476.
 " of the elements, 466.
 " unit of heat, 464, 472.
 Sp. Weight, 90.
 " relative, 96.
 Spheroidal condition of liquids, 361, 611.
 " " Boutigny's experiments, 613.
 " " illustrations of, 614.
 " " temperature in, 612.
 " " freezing of water in, 614.
 Spirit-Level, 232.
 Spring-Balance, 94, 189.
 Standards of measure. (*See Yard and Metre.*)
 " of weight. (*See Gramme and Pound.*)
 Statics, definition of, 34.
 Steam, 572. (*See Vapors.*)
 " application of latent heat of, 611.
 " bath, 591.
 " expansion at formation of, 603.
 " latent heat of, at different temperatures, 606, 632.
 " " " Regnault's results, 607.
 " " " theory of Watt as to, 606.
 " mechanical power of, 631. [606.
 " volume of, 631.
 Steam-Boiler, 615.
 " appendages of, 618.
 " Cornish, 616.
 " dimensions of, 620.
 " " heating surface,
 " French form of, 617. [616.
 " fusible plug, 620.
 " locomotive, 617.
 " requisites of, 615.
 " safety-valve, 619.
 Steam-Engine, 615.
 " condenser, 625.
 " cut-offs, 633.
 " fly-wheel, 623.
 " high-pressure, 628, 633.
 " locomotive, 628.
 " low-pressure, 621, 633.
 " mechanical power of, 631.
 " non-condensing, 628.
 " parallel motion, 624.
 " the eccentric, 625.
 " Watt's condensing, 621.
 Substances, definition of, 3.
 Sugar, hemihedral forms of, 168. [169.
 Sulphate of copper, crystalline form of, 124,
 " of iron, crystalline form of, 123.
 " of lime, crystalline form of, 123.
 " of soda, laws of solubility, 372, 375.
 " " osmotic equivalent of, 388.
 " " soluble modifications of, 374.
 " " supersaturated solution of, 376.
 " " use of, in freezing mixtures, 557.
 Sulphide of hydrogen, coefficient of absorption of, 399.
 Sulphur, how crystallized, 120.
 " ratio of crystalline axes of, 123.
 Sulphurous Acid, coefficient of absorption of, 401.
 " " condensation of, 593.
 Supersaturated Solution, 376.
 Surface, units of. English, 13. French, 17.
 Syphon, theory of, 320.
 System, dimetric, 122, 142.
 " hexagonal, 122, 147.
 " monoclinic, 123, 163.
 " monometric, 121, 182.
 " triclinic, 123, 168.
 " trimetric, 123, 158.
 Systems of crystals, 121.
 TABLES:—
 Absorption of gases by charcoal, 380;
 by Meerschaum, plaster of Paris, and silk, 381.
 Boiling-points of condensed gases, 592.
 " " liquids, 566.
 " " saline solutions, 568.
 Coefficients of compressibility of liquids,
 " of elasticity, 187. [217.
 " of expansion of glass at different temperatures, 497.
 " of expansion of mercury, 510.
 Comparison of different mercurial thermometers, 439.
 " of mercurial with air-thermometers, 439.
 " of thermometers filled with different liquids, 451.
 Compressibility of gases by Arago and Dulong, 294.
 " " by Natterer, 299.
 " " by Regnault, 296.
 Conducting power of metals, by Despretz, 659; by Wiedman and Franz, 656.
 Determination of crystals, 176.
 Diffusion of solids in solution, 385.
 Dimension of steam-boilers, 621.
 " of the earth, 83.
 Effect of pressure on melting-point, 550.
 Effusion and Diffusion of gases, 414.
 Expansion of matter by heat, 431.
 " in vaporization, 603.
 " of gases, 528.
 " of liquids, 517. [519.
 " " above boiling-point,
 Freezing-points of condensed gases, 599.
 French linear measure, 17.
 " system of weights, 89.
 Greatest density of vapors, 601.
 Groups of equi-diffusive substances, 386.
 Heat of combustion, 650.
 " fusion, 556.
 Height of liquids in capillary tubes, 358, 361.
 Intensity of gravity at different latitudes, 76.
 Latent heat of aqueous vapors, by Watt, 606; by Regnault, 608.
 " " of vapors, 605.
 Limit of elasticity, 195.
 Mechanical power of steam, 631.
 Melting-points, 548.
 " of alloys, 550.

Tables: —

- Person's law, 562.
 Pressure and specific gravity of the air at increasing altitudes, 306.
 Scale of hardness, 209.
 Solubility of carbonate of soda, 377.
 " of chloride of potassium, 366.
 " of gases, 393.
 " of nitre, 366.
 " of sulphate of soda, 375.
 Sp. Heat of elements, 466.
 " of equal volumes of gases, 483.
 " of gases and vapors, 478.
 " in solid and liquid state, 475.
 " of liquids at different temperatures, 474.
 " of modifications of carbon, 476.
 " of platinum at different temperatures, 473.
 " of solids at different temperatures, 473.
 " of water at different temperatures, 472.
 Temperature of liquids in spheroidal condition, 612.
 Tenacity, ductility, malleability, 207.
 Tension of aqueous vapors, 571.
 " of condensed gases, 593.
 " " " at 0°, 595.
 " of vapors of liquids, 583.
 Tints of heated steel, 211.
 Transpirability of gases, 418.
 Weight of gases, 668.
 Tartaric Acid, hemihedral forms of, 167.
 Tartrate of soda and ammonia, hemihedral forms of, 162.
 Temperature, absolute zero, 564.
 " definition of, 463.
 " determined by specific heat of platinum, 473.
 " influence of, on solubility, 366.
 " lowest observed, 452, 565.
 " measured by a thermometer, of celestial space, 564. [432.
 " obtained with condensed gases, 610.
 " thermal equilibrium, 463.
 " true, 539.
 Tempering, 211.
 " of bronze, 212.
 " of copper, 212.
 " of glass, 212.
 Tenacity, 203.
 " means of measuring, 202.
 " order of, 207.
 Tension of gases. (*See Gases.*)
 " of vapors. (*See Vapors.*)
 Tetrahedral Forms, 129, 156.
 Theory, atomic, 110.
 Theories, how related to laws, 7.
 Thermometer, air, 455, 534.
 " alcohol, 451.
 " filled with various liquids, 451.
 " fixed points of, 433.
 " house, 450.
 " maximum and minimum, 452.
 " mercurial, 432.
 " metallic, of Bréguet, 504.
 " Negretti and Zambra's, 453.
 " Rutherford's, 452.
 " scales of, 435.
 Thermometer, scales of, reduction of, 436.
 " Walferdin's, 454.
 " water, 438.
 " weight, 513.
 " (*See also Air, and Mercurial.*)
 Thermo-multiplier, Melloni's, 457.
 Thermoscopes, Leslie's, 456.
 " Rumford's, 457.
 " Sanctorius's, 456.
 Time, how measured, 22.
 " origin of the idea of, 22.
 " units of, 22.
 Tin, ratio of crystalline axes of, 122.
 Torricelli's experiments, 275.
 Torsion Balance, 193.
 " elasticity of, 191.
 Transpiration of gases, laws of, 417.
 Troughton, standard yard, 13.
 Truncation, 131.
 Twin crystals, 173.
 UNIT of force, 36, 93.
 " heat, 464, 472.
 " length, 11, 14, 17.
 " mass, 91.
 " surface, 13, 17.
 " volume, 13, 17.
 " weight, 89.
 VAPOR, aqueous tension of, 571.
 " " " Dalton's apparatus, 572.
 " apparatus of Gay-Lussac, 574.
 " " Regnault, 575.
 " empirical formulæ for, 581.
 " formation in atmosphere of gas, 636.
 " (*And see Hygrometry.*)
 " geometrical curve of, 580.
 " laws governing, 580.
 " Marcet's globe, 574.
 " Papin's digester, 591.
 " (*See Latent Heat of Vapor.*)
 Vapors, expansion attending formation of, formation of, 570, 582. [603.
 " greatest density of, 600.
 " how distinguished from gases, 585.
 " maximum tension of, 584.
 " smallest density of, 602.
 " specific gravity of, 674 *et seq.*
 " tensions of, compared, 584.
 " weight of, 669.
 Velocities, composition of, 28.
 Velocity, definition of, 23.
 Vis viva, 53.
 Volume, definition of, 10.
 " how estimated, 14.
 " units of. English, 13. French, 17.
 Volumeter, Gay-Lussac's, 252.
 WASH-BOTTLE, 325.
 Water, change of volume in freezing, 552.
 " effect of pressure on melting-point, 550.
 " expansion of. (*See Expansion.*)
 " freezing-point of, 549.
 " maximum density of. (*See Maximum Density.*)
 " pump, 334. [526.
 " volume of, at different temperatures,
 Watt, law of, 606.
 " steam-engine of, 621.

- Weighing and Measuring, 661.
- Sp. Gr. of gases, Bunsen's method, 671.
- “ “ Regnault's method, 670.
- “ of liquids, 91, 249, *seq.*
- “ “ corrected for temperature, 665.
- “ of solids, 91, 247.
- “ “ corrected for temperature, 662.
- “ of vapors, 674. *seq.* [678.
- “ “ Deville's method, 675.
- “ “ Dumas's method, 675.
- “ “ Gay-Lussac's method, 678.
- “ “ Regnault's method, 676.
- Volume of gases, 679.
- “ of liquids, 666.
- “ of solids, 664.
- Weight of gases, 270, 667.
- “ of solids, 87, 100, 661.
- “ of vapors, 669.
- Weight, absolute, 87.
- “ “ distinct from mass, 88.
- “ “ liable to variation, 89.
- “ “ measure of quantity of matter, 88.
- “ of a body in air, 268.
- “ relative, 94.
- “ “ a constant quantity, 95.
- “ “ measured by the balance, 94.
- “ specific, 90.
- “ of a unit of mass, 91.
- Weights described, 94.
- Wells's theory of dew, 653.
- Welter's tube, 317.
- Wertheim, experiments on elasticity, 187.
- Wire-Mill, 205.
- Woolf's Bottles, 318.
- YARD, act of Parliament concerning, 11.
- “ American standard, 13.
- “ origin and history of, 11.
- “ standard, destroyed by fire, 12.

THE END.

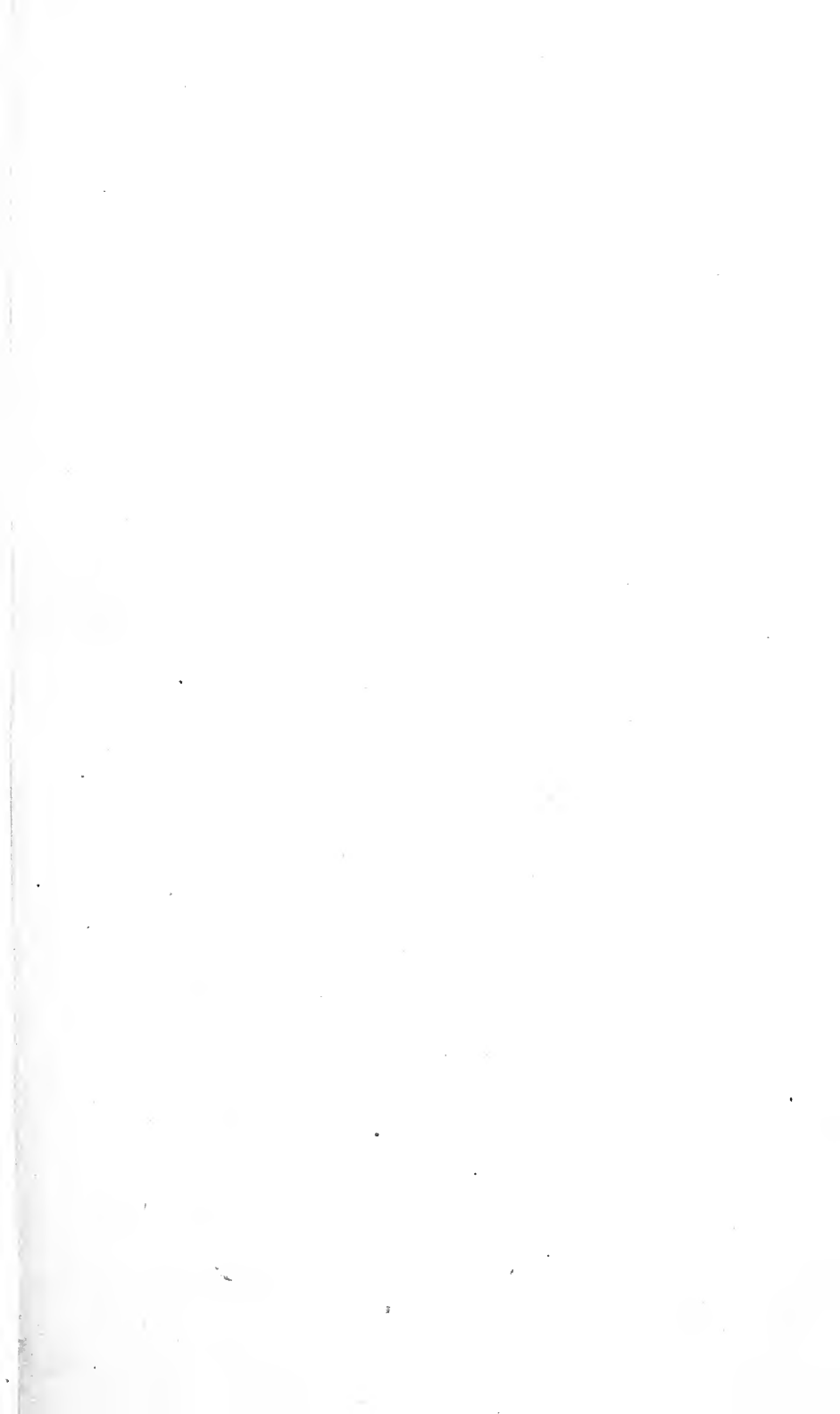



14 DAY USE
RETURN TO DESK FROM WHICH BORROWED
LOAN DEPT.

RENEWALS ONLY—TEL. NO. 642-3405

This book is due on the last date stamped below, or
on the date to which renewed.
Renewed books are subject to immediate recall.

APR 1 1970 4 0

REC'D LD

APR 3 '70 -9AM

LD21A-60m-6,'69
(J9096s10)476-A-32

General Library
University of California
Berkeley

QC.171

C6

Cooke

237518

THE UNIVERSITY OF CALIFORNIA LIBRARY

