



Encyclopaedia Britannica;

OR, A

DICTIONARY

OF

ARTS, SCIENCES, AND MISCELLANEOUS
LITERATURE;

ENLARGED AND IMPROVED.

THE FOURTH EDITION.

Illustrated with nearly six hundred Engravings.

VOL. XIX.

INDOCTI DISCANT; AMEN MEMINISSE PERITI.

EDINBURGH:

Printed by Andrew Bell, the Proprietor,

FOR ARCHIBALD CONSTABLE AND COMPANY, EDINBURGH;

AND FOR VERNOR, HOOD, AND SHARPE,

LONDON.

1810.

ENCYCLOPÆDIA BRITANNICA.

SCRIPTURE continued from last Volume.

Scripture.
55
Jeremiah.

JEREMIAH was called to the prophetic office in the 13th year of the reign of Josiah the son of Amos, A. M. 3376, A. C. 628, and continued to prophecy upwards of 40 years, during the reigns of the degenerate princes of Judah, to whom he boldly threatened those marks of the divine vengeance which their rebellious conduct drew on themselves and their country. After the destruction of Jerusalem by the Chaldeans, he was suffered by Nebuchadnezzar to remain in the desolate land of Judea to lament the calamities of his infatuated countrymen. He was afterwards, as he himself informs us, carried with his disciple Baruch into Egypt, by Johanan the son of Kareah.

It appears from several passages that Jeremiah committed his prophecies to writing. In the 36th chapter we are informed, that the prophet was commanded to write upon a roll all the prophecies which he had uttered; and when the roll was destroyed by Jehoiakim the king, Jeremiah dictated the same prophecies to Baruch, who wrote them together with many additional circumstances. The works of Jeremiah extend to the last verse of the 51st chapter; in which we have these words, "Thus far the words of Jeremiah." The 52d chapter was therefore added by some other writer. It is, however, a very important supplement, as it illustrates the accomplishment of Jeremiah's prophecies respecting the fate of Zedekiah.

The prophecies of Jeremiah are not arranged in the chronological order in which they were delivered. What has occasioned this transposition cannot now be determined. It is generally maintained, that if we consult their dates, they ought to be thus placed:

In the reign of Josiah the first 12 chapters.
11, 14; xlii. xliii. xxv. xxvi. xxxv. xxxvi. xlv.—xlix. 1—35.

In the reign of Zedekiah, chap. xxi. 1—10. xxiv. xxvii. xxviii. xxxix. xlix. 34—39. l. and li.

Under the government of Gedaliah, chapters xl. xlv. The prophecies which related to the Gentiles were contained in Vol. XIX. Part 1.

Scripture.
tained in the 46th and five following chapters, being placed at the end, as in some measure unconnected with the rest. But in some copies of the Septuagint these six chapters follow immediately after the 13th verse of the 25th chapter.

Jeremiah, though deficient neither in elegance nor sublimity, must give place in both to Isaiah. Jerome seems to object against him a sort of rusticity of language, no vestige of which Dr Lowth was able to discover. His sentiments, it is true, are not always the most elevated, nor are his periods always neat and compact; but these are faults common to those writers whose principal aim is to excite the gentler affections, and to call forth the tear of sympathy or sorrow. This observation is very strongly exemplified in the Lamentations, where these are the prevailing passions; it is, however, frequently instanced in the prophecies of this author, and most of all in the beginning of the book (L), which is chiefly poetical. The middle of it is almost entirely historical. The latter part, again, consisting of the last six chapters, is altogether poetical (M); it contains several different predictions, which are distinctly marked; and in these the prophet approaches very near the sublimity of Isaiah. On the whole, however, not above half the book of Jeremiah is poetical.

The book of Lamentations, as we are informed in the title, was composed by Jeremiah. We shall present to our reader an account of this elegiac poem from the elegant pen of Dr Lowth.

The Lamentations of Jeremiah (for the title is properly and significantly plural) consist of a number of plaintive effusions, composed on the plan of the funeral dirges, all on the same subject, and uttered without connection as they rose in the mind, in a long course of separate stanzas. These have afterwards been put together, and formed into a collection or correspondent whole. If any reader, however, should expect to find in them an artificial and methodical arrangement of the general subject, a regular disposition of the parts, a perfect connection and orderly succession in the matter,

A and

(L) See the whole of chap. ix. chap. xiv. 17, &c. xv. 14—18.

(M) Chap. xlvj.—li. to ver. 50. Chap. lii. properly belongs to the Lamentations, to which it serves as an exordium.

Chronological arrangement of his writings.

57
The book of Lamentations.

and with all this an uninterrupted flow of elegance and correctness, he will really expect what was foreign to the prophet's design. In the character of a mourner, he celebrates in plaintive strains the obsequies of his ruined country; whatever presented itself to his mind in the midst of desolation and misery, whatever struck him as particularly wretched and calamitous, whatever the instant sentiment of sorrow dictated, he pours forth in a kind of spontaneous effusion. He frequently pauses, and, as it were, ruminates upon the same object; frequently varies and illustrates the same thought with different imagery, and a different choice of language; so that the whole bears rather the appearance of an accumulation of corresponding sentiments, than an accurate and connected series of different ideas, arranged in the form of a regular treatise. There is, however, no wild incoherency in the poem; the transitions are easy and elegant.

The work is divided into five parts: in the first, second, and fourth chapters, the prophet addresses the people in his own person, or introduces Jerusalem as speaking. In the third chapter a chorus of the Jews is represented. In the fifth the whole captive Jews pour forth their united complaints to Almighty God. Each of these five parts is distributed into 22 stanzas, according to the number of the letters of the alphabet. In the first three chapters these stanzas consist of three lines. In the first four chapters the initial letter of each period follows the order of the alphabet; and in the third chapter each verse of the same stanza begins with the same letter. In the fourth chapter all the stanzas are evidently distichs, as also in the fifth, which is not acrostic. The intention of the acrostic was to assist the memory to retain sentences not much connected. It deserves to be remarked, that the verses of the first four chapters are longer by almost one half than Hebrew verses generally are: The length of them seems to be on an average about 12 syllables. The prophet appears to have chosen this measure as being solemn and melancholy.

That the subject of the Lamentations is the destruction of the holy city and temple, the overthrow of the state, the extermination of the people; and that these events are described as actually accomplished, and not in the style of prediction merely, must be evident to every reader; though some authors of considerable reputation have imagined this poem to have been composed on the death of King Josiah. The prophet, indeed, has so copiously, so tenderly, and poetically, bewailed the misfortunes of his country, that he seems completely to have fulfilled the office and duty of a mourner. In my opinion, there is not extant any poem which displays such a happy and splendid selection of imagery in so concentrated a state. What can be more elegant and pathetic, than the description of that once flourishing city, lately chief among the nations, sitting in the character of a female, solitary, afflicted, in a state of widowhood, deserted by her friends, betrayed by her dearest companions, imploring relief, and feeling consolation in vain? What a beautiful personification is that of the ways of Sion mourning because none are come to her solemn festival? How tender and pathetic are the following complaints?

Is it nothing to all you who pass along the way? to hold and see,

If there be any sorrow, like unto my sorrow, which is inflicted on me; Which Jehovah inflicted on me in the day of the violence of his wrath.

For these things I weep, my eyes stream with water; Because the comforter is far away, that should tranquillize my soul:

My children are desolate, because the enemy was strong,

But to detail its beauties would be to transcribe the entire poem.⁶⁰

Ezekiel was carried to Babylon as a captive, and received the first revelations from heaven, in the fifth year of Jehoiakim's captivity, A. C. 595. The book of Ezekiel is sometimes distributed under different heads. In the three first chapters the commission of the prophet is described. From the fourth to the thirty-second chapter inclusive, the calamities that befel the enemies of the Jews are predicted, viz. the Ammonites, the Moabites, and Philistines. The ruin of Tyre and of Sidon, and the fall of Egypt, are particularly foretold; prophecies which have been fulfilled in the most literal and astonishing manner, as we have been often advised by the relation of historians and travellers. From the 32d chapter to the 42th he inveighs against the hypocrisy and murmuring spirit of his countrymen, admonishing them to reformation by promises of deliverance. In the 38th and 39th chapters he undoubtedly predicts the final return of the Jews from their dispersion in the latter days, but in a language so obscure that it cannot be understood till the event take place. The nine last chapters of this book furnish the description of a very remarkable vision of a new temple and city, of a new religion and polity.

Ezekiel is much inferior to Jeremiah in elegance; in sublimity he is not even excelled by Isaiah; but his sublimity is of a totally different kind. He is deep, vehement, tragical; the only sensation he affects to excite is the terrible; his sentiments are elevated, fervid, full of fire, indignant; his imagery is crowded, magnificent, terrific, sometimes almost to disgust; his language is pompous, solemn, austere, rough, and at times unpolished; he employs frequent repetitions, not for the sake of grace or elegance, but from the vehemence of passion and indignation. Whatever subject he treats of, that he sedulously pursues, from that he rarely departs, but feverishly wades to it; whence the connection is in general evident and well preserved. In many respects he is perhaps excelled by the other prophets; but in that species of composition to which he seems by nature adapted, the forcible, the impetuous, the great and solemn, not one of the sacred writers is superior to him. His diction is sufficiently picturesque; all his obscurity consists in the nature of the subject. Visions (as far instance, among others, those of Hosea, Amos, and Jeremiah) are necessarily dark and enigmatical. The greater part of Ezekiel, towards the middle of the book especially, is poetical, whether we regard the matter or the diction. His periods, however, are frequently too rude and incognate, that I am often at a loss how to pronounce concerning his performance in this respect.

If I wish, Jeremiah, and Ezekiel, as far as relate to style, may be said to hold the same rank among the Hebrews, as Homer, Simonides, and Alchylus among the Greeks.⁶¹

So full an account of Daniel and his writings has been made, only under the article Darius, that little remains to be said on that subject. Daniel flourished during the successive reigns of several Babylonian and Median kings, in the east part of Babylon by Cyrus. The events recorded in the six chapters are connected with Darius the Median, but in the seventh and eighth chapters Daniel returns to a captivity, to relate the visions which he beheld in the three last years of Belshazzar's reign; and these which fall within the last chapters were revealed to him by the reign of Darius. The last six chapters are composed of prophecies delivered at different times; all of which are in some sense connected as parts of one great scheme. They extend through many ages, and furnish the most striking description of the fall of successive kingdoms, which were to be introductory to the establishment of the Messiah's reign. They characterize in descriptive terms the four great monarchies of the world to be succeeded by "the kingdom which should not be destroyed."

The whole book of Daniel being no more than a plain relation of facts, partly real and partly future, must be excluded the class of poetical prophecy. Much indeed of the parabolic imagery is introduced in that book; but the author introduces it as a prophet only; as visionary and allegorical symbols of objects and events, totally unconnected with the true poetical coloring. The Jews, indeed, would refer to Daniel even the character of a prophet; but the arguments under which they shelter this opinion are very futile; for those points which they maintain concerning the conditions on which the gift of prophecy is imparted, the different gradations, and the discrimination between the true prophecy and mere inspiration, are trifling and absurd, without any foundation in the nature of things, and totally delicate of scriptural authority. They add, that Daniel was neither originally educated in the prophetic discipline and precepts, nor afterwards lived conformably to the manner of the prophets. It is not, however, easy to comprehend how this can diminish his claim to a divine mission and inspiration; it may possibly enable us, indeed, to assign a reason for the dissimilarity between the style of Daniel and that of the other prophets, and for its possessing so little of the dignity and character of poetry, which the rest seem to have imbibed in common from the schools and discipline in which they were educated.

The prophecies of Daniel appear so plain and intelligible after their accomplishment, that Porphyry, who wrote in the 3d century, says, that they were written after the events to which they refer took place. A little reflection will show the absurdity of this supposition. Some of the prophecies of Daniel clearly refer to Antiochus Epiphanes, with whose reigns the Jews were too well acquainted. Had the book of Daniel not made its appearance till after the death of Epiphanes, every Jew who read it must have discovered the imagery. As it is not to be supposed that he received it among the Gentiles, it is impossible to conceive how he had it so long in his hands, the Jews being so well acquainted with the contents of it, that they regarded it as a book which had been written by one of their own prophets. But we need not descend into this important part from the general account we have to give; we can be satisfied, however, to conclude that the book of Daniel is a prophetic production of them, and has been accom-

plished since the time of Porphyry; particularly those respecting Antiochus; now, if it contains any prophecies, who will take upon him to affirm that the divine Spirit, which inspired these many centuries before they were fulfilled, could not also have delivered prophecies concerning Antiochus Epiphanes?

The language in which the book of Daniel is composed proves that it was written about the time of the Babylonian captivity. Part of it is in pure Hebrew; a language in which none of the Jewish books were composed after the age of Epiphanes. There are arguments to a deal. To a Christian the internal marks of the book itself will show the time in which it was written, and the testimony of Ezekiel will prove Daniel to be at least his contemporary.

The twelve minor prophets were so called, not from any supposed inferiority in their writings, but on account of the small size of their works. Perhaps it was for this reason that the Jews joined them together, and considered them as one volume. These 12 prophets presented to the Jewish mind a lively sketch of many particulars relative to the history of Judah and of Israel, as well as of other kingdoms; they prophesy with historical exactness the fate of Babylon, of Nineveh, of Tyre, of Sidon, and of Damascus. The three last prophets effectually illustrate every circumstance at a period when the historical pages of scripture are closed, and when profane writers are entirely wanting. At first the Jewish prophets appeared only as single lights, and shined each other in individual succession; but they became more numerous about the time of the captivity. The light of inspiration was collected into one blaze, presented to its suspension; and it served to keep alive the expectations of the Jews during the awful interval which preceded the expiration of prophecy and its grand completion on the advent of Christ.

Hosea has been supposed the most ancient of the 12 minor prophets. He flourished in the reign of Jeroboam II, king of Israel, and during the successive reigns of Uzziah, Jotham, Ahaz, and Hezekiah, Kings of Judah. He was therefore nearly contemporary with Isaiah, Amos, and Jonah. The prophecies of Hosea being scattered through the books without date or connection, cannot with any certainty be chronologically arranged.

Hosea is the first in order of the minor prophets, and is, perhaps, Jonah excepted, the most ancient of them all. His style exhibits the appearance of very ancient antiquity; it is pointed, energetic, and concise. It bears a distinguished mark of poetical composition, in that plain brevity and condensation which is observable in the Hebrews, and which later writers have in some measure neglected. This peculiarity has not escaped the observation of Jeremiah: "He is altogether (Gen. 10, speaking of this prophet) laconic and laconical." But this very circumstance, which eminently was adapted to impart uncommon force and elegance, in the most rigorous state of the Hebrew literature is productive of so much obscurity, that although the general subject of this writer be sufficiently obvious, his style is the most difficult and perplexed of all the rest. There is, however, another reason for the obscurity of his style; Hosea prophesied during the reigns of the four Kings of Judah, Uzziah, Jotham, Ahaz, and Hezekiah. The duration of his ministry, therefore, in what

Scripture

ever manner we calculate, must include a very considerable space of time. We have now only a small volume of his remaining, which seems to contain his principal prophecies; and these are extant in a continued series, with no marks of distinction as to the times in which they were published, or the subjects of which they treat. There is, therefore, no cause to wonder if, in perusing the prophecies of Hosea, we sometimes find ourselves in a singular predicament with those who consulted the scattered leaves of the Sibyl.

As a specimen of Hosea's style, we select the following beautiful pathetic passage:

How shall I resign thee, O Ephraim!
How shall I deliver thee up, O Israel!
How shall I resign thee as Admah!
How shall I make thee as Zeboim!
My heart is changed within me;
I am warmed also with repentance towards thee.
I will not do according to the fervour of my wrath;
I will not return to destroy Ephraim:
For I am God, and not man;
Holy in the midst of thee, though I inhabit not thy cities.

63
Prophecies
of Joel.

Concerning the date of the prophecy of Joel there are various conjectures. The book itself affords nothing by which we can discover when the author lived, or upon what occasion it was written. Joel speaks of a great famine, and of mischiefs that happened in consequence of an inundation of locusts; but nothing can be gathered from such general observations to enable us to fix the period of his prophecy. St Jerome thinks (and it is the general opinion) that Joel was contemporary with Hosea. This is possibly true; but the foundation on which the opinion rests is very precarious, viz. That when there is no proof of the time in which a prophet lived, we are to be guided in our conjectures respecting it by that of the preceding prophet whose epoch is better known. As this rule is not infallible, it therefore ought not to hinder us from adopting any other opinion that comes recommended by good reasons. Father Calmet places him under the reign of Josiah, at the same time with Jeremiah, and thinks it probable that the famine to which Joel alludes, is the same with that which Jeremiah predicted, ch. viii. 13.

69
Character
of their
style.

The style of Joel is essentially different from that of Hosea; but the general character of his diction, though of a different kind, is not less poetical. He is elegant, perspicuous, copious, and fluent; he is also sublime, animated, and energetic. In the first and second chapters he displays the full force of the prophetic poetry, and shows how naturally it inclines to the use of metaphors, allegories, and comparisons. Nor is the connection of the matter less clear and evident than the complexion of the style: this is exemplified in the display of the impending evils which gave rise to the prophecy, the exhortation to repentance; the promises of happiness and success both terrestrial and eternal to those who become truly penitent; the restoration of the Israelites; and the vengeance to be taken of their adversaries. But while we allow this just commendation to his perspicuity both in language and arrangement, we must not deny that there is sometimes great obscurity observable in his subject, and particularly in the latter part of the prophecy.

Lectures
on Hebrew
Poetry,
book 21.

The following prophecy of a plague of locusts is described with great sublimity of expression: Scripture.

For a nation hath gone up on my land,
Who are strong, and without number:
They have destroyed my vine, and have made my fig-tree a broken branch.
They have made it quite bare, and cast it away: the branches thereof are made white.
The field is laid waste; the ground mourneth.*

* Joel i. 6.
7, 10, Sec.
70
Prophecies
of Amos.

Amos was contemporary with Hosea. They both began to prophesy during the reigns of Uzziah over Judah, and of Jeroboam II. over Israel. Amos saw his first vision two years before the earthquake, which Zechariah informs us happened in the days of Uzziah. See AMOS.

Amos was a herdman of Tekoa, a small town in the territory of Judah, and a gatherer of sycamore fruit. In the simplicity of former times, and in the happy climates of the East, they were not considered as dishonourable occupations. He was no prophet (as he is informed Amaziah †), neither was he a prophet's son; † Amos vii. 14. that is, he had no regular education in the schools of the prophets.

The prophecies of Amos consist of several distinct discourses, which chiefly respect the kingdom of Israel; yet sometimes the prophet inveighs against Judah, and threatens the adjacent nations, the Syrians, Philistines, Tyrians, Edomites, Ammonites, and Moabites.

Jerome calls Amos "rude in speech, but not in knowledge †;" applying to him what St Paul modestly professes of himself ‡. "Many (says Dr Lowth) have followed the authority of Jerome in speaking of this prophet, as if he were indeed quite rude, ineloquent, and destitute of all the embellishments of composition. The matter is, however, far otherwise. Let any person who has candour and perspicacity enough to judge, not from the man but from his writings, open the volume of his predictions, and he will, I think, agree with me, that our shepherd 'is not a whit behind the very chief of the prophets.' He will agree, that as in sublimity and magnificence he is almost equal to the greatest, so in splendour of diction and elegance of expression he is scarcely inferior to any. The same celestial Spirit indeed actuated Isaiah and Daniel in the court and Amos in the sheep-folds; constantly selecting such interpreters of the divine will as were best adapted to the occasion, and sometimes 'from the mouth of babes and sucklings perfecting praise:' occasionally employing the natural eloquence of some, and occasionally making others eloquent."

† The-ir style.
‡ 1 Cor. xi.
§ 2 Cor. xi.
6.
2 Cor. x.

Mr Locke has observed, that the comparisons of this prophet are chiefly drawn from lions and other animals with which he was most accustomed; but the finest images and allusions are drawn from scenes of nature. There are many beautiful passages in the writings of Amos, of which we shall present one specimen:

Wo to them that are at ease in Zion,
And trust in the mountains of Samaria;
Who are named chief of the nations,
To whom the house of Israel came:
Pals ye unto Calneh and see,
And from thence go to Hamath the Great;

Then

Scriptures. Then go down to Gath of the Philistines;
Are they better than these kingdoms?
Or their borders greater than their borders?
Ye that put far away the evil day,
And cause the feat of violence to come near;
That lie upon beds of ivory,
And stretch yourselves upon couches;
That eat the lambs out of the flock,
And the calves out of the midst of the stall;
That chant to the sound of the viol,
And like David devise instruments of music;
That drink wine in bowls,
And anoint yourselves with chief ointments;
Ch. vi. 1.
— 72.
But are not grieved for the affliction of *Jeh. ph. ||*.

Of Obadiah. The writings of Obadiah, which consist of one chapter, are composed with much beauty, and unfold a very interesting scene of prophecy. Of this prophet little can be said, as the specimen of his genius is so short, and the greater part of it included in one of the prophecies of Jeremiah. Compare Ob. 1—9. with Jer. xlix. 12, 13, 16. See *OSADIAH*.

Of Jonah. Though *JONAH* be placed the sixth in the order of the minor prophets both in the Hebrew and Septuagint, he is generally considered as the most ancient of all the prophets, not excepting *Hosea*. He lived in the kingdom of Israel, and prophesied to the ten tribes under the reign of *Joah* and *Jeroboam*. The book of *JONAH* is chiefly historical, and contains nothing of poetry but the prayer of the prophet. The sacred writers, and our Lord himself, speak of *JONAH* as a prophet of considerable eminence*. See *JONAH*.

* 2 Kings xiv. 25.
Matth. xiii. 39. 41. xlv. 4.
Luke xi. 29.
— 74.
Of *Micah*.
† Jer. xxv. 15—14.
‡ *Jes. Ant.* lib. x. c. 7.
Micah iii. 12.
§ *Matt. ii.* 5. *John vi.* 45.
His style.

The style of *Micah* is for the most part close, forcible, pointed, and concise; sometimes approaching the obscurity of *Hosea*; in many parts animated and sublime; and in general truly poetical. In his prophecies there is an elegant poem, which Dr. Lowth thinks is a citation from the answer of *Balaam* to the king of the *Moabites*:

Wherewith shall I come before Jehovah?
Wherewith shall I bow myself unto the High God?
Shall I come before him with burnt-offerings,
With calves of a year old?
Will Jehovah be pleased with thousands of rams?
With ten thousands of rivers of oil?

Scriptures. Shall I give my first-born for my transgression?
The fruit of my body for the sin of my soul?
He hath showed thee, O man, what is good:
And what doth Jehovah require of thee,
But to do justice, and to love mercy,
And to be humble in walking with thy God?

Josephus asserts, that *Nahum* lived in the time of *Jo-* ⁷⁶ *Nahum*
tham king of *Judah*; in which case he may be supposed to have prophesied against *Nineveh* when *Tiglath-Pileser* king of *Assyria* carried captive the natives of *Galilee* and other parts about A. M. 3264. It is, however, probable, that his prophecies were delivered in the reign of *Hezekiah*; for he appears to speak of the taking of *No-Ammon* a city of *Egypt*, and of the insolent messengers of *Sennacherib*, as of things past; and he likewise describes the people of *Judah* as still in their own country, and desirous of celebrating their festivals.

While *Jerusalem* was threatened by *Sennacherib*, *Nahum* promised deliverance to *Hezekiah*, and predicted that *Judah* would long celebrate her solemn feasts secure from invasion, as her enemy would no more disturb her peace. In the second and third chapters *Nahum* foretells the downfall of the *Assyrian* empire and the final destruction of *Nineveh*, which was probably accomplished by the *Medes* and *Babylonians*, who's combined forces overpowered the *Assyrians* by surprise "while they were folded together as thorns, and while they were drunken as drunkards," when the gates of the river were opened, the palace demolished, and an "over-running flood" assailed the conquerors in their devastation; who took an endless store of spoil of gold and silver, making an utter end of the place of *Nineveh*, of that vast and populous city, whose walls were 100 feet high, and so broad that three chariots could pass abreast. Yet so completely was this celebrated city destroyed, that even in the 21 century the spot on which it stood could not be ascertained, every vestige of it being gone.

It is impossible to read of the exact accomplishment of the prophetic denunciations against the enemies of the Jews, without reflecting on the astonishing proofs which that nation enjoyed of the divine origin of their religion. From the *Babylonish* captivity to the time of *Christ* they had numberless instances of the fulfilment of their prophecies.

The character of *Nahum* as a writer is thus described by Dr. Lowth: "None of the minor prophets seem to equal *Nahum* in boldness, ardour, and sublimity. His prophecy, too, forms a regular and perfect poem; the exordium is not merely magnificent, it is truly majestic; the preparation for the destruction of *Nineveh*, and the description of its downfall and desolation, are expressed in the most vivid colours, and are bold and luminous in the highest degree."

As the prophet *Habakkuk* makes no mention of the ⁷⁷ *Of Habak.*
Assyrians, and speaks of the *Chaldean* invasions as near at hand, he probably lived after the destruction of the *Assyrian*

(S) Compare *Zeph. iii. 19.* with *Micah. iv. 7.* and *Ezek. xxii. 27.* with *Micah. iii. 11.*

(O) Compare *Mic. h. iv. 1—3.* and *Isaiah. ii. 2—4.* *Micah. iv. 13.* with *Isaiah. xli. 15.*

(P) Compare *Micah. viii. 6.* with *Matt. x. 35.* 36.

Assyrian empire in the fall of Nineveh A. M. 3302, and not long before the devastation of Isdrel by Nebuchadnezzar. Habbakuk was then nearly contemporary with Jeremiah, and predicted the same events. A general account of Habbakuk's prophecies has already been given under the word Habbakuk, which may be consulted. We should, however, farther observe, that the prayer in the third chapter is a most beautiful and perfect ode, possessing all the fire of poetry and the profound reverence of religion.

God came from Teman,
And the Holy One from Mount Paran.
His glory covered the heavens,
And the earth was full of his praise.
His brightness was as the light;
Beams of glory issued from his side;
And there was the hiding of his power.
Before him went the pestilence;
And burning coals went forth at his feet.
He stood and measured the earth;
He beheld and drove asunder the nations;
The everlasting mountains were scattered;
The perpetual hills did bow.

The prophet illustrates this subject throughout with equal sublimity; selecting from such an assemblage of miraculous incidents the most noble and important, displaying them in the most splendid colours, and embellishing them with the sublimest imagery, figures, and diction; the dignity of which is heightened and recommended by the superior elegance of the conclusion, that were it not for a few verses which the hand of time has apparently cut over it in two or three passages, no composition of the kind would appear more elegant or more perfect than this poem.

Habbakuk is imitated by succeeding prophets, and his words are borrowed by the evangelical writers [].

Zephaniah, who was contemporary with Jeremiah, prophesied in the reign of Josiah king of Judah; and from the history which he describes as prevailing at that time, it is probable that his prophecies were delivered before the last reformation made by that pious prince A. M. 3381.

The account which Zephaniah and Jeremiah give of the idolatries of their age is so similar, that St. Jerome asserts, that Zephaniah abridged the descriptions of Jeremiah. But it is more probable that the prophecies of Zephaniah were written some years before those of his contemporary; for Jeremiah seems to represent the abuses as partly removed which Zephaniah describes as rampant and excessive [].

In the first chapter Zephaniah denounces the wrath of God against the idolaters who worshipped Baal and the host of heaven, and against the violent and deceitful. In the second chapter the prophet denounces destruction to the Philistines, the Moabites, the Ammonites, and Edomites; and describes the fate of Nineveh in emphatic terms: "Flunks shall be down in the midst of her; all the heels of the nations, both the cornucopia and liberum, shall lodge in her; their voice shall ring in the windows; desolation shall be in the thresh-

old." In the third chapter the prophet inveighs against the pollutions and oppressions of the Jews; and concludes with the promise, "That a remnant would be saved, and that multiplied blessings would be bestowed upon the penitent." The style of Zephaniah is poetical, but is not distinguished by any peculiar elegance or beauty, though generally animated and impressive.

Haggai, the tenth of the minor prophets, was the first who flourished among the Jews after the Babylonian captivity. He began to prophesy in the second year of Darius Hystaspes, about 520 years before Christ.

The intention of the prophecy of Haggai was to encourage the dispersed Jews to proceed with the building of the temple. The only prediction mentioned refers to the Messiah, whom the prophet assures his countrymen would fill the new temple with glory. So well was this prediction understood by the Jews, that they looked with earnest expectation for the Messiah's appearing in this temple till it was destroyed by the Romans. But as the victorious Messiah, whom they expected, did not then appear, they have since applied the prophecy to a third temple, which they hope to see raised in some future period.

The style of Haggai, in the opinion of Dr. Lowth, is prosaic. Dr. Noyce, on the contrary, thinks that a great part of it is poetical.

Zachariah was undoubtedly a contemporary of Haggai, and began to prophesy two months after him, in the eighth month of the second year of Darius Hystaspes, A. M. 3481, being commissioned as well as Haggai to exhort the Jews to proceed in the building of the temple after the interruption which the work had suffered. We are informed by Ezra (vi. 14.), that the Jews progressed through the prophesying of Zachariah and Haggai.

Zachariah begins with general exhortations to his countrymen, exciting them to repent from the evil ways of their fathers, whom the prophets had admonished in vain. He describes angels of the Lord interceding for mercy on Jerusalem and the desolate cities of Judah, which had experienced the indignation of the Most High for 70 years, while the neighbouring nations were at peace. He declares, that the house of the Lord should be built in Jerusalem, and that Zion should be comforted. The prophet then represents the increase and prosperity of the Jews under several typical figures. He describes the establishment of the Jewish government and the coming of the Messiah. He admonishes those who cherished solemn fasts without due contrition, to exercise justice, mercy, and compassion, every man to his brother; not to oppress the widow nor the orphan, the stranger nor the poor. He promises, that God would again show favour to Jerusalem; that their mournful fasts should be turned into cheerful feasts; and that the church of the Lord should be enlarged by the conversion of many nations.

The 12th verse of the 11th chapter of this book, which exhibits a prophetic description of some circumstances afterwards fulfilled in our Saviour, appears to

See also be cited by St Matthew (xxvii. 9, 10.) as spoken by Jeremiah; and as the 11th, 12th, and 13th chapters have been thought to contain some particulars more suitable to the age of Jeremiah than to that of Zechariah, some learned writers are of opinion that they were written by the former prophet, and have been from similarity of subject joined by mistake to those of Zechariah. But others are of opinion, that St Matthew might allude to some traditional prophecy of Jeremiah, or, what is more probable, that the name of Jeremiah was substituted by mistake in place of Zechariah.

The 12th, 13th, and 14th chapters contain prophecies which refer entirely to the Christian dispensation; the circumstances attending which be determined with a clearness which indicated their near approach.

The style of Zechariah is so similar to that of Jeremiah, that the Jews were accustomed to remark that the spirit of Jeremiah had passed into him. He is generally profane, till towards the conclusion of his work, when he becomes more elevated and poetical. The whole is beautifully connected by easy transitions, and present and future scenes are blended with the greatest delicacy.

⁵¹ Malachi. Malachi was the last prophet that flourished under the Jewish dispensation; but neither the time in which he lived, nor any particulars of his history, can now be ascertained. It is even uncertain whether the word *Malachi* be a proper name, or denote, as the Septuagint have rendered it, *his angel* (R), i. e. "the angel of the Lord." Origen supposed, that Malachi was an angel incarnate, and not a man. The ancient Hebrews, the Chaldees, paraphrasts, and St Jerome, are of opinion he was the same person with Ezra; but if this was the case, they ought to have assigned some reason for giving two different names to the same person.

As it appears from the concurring testimony of all the ancient Jewish and Christian writers, that the light of prophecy expired in Malachi, we may suppose that the termination of his ministry coincided with the accomplishment of the first seven weeks of Daniel's prophecy, which was the period appointed for sealing the vision and prophecy. This, according to Pridmore's account, took place in A. M. 3603; but, according to the calculations of Biberus, to A. M. 3607, twelve years later. Whatever reasoning we prefer, it may be allowed that Malachi completed the canon of the Old Testament about 450 years before the birth of Christ.

It appears certain that Malachi prophesied under Nebuchadnezzar, and after Haggai and Zechariah, at a time when great disorders reigned among the priests and people of Israel, which are reproved by Malachi. He inveighs against the priests (i. 6. Sec. ii. 1, 2, &c.); he reproaches the people with having taken strange wives (ii. 11.); he reproves them for their inhumanity towards their brethren (ii. 17. iii. 4.); their too frequent divorcing their wives; their neglect of paying their tithes and first-fruits (Mal. iii. 8, 9.). He seems to allude to the covenant that Nebuchadnezzar made with the Lord (iii. 10.) and (ii. 2, 3, Sec.). It is the chief of the prophets of the new law, and of the sacrifice

of the new law, and of the abolition of those of the old, ⁵² *5 Eptis* in these words (i. 10, 11, 12, 13.): "I have no pleasure in you, faith the Lord of hosts, neither will I accept an offering at your hand. For from the rising of the sun, even unto the going down of the same, my name shall be great among the Gentiles, and in every place incense shall be offered unto my name, and a pure offering: for my name shall be great among the Heathen, faith the Lord of Hosts." He declares that the Lord was weary with the impiety of Israel; and assures them, that the Lord whom they sought should suddenly come to his temple preceded by the messenger of the covenant, who was to prepare his way; that the Lord when he appeared should purify the sons of Levi from their unrighteousness, and refine them as metal from the dross; and that then the offering of Judah, the spiritual sacrifice of the heart, should be pleasant to the Lord. The prophet, like one who was delivering a last message, denounces denunciation against the impenitent in emphatic and alarming words. He encourages those who feared the name of the Lord with the animating promise, that the "Sun of righteousness should arise with salvation in his rays," and render them triumphant over the wicked. And now that prophecy was to cease, and miracles were no more to be performed till the coming of the Messiah; now that the Jews were to be left to the guidance of their own reason, and the written instructions of their prophets—Malachi exhorts them to remember the law of Moses, which the Lord had revealed from Horeb for the sake of all Israel. At length, he seals up the prophecies of the Old Testament, by predicting the commencement of the new dispensation, which should be ushered in by John the Baptist with the power and spirit of Elijah; who should turn the hearts of fathers and children to repentance; but if his admonitions should be rejected, that the Lord would smite the land with a curse.

⁵³ THE collection of writings composed after the ascension of Christ, and acknowledged by his followers to be divine, is known in general by the name of *Novæ Testamenti*. This title, though neither given by divine command, nor applied to these writings by the apostles, was adopted in a very early age, though the precise time of its introduction is uncertain, it being justified by several passages in Scripture, and warranted by the authority of St. Paul in particular, who calls the sacred books before the face of Christ *παλαιὰ διαθήκη* 1. Even long before this period, either the whole of the Old Testament, or the five books of Moses, were entitled *βιβλος διαθήκης*, or book of the covenant §.

As the word *διαθήκη* admits of a two-fold interpretation, we may translate this title either the *New Covenant* or *New Testament*. The former translation must be adopted, if respect be had to the texts of Scripture, from which the name is borrowed, since those passages evidently convey the idea of a covenant; and, besides, a being incapable of death can neither have made an old nor make a new testament. It is likewise probable, that the earliest Greek scribes, who made use of this expression, had no other notion in view than that of covenant

Scriptures.

venant. We, on the contrary, are accustomed to give this sacred collection the name of *Testament*; and since it would be not only improper, but even absurd, to speak of the Testament of God, we commonly understand the Testament of Christ; an explanation which removes but half the difficulty, since the new only, and not the old, had Christ for its testator.

84
Importance
of the argu-
ment in
the authen-
ticity of the
books.

In flating the evidence for the truth of Christianity, there is nothing more worthy of consideration than the authenticity of the books of the New Testament. This is the foundation on which all other arguments rest; and if it is solid, the Christian religion is fully established. The proofs for the authenticity of the New Testament have this peculiar advantage, that they are plain and simple, and involve no metaphysical subtleties.—Every man who can distinguish truth from falshood must see their force; and if there are any to be blinded by prejudice, or corrupted by licentiousness, as to attempt by sophistry to elude them, their sophistry will be easily detected by every man of common understanding, who has read the historical evidence with candour and attention. Instead, therefore, of declaiming against the infidel, we solicit his attention to this subject, convinced, that where truth resides, it will shine with so constant and clear a light, that the combined ingenuity of all the devils since the beginning of the world will never be able to extinguish or to obscure it. If the books of the New Testament are really genuine, opposition will incite the Christian to bring forward the evidence; and thus by the united efforts of the deist and the Christian, the arguments will be stated with all the clearness and accuracy of which they are susceptible in so remarkable a degree.

It is surprising that the adversaries of Christianity have not always made their first attacks in this quarter; for if they admit that the writings of the New Testament are as ancient as we affirm, and composed by the persons to whom they are ascribed, they must allow, if they reason fairly, that the Christian religion is true.

The apostles frequently allude in their epistles to the gift of miracles, which they had communicated to the Christian converts by the imposition of hands, in confirmation of the doctrine delivered in their speeches and writing, and sometimes to miracles which they themselves had performed. Now if these epistles are really genuine, it is hardly possible to deny those miracles to be true. The case is here entirely different from that of an historian, who relates extraordinary events in the course of his narrative, since either credulity or an actual intention to deceive may induce him to describe as true a series of falsehoods respecting a foreign land or distant period. Even to the Evangelists might an adversary of the Christian religion make this objection: but to write to persons with whom we stand in the nearest connection, "I have not only performed miracles in your presence, but have likewise communicated to you the same extraordinary endowments," to write in this manner, if nothing of the kind had ever happened, would require such an incredible degree of effrontery, that he who possessed it would not only expose himself to the utmost ridicule, but by giving his adversaries the fairest opportunity to detect his imposture, would ruin the cause which he attempted to sup-

Michael's
Introduction to the
New Testam-
ent.

St Paul's First Epistle to the Thessalonians is addressed to a community to which he had preached the gospel only three Sabbath days, when he was forced to quit it by the persecution of the populace. In this epistle he appeals to the miracles which he had performed, and to the gifts of the Holy Spirit which he had communicated. Now, is it possible, without forfeiting all pretensions to common sense, that, in writing to a community which he had lately established, he could speak of miracles performed, and gifts of the Holy Ghost communicated, if no member of the society had seen the one, or received the other?

To suppose that an impostor could write to the converts or adversaries of the new religion such epistles as these, with a degree of triumph over his opponents, and yet maintain his authority, implies ignorance and stupidity hardly to be believed. Credulous as the Christians have been in later ages, and even so early as the third century, no less severe were they in their inquiries, and guarded against deception, at the introduction of Christianity. This character is given them even by Lucian, a writer of the second century, who vented his satire not only against certain Christians, who had supplied Peregrinus with the means of subsistence, but also against heathen oracles and pretended wonders. He relates of his impostor (Pseudomantis), that he attempted nothing supernatural in the presence of the Christians and Epicureans. This Pseudomantis exclaims before the whole assembly, "Away with the Christians, away with the Epicureans, and let those only remain who believe in the Deity!" (*πιστωτικῶν τῶν Θεῶν*) on which the populace took up stones to drive away the suspicious; while the other philosophers, Pythagoreans, Platonists, and Stoics, as credulous friends and protectors of the cause, were permitted to remain.

It is readily acknowledged, that the arguments drawn from the authenticity of the New Testament only establish the truth of the miracles performed by the apostles, and are not applicable to the miracles of our Saviour; yet, if we admit the first three gospels to be genuine, the truth of the Christian religion will be proved from the prophecies of Jesus. For if these gospels were composed by Matthew, Mark, and Luke, at the time in which all the primitive Christians affirm, that is, previous to the destruction of Jerusalem, they must be inspired; for they contain a circumstantial prophecy of the destruction of Jerusalem, and determine the period at which it was accomplished. Now it was impossible that human sagacity could foresee that event; for when it was predicted nothing was more improbable. The Jews were resolved to avoid an open rebellion, well knowing the greatness of their danger, and submitted to the oppressions of their governors in the hope of obtaining redress from the court of Rome.—The circumstance which gave birth to these misfortunes is so trifling in itself, that independent of its consequences, it would not deserve to be recorded. In the narrow entrance to a synagogue in Casarea, some person had made an offering of birds merely with a view to irritate the Jews. The insult excited their indignation, and occasioned the shedding of blood. Without this trifling accident, which no human wisdom could foresee even the day before it happened, it is possible that the prophecy of Jesus would never have been

Scriptures.

* De morte
Peregrini,
p. 12, 13, 16.
Ed. Reitz.
tom. iii.
p. 334—
338, 347.

† Alexan-
der seu
Pseudo-
mantis,
p. 25, 32,
tom. ii.
p. 232, 233,
244, 245.

Scripture. fulfilled. But Florus, who was then procurator of Judea, converted this private quarrel into public hostilities, and compelled the Jewish nation to rebel contrary to its wish and resolution, in order to avoid what the Jews had threatened, an impeachment before the Roman emperor for his excessive cruelties. But even after this rebellion had broken out, the destruction of the temple was a very improbable event. It was not the practice of the Romans to destroy the magnificent edifices of the nations which they subdued; and of all the Roman generals, none was more unlikely to demolish so ancient and august a building as Titus Vespasian.

So important then is the question, Whether the books of the New Testament be genuine? that the arguments which prove their authenticity, prove also the truth of the Christian religion. Let us now consider the evidence which proves the authenticity of the New Testament.

⁸⁵ Their authenticity proved. We receive the books of the New Testament as the genuine works of Matthew, Mark, Luke, John, and Paul, for the same reason that we receive the writings of Xenophon, of Polybius, of Plutarch, of Cæsar, and of Livy. We have the uninterrupted testimony of all ages, and we have no reason to suspect imposition. This argument is much stronger when applied to the books of the New Testament than when applied to any other writings; for they were addressed to large societies, were often read in their presence, and acknowledged by them to be the writings of the apostles.— Whereas, the most eminent profane writings which still remain were addressed only to individuals, or to no persons at all: and we have no authority to affirm that they were read in public; on the contrary, we know that a liberal education was uncommon; books were scarce, and the knowledge of them was confined to a few individuals in every nation.

The New Testament was read over three quarters of the world, while profane writers were limited to one nation or to one country. An uninterrupted succession of writers from the apostolic ages to the present time quote the sacred writings, or make allusions to them: and these quotations and allusions are made not only by friends but by enemies. This cannot be asserted of even the best classic authors. And it is highly probable, that the translations of the New Testament were made so early as the second century; and in a century or two after, they became very numerous. After this period, it was impossible to forge new writings, or to corrupt the sacred text, unless we can suppose that men of different nations, of different sentiments and different languages, and often exceedingly hostile to one another, should all agree in one forgery. This argument is so strong, that if we deny the authenticity of the New Testament, we may with a thousand times more propriety reject all the other writings in the world: we may even throw aside human testimony itself. But as this subject is of great importance, we shall consider it at more length; and to enable our readers to judge with the greater accuracy, we shall state, from the valuable work of Michaelis, as translated by the judicious and learned Mr Marsh, the reasons which may induce a critic to suspect a work to be spurious.

⁸⁶ Negatively. 1. When doubts have been made from its first appearance in the world, whether it proceeded from the author. VOL. XIX. Part I.

thor to whom it is ascribed. 2. When the immediate friends of the pretended author, who were able to decide upon the subject, have denied it to be his production. 3. When a long series of years has elapsed after his death, in which the book was unknown, and in which it must unavoidably have been mentioned and quoted, had it really existed. 4. When the style is different from that of his other writings, or, in case no other remain, different from that which might reasonably be expected. 5. When events are recorded which happened later than the time of the pretended author. 6. When opinions are advanced which contradict those he is known to maintain in his other writings. Though this latter argument alone leads to no positive conclusion, since every man is liable to change his opinion, or through forgetfulness to vary in the circumstances of the same relation, of which Josephus, in his Antiquities and War of the Jews, affords a striking example.

1. But it cannot be shown that any one doubted of its authenticity in the period in which it first appeared. 2. No ancient accounts are on record whence we may conclude it to be spurious. 3. No considerable period elapsed after the death of the apostles, in which the New Testament was unknown; but, on the contrary, it is mentioned by their very contemporaries, and the accounts of it in the second century are still more numerous. 4. No argument can be brought in its disfavour from the nature of the style, it being exactly such as might be expected from the apostles, not Attic but Jewish Greek. 5. No facts are recorded which happened after their death. 6. No doctrines are maintained which contradict the known tenets of the authors, since, beside the New Testament, no writings of the apostles exist. But, to the honour of the New Testament be it spoken, it contains numerous contradictions to the tenets and doctrines of the fathers in the second and third century, whose morality was different from that of the gospel, which recommends fortitude and submission to unavoidable evils, but not that enthusiastic ardour for martyrdom for which those centuries are distinguished; it alludes to ceremonies which in the following ages were either in disuse or totally unknown: all which circumstances infallibly demonstrate that the New Testament is not a production of either of those centuries.

We shall now consider the positive evidence for the authenticity of the New Testament. These may be arranged under the three following heads:

1. The impossibility of a forgery, arising from the nature of the thing itself. 2. The ancient Christian, Jewish, and Heathen testimony in its favour. 3. Its own internal evidence.

⁸⁹ Impossibility of a forgery arising from the nature of the thing. 1. The impossibility of a forgery arising from the nature of the thing itself is evident. It is impossible to establish forged writings as authentic in any place where there are persons strongly inclined and well qualified to detect the fraud. Now the Jews were the most violent enemies of Christianity. They put the founder of it to death; they persecuted his disciples with implacable fury; and they were anxious to stifle the new religion in its birth. If the writings of the New Testament had been forged, would not the Jews have detected the impotence? Is there a single instance on record where a few individuals have imposed a history upon the world

Scripture. against the testimony of a whole nation? Would the inhabitants of Palestine have received the gospels, if they had not had sufficient evidence that Jesus Christ really appeared among them, and performed the miracles ascribed to him? Or would the churches of Rome or of Corinth have acknowledged the epistles addressed to them as the genuine works of Paul, if Paul had never preached among them? We might as well think to prove, that the history of the Reformation is the invention of historians; and that no revolution happened in Great Britain during the last century.

92 From testimony. 2. The second kind of evidence which we produce to prove the authenticity of the New Testament, is the testimony of ancient writers, Christians, Jews, and Heathens.

In reviewing the evidence of testimony, it will not be expected that we should begin at the present age, and trace backwards the authors who have written on this subject to the first ages of Christianity. This indeed, though a laborious task, could be performed in the most complete manner; the whole series of authors, numerous in every age, who have quoted from the books of the New Testament, written commentaries upon them, translated them into different languages, or who have drawn up a list of them, could be exhibited so as to form such a perfect body of evidence, that we imagine even a jury of devils would find it impossible, upon a deliberate and candid examination, to reject or disbelieve it. We do not, however, suppose that scientificia has yet arrived at so great a height as to render such a tedious and circumstantial evidence necessary. Passing over the intermediate space, therefore, we shall ascend at once to the fourth century, when the evidence for the authenticity of the New Testament was fully established, and trace it back from that period to the age of the apostles. We hope that this method of stating the evidence will

appear more natural, and will afford more satisfaction, than that which has been usually adopted.

It is farly more natural, when we investigate the truth of any fact which depends on a series of testimonies, to begin with those witnesses who lived nearest the present age, and whose characters are best established. In this way we shall learn from themselves the foundation of their belief, and the characters of those from whom they derived it; and thus we ascend till we arrive at its origin. This mode of investigation will give more satisfaction to the deist than the usual way; and we believe no Christian, who is confident of the godhead of his cause, will be unwilling to grant any proper concessions. The deist will thus have an opportunity of examining, separately, what he will consider as the weakest parts of the evidence, those which are exhibited by the earliest Christian writers, consisting of expressions, and not quotations, taken from the New Testament. The Christian, on the other hand, ought to wish, that these apparently weak parts of the evidence were distinctly examined, for they will afford an irrefragable proof that the New Testament was not forged; and should the deist reject the evidence of these early writers, it will be incumbent on him to account for the origin of the Christian religion, which he will find more difficult than to admit the common hypothesis.

In the fourth century we could produce the testimonies of numerous witnesses to prove that the books of the New Testament existed at that time; but it will be sufficient to mention their names, the time in which they wrote, and the substance of their evidence. This we shall present in a concise form in the following table, which is taken from Jones's New and Full Method of establishing the canon of the New Testament.

<i>The Names of the Writers.</i>	<i>Times in which they lived.</i>	<i>The variation or agreement of their catalogues with ours now received.</i>	<i>The books in which these catalogues are.</i>
I. Athanasius bishop of Alexandria.	A. C. 315.	The same perfectly with ours now received.	<i>Fragment. Epist. Tegal. tom. ii. in Synopf. tom. i.</i>
II. Cyril bishop of Jerusalem.	340.	The same with ours, only the Revelation is omitted.	<i>Catech. IV. § ult. p. 101.</i>
III. The bishops assembled in the council of Laodicea.	364.	The Revelation is omitted.	<i>Canon LIX.</i> N. B. The Canons of this council were not long afterwards received into the body of the canons of the universal church.
IV. Epiphanius bishop of Salamis in Cyprus.	370.	The same with ours now received.	<i>Heref. 76. cont. Anom. p. 399.</i>
V. Gregory Nazianzen bishop of Constantinople.	375.	is the Revelation.	<i>Carm. de veris et genuis. Scriptur.</i>

The Names of the Writers.	Times in which they lived.	The variation or agreement of their catalogues with ours now received.	The books in which these catalogues are.
VI. Philastrius bishop of Brescia in Venice.	382.	The same with ours now received; except that he mentions only 13 of St Paul's epistles (omitting very probably the Epistle to the Hebrews), and leaves out the Revelations.	<i>Lib. de Heres. Numb. 87.</i>
VII. Jerome.	382.	The same with ours; except that he speaks doubtfully of the Epistle to the Hebrews; though in other parts of his writings he receives it as canonical.	<i>Ep. ad Paulin. Tract. 6. p. 2. Alio commonly prefixed to the Latin vulgæ.</i>
VIII. Ruffin presbyter of Aquilegium.	392.	It perfectly agrees with ours.	<i>Expof. in Symb. Apostol. § 36. ut. Ep. Hieron. Par. 1. Tract. 3. p. 110. et inter Op. Cypr. p. 575.</i>
IX. Auslin bishop of Hippo in Africa.	394.	It perfectly agrees with ours.	<i>De Doctrin. Christ. lib. ii. c. 8. Tom. Op. 3. p. 25.</i>
X. The XLIV bishops assembled in the third council of Carthage.	St Auslin was present at it.	It perfectly agrees with ours.	<i>Vid. Canon XLVII. et cap. ult.</i>

We now go back to Eusebius, who wrote about the year 315, and whose catalogue of the books of the New Testament we shall mention at more length. "Let us observe (says he) the writings of the apostle John, which are *uncontradicted*; and, first of all, must be mentioned, as acknowledged of all, the gospel, according to him, well known to all the churches under heaven." The author then proceeds to relate the occasions of writing the gospels, and the reasons for placing St John's the last, manifestly speaking of all the four as equal in their authority, and in the certainty of their original. The second passage is taken from a chapter, the title of which is, "Of the Scriptures universally acknowledged, and of those that are not such." Eusebius begins his enumeration in the following manner: "In the first place, are to be ranked the sacred four Gospels, then the book of the Acts of the Apostles; after that are to be reckoned the epistles of Paul: in the next place, that called the first Epistle of John and the Epistle of Peter are to be esteemed authentic: after this is to be placed, if it be thought fit, the Revelation of John; about which we shall observe the different opinions at proper seasons. Of the controverted, but yet well known or approved by the most, are that called the Epistle of James and that of Jude, the second of Peter, and the second and third of John, whether they were written by the evangelist or by another of the same name." He then pro-

ceeds to reckon up five others, not in our canon, which he calls in one place *spurious*, in another *controverted*; evidently meaning the same thing by these two words (8).

A. D. 295, Victorin bishop of Pettau in Germany, in a commentary upon this text of the Revelation, "The first was like a lion, the second was like a calf, the third like a man, and the fourth like a flying eagle," makes out, that by the four creatures are intended the four gospels; and to show the propriety of the symbols, he recites the subject with which each evangelist opens his history. The explication is fanciful, but the testimony positive. He also expressly cites the Acts of the Apostles.

A. D. 230, Cyprian bishop of Carthage gives the following testimony: "The church (says this father) is watered like Paradise by four rivers, that is, by four gospels." The Acts of the Apostles are also frequently quoted by Cyprian under that name, and under the name of the *Divine Scriptures*. In his various writings are such frequent and copious citations of Scripture, as to place this part of the testimony beyond controversy. Nor is there, in the works of this eminent African bishop, one quotation of a spurious or apocryphal Christian writing.

A. D. 215, Origen is a most important evidence. Nothing can be more preterpitory upon the subject now

(8) That Eusebius could not intend, by the word rendered *spurious*, what we at present mean by it, is evident from a clause in this very chapter, where, speaking of the Gospels of Peter and Thomas, and Matthias and some others, he says, "They are not so much as to be reckoned among the *spurious*, but are to be rejected as altogether absurd and impious." *Lard. Cred. vol. viii. p. 93.*

Scripture. under consideration, and from a writer of his learning and information, nothing more satisfactory, than the declaration of Origen, preserved in an extract of his works by Eusebius: "That the four gospels alone are received without dispute by the whole church of God under heaven;" to which declaration is immediately subjoined a brief history of the respective authors, to whom they were then, as they are now, ascribed. The sentiments expressed concerning the gospels in all the works of Origen which remain, entirely correspond with the testimony here cited. His attestation to the Acts of the Apostles is no less positive: "And Luke also once more founds the trumpet relating the Acts of the Apostles." That the Scriptures were then universally read, is plainly affirmed by this writer in a passage in which he is repelling the objections of Celsus, "That it is not in private books, or such as are read by few only, and those studious persons, but in books read by every body, that it is written. The invisible things of God from the creation of the world are clearly seen, being understood by things that are made." It is to no purpose to single out quotations of Scripture from such a writer as this. We might as well make a selection of the quotations of Scripture in Dr Clarke's sermons. They are so thickly sown in the works of Origen, that Dr Mill says, "If we had all his works remaining, we should have before us almost the whole text of the Bible."

Of Tertullian.

A. D. 194, Tertullian exhibits the number of the gospels then received, the names of the evangelists, and their proper designations, in one short sentence.—"Among the apostles, John and Matthew teach us the faith; among apostolical men, Luke and Mark refresh it." The next passage to be taken from Tertullian affords as complete an attestation to the authenticity of the gospels as can be well imagined. After enumerating the churches which had been founded by Paul at Corinth, in Galatia, at Philippi, Thessalonica, and Ephesus, the church of Rome established by Peter and Paul, and other churches derived from John, he proceeds thus: "I say then, that with them, but not with them only which are apostolical, but with all who have fellowship with them in the same faith, is that gospel of Luke received from its first publication, which we so zealously maintain; and presently afterwards adds, "The same authority of the apostolical churches will support the other gospels, which we have from them, and according to them, I mean John's and Matthew's, although that likewise which Mark published may be said to be Peter's, whose interpreter Mark was." In another place Tertullian affirms, that the three other gospels, as well as St Luke's, were in the hands of the churches from the beginning. This noble testimony proves incontestably the antiquity of the gospels, and that they were universally received; that they were in the hands of all, and had been so from the first. And this evidence appears not more than 150 years after the publication of the books. Dr Lardner observes, "that there are more and larger quotations of the small volume of the New Testament in this one Christian author, than there are of all the works of Cicero, in writers of all characters, for several ages."

Of Irenæus.

A. D. 178, Irenæus was bishop of Lyons, and is mentioned by Tertullian, Eusebius, Jerome, and Photius. In his youth he had been a disciple of Polycarp,

who was a disciple of John. He asserts of himself and his contemporaries, that they were able to reckon up in all the principal churches the succession of bishops to their first institution. His testimony to the four gospels and Acts of the Apostles is express and positive. "We have not received," says Irenæus, "the knowledge of the way of our salvation by any others than those by whom the gospel has been brought to us. Which gospel they first preached, and afterwards by the will of God, committed to writing, that it might be for time to come the foundation and pillar of our faith. For after that our Lord rose from the dead, and they (the apostles) were endowed from above with the power of the Holy Ghost coming down upon them, they received a perfect knowledge of all things. They then went forth to all the ends of the earth, declaring to men the blessing of heavenly peace, having all of them, and every one alike, the gospel of God. Matthew then, among the Jews, wrote a gospel in their own language, while Peter and Paul were preaching the gospel at Rome, and founding a church there. And after their exit, Mark also, the disciple and interpreter of Peter, delivered to us in writing the things that had been preached by Peter. And Luke, the companion of Paul, put down in a book the gospel preached by him (Paul). Afterwards John, the disciple of the Lord, who also leaned upon his breast, likewise published a gospel while he dwelt at Ephesus in Asia." Irenæus then relates how Matthew begins his gospel, how Mark begins and ends his, and gives the supposed reasons for doing so. He enumerates at length all the passages of Christ's history in Luke, which are not found in any of the other evangelists. He states the particular design with which St John composed his gospel, and accounts for the doctrinal declarations which precede the narrative. If any modern divine should write a book upon the genuineness of the gospels, he could not assert it more expressly, or state their original more distinctly, than Irenæus hath done within little more than 100 years after they were published.

Respecting the book of the Acts of the Apostles, and its author, the testimony of Irenæus is no less explicit. Referring to the account of St Paul's conversion and vocation, in the ninth chapter of that book, "Nor can they (says he, meaning the parties with whom he argues) show that he is not to be credited, who has related to us the truth with the greatest exactness." In another place, he has actually collected the several texts, in which the writer of the history is represented as accompanying St Paul, which led him to exhibit a summary of almost the whole of the last twelve chapters of the book.

According to Lardner, Irenæus quotes twelve of Paul's epistles, naming their author; also the first epistle of Peter, the two first epistles of John, and the Revelation. The epistles of Paul which he omits are those addressed to Philemon and the Hebrews. Eusebius says, that he quotes the epistle to the Hebrews, though he does not ascribe it to Paul. The work, however, is lost.

A. D. 172, Tatian, who is spoken of by Clemens of Alexandria, Origen, Eusebius, and Jerome, composed a harmony of the four gospels, which he called *Diatessaron* of the four. This title, as well as the work, is remarkable,

Of Tatian.

Scripture markable, because it shows that then as well as now there were four, and only four, gospels in general use among Christians.

A. D. 170, the churches of Lyons and Vienne in France sent an account of the sufferings of their martyrs to the churches of Asia and Phrygia, which has been preserved entire by Eusebius. And what carries in some measure the testimony of these churches to a higher age is, that they had now for their bishop Pothinus, who was 90 years old, and whose early life consequently must have immediately followed the times of the apostles. In this epistle are exact references to the gospels of Luke and John, and to the Acts of the Apostles. The form of reference is the same as in all the preceding articles. That from St John is in these words: "Then was fulfilled that which was spoken by the Lord, that whosoever killeth you, will think that he doth God service *."

Distinct references are also made to other books, viz. Acts, Romans, Ephesians, Philippians, 1 Timothy, 1 Peter, 1 John, Revelation.

A. D. 140, Justin Martyr composed several books, which are mentioned by his disciple Tatian by Tertullian, Methodius, Eusebius, Jerome, Epiphanius, and Photius. In his writings between 20 and 30 quotations from the gospels and Acts of the Apostles are reckoned up, which are clear, distinct, and copious; if each verse be counted separately, a much greater number; if each expression, still more. Jones, in his book on the Canon of the New Testament, ventures to affirm that he cites the books of which it consists, particularly the four gospels, above 200 times.

We meet with quotations of three of the gospels within the compass of half a page; "and in other words, he says, Depart from me into outer darkness, which the Father hath prepared for Satan and his Angels," (which is from Matthew xxv. 41.). "And again he said in other words, I give unto you power to tread upon serpents and scorpions, and venomous beasts, and upon all the power of the enemy." (This from Luke x. 19.). "And, before he was crucified, he said, The son of man must suffer many things, and be rejected of the Scribes and Pharisees, and be crucified, and rise again the third day." (This from Mark viii. 31.).

All the references in Justin are made without mentioning the author; which proves that these books were perfectly well known, and that there were no other accounts of Christ then extant, or, at least, no others so received and credited as to make it necessary to add any marks of distinction. But although Justin mentions not the authors names, he calls the books *Memoirs composed by the Apostles*; *Memoirs composed by the Apostles and their Companions*; which descriptions, the latter especially, exactly suit the titles which the Gospels and Acts of the Apostles now bear.

He informs us, in his first apology, that the *Memoirs of the Apostles*, or the writings of the prophets, are read according as the time allows; and, when the reader has read, the president makes a discourse, exhorting to the imitation of such excellent things.

A few short observations will show the value of this testimony. 1. The *Memoirs of the Apostles*, Justin in another place expressly tells us are what are called *gospels*. And that they were the gospels which we now

use is made certain by Justin's numerous quotations of Scripture. 2. He describes the general usage of the Christian church. 3. He does not speak of it as recent or newly instituted, but in the terms in which men speak of established customs.

Justin also makes such allusions to the following books as shews that he had read them: Romans, 1 Corinthians, Galatians, Ephesians, Philippians, Colossians, 2 Thessalonians, Hebrews, 2 Peter; and he ascribes the Revelation to John the Apostle of Christ.

A. D. 116, Papias, a hearer of John, and companion of Polycarp, as Irenæus attests, and of the apostolical age as all agree, in a passage quoted by Eusebius, from a work now lost, expressly quotes the two first gospels to Matthew and Mark; and in a manner which proves that these gospels must have publicly borne the names of these authors at that time, and probably long before; for Papias does not say, that one gospel was written by Matthew, and another by Mark; but, assuming this as perfectly well known, he tells us from what materials Mark collected his account, viz. from Peter's preaching, and in what language Matthew wrote, viz. in Hebrew. Whether Papias was well informed in this statement or not, to the point for which this testimony is produced, namely, that these books bore these names at this time, his authority is complete.

Papias himself declares that he received his accounts of Christianity from those who were acquainted with the apostles, and that those accounts which he thus received from the older Christians, and had committed to memory, he inserted in his books. He further adds, that he was very solicitous to obtain every possible information, especially to learn what the apostles said and preached, valuing such information more than what was written in books *.

A. D. 108, Polycarp was the bishop of Smyrna, and disciple of John the Apostle. This testimony concerning Polycarp is given by Irenæus, who in his youth had seen him. "I can tell the place," saith Irenæus, "in which the blessed Polycarp sat and taught, and his going out and coming in, and the manner of his life, and the form of his person, and the discourses he made to the people, and how he related his conversation with John and others who had seen the Lord, and how he related their sayings, and what he had heard concerning the Lord, both concerning his miracles and his doctrine, as he had received them from the eye-witnesses of the word of life; all which Polycarp related agreeable to the scriptures."

Of Polycarp, whose proximity to the age and country and persons of the apostles is thus attested, we have one undoubted epistle remaining; which, though a short performance, contains nearly 40 clear allusions to the books of the New Testament. This is strong evidence of the respect which was paid to them by Christians of that age. Amongst these, although the writings of St Paul are more frequently used by Polycarp than other parts of scripture, there are copious allusions to the gospel of St Matthew, some to passages found in the gospels both of Matthew and Luke, and some which more nearly resemble the words in Luke.

He thus fixes the authority of the Lord's Prayer, and the use of it among Christians. It, therefore, we pray

* John xvi. 2.

100
Of Justin Martyr.

101

Of Papias.

* Praefat. in Op. apud Euseb. Hist. Eccl. lib. iii. c. 39. Of Polycarp.

the Lord to forgive us, we ought also to forgive. And again, With supplication beseeching the all-seeing God not to lead us into temptation.

In another place, he quotes the words of our Lord: "But remembering what the Lord said, teaching, Judge not, that ye be not judged. Forgive, and ye shall be forgiven; be ye merciful, that ye may obtain mercy; with what measure ye mete, it shall be measured to you again." Supposing Polycarp to have had these words from the books in which we now find them, it is manifest that these books were considered by him, and by his readers, as he thought, as authentic accounts of Christ's discourses; and that this point was incontestable.

He quotes also the following books, the first of which he ascribes to St Paul: 1 Corinthians, Ephesians, Philippians, 1 and 2 Thessalonians; and makes evident references to others, particularly to Acts, Romans, 2 Corinthians, Galatians, 1 Timothy, 2 Timothy, 1 Peter, 1 John.

Ignatius, as it is testified by ancient Christian writers, became bishop of Antioch about 37 years after Christ's ascension; and therefore, from his time, and place, and station, it is probable that he had known and conversed with many of the apostles. Epistles of Ignatius are referred to by Polycarp his contemporary. Passages, found in the epistles now extant under his name, are quoted by Irenæus, A. D. 178, by Origen, A. D. 230; and the occasion of writing them is fully explained by Eusebius and Jerome. What are called the smaller epistles of Ignatius are generally reckoned the same which were read by Irenæus, Origen, and Eusebius.

They are admitted as genuine by Vossius, and have been proved to be so by Bishop Pearson with a force of argument which seems to admit of no reply. In these epistles are undoubted allusions to Matt. iii. 15. xi. 16. to John iii. 8; and their venerable author, who often speaks of St Paul in terms of the highest respect, once quotes his epistle to the Ephesians by name.

Near the conclusion of the epistle to the Romans, St Paul, amongst others, sends the following salutation:—"Salute Afnervitus, Phlegon, *Hermas*, Patrobus, Hermes, and the brethren which are with them." Of *Hermas*, who appears in this catalogue of Roman Christians as contemporary with St Paul, there is a book still remaining, the authenticity of which cannot be disputed. It is called the *Shepherd*, or *Pastor of Hermas*. Its antiquity is incontestable, from the quotations of it in Irenæus, A. D. 178, Clement of Alexandria, A. D. 194, Tertullian, A. D. 220, Origen, A. D. 230. The notes of time extant in the epistle itself agree with its title, and with the testimonies concerning it, which intimate that it was written during the life time of Clement. In this piece are tacit allusions to St Matthew's, St Luke's, and St John's gospels; that is to say, there are applications of thoughts and expres-

sions found in these gospels, without citing the place or writer from which they were taken. In this form appear in *Hermas* the confessing and denying of Christ † † Matt. x. the parable of the seed sown; † the comparison of Christ's disciples to little children; the saying, "he that putteth away his wife, and marieth another, committeth adultery †"; the singular expression, "having received all power from his Father," is probably an allusion to Matt. xxviii. 18, and Christ being the "gate," or only way of coming "to God," is a plain allusion to John xiv. 6. x. 7. 9. There is also a probable allusion to Acts v. 32.

The *Shepherd of Hermas* has been considered as a fanciful performance. This, however, is of no importance in the present case. We only adduce it as evidence that the books to which it frequently alludes existed in the first century; and for this purpose it is satisfactory, as its authenticity has never been questioned. If ever absurd opinions a man may entertain while he retains his understanding, his testimony to a matter of fact will still be received in any court of justice.

A. D. 96, we are in possession of an epistle written by Clement bishop of Rome, whom ancient writers, without any scruple, assert to have been the Clement whom St Paul mentions Philippians iv. 3. "with Clement also, and other my fellow labourers, whose names are in the book of life." This epistle is spoken of by the ancients as an epistle acknowledged by all; and, as Irenæus well represents its value, "written by Clement, who had seen the blessed apostles and conversed with them, who had the preaching of the apostles still sounding in his ears, and their traditions before his eyes." It is addressed to the church of Corinth; and what alone may seem a decisive proof of its authenticity, Dionysius bishop of Corinth, about the year 170, i. e. about 80 or 90 years after the epistle was written, bears witness, "that it had been usually read in that church from ancient times." This epistle affords, amongst others, the following valuable passages: "Especially remembering the words of the Lord Jesus, which he spake, teaching gentleness and long suffering; for thus he said (†), Be ye merciful, that ye may obtain mercy; forgive, that it may be forgiven unto you; as you do, so shall it be done unto you; as you give, so shall it be given unto you; as ye judge, so shall ye be judged; as ye shew kindness, so shall kindness be shewn unto you; with what measure ye mete, with the same it shall be measured to you. By this command, and by these rules, let us establish ourselves, that we may always walk obediently to his holy words."

Again, "Remember the words of the Lord Jesus, for he said, Wo to that man by whom offences come; it were better for him that he had not been born, than that he should offend one of my elect; it were better for him that a millstone should be tied about his neck, and that he should be drowned in the sea, than that he should offend one of my little ones (†)."

He

(†) "Blessed are the merciful, for they shall obtain mercy," Matt. v. 7. "Forgive, and ye shall be forgiven; give, and it shall be given unto you," Luke vi. 37, 38. "Judge not, that ye be not judged; for with what judgement ye judge, ye shall be judged, and with what measure ye mete, it shall be measured to you again," Matt. vii. 2.

(†) Matt. xviii. 6. "But who shall offend one of these little ones which believe in me, it were better for him that a millstone were hung about his neck, and that he were cast into the sea." The latter part of the passage

Scripture. He ascribes the first epistle to the Corinthians to Paul, and makes such allusions to the following books as are sufficient to show that he had seen and read them: Acts, Romans, 2 Corinthians, Galatians, Ephesians, Philippians, Colossians, 1 Thessalonians, 1 Timothy, 2 Timothy, Titus, 1 Peter, 2 Peter.

It may be said, as Clement has not mentioned the books by name from which we ascribe these allusions or references are made, it is uncertain whether he refers to any books, or whether he received these expressions from the discourses and conversation of the apostles. Mr Paley has given a very satisfactory answer to this objection: 1st, That Clement, in the very same manner, namely, without any mark of reference, uses a passage now found in the epistle to the Romans²; which passage, from the peculiarity of the words that compose it, and from their order, it is manifest that he must have taken from the epistle. The same remark may be applied to some very singular sentences in the epistle to the Hebrews. Secondly, That there are many sentences of St Paul's first epistle to the Corinthians, to be found in Clement's epistle, without any sign of quotation, which yet certainly are quotations; because it appears that Clement had St Paul's epistle before him; for in one place he mentions it in terms too expressive to leave us in any doubt. "Take into your hands the epistle of the blessed apostle Paul." Thirdly, That this method of adopting words of scripture, without reference or acknowledgement, was a method in general use amongst the most ancient Christian writers. These analogies not only repel the objection, but cast the presumption on the other side; and afford a considerable degree of positive proof, that the words in question have been borrowed from the places of scripture in which we now find them. But take it, if you will, the other way, that Clement had heard these words from the apostles or first teachers of Christianity; with respect to the precise point of our argument, viz. that the scriptures contain what the apostles taught, this supposition may serve almost as well.

We have now traced the evidence to the times of the apostles; but we have not been anxious to draw it out to a great length, by introducing every thing. On the contrary, we have been careful to render it as concise as possible, that its force might be discerned at a glance. The evidence which has been stated is of two kinds. Till the time of Justin Martyr and Irenæus it consists chiefly of allusions, references, and expressions, borrowed from the books of the New Testament, without mentioning them by name. After the time of Irenæus it became usual to cite the sacred books, and mention the authors from whom the citations were taken.

The first species of evidence will perhaps appear to some exceptional; but it must be remembered that it was usual among the ancient Christians as well as Jews to adopt the expressions of Scripture without naming the authors. Why they did so it is not necessary to inquire. The only point of importance to be determined is, whether those references are a sufficient proof

of the existence of the books to which they allude. This, we presume, will not be denied; especially in the present age, when it is so common to charge an author with plagiarism if he happens to fall upon the same train of ideas, or express himself in a similar manner with authors who have written before him. We may further affirm, that these ancient references afford a complete proof that those ancient writers had no intention of imputing a forgery upon the world. They prove the existence of the Christian religion and of the apostolical writings, without showing any suspicious circumstances that men should believe a lie. Had these books been forged, those who wished to pass them upon the world would have been at more pains than the first Christians were to prove their author false. They cited the part of honest men; they believed them themselves, and they never imagined that others would suspect their truth.

It is a consideration of great importance, in reviewing the evidence which has been now set forth, that the witnesses lived in different countries; Clement flourished at Rome, Polycarp at Smyrna, Justin Martyr in Syria, Irenæus in France, Tertullian at Carthage, Origen at Alexandria, and Eusebius at Caesarea. This proves that the books of the New Testament were equally well known in distant countries by men who had no intercourse with one another.

The same thing is proved by testimonies if possible less exceptional. The ancient heretics, whose opinions were sometimes grosser and more impious than those which any modern sectary has ventured to propose, and whose zeal in the propagation of their poisoned creed of the most flaming enthusiasm of the last century, never called in question the authenticity of the books of the New Testament. When they met with any passage in the gospels or epistles which they could not reconcile to their own heretical notions, they either erred it, or denied that the author was inspired; but they nowhere concluded that the book in which it stood was not written by the apostle or evangelist whose name it bore. Lactantius relates, that the Ebionites rejected all the epistles of Paul, and called him an apostate, because he departed from the Levitical law; and they adopted as their rule of faith the gospel of St. Matthew, though indeed they greatly corrupted it. This proves therefore that the gospel according to Matthew was then published, and that St. Paul's epistles were then known.

Of the heretics who erred or altered passages to make the Scriptures agree with their doctrines, we may produce Marcion as an instance, who lived in the beginning of the second century. He lived in an age when he could have easily discovered if the writings of the New Testament had been forged; and as he was much interested against the orthodox party, if such a forgery had been committed, unperceivably he would not have failed to make the discovery, as it would have afforded the most ample means of revenge and triumph, and enabled him to establish his own opinions with less difficulty. But his whole conduct shows clearly, that he believed the writings of the New Testament to be authentic.

in Clement agrees more exactly with Luke xvii. 2. "It were better for him that a millstone were hanged about his neck, and he cast into the sea, than that he should offend one of these little ones."

Scripture.

authentic. He said, that the gospel according to St Matthew, the epistle to the Hebrews, with those of St Peter and St James, as well as the Old Testament in general, were writings not for Christians but for Jews. He published a new edition of the gospel according to Luke, and the first ten epistles of Paul; in which it has been affirmed by Epiphanius, that he altered every passage that contradicted his own opinions: but as many of these alterations are what modern critics call *various readings*, though we receive the testimony of Epiphanius, we must not rely upon his opinion (x). Hence it is evident that the books of the New Testament above-mentioned did then exist, and were acknowledged to be the works of the authors whose names they bear.

Dr Lardner, in his General Review, sums up this head of evidence in the following words: "Noetus, Paul of Samofata, Sabellius, Marcellus, Photinus, the Novatians, Donatists, Manicheans (Y), Priscillianists, beside Artemon, the Audians, the Arians, and divers others, all received most or all the same books of the New Testament which the Catholics received; and agreed in a like respect for them as writ by apostles or their disciples and companions."

105
Testimonies of Hea-
thens.

Celsus and Porphyry, both enemies of the Christian religion, are powerful witnesses for the antiquity of the New Testament. Celsus, who lived towards the end of the second century, not only mentions by name, but quotes passages from the books of the New Testament; and that the books to which he refers were no other than our present gospels, is evident from the allusions to various passages still found in them. Celsus takes notice of the precepts, Resist not him that injures you, and, If a man strike thee on the one cheek, offer to him the other also; of the woes denounced by Christ; of his predictions; of his saying, that it is impossible to serve two masters; of the purple robe, the crown of thorns, and the reed which was put into the hand of Jesus; of the blood that flowed from his body upon the cross, a circumstance which is recorded only by John; and (what is *inftar omnium* for the purpose for which we produce it) of the difference in the accounts given of the resurrection by the evangelists, some mentioning two angels at the sepulchre, others only one.

It is extremely material to remark, that Celsus not only perpetually referred to the accounts of Christ contained in the four gospels, but that he referred to no other accounts; that he founded none of his objections to Christianity on any thing delivered in spurious gospels.

110
Of Porphy-
ry.

The testimony of Porphyry is still more important than that of Celsus. He was born in the year 213, of Tyrian origin. Unfortunately for the present age, says Michaelis, the mistaken zeal of the Christian emperors has banished his writings from the world; and every real friend of our religion would gladly give the works of one of the pious fathers to rescue those of Porphyry from the flames. But Mr Marsh, the learned and judicious translator of Michaelis, relates, that, according to the accounts of Isaac Vossius, a manuscript

Scripture.

of the works of Porphyry is preserved in the Medicean library at Florence, but kept so secret that no one is permitted to see it. It is universally allowed, that Porphyry is the most sensible, as well as the most severe, adversary of the Christian religion that antiquity can produce. He was versed not only in history, but also in philosophy and politics. His acquaintance with the Christians was not confined to a single country; for he had conversed with them in Tyre, in Sicily, and in Rome. Enabled by his birth to study the Syriac as well as the Greek authors, he was of all the adversaries to the Christian religion the best qualified to inquire into the authenticity of the sacred writings. He possessed therefore every advantage which natural abilities or a scientific education could afford to discover whether the New Testament was a genuine work of the apostles and evangelists, or whether it was imposed upon the world after the decease of its pretended authors. But no trace of this suspicion is anywhere to be found in his writings. In the fragments which still remain, mention is made of the gospels of St Matthew, St Mark, and St John, the Acts of the Apostles, and the epistle to the Galatians; and it clearly appears from the very objections of Porphyry, that the books to which he alludes were the same which we possess at present. Thus he objects to the repetition of a generation in St Matthew's genealogy; to Matthew's call; and to the quotation of a text from Isaiah, which is found in a psalm ascribed to Asaph; to the calling of the lake of Tiberias a sea; to the expression in St Matthew, "the abomination of desolation;" to the variation in Matthew and Mark upon the text "the voice of one crying in the wilderness;" Matthew citing it from Isaiah, Mark from the prophets; to John's application of the term *Word*; to Christ's change of intention about going up to the feast of tabernacles (John vii. 8.); to the judgement denounced by St Peter upon Ananias and Sapphira, which he calls an imprecation of death.

The instances here alleged serve in some measure to show the nature of Porphyry's objections, and prove that Porphyry had read the gospels with that sort of attention which a writer would employ who regarded them as the depositaries of the religion which he attacked. Beside these specifications, there exists in the writings of ancient Christians general evidence, that the places of Scripture, upon which Porphyry had made remarks, were very numerous.

The internal evidence to prove the authenticity of the New Testament consists of two parts: The nature of the style, and the coincidence of the New Testament with the history of the times.

The style of the New Testament is singular, and differs very widely from the style of classical authors. It is full of Hebraisms and Syriacisms; a circumstance which pious ignorance has considered as a fault, and which even so late as the present century, it has attempted to remove; not knowing that these very deviations from Grecian purity afford the strongest presumption in its favour: for they prove, that the *New Testament was written by men of Hebrew origin, and is therefore a production*

(x) Dr Loeffler has written a learned dissertation to prove that Marcion did not corrupt the sacred writings.

(y) This must be with an exception, however, of Faustus, who lived so late as the year 384.

Scripture. *duction of the first century.* After the death of the first Jewish converts, few of the Jews turned preachers of the gospel; and the Christians were generally ignorant of Hebrew, and consequently could not write in the style of the New Testament. After the destruction of Jerusalem and the dispersion of the Jews, their language must have been blended with that of other nations, and their vernacular phraseology almost entirely lost. The language of the early fathers, though not always the purest classic Greek, has no resemblance to that of the New Testament, not even excepting the works of the few who had a knowledge of the Hebrew; as Origen, Epiphanius, and Justin Martyr, the last of whom being a native of Palestine, might have written in a style similar to that of the New Testament, had such a style then prevailed. He that suspects the New Testament to be the forgery of a more recent period, ought to produce some person who has employed a similar diction; but those who are conversant with eastern writings know well that a foreigner, who has not been accustomed to eastern manners and modes of thinking from his infancy, can never imitate with success the oriental style, much less forge a history or an epistle which contains a thousand incidental allusions, which nothing but truth could suggest. To imitate closely the style of the New Testament is even more difficult than to imitate that of any other oriental book; for there is not a single author, even among the Jews themselves, since the destruction of Jerusalem, that has composed in a style in the least degree like it (z).

But though the books of the New Testament bear so close a resemblance in idiom, there is a diversity of style which shows them to be the work of different persons. Whoever reads with attention the epistles of Paul, must be convinced that they were all written by the same author. An equal degree of familiarity is to be found between the gospel and 1st epistle of John. The writings of St John and St Paul exhibit marks of an original genius which no imitation can ever attain. The character of Paul as a writer is drawn with great judgment by Michaelis: "His mind overflows with sentiment, yet he never loses sight of his principal object, but hurried on by the rapidity of thought, discloses frequently in the middle a conclusion to be made only at the end. To a profound knowledge of the Old Testament he joins the acuteness of philosophical wisdom, which he displays in applying and expounding the sacred writings; and his explanations are therefore sometimes so new and unexpected, that superficial observers might be tempted to suppose them erroneous. The fire of his genius, and his inattention to style, occasion frequently a twofold obscurity, he being often too concise to be understood except by those to whom he immediately wrote, and not seldom on the other hand so full of his subject, as to produce long and difficult parentheses, and a repetition of the same word even in different senses. With a talent for irony and satire, he unites the most refined sensibility, and tempers the severity of his censures by expressions of tenderness and affection;

VOL. XIX. Part I.

nor does he ever forget in the vehemence of his zeal the rules of modesty and decorum. He is a writer, in short, of so singular and wonderful a composition, that it would be difficult to find a rival. That truly sensible and sagacious philosopher Locke was of the same opinion, and contended that St Paul was without an equal."

Poems have been forged and ascribed to former ages with some success. Philosophical treatises might be invented which it would be difficult to detect; but there is not a single instance on record where an attempt has been made to forge a history or a long epistle, where the fraud has not been either fully proved, or rendered so suspicious that few are weak enough to believe it. Whoever attempts to forge a history or an epistle in the name of an ancient author, will be in great danger of contradicting the history or the manners of that age, especially if he relate events which are not mentioned in general history, but such as refer to a single city, sect, religion, or school.

The difficulty of forging such histories as the gospels, and such epistles as those of Paul, cannot be overcome by all the genius, learning, and industry, of any individual or society of men that ever lived. They contain a purer system of ethics than all the ancient philosophers could invent: They discover a candour and modesty unexampled: They exhibit an originality in the character of Jesus, and yet such a consistency as the imagination of our best poets has never reached. Now it is a very remarkable circumstance, that histories written by four different men should preserve such dignity and consistency, though frequently relating different actions of Jesus, and descending to the most minute circumstances in his life. The scene of action is too extensive, and the agreement of facts with the state of the times as represented by other historians is too close, to admit the possibility of forgery.

The scene of action is not confined to one country, it is successively laid in the greatest cities of the Roman empire; in Rome, in Antioch, in Corinth, in Athens, as well as in Jerusalem and the land of Palestine. Innumerable allusions are made to the manners and opinions of the Greeks, the Romans, and the Jews; and respecting the Jews, they extend even to the trilles and follies of their schools. Yet after the strictest examination, the New Testament will be found to have a wonderful coincidence and harmony with Josephus, the principal historian of these times, and an enemy of Christianity.

It has been a question who the soldiers were who are said in the gospel of Luke to have addressed John the Baptist in these words, *What shall we do?* An answer to this question may be found in Josephus'. Herod the tetrarch of Galilee was engaged in a war with his father-in-law Aretas, a petty king in Arabia Petrea, at the very time that John was preaching in the wilderness; and the road from Galilee to Arabia running through that wilderness, the soldiers on their march had this interview with the Baptist. A coincidence like this, And from remarkable instances of coincidence between Josephus and the New Testament. * See through that wilderness, the soldiers on their march had this interview with the Baptist. A coincidence like this, esp. 3.

C

which is 3, 2

(z) The style of Clemens Romanus may perhaps be an exception. By many eminent critics it has been thought so like to that of the epistle to the Hebrews, as to give room for the opinion that Clement either was the author of that epistle, or was the person who translated it from the Syro-Chaldaic language, in which it was originally composed.

Scripture, which has been overlooked by all the commentators, would not probably be attended to in a forgery.

Ch. up. ii. § 11. Another instance of an agreement no less remarkable we shall quote from the valuable work of Michaelis. It has been a question of some difficulty among the learned, who was the Ananias who commanded St Paul to be smitten on the mouth when he was making his defence before the council in Jerusalem? * Acts xxiii. 1-5. Erens, in his remarks taken from Josephus, has shown him to have been the son of Nebedeni. But if so, how can it be reconciled with chronology, that Ananias was, at that time, called high priest, when it is certain from Josephus that the time of his holding that office was much earlier? And how comes it to pass that St Paul says, "I will not, brethren, that he was the high priest?" The sacerdotal garb must have discovered who he was: a jest would have ill-suited the gravity of a tribunal; and a falsehood is inconsistent with the character of St Paul.

All these difficulties vanish as soon as we examine the special history of that period: "Ananias the son of Nebedeni was high priest at the time that Helena queen of Adiabene supplied the Jews with corn from Egypt during the famine which took place in the fourth year of Claudius, mentioned in the eleventh chapter of the Acts. St Paul therefore, who took a journey to Jerusalem at that period, could not have been ignorant of the elevation of Ananias to that dignity. Soon after the holding of the first council, as it is called, at Jerusalem, Ananias was dispossessed of his office, in consequence of certain acts of violence between the Samaritans and the Jews, and sent prisoner to Rome; but being afterwards released, he returned to Jerusalem. Now from that period he could not be called *high-priest* in the proper sense of the word, though Josephus has sometimes given him the title of *episcopus*, taken in the more extensive meaning of a priest who had a seat and voice in the Sanhedrim; and Jonathan, though we are not acquainted with the circumstances of his elevation, had been raised in the mean time to the supreme dignity in the Jewish church. Between the death of Jonathan, who was murdered by order of Felix, and the high-priesthood of Ismael, who was invested with that dignity by Agrippa, elapsed an interval during which the sacerdotal office was vacant. Now it happened precisely in this interval that St Paul was apprehended in Jerusalem: and, the Sanhedrim being destitute of a president, he undertook of his own authority the discharge of that office, which he executed with the greatest tyranny. It is possible therefore that St Paul, who had been only a few days in Jerusalem, might be ignorant that Ananias, who had been dispossessed of the priesthood, had taken upon himself a trust to which he was not entitled; he might therefore very naturally exclaim, 'I will not, brethren, that he was the high-priest!' Admitting him on the other hand to have been acquainted with the fact, the expression must be considered as an indirect reproach, and a tacit refusal to recognize usurped authority."

Could such a correspondence as this subsist between truth and falsehood, between a forgery and an authentic history? or is it credible that these events could be related by any person but a contemporary?

Impressed with the love of truth, and feeling contempt as well as detestation at pious frauds, we hesitate

not to acknowledge, that in some particular facts there is a difference either real or apparent between Josephus and the writers of the New Testament. The objections arising from these differences are of two kinds: 1. Such as would prove a book not to have been written by the author to whom it is ascribed. 2. Such as would prove that the author was mistaken, and therefore not divinely inspired. To the first class belongs the following objection: St Paul says (2 Cor. xi. 32.) that the governor of Damascus was under Aretas the king; but if we are to judge from the 18th book of the Jewish Antiquities, which corresponds with the period of St Paul's journey to Damascus, that city must have belonged at that time to the Romans; and what authority could Aretas, a petty king in Arabia Petraea, have in such a city? In answer to this question, J. G. Hyne, in a dissertation published in 1755, has shown it to be highly probable that Aretas, against whom the Romans, not long before the death of Tiberius, made a declaration of war, which they neglected to put in execution, took the opportunity of seizing Damascus, which had once belonged to his ancestors; an event omitted by Josephus, as forming no part of the Jewish history, and by the Roman historians as being a matter not flattering in itself, and belonging only to a distant province. Secondly, that Aretas was by religion a Jew; a circumstance the more credible, when we reflect that Judaism had been widely propagated in that country, and that even kings in Arabia Felix had recognized the law of Moses. The difficulty then is so far removed, that it ceases to create suspicion against an epistle which has so many evident marks of authenticity; and it is only to be regretted that, in order to place the subject in the clearest point of view, we are not sufficiently acquainted with the particular history of Damascus.

Examples of the second kind are such as, if allowed their full force, might indeed prove a writer not divinely inspired, but could afford no reason to conclude that he was not the author of the writings which bear his name, since mistakes may be committed by the most accurate historian. The chief difficulties of this nature are found in the gospel according to St Luke, and do not apply to the writings of Matthew, John, Paul, and Peter. Laying aside the idea of inspiration altogether, let us inquire whether Luke or Josephus be most entitled to credit in those passages where they differ, which of them is most accurate, and which of them had the best opportunities of exploring the truth of the facts which they relate. Now Josephus relates the same story differently in different parts of his works, and is sometimes equally mistaken in them all. We do not recollect to have seen such inconsistencies in the writings of St Luke. Luke knew the characters, and witnessed many of the facts, of which he speaks; and he could receive the best information respecting those facts which were transacted in his absence. Josephus was born A. D. 37, some years after our Saviour's ascension. Now it is a very important observation of Michaelis, that the period of history with which mankind are least acquainted is that which includes the time of their childhood and youth, together with the twenty or thirty years immediately preceding their birth. Concerning the affairs transacted during that period, we are much more liable to fall into mistakes than concerning those

114
There are also apparent inconsistencies, but these probably arise from oversight in Josephus;
115
or to his want of authentic information concerning the events that happened near his birth.

Scripture. those of a remoter age. The reason is, that authentic history never comes down to the period of our birth; our knowledge of the period immediately preceding depends on hearsay; and the events, which pass within the first eighteen or twenty years of our lives, we are too young and heedless to observe with attention. This must have been more remarkably the case in the time of Josephus than at present, when there were neither daily papers nor periodical journals to supply the want of regular annals. There was no historian from whom Josephus could derive any knowledge of the times that immediately preceded his birth. There is a period then of forty or fifty years, in which, even with the most diligent inquiry, he was exposed to error.

When we find therefore the relations of Luke and Josephus so different as not to be reconciled, it would be very unfair to determine without any further inquiry in favour of Josephus. Let their character, and works, and situation, be strictly examined; let their testimony be duly weighed and compared; and then let the preference be given to that author who, according to the strictest rules of equity and justice, seems entitled to the highest degree of credit. The decision of a jury, we shall venture to say, would in every instance turn out in favour of Luke.

116
Information of the New Testament.

Having thus ascertained the authenticity of the books of the New Testament, the next thing to be considered is their inspiration. It is certainly of some importance to know how far the apostles and evangelists were guided in their writings by the immediate influence of the spirit of God; though this knowledge, if attainable, is not equally important with that of the authenticity of these writings. Michaelis indeed asserts, that the divinity of the New Testament may be proved whether we can convince it to be written by immediate inspiration or not.*

* Chap. iii. § 1.

* The question (says he), whether the books of the New Testament are inspired? is not so important as the question, whether they are genuine? The truth of our religion depends upon the latter, not absolutely on the former. Had the Deity inspired not a single book of the New Testament, but left the apostles and evangelists without any other aid than that of natural abilities to commit what they knew to writing, admitting their works to be authentic, and possessed of a sufficient degree of credibility, the Christian religion would still be well founded. The miracles by which it is confirmed would equally demonstrate its truth, even if the persons who attested them were not inspired, but simply human witnesses; and their divine authority is never presupposed, when we discuss the question of miracles, but merely their credibility as human evidence. If the miracles are true which the evangelists relate, the doctrines of Christ recorded in the gospels are proved to be the infallible oracles of God; and, even if we admit the apostles to be mistaken in certain not essential circumstances, yet as the main points of the religion which Christ commissioned them to preach are so frequently repeated, their errors would instruct us as well in the tenets of the Christian system, as the works of Maclaurin in the philosophy of Newton. It is possible therefore to doubt, and even deny, the inspiration of the New Testament, and yet be fully persuaded of the truth of the Christian religion; and many really entertain these sentiments either publicly or in private, to whom we

should render great injustice, if we ranked them in the class of unbelievers.

" Yet the Christian religion would be attended with difficulty, if our *principium cognoscendi* relied not on firmer ground; and it might be objected, that sufficient care had not been taken for those whose confidences were tender, and who were anxiously fearful of mistaking the smallest of the divine commands. The chief articles indeed of Christianity are so frequently repeated, both by Christ and his apostles, that even were the New Testament not inspired, we could entertain no doubt of the following doctrines: 'Jesus was the Messiah of the Jews, and an infallible messenger of God: he died for our iniquity; and by the satisfaction made by his death we obtain remission of sins, if on our part be faith and amendment of life: the Levitical law is abolished, and moral precepts, with the ceremonies of Baptism and the Supper of the Lord, are appointed in its stead; after the present follows an everlasting life, in which the virtuous shall be rewarded and the wicked punished, and where Christ himself shall be the Judge.'

" To the epistles indeed (says Michaelis), inspiration is of real consequence; but with respect to the historical books, viz. the Gospels and the Acts of the Apostles, we should really be no losers if we abandoned the system of inspiration, and in some respects have a real advantage. We should be no losers, if we considered the apostles in historical facts as merely human witnesses, as Christ himself has done in saying, 'Ye also shall bear witness, because ye have been with me from the beginning.*' And no one that attempts to convince an unbeliever of the truth of Christianity, would begin his demonstration by presupposing a doctrine which his adversary denies, but would ground his arguments on the credibility of the evangelists as human historians, for the truth of the miracles, the death, and the resurrection of Christ. Even those who examine the grounds of their faith for their own private conviction, must treat the evangelists as human evidence; since it would be arguing in a circle to conclude that the facts recorded in the gospels are true, because they are inspired, when we conclude the Scriptures to be inspired in consequence of their contents. In these cases, then, we are obliged to consider the evangelists as human evidence; and it would be no detriment to the Christian cause to consider them at all times as such in matters of historical fact. We find it nowhere expressly recorded that the public transactions which the apostles knew by their own experience, and of which St Luke informed himself by diligent inquiry, should be particular objects of divine inspiration. We should even be considerable gainers, in adjusting the harmony of the gospels, if we were permitted to suppose that some one of the evangelists had committed an immaterial error, and that St John has rectified some trifling mistakes in the preceding gospels. The most dangerous objections which can be made to the truth of our religion, and such as are most difficult to answer, are those drawn from the different relations of the four evangelists."

119
Before any inquiry is made respecting the inspiration of the books of the New Testament, it is necessary to determine the meaning of the term; for theologians have given to it a variety of significations. Most of the German divines make it to consist in an infusion of

Scripture. words as well as ideas. Luther, Beza, and Salmasius, rest not it to ideas alone. Doddridge understands by it an intervention of the Deity, by which the natural faculties of the mind were directed to the discovery of truth. Warburton and Law think it was a negative intervention to preserve the sacred writers from essential error. Some believe every circumstance was dictated by the Holy Ghost; others suppose that no supernatural assistance was granted except in the epistolary writings. See **INSPIRATION**.

As there is an evident distinction between inspiration and revelation, and as the origin of the Christian religion may be still proved divine, even though it were denied that those who record its facts and doctrines were inspired in the act of writing, it will be most judicious and safe to employ the word *inspiration* in that sense which can be most easily defended and supported. By doing this, much may be gained and nothing lost. It is difficult to prove to a deity that the words of Scripture are divine, because he sees that every writer has words and phrases peculiar to himself. It is difficult also to prove that the ideas were infused into the mind of the authors while they were engaged in the act of writing; because concerning facts they appeal not to divine inspiration, but declare *what they have seen and heard*. In reasoning they add their own sentiments to what they had received from the Lord, and subjoin, especially in their epistles, things not connected with religion. The definition which Doddridge gives, seems applicable to ordinary gifts or the usual endowments of rational creatures, rather than to the extraordinary gifts of the Holy Spirit, which were bestowed on the apostles. Those who maintain that every fact or circumstance was suggested by divine inspiration, will find it no easy matter to prove their position. The opinion of Warburton and Law, with proper explanations, seems most probable. The opinion of Grotius, that only the epistles were inspired, may be easily refuted.

The proof of the authenticity of the New Testament depends on human testimony: The proof of its inspiration is derived from the declaration of inspired persons.

In proving that the New Testament is inspired, we presuppose its authenticity, that the sacred books were written by the apostles whose names they bear, and that they have been conveyed to us pure and uncorrupted. This we have already attempted to prove, and we hope with success. The evidence of inspiration is the testimony of Christ and his apostles, which we receive as credible, because they confirmed their doctrines by miracles. From the important mission of Christ and his apostles, we infer that every power was bestowed which divine wisdom thought expedient; and from their conduct we conclude, that it is morally impossible that they could lay claim to any powers which they did not possess. It is proper therefore to inquire into the declarations of Christ and his apostles concerning the nature, degree, and extent, of the inspiration bestowed on the writers of the sacred books.

If we consider Christ's more immediate promises of inspiration to the apostles, we shall find that he has given them, in the most proper sense of the word, at three several periods, 1st, When he sent the apostles to preach the gospel: 2dly, In holding a public discourse relating to the gospel, at which were present a con-

derable multitude; 3dly, In his prophecy of the destruction of Jerusalem. When he sent the apostles to preach the gospel, he thus addressed them: "When they deliver you up, take no thought how or what ye shall speak, for it shall be given you in that same hour what ye shall speak; for it is not you that speak, but the spirit of your father that speaketh in you." The same promise was made almost in the same words in the presence of an immense multitude (Luke xii. 11, 12). From these passages it has been urged, that if the apostles were to be inspired in the presence of magistrates in delivering speeches, which were soon to be forgotten, it is surely reasonable to conclude that they would be inspired when they were to compose a standard of faith for the use of all future generations of Christians. If this conclusion be fairly deduced, it would follow that the writings of the New Testament are the dictates of inspiration, not only in the doctrines and precepts, but in the very words. But it is a conclusion to which sincere Christians have made objections; for, say they, though Christ promises to assist his apostles in cases of great emergency, where their own prudence and fortitude could not be sufficient, it does not follow that he would dictate to them those facts which they knew already, or those reasonings which their own calm reflection might supply. Besides, say they, if the New Testament was dictated by the Holy Spirit, and only penned by the apostles, what reason can be given for the care with which Christ instructed them both during his ministry and after his crucifixion in those things pertaining to the kingdom of God?

In answer to this, we may observe, that though it is difficult to prove that the identical words of the New Testament were dictated by the Holy Spirit, or the train of ideas infused into the minds of the sacred writers, there is one species of inspiration to which the New Testament has an undoubted claim. It is this, that the memories of the apostles were strengthened and their understandings preserved from falling into essential errors. This we prove from these words of our Saviour, "and I will pray the Father, and he will give you another comforter, that he may abide with you for ever. He shall teach you all things, and bring all things to your remembrance whatsoever I have said unto you." * John xiv. This promise was surely not restrained to the day of Pentecost; it must have been a permanent gift, enabling the apostles at all times to remember with accuracy the discourses of our Saviour. When the apostles therefore (Matthew and John) relate those precepts of Christ which they themselves had heard, they write indeed from memory, but under the protection of the spirit who secures them from the danger of mistake: and we must of course conclude that their gospels are inspired.

Were we called upon more particularly to declare what parts of the New Testament we believe to be inspired, we would answer, The doctrines, the precepts, and the prophecies, every thing essential to the Christian religion. From these the idea of inspiration is inseparable. As to the events, the memory of the apostles was sufficient to retain them. If this opinion be just, it would enable us to account for the discrepancies between the sacred writers, which are chiefly confined to the relation of facts and events.

All the books of the New Testament were originally written in Greek, except the Gospel according to Mat-

119
The proof of inspiration depends on the declarations of Christ and his apostles.

120
The declarations of Christ.

121
Matt. x. 34.

Scripture. Mark xii. 11; Luke xii. 12.

122
Proper idea of inspiration.

* John xiv. 26.

Scripture. they and the epistle to the Hebrews, which there is reason to believe were composed in the Syro-Chaldaic language, which in the New Testament is called Hebrew.

Various reasons have been assigned why the greatest part of the New Testament was written in Greek; but the true reason is this, It was the language best understood both by writers and readers. Had St Paul written to a community in the Roman province of Africa, he might have written perhaps in Latin; but epistles to the inhabitants of Corinth, Galatia, Ephesus, Philippi, and Thessalonica, to Timothy, Titus, and Paulemon, from a native of Tarsus, could hardly be expected in any other language than Greek. The same may be said of the epistles of St Peter, which are addressed to the Christians of different countries, who had no other language in common than the Greek; and likewise of the epistles of St James, who wrote to Jews, that lived at a distance from Palestine, and were ignorant of Hebrew. The native language of St Luke, as well as of Theophilus, to whom he addressed his gospel, and Acts of the apostles, appears to have been Greek; and that St John wrote his gospel in that language, and not in Hebrew, is by no means a matter of surprise, since he wrote at Ephesus.

With respect to the epistle to the Romans, it may be asked indeed why St Paul did not write in Latin? Now, whoever proposes this question, must presuppose that St Paul was master of the Latin language in such a degree as to find no difficulty in writing it; a matter which remains to be proved. It is very probable that St Paul was acquainted with the Latin; but between understanding a language, and being able to write it, there is a very material difference. As St Paul was a native of Tarsus, his native language was Greek; he had travelled during several years through countries in which no other language was spoken, and when he addressed the Roman centurion at Jerusalem, he spoke not Latin, but Greek. Is it extraordinary, then, that in writing to the inhabitants of Rome he should have used a language which was there so generally understood? It has been long remarked, that Greek was at that time as well known in Rome as French in any court of modern Europe; that according to Juvenal even the female sex made use of Greek as the language of familiarity and passion; and that in letters of friendship Greek words and phrases were introduced with greater freedom than French expressions in German letters, as appears from Cicero's epistles to Atticus, and from those of Augustus preserved in the works of Suetonius. To this must be added a material circumstance, that a great part of the Roman Christians consisted of native Jews, who were better acquainted with Greek than with Latin, as either they themselves or their ancestors had come from Greece, Asia Minor, or Egypt, in which Greek was the language of the country. At least they read the Bible in that language, as no Latin translation of the Old Testament at that time existed; and the Christian church at that period consisting chiefly of Jews, the heathen converts in Rome were of course under the necessity of accustoming themselves to the Greek language. In short, St Paul in his epistle to the Romans made use of a language in which alone those who were ignorant of Hebrew could read the Bible. What has been here advanced respecting the

epistle to the Romans is equally applicable to the Greek of St Mark, on the supposition that it was written at Rome.

To the above arguments may be added the example of Josephus, who, as well as the apostles, was by birth a Jew. He even lived in Rome, which is more than can be said of St Paul and St Mark, who resided there only a certain time: he was likewise younger than either; he came to Italy at an age which is highly suitable to the learning of a language, and previous to that period had spent several years in the Roman camp. The Jewish antiquities, the history of the Jewish war, and the account of his own life, he wrote undoubtedly with a view of their being read by the Romans; and yet he composed all these writings in Greek. He expresses his motive for writing his Greek account of the Jewish war in the following terms: "That having written in his native language (i. e. the Hebrew dialect at that time spoken) a history of the war, in order that Partians, Babylonians, Arabians, Adiabenes, and the Jews beyond the Euphrates, might be informed of those events, he was now resolved to write for the Greeks and Romans, who had not been engaged in the campaigns, a more certain account than had hitherto been given." The motives which induced Josephus to write in Greek are fully as applicable to St Paul and St Mark.

Michaelis has thus characterized the style of the New Testament. "The New Testament (says he) was written in a language at that time common among the Jews, which may be named Hebraic Greek; the first traces of which we find in the translation of the LXX.

"Every man acquainted with the Greek language, who had never heard of the New Testament, must immediately perceive, on reading only a few lines, that the style is widely different from that of the classic authors. We find this character in all the books of the New Testament in a greater or less degree, but we must not therefore conclude that they possess an uniformity of style. The hardest Hebraisms, which extended even to grammatical errors in the government of cases, are the distinguishing marks of the book of Revelation; but they are accompanied with tokens of genius and poetical enthusiasm of which every reader must be sensible who has taste and feeling. There is no translation of it which is not read with pleasure even in the days of childhood; and the very faults of grammar are so happily placed as to produce an agreeable effect. The gospels of St Matthew and St Mark have strong marks of this Hebraic style; the former has harsher Hebraisms than the latter, the fault of which may be attributed to the Greek translator, who has made too literal a version, and yet the gospel of St Mark is written in worse language, and in a manner that is less agreeable. The epistles of St James and St Jude are somewhat better; but even these are full of Hebraisms, and betray in other respects a certain Hebrew tone. St Luke has in several passages written pure and classic Greek, of which the first four verses of his gospel may be given as an instance: in the sequel, where he describes the actions of Christ, he has very harsh Hebraisms, yet the style is more agreeable than that of St Matthew or St Mark. In the Acts of the apostles he is not free from Hebraisms, which he seems to have never studiously avoided; but his periods are more classically turned, and sometimes possess beauty

Michaelis, vol. i. chap. iv. sect. 1. p. 101.

Michaelis, vol. i. chap. ix. sect. 5. p. 111. 112 full of Hebraisms.

beauty devoid of art. St John has numerous, though not uncouth, Hebraisms both in his gospel and epistles; but he has written in a smooth and flowing language, and surpasses all the Jewish writers in the excellence of narrative. St Paul again is entirely different from them all; his style is indeed neglected and full of Hebraisms, but he has avoided the concise and verse-like construction of the Hebrew language, and has upon the whole a considerable share of the roundness of Grecian composition. It is evident that he was as perfectly acquainted with the Greek manner of expression as with the Hebrew, and he has introduced them alternately, as either the one or the other suggested itself the first, or was the best approved."

125
and fe-
reign id-
oms.

Michaelis has shown that the New Testament now only contains Hebraisms but Rabbinisms, Syriacisms, Chaldaisms, Arabisms, Latinisms, and Persian words, of which he has exhibited many specimens. To theologians, whose duty it certainly is to study the language of the New Testament with attention, we would strenuously recommend the perusal of this work, which in the English translation is one of the most valuable accessions to scriptural criticism that has yet appeared. We speak of the English translation, which the large and judicious notes of Mr Marsh has rendered infinitely superior to the original.

126
Peculiar-
ities in the
composi-
tion.

Dr Camp-
bell's *Prel-
iminary Dis-
course to his
Translation of the
Gospels.*

To the observations which have been made respecting the language of the New Testament, a few remarks may be added concerning the peculiarities of the style and manner of the sacred writers, particularly the historians. These remarks extend to the Old Testament as well as to the New.—The first quality for which the sacred history is remarkable is simplicity in the structure of the sentences. The first five verses of Genesis furnish an example, which consist of eleven sentences. The substantives are not attended by adjectives, nor the verbs by adverbs, no synonyms, no superlatives, no effort at expressing things in a bold, emphatical, or uncommon manner.

2. The second quality is simplicity of sentiment, particularly in the Pentateuch, arising from the very nature of the early and uncultivated state of society about which that book is conversant.

3. Simplicity of design. The subject of the narrative so engrosses the attention of the writer, that he himself is as nobody. He introduces nothing as from himself, no remarks, doubts, conjectures, or reasonings. Our Lord's biographers particularly excel in this quality. This quality of style we meet with in Xenophon and Cæsar.

The Evangelists may be ranked next to Genesis for simplicity of composition in the sentences. John and Matthew are distinguished for it more than Mark and Luke. But the sentiment is not so remarkable for simplicity in the Evangelists as the Pentateuch. The reasons of this difference are, the state of the Jews was totally changed; their manners, customs, &c. split into factions both in religion and politics. 2. The object of our Lord's ministry, which is the great subject of the gospels, was to inculcate a doctrine and morality with which some of their systems perfectly coincided; besides, being constantly copied by all the great men, the greater part of his history consists of instructions and discourses. 3. As it is occupied with what our Saviour said and what he did, this makes two distinctions of style

and manner; that of our Saviour, and the sacred penman's. In their own character, they neither explain nor command, promise nor threaten, praise nor blame. They generally omit the names of our Lord's enemies; thus directing our hatred at the vices they committed, not at the persons. They never mention such persons without necessity; which is the case with the high-priest, Pilate, Herod, and Judas: the three first for the chronology, the fourth to do justice to the eleven.

Herodias is indeed mentioned with dishonour; but her crime was a public one. On the other hand, all persons distinguished for any thing virtuous are carefully mentioned, Joseph of Arimathea, Nicodemus, Zaccheus, Bartimeus, Jairus, Lazarus, Mary, and Martha. They record their own faults (Peter's, Thomas's), nor do they make any merit of their confession. In one uniform strain they relate the most signal miracles and most ordinary facts.

From the narrative is excluded that quality of style which is called *animation*. Nothing that discovers passion in the writer or is calculated to excite the passions of the reader. Every thing is directed to mend the heart.

But in the discourses and dialogues of our Saviour the expression, without losing any thing of its simplicity, is often remarkable for spirit and energy. Respecting harmony and smoothness, qualities which only add an external polish to language, they had not the least solicitude.

As to elegance, there is an elegance which results from the use of such words as are most in use with those who are accounted fine writers, and from such arrangements in the words and clauses as have generally obtained their approbation. This is disclaimed by the sacred authors.

But there is an elegance of a superior order more nearly connected with the sentiment; and in this sort of elegance they are not deficient. In all the oriental languages great use is made of tropes, especially metaphors. When the metaphors employed bear a strong resemblance, they confer vivacity: if they be borrowed from objects which are naturally agreeable, beautiful, or attractive, they add also elegance. The Evangelists furnish us with many examples of this kind of vivacity and elegance. Our Lord borrows tropes from corn-fields, vineyards, gardens, &c.

As a valuable appendage to this part of our subject, ¹²⁷ *Proser me-* we shall subjoin Dr Campbell's method of studying the books of the New Testament. This we offer to our ¹²⁸ *the New* readers as a beautiful instance of the judicious applica- ¹²⁹ *Testament* tion of philosophy to sacred studies. It is the same by analysis method of discovering truth by analysis and induction, and induc- ¹³⁰ *tion.* which was pursued by Sir Isaac Newton with such astonishing success, which since his time has been uniformly practised in natural philosophy, and has been also applied to chemistry, to medicine, to natural history, and to the philosophy of mind, by the ingenious Dr Reid. This is the path of sound philosophy, which can alone lead to the discovery of truth. In following it, our progress may be slow, but it will be sure. If all theologians would readily adhere to it, we might then entertain the pleasing hope of discarding for ever those absurd systems of religion which are founded on single passages and detached fragments of scripture, and of establishing opinions and doctrines on a solid foundation.

Scripture.

128
Dr Campbell's method. *Practical Diss. to the Copists.*

" 1. To get acquainted with each writer's style; to observe his manner of composition, both in sentences and paragraphs; to remark the words and phrases peculiar to him, and the peculiar application that he may sometimes make of ordinary words; for there are few of those writers who have not their peculiarities in all the respects now mentioned. This acquaintance with each can be attained only by the frequent and attentive reading of his works in his own language.

" 2. To inquire into the character, the situation, and the office of the writer, the time, the place, and the occasion of his writing, and the people for whose immediate use he originally intended his work. Every one of these particulars will sometimes serve to elucidate expressions otherwise obscure or doubtful. This knowledge may in part be learned from a diligent and reiterated perusal of the book itself, and in part be gathered from what authentic, or at least probable, accounts have been transmitted to us concerning the complement of the canon.

" 3. The last general direction is, to consider the principal scope of the book, and the particulars chiefly observable in the method by which the writer has purposed to execute his design. This direction is particularly applicable to the epistolary writings, especially those of Paul.

" 4. If a particular word or phrase occur, which appears obscure, perhaps unintelligible, the first thing we ought to do, if satisfied that the reading is genuine, is to consult the context, to attend to the manner wherein the term is introduced, whether in a chain of reasoning or in a historical narration, in a description, or included in an exhortation or command. As the conclusion is inferred from the premises, or as from two or more known truths a third unknown or unproved before may fairly be deduced; so from such attention to the sentence in connection, the import of an expression, in itself obscure or ambiguous, will sometimes with moral certainty be discovered. This, however, will not always answer.

" 5. If it do not, let the second consideration be, whether the term or phrase be one of the writer's peculiarities. If so, it comes naturally to be inquired, what is the acceptance in which he employs it in other places? If the sense cannot be precisely the same in the passage under review, perhaps, by an easy and natural metaphor or other trope, the common acceptance may give rise to one which perfectly suits the passage in question.—Recourse to the other places wherein the word or phrase occurs in the same author is of considerable use, though the term should not be peculiar to him.

" 6. But thirdly, if there should be nothing in the same writer that can enlighten the place, let recourse be had to the parallel passages, if there be any such, in the other sacred writers. By parallel passages, I mean those places, if the difficulty occur in history, wherein the same or a similar story, miracle, or event, is related; if in teaching or restoring, those parts wherein the same argument or doctrine is treated, or the same parable propounded; and in moral lessons, those wherein the same class of duties is recommended; or, if the difficulty be found in a quotation from the Old Testament, let the parallel passage in the book referred to, both in the original Hebrew, and in the Greek version, be consulted.

Scripture.

" 7. But, if in these there be found nothing that can throw light on the expression or which we are in doubt, the fourth recourse is to all the places wherein the word or phrase occurs in the New Testament, and in the Septuagint version of the Old, adding to these the consideration of the import of the Hebrew or Chaldaic word, whose place it occupies, and the extent of signification, of which in different occurrences such Hebrew or Chaldaic term is susceptible.

" 8. Perhaps the term in question is one of those which very rarely occur in the New Testament, or those called *καὶ ἄλλοις*, only once read in Scripture, and not found at all in the translation of the Seventy. Several such words there are. There is then a necessity, in the fifth place, for recurring to the ordinary acceptance of the term in classical authors. This is one of those cases wherein the interpretation given by the earliest Greek fathers deserves particular notice. In this, however, I limit myself to those comments wherein they give a literal exposition of the sacred text, and do not run into vision and allegory.

The manuscripts of the New Testament are the natural sources from which the genuine readings of the Greek Testament are to be drawn. The printed editions are either copies of more ancient editions, or of manuscripts; and they have no further authority than as they correspond to the manuscripts from which they were originally taken. By manuscripts of the New Testament, we mean those only which were written before the invention of printing. The most ancient of these are lost, and there is no manuscript now extant older than the sixth century. Few contain the whole New Testament; some contain the four gospels; some the Acts of the Apostles and Epistles; and others the book of Revelation. The greatest number are those which contain the first part; those which have the second, or the first and second together, are likewise numerous; but those of the third are extremely few. It must be added also, that in many manuscripts those epistles are omitted whose divine authority was formerly doubted.

There are many manuscripts which have been examined only for a single text, such as John v. 7. or at least for a very small number. Others have been examined from the beginning to the end, but not completely and in respect of all the readings. A third class consists of such as either have been, or are said to have been, completely and accurately collated. But this requires such plegmatic patience, that we can hardly expect to find in critical catalogues all the various readings which have been only once collated. Wetstein, in collating many manuscripts anew, made discoveries which had entirely escaped the notice of his predecessors. The fourth class consists of such as have been completely and accurately collated more than once; but here also we are in danger of being led into error.—When various readings are transferred from one critical edition to another, as from that of Gregory to Mill's edition, and from the latter to those of Bergel and Wetstein, the manuscripts must sometimes be falsely named, and various readings must frequently be omitted. And as Wetstein has marked by cipher manuscripts that in former editions had been denoted by their initial letters, he could scarcely avoid substituting, in some cases, one figure instead of another. The fifth class, which is by far the most valuable, consists of such as

have

575, note.

have been printed word for word, and therefore form an original edition of the Greek Testament. We can boast but of a very few manuscripts of this kind. Hearne printed at Oxford, in 1715, the acts of the Apostles in Greek and Latin from the Codex Laudianus 3: Knittel has annexed to his edition of Ulpianus, p. 53—118, a copy of two very ancient fragments preserved in the library of Wolfenbützel; the one of the four Gospels in general, the other of St Luke and St John. Woidé printed in 1786 the Codex Alexandrinus, a manuscript of great antiquity, which shall afterwards be more fully described; and the University of Cambridge has resolved to publish, in a similar manner, the Cod. Cant. I. or, as it is sometimes called, the Codex Bezae, the care of which is intrusted to Dr Kipling, a publication which will be thankfully received by every friend to sacred criticism. It was the intention of the Abbé Spoletti, a few years ago, to publish the whole of the celebrated Codex Vaticanus; which would likewise have been a most valuable accession, since a more important manuscript is hardly to be found in all Europe. He delivered for this purpose a memorial to the pope; but the design was not put into execution, either because the pope refused his assent or the abbé abandoned it himself. See the Oriental Bible, vol. xxii. n.º 333. and vol. xxiii. n.º 348.

750
Michaelis's
proposal
of taking an
impression
of ancient
manuscripts,
vol. ii.
p. 152.

"A very valuable library," says Michaelis, "might be composed of the impressions of ancient manuscripts, which, though too expensive for a private person, should be admitted into every university collection, especially the Alexandrian and Cambridge manuscripts, to which I would add, if it were now possible to procure it, Hearne's edition of the Codex Laudianus 3. A plan of this sort could be executed only in England, by a private subscription, where a zeal is frequently displayed in literary undertakings that is unknown in other countries; and it were to be wished that the project were begun before length of time has rendered the manuscripts illegible, and the attempt therefore fruitless. Ten thousand pounds would go a great way towards the fulfilling of this request, if the learned themselves did not augment the difficulty of the undertaking, by adding their own critical remarks, and endeavouring thereby to recommend their publications, rather than by presenting to the public a faithful copy of the original. Should posterity be put in possession of faithful impressions of important manuscripts, an acquisition which would render the highest service to sacred criticism, all these editions of the New Testament should be regulated on the same plan as Hearne's edition of the Acts of the Apostles." It must be highly flattering to the patriotic spirit of an Englishman to hear the encomiums which learned foreigners have so profusely bestowed on our liberality in supporting works of genius and learning and public utility. The plan which Michaelis proposes

to us, in preference to all the other nations in Europe, is noble and magnificent, and would certainly confer immortality on those men who would give it their patronage and assistance.

There are many ancient manuscripts, especially in Italy, which have never been collated, but lie still unexplored. Here is a field where much remains to be done. See Marsh's Notes to Michaelis, vol. ii. p. 643.

Michaelis has given a catalogue of ancient manuscripts, amounting in number to 292, to which he has added a short account of each. In this place we shall confine our observations to the most celebrated, the Alexandrian and Vatican manuscripts, which we have chiefly extracted from Michaelis.

The *Alexandrian manuscript* consists of four volumes; the first three of which contain the Old Testament, the fourth the New Testament, together with the first Epistle of Clement to the Corinthians, and a fragment of the second. In the New Testament, which alone is the object of our present inquiry, is wanting the beginning as far as Matthew xxv. 6. *ὁ θυμὸς ἤρπυρας*; likewise from John vi. 50. to viii. 52. and from 2 Cor. iv. 13. to xii. 7. It must likewise be observed, that the Psalms are preceded by the epistle of Athanasius to Marcellinus, and followed by a catalogue, containing those which are to be used in prayer for each hour, both of the day and of the night; also by 14 hymns, partly apocryphal, partly biblical, the 11th of which is an hymn in praise of the Virgin Mary, entitled *προσῳδή μαρίας τῆς θεοτόκου*: further, the *Hypotheses Eusebii* are annexed to the Psalms, and his *Canones* to the Gospels. It is true, that this has no immediate reference to the New Testament, but may have influence in determining the antiquity of the manuscript itself.

131
Account of
the Alexan-
drian ma-
nuscript.

It has neither accents nor marks of aspiration; it is written with capital, or, as they are called, *uncial letters*, and has very few abbreviations. There are no intervals between the words; but the sense of a passage is sometimes terminated by a point, and sometimes by a vacant space. Here arises a suspicion that the copyist did not understand Greek, because these marks are sometimes found even in the middle of a word, for instance Levit. v. 4. *αυροπος η* for *αν σματος*; and Numb. xiii. 29. *μμ Υεπς*.

This manuscript was presented to Charles I. in 1628, by Cyrillus Lucaris patriarch of Constantinople. Cyrillus himself has given the following account; "We know so much of this manuscript of the holy writings of the Old and New Testament, that Thecla an Egyptian lady of distinction (*nobilis femina Ægyptia*) wrote it with her own hand 1300 years ago (A). She lived soon after the council of Nice. Her name was formerly at the end of the book; but when Christianity was subverted in Egypt by the errors of Mahomet, the books of the Christians suffered the same fate, and the name of

Thecla

(A) He wrote this in the year 1628. According to this account, then, the manuscript must have been written in 328: a date to which so many weighty objections may be made, that its most strenuous advocates will hardly undertake to defend it. But this error has furnished Oudin with an opportunity of producing many arguments against the antiquity of the *Codex Alexandrinus*, which seem to imply, that Grabe and others, who have referred it to the fourth century, suppose it to have been written in the above-mentioned year. Now it is probable, that the inference which has been deduced from the account of Cyrillus is more than he himself intended to express, as he relates that Thecla lived after the council of Nice.

Scripture. Thecla was expunged. But oral tradition of no very ancient date (*memoria et traditio recentis*) has preserved the remembrance of it.

But the reader will see that this account is merely traditional. Dr Semler very properly observes, that there is no more reason to rely on a tradition respecting the transcriber of an ancient manuscript, than on a tradition which relates to an ancient relic. The arguments which have been urged by Wettstein, Semler, Oudin, and Woide, to fix the date of this manuscript, are so many, that it would be tedious to repeat them. But, after all, its antiquity cannot be determined with certainty, though it appears from the formation of the letters, which resemble those of the fourth and fifth centuries, and the want of accents, that it was not written so late as the tenth century. In this century it was placed by Oudin, while Grabe and Schulze have referred it to the fourth, which is the very utmost period that can be allowed, because it contains the epistles of Athanasius. Wettstein, with more probability, has chosen a mean between these two extremes, and referred it to the fifth century: but we are not justified in drawing this inference from the formation of the letters alone, for it is well known that the same mode of forming the letters was retained longer in some countries and in some monasteries than in others.

We are now in possession of a perfect impression of this manuscript, which is accompanied with so complete and so critical a collection of various readings, as is hardly to be expected from the edition of any other manuscript. Dr Woide published it in 1786, with types cast for that purpose, line for line, without intervals between the words, as in the manuscript itself: the copy is so perfect a resemblance of the original, that it may supply its place. Its title is *Novum Testamentum Græcum e codice MS. Alexandrino qui Londini in Bibliotheca Musei Britannici asservatur descriptum*. It is a very splendid folio; and the preface of the learned editor contains an accurate description of the manuscript, with an exact list of all its various readings, that takes up no less than 87 pages; and each reading is accompanied with a remark, in which is given an account of what his predecessors Juninius, Walton, Fell, Mill, Grabe, and Wettstein, had performed or neglected.

The *Vatican manuscript* contained originally the whole Greek Bible, including both the Old and New Testament; and in this respect, as well as in regard to its antiquity, it resembles none so much as the *Codex Alexandrinus*, but no two manuscripts are more dissimilar in their readings, in the New Testament as well as in the Old. After the Gospels, which are placed in the usual order, come the Acts of the Apostles, which are immediately followed by the seven catholic epistles. This must be particularly noted, because some have contended that the second Epistle of St Peter, with the second and third of St John, were wanting. Professor Hwiid, in a letter dated Rome, April 12. 1781, assured Michaelis that he had seen them with his own eyes, that the second Epistle of St Peter is placed folio 1434, the second of St John fol. 1442, the third fol. 1443:

Vol. XIX. Part I.

then follow the Epistles of St Paul, but not in the usual order; for the Epistle to the Hebrews is placed immediately after those to the Thessalonians: and it is not improbable, that in the more ancient manuscript, from which the *Codex Vaticanus* was copied, this Epistle was even placed before that to the Ephesians, and immediately after the Epistle to the Galatians (E); for the Epistles of St Paul are divided into 93 sections by figures written in the margin with red ink; but the Epistle to the Galatians ends with 59, and that to the Ephesians begins with 70; the Epistle to the Hebrews, on the contrary, begins with 60, and ends with 69. With the words *ἀνατος τῶ θεῷ*, Heb. iv. 14. the manuscript ceases, the remaining leaves being lost. There is wanting, therefore, not only the latter part of this Epistle, but the Epistles to Timothy, Titus, and Philemon, with the Revelation of St John: but this last book, as well as the latter part of the Epistle to the Hebrews, has been supplied by a modern hand in the 15th century. In many places the faded letters have been also retouched by a modern, but careful hand; and when the person who made these amendments, who appears to have been a man of learning, found a reading in his own manuscript which differed from that of the *Codex Vaticanus*, he has noted it in the margin, and has generally left the text itself untouched, though in some few examples he has ventured to erase it.

It is certain, that this manuscript is of very high antiquity, though it has been disputed which of the two in this respect is entitled to the preference, the *Vaticanus* or *Alexandrinus*. The editors of the Roman edition of the Septuagint, in 1587, referred the date of the Vatican manuscript to the fourth century, the period to which the advocates for its great rival refer the *Codex Alexandrinus*. More moderate, and perhaps more accurate, are the sentiments of that great judge of antiquity Montfaucon, who, in his *Bibliotheca Bibliothecarum*, p. 3. refers it to the fifth or sixth century; and adds, that though he had seen other manuscripts of equal antiquity, he had found none at the same time so complete.

The *Codex Vaticanus* has a great resemblance to the manuscripts noted by Wettstein, C. D. L. 1. 13. 33. 69. 102. and to the Latin, Coptic, and Ethiopic versions; but it is preferable to most of them, in being almost entirely free from those undeniable interpolations and arbitrary corrections which are very frequently found in the above-mentioned manuscripts, especially in D. 1. and 69. It may be applied, therefore, as a mean not only of confirming their genuine readings, but of detecting and correcting those that are spurious. It is written with great accuracy, and is evidently a faithful copy of the more ancient manuscript from which it was transcribed. Peculiar readings, or such as are found neither in other manuscripts nor ancient versions, are seldom discovered in the *Codex Vaticanus*; and of the few which have been actually found, the greatest part are of little importance. But in proportion as the number of such readings is small, the number of those which are great; in support of which few only, though ancient

D authorities,

(*) Probably because the Epistle to the Hebrews, as well as the Epistle to the Galatians, relates to the abolition of the Mosaic law.

132
Account
of the Va-
tican ma-
nuscript.

Scripture authorities, have been hitherto produced: But this manuscript has not throughout the whole New Testament the same uniform text.

As we have now a beautiful printed edition of the Alexandrian manuscript by Dr Waide, it is much to be wished that we had also an exact impression of the Vatican manuscript. From the superstitious fears and intolerant spirit of the inquisition at Rome, all access to this manuscript was refused to the Abbé Spoletti, who presented a memorial for that purpose. Unless the pope interpose his authority, we must therefore despair of having our wishes gratified; but from the liberality of sentiment which the head of the Catholic church has shown on several occasions, we hope that the period is not far distant when the Vatican library will be open to the learned, and when the pope will think it his great honour to encourage their researches.

The most valuable editions of the Greek New Testament are those of Mill, Bengel, and Wettstein.

The edition of Mill, which was only finished 14 days before his death, occupied the attention of the author for 30 years.

The collections of various readings which had been made before the time of Mill, the Veleian, the Barberini, those of Stephens, the London Polyglot, and Fell's edition, with those which the Bishop had left in manuscript, and whatever he was able to procure elsewhere, he brought together into one large collection. He made likewise very considerable additions to it. He collated several original editions more accurately than had been done before: he procured extracts from Greek manuscripts which had never been collated; and of such as had been before collated, but not with sufficient attention, he obtained more complete extracts. It is said that he has collected from manuscripts, fathers, and versions, not fewer than 30,000 various readings. This collection, notwithstanding its many imperfections, and the superiority of that of Wettstein, is still absolutely necessary to every critic: for Wettstein has omitted a great number of readings which are to be found in Mill, especially those which are either taken from the Vulgate, or confirm its readings. Mill was indeed too much attached to this version; yet he cannot be accused of partiality in producing its evidence, because it is the duty of a critic to examine the witnesses on both sides of the question: and Wettstein, by too frequently neglecting the evidence in favour of the Vulgate, has rendered his collection less perfect than it would otherwise have been. He likewise added, as far as he was able, readings from the ancient versions; and is much to be commended for the great attention which he paid to the quotations of the fathers: the importance of which he had sagacity enough to discern.

It cannot, however, be denied, that Mill's Greek Testament has many imperfections, and some of real importance. His extracts from manuscripts often are not only incomplete, but erroneous; and it is frequently necessary to correct his mistakes from the edition of Wettstein. His extracts from the oriental versions are also imperfect, because he was unacquainted with these languages; and in selecting readings from the Syriac, the Arabic, and Ethiopic, he was obliged to have recourse to the Latin translations, which are annexed to those versions in the London Polyglot.

The great diligence which Mill had shown in collecting so many various readings, alarmed the clergy as if the Christian religion had been in danger of subversion. It gave occasion for a time to the triumphs of the deity, and exposed the author to many attacks. But it is now universally known, that not a single article of the Christian religion would be altered though a deity were allowed to select out of Mill's 30,000 readings whatever he should think most inimical to the Christian cause.

In 1734, Bengel abbot of Alpirsbach, in the duchy of Wurtemberg, published a new edition of the Greek Testament. The fears which Mill had excited began to subside on this new publication; for Bengel was universally esteemed a man of piety. Bengel was not only diligent in the examination of various readings, but in the strict sense of the word conscientious; for he considered it as an offence against the Deity, if, through his own fault, that is, through levity or carelessness, he introduced a false reading into the sacred text. His object was not merely to make a collection of readings, and leave the choice of them to the judgement of the reader, but to examine the evidence on both sides, and draw the inference; yet he has not given his own opinion so frequently as Mill, whom he resembled in his reverence for the Latin version, and in the preference which he gave to harsh and difficult readings, before those which were smooth and flowing. It may be observed in general, that he was a man of profound learning, and had a cool and sound judgement, though it did not prevent him from thinking too highly of the Latin readings, and of the *Codex Alexandrinus*, with other Latinizing manuscripts.

The imperfections of Bengel's edition arise chiefly from his diligence and caution. He did not venture to insert into the text any reading which had not already appeared in some printed edition, even though he believed it to be the genuine reading. In the book of Revelation indeed he took the liberty to insert readings which had never been printed; because few manuscripts had been used in the printing of that book.

The celebrated edition of John James Wettstein, and of Wetstein, which is the most important of all, and the most necessary to those engaged in sacred criticism, was published at Amsterdam in 1751 and 1752, in two volumes folio. No man will deny that Wettstein's *Prolegomena* discover profound erudition, critical penetration, and an intimate acquaintance with the Greek manuscripts. It is a work which in many respects has given a new turn to sacred criticism, and no man engaged in that study can dispense with it. Wherever Wettstein has delivered his sentiments respecting a Greek manuscript, which he has done less frequently than Mill, and indeed less frequently than we could have wished, he shows himself an experienced and sagacious critic. He is likewise more concise than Mill in delivering his opinion, and does not support it by producing so great a number of readings from the manuscript in question. This conciseness is the consequence of that warmth and haste which were peculiar to Wettstein's character, and which have sometimes given birth to mistakes. The fire of his disposition was likewise the cause of his advancing conjectures, in regard to the history of his manuscripts, which exceed the bounds of probability. But the critical

For text editions of the Greek New Testament are those of Mill.

154
Bengel,

155
Retin.

tical rules which he has delivered are perfectly just; and in this respect there is a remarkable agreement between him and his eminent predecessors Mill and Bengel. In regard to the Latin version alone they appear to differ: in Mill and Bengel it has powerful, and perhaps partial, advocates; but in Wettstein a severe and sagacious judge, who sometimes condemns it without a cause. The Greek manuscripts which confirm the readings of the Vulgate, and which he supposed had been corrupted from it, he of course condemned with equal severity: and some collections of various readings which had been made by Catholics, he made no scruple to pronounce a forgery, saying, "*Times Danais et dona ferentes.*" But in consequence of his animosity to the Vulgate, his collection of various readings is less perfect than it might have been.

It has been asked, 1. Whether he has quoted his manuscripts either fully or imperfectly, in order to establish his own religious opinions? or, 2. Whether his diligence and accuracy have been such that we may at all times depend upon them? To the first of these questions there can be no other answer, than that Wettstein, in his character of a critic, is perfectly honest. With respect to the second, his diligence and accuracy, Michaelis thinks there is less reason to pronounce him faultless. But Mr Marsh has examined the examples on which Michaelis founds his assertion, and declares that Michaelis is mistaken in every one of them.

The diligence of Wettstein can scarcely be questioned by any who are acquainted with his history. He travelled into different countries, and examined with his own eyes a much greater number of manuscripts than any of his predecessors. His collection of various readings amounts to *above a million*; and he has not only produced a much greater quantity of matter than his predecessors, but has likewise corrected their mistakes. The extracts from manuscripts, versions, and printed editions of the Greek Testament, which had been quoted by Mill, are generally quoted by Wettstein. Whenever Wettstein had no new extracts from the manuscripts quoted by Mill, or had no opportunity of examining them himself, he copied literally from Mill; but wherever Mill has quoted from printed editions, as from the margin of Robert Stephens's for instance, or from the London Polyglot, Wettstein did not copy from Mill, but went to the original source, as appears from his having corrected many mistakes in Mill's quotations.

In the opinion of Michaelis, there are many defects in the edition of Wettstein, which require to be supplied, and many errors to be corrected. Yet still it would be allowed to be a work of immense labour, and most valuable to those engaged in sacred criticism; and it is surprising, when we consider the difficulties and labour which Wettstein had to encounter, that his errors and imperfections are so few.

The proposal of Michaelis, however, of a new collection of manuscripts, in order to form a complete edition of various readings, is worthy the attention of the learned. In mentioning this proposal, Michaelis turns a wishful eye towards Britain, the only country, he says, which possesses the will and the means to execute the task. Should a resolution, he adds, be formed in this island, so happily situated for promoting the

purposes of general knowledge, to make the undertaking a public concern, to enter into a subscription, and to employ men of abilities in collating manuscripts both at home and abroad, they would be able to do more in ten years than could otherwise be done in a century. And could this nation direct its attention to any object more glorious or more useful than in ascertaining the text of the sacred Scriptures, and giving to posterity an accurate edition?

As the sense of Scripture, as well as all other books, is affected by the punctuation, it is of importance to determine whether the stops or points which we find in the sacred books were used by the sacred writers, or have been inserted by modern transcribers.

We are told by Montfaucou, in his *Paleographia Græca*, p. 31. that the person who first distinguished the several parts of a period in Greek writing, by the introduction of a point, was Aristophanes of Byzantium, who lived under Ptolemæus Epiphæmus, in the 14th Olympiad. But though points were not used in books before this period, they were employed in inscriptions above 400 years before the birth of Christ. See *Mont. Pal. Græc.* p. 135.

Under the article PUNCTUATION we mentioned, on authority which we reckoned unquestionable, that the ancient manuscripts were written without any points. We have now, however, discovered, from Woide's edition of the *Codex Alexandrinus*, that points are used in that manuscript, though omitted in the *Æc. Æmbe* given by Montfaucou. That they are found too in the *Codex Vaticanus*, though not frequently, is related by Birch in his *Prolegomena*, p. 14.

As the fact has not been generally known, that the ancients pointed their manuscripts, and as it is an important and interesting fact, we shall present our readers with the first six lines of St John's Gospel, as they are pointed in the Alexandrian manuscript:

ΕΝΑΡΧΗΗΝΟΛΟΓΟΕΚΑΙΟΛΟΓΟΣΗΝ
 ΠΡΟΣΤΟΝΘΝ ΚΑΙΘΕΗΝΟΛΟΓΟΣ·
 ΟΥΤΟΣΗΝΕΝΑΡΧΗΠΡΟΣΤΟΝΘΝ
 ΠΑΝΤΑΔΙΑΥΟΥΕΓΕΝΕΤΟ ΚΑΙΧΘ
 ΤΕΥΑΥΤΟΥΕΓΕΝΕΤΟΟΤΛΕΕΝ·
 ΟΥΕΓΟΝΕΝΑΥΤΩΖΩΗΗΝ·

Whether any points for marking the sense were used by the apostles, cannot be determined; but the points now in use have been invented since.

In the fourth century, Jerome began to add the comma and colon to the Latin version; and they were then inserted in many more ancient manuscripts. In the fifth century, Euthalius a deacon of Alexandria divided the New Testament into lines. This division was regulated by the sense, so that each line ended where some pause was to be made in speaking. And when a copyist was disposed to contract his space, and therefore crowded the lines into each other, he then placed a point where Euthalius had terminated the line. In the eighth century, the stroke was invented which we call a comma. In the Latin manuscripts, Jerome's points were introduced by Paul Warfried and Alcuin, at the command of Charlemagne. In the ninth century, the Greek note of interrogation (·) was first used. At the invention of printing, the editor placed the

Scripture. points arbitrarily, probably without bestowing the necessary attention; and Stephens, in particular, varied his points in every edition (D).

The meaning of many passages in the Scripture has been altered by false pointing. We shall produce one instance of this: Mat. v. 34. is commonly pointed in this manner, *οὐκ ἔστι θεὸς υἱός, μηδὲ υἱὸς θεοῦ; μαρτυρεῖτε τῷ θεῷ, ὡς ἐστὶν ὁ θεός.* "But I say unto you, swear not at all." But if, instead of the colon placed after *θεός*, we substitute a comma, the translation will be, "But I say to you that you ought by no means to swear, either by heaven, for it is his throne, or by earth, for it is his footstool." The command of Christ therefore applies particularly to the abuse of oaths among the Pharisees, who on every trivial occasion swore by the heaven, the earth, the temple, the head, &c. but it implies no prohibition to take an oath in the name of the Deity on solemn and important occasions.

137
Division into chapters.

The ancients divided the New Testament into two kinds of chapters, some longer and some shorter. This method appears to be more ancient than St Jerome, for he expunged a passage from the New Testament which makes an entire chapter. The longer kind of chapters were called *breves*, the shorter *capitula*. St Matthew contained, according to Jerome, 68 *breves*; Mark contained 48; Luke 83; and John 18. All the evangelists together consisted of 217 *breves* and 1126 *capitula*. The inventor of our modern division into chapters was Hugo de S. Caro, a French Dominican friar, who lived in the 13th century.

The ancients had two kinds of verses, one of which they called *εἰσοδοί*, and the other *εὐμακταί*. The *remata* were lines which contained a certain number of letters, like our printed books, and therefore often broke off in the middle of a word. Josephus's 20 books of Antiquities contained 60,000 of them, though in Ittiquis's edition there are only 40,000 broken lines.

Stichoi were lines measured by the sense: according to an ancient written list mentioned by Father Simin, there were in the New Testament 18,612 of these.

138
Division into verses.

The verses into which the New Testament is now divided are more modern, and an imitation of the division of the Old Testament. Robert Stephens, the first inventor, introduced them in his edition in the year

1551. He made this division on a journey from Lyons to Paris; and, as his son Henry tells us in the preface to the Concordance of the New Testament, he made it *inter equitandum*. This phrase probably means, that when he was weary of riding, he amused himself with this work at his inn.

139
Its disadvantages.

This invention of the learned printer was soon introduced into all the editions of the New Testament; and it must be confessed, that in consulting and quoting the Scriptures, and in framing concordances for them, a subdivision into minute parts is of the greatest utility. But all the purposes of utility could surely have been gained, without adopting the hasty and indigested division of Stephens, which often breaks the sense in pieces, renders plain passages obscure, and difficult passages unintelligible. To the injudicious division of Stephens we may ascribe a great part of the difficulties which attend the interpretation of the New Testament, and a great many of those absurd opinions which have disgraced the ages of the Reformation. For as separate verses appear to the eyes of the learned, and to the minds of the unlearned, as so many detached sentences, they have been supposed to contain complete sense, and they have accordingly been explained without any regard to the context, and often in direct opposition to it. Were any modern history or continued discourse divided into fragments with as little regard to the sense, we should soon find, that as many opposite meanings could be forced upon them as have been forced upon the books of the New Testament. The division into verses has been still more injurious to the Epistles than to the Gospels, for there is a close connection between the different parts of the Epistles, which the verses entirely dissolve. It is therefore to be wished that this division into verses were laid aside. The Scriptures ought to be divided into paragraphs, according to the sense; and the figures ought to be thrown into the margin. In this way, the figures will retain their utility without their disadvantages. Dr Campbell, in his beautiful translation of the Gospels, has adopted this method with great judgement and success; and he who will read that translation, will perceive that this single alteration renders the Gospels much more intelligible, and, we may add, more entertaining (E).

The word *ΕΥΑΓΓΕΛΙΟΝ* signifies any joyful tidings, Meaning of the word Gospel.

(D) The reader will perceive that the account of the origin of points is different from that given under PUNCTUATION. But the best authors differ upon this subject. We shall perhaps reconcile the difference, by supposing that points were invented at the time here mentioned, but were not in general use till the time mentioned under the article PUNCTUATION.

(E) We shall here subjoin, as a curiosity, what the anonymous author terms the *Old and New Testament dissected*. It contains an enumeration of all the books, chapters, verses, words, and letters, which occur in the English Bible and Apocrypha. It is said to have occupied three years of the author's life, and is a singular instance of the trifling employments to which superstition has led mankind.

The OLD and NEW TESTAMENT dissected.

	Books in the Old		in the New		Total		Apocryph.
Chapters	-	39	-	27	-	66	Chapters 183
Verfes	-	929	-	265	-	1194	Verfes 6081
Words	-	23,214	-	17959	-	41,173	Words 152,185
Letters	-	592,439	-	181,253	-	773,692	
	-	2,728,100	-	838,380	-	3,566,480	

The

Scripture. and exactly corresponds to our English word Gospel. In the New Testament this term is confined to "The glad tidings of the coming of the Messiah." Thus, in Mat. xi. 5, our Lord says, "The poor have the Gospel preached;" that is, The coming of the Messiah is preached to the poor. Hence the name of *Gospel* was given to the histories of Christ, in which the good news of the coming of the Messiah, with all its joyful circumstances, are recorded.

Gospel according to St. Matthew was composed, says Dr. Campbell, by one born a Jew, familiarly acquainted with the opinions, ceremonies, and customs of his countrymen; that it was compiled by one conversant in the sacred writings, and habituated to their idiom; a man of plain sense, but of little or no learning, except what he derived from the Scriptures of the Old Testament; and finally, that it was the production of a man who wrote from conviction, and had attended closely to the facts and speeches which he related, but who in writing entertained not the most distant view of setting off himself—we have as strong internal evidence as the nature of the thing will admit, and much stronger than that wherein the mind ninety-nine cases out of a hundred acquiesces.

It is authentic. The author of this history of our blessed Saviour was Matthew, appears from the testimony of the early Christians. It is attested by Jerome, Augustin, Epiphanius, and Chrysostom, and in such a manner as shews that they knew the fact to be uncontroverted, and judged it to be incontrovertible. Origen, who flourished in the former part of the 3d century, is also respectable authority. He is quoted by Eusebius in a chapter¹ wherein he specially treats of Origen's account of the sacred canon. "As I have learned (says Origen) by tradition concerning the four gospels, which alone are received without dispute by the whole church of God under heaven; the first was written by Matthew, once a publican, afterwards an apostle of Jesus Christ, who delivered it to the Jewish believers, composed in the Hebrew language." In another place he says, "Matthew writing for the Hebrews who expected him who was to descend from Abraham and David, says

the lineage of Jesus Christ, son of David, son of Abraham." It must be observed, that the Greek word *εὐαγγέλιον* does not exactly correspond to the English word *gospel*, which signifies any thing delivered orally from age to age. *εὐαγγέλιον* properly implies any thing transmitted from former ages, whether by oral or written testimony. In this acceptation we find it used in Scripture: "Hold the traditions *εὐαγγέλιον* which ye have been taught, *εὐαγγέλιον* most or our apostles." The next authority to which we shall have recourse is that of Irenæus bishop of Lyons, who had been a disciple of Polycarp. He says in the only book of his extant, that "Matthew, among the Hebrews, wrote a gospel in their own language, whilst Peter and Paul were preaching the gospel at Rome and founding the church there."

To the testimony of these writers it may be objected, that, except Irenæus, they all lived in the third and fourth centuries, and consequently their evidence is of little importance. But there is such unanimity in the testimony, that it must have been derived from some authentic source. And is it fair to question the veracity of respectable men merely because we knew not from what writings they received their information? Many books which were then extant are now lost; and how do we know but these might have contained sufficient evidence? Irenæus at least had the best opportunities of information, having been well acquainted in his youth with Polycarp, the disciple of John; no objection can therefore be made to his evidence. But we can quote an authority still nearer the times of the apostles. Papias bishop of Hierapolis, in Cesarea, who flourished about A. D. 116, affirms that Matthew wrote his gospel in the Hebrew tongue, which every one interpreted as he was able. Papias was the companion of Polycarp, and besides must have been acquainted with many persons who lived in the time of the apostles. The fact therefore is fully established, that Matthew, the apostle of our Saviour, was the author of that gospel which is placed first in our editions of the New Testament.

The next subject of inquiry respects the language in which

The middle Chapter and the least in the Bible is Psalm 117.
The middle Verse is the 8th of the 118th Psalm.
The middle time is the 2d of Chronicles, 4th Chap. 16th Verse.
The word *And* occurs in the Old Testament 35,543 times.
The same in the New Testament occurs 12,684 times.
The word *Jehovah* occurs 6355 times.

OLD TESTAMENT.

The middle Book is Proverbs.
The middle Chapter is Job 29th.
The middle Verse is 2d Chron. 25th Chap. between 17th and 18th Verses.
The least Verse is 1 Chron. 11th Chap. and 11th Verse.

NEW TESTAMENT.

The middle Book is Theſſalonians 2d.
The middle Chapter is between the 13th and 14th Romans.
The middle Verse is 17th Chap. Act. 17th Verse.
The least Verse is 11th Chap. John, Verse 35.
The 21st Verse of the 7th Chapter of Ezra has all the letters of the alphabet.
The 19th Chapter of 2d Kings and 37th of Isaiah are alike.

S. 170.

143
L. 10. 11
in which
it was writ-
ten.

which it was written. This we are assured by Papias, by Irenæus, and Origen, was the Hebrew; but the truth of this fact has been disputed by Erasmus, Whitby, and others. Whitby urges the improbability that Providence would have suffered the original of this gospel to be lost, and nothing to remain but a translation. This is an argument of no force against written testimony; indeed we are always in danger of drawing false conclusions when we argue from our own opinions of the conduct of Providence: *For His ways are not as our ways, nor His thoughts as our thoughts.* But though we are forced to acknowledge that the gospel according to Matthew which we possess is a translation, it is evidently a close one; and the very circumstance that it has superseded the original, is a clear proof that it was thought equally valuable by the ancient Christians. It is necessary to remark, that the language in which the gospel according to Matthew was originally composed, and which is called Hebrew by Papias, Irenæus, and Origen, is not the same with the Hebrew of the Old Testament: it was what Jerome very properly terms Syro-Chaldaic, having an affinity to both languages, but much more to the Chaldean than to the Syriac.

144
D. 10.
The time when this gospel was composed has not been precisely ascertained by the learned. Irenæus says that "Matthew published his gospel when Peter and Paul were preaching at Rome." Now Paul arrived at Rome A. D. 62 or 61, and it is very probable his martyrdom in A. D. 65. This may be justly concluded from comparing the relation of Tacitus with that of Orosius, a writer of the fifth century. Orosius having given an account of Nero's persecution of the Christians, and of the death of the two apostles in it, adds, that it was followed by a pestilence in the city, and other disasters. And Tacitus relates that a pestilence prevailed in the city, and violent storms took place in Italy, in the year of Christ 65. Matthew's gospel was therefore written between the year 60 and 65.

145
and design
it.
The Cambridge
1701 P.
1700 B.
Matthew's
C. 14.
That this history was primarily intended for the use of the Jews, we have, besides historical evidence, very strong presumptions from the book itself. Every circumstance is carefully pointed out which might conciliate the faith of that nation; every unnecessary expression is avoided, which might in any way serve to obstruct it. To come to particulars, there was no sentiment relating to the Messiah which the Jews were more strongly possessed, than that he must be of the race of Abraham, and of the family of David. Matthew, therefore, with great propriety, begins his narrative with the genealogy of Jesus. That he should be born at Bethlehem in Judæa, is another circumstance in which the Jews were universally agreed. His birth in that city, with some very memorable circumstances that attended it, this historian has also taken the first opportunity to mention. Those passages in the prophets, or other sacred books, which either foretell any thing that should happen to him, or admit an allusive application, or were in that age generally understood to be applicable to events which respect the Messiah, are never passed over in silence by this Evangelist. The fulfilment of prophecy was always to the Jews, who were convinced of the insipitation of their sacred writings, strong evidence. Accordingly none of the Evan-

gels has been more careful than Matthew, that nothing of this kind should be overlooked.

That which chiefly distinguishes Matthew's writings from those of the other Evangelists, is the minute and distinct manner in which he has related many of our Lord's discourses and moral instructions. Of these his sermon on the mount, his charge to the apostles, his illustrations of the nature of his kingdom, and his prophecy on Mount Olivet, are examples. He has also wonderfully united simplicity and energy in relating the replies of his master to the cavils of his adversaries. Being early called to the apostleship, he was an eye and ear witness of most of the things which he relates. And there are circumstances which incline Dr Campbell to think that Matthew has approached as near the precise order of time in which the events happened as any of the Evangelists.

Concerning the life of the apostle Matthew we have nothing to add, as the principal circumstances in his life have already been mentioned. See MATTHEW.

The Gospel according to Matthew is cited seven times in the epistle of Barnabas, twice in the first epistle of Clement Romanus to the Corinthians, eight times in the Shepherd of Hermas, six times in Polycarp's small epistle to the Philippians, and seven times in the smaller epistles of Ignatius. These citations may be seen at full length in *Jones's New and Full Method of settling the Canon*, with the parallel passages in the gospel according to Matthew.

That Mark was the author of the gospel which bears his name, and that it was the second in the order of writing to time, is proved by the unanimous testimony of the ancient Christians. Many authorities are therefore unnecessary; we shall only mention those of Papias and Irenæus. Eusebius has preserved the following passage of Papias: "This is what was related by the elder (that is, John, not the apostle, but a disciple of Jesus); Mark being Peter's interpreter wrote exactly whatever he remembered, not indeed in the order wherein things were spoken and done by the Lord: for he was not himself a hearer or follower of our Lord: but he afterwards, as I said, followed Peter who gave instructions as suited the occasions, but not as a regular history of our Lord's teaching. Mark, however, committed no mistake in writing such things as occurred to his memory: for of this one thing he was careful, to omit nothing which he had heard, and to insert no falsehood into his narrative." Such is the testimony of Papias, which is the more to be regarded as he aligns his authority. He spoke not from hearsay, but from the information which he had received from a most credible witness, John the elder, or presbyter, a disciple of Jesus, and a companion of the apostles.

Irenæus, after telling us that Matthew published his gospel whilst Peter and Paul were preaching at Rome, adds: "After their departure (*ἀφ᾽ ἑσθῶν*), Mark also, the disciple and interpreter of Peter, delivered to us in writing the things which had been preached by Peter." The Greek *ἀφ᾽ ἑσθῶν*, like the English word *departure*, may either denote death, which is a departure out of the world, or mean a departure out of the city. It is probably in the former of these senses it is here used. Yet by the accounts given by some others, Mark's gospel was published in Peter's lifetime, and had his approbation.

S. 170.

146
O. 10. 11
in which
it was writ-
ten.147
O. 10. 11
in which
it was writ-
ten.148
O. 10. 11
in which
it was writ-
ten.149
O. 10. 11
in which
it was writ-
ten.150
O. 10. 11
in which
it was writ-
ten.151
O. 10. 11
in which
it was writ-
ten.152
O. 10. 11
in which
it was writ-
ten.153
O. 10. 11
in which
it was writ-
ten.154
O. 10. 11
in which
it was writ-
ten.155
O. 10. 11
in which
it was writ-
ten.

Scripture. approbation. The gospel of Mark is supposed to be but two years posterior in date to that of Matthew. The precise year, however, cannot be determined with certainty; and it is a matter of no importance, since we have ascertained the author and the time in which he lived.

Preface to Mark

1st Pet v.

13. 190 Language in which it was written.

1st Design of it.

Dr Campbell's Preface to Mark's Gospel.

Mark not the abridger of Matthew.

Mark has generally been supposed to be the same person who is mentioned in the acts and some of Paul's epistles, who is called John, and was the nephew of Barnabas. But as this person was the attendant of Paul and Barnabas, and is nowhere in scripture said to have accompanied Peter in his apostolical mission, which ancient writers inform us the author of the gospel did, Dr Campbell has fully concluded that there was a different person. The author of the gospel is certainly meant by Peter when he says *Marcus my son Salutate* 2 Pet. 3.

That Mark wrote his gospel in Greek, is as evidently conformable to the testimony of antiquity, as that Matthew wrote his in Hebrew or Syro Chaldaic. The cardinals Baronius and Bellarmine, anxious to exalt the language in which the vulgate was written, have maintained that this Evangelist published his work in Latin. The only appearance of testimony which has been produced in support of this opinion is the inscription subjoined to this gospel in Syria, and in some other oriental versions. But these p^osscripts are not the testimonies of the translators: they proceed from the conjecture of some transcribers; but when written, or by whom, is equally unknown. Against positive testimony therefore they are entitled to no credit.

From the Hebrews in the style, we should readily conclude that the author was by birth and education a Jew. There are also expressions which show that he had lived for some time among the Latins, as *κιστριον* "centurion," and *στρατομαχος*, "soldier," words which do not occur in the other gospels. There are other internal evidences that this gospel was written beyond the confines of Judea. The first time the Jordan is mentioned, *ποταμος*, "river," is added to the name for explanation; for though no person in Judea needed to be informed that Jordan was a river, the case was different in distant countries. The word *Γολγοθα*, which is translated *Hell* in the New Testament, originally signified the *Valley of Hinnom*, where infants had been sacrificed by fire to Molech, and where a continual fire was afterwards kept up to consume the filth of Jerusalem. As this word could not have been understood by a foreigner, the Evangelist adds, by way of explanation, *αγο το αντρος*, "the unquenchable fire." Instead of the word *Μαμμωα*, he uses the common term *γενεα* "riches." When he employs the oriental word *Καβου*, he subjoins the interpretation *δωρεαν*, "that is, a gift." These peculiarities will corroborate the historical evidence that has been already mentioned, that Mark intended his gospel for the use of the Gentiles.

It has been affirmed that this evangelist is the abridger of Matthew. It is true that Mark sometimes copies the expressions used by Matthew; but he is not to be considered as a mere abridger, for he omits altogether several things related by Matthew, viz. our Lord's pedigree, his birth, the visit of the Magians, Joseph's flight into Egypt, and the cruelty of Herod. Dr Lardner has given a list of thirty-three passages, where-

in circumst^{ances} are related which are omitted by the other evangelists. There is no comparable, and an account of two miracles peculiar to Mark. The parable of similitude mentioned in chap. iv. 26. One of these miracles was the curing of a deaf and dumb man, chap. vii. 31, 37. The other was the giving sight to a blind man at Bethsaida, chap. viii. 22, 26. The style of Mark, instead of being more concise than that of Matthew, is more diffuse. That he had read Matthew's gospel cannot be doubted, but that he abridged it, is a mistake.

According to the testimony which has been already produced, Mark derived his information from the apostle Peter. It would be improper, therefore, not to remark, that this evangelist has omitted many things tending to Peter's honour, which are related in the other gospels, and has given the most particular account of Peter's fall. This gospel is seven times cited by Irenaeus, and nine times by Tertullian.

That the author of the gospel which is the third in order was Luke, the companion of the apostle Paul, is evident from the testimonies of Irenaeus, Clemens of Alexandria, Origen, Tertullian, and many succeeding writers. But it has been disputed whether he was a Jew or a Gentile. That Luke was a Jew by birth, or at least by religion, may be argued from his being a constant companion of Paul. If he had been an uncircumcised Gentile, exceptions would have been made to him, especially at Jerusalem; but nothing of that kind appears. It is also rendered highly probable, from his mode of computing time by the Jewish festivals, and from his frequent use of the Hebrew idiom. It has been supposed that Luke was one of the 70 disciples; but he does not pretend to have been a witness of our Lord's miracles and teaching; on the contrary, he tells us in his introduction, that he received his information from others.

The design of Luke in writing his gospel was to furnish some imperfect and inaccurate histories of our Saviour, which had then been published. What these were, it is impossible now to determine, as they are not mentioned by any contemporary writer, and probably did not survive the age in which they were composed.

It has been supposed that Luke chiefly derived his information from the apostle Paul, whom he faithfully attended in his travels; but, from Luke's own words, we are led to conclude, that the principal source of his intelligence, as to the facts related in the gospel, was from those who had been eye and ear witnesses of what our Lord both did and taught. Now Paul evidently was not of this number. It was from conversing with some of the twelve apostles or disciples of our Lord, who heard his discourses and saw his miracles, that he obtained his information.

As to the time when this gospel was written, we have hardly any thing but conjecture to guide us. But as Origen, Eusebius, and Jerome, have ranged it after those of Matthew and Mark; we have no reason to doubt but they were written in the same order.

The gospel by Luke has supplied us with many interesting particulars which had been omitted both by Matthew and Mark. It has given a distinct narration of the circumstances attending the birth of John the Baptist and the nativity of our Saviour. It has given

Scripture.

Scripture.

an account of several memorable incidents and cures which had been overlooked by the rest; the conversion of Zacheus the publican; the cure of the woman who had been bowed down for 18 years; the cure of the dropsical man; the cleansing of the ten lepers; the inhospitable treatment of our Saviour by the Samaritans, and the instructive rebuke which he gave on that occasion to two of his disciples for their intemperate zeal; also the affecting interview which he had after his resurrection with two of his disciples. Luke has also added many edifying parables to those which the other evangelists had recorded. Most of these are specified by Ireneus as particularly belonging to this gospel, and has thereby shewn to us, without intending it, that the gospel of Luke was the same in his time that it is at present.

many marks of distinction which were not conferred on the other disciples. He possessed a high degree of intrepidity and zeal, a warm and affectionate heart, and was strongly attached to his master. His brother James and he were honoured with the title of Boanerges, or *Sons of Thunder*. He was anxious to refrain whatever he considered as a mark of disrespect against his master, and to punish his enemies with severity. He was incensed against some persons for attempting to cast out demons in the name of Jesus; and required them to desist because they were not his disciples. James and he proposed to our Saviour to call down fire from heaven to punish the inhospitable Samaritans. Nor was the courage of John less ardent than his zeal. When Peter had disowned his Lord, and all the other disciples had fled, John continued to attend his master. He was present at his trial, and followed him to the cross, where he was a spectator of his sufferings and death. The interview between Jesus and this disciple at Calvary, though concisely related, is an event which will strongly affect every man of feeling, while it convinces him of the unalterable affection of Jesus to his beloved disciple, as well as discovers his respectful tenderness for his mother. See JOHN.

Dr Campbell's Preface to Luke's Gospel.

158 Style and composition of it.

The style of this evangelist abounds as much with Hebraisms as any of the sacred writings, but it contains more of the Grecian idiom than any of them. It is also distinguished by greater variety and copiousness; qualities which may be justly ascribed to the superior learning of the author. His occupation as a physician would naturally induce him to employ some time in reading, and give him easier access to the company of the great than any of the other evangelists. As an instance of Luke's copiousness, Dr Campbell has remarked that each of the evangelists has a number of words which are used by none of the rest; but in Luke's gospel the number of such peculiarities or words, used in none of the other gospels, is greater than that of the peculiar words found in all the three other gospels put together; and that the terms peculiar to Luke are for the most part long and compound words. The same judicious writer has also observed, that there is more of composition in Luke's sentences than is found in the other three, and consequently less simplicity. Of this the very first sentence is an example, which occupies no less than four verses. Luke, too, has a greater resemblance to other historians, in giving what may be called his own verdict in the narrative part of this work; a freedom which the other evangelists have seldom or never ventured to use. He calls the Pharisees *lovers of money*; in distinguishing Judas Iscariot from the other Judas, he uses the phrase, *he who proved a traitor, (ὁ καὶ ἔσσυτο πρεβόρος)*. Matthew and Mark express the same sentiment in milder language, "he who delivered him up." In recording the moral instructions of our Lord, especially his parables, this evangelist has united an affecting sweetness of manner with genuine simplicity.

161 Motives for writing it.

Chap. xvi. 24.

This gospel is frequently cited by Clemens Romanus, the contemporary of the Apostles, by Ignatius and Justin Martyr. Ireneus has made above a hundred citations from it. In his lib. iii. *adv. Hæres.* c. 14. he vindicates the authority and perfection of Luke's gospel, and has produced a collection of those facts which are only recorded by this evangelist.

159 Cited by ancient Christian authors.

The ancients inform us, that there were two motives which induced John to write his gospel: the one, that he might refute the heresies of Cerinthus and the Nicolaitans, who had attempted to corrupt the Christian doctrine; the other motive was, that he might supply those important events in the life of our Saviour which the other evangelists had omitted. Of the former of these motives Ireneus gives us the following account: "John, desirous to extirpate the errors sown in the minds of men by Cerinthus, and some time before by those called Nicolaitans, published his gospel; wherein he acquaints us that there is one God, who made all things by his word, and not, as they say, one who is the Creator of the world, and another who is the father of the Lord; one the son of the Creator, and another the Christ, from the supercelestial abodes who descended upon Jesus, the son of the Creator, but remained impassible, and afterwards fled back into his own pleroma or fulness." As Ireneus is the most ancient author who has written upon this subject, many appeals have been made to his authority. The authority of Ireneus is certainly respectable, and we have often referred to his testimony with confidence; but we think it necessary to make a distinction between receiving his testimony to a matter of fact, and implicitly adopting his opinion. He does not tell us, that he derived his information from any preceding writer, or indeed from any person at all. Nay, he seems to have believed that John wrote against these heresies by a prophetic spirit; for he says in another place, chap. xx. 32. "As John the disciple of our Lord assures us, saying, But these are written, that ye might believe that Jesus is the Christ, the Son of God, and that believing ye might have life through his name: *FORESEEING these blasphemous notions that divide the Lord, so far as it is in their power.*"

162 Not to conclude here-tics.

160 Gospel according to John.

That the gospel which is placed last in our editions of the New Testament was written by John, one of our Saviour's apostles, is confirmed by the unanimous testimony of the ancient Christians. He was the son of Zebedee, a fisherman of Bethsaida in Galilee, by his wife Salome, and the brother of James, surnamed the elder or greater. He was the beloved disciple of our Saviour, and was honoured, along with Peter and James, with

Indeed it seems very improbable that an apostle should write a history of our Lord on purpose to confute the wild opinions of Cerinthus or any other heretic. Had John considered such a consultation necessary, it is more likely that he would have introduced it into

Scripture. into an epistle than blended it with the actions of his venerable Master. But were the opinion of Irenæus well-founded, we should surely discover some traces of it in the gospel of John; yet except in the introduction, there is nothing that can with the least shadow of probability be applied to the opinions of Cerinthus; and few, we presume, will affirm, that the gospel of John was composed merely for the sake of the first eighteen verses.

164
But to prove that John was the Messiah, the Son of God.

The intention of John in writing his gospel was far more extensive and important than to refute the opinions of a few men who were to sink into oblivion in the course of a few centuries. It was evidently (according to the opinion of Clement of Alexandria) to supply the omissions of the other evangelists: It was to exhibit the evidences of the Christian religion in a distinct and perspicuous manner: It was, as he himself in the conclusion of his gospel affures us, to convince his readers, that Jesus is the Messiah, the Son of God, and that believing they might have life through his name.*

* John xv. 31.

Now it will appear to any person who reads this gospel with attention, that he has executed his plan with astonishing ability, and has given the most circumstantial and satisfactory evidence that Jesus was the Messiah the Son of God. After declaring the pre-existence of Jesus, he proceeds to deliver the testimony of John the Baptist, and selects some of the greatest miracles of Jesus to prove his divine mission. In the fifth chapter he presents us with a discourse which our Saviour delivered in the temple in the presence of the Jews, wherein he states in a very distinct manner the proofs of his mission from, 1. The testimony of John; 2. His own miracles; 3. The declaration of the Father at his baptism; 4. The Jewish Scriptures. Indeed the conclusion that Jesus was the Messiah the Son of God, naturally arises from almost every miracle which our Saviour is said to have performed, and from every discourse that he delivered. This declaration is very often made by our Saviour himself; particularly to the woman of Samaria, to Nicodemus, and to the blind man whom he had cured.

164
Is a supplement to the other three gospels.

It must be evident to every reader, that John studiously passes over those passages in our Lord's history and teaching which had been treated at large by the other evangelists, or, if he mentions them at all, he mentions them slightly. This confirms the testimony of ancient writers, that the first three gospels were written and published before John composed his gospel. Except the relation of our Saviour's trial, death, and resurrection, almost every thing which occurs in this book is new. The account of our Saviour's nativity, of his baptism, and of his temptation in the wilderness, is omitted; nor is any notice taken of the calling of the twelve apostles, or of their mission during our Saviour's life. It is remarkable, too, that not one parable is mentioned, nor any of the predictions relating to the destruction of Jerusalem. All the miracles re-

corded by the other evangelists are passed over, except the miraculous supply of provisions, by which five thousand were fed: and it is probable that this miracle was related for the sake of the discourse to which it gave birth. The other miracles which are mentioned are few in number, but in general they are minutely detailed. They consist of these: the turning of water into wine at Cana; the cure of the diseased man at the pool of Bethesda; the cure of the man that had been blind from his birth; the restoring of Lazarus to life; and the healing of the servant's ear which Peter had cut off. But valuable would this gospel be, though it had only recorded the consolation of Jesus to his disciples previous to his departure; which exhibits a most admirable view of our Saviour's character, of his care and tender regard for his disciples. Having opened every source of comfort to their desponding minds; exhorted them to mutual love, and to the obedience of his Father's precepts; having warned them of the impending dangers and sorrows—our Saviour concludes with a prayer, in the true spirit of piety and benevolence; ardent without enthusiasm, sober and rational without lukewarmness.

165
Time at which it was written.

The time in which this gospel was written has not been fixed with any precision. Irenæus informs us, that it was written at Ephesus, but leaves us to conjecture whether it was written before or after John's return from Patmos. He was banished to Patmos by Domitian, who reigned 15 years, and according to the best computation died A. D. 96. The persecution which occasioned the exile of John commenced in the 14th year of Domitian's reign. If John wrote his gospel after his return to Ephesus, which is affirmed by Epiphanius to have been the case, we may fix the date of it about the year 97 (†).

166
Style of it.

This gospel is evidently the production of an illiterate Jew, and its style is remarkable for simplicity. It abounds more with Hebraisms than any of the other gospels; and contains some strong oriental figures which are not readily understood by an European.

167
Often quoted by ancient Christians.

This gospel is cited once by Clemens Romanus, by Barnabas three times, by Ignatius five times, by Justin Martyr six times, by Irenæus, and above forty times by Clemens Alexandrinus.

168
Acts of the Apostles.

The book which we intitle the Acts of the Apostles connects the gospels and the epistles. It is evidently a continuation of Luke's gospel, which appears both from the introduction and from the attestations of ancient Christians. Both are dedicated to Theophilus; and in the beginning of the Acts a reference is made to his gospel, which he calls a former treatise, recording the actions and discourses of Jesus till his ascension to heaven. Luke is mentioned as the author of the Acts of the Apostles by Irenæus, by Tertullian, by Origen, and Eusebius.

From the frequent use of the first person plural, it is manifest that Luke the author was present at many of the

(†) It has been argued from a passage in this gospel, that it must have been written before the destruction of Jerusalem. In speaking of the pool of Bethesda, John uses the present tense: His words are, "There is at Jerusalem." Now, if these words had been written after the destruction of Jerusalem, it is urged the past tense would have been used, and not the present. This argument is more specious than forcible. Though Jerusalem was demolished, does it follow that the pool of Bethesda was dried up?

Scripture. the transactions which he relates. He appears to have accompanied Paul from Troas to Philippi. He attended him also to Jerusalem, and afterwards to Rome, where he remained for two years. He is mentioned by Paul in several of those epistles which were written from Rome, particularly in the 2d epistle to Timothy, and in the epistle to Philemon.

This book contains the history of the Christian church for the space of about 28 or 30 years, from the time of our Saviour's ascension to Paul's arrival at Rome in the year 60 or 61. As it informs us that Paul resided two years in Rome, it must have been written after the year 63; and as the death of Paul is not mentioned, it is probable it was composed before that event, which happened A. D. 65.

The Acts of the Apostles may be divided into seven parts. 1. The account of our Saviour's ascension, and of the occurrences which happened on the first Pentecost after that event, contained in chap. i. ii. 2. The transactions of the Christians of the circumcision at Jerusalem, in Judea, and Samaria, chap. iii.—ix. xi. 1.—21. xii. 3. Transactions in Cæsaræa, and the admission of the Gentiles, chap. x. 4. The first circuit of Barnabas and Paul among the Gentiles, chap. xi. 22. xiii. xiv. 5. Embassy to Jerusalem, and the first council held in that city, chap. xv. 6. Paul's second journey, chap. xvi.—xxi. 7. His arduous trial, appeal to Cæsar, and journey to Rome, chap. xxi. to the end of the book.

The Acts of Apostles are cited by Clemens Romanus, by Polycarp, by Justin Martyr, thirty times by Irenæus, and seven times by Clemens Alexandrinus.

All the essential doctrines and precepts of the Christian religion were certainly taught by our Saviour himself, and are contained in the gospels. The epistles may be considered as commentaries on the doctrines of the gospel, addressed to particular societies, accommodated to their respective situations; intended to refute the errors and false notions which prevailed among them, and to inculcate those virtues in which they were most deficient.

The plan on which these LETTERS are written is, first, to decide the controversy, or refute the erroneous notions which had arisen in the society to which the epistle was addressed: And, secondly, to recommend those duties which their false doctrines might induce them to neglect; at the same time inculcating in general exhortations the most important precepts of Christian morality.

Of the epistles fourteen were written by St Paul. These are not placed according to the order of time in which they were composed, but according to the supposed precedence of the societies or persons to whom they were addressed. It will be proper therefore to exhibit here their chronological order according to Dr Lardner.

A TABLE of ST PAUL'S EPISTLES, with the Places where, and times when, written, according to Dr Lardner.

Epistle.	Places.	A. D.
1 Theſſalonians	Corinth	52
2 Theſſalonians	Corinth	52
Gaſtians	{ Corinth or Ephesus }	{ near the end of or beginning of 53

Epistle.	Places.	A. D.	Scripture.
1 Corinthians	Ephesus	the beginning of	53
1 Timothy	Macedonia		56
Titus	{ Macedonia or near it }	}	bef. the end of 56
	Macedonia		about October 57
2 Corinthians	Corinth		about February 58
Romans	Rome		about April 61
Ephesians	Rome		about May 61
2 Timothy	Rome		bef. the end of 62
Philippians	Rome		bef. the end of 62
Coloſſians	Rome		bef. the end of 62
Philemon	Rome		bef. the end of 62
Hebrews	{ Rome or Italy }	}	in Spring of 63

A TABLE of the CATHOLIC EPISTLES, and the REVELATION, according to Dr Lardner.

Epistle.	Place.	A. D.	
James	Judea	{ or beg. of 61 62	
The two Epistles of Peter	Rome	64	
1 John	Ephesus	about 80	
2d and 3d of John	Ephesus	{ between 80 and 90	
Jude	Unknown	64 or 65	
Revelation	{ Patmos or Ephesus }	}	95 or 96

It is more difficult to understand the epistolary writings than the gospels; the cause of which is evident. Many things are omitted in a letter, or slightly mentioned, because supposed to be known by the person to whom it is addressed. To a stranger this will create much difficulty. The business about which St Paul wrote was certainly well known to his correspondents; but at this distance of time we can obtain no information concerning the occasion of his writing, of the character and circumstances of those persons for whom his letters were intended, except what can be gleaned from the writings themselves. It is no wonder, therefore, though many allusions should be obscure. Besides, it is evident from many passages that he answers letters and questions which his correspondents had sent him. If these had been preserved, they would have thrown more light upon many things than all the notes and conjectures of the commentators.

The causes of obscurity which have been now mentioned are common to all the writers of the epistles; but there are some peculiar to St Paul. 1. As he had an acute and fertile mind, he seems to have written with great rapidity, and without attending much to the common rules of method and arrangement. To this cause we may ascribe his numerous and long parentheses. In the heat of argument he sometimes breaks off abruptly to follow out some new thought; and when he has exhausted it, he returns from his digression without informing his readers; so that it requires great attention to retain the connection. 2. His frequent change of person, too, creates ambiguity: by the pronoun I he sometimes means himself; sometimes any Christian; sometimes a few, and sometimes any man. In using the pronoun we; he sometimes intends himself; sometimes comprehends his companions; sometimes the apostles;

169
contents
of that
book.

170
Often cited
by the ear
of Christi-
ans.

171
The epist-
les.

172
General
of the
book.

173
Arranged
in chrono-
logical or-
der.

174
Causes of
their obscu-
rity.

175
Causes of
obscurity
peculiar to
St Paul's
epistles.

Scriptures. tles; at one time he alludes to the converted Jews, at another time to the converted Gentiles. 3. There is a third cause of obscurity; he frequently propo- ses objections, and answers them without giving any formal intimation. There are other difficulties which arise from our uncertainty who are the persons he is addressing, and what are the particular opinions and practices to which he refers. To these we may add two external causes, which have increased the difficulty of understanding the epistles. 1. The dividing them into chapters and verses, which divides the connection of the parts, and breaks them into fragments. If Cicero's epistles had been so disjoined, the reading of them would be attended with less pleasure and advantage, and with a great deal more labour. 2. We are accustomed to the phraseology of the epistles from our infancy; but we have either no idea at all when we see it, or our idea of it is derived from the articles, or system which we have espoused. But as different sects have arbitrary definitions for St Paul's phrases, we shall never by following them discover the meaning of St Paul, who certainly did not adjust his phraseology to any man's system.

The best plan of studying the epistles is that which was proposed and executed by Mr Locke. This we shall present to our readers in the words of that acute and judicious author.

“After I had found by long experience, that the reading of the text and comments in the ordinary way proved not so successful as I wished to the end proposed, I began to suspect that in reading a chapter as was usual, and thereupon sometimes consulting expositors upon some hard places of it, which at that time most affected me, as relating to points then under consideration in my own mind, or in debate against others, was not a right method to get into the true sense of these epistles. I saw plainly, after I began once to reflect on it, that if any one should write me a letter as long as St Paul's to the Romans, concerning such a matter as that is, in a style as foreign, and expressions as dubious as his seem to be, if I should divide it into fifteen or sixteen chapters, and read one of them to day, and another tomorrow, &c. it is ten to one I should never come to a full and clear comprehension of it. The way to understand the mind of him that writ it, every one would agree, was to read the whole letter through from one end to the other all at once, to see what was the main subject and tendency of it; or if it had several views and purposes in it, not dependent one of another, nor in a subordination to one chief aim and end, to discover what those different matters were, and where the author concluded one, and began another; and if there were any necessity of dividing the epistle into parts, to make the boundaries of them.

“In the prosecution of this thought, I concluded it necessary, for the understanding of any one of St Paul's epistles, to read it all through at one sitting, and to observe as well as I could the drift and design of his writings. If the first reading gave me some light, the second gave me more; and so I persisted on reading constantly the whole of it over at once till I came to have a good general view of the epistle's main parts. In writing the epistle, the chief branches of his discourse were presented to, the arguments he used, and the disposition of the whole

“This, I confess, is not to be obtained by one or two hasty readings; it must be repeated again and again with a close attention to the tenor of the discourse, and a perfect neglect of the divisions into chapters and verses. On the contrary, the safest way is to suppose that the epistle has but one business and one aim, till by a frequent perusal of it you are forced to see there are distinct independent matters in it, which will forwardly enough show themselves.

“It requires for much more pains, judgement, and application, to find the coherence of obscure and abstruse writings; and makes them to much the more unfit to serve prejudice and preoccupation when found; that it is not to be wondered that St Paul's epistles have with many passed rather for disjointed, loose, pious discourses, full of warmth and zeal, and overflows of light, rather than for calm, strong, coherent reasonings, that carried a thread of argument and consistency all through them.”

Mr Locke tells us he continued to read the same epistle over and over again, till he discovered the scope of the whole, and the different steps and arguments by which the writer accomplishes his purpose. For he was convinced before reading his epistles, that Paul was a man of learning, of sound sense, and knew all the doctrines of the gospel by revelation. The speeches recorded in the Acts of the Apostles convinced this judicious critic that Paul was a clear and accurate reasoner; and therefore he concluded that his epistles would not be written in a loose, confused, incoherent style. Mr Locke accordingly followed the chain of the apostle's discourse, observed his inferences, and carefully examined from what premises they were drawn, till he obtained a general outline of any particular epistle. If every divine would follow this method, he would soon acquire such a knowledge of Paul's style and manner, that he would peruse his other Epistles with much greater ease.

That the Epistle to the Romans was written at Corinth by St Paul, is ascertained by the testimony of the ancient Christians. It was composed in the year 58, in the 24th year after Paul's conversion, and is the seventh epistle which he wrote. From the Acts of the Apostles we learn that it must have been written within the space of three months; for that was the whole period of Paul's residence in Greece, (Acts xv. 1, 2, 3.)

The following analysis of this epistle we have taken from a valuable little treatise, intitled A Key to the New Testament, which was written by Dr Percy bishop of Dromore. It exhibits the intention of the apostle, and the arguments which he uses to prove his different propositions, in the most concise, distinct, and connected manner, and shews the full view of this Epistle that we have ever seen.

“The Christian church at Rome appears not to have been planted by any apostle; wherefore St Paul, lest it should be corrupted by the Jews, who then swarmed in Rome, and of whom many were converted to Christianity, finds them an adherent of the principal truths of the gospel, and endeavours to guard them against those erroneous notions which the Jews had of justification, and of the merit of their own nature.

“Now the Jews alleged three grounds for justification. First, The extraordinary piety and merits of their ancestors, and the covenant made by God with their forefathers. They thought God could not hate the chil-

Scripture

dren of such meritorious parents; and as he had made a covenant with the patriarchs to bless their posterity, he was obliged thereby to pardon their sins.' Secondly, 'A perfect knowledge and diligent study of the law of Moses.' They made this a plea for the remission of all their sins and vices. Thirdly, 'The works of the Levitical law,' which were to expiate sin, especially circumcision and sacrifices. Hence they inferred that the Gentiles must receive the whole law of Moses, in order to be justified and saved.

"The doctrine of the Jews concerning election was, 'That as God had promised to Abraham to bless his seed, to give him not only spiritual blessings, but also the land of Canaan, to suffer him to dwell there in prosperity, and to consider him as his church upon earth.' That therefore this blessing extended to their whole nation, and that God was bound to fulfil these promises to them, whether they were righteous or wicked, faithful or unbelieving. They even believed that a prophet ought not to pronounce against their nation the prophecies with which he was inspired; but was rather to beg of God to exchange his name out of the book of the living.

"These previous remarks will serve as a key to unlock this difficult Epistle, of which we shall now give a short analysis. See *Michael's Lectures on the New Testament*.

183
and analy-
is of it.

"I. The Epistle begins with the usual salutation with which the Greeks began their letters, (chap. i. 1—7.)

"II. St Paul professes his joy at the flourishing state of the church at Rome, and his desire to come and preach the gospel (ver. 8—19.): then he insensibly introduces the capital point he intended to prove, viz.

"III. The subject of the gospel (ver. 16, 17.), that it reveals a righteousness unknown before, which is derived solely from faith, and to which Jews and Gentiles have an equal claim.

"IV. In order to prove this, he shows (chap. i. 18—iii. 20.) that both Jews and Gentiles are 'under sin,' i. e. that God will impute their sins to Jews as well as to Gentiles.

"His arguments may be reduced to these syllogisms (chap. ii. 17—24.) 1. 'The wrath of God is revealed against those who hold the truth in unrighteousness; i. e. who acknowledge the truth, and yet sin against it. 2. The Gentiles acknowledged truths; but, partly by their idolatry, and partly by their other detestable vices, they sinned against the truth they acknowledged. 3. Therefore the wrath of God is revealed against the Gentiles, and punisheth them. 4. The Jews have acknowledged more truths than the Gentiles, and yet they sin. 5. Consequently the Jewish sinners are yet more exposed to the wrath of God (ch. ii. 1—12. Having thus proved his point, he answers certain objections to it. *Obj.* 1. 'The Jews were well grounded in their knowledge, and studied the law.' He answers, If the knowledge of the law, without observing it, could justify them, then God could not have condemned the Gentiles, who knew the law by nature, (ch. ii. 13—16.) *Obj.* 2. 'The Jews were circumcised.' *Ans.* That is, ye are admitted by an outward sign into the covenant with God. This sign will not avail you when ye violate that covenant (ch. ii. 25. to the end). *Obj.* 3. 'According to this doctrine of St Paul, the Jews have no advantage before others.' *Ans.*

Scripture.

Yes, they still have advantages; for unto them are committed the oracles of God. But their privileges do not extend to this, that God should overlook their sins, which, on the contrary, Scripture condemns even in the Jews (ch. iii. 1—19.). *Obj.* 4. 'They had the Levitical law and sacrifices.' *Ans.* From hence is no remission, but only the knowledge of sin. (ch. iii. 20.)

"V. From all this St Paul concludes, that Jews and Gentiles may be justified by the same means, namely, without the Levitical law, through faith in Christ: And in opposition to the imaginary advantages of the Jews, he states the declaration of Zechariah, that God is the God of the Gentiles as well as of the Jews, (ch. iii. 21. to the end).

"VI. As the whole blessing was promised to the faithful descendants of Abraham, which both Scripture and the Jews call his children, he proves his former assertion from the example of Abraham; who was an idolater before his call, but was declared just by God, on account of his faith, long before his circumcision. Hence he takes occasion to explain the nature and fruits of faith, (ch. iv. 1. v. 11.)

"VII. He goes on to prove from God's justice, that the Jews had no advantages over the Gentiles with respect to justification. Both Jews and Gentiles had forfeited life and immortality, by the means of one common father of their race, whom they themselves had not chosen. Now as God was willing to restore immortality by a new spiritual head of a covenant, viz. Christ, it was just that both Jews and Gentiles should share in this new representative of the whole race (ch. v. 12. to the end).—Chap. v. ver. 15, 16. amounts to this negative question, 'Is it not fitted that the free gift should extend as far as the offence?'

"VIII. He shows that the doctrine of justification, as stated by him, lays us under the strongest obligations of holiness, (ch. vi. 1. to the end).

"IX. He shows that the law of Moses no longer concerns us at all; for our justification arises from our appearing in God's sight, as if actually dead with Christ on account of our sins; but the law of Moses was not given to the dead. On this occasion he proves at large, that the eternal power of God over us is not affected by this; and that whilst we are under the law of Moses we perpetually become subject to death, even by sins of inadvertency; (ch. vii. 1. to the end).

"X. Hence he concludes, that all those, and those only, who are united with Christ, and for the sake of his union, do not live according to the flesh, are free from all condemnation of the law, and have an undoubted share in eternal life, (ch. viii. 1—17.)

"XI. Having described their blessedness, he is aware that the Jews, who expected a temporal happiness, should object to him, that Christians notwithstanding endure much suffering in this world. He answers this objection at large, (ch. viii. 18 to the end).

"XII. He shows that God is not the less true and faithful, because he doth not justify, but rather rejects and punishes, those Jews who would not believe the Messiah, (ch. ix. x. xi.). In discussing this point, we may observe the cautious manner in which, on account of the Jewish prejudices, he introduces it (ch. ix. 1—5.), as well as in the discussion itself.

"He shows that the promises of God were never made to all the posterity of Abraham, and that God always

Scripture. was referred to himself the power of checking those sons of Abraham whom, for Abraham's sake, he intended to bless, and of punishing the wicked sons of Abraham; and that with respect to temporal happiness or misery, he was not even determined in his choice by their works. Thus he rejected Ishmael, Esau, the Israelites in the desert in the time of Moses, and the greater part of that people in the time of Isaiah, making them a sacrifice to his justice, (ch. ix. 6—29.).

“ He then proceeds to show, that God had reason to reject most of the Jews then living, because they would not believe in the Messiah, though the gospel had been preached to them plainly enough, (ch. ix. 32. x. to the end). However, that God had not rejected all the people, but was still fulfilling his promise upon many thousand natural descendants of Abraham, who believed in the Messiah, and would in a future period call them upon more; for that all Israel would be converted, (ch. xi. 1—32.). And he concluded with admiring the wide counsels of God, (ver. 32. to the end).

“ XIII. From the doctrine hitherto laid down, and particularly from this, that God has in mercy accepted the Gentiles; he argues, that the Romans should consecrate and offer themselves up wholly to God. This leads him to mention in particular some Christian duties, (ch. xii. vix.

“ XIV. He exhorts them to be subject to magistrates (ch. xii. 1—7.); the Jews at that time being given to sedition.

“ XV. To love one another heartily (ver. 2—10.). And,

“ XVI. To abstain from those vices which were considered as things indifferent among the Gentiles, (ver. 11. to the end).

“ XVII. He exhorts the Jews and Gentiles in the Christian church to brotherly unity, (ch. xiv. 2. xv. 13.).

“ XVIII. He concludes his Epistle with an excuse for having ventured to admonish the Roman, whom he had not converted; with an account of the journey to Jerusalem; and with some salutations to those persons whom he meant to recommend to the church at Rome.” See *Michaelis's Lectures on the New Testament*.

Corinth was a wealthy and luxurious city, built upon the isthmus which joins the Morea to the northern parts of Greece. In this city Paul had spent two years founding a Christian church, which consisted of a mixture of Jews and Gentiles, but the greater part Gentiles.

About three years after the apostles had left Corinth, he wrote this Epistle from Ephesus in the year 56 or 57, and in the beginning of Nero's reign. That it was written from Ephesus, appears from the salutation with which the Epistle closes, (chap. xvi. 19.) “ The churches of Asia salute you. Aquila and Priscilla salute you much in the Lord.” From these words it is evident in the 1st place, that the Epistle was written in Asia. 2dly, It appears from Acts xviii. 18, 19, that Aquila and Priscilla accompanied Paul from Corinth to Ephesus, where they seem to have continued till Paul's departure.

St Paul had certainly kept up a constant intercourse with the churches which he had founded: for he was evidently acquainted with all their revolutions. They seem to have applied to him for advice in those diffi-

cult cases which their own understanding could not solve; and he was ready on all occasions to correct their mistakes.

This Epistle consists of two parts. 1. A reproval for those vices to which they were most propense to give scope. 2. An answer to some queries which they had proposed to him.

The Corinthians, like the other Greeks, had been accustomed to see their philosophers divide themselves into different sects; and as they brought along with them into the Christian church their former opinions and customs, they wished, as before, to arrange themselves under different leaders. In this Epistle Paul condemns these divisions as inconsistent with the spirit of Christianity, which inculcates benevolence and unanimity, and as opposite to the conduct of Christian teachers, who did not, like the philosophers, aspire after the praise of eloquence and wisdom. They laid no claim to titles nor to any honour that cometh from men. The apostle declares, that the Christian truths were revealed from heaven; that they were taught with great plainness and simplicity, and proved by the evidence of miracles, (chap. i. 1.). He dissuades them from their divisions and animosities, by reminding them of the great trial which every man's work must undergo; of the guilt they incurred by polluting the temple or church of God; of the vanity of human wisdom; and of glorying in men. He admonishes them to esteem the teachers of the gospel only as the servants of Christ; and to remember that every superior advantage which they enjoyed was to be ascribed to the goodness of God, (chap. iii. 4.).

2. In the fifth chapter the apostle considers the case of a notorious offender, who had married his step-mother; and tells them, that he ought to be excommunicated. He also exhorts the Christians not to associate with any person who led such an openly profane life.

3. He censures the Corinthians for their litigious disposition, which caused them to prosecute their Christian brethren before the Heathen courts. He expresses much warmth and surprize that they did not refer their differences to their brethren; and concludes his exhortations on this subject, by assuring them that they ought rather to allow themselves to be defrauded than to seek redress from Heathens (chap. v. 1—9.).

4. He inveighs against those vices to which the Corinthians had been addicted before their conversion, and especially against fornication, the criminality of which they did not fully perceive, as this vice was generally overlooked in the systems of the philosophers, (chap. vi. 10. to the end).

Having thus pointed out the public irregularities with which they were chargeable, he next replies to certain questions which the Corinthians had proposed by letter. He, 1. Determines some questions relating to the marriage state; as, 1st, Whether it was good to marry under the existing circumstances of the church? And, 2d, Whether they should withdraw from their partners if they continued unbelievers? (chap. vii.).

2. He instructs them how to act with respect to idol offerings. It could not be unlawful in itself to eat the food which had been offered to idols; for the consecration of flesh or wine to an idol did not make it the property of the idol, an idol being nothing, and therefore incapable

151
First Epistle
to the Co-
rinthians.

152
Its date.

152
The ap-
ostle re-
proves
them for
their vices

152
And an-
swers cer-
tain ques-
tions which
they had
proposed to
him.

Scripture. incapable of property. But some Corinthians thought it lawful to go to a feast in the idol temples, which at the same time were places of resort for lewdness, and to eat the sacrifices which praises were sung to the idol. This was publicly joining in the idolatry. He even advises to abstain from such participation as was lawful, rather than give offence to a weak brother; which he enforces by his own example, who had abstained from many lawful things, rather than prove a scandal to the gospel. (chap. viii. ix. x.)

3. He answers a third query concerning the manner in which women should deliver any thing in public, when called to it by a divine impulse. And here he censures the unusual dress of both sexes in prophesying, which exposed them to the contempt of the Greeks, among whom the men usually went uncovered and the women veiled.

Being thus led to the consideration of the abuses that prevailed in their public worship, he goes on to censure the irregularities which were committed at their love-feasts, or, as we term them, the *Lord's Supper*. It was a common practice with the Greeks at their social suppers for every man to bring his own provisions along with him, not, however, to share them with the company, but to feast on them in a solitary manner. This the rich ate and drank to excess, whilst the poor were totally neglected. The Corinthians introduced the same practice in the celebration of the Lord's Supper, thus confounding it with their ordinary meals, and without ever examining into the end of the institution. It was this gross abuse that Paul represses in the 11th chapter. He also censures their conduct in the exercise of the extraordinary gifts of the Holy Ghost; he shows them they all proceeded from the same spirit, and were intended for the instruction of Christian societies; that all Christians ought to be united in mutual love; and that tenderness ought to be shown to the most inconsiderable member, as every one is subservient to the good of the whole (chap. xii.). In the 13th chapter he gives a beautiful description of benevolence, which has been much and justly admired. He represents it as superior to the supernatural gifts of the spirit, to the most exalted genius, to universal knowledge, and even to faith. In the 14th chapter he cautions the Corinthians against ostentation in the exercise of the gift of languages, and gives them proper advice.

4. He allerts the resurrection of the dead, in opposition to some of the Corinthians who denied it, founding it on the resurrection of Jesus Christ, which he considers as one of the most essential doctrines of Christianity. He then answers some objections to the resurrection, drawn from our not being capable of understanding how it will be accomplished, (chap. xv.). He then concludes with some directions to the Corinthian church concerning the manner of collecting alms; promises them a visit, and salutes some of the members.

The second Epistle to the Corinthians was written from Macedonia in the year 57, about a year after the former. See 2 Cor. ix. 1—5, viii. and xiii. 1.

St Paul's first Epistle had wrought different effects among the Corinthians; many of them examined their conduct; they excommunicated the incestuous man; requested St Paul's return with tears; and vindicated him and his office against the false teacher and his adherents. Others of them still adhered to that adversary

of St Paul, expressly denied his apostolic office, and even furnished themselves with pretended arguments from that Epistle. He had formerly promised to take a journey from Ephesus to Corinth, thence to visit the Macedonians, and return from them to Corinth (2 Cor. i. 15, 16.). But the unhappy state of the Corinthian church made him alter his intention (verse 23.), since he found he must have treated them with severity. Hence his adversaries partly argued, 1. That St Paul was irreflexive and unsteady, and therefore could not be a prophet; 2. The improbability of his ever coming to Corinth again, since he was afraid of them. Such was the state of the Corinthian church when St Paul, after his departure from Ephesus, having visited Macedonia, (Acts xx. 1.), received an account of the above particulars from Titus (2 Cor. vii. 5, 6.), and therefore wrote them his second Epistle about the end of the same year, or the beginning of 58.

But to give a more distinct view of the contents of this Epistle:

1. The apostle, after a general salutation, expresses his grateful sense of the divine goodness; professing his confidence in God, supported by a sense of his own integrity; makes an apology for not having visited the Corinthians as he had intended, and vindicates himself from the charge of fickleness, (chap. i.).

2. He forgives the incestuous man, whose conduct had made so deep an impression on the apostle's mind, that one reason why he had deferred his journey to Corinth was, that he might not meet them in grief, nor till he had received advice of the effect of his apostolical admonitions. He mentions his anxiety to meet Titus at Troas, in order to hear of their welfare; expresses his thankfulness to God for the success attending his ministry, and speaks of the Corinthians as his credentials, written by the finger of God, (chap. ii. iii. 1.—6.).

3. He treats of the office committed to him of preaching the redemption; and highly prefers it to preaching the law: to which probably his adversaries had made great pretences. They had ridiculed his sufferings; which he shows to be no disgrace to the gospel or its ministers; and here he gives a short abstract of the doctrine he preaches, (chap. iii. 6. v. to the end).

He expatiates with great copiousness on the temper with which, in the midst of afflictions and persecutions, he and his brethren executed their important embassy; and with great affection and tenderness he exhorts them to avoid the pollution of idolatry, (chap. vi.). He endeavours to win their confidence, by telling them how much he rejoiced in their amendment and welfare, and how sorry he had been for the distress which his necessary reproofs had occasioned, (chap. vii.). He then exhorts them to make liberal contributions for the Christians in Judaea. He recommends to them the example of the Macedonians, and reminds them of the benevolence of the Lord Jesus. He expresses his joy for the readiness of Titus to assist in making the collection; and makes also honourable mention of other Christian brethren, whom he had joined with Titus in the same commission, (chap. viii.). He then, with admirable address, urges a liberal contribution, and recommends them to the divine blessing, (chap. ix.).

4. Next he obviates some reflections which had been thrown

153
View of
the contents
of this Epistle.

156
Compare
the contents
of the
Corinthian
church.

157
Compare
the contents
of the
Corinthian
church.

Scripture. thrown on him for the mildness of his conduct, as if he had proceeded from fear. He asserts his apostolical power and authority, cautioning his opponents against urging him to give too sensible demonstrations of it, (chap. x.). He vindicates himself against the insinuations of some of the Corinthians, particularly for having declined pecuniary support from the church; an action which had been ungenerously turned to his disadvantage. To show his superiority over those designing men who had opposed his preaching, he enumerates his sufferings; gives a detail of some extraordinary revelations which he had received; and vindicates himself from the charge of boasting, by declaring that he had been forced to it by the desire of supporting his apostolical character, (chap. xi. xii.). He closes the Epistle, by assuring them with great tenderness how much it would grieve him to demonstrate his divine commission by severer methods.

159
Epistle to
the Galatians.

The Galatians were defended from those Gauls who had formerly invaded Greece, and afterwards settled in Lower Asia. St Paul had preached the gospel among them in the year 51, soon after the council held at Jerusalem, (Acts xvi. 6.). Asia swarmed at that time with zealots for the law of Moses, who wanted to impose it on the Gentiles, (Acts xv. 1.). Soon after St Paul had left the Galatians, these false teachers had got among them, and wanted them to be circumcised, &c. This occasioned the following Epistle, which Michaelis thinks was written in the same year, before St Paul left Thessalonica. Dr Lardner dates it about the end of the year 52, or in the very beginning of 53, before St Paul set out to go to Jerusalem by way of Ephesus.

150
The date

The subject of this Epistle is much the same with that of the Epistle to the Romans; only this question is more fully considered here, "Whether circumcision, and an observance of the Levitical law, be necessary to the salvation of a Christian convert?" It appears, these Judaizing Christians, whose indirect views St Paul exposes (Acts xv. 1. Gal. v. 3, 9.), at first only represented circumcision as necessary to salvation; but afterwards they insisted upon the Christians receiving the Jewish festivals, (Gal. iv. 10.).

As St Paul had founded the churches of Galatia, and instructed them in the Christian religion, he does not set before them its principal doctrines, as he had done in the Epistle to the Romans; but referring them to what he had already taught (chap. i. 8, 9.), he proceeds at once to the subject of the Epistle.

As it appears from several passages of this Epistle, particularly chap. i. 7, 8, 10, and chap. v. 11, that the Judaizing Christians had endeavoured to persuade the Galatians that Paul himself had changed his opinion, and now preached up the Levitical law; he denies that charge, and affirms that the doctrines which he had taught were true, for he had received them from God by immediate revelation. He relates his miraculous conversion; asserts his apostolical authority, which had been acknowledged by the disciples of Jesus; and, as a proof that he had never inculcated a compliance with the Mosaic law, he declares that he had opposed Peter at Antioch for yielding to the prejudices of the Jews.

Having now vindicated his character from the suspicion of fickleness, and shown that his commission was

divine, he argues that the Galatians ought not to submit to the law of Moses: 1. Because they had received the Holy Ghost and the gift of miracles, not by the law, but by the gospel, (chap. iii. 1—5.). 2. Because the promises which God made to Abraham were not restricted to his circumcised descendants, but extended to all who are his children by faith, (chap. iii. 6—18.). In answer to the objection, *What then serveth thee, who art under the law?* he replies, That it was given because of transgressions on the part of the flesh; that is, to preserve them from idolatry till the Messiah himself should come. 3. Because all men, whether Jews or Gentiles, are made the children of God by faith, or by receiving the Christian religion, and therefore do not stand in need of circumcision, (chap. iii. 26—29.). From the 10th verse of chap. iv. to the 11th, he argues that the law was temporary, being only fitted for a state of infancy; but that the world, having attained a state of manhood under the Messiah, the law was of no farther use. In the remaining part of chapter iv. he reminds them of their former affection to him, and assures them that he was still their sincere friend. He exhorts them to stand fast in the liberty with which Christ had made them free; for the sons of Agar, that is, those under the law given at Mount Sinai, are in bondage, and to be cast out; the inheritance being designed for those only who are the free-born sons of God under the spiritual covenant of the gospel.

The apostle next confutes the false report which had been spread abroad among the Galatians, that Paul himself preached up circumcision. He had already directly refuted this calumny by the particular account into which he gave of his life; but he now directly and openly contradicts it in the following manner:

1. By assuring them, that all who thought circumcision necessary to salvation could receive no benefit from the Christian religion, (chap. v. 2—4.).
2. By declaring, that he expected justification only by faith, (verse 5, 6.).
3. By testifying, that they had once received the truth, and had never been taught such false doctrines by him, (verse 7, 8.).
4. By insinuating that they should pass some censure on those who misled them (ver. 9, 10.), by declaring that he was persecuted for opposing the circumcision of the Christians, (ver. 11.).
5. By expressing a wish that those persons should be cut off who troubled them with his doctrine.

This Epistle affords a fine instance of Paul's skill in managing an argument. The chief objection which the advocates for the Mosaic law had urged against him was, that he himself preached circumcision. In the beginning of the Epistle he overturns this slander by a statement of facts, without taking any express notice of it; but at the end fully refutes it, that it might leave a strong and lasting impression on their minds.

He next cautions them against an idea which his arguments for Christian liberty might excite, that it consisted in licentiousness. He shows them it does not consist in gratifying vicious desires; for none are under stronger obligations to moral duties than the Christian. He recommends gentleness and meekness to the weak (chap. vi. 1—5.), and exhorts them to be liberal to their teachers, and to all men (ver. 6—10.). He concludes

concludes with exposing the false pretences of the Judaizing teachers, and asserting the integrity of his own conduct.

Ephesus was the chief city of all Asia on this side Mount Taurus. St Paul had passed through it in the year 53, but without making any stay, (Acts xviii. 19—21.). The following year he returned to Ephesus again, and staid there three years, (chap. xix.). During his staid there he completed a very flourishing church of Christians, the first foundations of which had been laid by some inferior teachers. As Ephesus was frequented by persons of distinction from all parts of Asia Minor, St Paul took the opportunity of preaching in the ancient countries (ver. 15.); and the other churches of Asia were considered as the daughters of the church of Ephesus; so that an Epistle to the Ephesians was, in effect, an epistle to the other churches of Asia at the same time.

Dr Linder shows it to be highly probable that this Epistle was written in the year 61, soon after Paul's arrival at Rome.

As Paul was in a peculiar manner the apostle of the Gentiles, and was now a prisoner at Rome in consequence of having provoked the Jews, by asserting that an observance of the Mosaic law was not necessary to obtain the favour of God, he was afraid lest an advantage should be taken of his confinement to unsettle the minds of those who he had converted. Hearing that the Ephesians stood firm in the faith of Christ, without submitting to the law of Moses, he writes this Epistle to give them more exalted views of the love of God, and of the excellence and dignity of Christ. This epistle is not composed in an argumentative or didactic style: The first three chapters consist almost entirely of thank-givings and prayers, or glowing descriptions of the blessings of the Christian religion. This circumstance renders them a little obscure; but by the assistance of the two following epistles, which were written on the same occasion, and with the same design, the meaning of the apostle may be easily discovered. The last three chapters contain practical exhortations. He still inculcates unity, love, and concord, from the consideration that all Christians are members of the same body, of which Christ is the head. He then advises them to forsake the vices to which they had been addicted while they remained heathens. He recommends justice and charity; strenuously condemns envy, ambition, and intemperance, vices which seem to have been too common among the Ephesians. In the 4th chapter he points out the duties which arise from the relations of husbands and wives, parents and children, masters and servants; and concludes with flowing exhortations to fortitude, which he describes in an allegorical manner.

The church at Philippi had been founded by Paul, Silas, and Timothy (Acts xvi.), in the year 51, and had continued to show a strong and manly attachment to the Christian religion, and a tender affection for the apostle. Hearing of his imprisonment at Rome, they sent Epistodius, one of their pastors, to supply him with necessaries. It appears from this epistle that he was disappointed, as he had not converted the Romans, he did not consider himself as entitled to receive supplies from them. Being a prisoner, he could not work as formerly, and was a martyr of the law to accept any pe-

culinary assistance from those churches where a faction had been raised against him. From the Philippians he was not averse to receive a present in the time of want, because he considered it as a mark of their affection, and because he was assured that they had conducted themselves as sincere Christians.

It appears from the apostle's own words, that this letter was written while he was a prisoner at Rome, (chap. i. 7, 13. iv. 22.); and from the expectation which he discovers (chap. ii. 24.) of being soon released and restored to them, compared with Philemon v. 22. and Heb. xiii. 13, where he expresses a like expectation in stronger terms, it is probable that this epistle was written towards the end of his first imprisonment in the year 62.

The apostle's design in this epistle, which is quite and design of it of the practical kind, seems to be, "to comfort the Philippians under the concern they had expressed at the news of his imprisonment; to check a party-spirit that appears to have broken out among them, and to promote, on the contrary, an entire union and harmony of affection; to guard them against being seduced from the purity of the Christian faith by Judaizing teachers; to support them under the trials with which they struggled; and, above all, to inspire them with a concern to adorn their profession by the most eminent attainments in the divine life." After some particular admonitions in the beginning of the 4th chapter, he proceeds in the 8th verse to recommend virtue in the most extensive sense, mentioning all the different foundations in which it had been placed by the Grecian philosophers. Towards the close of the epistle, he makes his acknowledgements to the Philippians for the seasonable and liberal supply which they had sent him, as it was so convincing a proof of their affection for him, and their concern for the support of the gospel, which he preferred far above any private secular interest of his own; expressly disclaiming all selfish, mercenary views, and assuring them with a noble simplicity, that he was able upon all occasions to accommodate his temper to his circumstances; and had learned, under the teachings of Divine grace, in whatever situation Providence might see fit to place him, there-with to be content. After which, the apostle, having encouraged them to expect a rich supply of all their wants from their God and Father, to whom he devoutly ascribes the honour of all, concludes with salutations from himself and his friends at Rome to the whole church, and a solemn benediction, (verse 10. to the end); and declares, that he is rejoiced in their liberality chiefly on their own account.

The epistle to the Colossians was written while Paul was in prison (chap. iv. 3.), and was therefore probably composed in the year 62. The intention of the apostle, as far as can be gathered from the epistle itself, was to secure the Colossians from the influence of some doctrines that were subversive of Christianity, and to excite them to a temper and behaviour worthy of their sacred character. A new sect had arisen, which had blended the oriental philosophy with the superstitious opinions of the Jews.

They held, 1. That God was surrounded by demons or angels, who were mediators with God, and therefore to be worshipped. 2. That the soul is debased by the body; that all bodily enjoyments hurt the soul, which they believed to be immortal, though they seem to have im-

Scripture.
174
175
176
177

178
179
180
181

182
183
184
185

Scripture.
175
176
177
178
179
180
181
182
183
184
185
186
187
188
189
190
191
192
193
194
195
196
197
198
199
200
201
202
203
204
205
206
207
208
209
210
211
212
213
214
215
216
217
218
219
220
221
222
223
224
225
226
227
228
229
230
231
232
233
234
235
236
237
238
239
240
241
242
243
244
245
246
247
248
249
250
251
252
253
254
255
256
257
258
259
260
261
262
263
264
265
266
267
268
269
270
271
272
273
274
275
276
277
278
279
280
281
282
283
284
285
286
287
288
289
290
291
292
293
294
295
296
297
298
299
300
301
302
303
304
305
306
307
308
309
310
311
312
313
314
315
316
317
318
319
320
321
322
323
324
325
326
327
328
329
330
331
332
333
334
335
336
337
338
339
340
341
342
343
344
345
346
347
348
349
350
351
352
353
354
355
356
357
358
359
360
361
362
363
364
365
366
367
368
369
370
371
372
373
374
375
376
377
378
379
380
381
382
383
384
385
386
387
388
389
390
391
392
393
394
395
396
397
398
399
400

Scripture denied the resurrection of the body, as it would only render the soul sinful by being reunited to it. 3. That there was a great mystery in numbers, particularly in the number seven; they therefore attributed a natural holiness to the seventh or Sabbath day, which they observed more strictly than the other Jews. They spent their time mostly in contemplation; abstained from marriage, and every gratification of the senses; used washings, and thought it sinful to touch certain things; regarded wine as poison, &c.

201 The arguments which the apostle employs. The arguments against these doctrines are managed with great skill and address. He begins with expressing great joy for the favourable character which he had heard of them, and assures them that he daily prayed for their farther improvement. Then he makes a short digression, in order to describe the dignity of Jesus Christ; declares that he had created all things, whether thrones or dominions, principalities and powers; that he alone was the head of the church, and had reconciled men to the Father. The inference from this description is evident, that Jesus was superior to angels; that they were created beings, and ought not to be worshipped. Thus he indirectly confutes one doctrine before he formally opposes it. Paul now returns from his digression in the 21st verse to the sentiments with which he had introduced it in the 13th and 14th verses, and again expresses his joy that the Philippians remained attached to the gospel, which was to be preached to the Gentiles, without the restraints of the ceremonial law. Here again he states a general doctrine, which was inconsistent with the opinions of those who were zealous for the law of Moses; but he leaves the Colossians to draw the inference, (chap. i.).

Having again assured them of his tender concern for their welfare, for their advancement in virtue, and that they might acknowledge the mystery of God, that is, that the gospel was to supersede the law of Moses, he proceeds directly to caution them against the philosophy of the new teachers, and their superstitious adherence to the law; shows the superiority of Christ to the angels, and warns Christians against worshipping them. He censures the observation of Sabbaths, and rebukes those who required abstinence from certain kinds of food, and cautions them against persons who assume a great appearance of wisdom and virtue, (chap. ii.).

203 Exhortations. In the 3d chapter he exhorts them, that, instead of being occupied about external ceremonies, they ought to cultivate pure morality. He particularly guards them against impurity, to which they had before their conversion been much addicted. He admonishes them against indulging the irascible passions, and against committing falsehood. He exhorts them to cultivate the benevolent affections, and humility, and patience. He recommends also the relative duties between husbands and wives, parents and children, masters and servants. He enjoins the duties of prayer and thanksgiving (chap. iv. 2.), and requests them to remember him in their petitions. He enjoins affability and mild behaviour to the unconverted heathens (verse 6th); and concludes the epistle with matters which are all of a private nature, except the directions for reading this epistle in the church of Laodicea, as well as in the church of Colosse.

204 The Epistle to the Thessalonians. This epistle is addressed to the inhabitants of Thessalonians. Vol. XIX. Part I.

Scripture. lonica, the capital of Macedonia, a large and populous city. It appears from the Acts, chapter xvii. 1. that the Christian religion was introduced into this city by Paul and Silas, soon after they had left Philippi. At first they made many converts; but at length the Jews, ever jealous of the admission of the Gentiles to the same privileges with themselves, stirred up the rabble, which assailed the house where the apostle and his friends lodged; so that Paul and Silas were obliged to flee to Berea, where their success was soon interrupted by the same restless and implacable enemies. The apostle then withdrew to Athens; and Timothy, at his desire, returned to Thessalonica (1 Thess. iii. 2.), to see what were the sentiments and behaviour of the inhabitants after the persecution of the Jews. From Athens Paul went to Corinth, where he stayed a year and six months; during which, Timothy returned with the joyful tidings, that the Thessalonians remained stedfast to the faith, and firmly attached to the apostle, notwithstanding his flight. Upon this he sent them this epistle, A. D. 52, in the 12th year of Claudius.

205 The date. This is generally reckoned the first epistle which Paul wrote; and we find he was anxious that it should be read to all the Christians. In chap. v. 27. he uses these words; "I adjure you by the Lord, that this epistle be read unto all the holy brethren." This direction is very properly inserted in his first epistle.

206 and de figo. The intention of Paul in writing this epistle was evidently to encourage the Thessalonians to adhere to the Christian religion. This church being still in its infancy, and oppressed by the powerful Jews, required to be established in the faith. St Paul, therefore, in the three first chapters, endeavours to convince the Thessalonians of the truth and divinity of his gospel, both by the miraculous gifts of the Holy Ghost which had been imparted, and by his own conduct when among them.

While he appeals, in the first chapter, to the miraculous gifts of the Holy Spirit, he is very liberal in his commendations. He vindicates himself from the charge of timidity, probably to prevent the Thessalonians from forming an unfavourable opinion of his fortitude, which his flight might have excited. He asserts, that he was not influenced by selfish or dishonourable motives, but that he was anxious to please God and not man. He expresses a strong affection for them, and how anxious he was to impart the blessings of the gospel. He congratulates himself upon his success; mentions it to their honour that they received the gospel as the word of God and not of man, and therefore did not renounce it when persecution was raised by the Jews. He expresses a strong desire to visit the Thessalonians; and assures them he had been hitherto retained against his will.

As a farther proof of his regard, the apostle informs them, that when he came to Athens, he was so much concerned, least, being discouraged by his sufferings, they should be tempted to call off their profession, that he could not forbear sending Timothy to comfort and strengthen them; and expresses, in very strong terms, the sensible pleasure he felt, in the midst of all his afflictions, from the favourable account he received of their faith and love; to which he adds, that he was continually praying for their farther establishment in religion, and for an opportunity of making them another visit, in order

Scripture. order to promote their edification, which lay so near his heart, (chap. iii. throughout).

Having now shown his paternal affection for them, with great address he improves all that influence which his zeal and fidelity in their service must naturally have given him to inculcate upon them the precepts of the gospel. He recommends chastity, in opposition to the prevailing practice of the heathens; justice, in opposition to fraud. He praises their benevolence, and encourages them to cultivate higher degrees of it. He recommends industry and prudent behaviour to their heathen neighbours. In order to comfort them under the loss of their friends, he assures them that those who were fallen asleep in Jesus should be raised again at the last day, and should, together with those who remained alive, be caught up to meet their Lord, and share his triumph, (chap. iv.). He admonishes them to prepare for this solemn event, that it might not come upon them unawares; and then concludes the epistle with various exhortations.

207
Second Epistle to the Thessalonians.

The second epistle to the Thessalonians appears to have been written soon after the first, and from the same place; for Silvanus or Silas, and Timothy, are joined together with the apostle in the inscriptions of this epistle, as well as of the former.

208
Contents of it.

The apostle begins with commending the faith and charity of the Thessalonians, of which he had heard a favourable report. He expresses great joy on account of the patience with which they supported persecution; and observes that their persecution was a proof of a righteous judgement to come, where their persecutors would meet with their proper recompense, and the righteous be delivered out of all their afflictions. He assures them of his constant prayers for their farther improvement, in order to attain the felicity that was promised, (chap. i.).

From misunderstanding a passage in his former letter, it appears that the Thessalonians believed the day of judgement was at hand. To rectify this mistake, he informs them that the day of the Lord will not come till a great apostacy has overspread the Christian world, the nature of which he describes (G). Symptoms of this mystery of iniquity had then appeared; but the apostle expresses his thankfulness to God that the Thessalonians had escaped this corruption. He exhorts them to steadfastness, and prays that God would comfort and strengthen them, (chap. ii.).

He requests the prayers of the Thessalonians for him and his two assistants, at the same time expelling his confidence that they would pay due regard to the instructions which he had given them. He then proceeds to correct some irregularities. Many of the Thessalonians seem to have led an idle disorderly life; these he severely reproveth, and commands the faithful to shun their company if they still remained incorrigible.

209
First Epistle to Timothy, when written.

When the first Epistle to Timothy was written, it is difficult to ascertain. Lardner dates it in 56; Mill, Whitby, and Macknight, place it in 64; but the ar-

guments on which each party founds their opinion are too long to infer here.

Timothy was the intimate friend and companion of Paul, and is always mentioned by that apostle with much affection and esteem. Having appointed him to superintend the church of Episcopus during a journey which he made to Macedonia, he wrote this letter, in order to direct him how to discharge the important trust which was committed to him. This was the more necessary, as Timothy was young and inexperienced, (1 Tim. iv. 12.). In the beginning of the epistle he reminds him of the charge with which he had intrusted him, to wit, to preserve the purity of the gospel against the pernicious doctrines of the Judaizing teachers, whose opinions led to frivolous controversies, and not to a good life. He shows the use of the law of Moses, of which these teachers were ignorant. His account of the law, he refers Timothy, was agreeable to the representation of it in the gospel, with the preaching of which he was intrusted. He then makes a digression, in the fulness of his heart, to express the sense which he felt of the goodness of God towards him.

In the second chapter, the apostle prescribes the manner in which the worship of God was to be performed in the church of Episcopus; and in the third explains the qualifications of the persons whom he was to ordain as bishops and deacons. In the fourth chapter he foretells the great corruptions of the church which were to prevail in future times, and instructs him how to support the sacred character. In the fifth chapter he teaches Timothy how to admonish the old and young of both sexes; mentions the age and character of such widows as were to be employed by the society in some peculiar office; and subjoins some things concerning the respect due to elders. In the sixth chapter he describes the duties which Timothy was to inculcate on slaves; condemns trifling controversies and pernicious disputes; censures the excessive love of money, and charges the rich to be rich in good works.

The second Epistle to Timothy was written from Rome as universally agreed; but whether it was during his first or second imprisonment has been much disputed. That Timothy was at Episcopus or in Asia Minor when this Epistle was sent to him, appears from the frequent mention in it of persons residing at Episcopus.

The apostle seems to have intended to prepare Timothy for those sufferings which he foretold he would be exposed to. He exhorts him to constancy and perseverance, and to perform with a good conscience the duties of the sacred function.

The false teachers, who had before thrown this church into confusion, grew every day worse: inasmuch that not only Hymeneus, but Philetus, another Episcopus heretic, now denied the resurrection of the dead. They were led into this error by a dispute about words. At first they only annexed various improper significations to the word *resurrection*, but at last they denied it altogether (H); pretending that the resurrection of the dead was only a resurrection from the death of sin, and

(G) For an explanation of this prophecy, Dr Hurd's Sermons may be consulted. He applies it to the papal power, to which it corresponds with astonishing exactness.

(H) This is by no means uncommon among men; to begin to dispute about the signification of words, and

Scripture. so was already paid. This error was probably derived from the eastern philosophy, which placed the origin of sin in the body (chapter ii.). He then forewarns him of the fatal apostacy and declension that was beginning to appear in the church; and at the same time animates him, from his own example and the great motives of Christianity, to the most vigorous and resolute discharge of every part of the ministerial office.

²¹³ Epistle to Titus. This Epistle is addressed to Titus, whom Paul had appointed to preside over the church of Crete. It is difficult to determine either its date or the place from which it was sent. The apostle begins with reminding Titus of the reasons for which he had left him at Crete; and directs him on what principles he was to act in ordaining Christian pastors: the qualifications of whom he particularly describes. To show him how cautious he ought to be in selecting men for the sacred office, he reminds him of the arts of the Judaizing teachers, and the bad character of the Cretans (chapter i.).

²¹⁴ Design and contents of it.

He advises him to accommodate his exhortations to the respective ages, sexes, and circumstances, of those whom it was his duty to instruct; and to give the greater weight to his instructions, he admonishes him to be an example of what he taught (chap. ii.). He exhorts him also to teach obedience to the civil magistrate, because the Judaizing Christians affirmed that no obedience was due from the worshippers of the true God to magistrates who were idolaters. He cautions against censoriousness and contention, and recommends meekness; for even the best Christians had formerly been wicked, and all the blessings which they enjoyed they derived from the goodness of God. He then enjoins Titus strenuously to inculcate good works, and to avoid useless controversies; and concludes with directing him how to proceed with those heretics who attempted to sow dissension in the church.

²¹⁵ Epistle to Philemon. — Date and design of it.

The epistle to Philemon was written from Rome at the same time with the Epistles to the Colossians and Philippians, about A. D. 62 or 63. The occasion of the letter was this: Onesimus, Philemon's slave, had robbed his master and fled to Rome; where, happily for him, he met with the apostle, who was at that time a prisoner at large, and by his instructions and admonitions was converted to Christianity; and reclaimed to a sense of his duty. St Paul seems to have kept him for some considerable time under his eye, that he might be satisfied of the reality of the change; and, when he had made a sufficient trial of him, and found that his behaviour was entirely agreeable to his profession, he would not detain him any longer for his own private convenience, though in a situation that rendered such an assiduous peculiarly desirable (compare ver. 13, 14.), but sent him back to his master; and, as a mark of his esteem, entrusted him, together with Tychicus, with the charge of delivering his Epistle to the church at Colosse, and giving them a particular account of the state of things at Rome, recommending him to them, at the same time, as a faithful and beloved brother (Col. iv. 9.).

Dull idler's Family Epistle.

And as Philemon might well be supposed to be strongly prejudiced against one who had left his service in so infamous a manner, he sends him this letter, in which he employs all his influence to remove his suspicions, and reconcile him to the thoughts of taking Onesimus into his family again. And whereas St Paul might have exerted that authority which his character as an apostle, and the relation in which he stood to Philemon as a spiritual father, would naturally give him, he chooses to entreat him as a friend; and with the softest and most insinuating address urges his suit, conjuring him by all the ties of Christian friendship that he would not deny him his request: and the more effectually to prevail upon him, he represents his own peace and happiness as deeply interested in the event; and speaks of Onesimus in such terms as were best adapted to soften his prejudices, and dispose him to receive one who was so dear to himself, not merely as a servant, but as a fellow Christian and a friend.

Scripture.

It is impossible to read over this admirable Epistle, without being touched with the delicacy of sentiment, and the matterly address that appear in every part of it. We see here, in a most striking light, how perfectly consistent true politeness is, not only with all the warmth and sincerity of the friend, but even with the dignity of the Christian and the apostle. And if this letter were to be considered in no other view than as a mere human composition, it must be allowed a master-piece in its kind. As an illustration of this remark, it may not be improper to compare it with an epistle of Pliny, that seems to have been written upon a similar occasion, (lib. ix. lit. 21); which, though penned by one that was reckoned to excel in the epistolary style, and though it has undoubtedly many beauties, yet must be acknowledged, by every impartial reader, vastly inferior to this animated composition of the apostle.

²¹⁶ The full and address which the apostle discovers in this Epistle.

The epistle to the Hebrews has been generally ascribed to Paul; but the truth of this opinion has been suspected by others, for three reasons: 1. The name of the writer is nowhere mentioned, neither in the beginning nor in any other part of the Epistle. 2. The style is said to be more elegant than Paul's. 3. There are expressions in the Epistle which have been thought unsuitable to an apostle's character. 1. In answer to the first objection, Clemens Alexandrinus has assigned a very good reason: "Writing to the Hebrews (says he), who had conceived a prejudice against him, and were suspicious of him, he wisely declined setting his name at the beginning, lest he should offend them." 2. Origen and Jerome admired the elegance of the style, and reckoned it superior to that which Paul has exhibited in his Epistles; but as ancient testimony had assigned it to Paul, they endeavoured to answer the objection, by supposing that the sentiments were the apostle's, but the language and composition the work of some other person. If the Epistle, however, be a translation, which we believe it to be, the elegance of the language may belong to the translator. As to the composition and arrangement, it cannot be denied that there are many specimens in the writings of this apostle not inferior

²¹⁷ Epistle to the Hebrews was composed by Paul.

Mistake on the Epistles.

to be led gradually to deny the thing signified. This appears to have been the cause of most disputes, and the general beginning of scepticism and infidelity.

Scripture. ferior in these qualities to the Epistle to the Hebrews. 3. It is objected, that in Heb. ii. 3. the writer of this Epistle joins himself with those who had received the gospel from Christ's apostles. Now Paul had it from Christ himself. But Paul often appeals to the testimony of the apostles in support of those truths which he had received from Revelation. We may instance 1 Cor. xv. 5, 6, 7, 8; 2. Tim. ii. 2.

218
Quoted as
being by
ancient
writers.

This Epistle is not quoted till the end of the second century, and even then does not seem to have been universally received. This silence might be owing to the Hebrews themselves, who supposing this letter had no relation to the Gentiles, might be at pains to diffuse copies of it. The authors, however, on whose testimony we receive it as authentic, are entitled to credit; for they lived so near the age of the apostles, that they were in no danger of being imposed on; and from the numerous list of books which they rejected as spurious, we are assured that they were very careful to guard against imposition. It is often quoted as Paul's by Clemens Alexandrinus, about the year 194. It is received and quoted as Paul's by Origen, about 230; by Dionysius bishop of Alexandria in 247; and by a numerous list of succeeding writers.

219
Written in
the Syro-
Chaldaic
language.

The Epistle to the Hebrews was originally written in Hebrew, or rather Syro-Chaldaic; a fact which we believe on the testimony of Clemens Alexandrinus, Jerome, and Eusebius. To this it has been objected, that as these writers have not referred to any authority, we ought to consider what they say on this subject merely as an opinion. But as they state no reasons for adopting this opinion, but only mention as a fact that Paul wrote to the Hebrews in their native language, we must allow that it is their testimony which they produce, and not their opinion. Eusebius informs us, that some supposed Luke the Evangelist, and others Clemens Romanus, to have been the translator.

According to the opinion of ancient writers, particularly Clemens Alexandrinus, Jerome, and Euthalius, this Epistle was addressed to the Jews in Palestine.—The force of the Epistle confirms this opinion.

220
Date of it.

Having now given sufficient evidence that this Epistle was written by Paul, the time when it was written may be easily determined: For the salutation from the saints of Italy (chap. iv. 24.), together with the apostle's promise to see the Hebrews (ver. 23.), plainly intimate, that his confinement was then either ended or on the eve of being ended. It must therefore have been written soon after the Epistles to the Colossians, Ephesians, and Philemon, and not long before Paul left Italy, that is, in the year 61 or 62.

221
Ferry's
Key to the
New Test.
Harmist.

As the zealous defenders of the Mosaic law would naturally insist on the divine authority of Moses, on the majesty and glory attending its promulgation by the ministry of angels, and the great privileges it afforded those who adhered to it; the apostle shows,

222
Defends it
to prove
to the Jews
the truth
of the Chr.
dispensation
and its
superiority
to the law
of Moses;

I. That in all these several articles Christianity had an infinite superiority to the law.

This topic he pursues from chap. i. to xi. wherein he reminds the believing Hebrews of the extraordinary favour shown them by God, in sending them a revelation by his own son, whose glory was far superior to that of angels (chap. i. throughout); very naturally inferring from hence the danger of despising Christ on account of his humiliation, which, in perfect con-

sistency with his dominion over the world to come, was voluntarily submitted to by him for wise and important reasons; particularly to deliver us from the fear of death, and to encourage the freedom of our access to God (chap. ii. throughout). With the same view he magnifies Christ as superior to Moses, their great legislator; and from the punishment inflicted on those who rebelled against the authority of Moses, infers the danger of contemning the promises of the gospel (chap. iii. 2—13.). And as it was an easy transition to call to mind on this occasion that rest in Canaan to which the authority invested in Moses was intended to lead them; the apostle hence cautions them against unbelief, as that would prevent their entering into a superior state of rest to what the Jews ever enjoyed (chap. iii. 14. iv. 11.). This caution is still farther enforced by awful views of God's omniscience, and a lively representation of the high-priesthood of Christ (chap. iv. to the end; and chap. v. throughout). In the next place, he intimates the very hopeless situation of those who apostatize from Christianity (chap. vi. 1—9.); and then, for the comfort and confirmation of sincere believers, displays to them the goodness of God, and his faithful adherence to his holy engagements; and the performance of which is sealed by the entrance of Christ into heaven as our forerunner (chap. vi. 9. to the end). Still farther to illustrate the character of our Lord, he enters into a parallel between him and Melchizedec as to their title and descent; and, from instances wherein the priesthood of Melchizedec excelled the Levitical, infers, that the glory of the priesthood of Christ surpassed that under the law (chap. vii. 1—17). From these premises the apostle argues, that the Aaronical priesthood was not only excelled, but consummated by that of Christ, to which it was only introductory and subservient; and of course, that the obligation of the law was henceforth dissolved (chap. vii. 18. to the end). Then recapitulating what he had already demonstrated concerning the superior dignity of Christ's priesthood, he thence illustrates the distinguished excellence of the new covenant, as not only foretold by Jeremiah, but evidently enriched with much better promises than the old (ch. viii. throughout); Explaining farther the doctrine of the priesthood and intercession of Christ, by comparing it with what the Jewish high-priests did on the great day of atonement (chap. ix. 1—14). Afterwards he enlarges on the necessity of shedding Christ's blood, and the sufficiency of the atonement made by it (chap. ix. 15. to the end); and proves that the legal ceremonies could not by any means purify the conscience: whence he infers the insufficiency of the Mosaic law, and the necessity of looking beyond it (chap. x. 1—15.). He then urges the Hebrews to improve the privileges which such an high-priest and covenant conferred on them, to the purposes of approaching God with confidence, to a constant attendance on his worship, and most benevolent regards to each other (chap. x. 15—25.).

Scripture.

The apostle having thus obviated the insinuations and objections of the Jews, for the satisfaction and establishment of the believing Hebrews, proceeds,

II. To prepare and fortify their minds against the storm of persecution which in part had already befallen them, which was likely to continue and be often renewed, he reminds them of those extremities they had endured, and of the fatal effects which would attend their

222
and to ani-
mate them
to bear
persecution
with ferti-
litude.

Scripture. apostacy (chap. x. 26. to the end); calling to their remembrance the eminent examples of faith and fortitude exhibited by holy men, and recorded in the Old Testament (chap. xi. 1—29.). He concludes his discourse with glancing at many other illustrious worthies; and, besides those recorded in Scripture, refers to the case of several who suffered under the persecution of Antiochus Epiphanes (2 Maccab. chap. viii. &c. chap. xi. 30. xii. 2.).

Having thus finished the argumentative part of the Epistle, the apostle proceeds to a general application; in which he exhorts the Hebrew Christians to patience, peace, and holiness (chap. xii. 3—14.); cautions them against secular views and sensual gratifications, by laying before them the incomparable excellence of the blessings introduced by the gospel, which even the Jewish economy, glorious and magnificent as it was, did by no means equal; exhorts them to brotherly affection, purity, compassion, dependence on the divine care, steadfastness in the profession of truth, a life of thankfulness to God, and benevolence to man: and concludes the whole with recommending their pious ministers to their particular regard, intreating their prayers, saluting and granting them his usual benediction.

The seven following Epistles, one of James, two of Peter, three of John, and one of Jude, have been distinguished by the appellation of *catholic* or *general* epistles, because most of them are inscribed, not to particular churches or persons, but to the body of Jewish or Gentile converts over the world. The authenticity of some of these has been frequently questioned, viz. the Epistle of James, the second of Peter, the Epistle of Jude, and the second and third of John. The ancient Christians were very cautious in admitting any books into their canon whose authenticity they had any reason to suspect. They rejected all the writings forged by heretics in the name of the apostles, and certainly, therefore, would not receive any without first subjecting them to a severe scrutiny. Now, though these five epistles were not immediately acknowledged as the writings of the apostles, this only shows that the persons who doubted had not received complete and incontestable evidence of their authenticity. But as they were afterwards universally received, we have every reason to conclude, that upon a strict examination they were found to be the genuine productions of the apostles.

The truth is, so good an opportunity had the ancient Christians of examining this matter, so careful were they to guard against imposition, and so well founded was their judgement concerning the books of the New Testament, that, as Dr Lardner observes, no writing which they pronounced genuine has yet been proved spurious, nor have we at this day the least reason to believe any book genuine which they rejected.

That the Epistle of James was written in the apostolical age is proved by the quotations of ancient authors. Clemens Romanus and Ignatius seem to have made references to it. Origen quotes it once or twice.—There are several reasons why it was not more generally quoted by the first Christian writers. Being written to correct the errors and vices which prevailed among the Jews, the Gentiles might think it of less importance to them, and therefore take no pains to procure copies of it. As the author was sometimes denominated James the Just, and often called bishop of Jerusalem, it might be doubt-

ed whether he was one of the apostles. But its authenticity does not seem to have been suspected on account of the doctrines which it contains. In modern times, indeed, Luther called it a strawy epistle (*epistola straminea*), and excluded it from the sacred writings, on account of its apparent opposition to the apostle Paul concerning justification by faith.

This Epistle could not be written by James the Elder, the son of Zebedee, and brother of John, who was beheaded by Herod in the year 41, for it contains passages which refer to a later period. It must, therefore, have been the composition of James the Less, the son of Alphaeus, who was called *the Lord's brother*, because he was the son of Mary, the sister of our Lord's mother. As to the date of this Epistle, Lardner fixes it in the The date year 61 or 62.

James the Less stately resided at Jerusalem, whence he hath been styled by some ancient fathers bishop of that city, though without sufficient foundation. Now James being one of the apostles of the circumcision, while he confined his personal labours to the inhabitants of Judea, it was very natural for him to endeavour by his writings to extend his services to the Jewish Christians who were dispersed abroad in more distant regions. For this purpose, there are two points which the apostle seems to have principally aimed at, though he hath not pursued them in an orderly and logical method, but in the free epistolary manner, handling them jointly or distinctly as occasions naturally offered. And these were, "to correct those errors both in doctrine and practice into which the Jewish Christians had fallen, which might otherwise have produced fatal consequences; and then to establish the faith and animate the hope of sincere believers, both under their present and their approaching sufferings."

The opinions which he is most anxious to refute are these, that God is the author of sin, (ch. i. 13.); that the belief of the doctrines of the gospel was sufficient to procure the favour of God for them, however deficient they were in good works, (ch. ii.). He dissuades the Jews from aspiring to the office of teachers in the third chapter, because their prejudices in favour of the law of Moses might induce them to pervert the doctrines of the gospel. He therefore guards them against the sins of the tongue, by representing their pernicious effects; and as they thought themselves wise and intelligent, and were ambitious of becoming teachers, he advises them to make good their pretensions, by showing themselves possessed of that wisdom which is from above, (ch. iii.).

The destruction of Jerusalem was now approaching; the Jews were split into factions, and often slaughtered one another; the apostle, therefore, in the fourth chapter, admonishes them to purify themselves from those vices which produced tumults and bloodshed. To rouse them to repentance, he foretells the miseries that were coming upon them. Lastly, He checks an irreligious spirit that seems to have prevailed, and concludes the Epistle with several exhortations.

The authenticity of the first Epistle of Peter has never been denied. It is referred to by Clemens, Romanus, by Polycarp, and is quoted by Papias, Irenaeus, Clemens Alexandrinus, and Tertullian. It is addressed to the strangers scattered through Pontus, &c. who are evidently Christians in general, as appears from chap.

Scripture.

225

Doddridge's Family Expositor.

226 and delightful.

227

Eusebius.

Scripture. chap. ii. 15. "In time past they were not a people, but are now the people of God." From Peter's sending the salutation of the church at Babylon to the Christians in Pontus, &c. it is generally believed that he wrote it in Babylon. There was a Babylon in Egypt and another in Assyria. It could not be the former, for it was an obscure place, which seems to have had no church for the first four centuries. We have no authority to affirm that Peter ever was in Assyria. The most probable opinion is that of Grotius, Whitty, Lardner, as well as of Eusebius, Jerome, and others, that by Babylon Peter figuratively means Rome. Lardner dates it in 63 or 64, or at the latest 65.

238
The date
239
and design
of it.

St Peter's chief design is to confirm the doctrine of St Paul, which the false teachers pretended he was opposing; and to assure the profelytes that they stood in the true grace of God, (ch. v. 12.). With this view he calls them cleft; and mentions, that they had been declared such by the effusion of the Holy Ghost upon them, (ch. i. 1, 2.). He assures them that they were regenerate without circumcision, merely through the gospel and resurrection of Christ, (ver. 3, 4, 21—25.); and that their sufferings were no argument of their being under the displeasure of God, as the Jews imagined, (ver. 6—12.). He recommends it to them to hope for grace to the end, (ver. 13.). He testifies, that they were not redeemed by the Paschal lamb, but through Christ, whom God had preordained for this purpose before the foundation of the world, (ver. 18—20.).

239
The second E-
pistle of
Peter. The
authenticity
of it
proved

The second Epistle of Peter is not mentioned by any ancient writer extant till the fourth century, from which time it has been received by all Christians except the Syrians. Jerome acquaints us, that its authenticity was disputed, on account of a remarkable difference between the style of it and the former Epistle. But this remarkable difference in style is confined to the 2d chapter of the 2d Epistle. No objection, however, can be drawn from this circumstance; for the subject of that chapter is different from the rest of Peter's writings, and nothing is so well known than that different subjects suggest different styles. Peter, in describing the character of some flagitious impostors, feels an indignation which he cannot suppress: it breaks out, therefore, in the bold and animated figures of an oriental writer. Such a diversity of style is not uncommon in the best writers, especially when warmed with their subject.

241
The internal
evidence.

This objection being removed, we contend that this Epistle was written by Peter, from the inscription, *Simon Peter, a servant and an apostle of Jesus Christ*. It appears from chap. i. 16, 17, 18, that the writer was one of the disciples who saw the transfiguration of our Saviour. Since it has never been ascribed to James or John, it must therefore have been Peter. It is evident, from chap. iii. 1. that the author had written an Epistle before to the same persons, which is another circumstance that proves Peter to be the author.

It is acknowledged, however, that all this evidence is merely internal; for we have not been able to find any external evidence upon the subject. If, therefore, the credit which we give to any fact is to be in proportion to the degree of evidence with which it is accompanied, we shall allow more authority due to the gospels than to the epistles; more to those epistles which have been generally acknowledged than to those which have been

controverted; and therefore no doctrine of Christianity ought to be founded solely upon them. It may also be added, that perhaps the best way of determining what are the essential doctrines of Christianity would be to examine what are the doctrines which occur oftenest in the gospels; for the gospels are the plainest parts of the New Testament; and their authenticity is most completely proved. They are therefore best fitted for common readers. Nor will it be denied, we presume, that our Saviour taught all the doctrines of the Christian religion himself; that he repeated them on different occasions, and inculcated them with an earnestness proportionable to their importance. The Epistles are to be considered as a commentary on the essential doctrines of the gospel, adapted to the situation and circumstances of particular churches, and perhaps sometimes explaining doctrines of inferior importance. 1. The essential doctrines are therefore first to be sought for in the gospels, and to be determined by the number of times they occur. 2. They are to be sought for, in the next place, in the uncontroverted Epistles, in the same manner. 3. No essential doctrine ought to be founded on a single passage, nor on the authority of a controverted Epistle.

That Peter was old, and near his end, when he wrote this Epistle, may be inferred from chap. i. 14. "Knowing that shortly I must put off this tabernacle, even as our Lord Jesus has shewn me." Lardner thinks it was written soon after the former. Others, perhaps with more accuracy, date it in 67.

232
Design of

The general design of this Epistle is, to confirm the doctrines and instructions delivered in the former; "to excite the Christian converts to adorn, and steadfastly adhere to their holy religion, as a religion proceeding from God, notwithstanding the artifices of false teachers, whose character is at large described; or the persecution of their bitter and inveterate enemies."

The first Epistle of John is ascribed by the unanimous suffrage of the ancients to the beloved disciple of our Lord. It is referred to by Polycarp, is quoted by Papias, by Irenaeus, and was received as genuine by Clements Alexandrinus, by Dionysius of Alexandria, by Eusebius, by Origen, and Eusebius. There is such a resemblance between the style and sentiments of this Epistle and those of the gospel according to John, as to afford the highest degree of internal evidence that they are the composition of the same author. In the style of this apostle there is a remarkable peculiarity, and especially in this Epistle. His sentences, considered separately, are exceeding clear and intelligible; but when we search for their connection, we frequently meet with greater difficulties than we do even in the Epistles of St Paul. The principal signature and characteristic of his manner is an artless and amiable simplicity, and a singular modesty and candour, in conjunction with a wonderful subtilty of sentiment. His conceptions are apparently delivered to us in the order in which they arose to his own mind, and are not the product of artificial reasoning or laboured investigation.

233
First E-
pistle of
John. Its
authenticity
and
style.

It is impossible to fix with any precision the date of this Epistle, nor can we determine to what persons it was addressed.

The leading design of the apostle is to show the insufficiency of faith, and the external profession of religion, separate from morality; to guard the Christians to whom he writes against the delusive arts of the corrupters

234
Design of

rupters of Christianity, whom he calls Antichrist; and to inculcate universal benevolence. His admonitions concerning the necessity of good morals, and the inefficacy of external professions, are scattered over the Epistle, but are most frequent in the 1st, 2d, and 3d chapters. The enemies or corruptors of Christianity, against whom he contends, seem to have denied that Jesus was the Messiah, the Son of God (chap. ii. 22. v. 1.), and had actually come into the world in a human form, (chap. iv. 2, 3.). The earnestness and frequency with which this apostle recommends the duty of benevolence is remarkable. He makes it the distinguishing characteristic of the disciples of Jesus, the only true pledge of our love to God, and the only assurance of eternal life, (chap. iii. 34, 15.). Benevolence was his favourite theme, which he affectionately pressed upon others, and constantly practised himself. It was conspicuous in his conduct to his great Master, and in the reciprocal affection which it inspired in his sacred breast. He continued to recommend it in his last words. When his extreme age and infirmities had so wasted his strength that he was incapable to exercise the duties of his office, the venerable old man, anxious to exert in the service of his Master the little strength which still remained, caused himself to be carried to church, and, in the midst of the congregation, he repeated these words, "Little children, love one another."

It has been observed by Dr Mill that the second and third Epistles of John are so short, and resemble the first so much in sentiment and style, that it is not worth while to contend about them. The second Epistle consists only of 13 verses; and of these eight may be found in the 1st Epistle, in which the sense or language is precisely the same.

The second Epistle is quoted by Irenæus, and was received by Clemens Alexandrinus. Both were admitted by Athanasius, by Cyril of Jerusalem, and by Jerome. The second is addressed to a woman of distinction whose name is by some supposed to be *Cyria* (taking *κωρια* for a proper name), by others *Ecelesta*. The third is ascribed to Gaius, or Caius according to the Latin orthography, who, in the opinion of Lardner, was an eminent Christian, that lived in some city of Asia not far from Ephesus, where St John chiefly resided after his leaving Judea. The time of writing these two Epistles cannot be determined with any certainty. They are so short that an analysis of them is not necessary.

The Epistle of Jude is cited by no ancient Christian writer extant before Clemens Alexandrinus about the year 194; but this author has transcribed eight or ten verses in his *Stromata* and *Pedagogue*. It is quoted once by Tertullian about the year 200; by Origen frequently about 230. It was not however received by many of the ancient Christians, on account of a supposed quotation from a book of Enoch. But it is not certain that Jude quotes any book. He only says that *Enoch prophesied, saying, The Lord cometh with ten thousand of his saints*. These might be words of

a prophecy preserved by tradition, and inserted occasionally in different writings. Nor is there any evidence that there was such a book as Enoch's prophecies in the time of Jude, though a book of that name was extant in the second and third centuries. As to the date of this Epistle nothing beyond conjecture can be produced.

The design of it is, by describing the character of false teachers, and the punishments to which they were liable, to caution Christians against listening to their suggestions, and being thereby perverted from the faith and purity of the gospel.

The Apocalypse or Revelation has not always been unanimously received as the genuine production of the apostle John. Its authenticity is proved, however, by the testimony of many respectable authors of the first centuries. It is referred to by the martyrs of Lyons: it was admitted by Justin Martyr as the work of the apostle John. It is often quoted by Irenæus, by Theophilus bishop of Antioch, by Clement of Alexandria, by Tertullian, by Origen, and by Cyprian of Carthage. It was also received by heretics, by Novatus and his followers, by the Donatists, and by the Arians. For the first two centuries no part of the New Testament was more universally acknowledged, or mentioned with higher respect. But a dispute having arisen about the millennium, Caius with some others, about the year 212, to end the controversy as speedily and effectually as possible, ventured to deny the authority of the book which had given occasion to it.

The book of Revelation, as we learn from Rev. i. 9. was written in the isle of Patmos. According to the general testimony of ancient authors, John was banished into Patmos in the reign of Domitian, and restored by his successor Nerva. But the book could not be published till after John's release, when he returned to Ephesus. As Domitian died in 96, and his persecution did not commence till near the end of his reign, the Revelation might therefore be published in 96 or 97.

Here we should conclude; but as the curious reader may desire to be informed how the predictions revealed in the book of St John have usually been interpreted and applied, we shall consistently with our subject subjoin a key to the prophecies contained in the Revelation. This is extracted from the learned dissertations of Dr Newton, bishop of Bristol (1): to which the reader is referred for a more full illustration of the several parts, as the conciseness of our plan only admits a short analysis or abridgment of them.

Nothing of a prophetic nature occurs in the first three chapters, except, 1. What is said concerning the church of Ephesus, that her "candlestick shall be removed out of its place," which is now verified, not only in this, but in all the other Asiatic churches which existed at that time; the light of the gospel having been taken from them, not only by their heresies and divisions from within, but by the arms of the Saracens from without: And, 2. Concerning the church of Smyrna, that she shall "have tribulation ten days;" that is, in prophetic language,

(1) Dissertations on the prophecies which have remarkably been fulfilled, and at this time are fulfilling, in the world, vol. iii. 8vo.

Scripture. guage, " ten years ;" referring to the persecution of Dioclesian, which alone of all the general persecutions lasted so long.

The next five chapters relate to the opening of the *Seven Seals*; and by these seals are intimated so many different periods of the prophecy. Six of these seals are opened in the sixth and seventh chapters.

The *first seal* or period is memorable for conquests. It commences with Vespasian, and terminates in Nerva; and during this time Judea was subjugated. The *second seal* is noted for war and slaughter. It commences with Trajan, and continues through his reign, and that of his successors. In this period, the Jews were entirely routed and dispersed; and great was the slaughter and devastation occasioned by the contending parties. The *third seal* is characterized by a rigorous execution of justice, and an abundant provision of corn, wine, and oil. It commences with Septimius Severus. He and Alexander Severus were just and severe emperors, and at the same time highly celebrated for the regard they paid to the felicity of their people, by procuring them plenty of every thing, and particularly corn, wine, and oil. This period lasted during the reigns of the Septimian family. The *fourth seal* is distinguished by a concurrence of evils, such as war, famine, pestilence, and wild beasts; by all which the Roman empire was remarkably afflicted from the reign of Maximin to that of Dioclesian. The *fifth seal* begins at Dioclesian, and is signalized by the great persecution, from whence arose that memorable era, the Era of Martyrs. With Constantine begins the *sixth seal*, a period of revolutions, pictured forth by great commotions in earth and in heaven, alluding to the subversion of Paganism and the establishment of Christianity. This period lasted from the reign of Constantine the Great to that of Theodosius the first. The *seventh seal* includes under it the remaining parts of the prophecy, and comprehends seven periods distinguished by the sounding of seven trumpets.

As the seals foretold the state of the Roman empire before and till it became Christian, so the trumpets foretold the fate of it afterwards; each trumpet being an alarm to one nation or other, rousing them up to overthrow that empire.

Four of these trumpets are sounded in the eighth chapter.

At the founding of the first, Alaric and his Goths invade the Roman empire, besiege Rome twice, and set it on fire in several places. At the founding of the second, Attila and his Huns waste the Roman provinces, and compel the eastern emperor Theodosius the second, and the western emperor Valentinian the third, to submit to shameful terms. At the founding of the third, Genserich and his Vandals arrive from Africa; spoil and plunder Rome, and set sail again with immense wealth and innumerable captives. At the founding of the fourth, Odoacer and the Heruli put an end to the very name of the western empire; Theodoric founds the kingdom of the Ostrogoths in Italy; and at last Italy becomes a province of the eastern empire, Rome being governed by a duke under the exarch of Ravenna. As the foregoing trumpets relate chiefly to the downfall of the western empire, so do the following to that of the eastern. They are sounded in the ninth, tenth, and part of the eleventh chapters. At the founding of the

Scripture. fifth trumpet, Mahomet, that blazing star, appears, opens the bottomless pit, and with his locusts the Arabians darkens the sun and air. And at the founding of the sixth, a period not yet finished, the four angels, that is, the four sultans, or leaders of the Turks and Othmans, are loosed from the river Euphrates. The Greek or Eastern empire was cruelly "hurt and tormented" under the fifth trumpet; but under the sixth, was "slain," and utterly destroyed.

The Latin or Western Church not being reclaimed by the ruin of the Greek or Eastern, but still persisting in their idolatry and wickedness; at the beginning of the tenth chapter, and under the sound of this sixth trumpet, is introduced a vision preparative to the prophecies respecting the Western Church, wherein an angel is represented, having in his hand a little book, or codicil, describing the calamities that should overtake that church. The measuring of the temple shows, that during all this period there will be some true Christians, who will conform themselves to the rule of God's word, even whilst the outer court, that is, the external and more extensive part of this temple or church, is trodden under foot by Gentiles, i. e. such Christians as, in their idolatrous worship and persecuting practice, resemble and outdo the Gentiles themselves. Yet against these corrupters of religion there will always be some true witnesses to protest, who, however they may be overborne at times, and in appearance reduced to death, yet will arise again from time to time, till at last they triumph and gloriously ascend. The eleventh chapter concludes with the sounding of the seventh trumpet.

In the twelfth chapter, by the woman bearing a man-child is to be understood the Christian church; by the great red dragon, the heathen Roman empire; by the man-child whom the woman bore, Constantine the Great; and by the war in heaven, the contests between the Christian and Heathen religions.

In the thirteenth chapter, by the beast with seven heads and ten horns, unto whom the dragon gave his power, seat, and great authority, is to be understood, not Pagan but Christian, not imperial but papal Rome; in submitting to whose religion, the world did in effect submit again to the religion of the dragon. The ten-horned beast therefore represents the Romish church and state in general: but the beast with two horns like a lamb is the Roman clergy; and that image of the ten-horned beast, which the two-horned beast caused to be made, and inspired with life, is the pope; whose number is 666, according to the numerical powers of the letters constituting the Roman name *Ahazazel*, *Latinus*, or its equivalent in Hebrew, רמית *Romit*.

A	300	200	7
A	1	6	7
T	300	40	6
E	5	10	1
I	10	10	1
N	50	400	6
O	70		
Σ	200		

666

666

Chapter xiv. By the lamb on Mount Zion is meant Jesus; by the hundred forty and four thousand, his church and followers; by the angel preaching the ever-

lasting

lasting gospel, the first principal effort made towards a reformation by that public opposition formed against the worship of saints and images by emperors and bishops in the eighth and ninth centuries; by the angel crying, "Babylon is fallen," the Waldenses and Albigenses, who pronounced the church of Rome to be the Apocalyptic Babylon, and denounced her destruction; and by the third angel Martin Luther and his fellow reformers, who protested against all the corruptions of the church of Rome, as destructive to salvation. For an account of the doctrines and precepts contained in the Scriptures, see THEOLOGY. For proofs of their divine origin, see RELIGION, PROPHECY, and MIRACLES.

SCRIVENER, one who draws contracts, or whose business it is to place money at interest. If a scrivener be entrusted with a bond, he may receive the interest; and if he fail, the obligee shall bear the loss; and so it is if he receive the principal and deliver up the bond; for being entrusted with the security itself, it must be presumed that he is trusted with power to receive interest or principal; and the giving up the bond on payment of the money shall be a discharge thereof. But if a scrivener shall be entrusted with a mortgage-deed, he hath only authority to receive the interest, not the principal; the giving up the deed in this case not being sufficient to restore the estate, but there must be a reconveyance, &c. It is held, where a scrivener puts out his client's money on a bad security, which upon inquiry might have been easily found so, yet he cannot in equity be charged to answer for the money; for it is here said, no one would venture to put out money of another upon a security, if he were obliged to warrant and make it good in case a loss should happen, without any fraud in him.

SCROBICULUS CORDIS, the same as ANTICARDIUM.

SCROFANELLO, in Ichthyology, a name by which some have called a small fish of the Mediterranean, more usually known by the name of the *serpenna*.

SCROLL, in Heraldry. See that article, chap. iv. sect. 9. When the motto relates to the crest, the scroll is properly placed above the achievement; otherwise it should be annexed to the escutcheon. Those of the order of knighthood are generally placed round shields.

SCROPHULA, the KING'S EVIL. See MEDICINE, N^o 349.

SCROPHULARIA, FIGWORT, a genus of plants belonging to the didymia class, and in the natural method ranking under the 45th order, *Personate*. See BOTANY Index.

SCROTUM. See ANATOMY, N^o 222.

SCRUPLE, SCRUPULUS, or *Scrupulum*, the least of the weights used by the ancients, which amongst the Romans was the 24th part of an ounce, or the 3d part of a dram. The scruple is still a weight among us, containing the 3d part of a dram, or 25 grains. Among goldsmiths it is 24 grains.

SCRUPLE, in Chaldean Chronology, is $\frac{1}{24}$ part of an hour, called by the Hebrews *halakin*. These scruples are much used by the Jews, Arabs, and other eastern people, in computations of time.

SCRUPLES of half Duration, an arch of the moon's

orbit, which the moon's centre describes from the beginning of an eclipse to its middle.

SCRUPLES of Immersion or Incidence, an arch of the moon's orbit, which her centre describes from the beginning of the eclipse to the time when its centre falls into the shadow.

SCRUPLES of Emerison, an arch of the moon's orbit, which her centre describes in the time from the emergence of the moon's limb to the end of the eclipse.

SCRUTINY, (*Scrutinium*), in the primitive church, an examination or probation practised in the last week of Lent, on the catechumens, who were to receive baptism on the Easter-day. The scrutiny was performed with a great many ceremonies. Exorcisms and prayers were made over the heads of the catechumens; and on Palm Sunday, the Lord's Prayer and Creed were given them, which they were afterwards made to rehearse. This custom was more in use in the church of Rome than anywhere else; though it appears, by some mistakes, to have been likewise used, though much later, in the Gallican church. It is supposed to have ceased about the year 862. Some traces of this practice still remain at Vienne, in Dauphiné, and at Liege.

SCRUTINY, is also used, in the Canon Law, for a ticket or little paper billet, wherein at elections the electors write their votes privately, so as it may not be known for whom they vote. Among us the term *scrutiny* is chiefly used for a strict perusal and examination of the several votes hastily taken at an election; in order to find out any irregularities committed therein, by unqualified voters, &c.

SCRUTOIRE, or SCRUTOIR (from the French *escrivoire*), a kind of cabinet, with a door or lid opening downwards, for convenience of writing on, &c.

SCRY, in falconry, denotes a large flock of fowl.

SCUDDING, the movement by which a ship is carried precipitately before a tempest. As a ship flies with amazing rapidity through the water whenever this expedient is put in practice, it is never attempted in a contrary wind, unless when her condition renders her incapable of sustaining the mutual effort of the wind and waves any longer on her side, without being exposed to the most imminent danger of being over-set.

A ship either scuds with a sail extended on her foremast, or, if the storm is excessive, without any sail; which, in the sea-phrase, is called *scudding under bare poles*. In floops and schooners, and other small vessels, the sail employed for this purpose is called the *square sail*. In large ships, it is either the foresail at large, reefed, or with its goose-wings extended, according to the degree of the tempest; or it is the fore-top sail, close reefed, and lowered on the cap; which last is particularly used when the sea runs so high as to becalm the foresail occasionally, a circumstance which exposes the ship to the danger of broaching to. The principal hazards incident to scudding are generally, a pooping sea; the difficulty of steering, which exposes the vessel perpetually to the risk of broaching to; and the want of sufficient sea-room. A sea striking the ship violently on the stem may dash it inwards, by which the masts inevitably founder. In broaching to (that is, inclining suddenly to windward), she is threatened with being immediately overturned; and, for want of sea-room, she is endangered.

directed by shipwreck on a sea-shore, a circumstance too dreadful to require explanation.

SCULPONE, among the Romans, a kind of

shoes worn by slaves of both sexes. These shoes were made of one block of wood made hollow, like the French sabots.

S C U L P T U R E,

IS the art of carving wood or hewing stone into images. It is an art of the most remote antiquity, being practised, as there is reason to believe, before the general deluge. We are induced to assign to it its early origin, by considering the expedients by which, in the full stages of society, men have everywhere supplied the place of alphabetical characters. These, it is universally known, have been picture-writing, such as that of the Mexicans, which, in the progress of refinement and knowledge, was gradually improved into the Hieroglyphics of the Egyptians and other ancient nations. See HIEROGLYPHS.

That mankind should have lived near 1700 years, from the creation of the world to the flood of Noah, without falling upon any method to make their conceptions permanent, or to communicate them to a distance, is extremely improbable; especially when we call to mind that such methods of writing have been found, in modern times, among people much less enlightened than those must have been who were capable of building such a vessel as the ark. But if the antediluvians were acquainted with any kind of writing, there can be little doubt of its being hieroglyphical writing. Mr Bryant has proved that the Chaldeans were possessed of that art before the Egyptians; and Berossus* informs us, that a delineation of all the monstrous forms which inhabited the chaos, when this earth was in that state, was to be seen in the temple of Belus in Babylon. This delineation, as he describes it, must have been a history in hieroglyphical character; for it consisted of human figures with wings, with two heads, and some with the horns and legs of goats. This is exactly similar to the hieroglyphical writing of the Egyptians; and it was preferred, our author says, both in drawings and engravings in the temple of the god of Babylon. As Chaldea was the first peopled region of the earth after the flood, and as it appears from Pliny†, as well as from Berossus, that the art of engraving on bricks baked in the sun was there carried to a considerable degree of perfection at a very early period, the probability certainly is, that the Chaldeans derived the art of hieroglyphical writing, and consequently the rudiments of the art of sculpture, from their antediluvian ancestors.

It is generally thought that sculpture had its origin from idolatry, as it was found necessary to place before the people the images of their gods to excite the fervour of their devotion; but this is probably a mistake. The worship of the heavenly bodies, as the only gods of the heathen nations, prevailed long before the deification of dead men was thought of (see POLYTHEISM), that we cannot suppose mankind to have been, during all that time, ignorant of the art of hieroglyphical writing. But the deification of departed heroes undoubtedly gave rise to the almost universal practice of representing the gods by images of a human form; and therefore we must conclude, that the elements of scul-

ture were known before that art was employed to enliven the devotion of idolatrous worshippers. The pyramids and obelisks of Egypt, which were probably temples, or rather altars, dedicated to the sun (see PYRAMID), were covered from top to bottom with hieroglyphical emblems of men, beasts, birds, fishes, and reptiles, at a period prior to that in which there is any unexceptionable evidence that mere statue-worship prevailed even in that nursery of idolatry.

But though it appears thus evident that picture-writing was the first employment of the sculptor, we are far from imagining that idolatrous worship did not contribute to carry his art to that perfection which it attained in some of the nations of antiquity. Even in the dark ages of Europe, when the other fine arts were almost extinguished, the mummery of the church of Rome, and the veneration which she taught her saints and martyrs, preferred among the Latins some vestiges of the finer-arts of sculpture and painting; and therefore, as human nature is everywhere the same, it is reasonable to believe that a similar veneration for heroes and demigods would, among the ancient nations, have a similar effect. But if this be so, the presumption is, that the Chaldeans were the first who invented the art of hewing blocks of wood and stone into the figures of men and other animals; for the Chaldeans were unquestionably the first idolaters, and their early progress in sculpture is confirmed by the united testimonies of Berossus, Alexander Polyhistor, Apollodorus, and Pliny; not to mention the eastern tradition, that the father of Abraham was a statue.

Against this conclusion Mr Browley, in his late History of the Fine Arts, has urged some plausible arguments. In stating these he protests not to be original, or to derive his information from the fountain-head of antiquity. He adds, as he tells us, the theory of a French writer, who maintains, that in the year of the world 1949, about 300 years after the deluge, the Scythians under Brouma, a descendant of Magog the son of Japhet, extended their conquests over the greater part of Asia. According to this system, Brouma was not only the civilizer of India, and the author of the Braminical doctrines, but also diffused the principles of the Scythian mythology over Egypt, Phœnicia, Greece, and the orient of Asia.

Of these principles Mr Browley has given us no distinct enumeration; the account which he gives of them is not to be found in one place, but to be collected from a variety of distant passages. In attempting therefore to present the substance of his scattered hints in one view, we will not be confident that we have omitted none of them. The ox, says he, was the Scythian emblem of the generator of animal life, and hence it became the principal divinity of the Arabians. The serpent was the symbol of the source of intellect and nature. These were the common points of union in all the first religions.

See on
the
art of
sculpture.

See
Berossus,
Polyhistor,
Pliny.

See
Pliny, Nat.
Hist. lib. 36.

See
Browley
on Idolatry.

3
thought
probably
contributed
to carry
the art to
perfection.

4
Mr. Browley's
theory, that
sculpture
was invented
by the
Scythians.

ingloss of the earth. From Egypt the Israelites carried with them a religious veneration for the ox and the serpent. Their veneration for the ox appeared soon after they marched into the wilderness, when in the absence of Moses they called upon Aaron to make them gods which should go before them. The idea of having an idol to go before them, says our author, was completely Scythian; for so the Scythians acted in all their progress through Asia, with this difference, that their idol was a living animal. The Israelites having gained their favourite god, which was an ox (not a calf as it is rendered in the book of Exodus), next proceeded to hold a festival, which was to be accompanied with dancing; a species of gaiety common in the festivals which were held in adoration of the emblematic *Uroos* or ox in that very part of Arabia near Mount Sinai where this event took place. It is mentioned too as a curious and important fact, that the ox which was revered in Arabia was called *Adonai*. Accordingly Aaron announcing the feat to the ox or golden calf, speaks thus, *to-morrow is a feast to Adonai*, which is in our translation rendered to the Lord. In the time of Jeroboam we read of the golden calves set up as objects of worship at Bethel and Dan. Nor was the reverence paid to the ox confined to Scythia, to Egypt, and to Asia; it extended much farther. The ancients Cimbrici, as the Scythians did, carried an ox of bronze before them on all their expeditions. Mr Bromley also informs us, that as great respect was paid to the living ox among the Greeks as was offered to its symbol among other nations.

The emblem of the serpent, continues Mr Bromley, was marked yet more decidedly by the express direction of the Almighty. That animal had ever been considered as emblematic of the supreme generating power of intelligent life: And was that idea, says he, discouraged, so far as it went to be a sign or symbol of life, when God said to Moses, "Make thee a brazen serpent, and set it on a pole, and it shall come to pass that every one who is bitten, when he looketh on it, shall live." In Egypt the serpent surrounded their Isis and Osiris, the diadems of their priests, and the bonnets of their priests. The serpent made a distinguished figure in Grecian sculpture. The table of Echidne, the mother of the Scythians, gave her figure terminating as a serpent to all the founders of States in Greece; from which their earliest sculptors represented in that form the Titan princes, Cecrops, Draco, and even Eteochus. Besides the spear of the image of Minerva, which Phidias made for the citadel of Athens, he placed a serpent, which was supposed to guard that goddess.

The serpent was combined with many other figures. It sometimes was coiled round an egg as an emblem of the creation; sometimes round a vessel, to show its power over the sea; sometimes it encircled a lamb, to represent life and death.

In Egypt, as well as in Scythia and India, the divinity was represented on the leaves of the tamaric or lotus. Pan was worshipped as a god in that country, as well as over the east. Their sphinxes, and all their combined figures of aimal creation, to mark their origin from the mother of the Scythians, who brought forth an offspring that was half a woman and half a serpent. Their pyramids and obelisks were like the idea of the

the first emblem of the serpent, which was used by the Scythians, and which even the influence of Zoroaster and the Magi could not remove.

We are told that the Bacchus of the Greeks derived from the Brouma of the Indians; that both are represented as seated on a swan swimming over the waves, to indicate that each was the god of liquid nature, not the god of wine, but the god of waters. The mitre of Bacchus was shaped like half an egg; an emblem taken from this circumstance, that at the creation the egg from which all things sprung was divided in the middle. Pan also was revered among the Scythians; and from that people were derived all the emblems by which the Greeks represented this divinity.

It would be tedious to follow our author through the whole of this subject; and were we to submit to the labour of collecting and arranging his scattered materials, we should still view his system with some degree of suspicion. It is drawn, as he informs us, from the work of M. D'Anearville, intitled, *Recherches sur l'origine, l'Esprit, et les Progres, des Arts de la Grece*.

To form conclusions concerning the origin of nations, the rise and progress of the arts and sciences, without the aid of historical evidence, by analogies which are sometimes accidental, and often fanciful, is a mode of reasoning which cannot readily be admitted. There may indeed, we acknowledge, be resemblances in the religion, language, manners, and customs of several nations, so striking and so numerous, that the supposition of their being descended from the same stock would appear of seipitum. But historical theories must not be adopted rashly. We must be certain that the evidence is credible and satisfactory before we proceed to deduce any conclusions. We must first know whether the Scythian history itself be authentic, before we make any comparison with the history of other nations. But what is called the Scythian history, every man of learning knows to be a collection of fables. Herodotus and Justin are the two ancient writers from whom we have the fullest account of that warlike nation; but these two historians contradict each other, and both write what cannot be believed of the same people at the same period of their progress. Justin tells us, that there was a long and violent contest between the Scythians and Egyptians about the antiquity of their respective nations; and after stating the arguments on each side of the question, which, as he gives them, are nothing to the purpose, he decides in favour of the claim of the Scythians. Herodotus was too partial to the Egyptians, not to give them the palm of antiquity; and he was probably in the right; for Justin describes his most ancient of nations, even in the time of Darius Hyastes, as ignorant of all the arts of civil life. "They occupied their land in common (says he), and cultivated none of it. They had no houses nor settled habitations, but wandered with their cattle from desert to desert. In their rambles they carried their wife and children in tumbrils covered with the skins of beasts, which served as haunts to protect them from the storms of winter. They were without laws, governed by the dictates of natural equity. They coveted not gold or silver like the rest of mankind, and lived upon milk and honey. Though they were exposed to extreme cold, and had abundance of flocks, they knew not how to make garments of wool, but clothed themselves in the skins of

Lib. vi.
Lib. vii.
Lib. iv.
cap. 62.

wild beasts &c." This is the most favourable account which any ancient writer gives of the Scythians. By Strabo † and Herodotus ‡ they are represented as the most savage of mortals, delighting in war and bloodshed, cutting the throats of all strangers who came among them, eating their flesh, and making cups and pots of their skulls. Is it conceivable that such savages could be sculptors; or that, even supposing their manners to have been such as Justin represents them, a people so simple and ignorant could have imposed their mythology upon the Chaldeans, Phenicians, and Egyptians, whom we know by the most incontrovertible evidence to have been great and polished nations so early as in the days of Abraham? No! We could as soon admit other novelties of more importance, with which the French of the present age pretend to enlighten the world, as this origin assigned by Mr Bromley to the art of sculpture, unless supported by better authority than that of D'Anceville.

The inference of our author from the name of the sacred ox in Arabia, and from the dancing and gaiety which were common in the religious festivals of the Arabians, appears to us to be very hastily drawn. At the early period of the departure of the Israelites from Egypt, the language of the Hebrews, Egyptians, and Arabians, differed not more from each other than do the different dialects of the Greek tongue which are found in the poems of Homer (see PHILOLOGY, Sect. III.); and it is certain, that for many years after the formation of the golden-calf, the Hebrews were strangers to every species of idolatry but that which they had brought with them from their house of bondage. See REMPHAM.

Taking for granted, therefore, that the Scythians did not impose their mythology on the eastern nations, and that the art of sculpture, as well as hieroglyphic writing and idolatrous worship, prevailed first among the Chaldeans, we shall endeavour to trace the progress of this art through some other nations of antiquity, till we bring it to Greece, where it was carried to the highest perfection to which it has yet attained.

The first intimation that we have of the art of sculpture is in the book of Genesis, where we are informed, that when Jacob, by the divine command, was returning to Canaan, his wife Rachel carried along with her the teraphim or idols of her father. These we are assured were small, since Rachel found it so easy to conceal them from her father, notwithstanding his anxious search. We are ignorant, however, how these images were made, or of what materials they were composed. The first person mentioned as an artist of eminence is Bezzeel, who formed the cherubims which covered the mercy-seat.

The Egyptians also cultivated the art of sculpture; but there were two circumstances which obstructed its progress. 1. The passions of the Egyptians were not possessed of the graces of form, of elegance, or of symmetry; and of consequence they had no perfect standard to model their taste. They resembled the Chinese in the cast of their face, in their great bellies, and in the clumsily rounding of their contours. 2. They were restrained by their laws to the principles and practices of their ancestors, and were not permitted to introduce any innovations. Their statues were always formed in the same stiff attitude, with the arms hanging perpendicu-

ly down the sides. What perfection were they capable of who knew no other attitude than that of chairmen? So far were they from attempting any improvements, that in the time of Adrian the art continued in the same rude state as at first; and when their slavish adulation to that emperor induced them to place the statue of his favourite Antinous among the objects of their worship, the same inanimate stiffness in the attitude of the body and position of the arms was observed. We believe it will scarcely be necessary to inform our readers that the Egyptian statue just now mentioned is very different from the celebrated statue of Antinous, of which so many moulds have been taken that imitations of it are now to be met with almost in every cabinet in Europe.

Notwithstanding the attachment of the Egyptians to ancient usages, Winkelman thinks he has discovered two different styles of sculpture which prevailed at different periods. The first of these ends with the conquest of Egypt by Cambyzes. The second begins at that time, and extends beyond the reign of Alexander the Great. In the first style, the lines which form the contour are straight and projecting a little; the position is stiff and unnatural; in sitting figures the legs are parallel, the feet squeezed together, and the arms fixed to the sides; but in the figures of women the left arm is folded across the breast; the bones and muscles are faintly discernible; the eyes are flat and looking obliquely, and the eyebrows sunk—features which destroy entirely the beauty of the head; the cheek-bones are high, the chin small and piked; and the ears are generally placed higher than in nature, and the feet are too large and flat. In short, if we are to look for any model in the statues of Egypt, it is not for the model of beauty but of deformity. The statues of men are naked, only they have a short apron, and a few folds of drapery surrounding their waist: The vestments of women are only distinguishable by the border, which rises a little above the surface of the statue. In this age it is evident the Egyptians knew little of drapery.

Of the second style of sculpture practiced among the Egyptians, Winkelman thinks he has found specimens in the two figures of basaltines in the Capitol, and in another figure at Villa Albani, the head of which has been renewed. The first two of these, he remarks, bear visible traces of the former style, which appear especially in the form of the mouth and shortness of the chin. The hands possess more elegance; and the feet are placed at a greater distance from each other, than was customary in more ancient times. In the first and third figures the arms hang down close to the sides. In the second they hang more freely. Winkelman suspects that these three statues have been made after the conquest of Egypt by the Greeks. They are clothed with a tunic, a robe, and a mantle. The tunic, which is puckered into many folds, descends from the neck to the ground. The robe in the first and third statues seems close to the body, and is only perceptible by some little folds. It is tied under the breast, and covered by the mantle, the two buttons of which are placed under the epaulet.

The Antinous of the Capitol is composed of two pieces, which are joined under the haunches. But as all the Egyptian statues which now remain have been hewn out of one block, we must believe that Diocorus,

6
Egyptian
sculpture.

7
First style.

8
Second style.

in faying the stone was divided, and each half finished by a separate artizan, spoke only of a colossus. The same author informs us, that the Egyptians divided the human body into 24½ parts; but it is to be regretted that he has not given a more minute detail of that division.

The Egyptian statues were not only formed by the chisel, they were also polished with great care. Even those on the summit of an obelisk, which could only be viewed at a distance, were finished with as much labour and care as if they had admitted a close inspection. As they are generally executed in granite or basaltes, stones of a very hard texture, it is impossible not to admire the indefatigable patience of the artists.

The eye was often of different materials from the rest of the statue; sometimes it was composed of a precious stone or metal. We are assured that the valuable diamond of the empress of Russia, the largest and most beautiful hitherto known, formed one of the eyes of the famous statue of Scheringham in the temple of Brama.

Those Egyptian statues which still remain are composed of wood or baked earth: and the statues of earth are covered with green enamel.

The Phenicians possessed both a character and situation highly favourable to the cultivation of statuary. They had beautiful models in their own persons, and their industrious character qualified them to attain perfection in every art for which they had a taste. Their situation raised a spirit of commerce, and commerce induced them to cultivate the arts. Their temples shone with statues and columns of gold, and a profusion of emeralds was everywhere scattered. All the great works of the Phenicians have been unfortunately destroyed; but many of the Carthaginian medals are still preserved, ten of which are deposited in the cabinet of the grand duke of Florence. But though the Carthaginians were a colony of Phenicians, we cannot from their works judge of the merit of their ancestors.

The Persians made no distinguished figure in the arts of design. They were indeed sensible to the charms of beauty, but they did not study to imitate them. Their dress, which consisted of long flowing robes concealing the whole person, prevented them from attending to the beauties of form. Their religion, too, which taught them to worship the divinity in the emblem of fire, and that it was impious to represent him under a human form, seemed almost to prohibit the exercise of this art, by taking away those motives which alone could give it dignity and value; and as it was not customary among them to raise statues to great men, it was impossible that statuary could flourish in Persia.

The Etrurians or ancient Tuscans, in the opinion of Winkelman, carried this art to some degree of perfection at an earlier period than the Greeks. It is said to have been introduced before the siege of Troy by Dedalus, who, in order to escape the resentment of Minos king of Crete, took refuge in Sicily, from whence he passed into Italy, where he left many monuments of his art. Pausanias and Diodorus Siculus informs us, that some works ascribed to him were to be seen when they wrote, and that they possessed that character of majesty which afterwards distinguished the labours of Etruria.

A character strongly marked forms the chief distinction

in these productions of Etruria which have descended to us. Their style was indeed harsh and overcharged; a fault also committed by Michael Angelo the celebrated painter of modern Etruria; for it is not to be supposed that a people of such rude manners as the Etrurians could communicate to their works that vividness and beauty which the elegance of Grecian manners inspired. On the other hand, there are many of the Tuscan statues which bear so close a resemblance to those of Greece, that antiquarians have thought it probable that they were conveyed from that country, or Magna Græcia, into Etruria, about the time of the Roman conquest, when Italy was adorned with the spoils of Greece.

Among the monuments of Etrurian art two distinct styles have been observed. In the first the lines are straight, the attitude stiff, and no idea of beauty appears in the formation of the head. The contour is not well rounded, and the figure is too slender. The head is oval, the chin piked, the eyes flat, and looking aloft.

These are the defects of an art in a state of infancy, which an accomplished master could never fall into, and are equally conspicuous in Gothic statues as in the productions of the ancient natives of Florence. They resemble the style of the Egyptians too much, that one is almost induced to suppose that there had once been a communication between these two nations; but others think that this style was introduced by Dedalus.

Winkelman supposes that the second epoch of this art commenced in Etruria, about the time at which it had reached its greatest perfection in Greece, in the age of Phidias; but this conjecture is not supported by any proofs. To describe the second style of sculpture among the Etrurians, is almost the same as to describe the style of Michael Angelo and his numerous imitators. The joints are strongly marked, the muscles raised, the bones distinguishable; but the whole mien harsh. In designing the bone of the leg, and the separation of the muscles of the calf, there is an elevation and strength above life. The statues of the gods are designed with more delicacy. In forming them, the artists were anxious to show that they could exercise their power without that violent distension of the muscles which is necessary in the exertions of beings merely human; but in general their attitudes are unnatural, and the actions strained. If a statue, for instance, hold any thing with its fore fingers, the rest are stretched out in a stiff position.

According to ancient history, the Greeks did not emerge from the savage state till a long time after the Egyptians, Chaldeans, and Indians, had arrived at a considerable degree of civilization. The original rude inhabitants of Greece were civilized by colonies which arrived among them, at different times, from Egypt and Phenicia. These brought along with them the religion, the letters, and the arts of their parent countries: and if sculpture had its origin from the worship of idols, there is reason to believe that it was one of the arts which were thus imported; for that the gods of Greece were of Egyptian and Phenician extraction is a fact incontrovertible; (see MYSTERIES, MYTHOLOGY, PHILOLOGY, Sect. VII. PHILOSOPHY, N^o. 19, and TRAVEL). The original statues of the gods, however were very rude. The sacred objects of adoration

9
Phenician
sculpture.

10
This art not
cultivated
among the
Persians.

11
Etrurian
sculpture.

12
First style.

13
Second
style.

worship have everywhere been the heavenly bodies; and the symbols consecrated to them were generally pillars of a conical or pyramidal figure. It was not till hero-worship was engrained on the planetary, that the sculptor thought of giving to the sacred statue any part of the human form (see POLYTHEISM, N^o 19, 23.); and it appears to have been about the era of their revolution in idolatry that the art of sculpture was introduced among the Greeks. The first representations of their gods were round stones placed upon cubes or pillars; and these stones they afterwards formed roughly, so as to give them something of the appearance of a head. Agreeable to this description was a Juniter, which Pausanias saw in Tegeum, in Arcadia. These representations were called *Hermes*; not that they represented Mercury, but from the word *Herna*, which signified a rough stone. It is the name which Homer gives to the stones which were used to fix vessels to the shore. Pausanias saw at Pheres 30 deities made of unformed blocks or cubical stones. The Lacedæmonians represented Castor and Pollux by two parallel poles; and a transverse beam was added, to express their mutual affection.

If the Greeks derived from foreign nations the rudiments of the arts, it must rebound much to their honour, that in a few centuries they carried them to such wonderful perfection as entirely to eclipse the fame of their masters. It is by tracing the progress of sculpture among them that we are to study the history of this art; and we shall see its origin and successive improvements correspond with nature, which always operates slowly and gradually.

VIEW OF GRECIAN SCULPTURE.

THE great superiority of the Greeks in the art of sculpture may be ascribed to a variety of causes. The influence of climate over the human body is so striking, that it must have fixed the attention of every thinking man who has reflected on the subject. The violent heats of the torrid zone, and the excessive cold of the north regions, are unfavourable to beauty. It is only in the mild climates of the temperate regions that it appears in its most attractive charms. Perhaps no country in the world enjoys a more serene air, less tainted with mists and vapours, or purer in a higher degree than mild and genial warmth which can unfold and expand the human body into all the symmetry of muscular strength, and all the delicacies of female beauty in greater perfection, than the happy climate of Greece; and never was there any people that had a greater taste for beauty, or were more anxious to improve it. Of the four wives of Simonides, the second was to have a handsome figure. The love of beauty was so great among the Lacedæmonian women, that they kept in their chambers the statues of Narcissus, of Narcissus, of Hyacinthus, and of Castor and Pollux; hoping that by often contemplating them they might have beautiful children.

There was a variety of circumstances in the noble and virtuous freedom of the Grecian manners that rendered the models of beauty peculiarly subservient to the cultivation of the fine arts. There were no tyrannical laws, as among the Egyptians, to check their progress. They had the best opportunities to study them in the

public places, where the youth, who needed no other veil than chastity and purity of manners, performed their various exercises quite naked. They had the strongest motives to cultivate sculpture, for a statue was the highest honour which public merit could attain. It was an honour ambitiously sought, and granted only to those who had distinguished themselves in the eyes of their fellow citizens. As the Greeks preferred natural qualities to acquired accomplishments, they decreed the first rewards to those who excelled in agility and strength of body. Statues were often raised to wrestlers. Even the most eminent men of Greece, in their youth, fought renown in gymnastic exercises. Chrylippus and Cleantes distinguished themselves in the public games before they were known as philosophers. Plato appeared as a wrestler both at the Isthmian and Pythian games; and Pythagoras carried off the prize at Elis, (see PYTHAGORAS). The passion by which they were inspired was the ambition of having their statues erected in the most sacred place of Greece, to be seen and admired by the whole people. The number of statues erected on different occasions was immense; of course the number of artists must have been great, their emulation ardent, and their progress rapid.

As most of their statues were decreed for those who vanquished in the public games, the artists had the opportunity of seeing excellent models; for those who surpassed in running, boxing, and wrestling, must in general have been well formed, yet would exhibit different kinds of beauty.

The high estimation in which sculptors were held was very favourable to their art. Socrates declared the artists the only wise men. An artist could be a legislator, a commander of armies, and might hope to have his statue placed beside those of Minerva and Theseus, or those of the gods themselves. Besides, the honour and success of an artist did not depend on the caprice of pride or of ignorance. The productions of art were estimated and rewarded by the greatest sages in the general assembly of Greece, and the sculptor who had executed his work with ability and taste was confident of obtaining immortality.

It was the opinion of Winkelman, that liberty was highly favourable to this art; but, though liberty is absolutely necessary to the advancement of science, it may be doubted whether the fine arts owe their improvement to it. Sculpture flourished most in Greece, when Pericles exercised the power of a king; and in the reign of Alexander, when Greece was conquered. It attained no perfection in Rome till Augustus had enslaved the Romans. It revived in Italy under the patronage of the family of Medici, and in France under the despotical rule of Louis XIV. It is the love of beauty, luxury, wealth, or the patronage of a powerful individual, that promotes the progress of this art.

It will now be proper to give a particular account of the ideas which the Greeks entertained concerning the standard of beauty in the different parts of the human body. And with respect to the head, the profile which they chiefly admired is peculiar to diversified beauty. It consists in a line almost straight, or marked by such slight and gentle inflections as are scarcely distinguishable from a straight line. In the figures of women and young persons, the forehead and nose form a line approaching to a perpendicular.

15
ideas of
beauty.
16
the face.

17
The head.

Ancient writers, as well as artists, assure us that the Greeks reckoned a broad forehead a mark of beauty, and a high forehead a disfigurement. From the same idea, the Circassians wore their hair hanging down over their foreheads almost to their eyes. To give an oval form to the countenance, it is necessary that the hair should cover the forehead, and thus make a curve about the temples; otherwise the face, which terminates in an oval form in the inferior part, will be angular in the higher part, and the proportion will be destroyed. This rounding of the forehead may be seen in all handsome persons, in all the heads of ideal beauty in ancient statues, and especially in those of youth. It has been overlooked, however, by modern statuary. Bernini, who modelled a statue of Louis XIV. in his youth, turned back the hair from the forehead.

18
The eyes.

It is generally agreed that large eyes are beautiful; but their size is of less importance in sculpture than their form, and the manner in which they are enshroued. In ideal beauty, the eyes are always sunk deeper than they are in nature, and consequently the eyebrows have a greater projection. But in large statues, placed at a certain distance, the eyes, which are of the same colour with the rest of the head, would have little effect if they were not sunk. By deepening the cavity of the eye, the statuary increases the light and shade, and thus gives the head more life and expression. The same practice is used in small statues. The eye is a characteristic feature in the heads of the different deities. In the statues of Apollo, Jupiter, and Juno, the eye is large and round. In those of Pallas they are also large; but by lowering the eyelids, the virgin air and expression of modesty are delicately marked. Venus has small eyes, and the lower eyelid being raised a little, gives them a languishing look and charming softness. It is only necessary to see the Venus de Medici to be convinced that large eyes are not essential to beauty, especially if we compare her small eyes with those which resemble them in nature. The beauty of the eyebrows consists in the funnel of the hair, and in the diaphanous of the bone which covers them; and masters of the art considered the joining of the eyebrows as a deformity, though it is sometimes to be met with in ancient statues.

19
The mouth.

The beauty of the mouth is peculiarly necessary to constitute a fine face. The lower lip must be fuller than the upper, in order to give an elegant rounding to the chin. The teeth seldom appear, except in laughing figures. In human figures the lips are generally close, and a little opened in the figures of the gods. The lips of Venus are half open.

In figures of ideal beauty, the Grecian artists never interrupted the rounding of the chin by introducing a dimple; for this they considered not as a mark of beauty, and only to be admitted to distinguish individuals. The dimple in the cheek appears in some ancient statues, but antiquaries object it to be the work of a modern hand. It is suspected also, that the dimple which is sometimes found on the cheeks of ancient statues is a modern innovation.

20
The ears.

No part of the head was executed by the ancients with more care than the ears, though little attention has been given to them by modern artists. This character is so decisive, that if we observe in any statue that the ears are not highly finished, but only roughly marked,

we may conclude with certainty that we are examining a modern production. The ancients were very attentive to copy the specific form of the ear in taking likenesses. Thus, where we meet with a head the ears of which have a very large inferior opening, we know it to be the head of Marcus Annius.

The manner in which the ancient artists formed the hair also enables us to distinguish their works from those of the moderns. On hard and coarse fibres the hair was short, and appeared as if it had been combed with a wide comb; for that kind of stone was difficult to work, and could not without immense labour be turned into curled and flowing hair. But the figures executed in marble in the most flourishing period of the art have the hair curled and flowing; at least where the head was not intended to be an exact resemblance, for then the artist conformed to the model. In the heads of women, the hair was more abundant, and tied behind in a waving manner, leaving considerable intervals which gives the agreeable variety of light and shadow, and produces the effects of the curls and tresses. The hair of the Amazons is disposed in this manner. Apollo and Bacchus have their hair falling down their shoulders; and young persons, till they arrived at manhood, wore their hair long. The colour of the hair which was reckoned most beautiful, was fair; and this they gave without distinction to the most beautiful of their gods, Apollo and Bacchus, and likewise to their most illustrious heroes.

Although the ravages of time have preferred but few of the hands or feet of ancient statues, it is evident from what remains how anxious the Grecian artists were to give every perfection to these parts. The hands of young persons were moderately plump, with little cavities or angles at the joints of the fingers. The fingers tapered very gently from the root to the joint, like well-proportioned columns, and the joints were scarcely perceptible. The terminating joint was not bent, as it commonly appears in modern statues.

21
The legs.

In the figures of young men the joints of the knee are faintly marked. The knee unites the leg to the thigh without making any remarkable projections or cavities. The most beautiful legs and well-turned knee, according to Winkelmann, are preserved in the Apollo Saurophonte, in the Vada Borghese; in the Apollo which has a tiger at its feet; and in the Bacchus of Villa Medici. The same delicate construction remains, it is rare to meet with beautiful knees in young persons, or in the elegant representations of art. As the artist did not cover the feet as we do, they gave to the most beautiful turn, and studied the form of toes with the most scrupulous attention.

The breasts of men were large and elevated. The breasts of women did not possess much suppleness. The figures of the deities have always the breasts of a virgin, the beauty of which the painters made to consist in a gentle elevation. So anxious were the ancients to resemble this standard, that they used several arts to restrain the growth of their breasts. The breasts of the nymphs and goddesses were never represented full, because that is peculiar to those women who suck. The paps of Venus contract and end in a point, this being considered as an essential characteristic of perfect beauty. Some of the moderns have tampered their rules, and have fallen into great improprieties.

The lower part of the body in the statues of men was formed like that of the living body after a profound sleep and good digestion. The navel was considerably sunk, especially in female statues.

²⁵ Ideal beauty. As beauty never appears in equal perfection in every part of the same individual, perfect or ideal beauty can only be produced by selecting the most beautiful parts from different models; but this must be done with such judgement and care, that these detached beauties when united may form the most exact symmetry. Yet the ancients sometimes confined themselves to one individual, even in the most flourishing age. Theodoros, whom Socrates and his disciples visited, served as a model to the artists of his time. Phryne also appears to have been a model to the painters and sculptors. But Socrates, in his conversation with Parrhasios, says, that when a perfect beauty was to be produced, the artists joined together the most striking beauties which could be collected from the finest figures. We know that Zeusis, when he was going to paint Helen, united in one picture all the beauties of the most handsome women of Crotona.

²⁵ The drapery of statues. THE Grecian sculptors, who represented with such success the most perfect beauty of the human form, were not regardless of the drapery of their statues. They clothed their figures in the most proper stuff, which they wrought into that shape which was best calculated to give effect to their design.

The vestments of women in Greece generally consisted of linen cloth, or some other light stuff, and in latter times of silk and sometimes of woollen cloth. They had also garments embroidered with gold. In the works of sculpture, as well as in those of painting, one may distinguish the linen by its transparency and small united folds. The other light stuffs which were worn by the women (A) were generally of cotton produced in the isle of Cos; and these the art of statuary was able to distinguish from the linen vestments. The cotton cloth was sometimes striped, and sometimes embellished with a profusion of flowers. Silk was also employed; but whether it was known in Greece before the time of the Roman emperors cannot easily be determined. In paintings, it is distinguishable by changing its colour in different lights to red, violet, and sky-blue. There were two sorts of purple; that which the Greeks called the colour of the sea, and Tyrian purple, which resembled lac. Woollen garments are easily known by the amplitude of their folds. Besides these, cloth of gold sometimes composed their drapery: but it was not like the modern fabric, consisting of a thread of gold or of silver spun with a thread of silk; it was composed of gold or silver alone, without any mixture.

²⁷ The tunic. The vestments of the Greeks, which deserve particular attention, are the tunic, the robe, and the mantle. The tunic was that part of the dress which was next to the body. It may be seen in sleeping figures, or in those in disthable; as in the Flora Tarrese, and in the statues of the Amazons in the Capitol. The youngest of the daughters of Niobe, who throws herself at her

mother's side, is clothed only with a tunic. It was of linen, or some other light stuff, without sleeves, fixed to the shoulders by a button, so as to cover the whole breast. None but the tunics of the goddesses Ceres and comedians have long straight sleeves.

²³ The robe. The robes of women commonly consisted of two long pieces of woollen cloth, without any particular form, attached to the shoulders by a great many buttons, and sometimes by a clasp. They had straight sleeves which came down to the wrists. The young girls, as well as the women, fastened their robe to their side by a cinchure, in the same way as the high-priest of the Jews fastened his, as it is still done in many parts of Greece. The cinchure formed on the side a knot of ribbons sometimes resembling a rose in shape, which has been particularly remarked in the two beautiful daughters of Niobe. In the younger of these the cinchure is seen passing over the shoulders and the back. Venus has two cinchures, the one passing over the shoulder, and the other surrounding the waist. The latter is called *ceflus* by the poets.

²⁹ The mantle. The mantle was called *peplon* by the Greeks, which signifies properly the mantle of Pallas. The name was afterwards applied to the mantles of the other gods, as well as to those of men. This part of the dress was not square, as some have imagined, but of a roundish form. The ancients indeed speak in general of square mantles, but they received this shape from four tassels which were affixed to them; two of these were visible, and two were concealed under the mantle. The mantle was brought under the right arm, and over the left shoulder; sometimes it was attached to the shoulder by two buttons, as may be seen in the beautiful statue of Leucothoe at Villa Albani.

³⁰ The colour of vestments peculiar to certain statues is too curious to be omitted. To begin with the figures of the gods.—The drapery of Jupiter was red, that of Neptune is supposed by Winkelman to have been sea-green. The same colour also belonged to the Nereids and Nymphs. The mantle of Apollo was blue or violet. Bacchus was dressed in white. Martianus Capella assigns green to Cybele. Juno's vestments were sky-blue, but the sometimes had a white veil. Pallas was robed in a flame-coloured mantle. In a painting of Hercules, Venus is in flowing drapery of a golden yellow. Kings were arrayed in purple; priests in white; and conquerors sometimes in sea-green.

With respect to the head, women generally wore no covering but their hair; when they wished to cover their head, they used the corner of their mantle.— Sometimes we meet with veils of a fine transparent texture. Old women wore a kind of bonnet upon their head, an example of which may be seen in a statue in the Capitol, called the *Præfca*; but Winkelman thinks it is a statue of Hecuba.

The covering of the feet consisted of shoes or sandals. The sandals were generally an inch thick, and composed of more than one sole of cork. Those of Pallas in Villa Albani has two soles, and other statues had no less than five.

WINKELMAN

(A) Men sometimes wore cotton, but all who did so were reckoned effeminate.

WINKELMAN has assigned four different styles to this art. The *ancient style*, which continued until the time of Phidias; the *grand style*, formed by that celebrated statuary; the *beautiful*, introduced by Praxiteles, Apollonius, and Lyfippus; and the *imitative style*, practised by those artists who copied the works of the ancient masters.

The most authentic monuments of the ancient style are medals, containing an inscription, which leads us back to very distant times. The writing is from right to left in the Hebrew manner; a usage which was abandoned before the time of Herodotus. The statue of Agamemnon at Elis, which was made by Oenotas, has an inscription from right to left. This artizan flourished 50 years before Phidias; it is in the intervening period therefore between these two artists, that we are to look for the cessation of this practice. The statues formed in the ancient style were neither distinguished by beauty of shape nor by proportion, but bore a close resemblance to those of the Egyptians and Etrurians (B); the eyes were long and flat; the flection of the mouth not horizontal; the chin was pointed; the curls of the hair were ranged in little rings, and resembled grains inclosed in a heap of radins. What was still worse, it was impossible by inspecting the head to distinguish the sex.

The characters of this ancient style were these: The designing was energetic, but harsh; it was animated, but without gracefulness; and the violence of the expression deprived the whole figure of beauty.

The grand style was brought to perfection by Phidias, Polyctetus, Scopas, Alcamenes, Myron, and other illustrious artists. It is probable, from some passages of ancient writers, that in this style were preserved some characters of the ancient manner, such as the straight lines, the squares and angles. The ancient masters, such as Polyctetus, being the legislators of proportions, says Winkelman, and of consequence thinking they had a right to distribute the measures and dimensions of the parts of the human body, have undoubtedly sacrificed some degree of the form of beauty to a grandeur which is harsh, in comparison of the flowing contours and graceful forms of their successors.—The most considerable monuments of the grand style are the statues of Niobe and her daughters, and a figure of Pallas, to be seen in Villa Albani; which, however, must not be confounded with the statue which is modelled according to the first style, and is also found in the same place. The head possesses all the characters of dignified beauty, at the same time exhibiting the rigidity of the ancient style. The face is defective in gracefulness; yet it is evident how easy it would have been to give the features more roundness and grace. The figures of Niobe and her daughters have not, in the opinion of Winkelman, that austerity of appearance which marks the age of the statue of Pallas. They are characterized by grandeur and simplicity: so simple are the forms, that they do not appear to be the tedious productions of art, but to have been created by an instantaneous effort of nature.

VOL. XIX. Part I.

The third style was the graceful or beautiful. Lyfippus was perhaps the artist who introduced this style. Being more conversant than his predecessors with the sweet, the pure, the flowing, and the beautiful lines of nature, he avoided the figure forms which the masters of the second style had too much employed. He was of opinion that the use of the art was rather to please than to astonish, and that the aim of the artist should be to raise admiration by giving delight. The artists who cultivated this style did not, however, neglect to study the sublime works of their predecessors. They knew that grace is consistent with the most dignified beauty, and that it possesses charms which must ever please; they knew also that these charms are enhanced by dignity. Grace is infused into all the movements and attitudes of their statues, and it appears in the delicate turns of the hair, and even in the adjusting of the drapery. Every sort of grace was well known to the ancients; and great as the ravages of time have been amongst the works of art, specimens are still preserved, in which can be distinguished dignified beauty, attractive beauty, and a beauty peculiar to infants. A specimen of dignified beauty may be seen in the statue of one of the mules in the palace of Barberini at Rome; and in the garden of the pope, on the Quirinal, is a statue of another mule, which affords a fine instance of attractive beauty. Winkelman says that the most excellent model of infant beauty which antiquity has transmitted to us is a satyr of a year old, which is preserved, though a little mutilated, in Villa Albani.

The great reputation of Praxiteles and Apelles raised an ardent emulation in their successors, who despairing to surpass such illustrious masters, were satisfied with imitating their works. But it is well known that a mere imitator is always inferior to the master whom he attempts to copy. When no original genius appears, the art must therefore decline.

CLAY was the first material which was employed in statuary. An instance of this may be seen in a figure of Alcamenes in bas-relief in Villa Albani. The ancients used their fingers, and especially their nails, to render certain parts more delicate and lively: hence arose the phrase *ad unguem factus homo*, "an accomplished man." It was the opinion of Count Caylus that the ancients did not use models in forming their statues. But to disprove this, it is only necessary to mention an engraving on a stone in the cabinet of Stofch, which represents Prometheus engraving the figure of a man, with a plummet in his hand to measure the proportions of his model. The ancients as well as the moderns made works in plaster; but no specimens remain except some figures in bas-relief, of which the most beautiful were found at Baia.

The works made of ivory and silver were generally of a small size. Sometimes, however, statues of a prodigious size were formed of gold and ivory. The colossal Minerva of Phidias, which was composed of these materials, was 26 cubits high. It is indeed scarcely possible

(B) This is a proof additional to those that will be found in the articles to which we have referred, that the Greeks derived the rudiments of the art of sculpture from the nations to which they were confessedly indebted for the elements of science.

possible to believe that statues of such a size could entirely consist of gold and ivory. The quantity of ivory necessary to a colossal statue is beyond conception. M. de Paw calculates that the statue of Jupiter Olympus, which was 54 feet high, would consume the teeth of 300 elephants.

30
Marble.

The Greeks generally hewed their marble statues out of one block, though they after worked the heads separately, and sometimes the arms. The heads of the famous group of Niobe and her daughters have been adapted to their bodies after being separately finished. It is proved by a large figure representing a river, which is preserved in Villa Albani, that the ancients first hewed their statues roughly before they attempted to finish any part. When the statue had received its perfect figure, they next proceeded to polish it with pumice-stone, and again carefully retouched every part with the chisel.

47
Porphyry.

The ancients, when they employed porphyry, usually made the head and extremities of marble. It is true, that at Venice there are four figures entirely composed of porphyry; but these are the productions of the Greeks of the middle age. They also made statues of basalt and alabaster.

41
Expression
and atti-
tude.

WITHOUT expression, gesture, and attitude, no figure can be beautiful, because in these the graces always reside. It was for this reason that the graces are always represented as the companions of Venus.

The expression of tranquillity was frequent in Grecian statues, because, according to Plato, that was considered as the middle state of the soul between pleasure and pain. Experience, too, shows that in general the most beautiful persons are endowed with the sweetest and most engaging manner. Without a serene tranquillity dignified beauty could not exist. It is in this tranquillity, therefore, that we must look for the complete display of genius.

42
The dis-
tinction
of the
gods.

The most elevated species of tranquillity and repose was studied in the figures of the gods. The father of the gods, and even inferior divinities, are represented without emotion or resentment. It is thus that Homer paints Jupiter thinking Olympus by the motion of his hair and his eyebrows.

Shakes his ambrosial curls, and gives the nod,

The stamp of fate and sanction of the god.

Jupiter is not always exhibited in this tranquil state. In a bas-relief belonging to the marquis Rouditi he appears seated on an arm-chair with a melancholy aspect. The Apollo of the Vatican represents the god in a fit of rage against the infant Python, which he kills at a blow. The artist, depicting the opinion of the poets, has made the side the seat of anger, and the lips the seat of disdain.

43
The ex-
pression
of
action.

To express the action of a hero, the Grecian sculptors distinguished between a noble virtuous character and a villainous one, and allowing no expression of pain to appear. In describing the actions of a hero the poet has made more liberty than the artist. The poet could do that which as they were before men were taught to believe their passions by the restraints of law, or the restraints of social life. But the artist, obliged to select the most beautiful forms, is reduced to the necessity of giving such an expression of the passions

as may not shock our feelings and disgust us with his production. The truth of these remarks will be acknowledged by those who have seen two of the most beautiful monuments of antiquity; one of which represents the fear of death, the other the most violent pains and sufferings. The daughters of Niobe, against whom Diana has discharged her fatal arrows, are exhibited in that state of suspension which we imagine must take place when the certain prospect of death deprives the soul of all sensibility. The fable presents us an image of that stupor which Elchylus describes as seizing the daughters of Niobe when they were transformed into a rock. The other monument referred to is the image of Laocoon, which exhibits the most agonizing pain that can affect the muscles, the nerves, and the veins. The sufferings of the body and the elevation of the soul are expressed in every member with equal energy, and form the most sublime contrast imaginable. Laocoon appears to suffer with such fortitude, that, whilst his lamentable situation pierces the heart, the whole figure fills us with an ambitious desire of imitating his constancy and magnanimity in the pains and sufferings that may fall to our lot.

Philoctetes is introduced by the poets shedding tears, uttering complaints, and rending the air with his groans and cries; but the artist exhibits him silent and bearing his pains with dignity. The Ajax of the celebrated painter Timomachus is not drawn in the act of destroying the sheep which he took for the Grecian chiefs, but in the moments of reflection which succeeded that frenzy. So far did the Greeks carry their love of calmness and slow movements, that they thought a quick step always announced rudeness of manners. Demosthenes reproaches Nicobulus for this very thing; and from the words he makes use of, it appears, that to speak with inflexion and to walk hastily were reckoned synonymous.

In the figures of women, the artists have conformed to the principle observed in all the ancient tragedies, and recommended by Aristotle, never to make women show too much intrepidity or excessive cruelty. Conformable to this maxim, Clytemnestra is represented at a little distance from the fatal spot, watching the murderer, but without taking any part with him. In a painting of Timomachus representing Medea and her children, when Medea lifts up the dagger they smile in her face, and her fury is immediately melted into compassion for the innocent victims. In another representation of the same subject, Medea appears hesitating and indecisive. Guided by the same maxims, the artists of most refined taste were careful to avoid all deformity, choosing rather to recede from truth than from their accustomed respect for beauty, as may be seen in several figures of Hecuba. Sometimes, however, she appears in the decrepitude of age, her face furrowed with wrinkles, and her breasts hanging down.

Illustrious men, and those invested with the offices of dignity, are represented with a noble assurance and firm aspect. The statues of the Roman emperors resemble those of heroes, and are far removed from every species of flattery, in the gesture, in the attitude, and action. They never appear with haughty looks, or with the splendor of royalty; no figure is ever seen presenting any thing to them with bended knee, except captives; and none addresses them with an inclination of the head.

In

In modern works too little attention has been paid to the ancient *eglima*. Winkelman mentions a bas-relief, which was lately executed at Rome for the fountain of Trevi, representing an architect in the act of presenting the plan of an aqueduct to Marcus Agrippa. The modern sculptor, not content with giving a long beard to this illustrious Roman, contrary to all the ancient marble statues as well as medals which remain, exhibits the architect on his knees.

In general, it was an established principle to banish all violent passions from public monuments. This will serve as a decisive mark to distinguish the true antique from supposititious works. A medal has been found exhibiting two Africans, a man and a woman tearing their hair, with this inscription, ASSYRIA. ET PALLAESTINA. IN POTEST. P. R. REDAC. S. C. The imagery of this medal is manifest from the word *Palaestina*, which is not to be found in any ancient Roman medal with a Latin inscription. Besides, the violent action of tearing the hair does not suit any symbolical figure. This extravagant style, which was called by the ancients *paranthoria*, has been imitated by most of the modern artists. Their figures resemble comedians on the ancient theatres, who, in order to suit the distant spectators, put on painted masks, employed exaggerated gestures, and far overleaped the bounds of nature. This style has been reduced into a theory in a treatise on the passions composed by Le Brun. The designs which accompany that work exhibit the passions in the very highest degree, approaching even to frenzy: but these are calculated to vitiate the taste, especially of the young; for the ardour of youth prompts them rather to seize the extremity than the middle; and it will be difficult for that artist who has formed his taste from such emaciated models ever to acquire that noble simplicity and sedate grandeur which distinguished the works of ancient taste.

PROPORTION is the basis of beauty, and there can be no beauty without it; on the contrary, proportion may exist where there is little beauty. Experience every day teaches us that knowledge is distinct from taste; and proportion, therefore, which is founded on knowledge, may be strictly observed in any figure, and yet the figure have no pretensions to beauty. The ancients considering ideal beauty as the most perfect, have frequently employed it in preference to the beauty of nature.

The body consists of three parts as well as the members. The three parts of the body are the trunk, the thighs, and the legs. The inferior parts of the body are the thighs, the legs, and the feet. The arms also consist of three parts. These three parts must bear a certain proportion to the whole as well as to one another. In a well formed man the head and body must be proportioned to the thighs, the legs, and the feet, in the same manner as the thighs are proportioned to the legs and the feet, or the arms to the hands. The face also consists of three parts, that is, three times the length of the nose; but the head is not four times the length of the nose, as some writers have asserted. From the place where the hair begins to the crown of the head are only three-fourths of the length of the nose, or that part is to the nose as 9 to 12.

It is probable that the Grecian, as well as Egyptian

artists, have determined the great and small proportions by fixed rules; that they have established a positive measure for the dimensions of length, breadth, and circumference. This supposition alone can enable us to account for the great conformity which we meet with in the statues. Winkelman thinks that the foot was the measure which the ancients used in all their great dimensions, and that it was by the length of it that they regulated the measure of their figures, by giving to them six times that length. This in fact is the length which Vitruvius assigns *Periura altitudinis corporis tot.* lib. iii. cap. 1. That celebrated antiquary thinks the foot is a more determinate measure than the head or face, the parts from which modern painters and sculptors too often take their proportions. This proportion of the foot to the body, which has appeared strange and incomprehensible to the learned Huëtius, and has been universally rejected by Perrault, is however founded upon evidence. After measuring with great care a vast number of figures, Winkelman found this proportion observed not only in Egyptian statues, but also in those of Greece. This fact may be determined by an inspection of those statues the feet of which are perfect. One may be fully convinced of it by examining some divine figures, in which the artists have made some parts beyond their natural dimensions. In the Apollo Belvidere, which is a little more than seven heads high, the foot is three Roman inches longer than the head. The head of the Venus de Medicis is very small, and the height of the statue is seven heads and a half; the foot is three inches and a half longer than the head, or precisely the sixth part of the length of the whole statue.

PRACTICE OF SCULPTURE.

WE have thus minute in our account of the Grecian sculpture, because it is the opinion of the ablest critics that modern artists have been more or less eminent as they have studied with the greater or less attention the models left us by that ingenious people; Winkelman goes so far as to contend that the most finished works of the Grecian masters ought to be studied in preference even to the works of nature. This appears to be paradoxical; but the reason assigned by the Author for his opinion is, that the fairest lines of beauty are more easily discovered, and make a more striking and powerful impression, by their reunion in these sublime copies, than when they are scattered far and wide in the original. Allowing, therefore, the study of nature the high degree of merit it so justly claims, it must nevertheless be granted, that it leads to true beauty by a much more tedious, laborious, and difficult path, than the study of the *antique*, which presents immediately to the artist's view the object of his researches, and combines in a clear and strong point of light the various rays of beauty that are dispersed through the wide domains of nature.

As soon as the artist has laid this excellent foundation, required an intimate degree of familiarity with the lines of the Grecian statues, and formed his taste after the admirable models they exhibit, he may then proceed with advantage and assurance to the imitation of nature. The student has already formed of the perfection of nature, by observing her diversified beauties combined and executed in the compositions of the ancient

artists, will enable him to acquire with facility, and to employ with advantage, the detached and partial ideas of beauty which will be exhibited to his view in a survey of nature in her actual state. When he discovers these partial beauties, he will be capable of combining them with those perfect forms of beauty with which he is already acquainted. In a word, by having always present to his mind the noble models already mentioned, he will be in some measure his own oracle, and will draw rules from his own mind.

There are, however, two ways of imitating nature. In the one a single object occupies the artist, who endeavours to represent it with precision and truth; in the other, certain lines and features are taken from a variety of objects, and combined and blended into one regular whole. All kinds of copies belong to the first kind of imitation; and productions of this kind must be executed necessarily in the Dutch manner, that is to say, with high finishing, and little or no invention. But the second kind of imitation leads directly to the investigation and discovery of true beauty, of that beauty whose idea is conate with the human mind, and is only to be found there in its highest perfection. This is the kind of imitation in which the Greeks excelled, and in which men of genius excite the young artists to excel after their example, viz. by studying nature as they did.

After having studied in the productions of the Grecian masters their choice and expression of select nature, their sublime and graceful contours, their noble draperies, together with that sedate grandeur and admirable simplicity that constitute their chief merit, the curious artists will do well to study the manual and mechanical part of their operations, as this is absolutely necessary to the successful imitation of their excellent manner.

It is certain that the ancients almost always formed their first models in wax: to this modern artists have substituted clay, or some such composition: they prefer clay before wax in the carnations, on account of the yielding nature of the latter, and its sticking in some measure to every thing it touches. We must not, however, imagine from hence that the method of forming models of wet clay was either unknown or neglected among the Greeks; on the contrary, it was in Greece that models of this kind were invented. Their author was Dibutades of Sicyon; and it is well known that Arcesilas, the friend of Lucretius, obtained a higher degree of reputation by his clay models than by all his other productions. Indeed, if clay could be made to preserve its original moisture, it would undoubtedly be the fittest substance for the models of the sculptor; but when it is placed either in the fire or left to dry imperceptibly in the air, its solid parts grow more compact, and the figure losing thus a part of its dimensions, is necessarily reduced to a smaller volume. This diminution would be of no consequence did it equally affect the whole figure. So as to preserve its proportions entire. But this is not the case: for the smaller parts of the figure dry faster than the larger; and thus losing more of their dimensions in the same space of time than the latter do, the figure by and by loses its proportions inevitably. This inconvenience does not take place in those models that are made in wax. It is indeed extremely difficult, in the ordinary method of

working the wax, to give it that degree of smoothness that is necessary to represent the softness of the carnations or fleshy parts of the body. This inconvenience may, however, be remedied, by forming the model first in clay, then moulding it in plaster, and lastly casting it in wax. And, indeed, clay is seldom used but as a mould in which to cast a figure of plaster, stucco, or wax, to serve henceforth for a model by which the measures and proportions of the statue are to be adjusted. In making waxen models, it is common to put half a pound of colophony to a pound of wax; and some add turpentine, melting the whole with oil of olives.

So much for the first or preparatory steps in this procedure. It remains to consider the manner of working the marble after the model so prepared; and the method here followed by the Greeks seems to have been extremely different from that which is generally observed by modern artists. In the ancient statues we find the most striking proofs of the freedom and boldness that accompanied each stroke of the chisel, and which resulted from the artist's being perfectly sure of the accuracy of his idea, and the precision and steadiness of his hand: the most minute parts of the figure carry these marks of assurance and freedom; no indication of timorousness or diffidence appears; nothing that can induce us to fancy that the artist had occasion to correct any of his strokes. It is difficult to find, even in the second-rate productions of the Grecian artists, any mark of a false stroke or a random touch. This firmness and precision of the Grecian chisel were certainly derived from a more determined and perfect set of rules than those which are observed in modern times.

The method generally observed by the modern sculptor is as follows: First, out of a great block of marble he saws another of the size required, which is performed with a smooth steel saw, without teeth, calling water and sand thereon from time to time; then he fashions it, by taking off what is superfluous with a steel point and a heavy hammer of soft iron; after this, bringing it near the measure required, he reduces it still nearer with another finer point; he then uses a flat cutting instrument, having notches in its edge; and then a chisel to take off the scratches which the former has left; till, at length, taking rasps of different degrees of fineness, by degrees he brings his work into a condition for polishing.

After this, having studied his model with all possible attention, he draws upon this model horizontal and perpendicular lines which intersect each other at right angles. He afterwards copies these lines upon his marble, as the painter makes use of such transversal lines to copy a picture, or to reduce it to a smaller size. These transversal lines or squares, drawn in an equal number upon the marble and upon the model, in a manner proportioned to their respective dimensions, exhibit accurate measures of the surfaces upon which the artist is to work; but cannot determine, with equal precision, the depths that are proportioned to these surfaces.—The sculptor, indeed, may determine these depths by observing the relation they bear to his model; but as his eye is the only guide he has to follow in this estimate, he is always more or less exposed to error, or at least to doubt. He is never sure that the cavities made

by his chief are exact; a degree of uncertainty accompanies each stroke; nor can he be assured that it has carried away neither too much nor too little of his marble. It is equally difficult to determine, by such lines as have already been mentioned, the external and internal contours of the figure, or to transfer them from the model to the marble. By the internal contour is understood that which is described by the parts which approach towards the centre, and which are not marked in a striking manner.

It is farther to be noticed, that in a complicated and laborious work, which an artist cannot execute without assistance, he is often obliged to make use of foreign hands, that have not the talents or dexterity that are necessary to finish his plan. A single stroke of the chisel that goes too deep is a defect not to be repaired; and such a stroke may easily happen, where the depths are so imperfectly determined. Defects of this kind are inevitable, if the sculptor, in chipping his marble, begins by forming the depths that are requisite in the figure he designs to represent. Nothing is more liable to error than this manner of proceeding. The cautious artist ought, on the contrary, to form these depths gradually, by little and little, with the utmost circumspection and care; and the determining of them with precision ought to be considered as the last part of his work, and as the finishing touches of his chisel.

The various inconveniences attending this method determined several eminent artists to look out for one that would be liable to less uncertainty, and productive of fewer errors. The French academy of painting at Rome hit on a method of copying the ancient statues, which some sculptors have employed with success, even in the figures which they finished after models in clay or wax. This method is as follows. The statue that is to be copied is inclosed in a frame that fits it exactly. The upper part of this frame is divided into a certain number of equal parts, and to each of these parts a thread is fixed with a piece of lead at the end of it.

These threads, which hang freely, show what parts of the statue are most removed from the centre with much more perspicuity and precision than the lines which are drawn on its surface, and which pass equally over the higher and hollow parts of the block; they also give the artist a tolerable rule to measure the more striking variations of height and depth, and thus render him more exact and determined in the execution of his plan.

But even this method is not without its defects: for as it is impossible, by the means of a straight line, to determine with precision the procedure of a curve, the artist has, in this method, no certain rule to guide him in his contours; and as often as the line which he is to describe deviates from the direction of the plumb line, which is his main guide, he must necessarily feel himself at a loss, and be obliged to have recourse to conjecture.

It is also evident, that this method affords no certain rule to determine exactly the proportion which the various parts of the figure ought to bear to each other, considered in their mutual relation and connections. The artist, indeed, endeavours to supply this defect by intersecting the plumb-lines by horizontal ones. This recourse has, nevertheless, its inconveniences, since the squares formed by transversal lines, that are at a distance from the figure (though they be exactly equal), yet represent the parts of the figure as greater or smaller, according as they are more or less removed from our position or point of view. But, notwithstanding these inconveniences, the method now under consideration is certainly the best that has hitherto been employed: it is more practicable and sure than any other we know, though it appears, from the remarks we have now been making, that it does not exhibit a sure and universal criterion to a sculptor who executes after a model.

To polish the statue, or make the parts of it smooth and sleek, pumice-stone and smelt are used: then tripoli is used and when a still greater lustre is required, burnt draw is employed. For the *Casting of Statues*, see **FOUNDRY**, and *PLATES of Paris*.

S C U

S C U

SCUM, properly denotes the impurities which a liquor, by boiling, casts up to the surface. The term *scum* is also used for what is more properly called the scoria of metals.

SCUPPERS, in a ship, are certain channels cut through the water-ways and sides of a ship, at proper distances, and lined with plated lead, in order to carry the water off from the deck into the sea. The scuppers of the lower deck of a ship of war are usually furnished with a leathern pipe, called the *scupper-hole*, which hangs downward from the mouth or opening of the scupper. The intent of this is to prevent the water from entering when the ship inclines under a weight of sail.

SCURVY, in *Medicine*, see that article, N^o 351, where we have given an account of the symptoms, causes, and modes of prevention and cure, according to some of the most eminent writers in medicine. We have here only to add, that, in the opinion of Dr Boerhaave, the mineral acids, especially the nitric and vitriolic, may

be employed in the prevention or cure of this dreadful disease with as much success as the vegetable acids.—But of all the substances that can at once be cheaply procured and long preserved, he thinks the concrete acid of tartar by far the most promising. It is very grateful, and comes near to the citric acid. In tropical countries the scurvy is seldom known.

SCUPPER-GRAVE. See *COCHLEARIA*, *HOLAND India*.
SCUTAGE (*scutagium*, *Sax. Schilling*), was a tax or contribution raised by those that held lands by knights service, towards furnishing the king's army, at one, two, or three morks for every knight's fee. Henry III. for his voyage to the Holy Land, had a tenth granted by the clergy, and *scutages*, three morks of every knight's fee by the *laity*. This was also levied by Henry II. Richard I. and King John. See *KING'S SERVICE*.

SCUTE (*scutum*), a French gold coin of 20 *gd.* in the reign of King Henry V. Catherine queen of England had an allowance made her of sundry castles, manors, lands, &c. valued at the sum of 45,000 *scutes*.

Scurvy
II.
Scute.

every two whereof were worth a noble. *Rot. Parl. 1. Hen. VI.*

SCUFELIARIA, SKULL-CAP, a genus of plants, belonging to the didymia class; and in the natural method ranking under the 42nd order, *Perfoliate*. See *BOTANY Index*.

SCUFFLES, in a ship, square holes cut in the deck, big enough to let down the body of a man, and which serve upon some occasions to let the people down into any room below, or from one deck to another.

SCYLAX, a celebrated mathematician and geographer of Gama, flourish'd under the reign of Darius Hytaspes, about 535 B. C. Some have attributed to him the invention of geographical tables. We have under his name a geographical work published by Hoelchelus; but it is written by a much later author, and is perhaps only an abridgement of Scylax's Ancient Geography.

SCYLLA, in *Ancient Geography*, a rock in the Fretum Scutulum, near the coast of Italy, dangerous to shipping, opposite to Charybdis, a whirlpool on the coast of Sicily; both of them famous in mythology.

Scylla and Charybdis have been almost subdued by the repeated convulsions of this part of the earth, and by the violence of the current, which is continually increasing the breadth of the straits. If proper allowance be made for these circumstances, we shall acquit the ancients of any exaggeration, notwithstanding the very dreadful colours in which they have painted this passage. It is formed by a low peninsula, called *Cape Pelorus*, stretching to the eastward on the Sicilian side, immediately within which lies the famous whirlpool of Charybdis, and by the rocks of Scylla, which a few miles below on the Calabrian shore project towards the west. The current runs with surprising force from one to the other alternately in the direction of the tide, and the tides themselves are very irregular. Thus vessels, by flammng the one, were in the utmost danger of being swallowed up by the other.

At present, in moderate weather, when the tide is either at ebb or flood, boats pass all over the whirlpool; but, in general, it is like the meeting of two contending currents, with a number of eddies all around; and, even now, there is scarcely a winter in which there are not some wrecks.

"At the time when we pass'd the straits (says Captain Sutherland, from whom we have obtained this accurate information) the weather was as favourable as we could wish; and yet, in spite of a strong breeze and the current, which hurried us on with surprising velocity, the ship's head was suddenly whirled round near three points; but the wind blowing fresh, in a few seconds the dashed through the eddy that had caught her; for, to avoid Scylla, and secure Messina, we had kept pretty close to Charybdis." For a later account of these rocks, see SICILIA.

SCYROS, an island in the *Ægean sea*, at the distance of about 28 miles north-east from Embra. It is 62 miles in circumference. It was originally in the possession of the Pelagians and Carians. Achilles retired thence to avoid going to the Trojan war, and became father of Neoptolemus by Deidamia the daughter of King Lacedæmon. Scyros was conquered by the Athenians under Cimon. It is very rocky and barren. Now *Sciro*. *E. Long. 25. 7. N. Lat. 38. 15.*

SCYTALA LYCONICA, in antiquity, a stratagem or

device of the Lacedæmonians, for the secret writing of letters to their correspondents, so that if they should chance to be intercepted, nobody might be able to read them.—To this end they had two wooden rollers or cylinders, perfectly alike and equal; one whereof was kept in the city, the other by the person to whom the letter was directed. For the letter, a skin of very thin parchment was wrapped round the roller, and thereon was the matter written; which done, it was taken off, and sent away to the party, who, upon putting it in the same manner upon his roller, found the lines and words in the very same disposition as when they were first written. This expedient they set a very high value on; though, in truth, artless and gross enough: the moderns have improved vastly on this method of writing. See *CIPHER*.

SCYTALIA, a genus of plants belonging to the octandria class; and in the natural method ranking with those that are doubtful. See *BOTANY Index*.

SCYTHE, in *Husbandry*, a well known instrument which has been long employed for cutting grass for hay. The same instrument with certain modifications in its construction has been used in reaping grain, in place of the sickle the use of which is far more common, and in Scotland at least prevails almost universally, although it must be admitted that the method of reaping by the scythe, where it is practicable, is attended with less labour, is more expeditious, and therefore more economical. But against the use of the scythe, as a reaping instrument, many objections have been raised. Some of these are probably founded in prejudice, while others, considering the slow progress which has been made in introducing this instrument as a substitute for the sickle, rest on a more solid foundation.

It is said that this instrument shakes the ear, so that many of the grains are lost; that it lets the corn fall after it is cut, in a scattered confused manner, in consequence of which either a great deal of it is lost, or much time is wasted in gathering it together. It is also affirmed that it can only be made use of in very even land, and which is free from stones; that it does not leave length enough of stubble on the ground, on which to lay the corn when it is cut; that it mixes noxious weeds with the corn, the seeds of which are sown the ensuing year; and finally, that the use of the scythe is prejudicial to the health of the reaper.

It appears, however, that these objections have either no weight, or they are made by those who are unacquainted with the scythes peculiarly adapted to this purpose, and with the manner in which they ought to be used. With a good scythe properly managed, the corn when cut, remains at first upright, afterwards falling gently on the rake fixed to the scythe, without any shaking or jolting, or at least with less than what is occasioned by the sickle. The loss of grain chiefly arises from the corn being too dry, and therefore it ought to be reaped on proper days, and suitable times of the day, which is more easily accomplished by the scythe than the sickle, because the one requires less time than the other. The stalks, held together by the rake, may be laid on the ground, or against the corn not yet cut down, in a state so regular and connected, that those by whom the sheaves are collected and bound have themselves alone to blame, should any thing be left behind. It is sufficiently even when lands are ploughed and harrowed

rowed in a proper manner; and the only necessary precaution in stony ground, is to keep the scythe a little higher, that it may not strike against the stones. If the stubble be short, the straw cut off will of course be the longer, and of consequence more valuable; and long stubble only incommodes the cattle afterwards sent to feed upon it.

These and similar considerations, prevailed with the patriotic society of Milan, to send to these places where scythes are used for reaping; and having procured a model from Silesia, they ordered one of a proper size to be made. It was first tried on corn, and afterwards on millet; and notwithstanding the first was far from being made with accuracy, and although such an instrument had never before been made use of by the reaper, nearly half the usual time was found to be saved, and the wanted fatigue and labour were much diminished. The corn was cut without receiving any injurious shock, falling in an even and regular state, by which means it was afterwards bound up with ease in compact sheaves.

These instruments are so simple in their construction, that a figure of one of them renders a description almost unnecessary. Fig. 1. represents the Silesian scythe tried by the society, the difference between which and the Austrian one we shall mention in our description. The Silesian scythe differs little from that commonly employed in mowing grass, except that the blade is rather smaller; to it four teeth of wood are added, parallel to the blade, fixed and secured in a proper manner, and designed to keep the corn together after it is cut; so that instead of its falling in a confused state, the reaper can lay it down in a regular and compact manner. The Austrian scythe is similar to the former, but the blade is larger; of course the wooden teeth, being five in number, are longer; the handle is also flatter, and rather crooked.

In the first, the handle *ab* (see fig. 1.) is four feet three inches in length; the blade *bc* is about two feet; the piece of wood in which the teeth are fixed, one foot ten inches and a half. In the second, the handle is four feet one inch; the blade, two feet eight inches; the piece in which the teeth are fixed, $1\frac{1}{2}$ inches.

The difference in the construction of these two scythes renders it necessary to use them in a different manner, which will be better acquired in practice than by precept. Such as are accustomed to the use of the common scythe will soon find out the most advantageous manner of using these new kinds of scythes, and of laying down the corn properly after it is cut.

It is necessary to observe, that, in mowing grass, the feet are held in a position nearly parallel to each other, whereas in reaping corn they should be kept on a line, the one behind the other, bringing the right foot forward, and moving the left towards it. The reason is, that when grass is mowed it is fit to fall where it is cut; but when corn is cut down, it is to be laid in a proper manner against that which is not yet cut, and which is at the reaper's left hand. Were the feet kept parallel to each other, the reaper would be under the necessity of extending, and turning his body, in a very inconvenient manner.

These observations having been admitted, the society next made experiments on the 11th, 12th, 13th, 14th, 15th they discovered, that when the stalks of corn are cut down by reason of extremely wet weather, the wooden teeth

of the scythes are apt to lay hold of some ears, to the stalks of which the iron does not extend; and therefore these not being cut below, are pulled to that the grain is scattered. This chiefly happens from the reapers not being accustomed to that kind of scythe, and therefore not knowing how to adapt it to particular existing circumstances.

It occurred to an ingenious blacksmith, that, in order to remedy this inconvenience, a collector made of cloth should be added to the common scythe, as may be seen at fig. 2. where *abc* is a common scythe, *cdmefne* Fig. 2. is the gatherer, which at *cde* is composed of a thin plate of iron, having a hollow at its extremity for receiving the point of the blade. At *d* *e* are holes for sewing in the cloth, which is coarse, light, and of low price; it is also fixed to two thick iron wires, of which the upper one is continued to *f*, where it terminates in a hole in the handle; the other is fixed to the back of the blade. The manner of fixing this gatherer to the back of the scythe will be better understood by referring to fig. 3. which represents one of the irons which, by means of the screw, are fastened to the back of the scythe. These proceed from, and make part of the upright irons *mn, lo*, which serve to keep the gatherer extended.

This contrivance is both cheap and simple; but an attempt was made to render it more so, by substituting two iron hoops for the gatherer, which are shewn in fig. 2. by the dotted lines *h g, ki*, with a cross piece *p*, which connects them. Experience has shewn, however, that the gatherer is in general preferable to these hoops, as it does not leave an ear of corn behind.

SCYTHIA, an ancient name for the northern parts of Asia, now known by the name of *Tartary*; also for some of the north-eastern parts of Europe.

This vast territory, which extends itself from the Ilser or Danube, the boundary of the Celts, that is, from about the 25th to almost the 112th degree of east longitude, was divided into Scythia in Europe and Scythia in Asia, including, however, the two Sarmatias; or, as they are called by the Greeks, *Sauromatias*, now the Circassian Tartary, which lay between and severed the two Scythias from each other. Sauromatia was also distinguished into European and Asiatic; and was divided from the European Scythia by the river Don or Tanais, which falls into the Palus Meotidis; and from the Asiatic by the Rha, now Volga, which empties itself into the Caspian sea.

1. The Asiatic Scythia comprehended, in general, great Tartary, and Iussia in Asia; and, in particular, the Scythia beyond or without Imaus, contained the regions of Bogdoi or Onicoi, and Tanguti. That within, or on this side Imaus, had Turkestan and Mogal, the Uluck or Zangai, Kalmauc and Nogaian Tartars; besides Siberia, the land of the Samoieses, and Nova Zembla. These three last not being to soon inhabited as the former, as may be reasonably supposed, were wholly unknown to the ancients; and the former were peopled by the Euxinians, Scythians, Gandari, Sacks, and Massagetes. As for Sarmatia, it contained Albania, Iocica, and Colchis, which makes now the Circassian Tartary, and the province of Georgia.

2. Scythia in Europe reached (towards the fourth) to the Po and the Alps, by which it was divided from Celtio-Gallia. It was bounded on the south by the

Scythe,
3. still.

Section II
Sea

Sea.

the Ilér or Danube and the Luxine sea. Its northern limits have been supposed to stretch to the spring-heads of the Borithenes or Nieper, and the Rha or Volga, and so to that of the Tanais.—The ancients divided this country into Scythia Axiamaea, which lay eastward, joining to Scythia in Asia; and Sarmatia Europæa on the west. In Scythia, properly so called, were the Arimæzi on the north; the Gætæ or Cæmans along the Danube, on the south; and the Neuri between these two. So that it contained the European Russia or Muscovy, and the Lesser Crim Tartary eastward; and, on the west, Lithuania, Poland, part of Hungary, Transilvania, Walachia, Bulgaria, and Moldavia. Sarmatia is supposed to have reached northward to that part of Swedeland called *Fennigia*, now *Finland*; in which they placed the Oænes, Panoti, and Hippopodes. This part they divided from Northern Germany, now the west part of Sweden and Norway, by the *Mare Sarmaticum* or *Scythicum*, which they supposed ran up into the northern ocean, and, dividing Lapland into two parts, formed the western part of Sweden, with Norway, into one island, and Finland into another; supposing this also to be cut off from the continent by the gulf of that name.

Although the ancient Scythians were celebrated as a warlike people, yet their history is too uncertain and obscure to enable us to give any detail which would not prove equally tiresome and uninteresting to the reader. Mr Pinkerton, in a dissertation on their origin, endeavours to prove that they were the most ancient of nations; and he assigns for the place of their first habitation the country known by the name of Persia. From Persia, he thinks, they proceeded in numerous hordes westward, surrounded the Euxine, peopled Germany, Italy, Gaul, the countries bordering on the Baltic, with part of Britain and Ireland. That the Scythians were of Asiatic origin cannot, we think, be questioned; and as Persia was peopled at a very early period, it may not improbably have been their parent country; but when our author contends that their empire had subsisted for more than 1500 years before Ninus the founder of the Assyrian monarchy, and that it extended from Egypt to the Ganges, and from the Persian gulf and Indian sea to the Caspian, we cannot help thinking that his prejudices against the Celts, and his desire to do honour to his favourite Goths, have made him advance a paradox inconsistent with the most authentic records of antiquity. His dissertation however is ingenious, and replete with a variety of curious learning.

SCYTHIAN LAMB, in *Natural History*. See *Scythian LAMB*.

SCYTHROPS, or *CHANNEL BILL*, a genus of birds belonging to the order of *Picæ*. See *ORNITHOLOGY*, N° 149.

SEA, in a strict sense, signifies a large portion of water almost surrounded by land, as the Baltic and Mediterranean seas; but it is frequently used for that vast body of water which encompasses the whole earth.

What proportion the superficies of the sea bears to that of the land cannot easily be ascertained. Buffon has supposed that the surface of our globe is equally divided between land and water, and has accordingly calculated the superficies of the sea to be 85,502,526 square miles. But it is now well known that the ocean covers much more than the half of the earth's surface. Buffon be-

lieved the existence of a vast southern continent, which Captain Cook has shown to be visionary. It was this circumstance which misled him. According to the most accurate observations hitherto made, the surface of the sea is to the land as three to one; the ocean therefore extends over 128,235,759 square miles, supposing the superficies of the whole globe to be 170,981,012 square miles. To ascertain the depth of the sea is still more difficult than its superficies, both on account of the numerous experiments which it would be necessary to make, and the want of proper instruments for that purpose. Beyond a certain depth the sea has hitherto been found unfathomable; and though several methods have been contrived to obviate this difficulty, none of them has completely answered the purpose. We know in general that the depth of the sea increases gradually as we leave the shore; but if this continued beyond a certain distance, the depth in the middle of the ocean would be prodigious. Indeed the numerous islands everywhere scattered in the sea demonstrate the contrary; by showing us that the bottom of the water is unequal like the land, and that so far from uniformly sinking, it sometimes rises into lofty mountains. If the depth of the sea be in proportion to the elevation of the land, as has generally been supposed, its greatest depth will not exceed five or six miles, for there is no mountain six miles perpendicular above the level of the sea. The sea has never been actually sounded to a greater depth than a mile and 66 feet; every thing beyond that therefore rests entirely upon conjecture and analogical reasoning, which ought never to be admitted to determine a single point that can be ascertained by experiment, because, when admitted, they have too often led to false conclusions. Along the coasts, where the depth of the sea is in general well known, it has always been found proportioned to the height of the shore: when the coast is high and mountainous, the sea that washes it is deep; when, on the contrary, the coast is low, the water is shallow. Whether this analogy holds at a distance from the shore, experiments alone can determine.

To calculate the quantity of water contained in the sea, while its depth is unknown, is impossible. But if we suppose with Buffon that its medium depth is the fourth part of a mile, the ocean, if its superficies be 128,235,759 square miles, will contain 32,058,939.75 cubic miles of water.

Let us now endeavour to compute the quantity of water which is constantly discharged into the sea. For this purpose let us take a river whose velocity and quantity of water is known, the Po, for instance, which according to Riccioli is 1000 feet (or 100 perches of Bologna) broad, 12 feet deep, and runs at the rate of four miles in an hour; consequently that river discharges into the sea 200,000 cubic perches of water in an hour, or 4,800,000 in a day. A cubic mile contains 125,000,000 cubic perches; the Po therefore will take 26 days to discharge a cubic mile of water into the sea. Let us now suppose, what is perhaps not very far from the truth, that the quantity of water which the sea receives from the rivers in any country is proportioned to the extent of that country. The Po from its origin to its mouth traverses a country 380 miles long, and the rivers which fall into it on every side rise from sources about sixty miles distant from it.

The

What proportion the surface of the sea bears to that of the land.

Quantity of water which it contains.

Buffon's Theory of the Earth, art. 10.

3. The Po, therefore, and the rivers which it receives, water a country of 45,600 square miles. Now since the whole superficies of the dry land is about 42,745,253 square miles, it follows, from our supposition, that the quantity of water discharged by all the rivers in the world, in one day, is 36 cubic miles, and in a year 13,140. If therefore the sea contains 32,078,030 cubic miles of water, it would take all the rivers in the world 2439 years to discharge an equal quantity.

4. It may seem surprising that the sea, since it is continually receiving such an immense supply of water, does not visibly increase, and at last cover the whole earth. But our surprize will cease, if we consider that the rivers themselves are supplied from the sea, and that they do nothing more than carry back those waters which the ocean is continually lavishing on the earth. Dr Halley has demonstrated that the vapours raised from the sea and transported on land are sufficient to maintain all the rivers in the world. The simplicity of this great process is astonishing: the sea not only connects distant countries, and renders it easy to transport the commodities of one nation to another, but its waters rising in the air descend in showers to fertilize the earth and nourish the vegetable kingdom, and collecting into rivers flow onwards, bringing fertility and wealth and commerce along with them, and again return to the sea to repeat the same round.

5. The knowledge of this process of nature might, one would think, have convinced philosophers that the proportion between sea and land continued always nearly the same. Philosophers however have formed different theories about this as well as most other subjects, maintaining on the one hand that the sea is continually encroaching on the land, and on the other that the land is constantly gaining on the sea. Both sides have supported their theories by arguments, demonstrations, and incontrovertible facts!

6. The height of the mountains, say the philosophers who support the encroachments of the sea, is continually diminishing; exposed to the violence of every storm, the hardest rocks must at last give way and tumble down. The rivers are continually sweeping along with them particles of earth which they deposit in the bottom of the sea. Both the depth of the ocean then and the height of the dry land must be always decreasing; the waters therefore must, unless a part of them were annihilated, spread over a greater extent of surface in proportion as these causes operate. This reasoning, convincing as it is, might be confirmed by a great number of facts: it will be sufficient however to mention one or two. In the reign of Augustus the island of Wight made a part of Britain, so that the English crossed over to it at low water with cart loads of tin; yet that island is at present separated from Britain by a channel half a mile wide. The Godwin sands on the eastern shore of England were formerly the fertile estate of earl Godwin. Nor are the encroachments of the sea confined to Britain. In the bay of Baie near Naples there are remains of houses and streets still visible below the present level of the sea. The sea therefore is making continued encroachments upon the land; and the time will come, say they, when the waters will again cover the surface of the earth.

Such are the arguments of those philosophers who maintain the continual encroachments of the sea. Those

7. who maintain the opposite theory, that the land is gradually gaining on the sea, though they pretend not to deny the facts advanced by their opponents, affirm that they are altogether insufficient to establish the hypothesis which they were brought forward to support. Though the rivers carry down particles of earth into the sea, these, say they, are either accumulated on other shores, or collecting in the bottom of the ocean, harden into stone, which being possessed of a vegetative power rises by degrees above the surface of the sea and forms rocks, and mountains, and islands. The vegetative nature of stone indeed is sufficient, of itself, to convince us that the quantity of earth must be daily accumulating, and consequently that the surface of the sea is diminishing in extent. Celsius, a Swedish philosopher (for this dispute has been carried on in Sweden with the greatest keenness), has endeavoured to build this theory with more solid materials than vegetable stone. In a curious memoir, published in 1743, he asserts that the Baltic and the Atlantic, at least that part of it which washes Norway, is constantly diminishing; and he proves this by the testimony of a great many aged pilots and fishermen, who affirmed that the sea was become much shallower in many places than it had been during their youth: that many rocks formerly covered with water were now several feet above the surface of the sea: that loaded vessels used formerly to ride in many places where pinnaces and barks could now with difficulty swim. He produces instances of ancient sea-port towns now several leagues from the shore, and of anchors and wrecks of vessels found far within the country. He mentions a particular rock which 168 years before was at the bottom of the sea, but was then raised eight feet above its surface. In another place where the water 50 years before had reached to the knee there was then none. Several rocks, too, which during the infancy of some old pilots had been two feet under water, were then three feet above it. From all these observations M. Celsius concludes, that the water of the Baltic decreases in height 4½ lines in a year, 4 inches 5 lines in 18 years, 4 feet 5 inches in a hundred years, and in a thousand years 45 feet. Conscious, however, that these facts, how conclusive soever as far as relates to the Baltic, can never determine the general question, M. Celsius advances another argument in support of his theory. All that quantity of moisture, says he, which is imbibed by plants is lost to the general mass of water, being converted into earth by the putrefaction of vegetables. This notion had been mentioned by Newton, and was adopted by Van Helmont: it granted, it follows as a consequence that the earth is continually increasing and the water diminishing in a very rapid degree.

8. Such are the arguments advanced in support of both these arguments examined. theories; for it is needless to mention a notion of Linnæus that the whole earth was formerly covered with water except a single mountain. When fairly weighed, they amount to nothing more than this, that the sea has encroached upon the land in some places, and retired in others: a conclusion which we are very willing to allow. What was advanced by those philosophers who maintain that the sea is continually encroaching on the land, about the depth of the sea constantly diminishing, must remain a mere assertion till they prove by experiments, either that this is really the case, or that nature has no way of restoring those particles of

9. Arguer ts of those who affirm that the land is gaining on the sea.

4. Why it does not increase.

5. Theories of philosophers on this subject.

6. Arguments of those who affirm that the sea is encroaching on the land.

8. These arguments examined.

Sea.

earth which are washed down by the rivers. Nor have they any good reason to affirm that the height of the mountains is decreasing. Can a single unconceivable instance be produced of this? Are the Alps or the Andes, or the Pyrenees, or Caucasus, less lofty now than they were a thousand years ago? We mean not to deny that the rain actually washes down quantities of earth from the mountains, nor to affirm that the hardest rocks are able to resist continual downing, nor that many mountains have subsided, and continue to subside daily, from a thousand accidents. But the effects produced by all these causes are so trifling as to be altogether imperceptible (A). Nature has sufficiently guarded against such accidents; she has formed the mountains of the most durable materials; and where they are covered with earth, she has bound it together by a thick and firm matrix of grass, and thus secured it from the rains; and should accident deprive it of this covering, she takes care immediately to supply the defect. Even should the earth be swept away together with its covering, nature has still full resources left as frequently restore things to their former state. Many kinds of moss, one would be tempted to think, have been created for this very purpose: they take root and flourish almost upon the bare rock, and flourish as they decay a fresh seed bed for several of the hardy Alpine plants. These perish in their turn, and others succeed them. The roots of the plants bind fast the earth as it accumulates, more plants spring up and spread wider, till by degrees the whole surface is covered with a firm coat of grass.

Part of the Sea.

As the sea covers so great a portion of the globe, we should, no doubt, by exploring its bottom, discover a vast number of interesting particulars. Unfortunately in the greater part of the ocean this has hitherto been impossible. Part, however, has been examined; and the discoveries which this examination has produced may enable us to form some idea at least of the whole. The bottom of the sea, as might have been conjectured indeed beforehand, bears a great resemblance to the surface of the dry land, being, like it, full of plains, rocks, caverns and mountains; some of which are abrupt and almost perpendicular, while others rise with a gentle declivity, and sometimes tower above the water and form islands. Neither do the materials differ which compose the bottom of the sea and the basis of the dry land. If we dig to a considerable depth in any part of the earth, we uniformly meet with rock; the same thing holds in the sea. The strata, too, are of the same kind, disposed in the same manner, and form indeed but one whole. The same kind of mineral and lustrous substances are also found interspersed with these strata; and it is to them probably that the sea is indebted for its bitter taste. Over these natural and original strata an artificial bed has pretty generally been formed, composed of different materials in different places. It consists frequently of muddy tartareous substances firmly cemented

together, sometimes of shells or coral reduced to powder, and near the mouths of rivers it is generally composed of fine sand or gravel. The bottom of the sea resembles the land likewise in another particular: many fresh springs and even rivers rise out of it, which, displacing the salt water, render the lower part of the sea wherever they abound quite fresh. An instance of this kind occurs near Goa on the western coast of Indostan*, and another † in the Mediterranean sea not far from Alexandria. These facts occasioned a notion, which later experiments have exploded, that the sea beyond a certain depth was always fresh.

Substances of a very beautiful appearance are frequently brought up by the sounding line from the bottom of the sea. The plummet is hollowed below, and this cavity filled with tallow, to which some of the substances above which form the bed of the ocean. The substances are generally sand, gravel, or mud; but they are sometimes of the brightest scarlet, vermilion, purple, and yellow; and sometimes, though less frequently, they are blue, green, or white. These colours are owing to a kind of jelly which envelops the substances, and vanishes entirely as soon as this jelly dries. At times, however, they assume the appearance of tartareous crusts, and are then so permanent, that they can be received into white wax melted and poured round them, and perhaps a proper care might be converted into valuable points.

Sea-water is really, as any one may convince himself by putting it into a glass, as clear and transparent as river water. The various appearances therefore which it assumes are owing to accidental causes, and not to any change in the water itself. The depth, or the materials which compose the bottom of the sea, occasions it to assume different colours in different places. The Arabian gulf, for instance, is said to be red from the colour of the sands which form its bed. The appearance of the sea is affected too by the winds and the sun, while the clouds that pass over it communicate all their various and fleeting colours. When the sun shines it is green; when the sun gleams through a fog it is yellow; near the north pole it appears black; while in the torrid zone its colour is often brown. Sometimes the sea assumes a luminous appearance. See LIGHT, Vol. XII. page 2.

The sea contains the greatest quantity of salt in the torrid zone, where otherwise from the excessive heat it would be in danger of putrefaction: as we advance northward this quantity diminishes, till at the pole it nearly vanishes altogether. Under the line Lucas found that the sea contained a seventh part of solid contents, consisting chiefly of sea-salt. At Harwich he found it yielded $\frac{1}{4}$ th of sea-salt. At Carlscroon in Sweden it contains $\frac{1}{8}$ th part (B), and on the coast of Greenland a great deal less. This deficiency of salt near the poles probably contributes a good deal towards the prodigious

(A) M. Genfanne pretends that the Pyrenean mountains become an inch lower every ten years. But even according to his own calculation, it would require a million of years to level these mountains with the plain, though they continued to decrease at the same rate; and philosophers tell us that this rate is constantly diminishing!

(B) This gradual diminution of saltness from the equator to the pole is not, however, without particular exceptions. The Mediterranean sea contains $\frac{1}{4}$ th of sea-salt, which is less than the German sea contains.

Sea.

* Voye de l'Inde Malabar.
† Harwich.
Hydrog.
Physique de la Mer.

Colour of the Sea.

†† The sea.

... quantities of ice which are met with in these first
 ... a more moderate degree of cold
 ... than fresh water. It was this circumstance,
 ... together with its constant motion, which indu-
 ... ces the ancients to believe that the sea never froze.
 ... Even among the moderns it has been generally re-
 ... ceived as an axiom, that ice is originally formed in ri-
 ... vers. Buffon has made the great quantities of ice
 ... with which the South sea abounds an argument for the
 ... existence of a continent near the Antarctic pole. But
 ... it is now well known that great quantities of ice are
 ... formed at a distance from land. Sea-ice is of two kinds;
 ... field ice, which extends along the shore, and is only two
 ... or three feet thick; and mountain ice, which abounds
 ... in the middle of the ocean. The latter of these con-
 ... tains is sometimes prodigious. The sea-ice is always
 ... fresh, and has been often of great use to navigators.
 ... The weight of sea-water is 70 lb of river-water as 73
 ... to 72; that is, a cubic foot of sea-water weighs 73 lb,
 ... while the same quantity of river water weighs only 72 lb;
 ... but this proportion varies in different places. It is
 ... worthy of our attention, too, that the water at the sur-
 ... face of the sea contains less salt than near the bottom;
 ... the difference indeed is inconsiderable, but still it is
 ... something. The Comte de Merigli found the same
 ... quantity of water, when taken from the bottom of the
 ... Mediterranean, to weigh one ounce three pennyweights
 ... 31 grains; whereas from the surface it weighed only one
 ... ounce three pennyweights 29 grains. He repeated the
 ... experiment frequently with nearly the same result.

The sea, with respect to temperature, may be divided
 ... into two regions: The first begins at the surface of the
 ... water, and descends as far as the influence of the sun's
 ... rays; the second reaches from thence to the bottom of
 ... the sea. In summer the lower region is considerably
 ... colder than the upper; but it is probable that during
 ... winter the very reverse takes place; at least the Comte
 ... de Merigli found it so repeatedly in the Mediterranean.
 ... This naturally results from the situation of the water
 ... near the bottom of the sea. Unlike the land by the changes
 ... in the atmosphere, it retains at very nearly the same
 ... degree of temperature; and this is considerably above
 ... congelation; for the lower region of the sea, at least in
 ... the temperate parts of the world, was never known to
 ... freeze. Captain Ellis let down a sea-gage, (see GAGE)
 ... in latitude 24° 15' north, and longitude 25° 12' west,
 ... to take the degrees of temperature and faltness of the
 ... sea at different depths. It descended 5346 feet, which
 ... is a mile and eleven fathoms. He found the sea colder
 ... and colder in proportion to its depth till the gage had
 ... descended 3950 feet, when the mercury in the thermo-
 ... meter came up to 53; but the water never grew colder,
 ... though he let down the gage 2466 feet lower. At the
 ... surface the thermometer stood at 84.

The sea has three kinds of motion: 1. The first is
 ... that undulation which is occasioned by the wind. This
 ... motion is entirely confined to the surface; the bottom
 ... even during the most violent storms remains perfectly
 ... calm. Mr Boyle has remarked, from the testimony of
 ... several divers, that the sea is affected by the winds
 ... only to the depth of six feet. It would follow from
 ... this, that the height of the waves above the surface does
 ... not exceed six feet; and that this holds in the Mediter-
 ... ranean at least, we are informed by the Comte de Mer-
 ...igli, though he also sometimes observed them, during

a very violent tempest, six two feet higher. It is as-
 ... serted by Lloyd, and several other ancient writers, that
 ... oil calms the waves of the sea; and that divers were ac-
 ... customed to carry some of it for that purpose in their
 ... mouths. This account was always considered by the
 ... moderns as a fable, and treated with such contempt, that
 ... they did not even deign to put it to the test of ex-
 ... periment, till Dr Franklin accidentally discovered its
 ... truth. Having sailed in 1772 to be in the middle of a
 ... large lake, he observed that the water on one or two
 ... vessels was quite calm and smooth, while everywhere
 ... else it was very much agitated by the winds. He ap-
 ... plied to the captain for an explanation of this phenom-
 ... enon, who replied, that the cooks, he thought, had
 ... thrown their greasy water out of the larger tubs, and
 ... by that means still'd the sides of the vessels in question.
 ... This answer did not satisfy the Doctor at first; but re-
 ... collecting what Lilly had said on the subject, he resolv-
 ... ed at least to make the experiment. He did so accord-
 ... ingly in 1762, and found that oil actually calmed the
 ... waves of the sea. He repeated the experiment upon a
 ... pond at Clapham; the oil spread itself with great rapidity
 ... upon the surface, but did not produce the desired effect,
 ... because, having been thrown in upon the side opposite
 ... to the wind, it was immediately driven to the edge of
 ... the water. But upon throwing in a like quantity upon
 ... the other side of the lake, it calmed in an instant sever-
 ... al yards of the surface; and gradually spreading, ren-
 ... dered all that part of the lake, to the extent of at least
 ... half an acre, as smooth as glass. The curious effect pro-
 ... duced by this liquid may be accounted for by the differ-
 ... ence which exists between oil and water, and between oil
 ... and air, which prevents all immediate contact, all rub-
 ... bing of the one upon the other.

2. The second kind of motion is that continual ten-
 ... dency which the whole water in the sea has towards the
 ... equator. It is greater near the equator than about the
 ... poles; and indeed cannot be said to take place at all in
 ... the northern hemisphere beyond the tropic. It begins
 ... on the west side of America, where it is most violent;
 ... hence that part of the ocean has been called *Pacific*.
 ... As the waters advance westward their motion is accel-
 ... erated; so that, after having traversed the glets, they
 ... strike with great violence on the eastern shore of Amer-
 ... ica. Being stopped by that continent, they turn north-
 ... ward, and run with considerable impetuosity in the
 ... gulf of Mexico; from thence they proceed along the
 ... coast of North America, till they come to the north
 ... side of the great bank at Newfoundland, when they
 ... turn off, and run down through the Western Isles.
 ... This current is called the *Gulf Stream*. It was first
 ... accurately described by Dr Franklin, who remarked
 ... also, that the water in it having been originally heated
 ... in the torrid zone, cools so gradually in its passage
 ... northward, that even the latitude might be found in
 ... any part of the stream by means of a thermometer.—
 ... This motion of the sea westward has never been ex-
 ... plained; it seems to have some connection with the
 ... trade-winds and the diurnal revolution of the earth on
 ... its axis.

3. The third and most remarkable motion of the sea
 ... is the tide, which is a regular swell of the ocean once
 ... every 12 hours, owing to Newton has demonstrated,
 ... to the attraction of the moon. In the middle of the
 ... sea the tide seldom rises higher than one or two feet,

12
 Temperature of the
 sea.
 Boyle de
 Tremble
 Robinson
 Submer-
 gation.
 Phil. Tr.
 for 1771,
 p. 215.
 13
 The sea
 has three
 kinds of
 motion
 occasioned
 by the
 wind.

50
 14
 111
 15
 16
 17
 18
 19
 20
 21
 22
 23
 24
 25
 26
 27
 28
 29
 30
 31
 32
 33
 34
 35
 36
 37
 38
 39
 40
 41
 42
 43
 44
 45
 46
 47
 48
 49
 50

Sea- but on the coast it frequently reaches the height of 45 feet, and, in some places even more. The tide generally rises higher in the evening than in the morning; on the coast of Britain this holds in winter, but in summer the morning tides are highest. In some seas it is said that there are no tides. This cannot be owing to their being surrounded by land, because there is a tide in the lakes of North America. For an explanation of these and other phenomena we refer to the article TIDE.

Sea-air, that part of the atmosphere which is above the sea.

Sea-air has been found salubrious and remarkably beneficial in some distempers. This may be owing to its containing a greater portion of oxygenous gas or vital air, and being less impregnated with noxious vapours than the land. Dr Ingenhousz made several experiments to ascertain the salubrity of sea-air. By mixing equal measures of common air and nitrous air, he found, that at Gravesend, they occupied about 104, or one measure and $\frac{1}{100}$ of a measure; whereas on sea, about three miles from the mouth of the Thames, two measures of air (one of common and one of nitrous air) occupied from 0.91 to 0.94. He attempted a similar experiment on the middle of the channel between the English coast and Ostend; but the motion of the ship rendered it impracticable. He found that in rainy and windy weather the sea-air contained a smaller quantity of vital air than when the weather was calm. On the sea-shore at Ostend it occupied from 94 $\frac{1}{2}$ to 97; at Bruges he found it at 105; and at Antwerp 109 $\frac{1}{2}$. Dr Ingenhousz thus concludes his paper:

It appears, from these experiments, that the air at sea and close to it is in general purer and fitter for animal life than the air on the land, though it seems to be subject to the same incertainty in its degree of purity with that of the land; so that we may now with more confidence send our patients, labouring under consumptive disorders, to the sea, or at least to places situated close to the sea, which have no marshes in their neighbourhood. It seems also probable, that the air will be found in general much purer far from the land than near the shore, the former being never subject to be mixed with land air.

Dr Damman, an eminent physician and professor royal of midwifery at Ghent, told Dr Ingenhousz, that when he was formerly a practitioner at Ostend, during seven years, he found the people there remarkably healthy; that nothing was rarer there than to see a patient labouring under a consumption or asthma, a malignant, putrid, or spotted fever; that the disease to which they are the most subject, is a regular intermittent fever in autumn, when sudden transitions from hot to cold weather happen.

People are in general very healthy at Gibraltar, though there are very few trees near that place; which Dr Ingenhousz thinks is owing to the purity of the air arising from the neighbourhood of the sea.

Most small islands are very healthy.

At Malta people are little subject to diseases, and live to a very advanced age.

SEA-Anemomy. See ANIMAL-Flower.

SEA-Bear. } See PHOCA, }

SEA-Calf. } See PHOCA, }

SEA-Cow. } See TRICHECUS, } MAMMALIA Index.

SEA-Crow, *Mire-Crow*, or *Pewit*. See LARUS, OR-
NITHOLOGY Index.

SEA-Dead. See ASPHALTITES.

SEA-Devil. See LOPHIUS, ICHTHYOLOGY Index.

SEA-Dragon, a monster of a very singular nature. In the Gentleman's Magazine for the year 1749, we have the account of a sea dragon which was said to be taken between Ostend and Southwold, on the coast of Suffolk, and afterwards carried round the country as a curiosity by the fishermen who caught it.

"Its head and tail (says the writer) resemble those of an alligator; it has two large fins, which serve it both to swim and to fly; and though they were so dried that I could not extend them, yet they appear, by the folds, to be shaped like those which painters have given to dragons and other winged monsters that serve as supporters to coats of arms. Its body is covered with impenetrable scales; its legs have two joints, and its feet are hooped like those of an ass; it has five rows of very white and sharp teeth in each jaw, and is in length about four feet, though it was longer when alive, it having shrunk as it became dry.

"It was caught in a net with mackerel; and being dragged on shore, was knocked down with a fletcher or boat-hook. The net being opened, it suddenly sprung up, and flew above 50 yards: the man who first seized it had several of his fingers bitten off; and the wound mortifying, he died. It afterwards fastened on the man's arm who shows it, and lacerated it so much, that the muscles are shrunk, and the hand and fingers distorted; the wound is not yet healed, and is thought to be incurable. It is said by some to have been described by naturalists under the name of the *Sea-dragon*." We must add to the account now given of the monster called a *sea-dragon*, that we think it extremely probable that the animal was nothing more than a distorted or overgrown individual of some of the well known species of fish.

SEA-Gage. See SEA-GAGE.

SEA-Hare. See LAPLYSIA, HELMINTHOLOGY Index.

SEA-Horse, in Ichthyology, the English name of the Hippocampus. See SYNGNATHUS, ICHTHYOLOGY Index.

SEA-Lemon. See DORIS, HELMINTHOLOGY Index.

SEA-Lion. See PHOCA, MAMMALIA Index.

SEA-Mall, or *SEA-Mew*. See LARUS, ORNITHOLOGY Index.

SEA-Man. See MERMAID.

SEA-Marker. The erection of beacons, light-houses, and sea-marks, is a branch of the royal prerogative. By 8 Eliz. 13. the corporation of the Trinity-house are empowered to set up any beacons or sea-marks wherever they shall think them necessary; and if the owner of the land or any other person shall destroy them, or take down any steeple, tree, or other known sea-mark, he shall forfeit 100l. sterling; or, in case of inability to pay it, he shall be *ipso facto* outlawed.

SEA-Needle, *Gar-fish*. See ESOX, ICHTHYOLOGY Index.

SEA-Nettle. See ANIMAL-Flower.

SEA-Pie, or *Oyster-Catcher*. See HÆMATOPUS, ORNITHOLOGY Index.

SEA-Plant, are those vegetables that grow in salt-water within the shores of the sea. The old botanists divided

divided these into three classes. 1. The first class, according to their arrangement, contained the *algæ*, the *fuci*, the *sea-mosses* or *conferveæ*, and the different species of sponges. 2. The second contained substances of a hard texture, like stone or horn, which seem to have been of the same nature with what we call *zoophyta*, with this difference, that we refer sponges to this class and not to the first. The third class was the same with our *lithophyta*, comprehending *corals*, *mandrepora*, &c. It is now well known that the genera belonging to the second and third of these classes, and even some referred to the first, are not vegetables, but animals, or the productions of animals. See CORALINA, MADREPORA, SPONGIA. Sea-plants, then, properly speaking, belong to the class of cryptogamia, and the order of *algæ*; and, according to Boniare, are all comprehended under the genus of *fucus*. We may also add several species of the *ulva* and *conferæ* and the *argazo*. The *fuci* and marine *ulvæ* are immerse in the sea, are sessile, and without root. The marine *conferæ* are either sessile or floating. The *argazo* grows beyond soundings.

As some species of the *fucus*, when dried and preserved, are extremely beautiful, the curious, and especially those who prosecute the study of botany, must be anxious to know the best method of preserving them, without destroying their colour and beauty. The following method is recommended by M. Muddyt. Take a sheet of paper, or rather of pasteboard, and cover it with varnish on both sides; and having rowed in a boat to the rock where the *fucus* abounds, plunge your varnished paper into the water, and, detaching the *fucus*, receive it upon the paper. Agitate the paper gently in the water, that the plant may be properly spread over it; and lift them up together softly out of the water: then fix down with pins the strong stalks, that they may not be displaced, and leave the plant lying upon the varnished paper to dry in the open air. When it is fully dry, the different parts will retain their position, and the plant may be preserved within the leaves of a book. To free it from the slime and salt which adhere to it, wash it gently in fresh water, after being removed from the rock on which it grew.

SEA-Serpent, a monstrous creature, said to inhabit the northern seas about Greenland and the coasts of Norway. The following marvellous account of this monster is given by Guthrie. "In 1736, one of them was shot by a master of a ship: its head resembled that of a horse; the mouth was large and black, as were the eyes, a white mane hanging from its neck: it floated on the surface of the water, and held its head at least two feet out of the sea: between the head and neck were seven or eight folds, which were very thick; and the length of this snake was more than 125 yards, some say fathoms. They have a remarkable aversion to the smell of cañor: for which reason, ship, boat, and bark masters provide themselves with quantities of that drug, to prevent being overta. The serpent's olfactory nerves being remarkably exquisite. The particularities related of this animal would be incredible, were they not attested upon oath. Egede, a very reputable author, says, that on the 6th day of July 1734, a large and frightful sea-monster raised itself to high out of the water, that its head reached above the main-top-mast of the ship; that it had a long sharp snout, broad paws, and spouted water like a whale; that the body seemed to be covered with

scales; the skin was uneven and wrinkled, and the lower part was formed like a finke. The body of this monster is said to be as thick as a hoghead; his skin is variegated like a tortoise shell; and his excrement, which floats upon the surface of the water, is corrosive." Notwithstanding the belief of Guthrie, and the testimony which he produces, we cannot help doubting of the existence of the sea-serpent. Its bulk is said to be so disproportionate to all the known animals of our globe, that it requires more than ordinary evidence to render it credible; but the evidence which is offered is so very feeble and unsatisfactory, that no man of sound judgement would think it sufficient to establish the truth of an extraordinary fact.

Attempts have lately been made to revive the opinion of the existence of sea-mermaids and sea-serpents. An individual of the latter, it is supposed, was some time ago thrown on shore in Orkney. Part of the skeleton is said to be in the museum of the University of Edinburgh, and another part is in the possession of Mr Home of London, who thinks that it may have belonged to an individual of some of the whale tribe, perhaps a monster of that tribe; but according to others it is to be considered as constituting a distinct genus. We cannot avoid observing, that this point must remain unsettled till other species of this new genus have been discovered, or at least till an entire individual have been described by an experienced naturalist.

SEA-Sickness, a disorder incident to most persons on their first going to sea, occasioned by the agitation of the vessel. This disorder has not been much treated of, although it is very irksome and distressing to the patient during its continuance. It has, however, been found beneficial in althmatic and pulmonary complaints, and the instances in which it has proved fatal, are extremely rare. The sea-sickness appears to be a spasmodic affection of the stomach, occasioned by the alternate pressure and recoil of its contents against its lower internal surface, according as the rise and fall of the ship oppose the action of gravity.

The seas in which the attacks of this disorder are accompanied with the greatest violence, are those where the waves have an uninterrupted freedom of action; and of consequence bays, gulfs and channels, may be navigated with less inconvenience, as the waves, meeting with more frequent resistance, the vessel does not experience that gentle uniform vacillation which induces sickness, and renders the head giddy. A person feels less inconvenience from the disorder in a small vessel on the wide ocean, on which the slightest motion of the waves makes a strong impression. He is also less exposed to it in a very large vessel deeply laden, as the waves, in this case, scarcely affect the vessel. It is in ships of an ordinary size, and which carry but a light cargo, that the passenger suffers most from the sea-sickness. The sooner it takes place after embarkation, the continuance of it becomes the more probable. It does not always cease immediately on landing, but in some cases continues for a considerable time.

Many methods of preventing, or at least of mitigating this disorder, have been recommended, of which the most efficacious appear to be the following.

1. Not to go on board immediately after eating, and not to eat, when on board, any large quantity at a time.

2. To take much exercise, with as little intermission as possible; as indolent passengers are always the greatest sufferers from the disorder.

3. To keep much upon deck, even when the weather is stormy, as the sea breeze is not so apt to affect the stomach as the impure air of the cabin, rendered so for want of proper circulation.

4. Not to watch the motion of the waves, particularly when strongly agitated with tempest.

5. Carefully to shun all employments by which the mind may be harassed, as reading, studying, gaming, &c. and to seek all opportunities of mental relaxation.

6. To drink occasionally liquids containing carbonic acid, as the froth of beer strongly fermented, or wine and Seltzer water mixed together, and sweetened with powdered sugar.

7. It will also be beneficial to take sulphuric acid diluted, dropped on a bit of sugar, or in peppermint water, or ten drops of ether.

The proper diet consists of bread and fresh meat, to be eaten cold with pepper. All sweet flavoured food should be carefully avoided, and the passenger ought to refrain from fat, and particularly from such meat as is in the smallest degree tainted. Even the smell of flowers is injurious, for which reason marine productions ought not to be examined; but the fumes of vinegar may be advantageously inhaled. The drink should consist of lemonade or tart wines, but never of common water. An accidental diarrhoea has often relieved the patient from sea-sickness, and therefore a gentle laxative in such a disorder seems to be indicated. It will also be found useful to apply a tonic anodyne plaster to the pit of the stomach, spread upon leather, and covered with linen.

When symptoms of vomiting appear, they may often be remedied by the patient placing himself in a horizontal position on his back or belly, and lying perfectly still. If the fits of vomiting are too violent to be repressed, they should be promoted by a strong dose of salt water; not, however, to be often repeated, as it debilitates the stomach. When the emetic operates, the patient should bend his body, bringing his knees towards his breast, and supporting his head against a firm upright place. His garters and cravat must be untied, a precaution which will secure him from the danger of a rupture.

The vomiting having subsided, a state of repose will prevent its return, and the eyes may be kept shut for a considerable time. The patient must make choice of a cool, ventilated place, remembering to keep himself warm and well clothed, as perspiration is highly beneficial. A gargle of sugar dissolved in vinegar is to be taken in the morning, accompanied with frequent and

spare eating. Water must never be taken in its pure state, but mixed with wine, vinegar, or brandy. A glass of wine may be taken in the morning, with an infusion of orange peel, gentian root, or peruvian bark. A glass of punch occasionally taken will be extremely beneficial, by which perspiration is promoted.

Persons accustomed to smoke tobacco, will find the use of the pipe salutary on such occasions, but the practice of smoking will be injurious to all others. We may add that warm clothing, flannel shirts, caps, trowsers, &c. are powerful remedies against excessive expectoration, with every other symptom of this dreadful malady.

SEA-Star. See ASTERIAS, } HELMINTHOLOGY In-
SEA-Urchin. See ECHINUS, } *de.*

SEA-Water, the salt water of the sea. The principal salts contained in sea-water are, 1st, Common marine or culinary salt, compounded of fossil alkali or soda and marine acid; 2^{ly}, A salt formed by the union of the same acid with magnesium earth; and, lastly, A small quantity of nitric. The quantity of saline matter contained in a pint of sea-water, in the British seas, is, according to Neumann, about one ounce in each pint (A).

The saltness of this water is supposed to arise from numerous mines and mountains of salt dispersed here and there in the depths of the sea. Dr Halley supposes that it is probable the greatest part of the sea-salt, and of all salt lakes, as the Caspian sea, the Dead sea, the lake of Mexico, and the Titicaca in Peru, is derived from the water of the rivers which they receive; and since this sort of lakes has no exit or discharge but by the exhalation of vapours, and also since these vapours are entirely fresh or devoid of such particles, it is certain that the saltness of the sea and of such lakes must from time to time increase; and therefore the saltuck at this time must be greater than at any time heretofore. He further adds, that if, by experiments made in different ages, we could find the different quantity of salt which the same quantity of water (taken up in the same place, and in all other the same circumstances) would afford, it would be easy from thence, by rules of proportion, to find the age of the world very nearly, or the time wherein it has been acquiring its present saltness.

This opinion of Dr Halley is so improbable, that it is surprising to acute a philosopher could have adopted it. That fresh water rivers should in the course of many thousand years produce saltness in the sea, is quite incredible. If this were the case, every sea or great body of water which receives rivers must be salt, and must possess a degree of saltness in proportion to the quantity of water which the rivers discharge. But

10

(A) In Bergman's analysis of sea-water taken up in the beginning of June 1776, about the latitude of the Canaries, from the depth of 65 fathoms, the solid contents of a pint of the water were,

	Grs.	
Of common salt	253 $\frac{1}{2}$	} or 5 $\frac{1}{2}$ Grs.
Salted magnesia	69 $\frac{1}{4}$	
Gypsum	8 $\frac{1}{2}$	
Total	331 $\frac{3}{4}$	

so far is this from being true, that in *Polus Meotis* and the great lakes in America do not contain salt but fresh water. It may indeed be objected, that the quantity of salt which the rivers carry along with them and deposit in the sea, must depend on the nature of the soil through which they flow, which may in some places contain no salt at all; and this may be the reason why the great lakes in America and the *Polus Meotis* are fresh. But to this objection, which is merely hypothetical, there are numerous plain objections. It is a curious fact that the saltness of the sea is greatest under the line, and diminishes gradually as we advance to the poles: We must therefore suppose, if Dr HALL'S theory be true, that the earth contains more salt in the tropical regions than in the temperate zones, and more in the temperate zones than in the frigid; and consequently that the rivers in these different regions contain a quantity of salt proportionable to their distance from the equator. This, however, must be first proved by experiment, and cannot be founded on an established fact. But there is another circumstance that entirely destroys this theory. If we allow that the sea receives its saltness from the rivers, it must be equally salt or nearly so in every part of the earth. For, according to a simple and well known principle in chemistry, "when any substance is dissolved in water with the assistance of agitation, or whatever part of the water it is introduced, it will be equally diffused through the whole liquid." Now though it were true that a greater quantity of salt were introduced into the sea under the line than towards the poles, from the constant agitation occasioned by the wind and tide, the salt must soon pervade the whole mass of water. To say that the superior degree of heat in the tropical regions may dissolve a greater quantity of salt, will not destroy our argument; for it is an established principle in chemistry, that cold water will dissolve nearly as great a quantity of salt as hot water can dissolve.

The saltness of the sea has also been ascribed to the solution of subterraneous mines of salt which is supposed to abound in the bottom of the sea and along its shores. But this hypothesis cannot be supported. If the sea were constantly dissolving salt, it would soon become saturated; for it cannot be said that it is deprived of any part of its salt by evaporation, since rain-water is fresh. If the sea were to become saturated, neither fishes nor vegetables could live in it. We must therefore desist of being able to account for the saltness of the sea by second causes; and must suppose that it has been salt from the creation. It is impossible indeed to suppose that the waters of the sea were at any period fresh since the formation of fishes and sea-plants; for as fishes will not live in water saturated with salt, neither will they live in water that is fresh; we therefore conclude that the saltness of the sea has been nearly the same in all ages. This is the simplest hypothesis of the three that has been mentioned. It explains best the various phenomena, and is involved in fewest difficulties. We shall, however, allow that there may be some exceptions; that the saltness of some seas, or of particular parts of the same sea, may be increased by mines of rock-salt dispersed near its shores.

With regard to the use of this salt property of sea-water, it is observed, that the saltness of the sea preserves its waters pure and sweet, which otherwise would

corrupt and stink like a stilly lake, and consequently that some of the myriads of creatures which live in the ocean could then have a being. From thence also the sea water becomes much heavier, and therefore ships of greater size and quantity may be used thereon. Salt-water also doth not freeze so soon as fresh water, whence the seas are more free for navigation. We have a dissertation, by Dr HALL, concerning the medical uses of sea-water in distillates of the glands, &c. wherein the author premises some observations upon the nature of sea-water, considered as impregnated with particles of all the bodies it passes over, such as sal marine plants, fish, salts, minerals, &c. and saturated with their several essences, to which it adds that it is putrefaction; whence it is said to be supposed to contain a ferment; and the whole collection, or log, generated by the sulphureous gases passing through it, to constitute what we call sea-water, and which has distinguishing characteristics of which are fishes, bitterness, nitrosity, and acridity: whence the author concludes, that it may be justly expected to contribute singularly to the improvement of psyllæ. The cases in which our author proposes we are to expect advantages from sea-water are, 1. In all recent obstructions of the glands of the intestines and mesentery. 2. All recent obstructions of the pulmonary glands, and those of the viscera, which frequently produce consumptions. 3. All recent glandular swellings of the neck, or other parts. 4. Recent tumours of the joints, if they are not suppurated, or become scirrhous or cancerous, and have not carious bones for their cause. 5. Recent distensions upon the glands of the eyelids. 6. All distensions of the skin, from an erysipelas to a lepra. 7. Distillates of the glands of the nose, with their usual composition a thickness of the lip. 8. Obstructions of the kidneys, where there is no inflammation, and the stone not large. 9. In recent obstructions of the liver, this method will be proper, where it prevents consumptions of the belly, and affluents other medicines directed in icterical cases. The same remedy is said to be of signal service in the bronchocæle; and is likewise recommended for the prevention of the bilious colics that so frequently affect our mariners.

Preparation of SEA-WATER for a Putrefaction. As it is sometimes necessary to preserve sea-water in casks for bathing and other purposes, it is of importance to know how to keep it from putrefaction. In my experiments were made to determine this point by Mr HALL, and are recorded in the first volume of the *Memoirs of the Literary and Philosophical Society of Manchester*. His first experiment we shall here present to our readers. "To one quart of sea-water were added two scruples of fresh quick-lime; to another, half an ounce of common culinary salt; and a third was kept as a standard without any addition. The mouths of the bottles being loosely covered with paper, they were exposed to the action of the sun in some of the hottest weather in summer. In about a week the standard became very effusive; and the water, with the additional quantity of salt, did not continue sweet many hours longer; whereas that with lime continued many months without ever exhibiting the least marks of putridity." When he added a dram more of quicklime, the whole of the magnesia contained in the water was separated; and when a further addition was made, a lime-water was immediately

Sea.

immediately formed. He therefore concluded, that two scruples of quicklime are sufficient to preserve a quart of sea-water. The proportions, however, may vary a little, according to the strength of the quicklime employed.

1
Different
methods of
treething
sea-water.

Freshening of SEA-Water. The method of making sea-water fresh was long a desideratum in navigation. Many methods have been proposed for this purpose. Mr Appleby published an account of a process which he had instituted in the year 1734. He distilled sea-water with a quantity of *lapis infernalis* and calcined bones; but this process was soon laid aside, as it was not only difficult in itself, but rendered the water unpalatable. Dr Butler proposed soap-leys in place of Mr Appleby's ingredients; but the water was still liable to the same objection. Dr Stephen Hales recommended powdered chalk; but his method was expensive, and did not improve the taste of the water. Dr Lind of Portsmouth distilled sea-water without any ingredients; but as the experiment he made was performed in a vessel containing only two quarts, with a glass receiver, in his ludy, nothing conclusive can be drawn from it for the use of sailors.

2
Dr Irving's

At length Dr Irving brought the process to a very high degree of simplicity and perfection, by which the water is obtained pure, without much expence of fuel or a complicated apparatus. For this valuable discovery he received a reward of 5000*l*. The advantages of this method remain to be stated, which may be reduced to the following: 1. The abolishing all stills, still-heads, worm-pipes, and their tubes, which occupy so much space as to render them totally incompatible with the necessary business of the ship; and using in the room of these the ship's kettle or boiler, to the top whereof may occasionally be applied a simple tube, which can be easily made on board a vessel at sea, of iron plate, stove funnel, or tin sheet; so that no situation can prevent a ship from being completely supplied with the means of distilling sea-water. 2. In consequence of the principles of distillation being fully ascertained, the contrivance of the simplest means of obtaining the greatest quantity of distilled water, by making the tube sufficiently large to receive the whole column of vapour, and placing it nearly in a horizontal direction, to prevent any compression of the fluid, which takes place so much with the common worm. 3. The adopting of the simplest and most efficacious means of condensing vapour; for nothing more is required in the distillation but keeping the surface of the tube always wet, which is done by having some sea-water at hand, and a person to dip a mop or swab into this water, and pass it along the upper surface of the tube. By this operation the vapour contained in the tube will be entirely condensed with the greatest rapidity imaginable; for by the application of the wet mop thin sheets of water are uniformly spread, and mechanically pressed upon the surface of the hot tube; which being converted into vapour make way for a succession of fresh sheets; and thus, both by the evaporation and close contact of the cold water constantly repeated, the heat is carried off more effectually than by any other method yet known. 4. The carrying on the distillation without any addition, a correct chemical analysis of sea-water having evinced the futility of mixing ingredients with it, either to prevent an acid from rising with the vapour, or to destroy any bituminous oil supposed to exist in sea-water, and to contaminate the di-

Sea.

stilled water, giving it that fiery unpalatable taste inseparable from the former processes. 5. The ascertaining the proper quantity of sea-water that ought to be distilled, whereby the fresh water is prevented from contracting a noxious impregnation of metallic salts, and the vessel from being corroded and otherwise damaged by the salts eaking on the bottom of it. 6. The producing a quantity of sweet and wholesome water, perfectly agreeable to the taste, and sufficient for all the purposes of shipping. 7. The taking advantage of the dressing the ship's provisions, so as to distil a very considerable quantity of water from the vapour, which would otherwise be lost, without any addition of fuel. To sum up the merits of this method in a few words: The use of a simple tube, of the most easy construction, applicable to any ship's kettle. The rejecting all ingredients; ascertaining the proportion of water to be distilled, with every advantage of quality, saving of fuel, and preservation of boilers. The obtaining fresh water, wholesome, palatable, and in sufficient quantities. Taking advantage of the vapour which ascends in the kettle while the ship's provisions are boiling. All these advantages are obtained by the above mentioned simple addition to the common ship's kettles. But Dr Irving proposes to introduce two further improvements. The first is a hearth, or stove, so constructed that the fire which is kept up the whole day for the common business of the ship serves likewise for distillation; whereby a sufficient quantity of water for all the economical purposes of the ship may be obtained, with a very inconsiderable addition to the expence of fuel. The other improvement is that of substituting, even in the largest ships, cast-iron boilers, of a new construction, in the place of coppers.

As soon as sea-water is put into the boiler, the tube is to be fitted either into the top or lid, round which, if necessary, a bit of wet linen may be applied, to make it fit close to the mouth of the vessel; there will be no occasion for luting, as the tube acts like a funnel in carrying off the vapour. When the water begins to boil, the vapour should be allowed to pass freely for a minute, which will effectually clean the tube and upper part of the boiler. The tube is afterwards to be kept constantly wet, by passing a mop or swab, dipped in sea water, along its upper surface. The waste water running from the mop may be carried off by means of a board made like a spout, and placed beneath the tube. The distillation may be continued till three-fourths of the water be drawn off, and no further. This may be ascertained either by a gauge-rod put into the boiler, or by measuring the water distilled. The brine is then to be let out. Water may be distilled in the same manner while the provisions are boiling. When the tube is made on shore, the best substance for the purpose is thin copper well tinned, this being more durable in long voyages than tin-plates. Instead of mopping, the tube, if required, may have a case made also of copper, so much larger in diameter as to admit a thin sheet of water to circulate between them by means of a spiral copper thread, with a pipe of an inch diameter at each end of the case; the lower for receiving cold water, and the upper for carrying it off when heated.

When only a very small portion of room can be conveniently allowed for distillation, the machine (fig. 2.), which is only 27 inches long, may be substituted, as

Fig. 1.

Fig. 2.

Fig. 3.

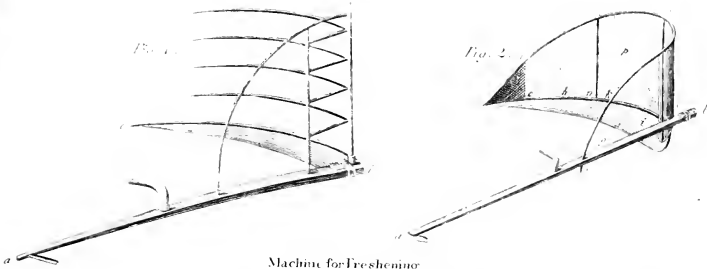

Machine for Freshening SEA WATER

Fig. 1.

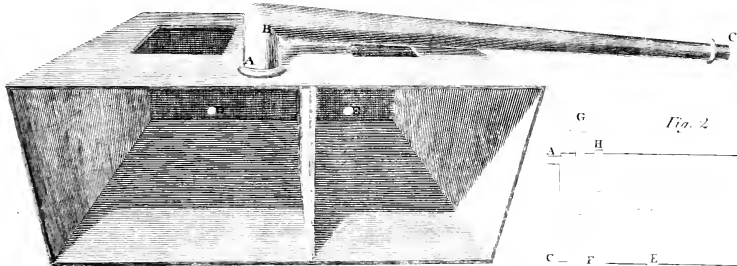
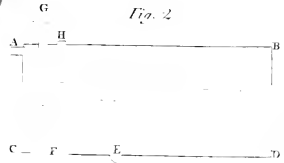

Fig. 2.



SECTOR.

Fig. 3.

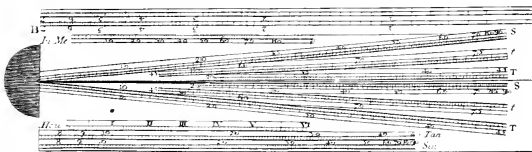

Fig. 1.

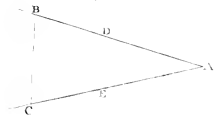
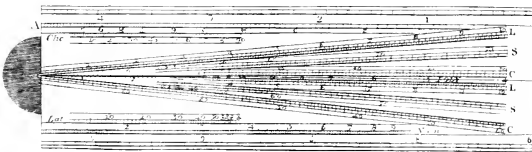
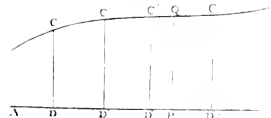
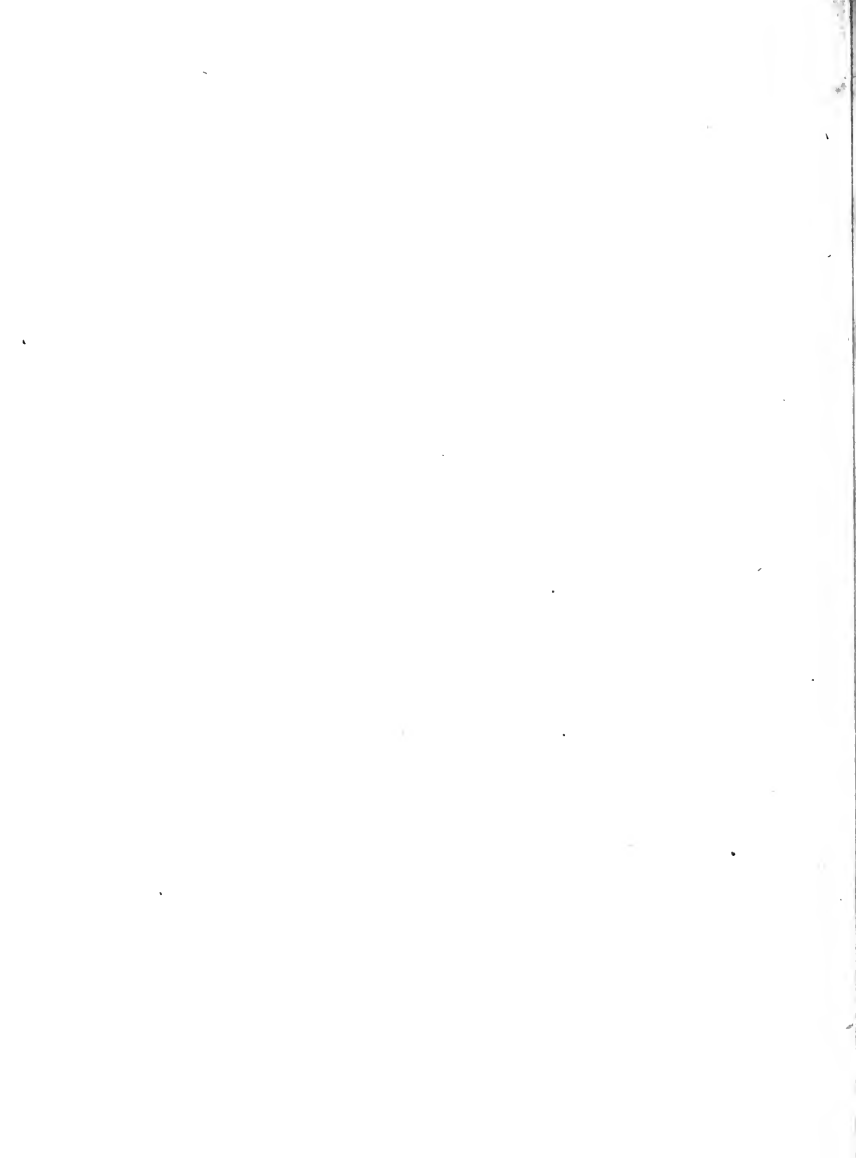

Fig. 4.



SERIES.





Sec. was done in this voyage. The principal intention of this machine, however, is to dull run and other liquors for which purpose it has been employed with extraordinary success, in preventing an emphysema, or fermentation.

Figure 1. represents in perspective a section of the tube as taken out of the boiler. In the back part at D, E, are seen openings for the cocks. On the top is a distilling tube A, B, C, of a inches diameter at A, and decreasing in size to diameter C; the length from B to C is five feet. Near C is a ring to prevent the water which is applied to the surface running with the distill'd water. In the middle of the tube, the low B, is a small lip or ledge, to hinder the distilled water from returning into the boiler by the boiling of the distil.

Fig. 2.

In figure 2. A, B, C, D, represent a vertical section of a copper box, 27 inches long, eleven inches wide, and 14 in height, turned on the inside. In the bottom F is an aperture about six inches in diameter, having a ring to fit on the still or boiler. The dotted lines which run nearly horizontal, are vessels of thin copper, turned on the outside, two feet long, seven inches wide, and three quarters of an inch deep. A, G is a funnel to receive cold water, which is conveyed into the vessels by communicating pipes, contrived in such a manner as to form a continuous quick circulation of the water through their whole extent. When the water is become hot by the action of the steam, it is discharged by the horizontal pipe at A. E is a pipe from which the distilled water or spirits run. F is not much above a fathom that the liquor coming from it does not evaporate, and hinders any steam from rising that way. On the top of the box, at H, is a safety valve, which proves any danger from a great accumulation of vapour not contained for want of a proper quantity of cold water.

We shall now mention a different method, discovered by the Chemist Lorange, by condensation of sea water. Sea water requires a very great degree of cold in order to become ice. Our author found that a freezing mixture, made by mixing three parts of powdered ice with two parts of common salt, was quite sufficient to freeze it. The cold produced by this mixture is equal to about 2° below 0 on Fahrenheit's thermometer.

A quantity of sea water is never entirely congel'd, a portion of it always remaining fluid and, which is very remarkable, this fluid part is incomparably more salt and more viscous than the rest; hence, if this be separated from the congel'd part, the latter on being melted will be found to contain much less salt than it did before congelation. This we shall call the *water of the solid part of ice*.

If the water of the solid part should be nearly congel'd, a part of it will remain fluid as in the next operation. This fluid part will contain a greater proportion of salt than the rest, which is of course more pure, and, being melted, forms the water of the second purification. Thus, by repeatedly freezing the same sea water, and separating the fluid part on the congel'd part in every operation, it will at last perfectly purify. From it we entirely disregard of salt, as it is fit for drink, and other purposes of a pure water, but it is soft.

At this time however, it is not to be conceiv'd, that a very great degree of cold has not been had; we have seen formed in cold a number of fluids or elements

from a compact body, and the quantity of the fluid parts bears a considerable proportion to the quantity of ice. But as the water, by undergoing the successive congelations, becomes more and more pure, so it becomes capable of being congel'd by a smaller and smaller degree of cold: the ice is of the same kind, more compact, and in greater quantity; the fluid part at last becomes very little considerable.

Sea weed, or *Agar Marina*, is commonly used as a manure on the sea-coast, where it has been planted in abundance. The best sort grows on rocks, and is taken from which kelp is made. The next best is called the *pealy ha weeds*; and the worst is that which is called fluk. In the neighbourhood of Berwick, the farmers mix it with stable dung and earth, and thus obtain a great quantity of excellent manure. Sea-weed is found also to be a very fit manure for gardens, as it not only enriches them, but destroys the vermin by which they are usually infest'd.

See *PLANT. S. S. ANATOMY, ZOOLOGY, ILLUSTRATIONS of the Arts, the Medicine.*

SEAL, *see P. 107, 108, and 127, 128.*

SEAL, a particular name of an order of medals, usually either made of gold, whereon are engraven the arms, device, &c. of the prince, state, community, magistracy, or private person, often with a legend or inscription; the metal whereof in wax serves to make acts, instruments, &c. authentic.

The use of seals, as a mark of authenticity to letters and other instruments in writing, is extremely ancient. We read of it among the Jews and Persians in the most ancient and most sacred records of history. And in the book of Jeremiah there is a very remarkable instance, not only of an attestation by seal, but also of the unusual formalities attending a Jewish purchase. In the civil law also, seals were the evidence of truth, and were required, on the part of the witnesses at least, as the confirmation of every testament. But in the times of our Saxon ancestors, they were not much in use in England. For though Sir Edward Coke relies on an instance of King Edward's making use of a seal about 120 years before the Conquest, yet it does not follow that this was the usage among the whole nation; and perhaps the charter he mentions may be of doubtful authority, from this very circumstance of its being sealed; since we are assur'd by all our ancient historians that sealing was not then in common use. The method of the Saxons was, for in his could write to Albinus; then nam'd, and whether they could write or not, to give a sign of the cross; which custom our Siftensers will give for the most part to this day keep up, by making a cross for their mark when unable to write their names. And indeed this inability to write, and therefore making a cross in its stead, is hourly practis'd by Chedwalla, a Saxon king, at the end of one of his charters. In like manner, and for the same reasons, at the death of the Normans, a brave but illiterate knight, at the dissolution of his house and the purchase of his land, could write no more than his name which could not be read; and when kneeling before his vassals, and thus unable to give his seal, he made a cross for his mark. The same is the custom of the world the Great Seal of Venice is engraven with the letters S. M. G. S. N. G. S. which will afford only by himself, and is accordingly the mark by which the Venetian ambassador's letters are sent.

4
Lorange's
method of
freshening
it by cong-
elation.

land. At the Conquest, the Norman lords brought over into this kingdom their own fashions; and introduced waxen seals only, instead of the English method of writing their names, and signing with the sign of the cross. The impressions of these seals were sometimes a knight on horseback, sometimes other devices; but coats of arms were not introduced into seals, nor indeed used at all till about the reign of Richard I. who brought them from the croisade in the Holy Land, where they were first invented and painted on the shields of the knights, to distinguish the variety of persons of every Christian nation who resorted thither, and who could not, when clad in complete steel, be otherwise known or ascertained.

This neglect of signing, and resting only upon the authenticity of seals, remained very long among us; for it was held in all our books, that sealing alone was sufficient to authenticate a deed: and so the common form of attesting deeds, "sealed and delivered," continues to this day; notwithstanding the statute 29 Car. II. c. 3. revives the Saxon custom, and expressly directs the signing in all grants of lands and many other species of deeds: in which, therefore, signing seems to be now as necessary as sealing, though it hath been sometimes held that the one includes the other.

The king's *great seal* is that whereby all patents, commissions, warrants, &c. coming down from the king are sealed; and the keeping whereof is in the hands of the lord chancellor. The king's *privy seal* is a seal that is usually first set to grants that are past the great seal.

SEAL. See *KEEPER of the Privy Seal*.

SEAL is also used for the wax or lead, and the impression thereon sixed to the thing sealed.

An amalgam of mercury with gold, reduced to the consistence of butter, by straining off part of the mercury through leather, has been recommended as a proper material for taking off the impression of seals in wax. In this state, the compound scarcely contains one part of mercury to two of gold; yet is of a silver whiteness, as if there was none of the precious metal in it. In this state it grows soft on being warmed or worked between the fingers; and is therefore proper for the purpose above-mentioned, but is not superior to some amalgams made with the inferior metals, as is well known to some impostors, who have sold for this use amalgams of the base metals as curious preparations of gold.

SEAL. See *PHOCA, MAMMALIA Index*.

SEALER, an officer in chancery appointed by the lord chancellor or keeper of the great seal, to seal the writs and instruments there made in his presence.

SEALING, in *Architecture*, the fixing a piece of wood or iron in a wall with plaster, mortar, cement, lead, or other solid binding. For staples, hinges, and joints, plaster is very proper.

SEALING *Wax*. See *WAX*.

SEAM, or SEME, of corn, is a measure of eight bushels.

SEAM of Glass, the quantity of 125 pounds, or 2½ stones, each five pounds weight. The seam of wood is an horse-load working.

SEAM, in mines, the same with a stratum or bed; as a seam of coal.

S E A M A N S H I P.

BY this word we express that noble art, or, more purely, the qualifications which enable a man to exercise the noble art of working a ship. A SEAMAN, in the language of the profession, is not merely a mariner or labourer on board a ship, but a man who understands the structure of this wonderful machine, and every subordinate part of its mechanism, so as to enable him to employ it to the best advantage for pulling her forward in a particular direction, and for avoiding the numberless dangers to which she is exposed by the violence of the winds and waves. He also knows what courses can be held by the ship, according to the wind that blows, and what cannot, and which of these is most conducive to her progress in her intended voyage; and he must be able to perform every part of the necessary operation with his own hands. As the seamen express it, he must be able "to hand, reef, and steer."

We are justified in calling it a *noble art*, not only by its importance, which it is quite needless to amplify or embellish, but by its immense extent and difficulty, and the prodigious number and variety of principles on which it is founded—all of which must be possessed in such a manner that they shall offer themselves without reflection in an instant, otherwise the pretended seaman is but a lubber, and cannot be trusted on his watch.

The art is practised by persons without what we call *education*, and in the humblest ranks of life, and therefore it suffers in the estimation of the careless spectator.

It is thought little of, because little attention is paid to it. But if multiplicity, variety, and intricacy of principles, and a systematic knowledge of these principles, intitle any art to the appellation of *scientific* and *liberal*, seamanship claims these epithets in an eminent degree. We are amused with the pedantry of the seaman, which appears in his whole language. Indeed it is the only pedantry that amuses. A scholar, a soldier, a lawyer, nay, even the elegant courtier, would disgust us, were he to make the thousandth part of the allusions to his profession that is well received from the jolly seaman; and we do the seaman no more than justice. His profession *must* engross his whole mind, otherwise he can never learn it. He possesses a prodigious deal of knowledge; but the honest tar cannot tell what he knows, or rather what he feels, for his science is really at his fingers ends. We can say with confidence, that if a person of education, versed in mechanics, and acquainted with the structure of a ship, were to observe with attention the movements which are made on board a first or second rate ship of war during a shifting storm, under the direction of an intelligent officer, he would be rapt in admiration.

What a pity it is that an art so important, so difficult, and so intimately connected with the invariable laws of mechanical nature, should be so held by its possessors, that it cannot improve, but must die with each individual. Having no advantages of previous education,

tion, they cannot arrange their thoughts; they can hardly be said to think. They can far less express or communicate to others the intuitive knowledge which they possess; and their art, acquired by habit alone, is little different from an instinct. We are as little entitled to expect improvement here as in the architecture of the bee or the beaver. The species (pardon the allusion, ye generous hearts of oak) cannot improve. Yet a ship is a machine. We know the forces which act on it, and we know the results of its construction—all these are as fixed as the laws of motion. What hinders this to be reduced to a set of practical maxims, as well founded and as logically deduced as the working of a steam engine or a cotton mill. The stoker or the spinner acts only with his hands, and may "whittle as he works, for want of thought;" but the mechanic, the engineer, thinks for him, improves his machine, and directs him to a better practice. May not the rough seaman look for the same assistance; and may not the ingenious speculatist in his closet unravel the intricate thread of mechanism which connects all the manual operations with the unchangeable laws of nature, and both furnish the seaman with a better machine and direct him to a more dexterous use of it?

We cannot help thinking that much may be done; nay, we may say that much has been done. We think highly of the progressive labours of Renaud, Piron, Bouguer, Du Hamel, Gougnard, Bernoulli, Euler, Romme, and others; and are both surpris'd and sorry that Britain has contributed so little in these attempts. Gordon is the only one of our countrymen who has given a professedly scientific treatise on a small branch of the subject. The government of France has always been strongly impressed with the notion of great improvements being attainable by systematic study of this art; and we are indebted to the endeavours of that ingenious nation for any thing of practical importance that has been obtained. M. Bouguer was professor of hydrology at one of the marine academies of France, and was enjoined, as part of his duty, to compile dissertations both on the construction and the working of ships. His *Traité du Navire*, and his *Manœuvre des Vaisseaux*, are undoubtedly very valuable performances: So are those of Euler and Bernoulli, considered as mathematical dissertations, and they are wonderful works of genius, considered as the productions of persons who hardly ever saw a ship, and were totally unacquainted with the profession of a seaman. In this respect Bouguer had great superiority, having always lived at a sea port, and having made many very long voyages. His treatises therefore are infinitely better accommodated to the demands of the seaman, and more directly instructive; but still the author is more a mathematician than an artist, and his performance is intelligible only to mathematicians. It is true, the academical education of the young gentlemen of the French navy is such, that a great number of them may acquire the preparatory knowledge that is necessary; and we are well informed that, in this respect, the officers of the British navy are greatly inferior to them.

But this very circumstance has furnished to many persons an argument against the utility of those performances. It is said that, "notwithstanding this superior mathematical education, and the possession of those boasted performances of M. Bouguer, the French

are greatly inferior, in point of seamanship, to our countrymen, who have not a page in their language to instruct them, and who could not peruse it if they had it." Nay, so little do the French themselves seem sensible of the advantage of these publications, that no person among them has attempted to make a familiar abridgement of them, written in a way fitted to attract attention; and they still remain neglected in their original altitude and uninteresting form.

We wish that we could give a satisfactory answer to this objection. It is just, and it is important. These very ingenious and learned dissertations are by no means so useful as we should expect. They are large books, and appear to contain much; and as their plan is logical, it seems to occupy the whole subject, and therefore to have done almost all that can be done. But, alas! they have only opened the subject, and the study is yet in its infancy. The whole science of the art must proceed on the knowledge of the impulsions of the wind and water. These are the forces which act on the machine; and its motions, which are the ultimatum of our research, whether as an end to be obtained or as a thing to be prevented, must depend on these forces. Now it is with respect to this fundamental point that we are as yet almost totally in the dark. And, in the perform-

ances of M. Bouguer, as also in those of the other authors we have named, the theory of these forces, by which their quantity and the direction of their action are ascertained, is altogether erroneous; and its results deviate so enormously from what is observed in the motions of a ship, that the person who should direct the operations on shipboard, in conformity to the maxims deducible from M. Bouguer's propositions, would be baffled in most of his attempts, and be in danger of losing the ship. The whole proceeds on the supposed truth of that theory which states the impulse of a fluid to be in the proportion of the square of the sine of the angle of incidence; and that its action on any small portion, such as a square foot of the sails or hull, is the same as if that portion were detached from the rest, and were exposed, single and alone, to the wind or water in the same angle. But we have shown, in the article *RESISTANCE of Fluids*, both from theory and experience, that both of these principles are erroneous, and this to a very great degree, in cases which occur most frequently in practice, that is, in the small angles of inclination. When the wind falls nearly perpendicular on the sails, theory is not very erroneous; but in these cases, the circumstances of the ship's situation are generally such that the practice is only, occurring almost without thought; and in this case, too, even considerable deviations from the very best practice are of no great moment. The interesting cases, where the intended movement requires or depends upon very oblique actions of the wind on the sails, and its practicality or impracticality depends on a very small variation of this obliquity; a mistake of the force, either as to intensity or direction, produces a mighty effect on the resulting motion. This is the case in sailing to windward; the most important of all the general problems of seamanship. The trim of the masts, and the cause of the ship, to as to gain most on the wind, are very nice things; and as they are confined within very narrow limits, an equal mistake produces a very considerable effect. The same thing obtains in many of the nice points

4
which has
been ze-
alously
culti-
vated by
the French
philosophers.

5
Argument
against the
utility of
their per-
formances.

Means of tacking, box-hauling, wearing after lying to in a storm, &c.

The error in the second assertion of the theory is still greater, and the action on one part of the sail or hull is to greatly modify by its action on another adjoining part, that a stay-sail is often seen hanging like a loote ring, although there is nothing between it and the wind; and this merely because a great sail in its neighbourhood kinds off a lateral stream of wind, which completely hinders the wind from getting at it. Till the theory of the action of fluids be established, therefore, we cannot tell what are the forces which are acting on every point of the sail and hull: Therefore we cannot tell either the mean intensity or direction of the whole force which acts on any particular sail, nor the intensity and mean direction of the resistance to the hull; circumstances absolutely necessary for enabling us to say what will be their energy in producing a rotation round any particular axis. In like manner, we cannot, by such a computation, find the spontaneous axis of conversion (see ROTATION), or the velocity of such conversion. In short, we cannot pronounce with tolerable confidence *a priori* what will be the motions in any case, or what dispositions of the sails will produce the movement we wish to perform. The experienced seaman learns by habit the general effects of every disposition of the sails; and though his knowledge is far from being accurate, it seldom leads him into any very blundering operation. Perhaps he seldom makes the best adjustment possible, but seldom will does he deviate very far from it; and in the most general and important problems, such as working to windward, the result of much experience and many corrections has settled a trim of the sails, which is certainly not far from the truth, but (it must be acknowledged) deviates widely and uniformly from the theories of the mathematician's closet. The honest tar, therefore, must be judged in his joke on the useless labours of the mathematician, who can neither hand, reef, nor steer.

After this account of the theoretical performances in the art of seamanship, and what we have said in another place on the small hopes we entertain of seeing a perfect theory of the impulse of fluids, it will not be expected that we enter very minutely on the subject in this place; nor is it our intention. But let it be observed, that the theory is defective in one point only; and although this is a most important point, and the errors in it destroy the conclusions of the chief propositions, the reasonings remain in full force, and the *modus operandi* is precisely such as is stated in the theory. The principles of the art are therefore to be found in these treatises; but false inferences have been drawn, by computing from erroneous quantities. The rules and the practice of the computation, however, are still beyond controversy: Nay, even the process of investigation is legitimate, we may make use of it in order to discover the very circumstance in which we are at present mistaken: by conversing the proposition, instead of finding the motions by means of the supposed forces, combined with the known mechanism, we may discover the forces by means of this method, and be assured of our aim.

We shall therefore, in this place give a very general view of the motions of a ship under sail, showing how they are produced and modified by the action of the wind on her sails, the water on her rudder and on

her bows. We shall not attempt a precise determination of any of these movements; but we shall say enough to enable the curious landman to understand how this mighty machine is managed amidst the fury of the winds and waves: and, what is more to our wish, we hope to enable the uninstructed but thinking seaman to generalise that knowledge which he possesses; to clais his ideas, and give them a sort of rational system; and even to improve his practice, by making him sensible of the immediate operation of every thing he does, and in what manner it contributes to produce the movement which he has in view.

A ship may be considered at present as a mass of inert matter in free space, at liberty to move in every direction, according to the forces which impel or resist her; and when she is in actual motion, in the direction of her course, we may still consider her as at rest in absolute space, but exposed to the impulse of a current of water moving equally fast in the opposite direction: for in both cases the pressure of the water on her bows is the same; and we know that it is possible, and frequently happens in currents, that the impulse of the wind on her sails, and that of the water on her bows, balance each other so precisely, that she not only does not stir from the place, but also remains readily in the same position, with her head directed to the same point of the compass. This state of things is easily conceived by any person accustomed to consider mechanical subjects, and every seaman of experience has observed it. It is of importance to consider it in this point of view, because it gives us the most familiar notion of the manner in which these forces of the wind and water are set in opposition, and made to balance or not to balance each other by the intervention of the ship, in the same manner as the goods and the weights balance each other in the scales by the intervention of a beam or steelyard.

When a ship proceeds steadily in her course, without changing her rate of sailing, or varying the direction of her head, we must in the first place conceive the accumulated impulses of the wind on all her sails as precisely equal and directly opposite to the impulse of the water on her bows. In the next place, because the ship does not change the direction of her keel, she resembles the balanced steelyard, in which the energies of the two weights, which tend to produce rotations in opposite directions, and thus to change the position of the beam, mutually balance each other round the fulcrum; so the energies of the actions of the wind on the different sails balance the energies of the water on the different parts of the hull.

The seaman has two principal tasks to perform. The first is to keep the ship steadily in that course which will bring her farthest on in the line of her intended voyage. This is frequently very different from that line, and the choice of the best course is sometimes a matter of considerable difficulty. It is sometimes possible to keep the course precisely along the line of the voyage; and yet the intelligent seaman knows that he will arrive sooner, or with greater safety, at his port, by taking a different course; because he will gain more by increasing his head than he loses by increasing the distance. Some principle must direct him in the selection of this course. This we must attempt to lay before the reader.

Having chosen such a course as he thinks most advantageous,

9
A ship con- sidered as in free space im- pelled and resisted by opposite forces.

10
Impulse of the wind on the sails opposite to the impulse of the water on the bows.

11
The seaman of- fering his course.

rageous, he must get such a quantity of fill as the strength of the wind will allow him to carry with safety and effect, and must trim the sails properly, or to adjust their positions to the direction of the wind, that they may have the greatest possible tendency to impel the ship in the line of her course, and to keep her steadily in that direction.

His other task is to produce any deviations which be fess proper from the present course of the ship; and to produce these in the most certain, the safest, and the most expeditious manner. It is chiefly in this movement that the mechanical nature of a ship comes into view, and it is here that the superior address and resource of an expert seaman is to be perceived.

Under the article SAILING some notice has been taken of the first task of the seaman, and it was there shown how a ship, after having taken up her anchor and fitted her sails, accelerates her motion, by degrees which continually diminish, till the increasing resistance of the water becomes precisely equal to the diminished impulse of the wind, and then the motion continues uniformly the same so long as the wind continues to blow with the same force and in the same direction.

It is perfectly consonant to experience that the impulse of fluids is in the duplicate ratio of the relative velocity. Let it be supposed that when water moves one foot per second, its perpendicular pressure or impulse on a square foot is m pounds. Then, if it be moving with the velocity V estimated in feet per second, its perpendicular impulse on a surface S , containing any number of square feet, must be mSV^2 .

In like manner, the impulse of air on the same surface may be represented by nSV^2 ; and the proportion of the impulse of these two fluids will be that of m to n . We may express this by the ratio of q to 1, making

$$\frac{m}{n} = q.$$

M. Bouguer's computations and tables are on the supposition that the impulse of sea-water moving one foot per second is 25 ounces on a square foot, and that the impulse of the wind is the same when it blows at the rate of 24 feet per second. These measures are all French. They by no means agree with the experiments of others; and what we have already said, when treating of the *RESISTANCE OF FLUIDS*, is enough to show us that nothing like precise measures can be expected. It was indeed the result of a rational investigation, and confirmed by the experiments of Burt and others, that the impulses and resistances at the same distance, with the same obliquity or incidence and the same velocity of motion, are different according to the form and situation of the adjoining parts. Thus the total resistance of a thin board is greater than that of a long pillar, having this board for its front or bow, &c.

We are sensible at a loss what to give as absolute measures of these resistances.

1. With respect to water. The experiments of the French naval academy, which were repeated by the English and the Americans, have not been so generally attended to as they ought to be, and it is not possible to give a complete description of the method of the French academy.

M. Bouguer's theory of hydrostatics, which he has laid in a French and English language,

A square foot as a thin plate	1,81 pounds.
Diagonals the front of a box one foot long	1,42
Diagonals the front of a box three feet long	1,29
The resistance of sea-water is about	$\frac{1}{2}$ greater.

2. With respect to air, the varieties are as great.—The resistance of a square foot to air moving with the velocity of one foot per second appears from M. Robins's experiments on 16 square inches to be on a square foot

Chevalier Borda's on 16 inches	0,001596 pounds,
on 81 inches	0,001757
Mr. Reule's on large surfaces	0,002242
	0,002291

Precise measures are not to be expected, nor are they necessary in this inquiry. Here we are chiefly interested in their proportions, as they may be varied by their mode of action in the different circumstances of obliquity and velocity.

We begin by recurring to the fundamental proposition concerning the impulse of fluids, viz. that the absolute pressure is always in a direction perpendicular to the impelled surface, whatever may be the direction of the stream of fluid. We must therefore illustrate the doctrine, by always supposing a flat surface of flat breadth l on a yard, which can be fixed about in any direction, and giving this sail first a position and such an extent of surface that the impulse on it may be the same both as to direction and intensity with that on the real sails. Thus the consideration is greatly simplified. The direction of the impulse is therefore perpendicular to the sail. Its intensity depends on the velocity with which the wind meets the sail, and the obliquity of the stroke. We shall adopt the conditions founded on the common doctrine, that the impulse is as the square of the sine of the inclination, because they are simple; whereas, if we were to introduce the values of the oblique resistances, such as they have been observed in the excellent experiments of the Academy of Paris, the conditions would be complicated in the extreme, and we could hardly draw any consequences which would be intelligible to any but expert mathematicians. The conditions will be erroneous, not in kind but in quantity only; and we shall point out the necessary corrections, so that the final results will be found not very different from real observations.

The ship was a small cylindrical body like a hot tub, floating on its bottom, and fitted with a mast and sail in the centre, the wind always fell in a direction perpendicular to the yard. This is evident. But the mast and yard, and any other parts, will be compared to a chisel, whose length only exceeds its breadth. She is so disposed, that a moderate breeze will push her through the water with the head or stem facing it; that is, requires a very great force to push her sideways with the same velocity. A fine sailing ship of war will require about 12 times as much force to push her sideways as to sail head or beam on. In this respect there are the same varieties as in the resistance of a whole length of 12 times its breadth, and which are the proportion of these resistances to the resistance may always substitute a board which will have the same resistances headwise and beamwise.

Let L denote the length of the vessel, and

13
Impulse of
the water
calculated
in ounces
on the
square foot

15
16
17
18
19
20
21
22
23
24
25

11
12
13
14
15

Plate
CC LXXXIX
Fig. 1.

such a box, and AB its middle line, and C its centre. In whatever direction this box may chance to move, the direction of the whole resistance on its two sides will pass through C. For as the whole stream has one inclination to the side EF, the equivalent of the equal impulses on every part will be in a line perpendicular to the middle of EF. For the same reason, it will be in a line perpendicular to the middle of FG. These perpendiculars must cross in C. Suppose a mast erected at C, and YC *y* to be a yard hoisted on it carrying a sail. Let the yard be first conceived as braced right athwart at right angles to the keel, as represented by Y' *y'*. Then, whatever be the direction of the wind about this sail, it will impel the vessel in the direction CB. But if the sail has the oblique position Y *y*, the impulse will be in the direction CD perpendicular to CY, and will both push the vessel ahead and sidewise: For the impulse CD is equivalent to the two impulses CK and CI (the sides of a rectangle of which CD is the diagonal). The force CI pushes the vessel ahead, and CK pushes her sidewise. She must therefore take some intermediate direction *a b*, such that the resistance of the water to the plane FG is to its resistance to the plane EF as CI to CK.

15
Mech. See
way when
not being
directly be-
tore the
wind.

The angle *b* CB between the real course and the direction of the head is called the LEEWAY; and in the course of this dissertation we shall express it by the symbol *x*. It evidently depends on the shape of the vessel and on the position of the yard. An accurate knowledge of the quantity of leeway, corresponding to different circumstances of obliquity of impulse, extent of force, &c. is of the utmost importance in the practice of navigation; and even an approximation is valuable. The subject is so very difficult that this must content us for the present.

16
How to
find the
quantity of
leeway.

Let V be the velocity of the ship in the direction C *b*, and let the surfaces FG and FE be called A' and B'. Then the resistance to the lateral motion is $mV^2 \times B' \times \sin^2 \angle CCB$, and that to the direct motion is $mV^2 \times A' \times \sin^2 \angle bCK$, or $mV^2 \times A' \times \cos^2 \angle CCB$. Therefore these resistances are in the proportion of $B' \times \sin^2 x$ to $A' \times \cos^2 x$ (representing the angle of leeway *b* CB by the symbol *x*).

Therefore we have $CI : CK$, or $CI : ID = A' \times \cos^2 x : B' \times \sin^2 x = A' : B' \frac{\sin^2 x}{\cos^2 x} = A : B \tan^2 x$.

Let the angle YCB, to which the yard is braced us, be called the TRIM of the sails, and expressed by the symbol *b*. This is the complement of the angle DCI. Now $CI : ID = \text{rad.} : \tan. DCI = 1 : \tan. DCI = 1 : \cotan. b$. Therefore we have finally $1 : \cotan. b = A' : B' \tan^2 x$, and $A' \cotan. b = B' \tan^2 x$, and $\tan^2 x = \frac{A}{B} \cot. b$. This equation evidently ascertains the mutual relation between the trim of the sails and the leeway in every case where we can tell the proportion between the resistances to the direct and braced motions of the ship, and where this proportion does not change by the obliquity of the course. Thus, suppose the yard braced us to an angle of 35° with the keel. Then $\cotan. 35^\circ = 1,732$ very nearly. Suppose also that the resistance sidewise is 12 times greater than the resistance headwise. This gives

$A' = 1$ and $B' = 12$. Therefore $1,732 = 12 \times \tan^2 x$, and $\tan^2 x = \frac{1,732}{12} = 0,14434$, and $\tan. x = 0,3799$, and $x = 20^\circ 46'$, very nearly two points of leeway.

This computation, or rather the equation which gives room for it, supposes the resistances proportional to the squares of the sines of incidence. The experiments of the Academy of Paris, of which an abstract is given in the article *RESISTANCE of Fluids*, show that this supposition is not far from the truth when the angle of incidence is great. In the present case the angle of incidence on the front FG is about 70° , and the experiments just now mentioned show that the real resistances exceed the theoretical ones only $\frac{1}{30}$. But the angle of incidence on EF is only $20^\circ 48'$. Experiment shows that in this inclination the resistance is almost quadruple of the theoretical resistances. Therefore the lateral resistance is assumed much too small in the present instance. Therefore a much smaller leeway will suffice for producing a lateral resistance which will balance the lateral impulse CK, arising from the obliquity of the sail, viz. 30° . The matter of fact is, that a pretty good sailing ship, with her sails braced to this angle at a medium, will not make above five or six degrees leeway in smooth water and easy weather; and yet in this situation the hull and rigging present a very great surface to the wind, in the most improper positions, so as to have a very great effect in increasing her leeway. And if we compute the resistances for this leeway of six degrees by the actual experiments of the French Academy on the angle, we shall find the result not far from the truth; that is, the direct and lateral resistances will be nearly in the proportion of CI to ID.

It results from this view of the matter, that the leeway is in general much smaller than what the usual theory assigns.

We also see, that according to whatever law the resistances change by a change of inclination, the leeway remains the same while the trim of the sails is the same. The leeway depends only on the direction of the impulse of the wind; and this depends solely on the position of the sails with respect to the keel, whatever may be the direction of the wind. This is a very important observation, and will be frequently referred to in the progress of the present investigation. Note, however, that we are here considering only the action on the sails, and on the same fails. We are not considering the action of the wind on the hull and rigging. This may be very considerable; and it is always in a lee direction, and augments the leeway; and its influence must be so much the more sensible as it bears a greater proportion to the impulse on the sails. A ship under courses, or close-reefed, topsails and courses, must make more leeway than when under all her canvas trimmed, to the same angle. But to introduce this additional cause of deviation here would render the investigation too complicated to be of any use.

This doctrine will be considerably illustrated by attending to the manner in which a lighter is tracked a canal, or fixings to its anchor in a stream. The track rope is made fast to some fluke or bolt E on the deck (Fig. 2.), and is passed between two of the timbers of the bow D, and laid bold of at F on the heads of the bow D, and laid bold of at F on the deck. The men or cattle walk along the path FG, the rope keeps

17

the re-
depends on
the trim of
the sails.

18

Illustration
of the de-
scribed
method
of track-
ing.

Fig. 2.

keeps

keeps extended in the directions DF, and the lighter arranges itself in an oblique position AB, and is thus dragged along in the direction *ab*, parallel to the side of the canal. Or, if the canal has a current in the opposite direction *ba*, the lighter may be kept steady in its place by the rope DF made fast to a post at F. In this case, it is always observed, that the lighter swims in a position AB, which is oblique to the stream *ab*. Now the force which retains it in this position, and which precisely balances the action of the stream, is certainly exerted in the direction DF; and the lighter would be held in the same manner if the rope were made fast at C amidship, without any dependence on the timberheads at D; and it would be held in the same position, if, instead of the single rope CF, it were riding by two ropes CG and CH, of which CH is in a direction right ahead, but oblique to the stream, and the other CG is perpendicular to CH or AB. And, drawing DI and DK perpendicular to AB and CG, the strain on the rope CH is to that on the rope CG as CI to CK. The action of the rope in these cases is precisely analogous to that of the sail *y Y*; and the obliquity of the keel to the direction of the motion, and to the direction of the stream, is analogous to the leeway. All this must be evident to any person accustomed to mechanical disquisitions.

19
On models
and

A most important use may be made of this illustration. If an accurate model be made of a ship, and if it be placed in a stream of water, and ridden in this manner by a rope made fast at any point D of the bow, it will arrange itself in some determined position AB. There will be a certain obliquity to the stream, measured by the angle *Bob*; and there will be a corresponding obliquity of the rope, measured by the angle *FCB*. Let *y CY* be perpendicular to CF. Then *CY* will be the position of the yard, or trim of the sails corresponding to the leeway *b CB*. Then, if we lift the rope to a point of the bow distant from D by a small quantity, we shall obtain a new position of the ship, both with respect to the stream and rope; and in this way may be obtained the relation between the position of the sails and the leeway, independent of all theory, and susceptible of great accuracy; and this may be done with a variety of models suited to the most usual forms of ships.

20
on figs.
fig. 3.

In farther thinking on this subject, we are persuaded that these experiments, instead of being made on models, may with equal ease be made on a ship of any size. Let the ship ride in a stream at a mooring D (fig. 3.) by means of a short hawser BCD from her bow, having a spring AC on it carried out from her quarter. She will swing to her moorings, till she ranges herself in a certain position AB with respect to the direction *ab* of the stream; and the direction of the hawser DC will point to some point E of the line of the keel. Now, it is plain to any person acquainted with mechanical disquisitions, that the deviation *BEb* is precisely the leeway that the ship will make when the average position of the sails is that of the line *GEH* perpendicular to ED; and let it this will give the leeway which is produced by the sails. Hence, by heaving on the spring, the knot C may be brought into any other position we please; and for every new position of the knot the ship will take a new position with respect to the stream and to the haw-

ser. And we profit in saying, that more information will be got by this train of experiments than from any mathematical theory; for all the theories of the impulses of fluids must proceed on physical suppositions with respect to the motions of the filaments, which are exceedingly conjectural.

And it must now be farther observed, that the substitution which we have made of an oblong parallelopiped for a ship, although well suited to give us clear notions of the subject, is of small use in practice: for it is next to impossible (even granting the theory of oblique impulses) to make this substitution. A ship is of a form which is not reducible to equations; and therefore the action of the water on her bow or broadside can only be had by a most laborious and intricate calculation for almost every square foot of its surface. (See *Bezout's Cours de Mathem.* vol. v. p. 72, &c.) And this must be different for every ship. But, which is more unlucky, when we have got a parallelopiped which will have the same proportion of direct and lateral resistance for a particular angle of leeway, it will not answer for another leeway of the same ship; for when the leeway changes, the figure actually exposed to the action of the water changes also. When the leeway is increased, more of the lee-quarter is acted on by the water, and a part of the weather-bow is now removed from its action. Another parallelopiped must therefore be discovered, whose resistance shall suit this new position of the keel with respect to the real course of the ship.

We therefore beg leave to recommend this train of experiments to the notice of the ASSOCIATION FOR THE IMPROVEMENT OF NAVAL ARCHITECTURE as a very promising method for ascertaining this important point. And we proceed, in the next place, to ascertain the relation between the velocity of the ship and that of the wind, modified as they may be by the trim of the sails and the obliquity of the impulse.

Let AB (figs. 4, 5, and 6.) represent the horizontal section of a ship. In place of all the drawing sails, that is, the sails which are really filled, we can always substitute one sail of equal extent, trimmed to the same angle with the keel. This being supposed attached to the yard DCD, let this yard be first of all at right angles to the keel, as represented in fig. 4. Let the wind blow in the direction WC, and let CE (in the direction WC continued) represent the velocity V of the wind. Let CF be the velocity *v* of the ship. It must also be in the direction of the ship's motion, because when the sail is at right angles to the keel, the absolute impulse on the sail is in the direction of the keel, and there is no lateral impulse, and consequently no leeway. Draw EF, and complete the parallelogram CFEe, producing eC through the centre of the yard to e. Then *eC* will be the relative or apparent direction of the wind, and *Ce* or *FE* will be its apparent or relative velocity: For if the line *Ce* be carried along CF, keeping always parallel to its first position, and if a particle of air move uniformly along CE (a fixed line in absolute space) in the same time, this particle will always be found in that point *e* of *CE* where it is intersected at that instant by the moving line *Ce*; so that if *Ce* were a tube, the particle of air, which really moves in the line *CE*, would always be found in the tube *Ce*. While *CE* is the real direction of the wind, *Ce* will be the position of the

the wind is blowing from the north, mark the true direction of the ship, or its motion relative to the wind.

We may now consider this in another way. Suppose a current to be in the direction CL , the ship's drift, CP , and the wind's drift, CE , the angle P will be the velocity of the wind. If P is not far from the outside of the ship at P , in the line CE ; for while the ship moves from C to P , the point P has gone forward, and the point p is now in the place where P was when the ship passed through the point p . The ship will therefore pass through the ship's face in the point p , and a person on board feeling it pass the ship, C and p will say that its motion was in the line Cp .

This it happens, that when a ship is in motion the apparent direction of the wind is always ahead of its real direction. The line re C is always found within the angle WCB . It is easy to see from the construction, that the difference between the real and apparent directions of the wind is to much the more remarkable as the velocity of the ship is greater; For the angle WCe or ECe depends on the magnitude of EC or CE , in proportion to CL . Persons not much accustomed to attend to these matters are apt to think all attend to this difference, to be owing but to a fashion of nicety. They have no notion that the velocity of a ship can have any sensible proportion to that of the wind. "Swift as the wind" is a poetical expression; yet the velocity of a ship always bears a very sensible proportion to that of the wind, and even very frequently exceeds it. We may form a pretty exact notion of the velocity of the wind by observing the shadows of the summer clouds lying along the face of a country, and it may be very accurately done by this method. The motion of such clouds cannot be very different from that of the air below; and when the pressure of the wind can be felt, will blowing, with a velocity measured in this way, is compared with its pressure when its velocity is measured by more unexceptionable means, they are found to agree with all degrees of accuracy. Now observations of this kind frequently reveal, first, that what we call a pleasant brisk gale blows at the rate of about 10 miles an hour, or about 17 feet in a second, and exerts a pressure of half a pound on a square foot. Mr Smeaton has frequently observed the tails of a windmill, driven by such a wind, moving faster, or much faster, towards their extremities, so that the sails, instead of being pressed to the masts on the mizes, was taken aback, and flattered in them. Now, we know that a good ship, with her sails set and the wind on the beam, will in such a gale run sail above ten knots an hour in smooth water. There is an observation made by every experienced seaman, who knows this difference between the real and apparent directions of the wind very distinctly. When the ship is falling aback, with the wind on the beam, the sails shoot, and then falls equally well on the other side, the wind thus appears to have shifted and come from ahead. This is familiar to all seamen. The false direction of the direction of the wind by the position of the ship's vane. Suppose the direction of the wind on the beam and tack, with the wind apparent N. N. W. the vane pointing S. S. E. If the ship put about, and stands due east on the starboard tack, the vane will be found to point S. S. E. but perhaps S. S. W. the

wind's real direction N. N. E. and the ship must be nearly eddied round, or come on an aback course. The wind appears to have shifted four points. If the ship rocks a little, the vane returns to its old quarter. We have often observed a greater difference than this. The celebrated astronomer, Dr Bradley, taking the amusement of sailing in a pleasure on the river Thames, observed this, and was inspired at it, imagining that the change of wind was owing to the approaching to or retiring from the shore. The boatman told him that it always happened at sea, and explained it to him in the best manner they were able. The explanation struck him, and let him a mull, on an astronomical phenomenon which he had been puzzled by for some years, and which he called THE ABBERRATION OF THE FIXED STARS. Every star changes its place a small matter for half a year, and returns to it at the completion of the year. He compared the stream of light from the star to the wind, and the telescope of the astronomer to the ship's vane, while the earth was like the ship, moving in opposite directions when in the opposite points of its orbit. The telescope must always be pointed ahead of the real direction of the star, in the same manner as the vane is always in a direction ahead of the wind; and thus he ascertained the progressive motion of light, and discovered the proportion of its velocity to the velocity of the earth in its orbit, by observing the deviation which was necessarily given to the telescope. Observing that the light tilted its direction about $4\frac{1}{2}^{\circ}$, he concluded its velocity to be about 11,000 times greater than that of the earth; just as the intelligent team would conclude from this system, drifting of the wind, that the velocity of the wind is about triple that of the ship. This is indeed the best method for ascertaining the velocity of the wind. Let the direction of the vane at the mast-head be very accurately noticed on both tacks, and let the velocity of the ship be also accurately measured. The angle between the directions of the ship's head on these different tacks being halved, will give the real direction of the wind, which must be compared with the position of the vane in order to determine the angle contained between the real and apparent directions of the wind or the angle ECe ; or half of the observed tilting of the wind will show the inclination of its true and apparent directions. This being found, the proportion of EC to CE (fig. 6.) is easily measured.

We have been very particular on this point, because since the mutual actions of bodies depend on their relative motions only, we should make no religious mistakes if we estimated the action of the wind by its real direction and velocity, when they differ so much from the relative or apparent.

We now resume the investigation of the velocity of the ship (fig. 4.), having its sails at right angles to the wind's keel, and the wind blowing in the direction re with the velocity CE , while the ship proceeds in the direction of the keel with the velocity CP . Produce EC , and draw FG perpendicular to EC , till it meet the yard in G , and the angle WCD , contained between the sail and the real direction of the wind, put a for the angle of trim DCB . CE the velocity of the wind was expressed by V , and CP the velocity of the ship by v .

The velocity of the ship is then the final

24
Of the
in a Dr
of this on
this subjct.

W. P. A.
1811
1812
1813
1814
1815
1816
1817
1818
1819
1820
1821
1822
1823
1824
1825
1826
1827
1828
1829
1830
1831
1832
1833
1834
1835
1836
1837
1838
1839
1840
1841
1842
1843
1844
1845
1846
1847
1848
1849
1850
1851
1852
1853
1854
1855
1856
1857
1858
1859
1860
1861
1862
1863
1864
1865
1866
1867
1868
1869
1870
1871
1872
1873
1874
1875
1876
1877
1878
1879
1880
1881
1882
1883
1884
1885
1886
1887
1888
1889
1890
1891
1892
1893
1894
1895
1896
1897
1898
1899
1900

25
Velocity of
the ship
with
at
the
to

theory) proportional to the square of the relative velocity, and to the square of the sine of the angle of incidence; that is, to $FE \times \sin^2 \alpha \approx CD$. Now the angle $GFE = \alpha$, and EG is equal to $FE \times \sin \alpha$. GFE and EG is equal to $Eg = G$. But $Eg = EC \times \sin \alpha$. $EC \times \sin \alpha = V \times \sin \alpha$. $a = v$. Therefore $EG = V \times \sin \alpha = v$. and the impulse is proportional to $V \times \sin \alpha \cdot a = v^2$. If S represent the surface of the sail, the impulse, in pounds, will be $nS \sqrt{V \times \sin \alpha} \cdot a = v^2$.

Let A be the surface which, when it meets the water perpendicularly with the velocity v , will sustain the same pressure or resistance which the bows of the ship actually meets with. This impulse, in pounds, will be $m A v^2$. Therefore, because we are considering the ship's motion as in a state of uniformity, the two pressures balance each other; and therefore $m A v^2 = n S (V \times \sin \alpha \cdot a - v)^2$, and $\frac{m}{n} A v^2 = S (V \times \sin \alpha \cdot a - v)^2$;

$$\text{therefore } \sqrt{\frac{m}{n}} \sqrt{A} \times v = \sqrt{S} \times V \times \sin \alpha \cdot a - v \sqrt{S}, \text{ and}$$

$$v = \frac{\sqrt{S} \times v \times \sin \alpha \cdot a - V \times \sin \alpha \cdot a}{\sqrt{\frac{m}{n} A + S}} = \frac{V \times \sin \alpha \cdot a}{\sqrt{\frac{m}{n} A + S} + 1}.$$

We see, in the first place, that the velocity of the ship is (*ceteris paribus*) proportional to the velocity of the wind, and to the sine of its incidence on the sail jointly; for while the surface of the sail S and the equivalent surface for the bow remains the same, v increases or diminishes at the same rate with $V \times \sin \alpha$. When the wind is right ahead, the sine of α is unity,

$$\text{and then the ship's velocity is } \frac{V}{\sqrt{\frac{m}{n} S} + 1}.$$

Note, that the denominator of this fraction is a common number; for m and n are numbers, and A and S being quantities of one kind, $\frac{A}{S}$ is also a number.

It must also be carefully attended to, that S expresses a quantity of sail actually receiving wind with the inclination α . It will not always be true, therefore, that the velocity will increase as the wind is more abaft, because some sails will then become others. This observation is not, however, of great importance; for it is very unsafe to put a ship in the situation considered hitherto; that is, with the yards square, unless she be right before the wind.

If we would discover the relation between the velocity and the quantity of fail in this simple case of the wind right aft, observe that the equation $v = \frac{V}{\sqrt{\frac{m}{n} S} + 1}$,

gives us $\sqrt{\frac{m}{n} S} v + v = V$, and $\sqrt{\frac{m}{n} S} v = V - v$, and $\frac{m}{n} S v^2 = V^2 - v^2$, and $\frac{n S}{m A} = \frac{v^2}{(V - v)^2}$; and because n and m and A are constant quantities, S is proportional to $\frac{v^2}{(V - v)^2}$, or the surface of fail is proportional to the square of the ship's velocity directly, and to the square of the relative velocity inversely. Thus, if a ship

be sailing with one-eighth of the velocity of the wind, and we would have her sail with one-fourth of it, we must quadruple the fail. This is more easily seen in another way. The velocity of the ship is proportional to the velocity of the wind; and therefore the relative velocity is also proportional to that of the wind, and the impulse of the wind is as the square of the relative velocity. Therefore, in order to increase the relative velocity by an increase of fail only, we must make this increase of fail in the duplicate proportion of the increase of velocity.

Let us, in the next place, consider the motion of a ship whose sails stand oblique to the keel.

The construction for this purpose differs a little from the former, because, when the sails are trimmed to any oblique position DCB (fig. 5, and 6), there must be an deviation from the direction of the keel, or a leeway to $BC b$. Call this x . Let CF be the velocity of the ship. Draw, as before, Eg perpendicular to the yard, and FG perpendicular to the yard; as before, EG , which is in the subduplicate ratio of the impulse on the sail, is equal to $Eg = Gg$. Now Eg is, as before, $= V \times \sin \alpha$, and Gg is equal to FH , which is $= CF \times \sin \alpha$, or $= v \times \sin \alpha$. Therefore we have the impulse $= n S (V \times \sin \alpha - v \times \sin \alpha \cdot b + x)^2$.

This expression of the impulse is perfectly similar to that in the former case, its only difference consisting in the subduplicate part, which is here $v \times \sin \alpha \cdot b + x$ instead of v . But it expresses the same thing as before, viz. the diminution of the impulse. The impulse being reckoned solely in the direction perpendicular to the sail, it is diminished solely by the fail withdrawing itself *in that direction* from the wind; and as $g E$ may be considered as the real impulsive motion of the wind, GE must be considered as the relative and effective impulsive motion. The impulse would have been the same had the ship been at rest, and had the wind met it perpendicularly with the velocity GE .

We must now show the connection between this impulse and the motion of the ship. The fail, and consequently the ship, is pressed by the wind in the direction CI perpendicular to the sail or yard with the force which we have just now determined. This (in the state of uniform motion) must be equal and opposite to the action of the water. Draw IL at right angles to the keel. The impulse in the direction CI (which we may measure by CI) is equivalent to the impulses CL and LI . By the first the ship is impelled right forward, and by the second she is driven sidewise. Therefore we must have a leeway, and a lateral as well as a direct resistance. We suppose the form of the ship to be known, and therefore the proportion is known, or discoverable, between the direct and lateral resistances corresponding to every angle x of leeway. Let A be the surface whose perpendicular resistance is equal to the direct resistance of the ship corresponding to the leeway x , that is, whose resistance is equal to the resistance really felt by the ship's bows in the direction of the keel when she is sailing with this leeway; and let B in like manner be the surface whose perpendicular resistance is equal to the actual resistance to the ship's motion in the direction LI , perpendicular to the keel. ($N. B.$ This is not equivalent to A and B adapted to the rectangular box, but to $A' \cdot \cos^2 x$ and $B' \cdot \sin^2 x$.) We have therefore

therefore $A : B = CL : LI$, and $LI = \frac{CL \cdot B}{A}$. Also,

because $CI = \sqrt{CL^2 + LI^2}$, we have $A : \sqrt{A^2 + B^2} = CL : CI$, and $CI = \frac{CL \sqrt{A^2 + B^2}}{A}$. The resistance in

the direction LC is properly measured by $m \cdot A \cdot v^2$, as has been already observed. Therefore the resistance in the direction IC must be expressed by $m \sqrt{A^2 + B^2} v^2$; or (making C the surface which is equal to $\sqrt{A^2 + B^2}$), and which will therefore have the same perpendicular resistance to the water having the velocity v it may be expressed by $m \cdot C \cdot v^2$.

Therefore, because there is an equilibrium between the impulse and resistance, we have $m \cdot C \cdot v^2 = n \cdot S \cdot (V \cdot \sin. a - v \cdot \sin. \overline{b+x})^2$ and $\frac{m}{n} \cdot C \cdot v^2$, or $q \cdot C \cdot v^2 = S \cdot (V \cdot \sin. a - v \cdot \sin. \overline{b+x})^2$, and $\sqrt{q \cdot C} \cdot v = \sqrt{S} \cdot (V \cdot \sin. a - v \cdot \sin. \overline{b+x})$.

Therefore $v = \frac{\sqrt{S \cdot V \cdot \sin. a}}{\sqrt{q \cdot C} + \sqrt{S} \cdot \sin. \overline{b+x}}$, $= \frac{V \cdot \sin. a}{\sqrt{q \cdot C} + \sqrt{S} \cdot \sin. \overline{b+x}} = V \cdot \frac{\sin. a}{\sqrt{q \cdot C} + \sqrt{S} \cdot \sin. \overline{b+x}}$.

Observe that the quantity which is the coefficient of V in this equation is a common number; for $\sin. a$ is a number, being a decimal fraction of the radius 1, $\sin. \overline{b+x}$ is also a number, for the same reason. And since m and n were numbers of pounds, $\frac{m}{n}$ or q is a common number. And because C and S are surfaces, or quantities of one kind, $\frac{C}{S}$ is also a common number.

This is the simplest expression that we can think of for the velocity acquired by the ship, though it must be acknowledged to be too complex to be of very prompt use. Its complication arises from the necessity of introducing the leeway x . This affects the whole of the denominator; for the surface C depends on it, because C is $\sqrt{A^2 + B^2}$, and A and B are analogous to $A' \cdot \cos. x$ and $B' \cdot \sin. x$.

But we can deduce some important consequences from this theorem.

While the surface S of the sail actually filled by the wind remains the same, and the angle DCB , which in future we shall call the *TRIM* of the sails, also remains the same, both the leeway x and the substituted surface C remain the same. The denominator is therefore constant; and the velocity of the ship is proportional to $\sqrt{S} \cdot V \cdot \sin. a$; that is, directly as the velocity of the wind, directly as the absolute inclination of the wind to the yard, and directly as the square root of the surface of the sails.

We also learn from the construction of the figure that FG parallel to the yard cuts CE in a given ratio. For CF is in a constant ratio to Eg , as has been just now demonstrated. And the angle DCF is constant. Therefore $CF \cdot \sin. b$, or FH or Gg , is proportional to Eg , and OC to EC , or EC is cut in one proportion, what

ever may be the angle ECD , so long as the angle DCF is constant.

We also see that it is very possible for the velocity of the ship on an oblique course to exceed that of the wind. This will be the case when the number

$\frac{\sin. a}{\sqrt{q \cdot C} + \sin. \overline{b+x}}$ exceeds unity, or when $\sin. a$ is greater than $\sqrt{q \cdot C} + \sin. \overline{b+x}$. Now this may easily

be by sufficiently enlarging S and diminishing $b+x$. It is indeed frequently seen in fine sailers with all their sails set and not hauled too near the wind.

We remarked above that the angle of leeway x affects the whole denominator of the fraction which expresses the velocity. Let it be observed that the angle ICL is the complement of ICD , or of b . Therefore, $CL : LI$, or $A : B = 1 : \tan. ICL = 1 : \cot. b$, and $B = A \cdot \cotan. b$. Now A is equivalent to $A' \cdot \cos. x$, and thus b becomes a function of x . C is evidently so, being $\sqrt{A^2 + B^2}$. Therefore before the value of this fraction can be obtained, we must be able to compute, by our knowledge of the form of the ship, the value of A for every angle x of leeway. This can be done only by resolving her bows into a great number of elementary planes, and computing the impulses on each and adding them into one sum. The computation is of immense labour, as may be seen by one example given by Bouguer. When the leeway is but small, not exceeding ten degrees, the substitution of the rectangular prism of one determined form is abundantly exact for all leeways contained within this limit, and we shall soon see reason for being contented with this approximation. We may now make use of the formula expressing the velocity for solving the chief problems in this part of the seaman's task.

And first let it be required to determine the best position of the sail for standing on a given course ab , when to determine the direction and velocity of the wind, and its angle with the course WCF , are given. This problem has exercised the talents of the mathematicians ever since the days of Newton. In the article PNEUMATICS we gave the solution of one very nearly related to it, namely, to determine the position of the sail which would produce the greatest impulse in the direction of the course. The solution was to place the yard CD in such a position that the tangent of the angle FCD may be one half of the tangent of the angle DCW . This will indeed be the best position of the sail for beginning the motion; but as soon as the ship begins to move in the direction CF , the effective impulse of the wind is diminished, and also its inclination to the sail. The angle DCW diminishes continually as the ship accelerates; for CF is now accompanied by its equal CE , and by an angle ECF or WCW . CF increases, and the impulse on the sail diminishes, till an equilibrium obtains between the resistance of the water and the impulse of the wind. The impulse is now measured by $CE^2 \times \sin. a \cdot CD$ instead of $CE^2 \times \sin. a \cdot ECD$, that is, by EG^2 instead of Eg^2 .

This introduction of the relative motion of the wind renders the actual solution of the problem extremely difficult.

23
Exp. tract
consequences
deduced
from
the
propn.
there.

29
Problem I.
To deter-
CE the direction
and velocity of
the wind, and its
angle with the
course ab , when
to determine the
direction and
velocity of the
wind, and its
angle with the
course are
given.

Problem II. It is very easily expressed geometrically: Divide the angle $\angle WCF$ in such a manner that the tangent of DCF may be half of the tangent of DCW, and the problem may be constructed geometrically as follows.

Fig. 7. Let $\angle WCF$ (fig. 7.) be the angle between the fall and course. Round the centre C describe the circle $WDFY$; produce WC to Q , so that $CQ=4WC$, and draw QY parallel to CF cutting the circle in Y ; bisect the arch WY in D , and draw DC . DC is the proper position of the yard.

Draw the chord WY , cutting CD in V and CF in T ; draw the tangent PD cutting CF in S and CY in R .

It is evident that WY , PR , are both perpendicular to CD , and are bisected in V and D ; therefore (by reason of the parallels QY , CF) $1:3::QV:CV$, $=YW:TW::RP:SP$. Therefore $PD:PS=1:3$, and $PD:DS=1:1$. $\therefore E. D$. But this division cannot be made to the best advantage till the ship has attained its greatest velocity, and the angle $\angle WCF$ has been produced.

We must consider all the three angles, a , b , and x , as variable in the equation which expresses the value of v , and we must make the fluxion of this equation $=0$; then, by means of the equation $B=A \cotan. b$, we must obtain the value of b and of \dot{b} in terms of x and \dot{x} . With respect to a , observe, that if we make the angle $\angle WCF=\rho$, we have $\rho=a+b+x$; and ρ being a constant quantity, we have $\dot{a}+\dot{b}+\dot{x}=0$. Substituting for a , b , \dot{a} , \dot{b} , their values in terms of x and \dot{x} , in the fluxionary equation $=0$, we readily obtain x , and then a and b , which solves the problem.

Let it be required, in the next place, to determine the course and the trim of the sails most proper for plying to windward.

In fig. 6, draw FP perpendicular to WC . CF is the motion of the ship; but it is only by the motion PC that she gains to windward. Now CP is $=CF \times \cosin. WCF$, or $v \times \cosin. (a+b+x)$. This must be rendered a maximum, as follows.

By means of the equation which expresses the value of v and the equation $B=A \cotan. b$, we exterminate the quantities v and b ; we then take the fluxion of the quantity into which the expression $v \times \cosin. (a+b+x)$ is changed by this operation. Making this fluxion $=0$, we get the equation which must solve the problem. This equation will contain the two variable quantities a and x with their fluxions; then make the coefficient of \dot{x} equal to 0, also the coefficient of \dot{a} equal to 0. This will give two equations which will determine a and x , and from this we get $b=\rho-a-x$.

Should it be required, in the third place, to find the best course and trim of the sails for getting away from a given line of coast CM (fig. 6.), the process perfectly resembles this last, which is in fact getting away from a line of coast which makes a right angle with the wind. Therefore, in place of the angle $\angle WCF$, we must substitute the angle $\angle WCM=\angle WCF$. Call this angle e . We must make $v \times \cosin. (e+a+b+x)$ a maximum. The analytical process is the same as the former, only e is here a constant quantity.

These are the three principal problems which can be solved by means of the knowledge that we have obtain-

ed of the motion of the ship when impelled by an oblique fall, and therefore making leeway; and they may be considered as an abstract of this part of M. Bouguer's work. We have only pointed out the process for this solution, and have even omitted some things taken notice of by M. Bezout in his very elegant compendium. Our reason will appear as we go on. The learned reader will readily see the extreme difficulty of the subject, and the immense calculations which are necessary even in the simplest cases, and will grant that it is out of the power of any but an expert analyst to divide any use from them; but the mathematician can calculate tables for the use of the practical seaman. Thus he can calculate the best position of the sails for advancing in a course 90° from the wind, and the velocity in that course; then for 85° , 80° , 75° , &c. M. Bouguer has given a table of this kind; but to avoid the immense difficulty of the process, he has adapted it to the apparent direction of the wind. We have inserted a few of his numbers, suited to such cases as can be of service, namely, the case when all the sails draw, or none stand in the way of the others. Column 1d is the apparent angle of the wind and course; column 2d is the corresponding angle of the sails and keel; and column 3d is the apparent angle of the sails and wind.

\angle DCB	\angle DCB	\angle CD
$125^\circ 55'$	$42^\circ 37'$	$61^\circ 23'$
$99 13$	$47 -$	$59 13$
$94 25$	$37 30$	$56 55$
$89 28$	$35 -$	$54 28$
$84 23$	$32 30$	$51 53$
$79 06$	$30 -$	$49 06$
$73 39$	$27 30$	$46 39$
$68 -$	$25 -$	$43 -$

In all these numbers we have the tangent of \angle CD double of the tangent of DCF.

But this is really doing but little for the seaman. The apparent direction of the wind is unknown to him till the ship is sailing with uniform velocity; and he is still uninform'd as to the leeway. It is, however, of service to him to know, for instance, that when the angle of the vanes and yards is 36 degrees, the yard should be braced up to $35^\circ 30'$, &c.

But here occurs a new difficulty. By the construction of a square-rigged ship it is impossible to give the yards that inclination to the keel which the calculation requires. Few ships can have their yards braced up to $35^\circ 30'$; and yet this is required in order to have an incidence of 36° , and to hold a course $94^\circ 25'$ from the apparent direction of the wind, that is, with the keel apparently $4^\circ 25'$ abaft the beam. A good sailing ship in this position may acquire a velocity even exceeding that of the wind. Let us suppose it only one half of the velocity. We shall find that the angle $\angle WCF$ is in this case about 29° , and the ship is nearly going 125° from the wind, with the wind almost perpendicular to the fall; therefore this utmost bracing up of the sails is only giving them the position suited to a wind broad on the quarter. It is impossible therefore to comply with the demand of the mathematician, and the seaman must be contented to employ a less favourable disposition of his sails in all cases where this course does not lie at least eleven points from the wind.

Let us see whether this reflection, arising from necessity, leaves anything in our choice, and makes one course preferable to another. We see that there are a prodigious number of courses, and that the most usual and the most important, which we must hold with one trim of the sails; in particular, sailing with the wind on the beam, and all cases of plying to windward, must be performed with this unfavourable trim of the sails. We are certain that the smaller we make the angle of incidence, real or apparent, the smaller will be the velocity of the ship; but it may happen that we shall gain more to windward, or get looser away from a lee-coast, or any object of danger, by sailing slowly on one course than by sailing quickly on another.

We have seen that while the trim of the sails remains the same, the leeway and the angle of the yard and course remains the same, and that the velocity of the ship is as the sine of the angle of real incidence, that is, as the sine of the angle of the sail and the real direction of the wind.

Fig. 5. Let the ship AB (fig. 5.) hold the course CF, with the wind blowing in the direction WC, and having her yards DCD braced up to the smallest angle BCD which the rigging can admit. Let CF be to CE as the velocity of the ship to the velocity of the wind; join FE and draw CE parallel to EF; it is evident that FE is the relative motion of the wind, and EC is the relative incidence on the sail. Draw FO parallel to the yard DC, and describe a circle through the points CFO; then we say that if the ship, with the same wind and the same trim of the same drawing sails, be made to sail on any other course Cf, her velocity along CF is to the velocity along Cf as CF is to Cf; or, in other words, the ship will employ the same time in going from C to any point of the circumference CFO.

Join FO. Then, because the angles CFO, CFO are on the same chord CO, they are equal, and FO is parallel to CA, the new position of the yard corresponding to the new position of the keel ab, making the angle ACD = DCB. Also, by the nature of the circle, the line CF is to Cf as the sine of the angle CFO to the sine of the angle COF, that is (on account of the parallels CD, OF and CA, OF), as the sine of WCD to the sine of WCD. But when the trim of the sails remains the same, the velocity of the ship is as the sine of the angle of the sail with the direction of the wind; therefore CF is to Cf as the velocity on CF to that on Cf, and the proposition is demonstrated.

55
To determine the best course for avoiding a rock.

Let it now be required to determine the best course for avoiding a rock R lying in the direction CR, or for withdrawing as fast as possible from a line of coast PQ. Draw CAI through R, or parallel to PQ, and let m be the middle of the arch C m M. It is plain that m is the most remote from CM of any point of the arch C m M, and therefore the ship will recede farther from the coast PQ in any given time by holding the course C m than by any other course.

This course is easily determined; for the arch C m M = 360° - (arch CO + arch OM), and the arch CO is the measure of twice the angle CFO, or twice the angle DCB, or twice $\frac{b}{2} + x$, and the arch OM measures twice the angle ECM.

Thus, suppose the sharpest possible trim of the sails to be 35°, and the observed angle ECM to be 75°; then CO + OM = 75° + 140° = 215°. This being ta-

ken from 360°, leaves 145°, of which the half M m is 72½°, and the angle MC m is 37° 30'. This added to ECM makes EC m 112° 30', leaving WC m = 72° 30', and the ship must hold a course making an angle of 72° 30' with the real direction of the wind, and WCD will be 37° 30'.

This supposes no leeway. But if we know that under all the sail which the ship can carry with safety and advantage she makes 5 degrees of leeway, the angle ECM of the sail and course, or $b + x$, is 45°. Then CO + OM = 225°, which being taken from 360° leaves 135°, of which the half is 67½° = M m, and the angle MC m = 35°, and EC m = 105°, and WC m = 75°, and the ship must lie with her head 75° from the wind, making 5 degrees of leeway, and the angle WCD is 35°.

The general rule for the position of the ship is, that the line on shipboard which bisects the angle $b + x$ may always bisect the angle WCM, or make the angle between the course and the line from which we wish to withdraw equal to the angle between the sail and the real direction of the wind.

It is plain that this problem includes that of plying to windward. We have only to suppose ECM to be 92°, then, taking our example in the same ship, with the same trim and the same leeway, we have $b + x = 45°$. This taken from 92° leaves 50° and WC m = 92 - 25 = 65, and the ship's head must lie 65° from the wind, and the yard must be 25° from it.

It must be observed here, that it is not always eligible to select the course which will remove the ship fastest from the given line CM; it may be more prudent to remove from it more securely though more slowly. In such cases the procedure is very simple, viz. to shape the course as near the wind as is possible.

The reader will also easily see that the propriety of these practices is confined to those courses only where the practicable trim of the sails is not sufficiently sharp. Whenever the course lies so far from the wind that it is possible to make the tangent of the apparent angle of the wind and sail double the tangent of the sail and course, it should be done.

These are the chief practical consequences which can be deduced from the theory. But we should consider how far this adjustment of the sails and course can be performed. And here occur difficulties so great as to make it almost impracticable. We have always supposed the position of the surface of the sail to be distinctly observable and measurable; but this can hardly be affirmed even with respect to a sail stretched on a yard. Here we supposed the surface of the sail to have the same inclination to the keel that the yard has. This is by no means the case; the sail assumes a concave form, of which it is almost impossible to assign the direction of the mean impulse. We believe that this is always considerably to leeward of a perpendicular to the yard, lying between CI and CE (fig. 6.). This is of some advantage, being equivalent to a sharper trim. We cannot affirm this, however, with any confidence, because it renders the impulse on the weather-leech of the sail far exceedingly feeble as hardly to have any effect. In sailing close to the wind the ship is kept so near that the weather-leech of the sail is almost ready to receive the wind edgewise, and to flutter or fliver. The most effective or drawing sails with a side-wind, especially when

36
Corollaries.

37
The adjustment of the sails supposed in the theory impracticable.

when plying to windward, are the stayfalls. We believe that it is impossible to lay, with any thing approaching to precision, what is the position of the general surface of a stayfall, or to calculate the intensity and direction of the general impulse; and we affirm with confidence that no man can pronounce on tacit points with any exactness. If we can guess within a third or a fourth part of the truth, it is all we can pretend to; and after all, it is out a guess. Add to this, the sails coming in the way of each other, and either becalming them or finding the wind upon them in a direction widely different from that of its free motion. All these points we think beyond our power of calculation, and therefore that it is in vain to give the seaman mathematical rules, or even tables of adjustment ready calculated; since he can neither produce that medium position of his sails that is required, nor tell what is the position which he employs.

This is one of the principal reasons why so little advantage has been derived from the very ingenious and promising disquisitions of Bouguer and other mathematicians, and has made us omit the actual solution of the chief problems, contenting ourselves with pointing out the process to such readers as have a relish for these analytical operations.

But there is another principal reason for the small progress which has been made in the theory of seamanship: This is the error of the theory itself, which supposes the impulses of a fluid to be in the duplicate ratio of the sine of incidence. The most careful comparison which has been made between the results of this theory and matter of fact is to be seen in the experiments made by the members of the Royal Academy of Sciences at Paris, mentioned in the article *RESISTANCE of Fluids*. We subjoin another abstract of them in the following table; where col. 1st gives the angle of incidence; col. 2d gives the impulses really observed; col. 3d the impulses, had they followed the duplicate ratio of the sines; and col. 4th the impulses, if they were in the simple ratio of the sines.

Angle of incidence	Impulse really observed	Impulse as Sines ²	Impulse as Sines
90	1000	1000	1000
84	989	989	993
78	938	937	978
72	908	905	951
66	845	833	914
60	771	750	866
54	693	653	809
48	615	532	743
42	543	448	668
36	480	346	597
30	440	250	500
24	424	163	407
18	414	96	309
12	425	43	208
6	420	11	105

Here we see an enormous difference in the great obliquities. When the angle of incidence is only six degrees, the observed impulse is forty times greater than

the theoretical impulse; at 12° it is ten times greater; at 18° it is more than four times greater; and at 24° it is almost three times greater.

No wonder then that the deductions from this theory are so weak and to unlike what we familiarly observe. We took notice of this when we were considering the leeway of a rectangular box, and was led a reason for admitting an incomparably smaller leeway than what would result from the fabulous computations necessary by the theory. This error in theory has as great an influence on the impulses of air when acting obliquely on a sail; and the experiments of Mr ROBINS and of the Chevalier BOUDA on the oblique impulses of air are perfectly conformable (as far as they go) to those of the academicians on water. The oblique impulses of the wind are therefore much more efficacious for pressing the ship in the direction of her course than the theory allows us to suppose; and the progress of a ship plying to windward is much greater, both because the oblique impulses of the wind are more effective, and because the leeway is much smaller, than we suppose. Were not this the case, it would be impossible for a square-rigged ship to get to windward. The impulse on her sails when close hauled would be so trifling that she would not have a third part of the velocity which we see her acquire; and this trifling velocity would be wadded in leeway; for we have seen that the diminution of the oblique impulses of the water is accompanied by an increase of leeway. But we see that in the great obliquities the impulses continue to be very considerable, and that even an incidence of six degrees gives an impulse as great as the theory allows to an incidence of 45. We may therefore, on all occasions, keep the yards more square; and the loss which we sustain by the diminution of the very oblique impulse will be more than compensated by its more favourable direction with respect to the ship's keel. Let us take an example of this. Suppose the wind about two points before the beam, making an angle of 68° with the keel. The theory assigns 43° for the inclination of the wind to the sail, and 15° for the trim of the sail. The perpendicular impulse being supposed 1000, the theoretical impulse for 45° is 465. This reduced in the proportion of radius to the sine of 25°, gives the impulse in the direction of the course only 197.

But if we ease off the lee-braces till the yard makes an angle of 50° with the keel, and allows the wind an incidence of no more than 18°, we have the experimented impulse 414, which, when reduced in the proportion of radius to the sine of 50°, gives an effective impulse 317. In like manner, the trim 36°, with the incidence 12°, gives an effective impulse 357; and the trim 62°, with the incidence only 6°, gives 332.

Hence it would at first sight appear that the angle DCB of 62° and WCD of 6° would be better for holding a course within six points of the wind than any more oblique position of the sails; but it will only give a greater initial impulse. As the ship accelerates, the wind apparently comes ahead, and we must continue to brace up as the ship freshens her way. It is not unusual for her to acquire half or two thirds of the velocity of the wind; in which case the wind comes apparently ahead more than two points, when the yards must be braced up to 35°, and this allows an impulse no greater than about 40°. Now this is very far from

observed in good ships, which in a brisk gale and smooth water will go five or six knots close-hauled, the ship's head six points from the wind, and the sails no more than just full, but ready to fliver by the smallest luff. All this would be impossible by the usual theory; and in this respect these experiments of the French academy gave a fine illustration of the seaman's practice. They account for what we should otherwise be much puzzled to explain; and the great progress which is made by a ship close hauled being perfectly agreeable to what we should expect from the law of oblique impulsion deducible from these so often mentioned experiments, while it is totally incompatible with the common theory, should make us abandon the theory without hesitation, and strenuously set about the establishment of another, founded entirely on experiments. For this purpose the experiments should be made on the oblique impulsions of air on as great a scale as possible, and in as great a variety of circumstances, so as to furnish a series of impulsions for all angles of obliquity. We have but four or five experiments on this subject, viz. two by Mr Robins and two or three by the Chevalier Borda. Having thus gotten a series of impulsions, it is very practicable to raise on this foundation a practical institute, and to give a table of the velocities of a ship suited to every angle of inclination and of trim; for nothing is more certain than the resolution of the impulse perpendicular to the sail into a force in the direction of the keel, and a lateral force.

We are also disposed to think that experiments might be made on a model very nicely rigged with sails, and trimmed in every different degree, which would point out the mean direction of the impulle on the sails, and the comparative force of these impulsives in different directions of the wind. The method would be very similar to that for examining the impulle of the water on the hull. If this can also be ascertained experimentally, the intelligent reader will easily see that the whole motion of a ship under sail may be determined for every case. Tables may then be constructed by calculation, or by graphical operations, which will give the velocities of a ship in every different course, and corresponding to every trim of sail. And let it be here observed, that the trim of the sail is not to be estimated in degrees of inclination of the yards; because, as we have already remarked, we cannot observe nor adjust the latter sails in this way. But, in making the experiments for ascertaining the impulle, the exact position of the tracks and sheets of the sails are to be noted; and this combination of adjustments is to pass by the name of a certain trim. Thus that trim of all the sails may be called 42, whose direction is experimentally found equivalent to a flat surface trimmed to the obliquity 42°.

Having done this, we may construct a figure for each trim similar to fig. 8. where, instead of a circle, we shall have a curve *COM P*, whose chords *CP, cP*, &c. are proportional to the velocities in these courses; and by means of this curve we can find the point *m'*, which is not remote from any line *CM* from which we wish to withdraw; and thus we may solve all the principal problems of the art.

We hope that it will not be accounted presumption in us to expect more improvement from a theory

founded on judicious experiments only, than from a theory of the impulle of fluids, which is found to inconsistent with observation, and of whose fallacy all its authors, from Newton to D'Alembert, entertained strong suspicions. Again, we beg leave to recommend this view of the subject to the attention of the SOCIETY FOR THE IMPROVEMENT OF NAVAL ARCHITECTURE. Should these patriotic gentlemen entertain a favourable opinion of the plan, and honour us with their correspondence, we will cheerfully impart to them our notions of the way in which both these trains of experiments may be prosecuted with success, and results obtained in which we may confide; and we content ourselves at present with offering to the public these hints, which are not the speculations of a man of mere science, but of one who, with a competent knowledge of the laws of mechanical nature, has the experience of several years service in the royal navy, where the art of working of ships was a favourite object of his scientific attention.

With these observations we conclude our discussion of the first part of the seaman's task, and now proceed to consider the means that are employed to prevent or to produce any deviations from the uniform rectilinear course which has been selected.

Here the ship is to be considered as a body in free space, convertible round her centre of inertia. For whatever may be the point round which the turns, this motion may always be considered as compounded of a rotation round an axis passing through her centre of gravity or inertia. She is impelled by the wind and by the water acting on many surfaces differently inclined to each other, and the impulle on each is perpendicular to the surface. In order therefore that she may continue steadily in one course, it is not only necessary that the impelling forces, estimated in their mean direction, be equal and opposite to the resisting forces estimated in their mean direction; but also that these two directions may pass through one point, otherwise she will be affected as a log of wood is when pushed in opposite directions by two forces, which are equal indeed, but are applied to different parts of the log. A ship must be considered as a lever, acted on in different parts by forces in different directions, and the whole balancing each other round that point or axis where the equivalent of all the resisting forces passes. This may be considered as a point supported by this resisting force and as a sort of fulcrum; therefore, in order that the ship may maintain her position, the energies or momenta of all the impelling forces round this point must balance each other.

When a ship sails right afore the wind, with her yards square, it is evident that the impulsions on each side of the keel are equal, as also their mechanical momenta round any axis passing perpendicularly through the keel. So are the actions of the water on her bows. But when she sails on an oblique course, with her yards breezed up on either side, the various a pressure in the direction *CI* perpendicular to the sail. This, by giving her a lateral pressure *LI*, as well as a pressure *CL* ahead of the bows to make leeway, and to move in a line *CB* inclined to *CB*. By this means the balance of action on the two bows is destroyed; the general impulle on the lee-bow is increased; and that on the weather-bow is diminished.

42
Experiments proposed for establishing another

41
recom-
mended to
the Society
for the Im-
provement
of Naval
Architec-
ture.

42
Means em-
ployed to
prevent or to
produce de-
viations
from a
course.

43
Impulsive
square, it is
evident that
the impulsions
on each side
of the keel are
equal, as also
their mechanical
momenta round
any axis pass-
ing perpendicu-
larly through
the keel. So
are the actions
of the water on
her bows. But
when she sails
on an oblique
course, with her
yards breezed
up on either
side, the various
a pressure in
the direction
CI perpendicu-
lar to the sail.
This, by giving
her a lateral
pressure *LI*,
as well as a
pressure *CL*
ahead of the
bows to make
leeway, and to
move in a line
CB inclined
to *CB*.

minished. The combing impulse is therefore no longer in the direction BC , but (in the case of uniform motion) in the direction IC .

Suppose that, in an instant the whole fails are unbalanced and the upsetting pressure CI , which, precisely balanced the resisting pressure on the bows, removed. The ship tends, by her inertia, to proceed in the direction CB . This tendency produces a continuation of the resistance in the opposite direction IC , which is not directly opposed to the tendency of the ship in the direction CB ; therefore the ship's head would immediately come up to the wind. The experienced seaman will recollect feeling like this when the fails are suddenly lowered when coming to anchor. It does not happen solely from the obliquity of the action on the bows: It would happen to the parallelogram of fig. 2, which was sustaining a lateral impulsion $B \sin \alpha \times x$, and a direct impulsion $A \cos \alpha \times x$. These are continued for a moment after the annihilation of the BC : but being no longer opposed by a force in the direction CB , but by a force in the direction CA , the force $B \sin \alpha \times x$ must prevail, and the body is not only retarded in its motion, but its head turns to wind the wheel. But this effect of the Leeway is greatly increased by the curved form of the ship's bows. This occasions the centre of effort of all the impulsions of the water on the lee-side of the ship to be very far forward, and this so much the more remarkably as the lee is sharper astre. It is in general not much astre the foremast. Now the centre of the ship's tendency to continue her motion is the focus with her centre of gravity, and this is generally but a little before the mainmast. She is therefore in the same condition nearly as if she were pulled at the mainmast in a direction parallel to CB , and at the foremast by a force parallel to IC . The evident consequence of this is a tendency to come up to the wind. This is independent of all situation of the fails, provided only that they have been trimmed obliquely.

44
Capt.

This tendency of the ship's head to windward is called GRIPPING in the seaman's language, and is greatest in ships which are sharp forward, as we have said already. This circumstance is easily understood. Whatever is the direction of the ship's motion, the absolute impulse on that part of the bow immediately contiguous to B is perpendicular to that very part of the surface. The more acute, therefore, that the angle of the bow is, the more will the impulse on that part be perpendicular to the keel, and the greater will be its energy to turn the head to windward.

44
Propriety of
the disposition
of the
fails of a
ship.

Thus we are enabled to understand or to see the propriety of the disposition of the fails of a ship. We see her provided with fails forward, and even many fails extended far before her bow, such as the first-fail, the bowsprit-top-fail, the fore-topmast stay-fail, the jib, and flying jib. The fails abaft are comparatively smaller. The fails on the mainmast are much smaller than those on the foremast. All the stay-fails hoisted on the mainmast may be considered as head-fails, because their centres of effort are considerably before the centre of gravity of the ship: and notwithstanding this disposition, it generally requires a small action of the rudder to counteract the windward tendency of the lee-bow. This is considered as a good quality when moderate; because it enables the seaman to throw the fails abaft, and stop the ship's way in a moment, if she be in danger

from any thing she lies to; and the ship which does not carry a mile of a weather helm, is always a good sailor.

In order to judge somewhat more accurately of the action of the water and fails, suppose the ship AB (fig. 6.) to have its fails on the mainmast D , the mainmast E , and foremast F , braced up or trimmed alike, and that the three lines DD' , EE' , FF' , perpendicular to the fails, are in the proportion of the impulses on the fails. The ship is driven ahead and to leeward, and moves in the path aCB . This path is so inclined to the line of the keel that the medium direction of the resistance of the water is parallel to the direction of the impulse. A line CI may be drawn parallel to the lines DD' , EE' , FF' , and I equal to their sum: and it may be drawn from each a point C , that the actions on all the parts of the hull between C and B may balance the *momenta* of all the impulses on the hull between C and A . This point may justly be called the *centre of effort*, or *Centre of effort*.

46
Action of
the water
on the
ship.

Fig. 5.

We cannot determine this point for want of a theory of the resistance of fluids. $N \sin \alpha$, although very eminent like those of the Parisian academy should give us the most perfect knowledge of the intensity, or of the equal impulses on a square foot, we should hardly be able to apply them: for the action of the water on a square foot of the hull at p , for instance, is so modified by the intervention of the stream of water which has struck the hull about B , and glided along the bow $B \sin \rho$, that the pressure on p is totally different from what it would have been were it a square foot or surface detached from the rest, and presented in the same position to the water moving in the direction bC . For it is found, that the resistances given to planes joined so as to form a wedge, or to curved surfaces, are widely different from the accumulated resistances, calculated for their separate parts, agreeably to the experiments of the academy on single surfaces. We therefore do not attempt to ascertain the point C by theory; but it may be accurately determined by the experiments which we have so strongly recommended; and we offer this as an additional inducement for prosecuting them.

Draw through C a line perpendicular to CI , that is, parallel to the fails; and let the lines of impulse of the three fails cut it in the points k , l , and m . This line im may be considered as a lever, moveable round C , and acted on at the points k , l , and m , by three forces. The rotatory momentum of the fails on the mainmast is $D'k \times Ck$; that of the fails on the mainmast is $E \times l \times Cl$; and the momentum of the fails on the foremast is $F \times m \times Cm$. The two first tend to press forward the arm Cl , and then to turn the ship's head to wind the wheel. The action of the fails on the foremast tends to pull the arm Cm forward, and produce a contrary rotation. If the ship under these three fails keeps steadily in her course, without the aid of the rudder, we shall have $D'k \times Ck + E \times l \times Cl = F \times m \times Cm$. This is very possible, and is often seen in a ship under her main-top-fail, main-top-fail, and fore-top-fail, all pulled to one another, and their surfaces duly respected by reefing. If more fails are set, we must always have a similar equilibrium. A certain number of them will have their efforts directed to the larboard arm of the lever im lying to leeward of CI , and a certain number will have their efforts directed to the starboard arm lying to windward of CI . The sum of the products of each of the first set, by their distances from C , must be equal

49
Equilibrium
between
the
top-fail
and the
fore-top-fail.

equal

equal to the sum of the similar products of the other set. As this equilibrium is all that is necessary for preserving the ship's position, and the cessation of it is immediately followed by a conversion; and as these states of the ship may be had by means of the three square sails only, when their surfaces are properly proportioned—it is plain that every movement may be executed and explained by their means. This will greatly simplify our future discussions. We shall therefore suppose in future that there are only the three topsails set, and that their surfaces are so adjusted by reefing, that their actions exactly balance each other round that point C of the middle line AB, where the actions of the water on the different parts of her bottom in like manner balance each other. This point C may be differently situated in the ship according to the leeway she makes, depending on the trim of the sails; and therefore although a certain proportion of the three surfaces may balance each other in one state of leeway, they may happen not to do so in another state. But the equilibrium is evidently attainable in every case, and we therefore shall always suppose it.

It must now be observed, that when this equilibrium is destroyed, as, for example, by turning the edge of the mizen-top-sail to the wind, which the seamen call *flivvering* the mizen-top-sail, and which may be considered as equivalent to the removing the mizen-top-sail entirely, it does not follow that the ship will round the point C, this point remaining fixed. The ship must be considered as a free body, still acted on by a number of forces, which no longer balance each other; and she must therefore *begin* to turn round a spontaneous axis of conversion, which must be determined in the way set forth in the article ROTATION. It is of importance to point out in general where this axis is situated. Therefore let G (fig. 10.) be the centre of gravity of the ship. Draw the line qGv parallel to the yards, cutting Dd in q , Ee in r , CI in t , and Ff in v . While the three sails are set, the line qGv may be considered as a lever acted on by four forces, *vis.* Dd , impelling the lever forward perpendicularly in the point q ; Ee , impelling it forward in the point r ; Ff , impelling it forward in the point v ; and CI , impelling it backward in the point t . These forces balance each other both in respect of progressive motion and of rotatory energy: for CI was taken equal to the sum of Dd , Ee , and Ff ; so that no acceleration or retardation of the ship's progress in her course is supposed.

But by taking away the mizen-top-sail, both the equilibriums are destroyed. A part Dd of the accelerating force is taken away; and yet the ship, by her inertia or inherent force, tends, for a moment, to proceed in the direction Cp with her former velocity; and by this tendency exerts for a moment the same pressure CI on the water, and sustains the same resistance IC . She must therefore be retarded in her motion by the excess of the resistance IC over the remaining impelling forces Ee and Ff ; that is, by a force equal and opposite to Dd . She will therefore be retarded in the same manner as if the mizen-top-sail were still set, and a force equal and opposite to its action were applied to G the centre of gravity, and the would soon acquire a smaller velocity, which would again bring all things into equilibrium; and she would stand on in the same course, without changing either her leeway or the position of her head.

But the equilibrium of the lever is also destroyed.

It is now acted on by three forces only, *vis.* Ee and Ff , impelling it forward in the points r and v , and IC impelling it backward in the point t . Make $ro : ro :: Ee + Ff : Ff$, and make op parallel to CI and equal to $Ee + Ff$. Then we know, from the common principles of mechanics, that the force op acting at o will have the same momentum or energy to turn the lever round any point whatever as the two forces Ee and Ff applied at r and v ; and now the lever is acted on by two forces, *vis.* IC , urging it backwards in the point t , and op urging it forwards in the point o . It must therefore turn round like a floating log, which gets two blows in opposite directions. If we now make $IC - op : op :: to : tx$, or $IC - op : IC :: to : ox$, and apply to the point x a force equal to $IC - op$ in the direction IC ; we know by the common principles of mechanics, that this force $IC - op$ will produce the same rotation round any point as the two forces IC and op applied in their proper directions at t and o . Let us examine the situation of the point x .

The force $IC - op$ is evidently $= Dd$, and op is $= Ee + Ff$. Therefore $ot : tx :: Dd : op$. But because, when all the sails were filled, there was an equilibrium round C , and therefore round t , and because the force op acting at o is equivalent to Ee and Ff acting at r and v , we must still have the equilibrium; and therefore we have the momentum $Dd \times qt = op \times ot$. Therefore $ot : tq :: Dd : op$, and $tq = tx$. Therefore the point x is the same with the point q .

Therefore, when we *flivver* the mizen-top-sail, the rotation of the ship is the same as if the ship were at rest, and a force equal and opposite to the action of the mizen-top-sail were applied at q or at D , or at any point in the line Dq .

This might have been shown in another and shorter way. Suppose all sails filled, the ship is in equilibrium. This will be disturbed by applying to D a force opposite to Dd ; and if the force be also equal to Dd , it is evident that these two forces destroy each other, and that this application of the force dD is equivalent to the taking away of the mizen-top-sail. But we chuse to give the whole mechanical investigation; because it gave us an opportunity of pointing out to the reader, in a case of very easy comprehension, the precise manner in which the ship is acted on by the different sails and by the water, and what share each of them has in the motion ultimately produced. We shall not repeat this manner of procedure in other cases, because a little reflection on the part of the reader will now enable him to trace the *modus operandi* through all its steps.

We now see that, in respect both of progressive motion and of conversion, the ship is affected by *flivvering* the sail D , in the same manner as if a force equal and opposite to Dd were applied at D , or at any point in the line Dd . We must now have recourse to the principles established under the article ROTATION.

Let p represent a particle of matter, r its radius vector, or its distance pG from an axis passing through the centre of gravity G , and let M represent the whole quantity of matter of the ship. Then its momentum of inertia is $= \int p \cdot r^2$ (see ROTATION, N^o 18.) The ship, impelled in the point D by a force in the direction dD , will begin to turn round a spontaneous vertical axis, passing through a point S of the line qG , which

So
Conse-
quence
of
destroy-
ing it.

Fig. 10.

By *flivver-
ing* the
mizen-top-
sail.

which is drawn through the centre of gravity G , perpendicular to the direction dD of the external force, and the distance GS of this axis from the centre of gravity

is $= \frac{\int p \cdot r^2}{M \cdot G \gamma}$ (see ROTATION, N^o 96.), and it is

taken on the opposite side of G from γ , that is, S and γ are on opposite sides of G .

Let us express the external force by the symbol F . It is equivalent to a certain number of pounds, being the pressure of the wind moving with the velocity V and inclination a on the surface of the sail D ; and may therefore be computed either by the theoretical or experimental law of oblique impulses. Having obtained this, we can ascertain the angular velocity of the rotation and the absolute velocity of any given point of the ship by means of the theorems established in the article ROTATION.

52
Action of
the rudder.
Fig. 11.

But before we proceed to this investigation, we shall consider the action of the rudder, which operates precisely in the same manner. Let the ship AB (fig. 11.) have her rudder in the position AD , the helm being hard a-starboard, while the ship sailing on the starboard tack, and making leeway, keeps on the course ab . The lee surface of the rudder meets the water obliquely. The very foot of the rudder meets it in the direction DE parallel to ab . The parts farther up meet it with various obliquities, and with various velocities, as it glides round the bottom of the ship and falls into the wake. It is absolutely impossible to calculate the accumulated impulse. We shall not be far mistaken in the detection of each contiguous filament, as it quits the bottom and glides along the rudder; but we neither know the velocity of these filaments, nor the deflection and velocity of the filaments gliding without them. We therefore imagine that all computations on this subject are in vain. But it is enough for our purpose that we know the direction of the absolute pressure which they exert on its surface. It is in the direction Dd , perpendicular to that surface. We also may be confident that this pressure is very considerable, in proportion to the action of the water on the ship's bows, or of the wind on the sails; and we may suppose it to be nearly in the proportion of the square of the velocity of the ship in her course; but we cannot affirm it to be accurately in that proportion, for reasons that will readily occur to one who considers the way in which the water falls in behind the ship.

It is observed, however, that a fine sloop always steers well, and that all movements by means of the rudder are performed with great rapidity when the velocity of the ship is great. We shall see by and by, that the speed with which the ship performs the angular movements is in the proportion of her progressive velocity; for we shall see that the squares of the times of performing the evolution are as the impulses inversely, which are as the squares of the velocities. There is perhaps no force which acts on a ship, that can be more accurately determined by experiment than this. Let the ship ride in a stream or tideway whose velocity is accurately measured; and let her ride from two windings, S that her bow may be a fixed point. Let a small tow-line be laid out from her stern or quarter at right angles to the keel, and connected with some apparatus fixed up on shore or on board another ship, by

which the strain on it may be accurately measured; a person conversant with mechanics will see many ways in which this can be done. Perhaps the following may be as good as any: Let the end of the tow-line be fixed to some point as high out of the water as the point of the ship from which it is given out, and let this be very high. Let a block with a hook be on the rope, and a considerable weight hung on this hook. Things being thus prepared, put down the helm to a certain angle, so as to cause the ship to sheer off from the point to which the far end of the tow-line is attached. This will stretch the rope, and raise the weight out of the water. Now heave upon the rope, to bring the ship back again to her former position, with her keel in the direction of the stream. When this position is attained, note carefully the form of the rope, that is, the angle which its two parts make with the horizon. Call this angle α . Every person acquainted with these subjects knows that the horizontal strain is equal to half the weight multiplied by the cotangent of α , or that 2 is to the cotangent of α as the weight to the horizontal strain. Now it is this strain which balances and therefore measures the action of the rudder, or Dd , in fig. 11. Therefore, to have the absolute impulse Dd , we must increase Dd in the proportion of radius to the secant of the angle b which the rudder makes with the keel. In a great ship sailing six miles in an hour, the impulse on the rudder inclined 25° to the keel is not less than 3000 pounds. The surface of the rudder of such a ship contains near 80 square feet. It is not, however, very necessary to know this absolute impulse Dd , because it is its part De alone which measures the energy of the rudder in producing a conversion. Such experiments, made with various positions of the rudder, will give its energies corresponding to these positions, and will settle that long disputed point, which is the best position for turning a ship. On the hypothesis that the impulses of fluids are in the duplicate ratio of the sines of incidence, there can be no doubt that it should make an angle of $54^\circ 44'$ with the keel. But the form of a large ship will not admit of this, because a tiller of a length sufficient for managing the rudder in sailing with great velocity has not room to deviate above 50° from the direction of the keel; and in this position of the rudder the mean obliquity of the filaments of water to its surface cannot exceed 40° or 45° . A greater angle would not be of much service, for it is never for want of a proper obliquity that the rudder fails of producing a conversion.

A ship misses stays in rough weather for want of a sufficient progressive velocity, and because her bows are beat off by the waves; and there is seldom any difficulty in wearing the ship, if she has any progressive motion. It is, however, always desirable to give the rudder as much influence as possible. Its surface should be enlarged (especially below) as much as can be done consistently with its strength and with the power of the fleetmen to manage it; and it should be put in the most favourable situation for the water to get at it with great velocity; and it should be placed as far from the stern of the ship's motion as possible. These points are obtained by making the stem-post very upright, as has always been done in the French dockyards. The British ships have a much greater rake; but our builders are gradually adopting the French forms, experience ha-

ving taught us that their ships, when in our possession, are much more obedient to the helm than our own.— In order to ascertain the motion produced by the action of the rudder, draw from the centre of gravity a line Gg perpendicular to Dd (Dd being drawn through the centre of effort of the rudder). Then, as in the consideration of the action of the sails, we may conceive the line gG as a lever connected with the ship, and impelled by a force Dd acting perpendicularly at g . The consequence of this will be, an incipient conversion of the ship about a vertical axis passing through some point S in the line gG , lying on the other side of G from g ; and we have, as in the former case, $GS =$

$$\frac{\int \rho \cdot r^2}{M \cdot Gg}$$

⁶⁵
The action of the rudder is similar to that of the sails, and very great.

Thus the action and effects of the sails and of the rudder are perfectly similar, and are to be considered in the same manner. We see that the action of the rudder, though of a small surface in comparison of the sails, must be very great: For the impulse of water is many hundred times greater than that of the wind; and the arm gG of the lever, by which it acts, is incomparably greater than that by which any of the impulses on the sails produces its effect; accordingly the ship yields much more rapidly to its action than she does to the lateral impulse of a sail.

Observe here, that if G were a fixed or supported axis, it would be the same thing whether the absolute force Dd of the rudder acts in the direction Dd , or its transverse part De acts in the direction De , both would produce the same rotation; but it is not so in a free body. The force Dd both tends to retard the ship's motion and to produce a rotation: It retards it as much as if the same force Dd had been immediately applied to the centre. And thus the real motion of the ship is compounded of a motion of the centre in a direction parallel to Dd , and of a motion round the centre. These two constitute the motion round S .

⁶⁷
Employed as an example of the motions of conversion.

As the effects of the action of the rudder are both more remarkable and somewhat more simple than those of the sails, we shall employ them as an example of the mechanism of the motions of conversion in general; and as we must content ourselves in a work like this with what is very general, we shall simplify the investigation by attending only to the motion of conversion. We can get an accurate notion of the whole motion, if wanted for any purpose, by combining the progressive or retrograde motion parallel to Dd with the motion of rotation which we are about to determine.

In this case, then, we observe, in the first place, that the angular velocity (see ROTATION, N^o 22.) is $\frac{Dh \cdot gG}{\int \rho r^2}$;

and, as was shown in that article, this velocity of rotation increases in the proportion of the time of the forces uniform action, and the rotation would be uniformly accelerated if the forces did really act uniformly. This, however, cannot be the case, because, by the ship's change of position and change of progressive velocity, the direction and intensity of the impelling force is continually changing. But if two ships are performing similar evolutions, it is obvious that the changes of force are similar in similar parts of the evolution. Therefore

the consideration of the momentary evolution is sufficient for enabling us to compare the motions of ships actuated by similar forces, which is all we have in view at present. The velocity v , generated in any time t by the continuance of an invariable momentary acceleration (which is all that we mean by saying that it is produced by the action of a constant accelerating force), is as the acceleration and the time jointly. Now what we call the angular velocity is nothing but this momentary acceleration. Therefore the velocity v generated in the time

$$t \text{ is } = \frac{F \cdot gG}{\int \rho r^2} t.$$

The expression of the angular velocity is also the expression of the velocity v of a point situated at the distance α from the axis G .

Let α be the space or arch of revolution described in the time t by this point, whose distance from G is $= 1$. Then $\dot{\alpha} = v$ is $= \frac{F \cdot gG}{\int \rho r^2} t$; and taking the

ducent $\alpha = \frac{F \cdot gG}{\int \rho r^2} t^2$. This arch measures the whole

angle of rotation accomplished in the time t . These are therefore as the squares of the times from the beginning of the rotation.

Those evolutions are equal which are measured by equal arches. Thus two motions of 45 degrees each are equal. Therefore because α is the same in both,

the quantity $\frac{F \cdot gG}{\int \rho r^2} t^2$ is a constant quantity, and t^2 is

reciprocally proportional to $\frac{F \cdot gG}{\int \rho r^2}$, or is proportional

to $\frac{\int \rho r^2}{F \cdot gG}$, and t is proportional to $\frac{\sqrt{\int \rho r^2}}{\sqrt{F \cdot gG}}$. That

is to say, the times of the similar evolutions of two ships are as the square root of the momentum of inertia directly, and as the square root of the momentum of the rudder or sail inversely. This will enable us to make the comparison easily. Let us suppose the ships perfectly similar in form and rigging, and to differ only in length L and l ; $\int P \cdot R^2$ is to $\int \rho r^2$ as L^5 to l^5 ,

For the similar particles P and ρ contain quantities of matter which are as the cubes of their lineal dimensions, that is, as L^3 to l^3 . And because the particles are similarly situated, R^2 is to r^2 as L^2 to l^2 . Therefore $P \cdot R^2 : \rho \cdot r^2 = L^5 : l^5$. Now F is to f as L^3 to l^3 . For the surfaces of the similar rudders or sails are as the squares of their lineal dimensions, that is, as L^2 to l^2 . And, lastly, Gg is to $g g$ as L to l , and therefore $F \cdot Gg : f \cdot g g = L^3 : l^3$. Therefore we have $T^2 :$

$$t^2 = \frac{\int P \cdot R^2}{F \cdot Gg} : \frac{\int \rho \cdot r^2}{f \cdot g g} = \frac{L^5}{L^3} : \frac{l^5}{l^3} = L^2 : l^2, \text{ and } T : t = L : l.$$

Therefore the times of performing similar evolutions with similar ships are proportional to the lengths of the ships when both are sailing equally fast; and since the evolutions are similar, and the forces vary similarly in their

their different parts, what is here demonstrated of the smallest incipient evolutions is true of the whole. They therefore not only describe equal angles of revolution, but also similar curves.

A small ship, therefore, works in less time and in less room than a great ship, and this in the proportion of its length. This is a great advantage in all cases, particularly in wearing, in order to sail on the other tack close-hauled. In this case the will always be to windward and a-head of the large ship, when both are got on the other tack. It would appear at first sight that the large ship will have the advantage in tacking. Indeed the large ship is farther to windward when again trimmed on the other tack than the small ship when it is just trimmed on the other tack. But this happened before the large ship had completed her evolution, and the small ship, in the mean time, has been going forward on the other tack, and going to windward. She will therefore be before the large ship's beam, and perhaps as far to windward.

We have seen that the velocity of rotation is proportional, *ceteris paribus*, to $F \times G \times q$. F means the absolute impulse on the rudder or fail, and is always perpendicular to its surface. This absolute impulse on a fail depends on the obliquity of the wind to its surface. The usual theory says, that it is as the square of the sine of incidence: but we find this not true. We must content ourselves with expressing it by some as yet unknown function ϕ of the angle of incidence a , and call it ϕa ; and if S be the surface of the fail, and V the velocity of the wind, the absolute impulse is $n V^2 S \times \phi a$. This acts (in the case of the mizen-topmast, fig. 1c.) by the lever $q G$, which is equal to $DG \times \cos. DG q$, and $DG q$ is equal to the angle of the yard and keel; and which angle we formerly called b . Therefore its energy in producing a rotation is $n V^2 S \times \phi a \times DG \times \cos. b$. Leaving out the constant quantities n, V^2, S , and DG , its energy is proportional to $\phi a \times \cos. b$. In order, therefore, that any fail may have the greatest power to produce a rotation round G , it must be so trimmed that $\phi a \times \cos. b$ may be a maximum. Thus, if we would trim the fails on the foremast, so as to pay the ship off from the wind right a-head with the greatest effect, and if we take the experiments of the French academicians as proper measures of the oblique impulses of the wind on the fail, we will brace up the yard to an angle of 48 degrees with the keel. The impulse corresponding to 48 is 615, and the cosine of 48° is 669. These give a product of 411435. If we brace the fail to 54.44, the angle assigned by the theory, the effective impulse is 425274. If we make the angle 45°, the impulse is 425774. It appears then that 48° is preferable to either of the others. But the difference is inconsiderable, as in all cases of maximum a small deviation from the best position is not very detrimental. But the difference between the theory and this experimental measure will be very great when the impulses of the wind are of necessity very oblique. Thus, in tacking ship, as soon as the headsails are taken aback, they serve to aid the evolution, as is evident: But if we were now to adopt the maxim inculcated by the theory, we should immediately round in the weather-braces, so as to increase the impulse on the fail, because it is then very small; and although we by this means make yard more square, and therefore diminish the rotatory mo-

mentum of this impulse, yet the impulse is more increased (by the theory) than its vertical lever is diminished.— Let us examine this a little more particularly, because it is reckoned one of the nicest points of seamanship to aid the ship's coming round by means of the headsails; and experienced seamen differ in their practice in this manœuvre. Suppose the yard braced up to 42°, which is as much as can be usually done, and that the fail shivers (the bowlines are usually let go when the helm is put down), the fail immediately takes aback, and in a moment we may suppose an incidence of 6 degrees. The impulse corresponding to this is 405 (by experiment), and the cosine of 42° is 706. This gives 284407 for the effective impulse. To proceed according to the theory, we should brace the yard to 72°, which would give the wind (now 34° on the weather-box) an incidence of nearly 36°, and the fail an inclination of 20° to the intended motion, which is perpendicular to the keel. For the tangent of 22° is about $\frac{1}{2}$ of the tangent of 36°. Let us now see what effective impulse the experimental law of oblique impulses will give for this adjustment of the fails. The experimental impulse for 36° is 480; the cosine of 72° is 242; the product is 104160, not much exceeding the half of the former. Nay, the impulse for 36°, calculated by the theory, would have been only 346, and the effective impulse only 118332. And it must be farther observed, that this theoretical adjustment would tend greatly to check the evolution, and in most cases would entirely mar it, by checking the ship's motion a head, and consequently the action of the rudder, which is the most powerful agent in the evolution; for here would be a great impulse directed almost astern.

We were justifiable, therefore, in saying, in the beginning of this article, that a seaman would frequently find himself baffled if he were to work a ship according to the rules deduced from M. Bouguer's work; and we see by this instance of what importance it is to have the oblique impulses of fluids ascertained experimentally. The practice of the most experienced seaman is directly the opposite to this theoretical maxim, and its success greatly confirms the usefulness of these experiments of the academicians so often praised by us.

We return again to the general consideration of the rotatory motion. We found the velocity $v = \frac{F \cdot q \cdot G}{\int p \cdot r^2}$

It is therefore proportional, *ceteris paribus*, to $q \cdot G$. We have seen in what manner $q \cdot G$ depends on the position and situation of the fail or rudder when the joint G is fixed. But it also depends on the position of G . With respect to the action of the rudder, it is evident that it is so much the more powerful as it is more remote from G . The distance from G may be increased either by moving the rudder farther ast or G farther forward. And as it is of the utmost importance that a ship answer her helm with the greatest promptitude, those circumstances have been attended to which distinguished fine steering ships from such as had not this quality; and it is in a great measure to be ascribed to this, that, in the gradual improvement of naval architecture, the centre of gravity has been placed far forward. Perhaps the notion of a centre of gravity did not come into the thoughts of the rude builders in early times; but they observed that those boats and ships steered best which

had their extreme breadth before the middle point, and consequently the bows not so acute as the stern. This is so contrary to what one would expect, that it attracted attention more forcibly; and, being somewhat mysterious, it might prompt to attempts of improvement, by exceeding in this singular maxim. We believe that it has been carried as far as is compatible with other essential requisites in a ship.

We believe that this is the chief circumstance in what is called the trim of a ship; and it were greatly to be wished that the best place for the centre of gravity could be accurately ascertained. A practice prevails, which is the opposite of what we are now advancing. It is usual to load a ship so that her keel is not horizontal, but lower abaft. This is found to improve her steerage. The reason of this is obvious. It increases the acting surface of the rudder, and allows the water to come at it with much greater freedom and regularity; and it generally diminishes the gripping of the ship forward, by removing a part of the bows out of the water. It has not always this effect; for the form of the harping aloft is frequently such, that the tendency to gripe is diminished by immersing more of the bow in the water.

But waving these circumstances, and attending only to the rotatory energy of the rudder, we see that it is of advantage to carry the centre of gravity forward. The same advantage is gained to the action of the after sails. But, on the other hand, the action of the head-sails is diminished by it; and we may call every sail a head-sail whose centre of gravity is before the centre of gravity of the ship; that is, all the sails hoisted on the bowsprit and foremast, and the staysails hoisted on the mainmast; for the centre of gravity is seldom far before the mainmast.

Suppose that when the rudder is put into the position AD (fig. 11.), the centre of gravity could be shifted to g , so as to increase qG , and that this is done without increasing the sum of the products ρr^2 . It is obvious that the velocity of conversion will be increased in the proportion of qG to qg . This is very possible, by bringing to that side of the ship parts of her loading which were situated at a distance from G on the other side. Nay, we can make this change in such a manner that $\int \rho r^2$ shall even be less than it was before, by taking care that every thing which we shift shall be nearer to g than it was formerly to G . Suppose it all placed in one spot m , and that m is the quantity of matter so shifted, while M is the quantity of matter in the whole ship. It is only necessary that $m \cdot g^2$ shall be less than the sum of the products ρr^2 corresponding to the matter which has been shifted. Now, although the matter which is easily moveable is generally very small in comparison to the whole matter of the ship, and therefore can make but a small change in the place of the centre of gravity, it may frequently be brought from places so remote that it may occasion a very sensible diminution of the quantity $\int \rho r^2$, which expresses the whole momentum of inertia.

This explains a practice of the seamen in small wherries or skiffs, who in putting about are accustomed to place themselves to leeward of the mast. They even find that they can add the quick motions of these light

boats by the way in which they rest on their two feet, sometimes leaning all on one foot, and sometimes on the other. And we have often seen this evolution very sensibly accelerated in a ship of war, by the crew running suddenly, as the helm is put down, to the lee-bow. And we have heard it ascribed by very expert seamen, that after all attempts to wear ship (after lying-to in a storm) have failed, they have succeeded by the crew collecting themselves near the weather fore-throwds the moment the helm was put down. It must be agreeable to the reflecting seaman to see this practice supported by undoubted mechanical principles.

It will appear paradoxical to say that the evolution may be accelerated even by an addition of matter to the ship; and though it is only a piece of curiosity, our readers may wish to be made sensible of it. Let m be the addition, placed in some point m lying beyond G from q . Let S be the spontaneous centre of conversion before the addition. Let v be the velocity of rotation round g , that is, the velocity of a point whose distance from g is r , and let ρ be the radius vector, or distance of a particle from g . We have (ROTATION, N^o 22.) $v = \frac{F \cdot qg}{\int \rho^2 \xi^2 + m m g^2}$. But we know (ROTATION, N^o 23.)

that $\int \rho^2 \xi^2 = \int \rho^2 r^2 + M \cdot G g^2$. Therefore $v = \frac{F \cdot qg}{\int \rho^2 r^2 + M \cdot G g^2 + m \cdot m g^2}$. Let us determine Gg and $m g$ and qg .

Let mG be called z . Then, by the nature of the centre of gravity, $M + m : M = Gm : g m$, and $g m = \frac{M}{M+m} z$, and $m \cdot g m^2 = \frac{M m^2}{M+m} z^2$. In like manner, $M \cdot G g^2 = \frac{M m^2}{M+m} z^2$. Now $m M^2 + M m^2 = M m \times M + m$. Therefore $M \cdot G g^2 + m \cdot g m^2 = \frac{M m \times (M+m)}{M+m} z^2 = \frac{M m}{M+m} z^2$. Let n be $= \frac{m}{M+m}$, then $M \cdot G^2 + m \cdot g m^2 = M n z^2$. Also $Gg = n z$, being $= \frac{m}{M+m} z$. Let qG be called c : then $qg = c + n z$. Also let SG be called e .

We have now for the expression of the velocity $v = \frac{F(c+nz)}{M \times \frac{c+nz}{c+nz}}$, or $v = \frac{F}{M} \times \frac{c+nz}{c+nz}$. But $\int \rho^2 r^2 + M n z^2 = \frac{F}{M+nz}$.

(ROTATION, N^o 30) $\frac{\int \rho^2 r^2}{M} = c e$. Therefore, finally, $v = \frac{F}{M} \times \frac{c+nz}{c e + n z^2}$. Had there been no addition of matter made, we should have had $v = \frac{F}{M} \times \frac{c}{c e}$. It remains to

show, that z may be so taken that $\frac{c}{c e}$ may be less than $\frac{c+nz}{c e + n z^2}$. Now, if c be to z as $c e$ to z^2 , that is, if z

63
The evolu-
tion accele-
rated by
additional
matter.

be taken equal to α , the two fractions will be equal. But if α be less than α , that is, if the additional matter is placed anywhere between S and G, the complex fraction will be greater than the fraction $\frac{c}{c'}$, and the velocity of rotation will be increased. There is a particular distance which will make it the greatest possible, namely, when α is made $= \frac{1}{\alpha} (\sqrt{c^2 + ac} - c)$, as will

64
The rotation performed round a spontaneous axis.

enly be found by treating the fraction $\frac{c + \alpha z}{c' + \alpha z}$, with α , considered as the variable quantity, for a maximum. In what we have been saying on this subject, we have considered the rotation only in as much as it is performed round the centre of gravity, although in every moment it is really performed round a spontaneous axis lying beyond that centre. This was done because it afforded an easy investigation, and any angular motion round the centre of gravity is equal to the angular motion round any other point. Therefore the extent and the time of the evolution are accurately defined.—

From observing that the energy of the force F is proportional to qG , an inattentive reader will be apt to conceive the centre of gravity as the centre of motion, and the rotation as taking place, because the momenta of the sails and rudder, on the opposite sides of the centre of gravity, do not balance each other. But we must always keep in mind that this is not the cause of the rotation. The cause is the want of equilibrium round the point C (fig. 10.), where the actions of the water balance each other. During the evolution, which consists of a rotation combined with a progressive motion, this point C is continually shifting, and the unbalanced momenta which continue the rotation always respect the momentary situation of the point C. It is nevertheless always true that the energy of a force F is proportional (*ceteris paribus*) to qG , and the rotation is always made in the same direction as if the point G were really the centre of conversion. Therefore the mainmast axis always (when oblique) by pushing the stern away from the wind, although it should sometimes act on a point of the vertical lever through C, which is ahead of C.

These observations on the effects of the sails and rudder in producing a conversion, are sufficient for enabling us to explain any case of their action which may occur. We have not considered the effects which they tend to produce by inclining the ship round a horizontal axis, viz. the motions of rolling and pitching. See ROLLING and FITTING. To treat this subject properly would lead us into the whole doctrine of the equilibrium of floating bodies, and it would rather lead to maxims of construction than to maxims of manœuvre. M. Bouguer's *Traité du Navire* and Euler's *Scientia Navalis* are excellent performances on this subject, and we are not here obliged to have recourse to any erroneous theory.

65
Diff. rent operations of the water on the ship and wind as the sails & rudder.

It is easy to see that the lateral pressure both of the wind on the sails and of the water on the rudder tends to incline the ship to one side. The sails also tend to press the ship's bows into the water, and, if she were kept from advancing, would press them down considerably. But by the ship's motion, and the prominent form of her bows, the resistance of the water to the fore part of the ship produces a force which is directed

upwards. The sails also have a small tendency to raise the ship, for they constitute a surface which in general separates from the plumb-line below. This is remarkably the case in the stay-sails, particularly the jib and fore-topmast stay-sail. And this helps greatly to stiffen the plunges or the ship's bows into the head seas. The upward pressure also of the water on her bows, which we just now mentioned, has a great effect in opposing the immersion of the bows which the sails produce by acting on the long levers furnished by the masts. M.

Bouguer gives the name of *point velue* to the point V (fig. 12.) of the mast, where it is cut by the line CV, which marks the mean place and direction of the whole impulse of the water on the bows. And he observes, that if the mean direction of all the actions of the wind on the sails be made to pass also through this point, there will be a perfect equilibrium, and the ship will have no tendency to plunge into the water or to rise out of it; for the whole action of the water on the bows, in the direction CV, is equivalent to, and may be resolved into the action CE, by which the progressive motion is resisted, and the vertical action CD, by which the ship is raised above the water. The force CE must be opposed by an equal force VD, exerted by the wind on the sails, and the force CD is opposed by the weight of the ship. If the mean effort of the sails passes above the point V, the ship's bow will be pressed into the water; and if it pass below V, her stern will be pressed down. But, by the union of these forces, she will rise and fall with the sea, keeping always in a parallel position. We apprehend that it is of very little moment to attend to the situation of this point. Except when the ship is right after the wind, it is a thousand chances to one that the line CV of mean resistance does not pass through any mast; and the fact is, that the ship cannot be in a state of uniform motion on any other condition but the perfect union of the line of mean action of the sails, and the line of mean action of the resistance. But its place shifts by every change of leeway or of trim; and it is impossible to keep these lines in one constant point of intersection for a moment, on account of the incessant changes of the surface of the water on which the floats. M. Bouguer's observations on this point are, however, very ingenious and original.

66
Chief evolutions intended for the instruction of the artist by making him familiar of the mechanical procedure.

We conclude this dissertation, by describing some of the chief evolutions or evolutions. What we have intended for the instruction of the artist by making him familiar of the mechanical procedure. The description is rather meant for the amusement of the landman, enabling him to understand operations that are familiar to the seaman. The latter will perhaps smile at the awkward account given of his business by one who cannot hand, reef, or steer.

To tack Ship.

The ship must first be kept full, that is, with a very sensible angle of incidence on the sails, and by no means hugging the wind. For as this evolution is chiefly performed by the rudder, it is necessary to give the ship a good velocity. When the ship is observed to luff up of herself, that moment is to be caught for beginning the evolution, because she will by her inherent force continue this motion. The helm is then put down. When the officer calls out Helm's a lee, the fore-sheet, fore-top-boom-line, jib, and flag tail sheets are

ward are let go. The jib is frequently hauled down. Thus the obstacles to the ship's head coming up to the wind by the action of the rudder are removed. If the main-fail is set, it is not unusual to clue up the weather side, which may be considered as a head-fail, because it is before the centre of gravity. The mizen must be hauled out, and even the fail braced to windward. Its power in paying off the stern from the wind conspires with the action of the rudder. It is really an aerial rudder. The fails are immediately taken aback. In this state the effect of the mizen-top-fail would be to obstruct the movement, by pressing the stern the contrary way to what it did before. It is therefore either immediately braced about sharp on the other tack, or lowered. Bracing it about evidently tends to pay round the stern from the wind, and thus assist in bringing the head up to the wind. But in this position it checks the progressive motion of the ship, on which the evolution chiefly depends. For a rapid evolution, therefore, it is as well to lower the mizen-top-fail. Meantime, the head-fails are all aback, and the action of the wind on them tends greatly to pay the ship round. To increase this effect, it is not unusual to haul the fore-top bowline again. The fails on the main-mast are now almost becalmed; and therefore when the wind is right ahead, or a little before, the main-fail is hauled round and braced up sharp on the other tack with all expedition. The stay-fail sheets are now shifted over to their places for the other tack. The ship is now entirely under the power of the head-fails and of the rudder, and their actions conspire to promote the conversion. The ship has acquired an angular motion, and will preserve it, so that now the evolution is secured, and the fails off apace from the wind on the other tack. The farther action of the rudder is therefore unnecessary, and would even be prejudicial, by causing the ship to fall off too much from the wind before the fails can be shifted and trimmed for falling on the other tack. It is therefore proper to right the helm when the wind is right ahead, that is, to bring the rudder into the direction of the keel. The ship continues her conversion by her inherent force and the action of the head-fails.

When the ship has fallen off about four points from the wind, the head-fails are hauled round, and trimmed sharp on the other tack with all expedition; and although this operation was begun with the wind four points on the bow, it will be six before the fails are braced up, and therefore the head-fails will immediately fill. The after-fails have filled already, while the head-fails were inactive, and therefore immediately check the farther falling off from the wind. All fails now draw, for the stay-fail sheets have been shifted over while they were becalmed or shaking in the wind. The ship now gathers way, and will obey the smallest motion of the helm to bring her close to the wind.

We have here supposed, that during all this operation the ship preserves her progressive motion. She must therefore have described a curve line, advancing all the while to windward. Fig. 13, is a representation of this evolution when it is performed in the completed manner. The ship starting on the course $E\sigma$, with the wind blowing in the direction WF , has her helm put hard a-lee when she is in the position A . She is presently deviated from her course, and describing a curve, comes to the position B , with the wind blowing

in the direction WF of the yards, and the square-fails now fliver. The mizen top-fail is here represented braced sharp on the other tack, by which its tendency to aid the angular motion (while it checks the progressive motion) is distinctly seen. The main and fore-fails are now flivering, and immediately after are taken aback. The effect of this on the head-fails is distinctly seen to be favourable to the conversion, by pulling the point F in the direction Ff ; but for the same reason it continues to retard the progressive motion. When the ship has attained to the position C , the main-fail is hauled round and trimmed for the other tack. The impulse in the direction Ff still aids the conversion and retards the progressive motion. When the ship has attained a position between C and D , such that the main and mizen top-fail yards are in the direction of the wind, there is nothing to counteract the force of the head-fails to pay the ship's head off from the wind. Nay, during the progress of the ship to this intermediate position, if any wind gets at the main or mizen top-fails, it acts on their anterior surfaces, and impels the after parts of the ship away from the curve $abc d$, and thus aids the evolution. We have therefore said, that when once the fails are taken fully aback, and particularly when the wind is brought right ahead, it is scarce possible for the evolution to fail; as soon therefore as the main top-fail (trimmed for the other tack) flivers, we are certain that the head-fails will be filled by the time they are hauled round and trimmed. The stay-fails are filled before this, because their sheets have been shifted, and they stand much sharper than the square-fails; and thus every thing tends to check the falling off from the wind on the other tack, and this no sooner than it should be done. The ship immediately gathers way, and holds on in her new course dG .

But it frequently happens, that in this conversion the ship loses her whole progressive motion. This sometimes happens while the fails are flivering before they are taken fully aback. It is evident, that in this case there is little hopes of success, for the ship now lies like a log, and neither sails nor rudder have any action. The ship drives to leeward like a log, and the water acting on the lee side of the rudder checks a little the driving of the stern. The head therefore falls off again, and by and by the fails fill, and the ship continues on her former tack. This is called MISSING STAYS, and it is generally owing to the ship's having too little velocity at the beginning of the evolution. Hence the propriety of keeping the fails well filled for some little time before. Rough weather, too, by raising a wave which beats violently on the weather-bow, frequently checks the first luffing of the ship, and beats her off again.

If the ship lose all her motion after the head-fails have been fully taken aback, and before we have brought the wind right ahead, the evolution becomes uncertain, but by no means desperate; for the action of the wind on the head-fails will presently give her stern-way. Suppose this to happen when the ship is in the position C . Bring the helm over hard to windward, so that the rudder shall have the position represented by the small dotted line σf . It is evident, that the resistance of the water to the stern-way of the rudder acts in a favourable direction, pushing the stern outwards. In the mean time, the action of the wind on the head-fails pushes the head in the opposite direction. These actions

tions confpire therefore in promoting the evolution; and if the wind is right ahead, it cannot fail, but may even be completed speedily, because the ship gathers leeway, and the action of the rudder becomes very powerful; and as soon as the wind comes on the formerly lee-bow, the action of the water on the now lee-quarter will greatly accelerate the conversion. When the wind therefore has once been brought nearly right ahead, there is no risk of being becalm'd.

But should the ship have left all her headway considerably before this, the evolution is very uncertain: for the action of the water on the rudder may not be nearly equal to its contrary action on the lee-quarter; in which case, the action of the wind on the headfalls may not be sufficient to make up the difference. When this is observed, when the ship goes astern without changing her position, we must immediately throw the headfalls completely aback, and put the helm down again, which will pay off the ship's head from the wind enough to enable us to fill the sails again on the same tack, to try our fortune again; or we must BOXHAUL the ship, in the manner to be described by and by.

Such is the ordinary process of tacking ship; a process in which all the different modes of action of the rudder and sails are employed. To execute this evolution in the most expeditious manner, and so as to gain as much on the wind as possible, is considered as the test of an expert seaman. We have described the process which is best calculated for *ensuring* the movement. But if the ship be sailing very briskly in smooth water, so that there is no danger of missing stays, we may gain more to windward considerably by keeping fast the fore-top bowline and the jib and stay-fall sheets till the square fails are all divering: For these sails, continuing to draw with considerable force, and balancing each other tolerably fore and aft, keep up the ship's velocity very much, and thus maintain the power of the rudder. If we now let all fly when the square fails are divering, the ship may be considered as without sails, but exposed to the action of the water on the lee-bow, from which arises a strong pressure of the bow to windward, which confpires with the action of the rudder to aid the conversion. It evidently leaves all that tendency of the bow to windward which arises from leeway, and even what was counteracted by the formerly unbalanced action of these head-stay sails. This method lengthens the whole time of the evolution, but it advances the ship to windward. Observe, too, that keeping fast the fore-top bowline till the sail thivers, and then letting it go, infuses the taking aback of that sail, and thus instantly produces an action that is favourable to the evolution.

The most expert seamen, however, differ among themselves with respect to these two methods, and the first is the most generally practised in the British navy, because the least liable to fail. The forces which oppose the conversion are sooner removed, and the production of a favourable action by the backing of the fore-top-sail is also sooner obtained, by letting go the fore-top bowline at the first.

Having entered so minutely into the description and rationale of this evolution, we have sufficiently turned the reader's attention to the different actions which cooperate in producing the motions of conversion. We shall therefore be very brief in our description of the other evolutions.

To wear Ship.

When the seaman sees that his ship will not go about head to wind, but will miss stays, he must change his tack the other way; that is, by turning her head away from the wind, going a little way before the wind, and then hauling the wind on the other tack. This is called WEARING or VEERING ship. It is most necessary in a stormy weather with little sail, or in very faint breezes, or in a disabled ship.

The process is exceedingly simple; and the mere narration of the procedure is sufficient for showing the propriety of every part of it.

Watch for the moment of the ship's falling off, and then haul up the main-sail and mizen, and dither the mizen top-sail, and put the helm a-weather. When the ship falls off sensibly (and not before), let go the bowlines. Ease away the fore-sheet, raise the fore-tack, and gather aft the weather fore-sheet, as the lee sheet is eased away. Round in the weather-braces of the fore and main-masts, and keep the yards nearly bisecting the angle of the wind and keel, so that when the ship is before the wind the yards may be square. It may even be of advantage to round in the weather-braces of the main-top-sail more than those of the head-falls; for the mainmast is abast the centre of gravity. All this while the mizen-top-sail must be kept divering, by rounding in the weather-braces as the ship pays off from the wind. Then the main top-sail will be braced up for the other tack by the time that we have brought the wind on the weather-quarter. After this it will be full, and will aid the evolution. When the wind is right aft, shift the jib and stay-fall sheets. The evolution now goes on with great rapidity; therefore briskly haul on board the fore and main tacks, and haul out the mizen, and set the mizen-stay-sail as soon as they will take the wind the right way. We must now check the great rapidity with which the ship comes to the wind on the other tack, by righting the helm before we bring the wind on the beam; and all must be trimmed sharp fore and aft by this time, that the headfalls may take and check the coming-to. All being trimmed, stand on close by the wind.

We cannot help losing much ground in this movement. Therefore, though it is very simple, it requires much attention and rapid execution to do it with as little loss of ground as possible. One is apt to imagine at first that it would be better to keep the headfalls braced up on the former tack, or at least not to round in the weather-braces so much as is here directed. When the ship is right afore the wind, we should expect assistance from the obliquity of the head-falls; but the rudder being the principal agent in the evolution, it is found that more is gained by increasing the ship's velocity, than by a smaller impulse in the headfalls more favourably directed. Experienced seamen differ, however, in their practice in respect of this particular.

To box-haul a Ship.

THIS is a process performed only in critical situations, as when a rock, a ship, or some danger, is suddenly seen right ahead, or when a ship misses stays. It requires the most rapid execution.

The ship being close-hauled on a wind, haul up the main-sail.

main-fail and mizen, and draw the top-fails, and put the helm hard a lee altogether. Raise the fore-tack, let go the head bowlines, and brace about the head-fails sharp on the other tack. The ship will quickly lose her way, get item-way, and then fall off, by the joint action of the head-fails and of the inverted rudder. When the helm has fallen off eight points, brace the after-fails square, which have hitherto been kept shivering. This will at first increase the power of the rudder, by increasing the stern-way, and at the same time it makes no opposition to the conversion which is going on. The continuation of her circular motion will presently cause them to take the wind on their after surfaces. This will check the stern-way, stop it, and give the ship a little head-way. Now shift the helm, so that the rudder may again act in conjunction with the head-fails in paying her off from the wind. This is the critical part of the evolution, because the ship has little or no way through the water, and will frequently remain long in this position. But as there are no counteracting forces, the ship continues to fall off. Then the weather-braces of the after-fails may be gently rounded in, so that the wind acting on their hinder surfaces may both pull the ship a little ahead and her stern laterally in conjunction with the rudder. Thus the wind is brought upon the quarter, and the head-fails draw. By this time the ship has acquired some headway. A continuation of the rotation would now fill the head-fails, and their action would be contrary to the intended evolution. They are therefore immediately braced the other way, nearly square, and the evolution is now completed in the same manner with wearing ship.

Some seamen brace all the fails aback the moment that the helm is put hard a-lee, but the after-fails no more aback than just to square the yards. This quickly gives the ship stern-way, and brings the rudder into action in its inverted direction; and they think that the evolution is accelerated by this method.

There is another problem of seamanship deserving of our attention, which cannot properly be called an evolution. This is lying-to. This is done in general by laving some fails aback, so as to stop the head-way produced by others. But there is a considerable address necessary for doing this in such a way that the ship shall lie easily, and under command, ready to proceed in her course, and easily brought under weigh.

To bring to with the fore or main-top-sail to the mast, brace that sail sharp aback, haul out the mizen, and clap the helm hard a-lee.

Suppose the fore-top-sail to be aback; the other fails float the ship ahead, and the lee-helm makes the fail come up to the wind, which makes it come more perpendicularly on the fail which is aback. Then its impulse from exceeds those on the other fails, which are now shivering, or almost shivering. The ship stands still awhile, and then falls off, so as to fill the after fails, which again shoot her ahead, and the process is thus repeated. A ship lying to in this way goes a good deal ahead and also to leeward. If the main-top-sail be aback, the ship shoots ahead, and comes up till the diminished impulse of the drawing fails in the direction of the keel is balanced by the increased impulse on the main-top-sail. She lies a-lee while in this position, driving slowly to leeward; and the lee sail falls off by the

heating of the water on her weather-bow. She falls off but little, and soon comes up again.

Thus a ship lying to is not like a mere log, but has a certain motion which keeps her under command. To get under weigh again, we must watch the time of falling off; and when this is just about to finish, brace about briskly, and fill the fail which was aback. To aid this operation, the jib and fore-top-mast stay-fail may be hoisted, and the mizen brail'd up; or, when the intended course is before the wind or large, back the fore-top-sail sharp, draw the main and mizen-top-sail, brail up the mizen, and hoist the jib and fore-top-mast stay-fails altogether.

In a storm with a contrary wind, or on a lee shore, a ship is obliged to lie-to under a very low fail. Some fail is absolutely necessary, in order to keep the ship steadily down, otherwise she would kick about like a cork, and roll so deep as to strain and work herself to pieces. Different ships behave best under different fails. In a very violent gale, the three lower stay-fails are in general well adapted for keeping her steady, and distributing the strain. This mode seems also well adapted for wearing, which may be done by hauling down the mizen-stay-sail. Under whatever fail the ship is brought to in a storm, it is always with a fitted fail, and never with one laid aback. The helm is lashed down hard a-lee; therefore the ship shoots ahead, and comes up till the sea on her weather-bow beats her off again. Getting under weigh is generally difficult; because the ship and rigging are lofty abaft, and hinder her from falling off readily when the helm is put hard a-weather. We must watch the falling off, and assist the ship by some small head-sail. Sometimes the crew get up on the weather fore-throwls in a crowd, and thus present a surface to the wind.

THESE examples of the three chief evolutions will enable those who are not seamen to understand the propriety of the different steps, and also to understand the other evolutions as they are described by practical authors. We are not acquainted with any performance in our language where the whole are considered in a connected and systematic manner. There is a book on this subject in French, called *Le Manœuvrier*, by M. Burdè de Ville-Huet, which is in great reputation in France. A translation into English was published some years ago, said to be the performance of the Chevalier de Sauleuil a French officer. But this appears to be a book-eller's puff; for it is undoubtedly the work of some person who did not understand either the French language, or the subject, or the mathematical principles which are employed in the scientific part. The blunders are not such as could possibly be made by a Frenchman not versant in the English language, but natural for an Englishman ignorant of French. No French gentleman or officer would have translated a work of this kind (which he professes to think so highly of) to serve the rivals and foes of his country. But indeed it can do no great harm in this way; for the scientific part of it is absolutely unintelligible for want of science in the translator; and the practical part is full of blunders for want of knowledge of the French language.

We offer this account of the subject with all proper respect and diligence. We do not profess to teach:

but

Fig 1

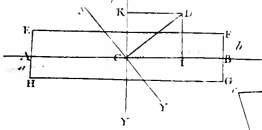

Fig 5

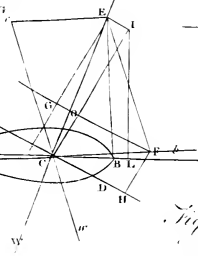

Fig 2

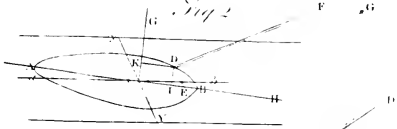

Fig 3

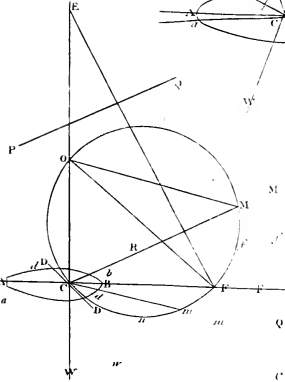

Fig 3

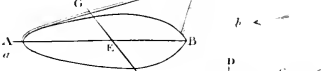

Fig 6

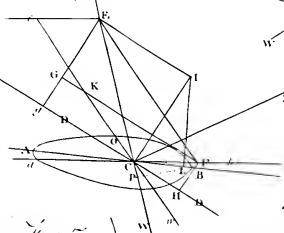

Fig 4

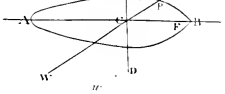

Fig 7

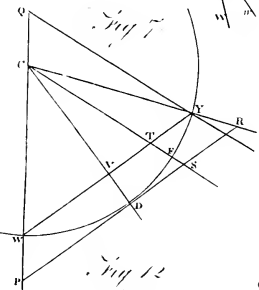

Fig 10

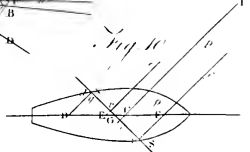

Fig 9

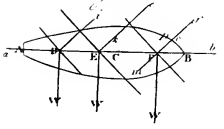

Fig 12

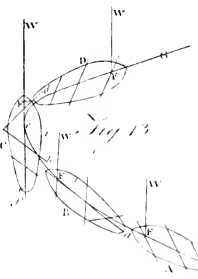
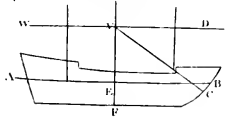

Fig 11

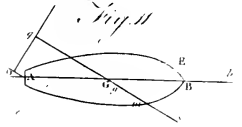

Fig 13

but by pointing out the defects of the celebrated works of M. Bouguer, and the course which may be taken to remove them, while we procure much valuable knowledge which they contain, we may perhaps excite some persons to apply to this subject, who, by a combination

of what is just in M. Bouguer's theory, with an experimental doctrine of the impulses of fluids, may produce a treatise of seamanship which will not be confined to the libraries of mathematicians, but become a manual for seamen by profession.

S E A

S E A

Seamen. SEAMEN, such persons as serve the king or others at sea by navigation and fighting ships, &c. See *MILITARY STATE*.

Seamen fighting, quarrelling, or making any disturbance, may be punished by the commissioners of the navy with fine and imprisonment. Registered seamen are exempted from serving in any parish office, &c. and are allowed bounty-money beside their pay. By the law of merchants, the seamen of a vessel are accountable to the master or commander, the master to the owners, and the owners to the merchants, for damage sustained either by negligence or otherwise. Where a seaman is hired for a voyage, and he deserts before it is ended, he shall lose his wages; and in case a ship be lost in a storm, the seamen lose their wages, as well as the owners their freight.

Means of Preserving the Health of SEAMEN. See *MEDICINE*, N^o 351.

In addition to what has been said on this subject in the place referred to, we shall subjoin some valuable observations which we have met with in the sixth volume of the Memoirs of the Royal Society of Medicine at Paris for the years 1784 and 1785.

In 1783, the marshal de Castries, intending to make some changes in the regulations of the navy, particularly with regard to diet, proposed to the society the two following questions: 1. "What are the most wholesome aliments for seamen, considering the impossibility of procuring them fresh meat? And what kinds of salt meat or fish, of pulse, and of drink, are most proper for them, and in what quantity, not omitting to inquire into the regimens in use amongst other maritime nations for what may be adopted by us, and into what experience has evinced the utility of, from the accounts of the most celebrated navigators?" 2. "A number of patients labouring under different diseases being assembled in naval hospitals, and different constitutions affected by the same disease requiring difference of diet, what general dietetic rules for an hospital would be best adapted to every exigence, dividing the patients into three classes; the first in which liquids alone are proper, the second in which we begin to give solids in small quantities, and the state of convalescence in which a fuller diet is necessary?" A committee was appointed to draw up an answer to these, who investigated the subject very minutely. The result of their labours is there given at large. The observations most worthy of notice are, that the scurvy of the English seamen, who live chiefly on salt-meat, is a putrid disease; whilst that of the Dutch, who use farinaceous vegetables and dried pulse in large quantities, has more of an hydropical tendency. A mixture of both, even at the same meal, is recommended. This is supported by philosophical reasoning, and the example of Captain Cook, who was partly indebted to this mixed regimen for the preserva-

tion of his crew. Salt fish should never be used: salt beef grows hard, and after boiling its fibrous parts only remain, which are more calculated to load the stomach than recruit the strength. Salt bacon may be kept at sea 18 months; it does not lose its moil and nutritional parts, and unites better with pulse, but should not be used when rancid. Live animals kept on board ships tend to produce diseases amongst the crew. Rice should be used largely. Our puddings are bad food: the flour would be much better made into bread, which might be done at sea with no great trouble. Sour krout should be used freely. Mustard, vinegar, sugar, melasses, and honey, are good antiscorbutics. Of drinks, wine is the best: wort, spruce beer, or the Russian *quars*, are good substitutes. Spirits are only to be used in cold climates, and in small quantity. The greater part of the excellent memoir in answer to the second question, perfectly coincides with M. Duhamel du Monceaux's "Means of Preserving the Health of Seamen," and M. Poissonnier des Perrieres's treatises "On the Diseases of Seamen," and "On the advantages of changing the Diet of Seamen," and his "Examination of Pringle's Dissertation."

SEAPOYS, or SEPOYS, natives of Indostan serving in a military capacity under the European powers, and disciplined after the European manner.

The Seapoys of the English East India company compose perhaps the most numerous, regular, and best disciplined body of black troops in the world. They are raised from among the natives of the country, and consist of Moors or Mahometans, Raja-poots, Hindoos, Pariars, besides many intermediate casts peculiar to themselves; the whole modelled in all corresponding particulars, and disciplined in every respect as the army of Great Britain.

The military establishments of Bengal, Madras and Bombay, have each their respective numbers, that of Bengal exceeding the rest. The Seapoys are formed into complete, uniform, and regular battalions, as our marching regiments at home, being intended to represent and answer fully to every purpose in India to the like troops in Europe. A battalion consists of 700 men, of complete effective strength. In each there are eight companies, including two flank ones or grenadiers. They are respectively commanded by their own black and European officers; to each company there is attached a subaltern, who takes the command, under whom are two native commissioned officers, bearing the rank of subidar and jimmidar; of eight subalterns, five are lieutenants, the other ensigns; exclusive is a staff, of adjutant and surgeon. The black non-commissioned officers answer to our serjeants and corporals, and are called *hazildars* and *naivars*. There is also to each corps an English serjeant-major, drill and fure serjeant; to each battalion is a band of drums and fifes, and to

Seamen
II
SEAPOYS

each a pair of colours. A captain commands the whole.

Their jackets, which are made entirely after the European fashion, are of a red colour with yellow facings (as worn by all the infantry of the company on the Comorandel coast). The remaining part of their attire resembles more the country or Indian habit, and consists of a dark blue turban, broad and round at top, descending deep to the bottom, the sides of which, of a concave form, are crossed by a white band, running in front, fastened under a robe above. As an under garment, they have a jacket of linen. A dark blue sash girding, to answer the turban, goes round their middle. On the thighs they have short drawers, fastened by a scolloped band. Their legs are bare, which renders them more ready for action or service. Their arms are a musket and bayonet; their accoutrements or cross belts black leather, with pouches the same.

A battalion drawn out cannot but strike the spectators with a lively and fanciful military impression, as they unite in their exterior traits respectively Indian and European.

They are brought to the utmost exactness of discipline; go through their evolutions and manœuvres with a regularity and precision equal to, and not surpassed by European troops. In action they are brave and steady, and have been known to stand where Europeans have given way.

Their discipline puts them on a footing with European troops, with whom they are always ready to act in concert.

Their utility and services are evident: they secure to the company the internal good order and preservation of their territorial districts, which, though possible to be enforced with a strong hand by Europeans, requires numbers, and can only be conducted with that ease and address peculiar to the native forces of the country.

They are considered with respect in the eyes of the other natives, though they sufficiently, and with a good grace, feel and assert their own consequence. In large garrisons, where the duty is great, as Madras, Pondicherry, Trichinopoly, Vellore, &c. two or three battalions might best be present together, exclusive of Europeans. If sent singly up the country, they are liable to be detached, sometimes by one or more companies being sent to a station dependent on the chief garrison or headquarters, otherwise they are dispersed through the districts, four or five together, with a non-commissioned officer (this is a part of the service which is called *going on command*), on hills, or in villages, to preserve order, convey intelligence, and assist the salsalar, renter, or cutwall of the place, in cases of emergency. They also enforce the police, and prevent in such cases the country from being infested with thieves, which otherwise have combined, forming a banditti, to rob passengers and plunder cattle, of which there are so many instances upon record. As for such British officers in the company's service as are attached to battalions, they are obliged to follow the fortunes and destinations of their men, with their respective corps, leading a life often replete with adventures of a peculiar nature. An individual in such cases is frequently secluded from those of his own colour when up the country, or detached upon command, where in a frontier garrison or hill fort in the interior parts of India none but natives are to be

found. Here he might live as he pleases, being perfectly absolute within his jurisdiction. Such stations being lucrative, with management may produce great fortunes. Neither is the condition hard to a person conversant in the language of the country, or that of the Seapoys called *Moor*s (which most officers in the company's service acquire); otherwise the loss of society is not recompensed by other advantages, as you forget your own language, grow melancholy, and pass your days without comfort.

The peace establishment at Madras consists of 30 Seapoy battalions, but in time of war is augmented as occasion requires; or frequently each corps is strengthened by the addition of two companies, which are reduced again in time of peace, the officers remaining supernumeraries in the service. In garrison they are quartered in barracks: they live agreeably to the usage of the country, sleep on the ground on a mat or skin carpet. In their persons they are cleanly, but appear to beat advantage in their uniform. Off duty they go as the other natives in poor circumstances; and have only a cloth round their middle and over their shoulders. As to the different castes, the Moormen or Mussulmen assert pre-eminence, as coming into the country by conquest. In their persons they are rather robust, and in their tempers vindictive. Their religion and dress is distinct from the Hindoos, who are mild and passive in their temper, faithful, steady, and good soldiers. The Pariahs are inferior to the others, live under different circumstances, dwell in huts, and associate not on equal terms with the rest; they do all menial offices, are servants to Europeans, and think themselves happy when by them employed, though they are equally good Seapoys.

Having thus treated of the company's Seapoys, we shall observe that they are kindly attentive to their officers when often in circumstances requiring their assistance; are guilty of few vices; and have a strong attachment for those who have commanded them. That acute historian Dr Robertson has remarked, as a proof that the ingenuity of man has recourse in similar situations to the same expedients that the European powers, have, in forming the establishment of these native troops, adopted the same maxims, and, probably without knowing it, have modelled their battalions of Seapoys upon the same principles as Alexander the Great did his phalanx of Persians.

SEARCH-WARRANT, in *Law*, a kind of general warrant issued by justices of peace or magistrates of towns for searching all suspected places for stolen goods. In Scotland this was often done formerly; and in some English law-books there are precedents requiring the constable to search all such suspected places as he and the party complaining shall think convenient; but such practice is condemned by Lord Hale, Mr Hawkins, and the best authorities both among the English and Scotch lawyers. However, in case of a complaint, and oath made of goods stolen, and that the party suspects that those goods are in a particular house, and shows the cause of such suspicion, the justice may grant a warrant to search not only that house but other suspected places; and to attach the goods, and the party in whose custody they are found, and bring them before him or some other justice, to give an account how he came by them, and to abide such order as to law shall appertain; which

Searcher
II
Seafaring.

which warrant should be directed to the constable or other public officer, who may enter a suspected house and make search.

SEARCHER, an officer in the customs, whose business it is to search and examine ships outwards bound, if they have any prohibited goods on board, &c. (12 Car. II.). There are also searchers of leather, &c. See **AINAGER**.

SEARCHER, in ordnance, is an iron socket with branches, from four to eight in number, a little bent outwards, with small points at their ends; to this socket is fixed a wooden handle, from eight to twelve feet long, of about an inch and a quarter diameter. After the gun has been fired, this searcher is introduced into it, and turned round, in order to discover the cavities within. The distances of these cavities, if any be found, are then marked on the outside with chalk, when another searcher that has only one point, about which a mixture of wax and tallow is put, is introduced to take the impression of the holes; and if there be any hole, a quarter of an inch deep, or of any considerable length, the gun is rejected as unserviceable.

SEARCLOTH, or **CERECLOTH**, in *Surgery*, a form of external remedy somewhat harder than an unguent, yet finer than an emplaster, though it is frequently used both for the one and the other. The cerecloth is always supposed to have wax in its composition, which distinguishes and even denominates it. In effect, when a liniment or unguent has wax enough in it, it does not differ from a cerecloth.

SEASIN, in a ship, the name of a rope by which the boat rides by the ship's side when in harbour, &c.

SEASONING, the first illness to which persons habituated to colder climates are subject on their arrival in the West Indies. This seasoning, unless they live very temperately, or are in a proper habit of body (though some people are unmolested for many months), seldom suffers them to remain long before it makes its appearance in some mode or other; particularly if at first they expose themselves in a shower of rain, or too long in the sun, or in the night-air; or when the body is much heated, if they drink large draughts of cold liquors, or bathe in cold water; or use much exercise; or commit excess in drinking wine or spirits; or by heating the body and inflaming the blood; or by subjecting themselves to any cause that may suddenly check perspiration, which at first is generally excessive.

Some people, from a favourable state of body, are no seasoning. Thin people, and very young people, are most likely to escape it. Women generally do from their temperance, and perhaps their menstruation contributes to their security; indeed hot climates are favourable to the delicacy of their habits, and suitable to their modes of life. Some escape by great regularity of living; some, by the breaking out of the rash, called the *prickly heat*; some by a great degree of perspiration; and some by observing a cooling regimen. The disorders are various that constitute this seasoning of *new-comers* as they are called; depending on age, constitution, and habit of body. But all seasoning diseases are of the inflammatory kind; and yield to antiphlogistic treatment proportioned to their violence. When all precaution to guard against sickness has failed, and prudence proved abortive to new-comers, they will have this comfort at least for their pains, that their disorders

will seldom be severe or extensive, and will generally have a speedy termination; and that their suffering, as it is emphatically called, will be relieved by bleeding, a dose of salts, rest, and a cooling regimen.

SEASONING of Timber. See **TIMBER**.

SEASONS, in *Cosmography*, certain portions or quarters of the year, distinguished by the signs when the sun then enters, or by the meridian altitudes at the sun; consequent on which are different temperatures of the air, different works in tillage, &c. See **WATERS**.

The year is divided into four seasons, spring, summer, autumn, and winter. The beginnings and endings of each whereof, see under its proper article. It is to be observed, the seasons anciently began differently from what they now do: witness the old verses,

Dat Clonens helem; dat Petrus zer cathedraus;
Afshat Urbanus; autumnat Bartholomeus.

SEAT, in the manege, is the posture or situation of a horseman upon the saddle.

SEATON, a small fishing town on the south coast of Devon, between Lyme and Sidmouth. Ritton says "our learned antiquarians would have it to be that *Maridanum* whereof Antonine speaks, placed between *Dunnowaria* and *Ilica*; for *Maridanum* in British is the same with *Seaton* in English, "a town upon a hill by the sea-side." This place is memorable for the Danish princes landing there in the year 937.

SEBACIC ACID, so called, because it is procured from fat. For an account of its preparation and properties, see **CHEMISTRY**, page 540, and N^o 822.

St SEBASTIAN, a handsome, populous, and strong town in Spain, in the province of Guipulco, with a good and well frequented harbour. It is seated at the foot of a mountain; and the harbour secured by two moles, and a narrow entrance for the ships. The town is surrounded with a double wall, and to the sea-side is fortified with bastions and half moons. The streets are long, broad, and straight, and paved with white flagstones. At the top of the mountain is a citadel, with a garison well furnished with cannon. The town carries on a considerable trade, the greatest part of which consists of iron and steel, which some reckon to be the best in Europe. They also deal in wood, which comes from Old Castile. W. Long. 1. 59. N. Lat. 42. 23.—The capital of Brazil in South America is likewise called *Sebastian*.

SEBASTIANO, called *Del Piombo*, from an office in the lead mines given him by Pope Clement VII. was an eminent Venetian painter, born in 1485. He was first a disciple of old Giovanni Bellino; continued his studies under Giorgione; and having attained an excellent manner of colouring, went to Rome, where he ingenuited himself into the favour of Michael Angelo. He has the name of being the first who invented the art of preparing plaster walls for oil-painting; but was to slow and lazy in his work, that other hands were often employed to finish what he began. He died in 1547.

SEBESTEN. See **CORDIA**, **BOTANY Indes**.

SEBU,II, a sect among the ancient Samaritans, whom St Epiphanius accuses of changing the time expressed in the law, for the celebration of the great annual feasts of the Jews.

Maleses
Tropical
Diseases.

St
C
I

Seburai
||
Se alu.

SEBURAI, SEBURAI, a name which the Jews give to fuch of their rabbins or doctors as lived and taught fome time after the finishing of the Talmud.

SECACUL, in the *Materia Medica* of the ancients, a name given by Avicenna, Serapion, and others, to a root which was like ginger, and was brought from the East Indies, and ufed as a provocative to venery. The interpreters of their works have rendered this word *eringo*; and hence fome have fuppofed that our *eryngion* or *eryngo* was the root meant by it: but this does not appear to be the cafe on a ftrict inquiry, and there is fome reafon to believe that the famous root, at this time called *gingeng*, was what they meant.

SECALE, RYE, a genus of plants belonging to the triandria clafs; and in the natural method ranking under the 4th order, *Gramina*. See BOTANY and AGRICULTURE Index.

The *secale*, or common rye, has glumes with rough finges. It is a native of the ifland of Candia, was introduced into England many ages ago, and is the only fpecies of rye cultivated in this kingdom. There are, however, two varieties, the winter and fpring rye.

The winter rye, which is larger in the grain than the fpring rye, is fown in autumn at the fame time with wheat, and fometimes mixed with it; but as the rye ripens fooner than the wheat, this method mult be very exceptionable. The fpring rye is fown along with the oats, and usually ripens as foon as the winter rye; but the grain produced is lighter, and it is therefore feldom fown except where the autumnal crop has failed.

Rye is commonly fown on poor, dry, limestone, or fandy foils, where wheat will not thrive. By continuing to fow it on fuch a foil for two or three years, it will at length ripen a month earlier than that which has been raised for years on strong cold ground.

Rye is commonly ufed for bread either alone or mixed with wheat. This mixture is called *meslin*, and was formerly a very common crop in fome parts of Britain. Mr Marshall tells us, that the farmers in Yorkfhire believe that this mixed crop is never affected by mildew, and that a fmall quantity of rye fown among wheat will prevent this destructive difeafe. Rye is much ufed for bread in fome parts of Sweden and Norway by the poor people. About a century ago rye-bread was alfo much ufed in England; but being made of a black kind of rye, it was of the fame colour, clammy, very detergent, and confequently not fo nourifhing as wheat.

Rye is fubject to a difeafe which the French call *ergot*, and the English *horned rye*; which fometimes happens when a very hot fummer fucceeds a rainy fpring. According to Tilbot, horned rye is fuch as fuffeers an irregular vegetation in the middle fubftance between the grain and the leaf, producing an excrescence of a brownifh colour, about an inch and a half long, and two-tenths of an inch broad. Bread made of this kind of rye has a naufeous acrid tafte, and produces fpafmodic and gangrenous diforders. In 1596, an epidemic difeafe prevailed in Hefle, which the phyficians afcribed to bread made of horned rye. Some, we are told, were feized with an epilepsy, and thefe feldom ever re-

covered; others became lunatic, and continued flupid the reft of their lives: thofe who apparently recovered had annual returns of their diforder in January and February; and the difeafe was faid to be contagious at leaft in a certain degree. The facts which we have now mentioned are taken from a work of Tilbot, which was never printed. The fame difeafe was occafioned by the ufe of this bread in feveral parts of the continent in the years 1648, 1675, 1702, 1716, 1722, and 1736; and has been very minutely defcribed by Hoffman, A. O. Goelicke, Vater Burghart, and J. A. Slink.

In the year 1709, one fourth part of all the rye raised in the province of Salonia in France was horned, and the furgeon to the hospital of Orleans had no lefs than 500 patients under his care that were diftempered by eating it: They were called *ergots*, from *ergot* (λ), the French name for horned rye; they confifted chiefly of men and boys, the number of women and girls being very fmall. The firft fymptom was a kind of drunkennets, then the local diforder began in the toes, and thence extended fometimes to the thigh, and the trunk itfelf, even after amputation, which is a good argument againft that operation before the gangrene is flopped.

In the year 1710, the celebrated Fontenelle describes a cafe in the History of the Academy of Sciences of France, which exactly refembles that of the poor family at Wattifham. A peasant at Elois, who had eaten horned rye in bread, was feized with a mortification which firft caufed all the toes of one foot to fall off, then the toes of the other, afterwards the remainder of the feet, and, laftly, it ate off the flefh of both his legs and thighs, leaving the bones bare.

Horned rye is not only hurtful to man, but to other animals; it has been known to destroy even the filks that fettled upon it; fheep, dogs, deer, geefe, ducks, fwine, and poultry, that were led with it for experiment, died miferably, fome convulfed, others mortified and ulcerated.

SECANT, in *Geometry*, a line that cuts another or divides it into parts. The fecant of a circle is a line drawn from the circumference on one fide to a point without the circumference on the other; and it is demonftrated by geometers, that of feveral fecants drawn to the fame point, that is the longeft which paffes through the centre of the circle. The portions, however, of thefe feveral fecants that are without the circle are fo much the greater as they recede from the centre, and the leaft external portion is of that fecant which paffes through it.

SECANT, in *Trigonometry*, denotes a right line drawn from the centre of a circle, which, cutting the circumference, proceeds till it meets with a tangent to the fame circle. See GEOMETRY.

Line of SECANTS, one of thofe lines or feales which are usually put upon fectors. See SECTOR, n^o 12.

SECEDERS, a numerous body of Prebiterians in Scotland, who have withdrawn from the communion of the eftablifhed church. As they take up their ground

Secale
||
Secedens

(A) *Ergot* is French for a cock's spur, and horned rye was called *ergot* from the refemblance of its excrescence to that part.

Seceders. ground upon the establishment of religion from 1638 to 1650, which they hold to be the parent period of the Scottish church, we shall introduce our account of them by a short view of ecclesiastical history from that period to the era of their secession. With our usual candour and impartiality we mean to give a fair statement of those events with which, as they lay, their secession is connected.

James I. having for some time previous to his death entertained a wish to form the church of Scotland as much as possible upon the model of that in England, his son Charles, with the assistance of Archbishop Laud, endeavoured to carry the design into execution, by establishing canons for ecclesiastical discipline, and introducing a liturgy into the public service of the church.—Numbers of the clergy and laity of all ranks took the alarm at what they considered to be a bold and dangerous innovation; and after frequent applications to the throne, they at last obtained the royal proclamation for a free parliament and general assembly. The assembly met in 1638, and began their labours with a repeal of all the acts of the six preceding parliaments, which had favoured the designs of James. They condemned the liturgy, together with every branch of the hierarchy. They cited all the Scottish bishops to their bar; and after having excommunicated nine of them, and deposed five from their episcopal office, they restored kirk-sessions, presbyteries, and synods provincial as well as national. See PRESBYTERIANS.

These proceedings were ratified by the parliament which met in 1640. The law of patronage was in full force for several years after this period; yet great care was taken that no minister should be obtruded on the Christian people contrary to their inclinations; and in 1649 it was abolished as an oppressive grievance.

The restoration of Charles II. in 1660 changed the face of affairs in the church of Scotland. All that the general assembly had done from 1638 to 1650 was rendered null and void, the covenants were pronounced to be unlawful, episcopacy was restored, and the king was declared to be the supreme head of the church in all causes civil and ecclesiastical. During this period the Presbyterians were subjected to fines and imprisonment, while numbers of them were publicly executed for their adherence to their political and religious tenets.

The Revolution in 1688 gave a different turn to the affairs of the church. The first parliament which met after that event, abolished prelacy and the king's supremacy in ecclesiastical affairs. They ratified the Westminster Confession of Faith, together with the Presbyterian form of church-government and discipline, "as agreeable to the word of God, and most conducive to the advancement of true piety and godliness, and the establishment of peace and tranquillity within these realms." That same parliament abolished patronage, and lodged the election of ministers in the hands of heritors and elders, with the consent of the congregation.

In the reign of Queen Anne the true Protestant religion was ratified and established, together with the Presbyterian form of church-government and discipline; and the unalterable continuance of both was declared to be an essential condition of the union of the two kingdoms in all time coming. In 1712 the law respecting patronage was revived, in resentment, it has been said,

of that warm attachment which the church of Scotland discovered to the family of Hanover; but the severity of that law was greatly mitigated by the first parliament of George I. stat. 50. by which it is enacted, that, if the pretence do not signify his acceptance, the presentation shall become void and null in law. The church, however, did not avail herself of this statute; and an event which happened not many years afterwards gave rise to the *secession*.

In 1732 more than 40 ministers presented an address to the general assembly, specifying in a variety of instances what they considered to be great defections from the established constitution of the church, and craving a redress of these grievances. A petition to the same effect, subscribed by several hundreds of elders and private Christians, was offered at the same time; but the assembly refused a hearing to both, and enacted, that the election of ministers to vacant charges, where an accepted presentation did not take place, should be competent only to a conjunct meeting of elders and heritors, being Protestants. To this act many objections were made by numbers of ministers and private Christians. They asserted that more than 30 to one in every parish were not possessed of landed property, and were on that account deprived of what they deemed their natural right to choose their own pastors. It was also said, that this act was extremely prejudicial to the honour and interest of the church, as well as to the edification of the people; and in fine, that it was directly contrary to the appointment of Jesus Christ, and the practice of the apostles, when they filled up the first vacancy in the apostolic college, and appointed the election of deacons and elders in the primitive church.—Many of those also who were thought to be the best friends of the church, expressed their fears that this act would have a tendency to overturn the ecclesiastical constitution which was established at the Revolution.

Mr Ebenezer Erskine, minister at Stirling, distinguished himself by a bold and determined opposition to the measures of the assembly in 1732. Being at that time moderator of the synod of Perth and Stirling, he opened the meeting at Perth with a sermon from Psalm cxviii. 22. "The stone which the builders rejected is become the head stone of the corner." In the course of his sermon he remonstrated with no small degree of freedom against the act of the preceding assembly with regard to the settlement of ministers, and alleged that it was contrary to the word of God and the established constitution of the church. A formal complaint was lodged against him for uttering several offensive expressions in his sermon before the synod. Many of the members declared that they heard him utter nothing but sound and reasonable doctrine; but his accusers insisting on their complaint, obtained an appointment of a committee of synod to collect what were called the offensive expressions, and to lay them before the next diet in writing. This was done accordingly; and Mr Erskine gave in his answers to every article of the complaint. After three days warm reasoning on this affair, the synod by a majority of six found him censurable; against which sentence he protested, and appealed to the next general assembly. When the assembly met in May 1733, it affirmed the sentence of the synod, and appointed Mr Erskine to be rebuked

Seceders.

Origin of

They op.
to the
measures of
the general
assembly.For wh. he
appealed.
1733

Seceders

and admitted from the chair. Upon which he protested, that, as the assembly had found him censurable, and had rebuked him for doing what he conceived to be agreeable to the word of God and the standards of the church, he should be at liberty to preach the same truths, and to testify against the same or similar evils, on every proper occasion. To this protest Messrs William Wilson minister at Perth, Alexander Moncrief minister at Abernethy, and James Filmer minister at Kinclaven, gave in a written adherence, under the form of instrument; and these four withdrew, intending to return to their respective charges, and act agreeably to their protest whenever they should have an opportunity. Had the affair rested here, there never would have been a secession; but the assembly resolving to carry on the process, cited them by their officer to compare next day. They obeyed the citation; and a committee was appointed to retire with them, in order to persuade them to withdraw their protest. The committee having reported that they still adhered to their protest, the assembly ordered them to appear before the commission in August following and retract their protest; and if they should not comply and testify their sorrow for their conduct, the commission was empowered to suspend them from the exercise of their ministry, with certification that if they should act contrary to said sentence, the commission should proceed to a higher censure.

Suspended from the exercise of their office

The commission met in August accordingly; and the four ministers still adhering to their protest, were suspended from the exercise of their office, and cited to the next meeting of the commission in November following. From this sentence several ministers and elders, members of the commission, dissented. The commission met in November, and the suspended ministers compared. Addresses, representations, and letters from several synods and presbyteries, relative to the business now before the commission, were received and read. The synods of Dumfries, Murray, Ross, Angus and Meams, Perth and Stirling, craved that the commission would delay proceeding to a higher censure. The synods of Galloway and Fife, as also the presbytery of Dornoch, addressed the commission for lenity, tenderness, and forbearance, towards the suspended ministers; and the presbytery of Aberdeen represented, that in their judgement, the sentence of suspension inflicted on the fore-said ministers was too high, and that it was a stretch of ecclesiastical authority. Many members of the commission reasoned in the same manner, and alleged that the act and sentence of last assembly did not oblige them to proceed to a higher censure at this meeting of the commission. The question, however, was put, Proceed to a higher censure, or not? and the votes being numbered, were found equal on both sides: upon which Mr John Goldie the moderator gave his calling vote to proceed to a higher censure: which stands in their minutes in these words: "The commission did and hereby do lose the relation of Mr Ebenezer Esikine minister at Stirling, Mr William Wilson minister at Perth, Mr Alexander Moncrief minister at Abernethy, and Mr James Filmer minister at Kinclaven, to their respective charges, and declare them no longer ministers of the church; and do hereby prohibit all ministers of this church to employ them, or any of them, in any ministerial function. And the commission do declare the

churches of the said ministers vacant from and after the date of this sentence."

Seceders

This sentence being intimated to them, they protested, that their ministerial office and relation to their respective charges should be held as valid as if no such sentence had passed; and that they were now obliged to make a *secession* from the prevailing party in the ecclesiastical courts; and that it shall be lawful and warrantable for them to preach the gospel, and discharge every branch of the pastoral office, according to the word of God and the established principles of the church of Scotland. Mr Ralph Esikine minister at Dunfermline, Mr Thomas Nairn minister at Orwell, Mr John McLaren minister at Edinburgh, Mr John Currie minister at Kinglassie, Mr James Wardlaw minister at Dunfermline, and Mr Thomas Nairn minister at Abbotshall, protested against the sentence of the commission, and that it should be lawful for them to complain of it to any subsequent general assembly of the church.

The secession properly commenced at this date. And accordingly the ejected ministers declared in their protest that they were laid under the disagreeable necessity of seceding, not from the principles and constitution of the church of Scotland, to which, they said, they steadfastly adhered, but from the present church-courts, which had thrown them out from ministerial communion. The assembly, however, which met in May 1734 did so far modify the above sentence, that they empowered the synod of Perth and Stirling to receive the ejected ministers into the communion of the church, and restore them to their respective charges; but with this express direction, "that the said synod should not take upon them to judge of the legality or formality of the former procedure of the church judicatories in relation to this affair, or either approve or censure the same." As this appointment neither condemned the act of the preceding assembly nor the conduct of the commission, the seceding ministers considered it to be rather an act of grace than of justice, and therefore they said they could not return to the church-courts upon this ground; and they published to the world the reasons of their refusal, and the terms upon which they were willing to return to the communion of the established church. They now erected themselves into an ecclesiastical court, which they called the *Associated Presbytery*, and preached occasionally to numbers of the people who joined them in different parts of the country. They also published what they called an *Act, Declaration, and Testimony*, to the doctrine, worship, government, and discipline of the church of Scotland, and against several instances, as they said, of defection from these, both in former and in the present times. Some time after this several ministers of the established church joined them, and the *Associated Presbytery* now consisted of eight ministers. But the general assembly which met in 1738 finding that the number of Seceders was much increased, ordered the eight ministers to be served with a libel, and to be cited to the next meeting of the assembly in 1739. They now appeared at the bar as a constituted presbytery, and having formally declined the assembly's authority, they immediately withdrew. The assembly which met next year deposed them from the office of the ministry; which, however, they continued to exercise in their respective congregations, who still adhered to them, and erected meeting houses, where they preached till

and deposed

their death. Mr James Fisher, the last survivor of them, was, by an unanimous call in 1731, translated from Edinburgh to Glasgow, where he continued in the exercise of his ministry among a numerous congregation, respected by all ranks in that large city, and died in 1775 much regretted by his people and friends. In 1745 the seceding ministers were become so numerous, that they were erected into three different presbyteries, under one synod, when a very unprofitable dispute divided them into two parties.

The burghs oath in some of the royal boroughs of Scotland contains the following clause: "I profess and allow with my heart the true religion presently professed within this realm, and authorized by the laws thereof. I will abide at and defend the same to my life's end, renouncing the Romish religion called *Papistry*." Messrs Ebenezer and Ralph Erskine, James Fisher, and others, affirmed that this clause was no way contrary to the principles on which the secession was formed, and that therefore every Seceder might lawfully swear it. Messrs Alexander Moncrief, Thomas Mair, Adam Gib, and others, contended on the other hand that the swearing of the above clause was a virtual renunciation of their testimony. And this controversy was so keenly agitated, that they split into two different parties, and now met in different synods. Those of them who assert the lawfulness of swearing the burghs oath are called *Burghers*, and the other party who condemn it are called *Antiburgher Seceders*. Each party claiming to itself the lawful constitution of the *Affiliate Synod*, the Antiburghers, after several previous steps, excommunicated the Burghers on the ground of their sin and of their contumacy in it. This rupture took place in 1747, since which period no attempts to effect a reunion have been successful. They remain under the jurisdiction of different synods, and hold separate communion, although much of their former hostility has been laid aside. The Antiburghers consider the Burghers as too lax and not sufficiently steadfast to their testimony. The Burghers on the other hand contend that the Antiburghers are too rigid, in that they have introduced new terms of communion into the society. The Antiburghers having adopted ideas with regard to what they call *covenanting*, which the Burghers never approved (A), have been in use of renewing in their several congregations the Scottish Covenant, by causing their people formally swear to maintain it. In other respects the differences between the two parties are not material. The Antiburghers are most numerous on

the north of the Tay, and the Burghers on the south of it.

What follows in this article is a further account of those who are commonly called the *Burgher Seceders*.¹ These have a greater number of people in their communion than the Antiburghers, and for some years past they have greatly increased in the southern and western districts of Scotland. As there were among them from the commencement of their secession several students who had been educated at one or other of the universities, they appointed one of their ministers to give lectures in theology, and train up candidates for the ministry. Messrs William Wilson minister at Perth and Alexander Moncrief minister at Abernethy were their professors of theology before their separation from the Antiburghers.

Since that period Mr Ebenezer Erskine minister at Stirling, Mr James Fisher minister at Glasgow, Mr John Swanton minister at Kinross, and Mr John Brown minister at Haddington, have succeeded each other in this office. At present Mr George Lawson minister at Selkirk is their professor of theology, and there are between thirty and forty students who attend his lectures annually. The number of their ministers is about an hundred, and each of their congregations contains from two hundred and fifty to three thousand persons; and there are among them at present more than twenty vacant charges. Where a congregation is very numerous, as in Stirling, Dunfermline, and Perth, it is formed into a collegiate charge, and provided with two ministers. They are erected into six different presbyteries, united in one general synod, which commonly meets at Edinburgh in May and September (B). They have also a synod in Ireland composed of three or four different presbyteries. They are legally tolerated in Ireland; and government some years ago granted 500l. per annum, and of late an additional 500l. which, when divided among them, affords to each minister about 20l. over and above the stipend which he receives from his hearers. There have besides a presbytery in Nova Scotia; and some years ago, it is said, that the Burgher and the Antiburgher ministers residing in the United States formed a coalition and joined in a general synod, which they call the *Synod of New York and Pennsylvania*. They all preach the doctrines contained in the Westminster Confession of Faith and Catechisms, as they believe they to be founded on the sacred scriptures. They catechise their hearers publicly, and visit them from house to house once every year.

(A) This is the account which the Burghers give of their own notions respecting the covenant. One of the most enlightened of their opponents, however, assures us that they acknowledge covenanting to be a *moral duty*, and that the solemn vows of our ancestors are obligatory. But since the breach in the synod they have never engaged in this work; giving, as their reason, that this is not the proper season.

(B) The constitution of the Antiburgher church differs very little from that of the Burghers. The supreme court among them is denominated *The General Affiliate Synod*, having under its jurisdiction three provincial synods in Scotland and one in Ireland. In the former country there are eleven presbyteries; in the latter, four. They have a few congregations in England, and a ministry in connection with them in North America. The number of ministers belonging to the general synod is a hundred and thirty-seven; and in Scotland there are nineteen vacancies. They, as well as the Burgher Seceders, have a professor of theology, who lectures every candidate for the office of a preacher is obliged to attend, we have been told, for no less than five or six sessions! Surely the session must be of short duration.

Seceders. year. They will not give the Lord's supper to those who are ignorant of the principles of the gospel, nor to such as are scandalous and immoral in their lives. They condemn private baptism, nor will they admit those who are grossly ignorant and profane to be sponsors for their children. Believing that the people have a natural right to choose their own pastors, the settlement of their ministers always proceeds upon a popular election; and the candidate who is elected by the majority is ordained among them. Convinced that the charge of souls is a trust of the greatest importance, they carefully watch over the morals of their students, and direct them to such a course of reading and study as they judge most proper to qualify them for the profitable discharge of the pastoral duties. At the ordination of their ministers they use a *formula* of the same kind with that of the established church, which their ministers are bound to subscribe when called to it; and if any of them teach doctrines contrary to the Scriptures or the Westminster Confession of Faith, they are sure of being thrown out of their communion. By this means uniformity of sentiment is preserved among them; nor has any of their ministers, excepting one, been prosecuted for error in doctrine since the commencement of their secession.

11
Their rules
of faith,

They believe that the holy scriptures are the sole criterion of truth, and the only rule to direct mankind to glorify and enjoy God, the chief and eternal good; and that "the Supreme Judge, by which all controversies of religion are to be determined, and all the decrees of councils, opinions of ancient writers, doctrines of men and private spirits, are to be examined, and in whose sentence we are to rest, can be no other but the Holy Spirit speaking in the Scriptures." They are fully persuaded, however, that the standards of public authority in the church of Scotland exhibit a just and consistent view of the meaning and design of the holy scriptures with regard to doctrine, worship, government, and discipline; and they in so far differ from the dissenters in England, in that they hold these standards to be not only articles of peace and a test of orthodoxy, but as a bond of union and fellowship. They consider a simple declaration of adherence to the scriptures as too equivocal a proof of unity in sentiment, because Arians, Socinians, and Arminians, make such a confession of their faith, while they retain sentiments which they (the Seceders) apprehend are subversive of the great doctrines of the gospel. They believe that Jesus Christ is the only King and Head of the Church, which is his body; that it is his sole prerogative to enact laws for the government of his kingdom, which is not of this world; and that the church is not possessed of a legislative, but only of an executive power, to be exercised in explaining and applying to their proper objects and ends those laws which Christ hath published in the scriptures. Those doctrines which they teach relative to faith and practice are exhibited at great length in an explanation of the Westminster Assembly's Shorter Catechism, by way of question and answer, in two volumes, composed chiefly by Mr James Fisher late of Glasgow, and published by desire of their synod.

For these 50 years past, the grounds of their secession, they allege, have been greatly enlarged by the public admissions of the established church, and particularly by the uniform execution of the law respecting patro-

nage, which, they say, has obliged many thousands of private Christians to withdraw from the parish-churches and join their society.

It is certain, however, that their number has rapidly increased of late, especially in the large cities of the kingdom. They have three different congregations in Edinburgh, two in Glasgow, and two in London, besides several others in the north of England. In most of their congregations they celebrate the Lord's supper twice in the year, and they catechise their young people concerning their knowledge of the principles of religion previous to their admission to that sacrament. When any of them fall into the sin of fornication or adultery, the scandal is regularly purged according to the form of process in the established church; and those of the delinquents who do not submit to adequate censure are publicly declared to be fugitives from discipline, and are expelled the society. They never accept a sum of money as a commutation for the offence. They condemn all clandestine and irregular marriages, nor will they marry any persons unless they have been proclaimed in the parish-church on two different Lord's days at least.

When they separated from the established church, and they remained firm in their attachment to the state; and they were not many years formed into a distinct society when they expelled from their communion a Mr Thomas Nairn minister at Kirkealdy, who had taught doctrines inimical to the civil government of the nation. In 1745 there was not one of their number who joined the pretender to the British crown. They are still of the same sentiments; and in their public assemblies they always pray for our sovereign King George, with the royal family, and for all who are in authority under them. They are so far from wishing the overthrow of the present civil government, that when the nation was lately in danger of being thrown into a fermentation by the circulation of inflammatory and seditious writings, they warmly recommended peace and order in society. The same remarks, we believe, are equally applicable to the Anti-burgher seceders. No legal disqualifications, as in the case of the dissenters in England, exclude them from any place of public trust in the municipal government of the country; and some of them are frequently in the magistracy of the royal boroughs. They are not, however, legally tolerated, but are supported by the mildness of administration and the liberal spirit of the times. Avowing their adherence to the doctrines contained in the public standards of the church of Scotland, together with the presbyterian form of government, from which they never intend to secede, they deny that they are either schismatics or sectaries, as they have been frequently called: and when they withdrew from the ecclesiastical courts, they did not, they say, constitute a church of their own, different from the national church, but profess to be a part of that church, endeavouring to hold by her reformed principles, in opposition to those deviations from them which they have specified in their *Act and Testimony*. Most of them live in habits of friendship and intimacy with their brethren of the establishment, and they profess an affectionate regard for all those of every denomination who love Jesus Christ in sincerity and truth. In the late re-exhibition of their testimony, they have declared to the world, that, were the grounds of their secession happily removed, they would account it one of the most singular felicities of their

12
and politi-
cal princi-
ples

13
Their mo-
deration

Sechium
 II
 Secker.

their time to return with pleasure to the communion of the established church.

SECIUM, a genus of plants belonging to the monocotyledonous class; and in the natural method ranking under the 34th order, *Cucurbitaceae*. See BOTANY Index.

SECKENDORF, GUY LEWIS DE, a very learned German, descended from an ancient and noble family, was born at Aurach in Franconia in 1626. He was a good linguist, learned in law, history, and divinity; and is said to have been a tolerable painter and engraver. He was honourably employed by several of the German princes; and died counsellor of state to Frederick III. elector of Brandenburg, and chancellor of the university of Halle, in 1692. He wrote many books, particularly "A history and defence of the Lutheran religion," 2 vols folio, Frankfort, 1602, in Latin.

SECKER, THOMAS, a learned and respectable prelate of the church of England, was born, in 1693, at a village called *Silthorp*, in the vale of Belvoir, in Nottinghamshire. His father was a Protestant dissenting, a pious, virtuous, and sensible man; who, having a small paternal fortune, followed no profession. His mother was the daughter of Mr Brough, a substantial gentleman farmer of Shelton in the same county. He received his education at several private schools and academies in the country, being obliged, by various accidents, frequently to change his masters.

Notwithstanding this disadvantage, he had at the age of 19 not only made considerable progress in Greek and Latin, and read the best writers in both languages, but had acquired a knowledge of French, Hebrew, Chaldee, and Syriac; had learned geography, logic, algebra, geometry, conic sections, and gone through a course of lectures on Jewish antiquities and other points, preparatory to the critical study of the Bible. He had been destined by his father for orders among the Dissenters. With this view, during the latter years of his education, his studies were chiefly turned towards divinity, in which he had made such quick advances, that by the time he was 23 he had carefully read over a great part of the Scriptures, particularly the New Testament, in the original, and the best comments upon it; Eusebius's Ecclesiastical History, The Apostolical Fathers, Whiston's Primitive Christianity, and the principal writers for and against Ministerial and Lay Conformity.—But though the result of these inquiries was a well-grounded belief of the Christian revelation, yet not being at that time able to decide on some arbitrary speculative doctrines, nor to determine absolutely what communion he should embrace; he resolved, like a wise and honest man, to pursue some profession, which should leave him at liberty to weigh those things more maturely in his thoughts, and not oblige him to declare or teach publicly opinions which were not yet thoroughly settled in his own mind.

In 1716, therefore, he applied himself to the study of physic, and after gaining all the medical knowledge he could, by reading the usual preparatory book, and attending the best lectures during that and the following winter in London, in order to improve himself farther, in January 1718-19 he went to Paris. There he lodged in the same house with the famous anatomist Mr Winslow, whose lectures he attended, as he did those of the materia medica, chemistry, and botany, at the king's

gardens. He saw the operations of surgery at the *Hôtel Dieu*, and attended also for some time M. Grogon, the accoucheur, but without any design of ever settling that or any other branch of surgery. Here he became acquainted with Mr Martin Benton, afterwards bishop of Gloucester, one of the most agreeable and virtuous men of his time; with whom he quickly became much connected, and not many years after was united to him by the strictest bonds of affinity as well as affection.

During the whole of Mr Secker's continuance at Paris, he kept up a constant correspondence with Mr Joseph Butler, afterwards bishop of Durham, with whom he became acquainted at the academy of orator Mr Jones, kept first at Gloucester, and afterwards at Fewkbury. Mr Butler having been appointed preacher at the Rolls on the recommendation of Dr Cloke and Mr Edward Talbot, son to Bishop Talbot, he now took occasion to mention his friend Mr Secker, without Secker's knowledge, to Mr Talbot, who promised, in case he chose to take orders in the church of England, to engage the bishop his father to provide for him. This was communicated to Mr Secker in a letter from Mr Butler about the beginning of May 1720. He had not at that time come to any resolution of quitting the study of physic; but he began to foresee many obstacles to his pursuing that profession; and having never discontinued his application to theology, his former difficulties both with regard to conformity and some other doubtful points had gradually lessened, as his judgement became stronger, and his reading and knowledge more extensive. It appears also from two of his letters still in being, written from Paris to a friend in England, (both of them prior to the date of Mr Butler's above mentioned), that he was greatly dissatisfied with the divisions and disturbances which at that particular period prevailed among the Dissenters.

In this state of mind Mr Butler's unexpected proposal found him; which he was therefore very well disposed to take into consideration; and after deliberating on the subject of such a change for upwards of two months, he resolved at length to embrace the offer, and for that purpose quitted France about the beginning of August 1720.

On his arrival in England, he was introduced to Mr Talbot, with whom he cultivated a close acquaintance; but it was unfortunately of very short duration; for in the month of December that gentleman died of the smallpox. This was a great shock to all his friends, who had justly conceived the highest expectations of him; but especially to an amiable lady whom he had lately married, and who was very near sinking under so sudden and grievous a stroke. Mr Secker, beside sharing largely in the common grief, had peculiar reason to lament an accident that seemed to put an end to all his hopes; but he had taken his resolution, and he determined to persevere. It was some encouragement to him to find that Mr Talbot had, on his death bed, recommended him, together with Mr Benson and Mr Butler, to his father's notice. Thus did that excellent young man (for he was but 29 when he died), by his nice discernment of characters, and his considerate good nature, provide most effectually, in a few sensible moments, for the welfare of that church from which he himself was so prematurely snatched away; and at the

Secker.

Secker. Some time raised up, when he least thought of it, the truest friend and protector to his wife and unborn daughter; who afterwards found in Mr Secker all that tender care and assistance which they could have hoped for from the nearest relation.

It being judged necessary by Mr Secker's friends that he should have a degree at Oxford; and having been informed, that if he should previously take the degree of Doctor in Physic at Leyden, it would probably help him in obtaining the other, he went over and took his degree there in March 1721: and, as part of his exercise for it, he composed and printed a dissertation *de Medicina Statica*, which is still extant, and is thought by the gentlemen of that profession to be a sensible and learned performance.

In April the same year, he entered himself a gentleman commoner of Exeter college, Oxford; after which he obtained the degree of Bachelor of Arts, in consequence of the chancellor's recommendatory letter to the convocation.

He now spent a considerable part of his time in London, where he quickly gained the esteem of some of the most learned and ingenious men of those days, particularly of Dr Clarke, rector of St James's, and the celebrated Dean Berkeley, afterwards bishop of Cloyne, with whom he every day became more delighted, and more closely connected. He paid frequent visits of gratitude and friendship to Mrs Talbot, widow of Mr Edward Talbot, by whom she had a daughter five months after his decease. With her lived Mrs Catharine Benson, sister to Bishop Benson, whom in many respects she greatly resembled. She had been for several years Mrs Talbot's inseparable companion, and was of unspokeable service to her at the time of her husband's death, by exerting all her courage, activity, and good sense (of which she possessed a large share), to support her friend under so great an affliction, and by afterwards attending her sickly infant with the utmost care and tenderness, to which, under Providence, was owing the preservation of a very valuable life.

Bishop Talbot being in 1721 appointed to the see of Durham, Mr Secker was in 1722 ordained deacon by him in St James's church, and priest not long after in the same place, where he preached his first sermon March 28. 1723. The bishop's domestic chaplain at that time was Dr Rundle, a man of warm fancy and very brilliant conversation, but apt sometimes to be carried by the vivacity of his wit into indifereet and ludicrous expressions, which created him enemies, and, on one occasion, produced disagreeable consequences.—With him Mr Secker was soon after associated in the bishop's family, and both taken down by his lordship to Durham in July 1723.

In the following year the bishop gave Mr Secker the rectory of Houghton-le-Spring. This preferment putting it in his power to fix himself in the world, in a manner agreeable to his inclinations, he soon after made a proposal of marriage to Mrs Benson; which being accepted, they were married by Bishop Talbot in 1725. At the earnest request of both, Mrs Talbot and her daughter consented to live with them, and the two families from that time became one.

About this time Bishop Talbot also gave preferments to Mr Butler and Mr Benson, whose rise and progress in the church is here interwoven with the history of

Mr Secker. In the winter of 1725-6, Mr Butler first published his incomparable sermons; on which, as Dr Beilby Porteus and Dr Stinton inform us, Mr Secker took pains to render the style more familiar, and the author's meaning more obvious; yet they were at last by many called obscure. Mr Secker gave his friend the same assistance in that noble work the *Analogy of Religion*, &c.

He now gave up all the time he possibly could to his residence at Houghton, applying himself with alacrity to all the duties of a country clergyman, and supporting that useful and respectable character throughout with the strictest propriety. He omitted nothing which he thought would be of use to the souls and bodies of the people entrusted to his care. He brought down his conversation and his sermons to the level of their understandings; he visited them in private, he catechised the young and ignorant, he received his country neighbours and tenants very kindly and hospitably, and was of great service to the poorer sort of them by his skill in physic, which was the only one he ever made of it. Though this place was in a very remote part of the world, yet the solitude of it perfectly suited his studious disposition, and the income arising from it bounded his ambition. Here he would have been content to live and die; here, as he has often been heard to declare, he spent some of the happiest hours of his life; and it was no thought or choice of his own that removed him to a higher and more conspicuous situation; but Mrs Secker's health, which now began to decline, and was thought to be injured by the dampness of the situation, obliged him to think of exchanging it for a more healthy one. Accordingly, an exchange was made through the friendly interposition of Mr Benson (who generously sacrificed his own interest on this occasion, by relinquishing a pretend of his own to serve his friend) with Dr Finney, prebendary of Durham, and rector of Ryton; and Mr Secker was instituted to Ryton and the prebend June 3. 1727. For the two following years he lived chiefly at Durham, going every week to officiate at Ryton, and spending there two or three months together in the summer.

In July 1732 he was appointed chaplain to the king; for which favour he was indebted to Dr Sherlock, who having heard him preach at Bath, had conceived the highest opinion of his abilities, and thought them well worthy of being brought forward into public notice. From that time an intimacy commenced between them, and he received from that great prelate many solid proofs of esteem and friendship.

His month of waiting at St James's happened to be August, and on Sunday the 27th of that month he preached before the queen, the king being then abroad. A few days after, her majesty sent for him into her closet, and held a long conversation with him; in the course of which he took an opportunity of mentioning to her his friend Mr Butler. He also, not long after this, on Mr Talbot's being made lord chancellor, found means to have Mr Butler effectually recommended to him for his chaplain. The queen also appointed him clerk of her closet; from whence he rose, as his talents became more known, to those high dignities which he afterwards attained.

Mr Secker now began to have a public character, and stood high in the estimation of those who were allowed

Secker, lowed to be the best judges of merit: he had already given proofs of abilities that plainly indicated the eminence to which he must one day rise, as a preacher and a divine; and it was not long before an opportunity offered of placing him in an advantageous point of view. Dr Tyrwhit, who succeeded Dr Clarke as rector of St James's in 1729, found that preaching in so large a church endangered his health. Bishop Gibson, therefore, his father-in-law, proposed to the crown that he should be made rector of St Paul's, and that Mr Secker should succeed him in the rectory. This arrangement was so acceptable to those in power, that it took place without any difficulty. Mr Secker was instituted rector the 18th of May 1733; and in the beginning of July went to Oxford to take his degree of Doctor of Laws, not being of sufficient standing for that of divinity. On this occasion it was that he preached his celebrated A3 Sermon, on the advantages and duties of academical education, which was universally allowed to be a masterpiece of sound reasoning and just composition: it was printed at the desire of the heads of houses, and quickly passed through several editions. It is now to be found in the second collection of Occasional Sermons, published by himself in 1766.

It was thought that the reputation he acquired by this sermon, contributed not a little toward that promotion which very soon followed its publication. For in December 1734, he received a very unexpected notice from Bishop Gibson, that the king had fixed on him to be bishop of Bristol. Dr Benson was about the same time appointed to the see of Gloucester, as was Dr Fleming to that of Carlisle; and the three new bishops were all consecrated together in Lambeth Chapel, Jan. 10. 1734-5, the consecration-sermon being preached by Dr Thomas, afterwards bishop of Winchester.

The honours to which Dr Secker was thus raised in the prime of life did not in the least abate his diligence and attention to business; for which, indeed, there was now more occasion than ever. His learned biographers, Messrs Porteus and Stinton, now relate the manner in which he set about the visitation of his diocese, and the ceremony of confirmation, which he performed in a great number of places; he also preached in several churches, sometimes twice a-day. The affairs of his parish of St James's being likewise in great disorder, he took extraordinary pains to regulate and adjust every thing, particularly the management of the poor; and thus even in a temporal view became of signal service to his parishioners. But, say our authors, "it was their spiritual welfare which engaged, as it ought to do, his chief attention. As far as the circumstances of the times, and the populousness of that part of the metropolis allowed, he omitted not even those private admonitions and personal applications which are often attended with the happiest effects. He allowed out of his own income a salary for reading early and late prayers, which had formerly been paid out of the offertory money. He held a confirmation once every year, examined the candidates several weeks before in the vestry, and gave them religious tracts, which he also distributed at other times very liberally to those that needed them. He drew up, for the use of his parishioners, that admirable course of *Lectures on the Church Catechism* which hath been lately published, and not only read them once every week on the usual days, but also every Sunday

evening, either at the church or one of the chapels belonging to it."

The sermons which at the same time, we are told, he set himself to compose, "were truly excellent and original. His faculties were now in their full vigour, and he had an audience to speak before that rendered the utmost exertion of them necessary. He did not, however, seek to gratify the higher part, by amusing them with refined speculations, or ingenious allays, unintelligible to the lower part, and unprofitable to both; but he laid before them all, with equal freedom and plainness, the great Christian duties belonging to their respective stations, and reproved the follies and vices of every rank among them, without distinction or palliation. He studied human nature thoroughly in all its various forms, and knew what sort of arguments would have most weight with each class of men. He brought the subject home to their bosoms, and did not seem to be merely saying useful things in their presence, but addressing himself personally to every one of them. Few ever possessed, in a higher degree, the rare talent of touching on the most delicate subjects with the nicest propriety and decorum, of saying the most familiar things without being low, the plainest without being feeble, the boldest without giving offence. He could defend with such singular ease and felicity into the minutest concerns of common life, could lay open with so much address the various workings, artifices, and evasions of the human mind, that his audience often thought their own particular cases alluded to, and heard with surprise their private sentiments and feelings, their ways of reasoning and principles of acting, exactly stated and described. His preaching was, at the same time, highly rational, and truly evangelical. He explained with perspicuity, he asserted with dignity, the peculiar characteristic doctrines of the gospel. He inculcated the utility, the necessity of them, not merely as speculative truths, but as actual instruments of moral goodness, tending to purify the hearts and regulate the lives of men; and thus, by God's gracious appointment, as well as by the inseparable connection between true faith and right practice, leading them to salvation.

"These important truths he taught with the authority, the tenderness, the familiarity, of a parent instructing his children. Though he neither possessed nor affected the artificial eloquence of an orator who wants to amuse or to mislead, yet he had that of an honest man who wants to convince, of a Christian preacher who wants to reform and to save those that hear him. Solid argument, manly sense, useful directions, short, nervous, striking sentences, awakening questions, frequent and pertinent applications of scripture; all these following each other in quick succession, and coming evidently from the speaker's heart, enforced by his elevation, his figure, his action, and above all, by the corresponding facility of his example, stamped conviction on the minds of his hearers, and sent them home with impressions not easy to be effaced. It will readily be imagined that with these powers he quickly became one of the most admired and popular preachers of his time."

In 1737 he succeeded to the see of Oxford, on the promotion of Dr Potter to that of Canterbury, then vacant by the death of Archbishop Wake.

In the spring of 1748, Mrs Secker died of the gout in her stomach. She was a woman of great sense and

Secker.

merit, but of a weak and sickly constitution. The bishop's affection and tenderness for her was suited to his character. In 1750, he was installed dean of St Paul's, for which he gave in exchange the rectory of St James's and his prebend of Durham. "It was no wonder (say our authors) that, after presiding over so extensive and populous a parish for upwards of 17 years, he should willingly consent to be released from a burden which began now to grow too great for his strength. When he preached his farewell sermon, the whole audience melted into tears: he was followed with the prayers and good wishes of those whom every honest man would be most ambitious to please; and there are numbers still living who retain a strong and grateful remembrance of his incessant and tender sollicitude for their welfare. Having now more leisure both to prosecute his own studies and to encourage those of others, he gave Dr Church considerable assistance in his *First and Second Vindication of the Miraculous Powers*, &c. against Dr Middleton, and he was of equal use to him in his *Analysis of Lord Brougham's Works*. About the same time began the late Archdeacon Sharp's controversy with the followers of Mr Hatchinson, which was carried on to the end of the year 1755." Bishop Secker, we are told, read over all Dr Sharp's papers, amounting to three volumes 8vo, and corrected and improved them throughout. But the ease which this late change of situation gave him was soon disturbed by a heavy and unexpected stroke, the loss of his three friends, Bishops Butler, Benson, and Berkeley, who were all cut off within the space of one year.

Our authors next give an account of the part which Dr Secker bore, in the house of lords, in respect to the famous repeal of the Jew bill; for which the duke of Newcastle moved, and was seconded by the Bishop, in a speech which, we are told, was remarkably well received. At length his distinguished merit prevailed over all the political obstacles to his advancement, and placed him, without any efforts or application of his own, in that important station which he had shown himself to well qualified to adorn. On the death of Archbishop Hutton, he was promoted to the see of Canterbury, and was confirmed at Bow-church, April 21. 1758; on which occasion our authors observe, that in accepting this high and burdensome station, Dr Secker acted on that principle which influenced him through life; that he sacrificed his own ease and comfort to considerations of public utility; that the mere secular advantages of grandeur were objects below his ambition; and were, as he knew and felt, but poor compensations for the anxiety and difficulties attending them. He had never once through his whole life asked preferment for himself, nor shown any unbecoming eagerness for it; and the use he made of his newly acquired dignity very clearly showed, that rank, and wealth, and power, had in no other sight any charms for him, than as they enlarged the sphere of his active and industrious benevolence.

He fought cut and encouraged men of real genius or extensive knowledge; he expended 300l. in arranging and improving the manuscript library at Lambeth;

and observing with concern, that the library of printed books in that palace had received no additions since the time of Archbishop Tension, he made it his business to collect books in all languages from most parts of Europe at a very great expence, with a view of supplying that chain; which he accordingly did, by leaving them to the library at his death, and thereby rendered that collection one of the noblest and most useful in the kingdom.

All designs and institutions which tended to advance good morals and true religion, he patronized with zeal and generosity: he contributed largely to the maintenance of schools for the poor; to rebuilding or repairing parsonage houses and places of worship; and gave no less than 600l. towards erecting a chapel in the parish of Lambeth. To the society for promoting Christian knowledge he was a liberal benefactor; and to that for propagating the gospel in foreign parts, of which he was the president, he paid much attention; was constant at all the meetings of its members, even sometimes when his health would but ill permit, and superintended their deliberations with consummate prudence and temper.

Whenever any publications came to his knowledge that were manifestly calculated to corrupt good morals, or subvert the foundations of Christianity, he did his utmost to stop the circulation of them; yet the wretched authors themselves he was so far from wishing to treat with any undue rigour, that he has more than once extended his bounty to them in distress. And when their writings could not properly be suppressed (as was too often the case) by lawful authority, he engaged men of abilities to answer them, and rewarded them for their trouble. His attention was everywhere. Even the falsehoods and misrepresentation of writers in the newspapers, on religious or ecclesiastical subjects, he generally took care to have contradicted; and when they seemed likely to injure, in any material degree, the cause of virtue and religion, or the reputation of eminent and worthy men, he would sometimes take the trouble of answering them himself. One instance of this kind, which does him honour, and deserves mention, was his defence of Bishop Butler, who, in a pamphlet published in 1767, was accused of having died a Papist. The conduct which he observed towards the several divisions and denominations of Christians in this kingdom was such as showed his way of thinking to be truly liberal and catholic. The dangerous spirit of popery, indeed, he thought should always be kept under proper legal restraints, on account of its natural opposition not only to the religious but the civil rights of mankind. He therefore observed its movements with care, and exhorted his clergy to do the same, especially those who were situated in the midst of Roman Catholic families; against whose influence they were charged to be upon their guard, and were furnished with proper books or instructions for that purpose. He took all fit opportunities of combating the errors of the church of Rome in his own writings (A); and the best answers that were published to some of the late bold apologies for popery were written at his instance, and under his direction.

With

(A) See particularly his sermons on the rebellion in 1745; on the Protestant working schools in Ireland; on the

Secker.

With the Dissenters his Grace was sincerely desirous of cultivating a good understanding. He considered them, in general, as a conscientious and valuable class of men. With some of the most eminent of them, Watts, Doddridge, Leland, Chandler, Lardner, he maintained an intercourse of friendship or civility. By the most candid and considerate part of them he was highly revered and esteemed; and to such among them as needed help he showed no less kindness and liberality than to those of his own communion.

Nor was his concern for the Protestant cause confined to his own country. He was well known as the great patron and protector of it in various parts of Europe; from whence he had frequent applications for assistance, which never failed of being favourably received. To several foreign Protestants he allowed pensions, to others he gave occasional relief, and to some of their universities was an annual benefactor.

In public affairs, his Grace acted the part of an honest citizen, and a worthy member of the British legislature. From his first entrance into the house of peers, his parliamentary conduct was uniformly upright and noble. He kept equally clear from the extremes of factious petulance and servile dependence; never wantonly thwarting administration from motives of party zeal or private pique, or personal attachment, or a passion for popularity; nor yet going every length with every minister from views of interest or ambition. He admired and loved the constitution of his country, and wished to preserve it unaltered and unimpaired. So long as a due regard to this was maintained, he thought it his duty to support the measures of government; but whenever they were evidently inconsistent with the public welfare, he opposed them with freedom and firmness. Yet his opposition was always tempered with the utmost fidelity, respect, and decency, to the excellent prince upon the throne; and the most candid allowances for the unavoidable errors and infirmities even of the very best ministers, and the peculiarly difficult situation of those who govern a free and high-spirited people. He seldom spoke in parliament, except where the interests of religion and virtue seemed to require it; but whenever he did, he spoke with propriety and strength, and was heard with attention and reverence. Though he never attached himself blindly to any set of men, yet his chief political connections were with the late duke of Newcastle and Lord Chancellor Hardwicke. To these he principally owed his advancement; and he had the good fortune to live long enough to show his gratitude to them or their descendants.

For more than ten years, during which Dr Secker enjoyed the see of Canterbury, he resided constantly at his archiepiscopal house at Lambeth. A few months before his death, the dreadful pains he felt had compelled him to think of trying the Bath waters; but that design was stopped by the fatal accident which put an end to his life.

His Grace had been for many years subject to the gout, which, in the latter part of his life, returned with

more frequency and violence, and did not go off in a regular manner, but left the parts affected for a long time very weak, and was succeeded by pains in different parts of the body. About a year and a half before he died, after a fit of the gout, he was attacked with a pain in the arm, near the shoulder, which having continued about 12 months, a similar pain seized the upper and outer part of the opposite thigh, and the arm soon became easier. This was much more grievous than the former, as it quickly disabled him from walking, and kept him in almost continual torment, except when he was in a reclining position. During this time he had two or three fits of the gout; but neither the gout nor the medicines alleviated these pains, which, with the want of exercise, brought him into a general bad habit of body.

On Saturday July 30. 1768, he was seized, as he sat at dinner, with a sickness at his stomach. He recovered before night; but the next evening, while his physicians were attending, and his servants raising him on his couch, he suddenly cried out that his thigh-bone was broken. The shock was so violent, that the servants perceived the couch to shake under him, and the pain so acute and unexpected, that it overcame the firmness he so remarkably possessed. He lay for some time in great agonies; but when the surgeons arrived, and discovered with certainty that the bone was broken, he was perfectly resigned, and never afterwards asked a question about the event. A fever soon ensued. On Tuesday he became lethargic, and continued so till about five o'clock on Wednesday afternoon, when he expired with great calmness, in the 75th year of his age.

On examination, the thigh-bone was found to be carious about four inches in length, and at nearly the same distance from its head. The disease took its rise from the internal part of the bone, and had so entirely destroyed its substance, that nothing remained at the part where it was broken but a portion of its outward integument; and even this had many perforations, one of which was large enough to admit two fingers, and was filled with a fungous substance arising from within the bone. There was no appearance of matter about the caries, and the surrounding parts were in a sound state. It was apparent that the torture which he underwent during the gradual corrosion of this bone must have been inexplicably great. Out of tenderness to his family he seldom made any complaints to them, but to his physicians he frequently declared his pains were so excruciating, that unless some relief could be procured he thought it would be impossible for human nature to support them long. Yet he bore them for upwards of six months with astonishing patience and fortitude; sat up generally the greater part of the day, admitted his particular friends to see him, mixed with his family at the usual hours, sometimes with his usual cheerfulness; and, except some very slight defects of memory, retained all his faculties and senses in their full vigour till within a few days of his death. He was buried, pursuant

Secker.

gh of November; and a great number of occasional passages to the same purpose, in various parts of his lectures, sermons, and other works.

Seeker
 ll
 Secant.

fuant to his own directions, in a covered passage, leading from a private door of the palace to the north door of Lambeth church; and he forbade any monument or epitaph to be placed over him.

By his will he appointed the Rev. Dr Daniel Burton, canon of Christ-church, and Mrs Catherine Talbot, already mentioned in the course of these memoirs, his executors; and left 13,000*l.* in trust to the Drs Porteous and Stinton, his chaplains; to pay the interit thereof to Mrs Talbot and her daughter during their joint lives, or the life of the survivor; and after the decease of both those ladies, 11,000*l.* of the said 13,000*l.* are to be transferred to charitable purposes; amongst which are 1000*l.* to the Society for the Propagation of the Gospel, and 1000*l.* to the same society for a bishop or bishops in the king's dominions in America.

The following description is given of his person: He was tall and comely; in the early part of his life slender, and rather consumptive; but as he advanced in years his constitution gained strength, and his size increased, yet never to a degree of corpulency that was disproportionate or troublesome.

The dignity of his form corresponded with the greatness of his mind, and inspired at all times respect and awe; but peculiarly so when he was engaged in any of the more solemn functions of religion, into which he entered with such devout earnestness and warmth, with so just consciousness of the place he was in, and the business he was about, as seemed to raise him above himself, and added new life and spirit to the natural gracefulness of his appearance.

His countenance was open, ingenious, and expressive of every thing right. It varied easily with his spirits and his feelings, so as to be a faithful interpreter of his mind, which was incapable of the least dissimulation. It could speak dejection, and, on occasion, anger, very strongly; but when it meant to show pleasure or approbation, it softened into a most gracious smile, and diffused over all his features the most benevolent and reviving complacency that can be imagined.

SECOND, in *Geometry, Chronology, &c.* the 60th part of a prime; or minute, whether of a degree or of an hour.

SECOND, in *Music*, one of the musical intervals; being only the difference between any sound and the next nearest sound, whether above or below it.

SECOND Major, in *Music*. See INTERVAL.

SECOND Minor, in *Music*. See INTERVAL.

SECOND Sight, in *Erie* called *Tafsch*, is a mode of seeing superadded to that which nature generally bestows. This gift or faculty, which is neither voluntary nor constant, is in general rather troublesome than agreeable to the possessors of it, who are chiefly found among the inhabitants of the Highlands of Scotland, those of the Western isles, of the Isle of Man, and of Ireland. It is an impression made either by the mind upon the eye, or by the eye upon the mind, by which things distant or future are perceived, and seen as if they were present. A man on a journey far from home falls from his horse; another, who is perhaps at work about the house, sees him bleeding on the ground, commonly with a landscape of the place where the accident befalls him. Another sees, driving home his cattle, or wandering in idleness, or musing in the sunshine, is suddenly surprised by the ap-

Secord.

pearance of a bridal ceremony, or funeral procession, and counts the mourners or attendants, of whom, if he knows them, he relates the names; if he knows them not, he can describe the dresses. Things distant are seen at the instant they happen.

Of things future, Johnson says that he knows no rule pretended to for determining the time between the sight and the event; but we are informed by Mr Grose, that in general the time of accomplishment bears some relation to the time of the day in which the impressions are received. Thus visions seen early in the morning (which seldom happens) will be much sooner accomplished than those appearing at noon; and those seen at noon will take place in a much shorter time than those happening at night; sometimes the accomplishment of the last does not fall out within a year or more.

These visions are not confined to solemn or important events; nor is it true, as is commonly reported, that to the second sight nothing is presented but phantoms of evil. The future visit of a mountebank, or piper; a plentiful draught of fish; the arrival of common travellers; or, if possible, still more trifling matters than these, — are foreseen by the seers. A gentleman told Dr Johnson, that when he had once gone far from his own island, one of his labouring servants predicted his return, and described the livery of his attendant, which he had never worn at home; and which had been, without any previous design, occasionally given him.

As many men eminent for science and literature have admitted the reality of this apparently useless gift, we shall, without interposing our own opinion, give the reflections of two of the first characters of the age upon it, and leave our readers to form their own judgment. By Dr Beattie of Aberdeen it is thus accounted for.

The Highlands of Scotland are a picturesque but a melancholy country. Long tracts of mountainous desert, covered with dark heath, and often obscured by misty weather; narrow valleys, thinly inhabited, and bounded by precipices resounding with the fall of torrents; a soil so rugged, and a climate so dreary, as in many parts to admit neither the amusements of pasturage nor the labours of agriculture; the mournful dashing of waves along the friths and lakes that intersect the country; the portentous noises which every change of the wind and every increased diminution of the waters is apt to raise in a lonely region full of echoes and rocks and caverns; the grotesque and ghastly appearance of such a landscape by the light of the moon; objects like these diffuse a gloom over the fancy, which may be combatable enough with occasional and social merriment, but cannot fail to tincture the thoughts of a native in the hour of silence and solitude. If these people, notwithstanding their reformation in religion, and more frequent intercourse with strangers, do still retain many of their old superstitions, we need not doubt but in former times they must have been much more enslaved to the horrors of imagination, when beset with the bugbears of Popery and Paganism. Most of their superstitions are of a melancholy cast. That of *second sight*, by which some are still supposed to be haunted, is considered by themselves as a misfortune, on account of the many dreadful images it is said to obtrude upon the fancy. It is said that some of the Alpine regions do likewise lay claim to a sort of second sight.

Second. Nor is it wonderful, that persons of all degrees of imagination, immured in deep solitude, and surrounded with the stupendous scenery of clouds, precipices, and torrents, should dream (even when they think themselves awake) of those few striking ideas with which their lonely lives are diversified: of corpses, funeral processions, and other subjects of terror; or of marriages, and the arrival of strangers, and such like matters of more agreeable curiosity.

Let it be observed also, that the ancient Highlanders of Scotland had hardly any other way of supporting themselves than by hunting, fishing, or war; professions that are continually exposed to fatal accidents. And hence, no doubt, additional horrors would often haunt their solitude, and a deeper gloom overshadow the imagination even of the hardiest native.

A sufficient evidence can hardly be found for the reality of the *second sight*, or at least of what is commonly understood by that term. A treatise on the subject was published in the year 1762, in which many tales were told of persons whom the author believed to have been favoured, or haunted, with these illuminations; but most of the tales were trifling and ridiculous: and the whole work betrayed, on the part of the compiler, such extreme credulity, as could not fail to prejudice many readers against his system.

That any of these visionaries are apt to be swayed in their declarations by sinister views, we will not say; but this may be said with confidence, that none but ignorant people pretend to be gifted in this way. And in them it may be nothing more, perhaps, than short fits of sudden sleep or drowsiness, attended with lively dreams, and arising from some bodily disorder, the effect of idleness, low spirits, or a gloomy imagination. For it is admitted, even by the most credulous Highlanders, that as knowledge and industry are propagated in their country, the *second sight* disappears in proportion; and nobody ever laid claim to the faculty who was much employed in the intercourse of social life (A). Nor is it at all extraordinary, that one should have the appearance of being awake, and should even think one's self so, during those fits of dozing; that they should come on suddenly, and while one is engaged in some business. The same thing happens to persons much fatigued, or long kept awake, who frequently fall asleep for a moment, or for a long space, while they are standing, or walking, or riding on horseback. Add but a lively dream to this slumber, and (which is the frequent effect of disease) take away the consciousness of having been asleep, and a superstitious man may easily mistake his dream for a waking vision; which, however, is soon forgotten when no subsequent occurrence recalls it to his memory; but which, if it shall be thought to resemble any future event, exalts the poor dreamer into a Highland prophet. This conceit makes him more reckless and more melancholy than ever; and so feeds his disease, and multiplies his visions: which, if they are not dissipated by business or society, may continue to haunt

him as long as he lives; and which, in their progress through the neighbourhood, receive some new tinctures of the marvels from every mouth that promotes their circulation. As to the prophetic nature of this *second sight*, it cannot be admitted at all. That the Deity should work a miracle in order to give intimation of the frivolous things that these tales are made up of, the arrival of a stranger, the mailing of a coin, or the colour of a suit of clothes; and that these intimations should be given for no end, and to those persons only who are idle and solitary, who speak Gaelic, or who live among mountains and deserts—is like nothing in nature or providence that we are acquainted with, and must therefore, unless it were confirmed by satisfactory proof (which is not the case), be rejected as a wild and incredible.

These visions, such as they are, may reasonably enough be attributed to a diseased fancy. And that in them, as well as in our ordinary dreams, certain appearances should, on some rare occasions, resemble certain events, is to be expected from the laws of chance; and seems to have in it nothing more marvellous or supernatural, than that the parrot, who deals out his familiarities at random, should sometimes happen to salute the passenger by his right appellation.

To the confidence of these objections Dr Johnson replies, that by presuming to determine what is fit, and what is beneficial, they presuppose more knowledge of the universal system than man has attained; and therefore depend upon principles too complicated and extensive for our comprehension; and that there can be no security in the consequence when the premises are not understood; that the *second sight* is only wonderful because it is rare, for, considered in itself, it involves no more difficulty than dreams, or perhaps than the regular exercise of the cognitive faculty; that a general opinion of communicative impulses, or visionary representations, has prevailed in all ages and all nations; that particular instances have been given with such evidence, as neither Bacon nor Bayle has been able to resist; that sudden impulses, when the event has verified, have been felt by more than even or publish them; that the *second sight* of the Hebrides implies only the local frequency of a power, which is nowhere totally unknown; and that where we are unable to decide by antecedent reason, we must be content to yield to the force of testimony. By pretension to *second sight*, no profit was ever sought or gained. It is an involuntary affection, in which neither hope nor fear are known to have any part. Those who profess to feel it do not boast of it as a privilege, nor are considered by others as advantageously distinguished. They have no temptation to feign, and their hearers have no motive to encourage the imposture.

SECOND Terms, in *Algebra*, those where the unknown quantity has a degree of power less than it has in the term where it is raised to the highest. The art of throwing these *second terms* out of an equation, is,

(A) This, however, is denied by Johnson, who affirms that the Islanders of all degrees, whether of rank or understanding, universally admit it except the ministers, who, according to him, reject it, in consequence of a system, against conviction. He affirms, too, that in 1773, there was in the Hebrides a *second-sighted* gentleman, who confessed of the terrors to which he was exposed.

Secondary Secretary. is, of forming a new equation where they have no place, is one of the most ingenious and useful inventions in all algebra.

SECONDARY, in general, something that acts as second or in subordination to another.

SECONDARY or *Secondary*, an officer who acts as second or next to the chief officer. Such are the secondaries of the courts of king's bench and common pleas; the secondaries of the compters, who are next the sheriffs of London in each of the two compters; two secondaries of the pipe; secondaries to the remembrancers, &c.

SECONDARY Circles of the Ecliptic are circles of longitude of the stars; or circles which, passing through the poles of the ecliptic, are at right angles to the ecliptic. See **CIRCLES of Latitude**.

SECONDARY Qualities of Bodies. See **METAPHYSICS**, N^o 153.

SECONDAT. See **MONTESQUIEU**.

SECRETARIES BIRD, the falco ferpentarius and fagittarius of Linnaeus, but classed by Latham under the genus **VULTUR**. See **ORNITHOLOGY Index**.

SECRETARY, an officer who, by his master's orders, writes letters, dispatches, and other instruments, which he renders authentic by his signet. Of these there are several kinds; as, 1. Secretaries of state, who are officers that have under their management and direction the most important affairs of the kingdom, and are obliged constantly to attend on the king: they receive and dispatch whatever comes to their hands, either from the crown, the church, the army, private grants, pardons, dispensations, &c. as likewise petitions to the sovereign, which, when read, are returned to them; all which they dispatch according to the king's direction. They have authority to commit persons for treason, and other offences against the state, as conservators of the peace at common law, or as justices of the peace throughout the kingdom. They are members of the privy-council, which is seldom or never held without one of them being present. As to the business and correspondence in all parts of this kingdom, it is managed by either of the secretaries without any distinction; but with respect to foreign affairs, the business is divided into two provinces or departments, the southern and the northern, comprehending all the kingdoms and states that have any intercourse with Great Britain; each secretary receiving all letters and addresses from, and making all dispatches to, the several princes and states comprehended in his province. Ireland and the Plantations are under the direction of the elder secretary, who has the southern province, which also comprehends, France, Italy, Switzerland, Spain, Portugal, and Turkey; the northern province includes the Low Countries, Germany, Denmark, Sweden, Poland, and Muscovy. Each of the secretaries has an apartment in all the royal houses, both for their own accommodation and their officers; they have also a table at the king's charge, or else board-wages. The two secretaries for Britain have each two under secretaries, and one chief clerk; with an uncertain number of other clerks and translators, all wholly depending on them. To the secretaries of state belong the custody of that seal properly called the *signet*, and the direction of two other offices, one called the *paper-office*, and the other the *signet office*. In addition to these, there is a secretary for the war de-

partment, whose office must be temporary. 2. Secretary of an embassy, a person attending an ambassador, for writing dispatches relating to the negotiation. There is a great difference between the secretaries of an embassy and the ambassador's secretary; the latter being a domestic or menial of the ambassador, and the first a servant or minister of the prince. 3. The secretary of war, an officer of the war-office, who has two chief clerks under him, the last of which is the secretary's messenger. There are also secretaries in most of the other offices.

SECRETION, in the animal economy. See **PHYSIOLOGY Index**.

SECT, a collective term, comprehending all such as follow the doctrines and opinions of some famous divine, philosopher, &c.

SECTION, in general, denotes a part of a divided thing, or the division itself. Such, particularly, are the subdivisions of a chapter; called also *paragraphs* and *articles*: the mark of a section is §.

SECTION, in *Geometry*, denotes a side or surface of a body or figure cut off by another; or the place where lines, planes, &c. cut each other.

SECTOR, in *Geometry*, is a part of a circle comprehended between two radii and the arch: or it is a mixed triangle, formed by two radii and the arch of a circle.

SECTOR, is also a mathematical instrument, of great use in finding the proportion between quantities of the same kind: as between lines and lines, surfaces and surfaces, &c. whence the French call it the *compass of proportion*. The great advantage of the sector above the common scales, &c. is, that it is made so as to fit all radii and all scales. By the lines of chords, sines, &c. on the sector, we have lines of chords, sines, &c. to any radius betwixt the length and breadth of the sector when open.

The real inventor of this valuable instrument is unknown; yet of so much merit has the invention appeared, that it was claimed by Galileo, and disputed by nations.

The sector is founded on the fourth proposition of the sixth book of Euclid; where it is demonstrated, that similar triangles have their homologous sides proportional. An idea of the theory of its construction may be conceived thus. Let the lines AB, AC (Plate CCCCLXXXVIII. fig. 1.) represent the legs of the sector; and AD, AE, two equal sections from the centre: if, now the points CB and DE be connected, the lines CB and DE will be parallel; therefore the triangles ADE, ACB will be similar; and consequently the sides AD, DE, AB, and BC, proportional; that is, as AD : DE :: AB : BC : whence, if AD be the half, third, or fourth part of AB; DE will be a half, third, or fourth part of CB: and the same holds of all the rest. If, therefore, AD be the chord, sine, or tangent, of any number of degrees to the radius AB; DE will be the same to the radius BC.

Description of the Sector. The instrument consists of two rules or legs, of brass or ivory, or any other matter, representing the radii, moveable round an axis or joint, the middle of which expresses the centre; whence are drawn on the faces of the rulers several scales, which may be distinguished into single and double.

The double scales, or lines graduated upon the faces,

Sector.

of the instrument, and which are to be used as sectorial lines, proceed from the centre; and are, 1. Two scales of equal parts, one on each leg, marked *LIN.* or *L.*; each of these scales, from the great extensiveness of its use, is called the *line of lines*. 2. Two lines of chords marked *CH.* or *C.* 3. Two lines of secants marked *SEC.* or *S.* A line of polygons marked *POL.* Upon the other face the sectorial lines are, 1. Two lines of lines marked *SIN.* or *S.* 2. Two lines of tangents marked *TAN.* or *T.* 3. Between the line of tangents and lines there is another line of tangents to a lesser radius, to supply the defect of the former, and extending from 45° to 75° , marked *t*.

Each pair of these lines (except the line of polygons) is so adjusted as to make equal angles at the centre; and consequently at whatever distance the sector be opened, the angles will be always respectively equal. That is, the distance between 10 and 10 on the line of lines, will be equal to 60 and 60 on the line of chords, 90 and 90 on the line of lines, and 45 and 45 on the line of tangents.

Besides the sectorial scales, there are others on each face, placed parallel to the outward edges, and used as those of the common plane scale. 1. These are a line of inches. 2. A line of latitudes. 3. A line of hours. 4. A line of inclination of meridians. 5. A line of chords. Three logarithmic scales, namely, one of numbers, one of sines, and one of tangents. These are used when the sector is fully opened, the legs forming one line (A).

The value of the divisions on most of the lines are determined by the figures adjacent to them; these proceed by tens, which constitute the divisions of the first order, and are numbered accordingly; but the value of the divisions on the line of lines, that are distinguished by figures, is entirely arbitrary, and may represent any value that is given to them; hence the figures, 1, 2, 3, 4, &c. may denote either 10, 20, 30, 40, or 100, 200, 300, 400, and so on.

The line of lines is divided into ten equal parts, numbered 1, 2, 3, to 10; these may be called *divisions of the first order*; each of these is again subdivided into 10 other equal parts, which may be called *divisions of the second order*; each of these is divided into two equal parts, forming *divisions of the third order*. The divisions on all the scales are contained between four parallel lines; those of the third order extend to the most distant; those of the third to the least; those of the second to the intermediate parallel.

When the whole line of lines represents 100, the divisions of the first order, or those to which the figures are annexed, represent tens; those of the second order units; those of the third order the halves of these units. If the whole line represent ten, then the divisions of the first order are units; those of the second tenths; the thirds twentieths.

In the line of tangents, the divisions to which the numbers are affixed, are the degrees expressed by those numbers. Every fifth degree is denoted by a line somewhat longer than the rest; between every number and each fifth degree, there are four divisions longer than

Vol. XIX. Part I.

the intermediate adjacent ones, these are whole degrees; the shorter ones, or those of the third order, are 30 minutes.

From the centre, to 60 degrees, the line of sines is divided like the line of tangents, from 60 to 70; it is divided only 10 every degree, from 70 to 80, to every two degrees, from 80 to 90; the division must be estimated by the eye.

The divisions on the line of chords are to be estimated in the same manner as the tangents.

The lesser line of tangents is graduated every two degrees, from 45 to 50; but from 50 to 60 to every degree; from 60 to the end, to half degree.

The line of secants from 0 to 10 is to be estimated by the eye; from 20 to 30, it is divided to every two degrees; from 30 to 60, to every degree; from 60 to the end, to every half degree.

Use of the Line of Equal Parts on the SECTOR. 1. To divide a given line into any number of equal parts, suppose five. Take the given line in your compasses, and setting one foot in a division of equal parts, that may be divided by five, for example 70, whose seventh part is 10, open the sector till the other point fall exactly on 70, in the same line on the other leg. In this disposition, applying one point of the compasses to 10 in the same line; that them till the other fall in 10 in the same line on the other leg, and this opening will be the seventh part of the given line. Note, if the line to be divided be too long to be applied to the legs of the sector, divide only one half or one fourth by seven, and the double or quadruple thereof will be the seventh part of the whole.

2. To measure the lines of the perimeter of a polygon, one of which contains a given number of equal parts. Take the given line in your compasses, and setting it parallel, upon the line of equal parts, to the number on each leg expressing its length. The sector remaining thus, set off the length of each of the other lines parallel to the former, and the number each of them falls on will express its length.

3. A right line being given, and the number of parts it contains, suppose 120, to take from it a shorter line, containing any number of the same parts, suppose 20. Take the given line in your compasses, open the sector till the two feet fall on 120 on each leg; then will the distance between 25 on one leg, and the same number on the other, give the line required.

4. To multiply by the line of equal parts on the sector. Take the lateral distance from the centre of the line to the given multiplicator; open the sector till you fit that lateral distance to the parallel of 1 and 1, or 10 and 10, and keep the sector in that disposition; then take in the compasses the parallel distance of the multiplicand, which distance, measured laterally on the same line, will give the product required. Thus, suppose it were required to find the product of 8 multiplied by 4: take the lateral distance from the centre of the line to 4 in your compasses, i. e. place one foot of the compasses in the beginning of the divisions, and extend the other along the line to 4. Open the sector till you fit this lateral distance to the parallel of 1 and 1, or

P

1, or

(A) The lines are placed in different orders on different sectors, but they may easily be found by these general directions.

Sector.

1. or 10 and 10. Then take the parallel distance of 8, the multiplicand; i. e. extend the compasses from 8, in this line, on one leg, to 8 in the same line on the other; and that extent, measured laterally, will give the product required.

8
Division in
general.

5. To divide by the line of equal parts on the sector. Extend the compasses laterally from the beginning of the line to 1, and open the sector till you fit that extent to the parallel of the divisor; then take the parallel distance of the dividend, which extent, measured in a lateral direction, will give the quotient required. Thus, suppose it was required to divide 36 by 4: extend the compasses laterally, the beginning of the line to 1, and fit to that extent the parallel of 4, the divisor; then extend the compasses parallel, from 36 on one leg to 36 on the other, and that extent, measured laterally, will give 9, the quotient required.

9
Proportion.

6. Proportion by the line of equal parts. Make the lateral distance of the second term the parallel distance of the first term, the parallel distance of the third term is the fourth proportional. *Example.* To find a fourth proportional to 8, 4, and 6, take the lateral distance of 4, and make it the parallel distance of 8; then the parallel distance of 6, extended from the centre, shall reach to the fourth proportional 3.

In the same manner, a third proportional is found to two numbers. Thus, to find a third proportional to 8 and 4, the sector remaining as in the former example, the parallel distance of 4, extended from the centre, shall reach to the third proportional 2. In all these cases, if the number to be made a parallel distance be too great for the sector, some aliquot part of it is to be taken, and the answer is to be multiplied by the number by which the first number was divided.

10
Line of
chords.

Use of the Line of Chords on the SECTOR. 1. To open the sector so that the two lines of chords may make an angle or number of degrees, suppose 40. Take the distance from the joint to 40, the number of the degrees proposed, on the line of chords; open the sector till the distance from 60 to 60, on each leg, be equal to the given distance of 40; then will the two lines on the sector form an angle of 40 degrees, as was required.

2. The sector being opened, to find the degrees of its aperture. Take the extent from 60 to 60, and lay it off on the line of chords from the centre; the number whereon it terminates will show the degrees, &c. required.

3. To lay off any number of degrees upon the circumference of a circle. Open the sector till the distance between 60 and 60 be equal to the radius of the given circle; then take the parallel extent of the chord of the number of degrees on each leg of the sector, and lay it off on the circumference of the given circle.— Hence any regular polygon may be easily inscribed in a given circle.

11
Line of
Polygons.

Use of the Line of Polygons on the SECTOR. 1. To inscribe a regular polygon in a given circle. Take the semidiameter of the given circle in the compasses, and adjust it to the number 6, on the line of polygons, on each leg of the sector: then, the sector remaining thus opened, take the distance of the two equal numbers, expressing the number of sides the polygon is to have; e. g. the distance from 5 to 5 for a pentagon, from 7 to 7 for a heptagon, &c. These distances carried about

the circumference of the circle, will divide it into 60 Sector.
many equal parts.

2. To describe a regular polygon, e. g. a pentagon, on a given right line. Take the length of the line in the compasses, and apply it to the extent of the number 5, 5, on the lines of polygons. The sector thus opened, upon the same lines take the extent from 6 to 6; this will be the semidiameter of the circle the polygon is to be inscribed in. If, then, with this distance, from the ends of the given line, you describe two arches of a circle, their intersection will be the centre of the circle.

3. On a right line, to describe an isosceles triangle, having the angles at the base double that at the vertex. Open the sector, till the ends of the given line fall on 10 and 10 on each leg; then take the distance from 6 to 6. This will be the length of the two equal sides of the triangle.

*Use of the Lines of Sines, Tangents, and Secants, on Sines, Tan-
the SECTOR.* By the several lines disposed on the secants, and
tor, we have scales to several radii; so that having a
length or radius given, not exceeding the length of the
sector when opened, we find the chord, sine, &c.
thereto: e. g. Suppose the chord, sine, or tangent of
10 degrees, to a radius of 3 inches required; make 3
inches the aperture between 60 and 60, on the lines of
chords of the two legs; then will the same extent reach
from 45 to 45 on the line of tangents, and from 90 to
90 on the line of the sines on the other side; so that to
whatever radius the line of chords is set, to the same are
all the others set. In this disposition, therefore, if the
aperture between 10 and 10, on the lines of chords, be
taken with the compasses, it will give the chord of 10
degrees. If the aperture of 10 and 10 be in like man-
ner taken on the lines of sines, it will be the sine of 10
degrees. Lastly, if the aperture of 10 and 10 be in
like manner taken on the lines of tangents, it gives the
tangent of 10 degrees.

If the chord, or tangent, of 70 degrees were required; for the chord, the aperture of half the arch, viz. 35, must be taken, as before; which distance, repeated twice, gives the chord of 70 degrees. To find the tangent of 70 degrees to the same radius, the small line of tangents must be used, the other only reaching to 45: making, therefore, 3 inches the aperture between 45 and 45 on the small line; the extent between 70 and 70 degrees on the same, will be the tangent of 70 degrees to 3 inches radius.

To find the secant of an arch, make the given radius the aperture between 0 and 0 on the lines of secants: then will the aperture of 10 and 10, or 70 and 70, on the said lines, give the tangent of 10° or 70°.

If the converse of any of these things were required, that is, if the radius be required, to which a given line is the sine, tangent, or secant, it is but making the given line, if a chord, the aperture on the line of chords between 10 and 10, and then the sector will stand at the radius required; that is, the aperture between 60 and 60 on the said line is the radius. If the given line were a sine, tangent, or secant, it is but making it the aperture of the given number of degrees; then will the distance of 92 and 90 on the sines, of 45 and 45 on the tangents, of 0 and 0 on the secants, be the radius.

SECTOR of an Ellipse, of an Hyperbola, &c. is a part resembling

Sector,
Secular.

representing the circular sector, being contained by three lines, two of which are radii, or lines drawn from the centre of the figure to the curve, and the intercepted arc or part of that curve.

SECTOR of a Sphere, is the solid generated by the revolution of the sector of a circle about one of its radii; the other radius describing the surface of a cone, and the circular arc a circular portion of the surface of the sphere of the same radius. So that the spherical sector consists of a right cone, and of a segment of the sphere having the same common base with the cone. Hence the solid content of it will be found by multiplying the base or spherical surface by the radius of the sphere, and taking one third of the product.

Astronomical SECTOR. See **ASTRONOMICAL SECTOR.**
Dialing SECTOR. See **DIALING.**

SECULAR, that which relates to affairs of the present world, in which sense the word stands opposed to *spiritual, ecclesiastical*: thus we say secular power, &c.

SECULAR, is more peculiarly used for a person who lives at liberty in the world, not shut up in a monastery, nor bound by vows, or subjected to the particular rules of any religious community; in which sense it stands opposed to *regular*. The Romish clergy are divided into secular and regular, of which the latter are bound by monastic rules, the former not.

SECULAR Games, in antiquity, solemn games held among the Romans once in an age. These games lasted three days and as many nights; during which time sacrifices were performed, theatrical shews exhibited, with combats, sports, &c. in the circus. The occasion of these games, according to Valerius Maximus, was to stop the progress of a plague. Valerius Publicola was the first who celebrated them at Rome in the year of the city 235. The solemnity was as follows: The whole world was invited by a herald to a feast which they had never seen already, nor ever should see again. Some days before the games began, the quincecenviri in the Capitol and the Palatine temple, distributed to the people purifying compositions, of various kinds, as Lambears, sulphur, &c. From hence the populace passed to Diana's temple on the Aventine mount, with wheat, barley, and oats, as an offering. After this, whole nights were spent in devotion to the Deities. When the time of the games was fully come, the people assembled in the Campus Martius, and sacrificed to Jupiter, Juno, Apollo, Latona, Diana, the Parcae, Ceres, Pluto, and Proserpine. On the first night of the feast the emperor, with the quincecenviri, caused three altars to be erected on the banks of the Tiber, which they sprinkled with the blood of three lambs, and then proceeded to regular sacrifice. A space was next marked out for a theatre, which was illuminated with innumerable flambeaus and fires. Here they sung hymns, and celebrated all kinds of sports. On the day after, having offered victims at the Capitol, they went to the Campus Martius, and celebrated sports to the honour of Apollo and Diana. These lasted till next day, when the noble matrons, at the hour appointed by the oracle, went to the Capitol to sing hymns to Jupiter. On the third day, which concluded the solemnity, twenty seven boys, and as many girls, sung in the temple of Palatine Apollo hymns and verses in Greek and Latin, to recommend the city to the protection of those deities whom they designed particularly to honour by their sacrifices.

The inimitable Carmen Seculare of Horace was composed for this last day, in the Secular Games, held by Augustus.

It has been much disputed whether these games were held every hundred, or every hundred and ten years. Valerius Antius, Varro, and Livy, are quoted in support of the former opinion: In favour of the latter may be produced the quincecenviral registers, the edicts of Augustus, and the words of Horace in the Secular poem,

Cetus undenos decies per annos.

It was a general belief, that the girls who bore a part in the song should be soon married; and that the children who did not dance and sing at the coming of Apollo, should die unmarried, and at an early period of life.

SECULAR Poem, a poem sung or rehearsed at the secular games; of which kind we have a very fine piece among the works of Horace, being a sapphic ode at the end of his epodes.

SECULARIZATION, the act of converting a regular person, place, or benefice, into a secular one. Almost all the cathedral churches were anciently regular, that is, the canons were to be religious; but they have been since secularized. For the secularization of a regular church, there is required the authority of the pope, that of the prince, the bishop of the place, the patron, and even the consent of the people. Religious that want to be released from their vow, obtain briefs of secularization from the pope.

SECUNDINEs, in *Anatomy*, the several coats or membranes wherein the fetus is wrapped up in the mother's womb; as the chorion and amnios, with the placenta, &c.

SECUNDUS, JOANNES NICOLAÏUS, an elegant writer of Latin poetry, was born at the Hague in the year 1511. His descent was from an ancient and honourable family in the Netherlands; and his father Nicolaus Everardus, who was born in the neighbourhood of Middleburg, seems to have been high in the favour of the emperor Charles V. as he was employed by that monarch in several stations of considerable importance. We find him first a member of the grand parliament or council of Mechelen, afterwards president of the states of Holland and Zealand at the Hague, and lastly holding a similar office at Mechelen, where he died, August 5. 1532. aged 70.

These various employments did not occupy the whole of Everardus's time. Notwithstanding the multiplicity of his business, he found leisure to cultivate letters with great success, and even to act as preceptor to his own children, who were five sons and three daughters. They all took the name of Nicolaii from their father; but on what account our author was called *Secundus* is not known. It could not be from the order of his birth, for he was the youngest son. Perhaps the name was not given him till he became eminent; and then, according to the fashion of the age, it might have its rise from some pun, such as his being *Poetarum nemi: Secundus*. Poetry, however, was by no means the profession which his father wished him to follow. He intended him for the law, and when he could no longer direct his studies himself, placed him under the care of

Secular
the
Secular.

Jacobus Valeardus. This man is said to have been every way well qualified to discharge the important trust which was committed to him; and he certainly gained the affection of his pupil, who, in one of his poems, mentions the death of Valeardus with every appearance of unfeigned sorrow. Another tutor was soon provided; but it does not appear that Secundus devoted much of his time to legal pursuits. Poetry and the sister arts of painting and sculpture had engaged his mind at a very early period; and the imagination, on which these have laid hold, can with difficulty submit to the dry study of rusty civilians. Secundus is said to have written verses when but ten years old; and from the vast quantity which he left behind him, we have reason to conclude that such writing was his principal employment. He found time, however, to carve figures of all his own family, of his mistresses, of the emperor Charles V. of several eminent personages of those times, and of many of his intimate friends; and in the last edition of his works published by Scriverius at Leyden, 1631, there is a print of one of his mistresses with this inscription round it; VAVIS AMATORIS JULIA SCULPTA MANU.

Secundus having nearly attained the age of twenty-one, and being determined, as it would seem, to comply as far as possible with the wishes of his father, quitted Mechelen, and went to France, where at Bourges, a city in the *Orleanois*, he studied the civil law under the celebrated *Andreas Alciatus*. Alciatus was one of the most learned civilians of that age; but what undoubtedly exceeded him much more to our author was his general acquaintance with polite literature, and more particularly his taste in poetry. Having studied a year under this eminent professor, and taken his degrees, Secundus returned to Mechelen, where he remained only a very few months. In 1533 he went into Spain with warm recommendations to the count of Nassau and other persons of high rank; and soon afterwards became secretary to the cardinal archbishop of Toledo in a department of business which required no other qualifications than what he possessed in a very eminent degree, a facility in writing with elegance the Latin language. It was during his residence with this cardinal that he wrote his *Baïta*, a series of satirical poems, of which the fifth, seventh, and ninth *carmina* of *Catullus* seem to have given the hint. Secundus was not, however, a servile imitator of Catullus. His expressions seem to be borrowed rather from *Tibullus* and *Propertius*; and in the warmth of his descriptions he surpasses every thing that has been written on similar subjects by *Catullus*, *Tibullus*, *Propertius*, *C. Gallus*, *Ovid*, or *H. ruce*.

In 1535 he accompanied the emperor Charles V. to the siege of Tunis, but gained no laurels as a soldier. The hardships which were endured at that memorable siege were but little suited to the soft disposition of a votary of Venus and the muses; and upon an enterprise which might have furnished ample matter for an epic poem, it is remarkable that Secundus wrote nothing which has been deemed worthy of preservation. Having returned from his martial expedition, he was sent by the cardinal to Rome to congratulate the pope upon the success of the emperor's arms; but was taken ill on the road, that he was not able to complete his journey. He was advised to seek, without a moment's

delay, the benefit of his native air; and that happily recovered him.

Having now quitted the service of the archbishop of Toledo, Secundus was employed in the same office of secretary by the bishop of Utrecht; and so much had he hitherto distinguished himself by the classical elegance of his compositions, that he was soon called upon to fill the important post of private Latin secretary to the emperor, who was then in Italy. This was the most honourable office to which our author was ever appointed; but before he could enter upon it death put a stop to his career of glory. Having arrived at *Saint Amand* in the district of *Tournay*, in order to meet, upon business, with the bishop of Utrecht, he was on the 8th of October 1536 cut off by a violent fever, in the very flower of his age, not having quite completed his twenty-fifth year. He was interred in the church of the Benedictines, of which his patron, the bishop, was *abbot* or *pro-abbot*; and his near relations erected to his memory a marble monument, with a plain Latin inscription.

The works of Secundus have gone through several editions, of which the best and most copious is that of Scriverius already mentioned. It consists of *JULIA, Eleg. lib. i.*; *AMORES, Eleg. lib. ii.*; *AD DIVERSOS, Eleg. lib. iii.*; *BASIA*, styled by the editor *incomparabilis et divinus proflus liber*; *EPIGRAMMATA*; *ODARUM liber unus*; *EPISTOLARUM liber unus Elegiaca*; *EPISTOLARUM liber alter, heroico carmine scriptus*; *FENERUM liber unus*; *SYLVÆ ET CARMINUM fragmenta*; *POEMATATA nonnulla fratrum*; *ITINERARIA Secundi tria, &c.*; *EPISTOLÆ totidem, soluta oratione*. Of these works it would be superfluous in us to give any character after the ample testimonies prefixed to them of *Lelius Greg. Gyraldus*, the elder *Scaliger*, *Theodore Beza*, and others equally celebrated in the republic of letters, who all speak of them with rapture. A French critic, indeed, after having affirmed that the genius of Secundus never produced any thing which was not excellent in its kind, adds, with too much truth, *Mais sa muse est un peu trop lascive*. For this fault our author makes the following apology in an epigram addressed to the grammarians;

Carmina cur spargam cunctis lasciva libellis,
 Queritis? Insulsius arceo grammaticos.
 Fortis magnanimi canerem si Cæsaris arma,
 Faciave DIVORUM religiosa VIRUM?
 Quot nasser exciperemque notas, pateretque lituras?
 Quot ferem teneris supplicium pueris?
 At nunc uda mihi d'stant cum BASIA carmen,
 Pueric et versu mentula multa meo:
 Me leget innecte juvenis placitum amice,
 Et placitura nova blanda puella viro:
 Et quemcumque juvat lepidorum de grege vatium
 Oia telitivis ludere deliciis.
 Lusibus et levis procul hinc abesse, SEVI
 GRAMMATICI, injussas et exhibite manus.
 Ne puer, ab malleis cæcis lacrymanisque leporis;
 DURAM FORTE MEIS OSSIBUS OPTET HUMUM.

SECURIDACA, a genus of plants belonging to the class didadelphia. See *BOTANY Index*.

SECUTORES, a species of gladiators among the Romans, whose arms were a helmet, a shield, and a sword or a leaden bullet. They were armed in this manner, because they had to contend with the retarii, who were

Secutores
||
Sedition.

were dressed in a short tunic, bore a three pointed lance in their left hand, and a net in their right. The retiararius attempted to cast his net over the head of the fenerator; and if he succeeded, he drew it together and flew him with his talent: but if he missed his aim, he immediately betook himself to flight till he could find a second opportunity of entangling his adversary with his net. He was punished by the lecturer, who endeavoured to dispatch him in his flight.

Secutores was also a name given to such gladiators as took the place of those killed in the combat, or who engaged the conqueror. This post was usually taken by lot.

SEDAN is a town in France, in the department of the Ardennes, in E. Long. 4. 45. N. Lat. 49. 46. This is the capital of a principality of the same name, situated on the Maese, six miles from Bouillon, and fifteen from Charleville. Its situation on the frontiers of the territory of Liege, Namur, and Limburg, formerly rendered it one of the keys of the kingdom. It is extremely well fortified, and defended by a strong citadel. The castle is situated on a rock, surrounded with large towers and strong walls; here you see a most beautiful magazine of ancient arms. The governor's palace is opposite the castle. From the ramparts you have a most agreeable prospect of the Maese and the neighbouring country. Though the town is but small, yet it is full of tradesmen, as tanners, weavers, dyers, &c. the manufacture of fine cloth in this city employing a great number of hands. The principality of Sedan formerly belonged to the duke of Bourbon, who was obliged in the beginning of the last century to resign it to the crown.

SEDAN-CHAIR is a covered vehicle for carrying a single person, supported by two poles, and borne by two men, hence denominated *chairmen*. They were first introduced in London in 1633, when Sir Sanders Dancomb obtained the sole privilege to use, let, and hire a number of the said covered chairs for fourteen years.

SEDMOOR, a large and rich tract of land in Somersetshire, memorable for the defeat of the duke of Monmouth, in 1685. It lies between Somerton and Bridgewater.

SEDITION, among civilians, is used for a factious commotion of the people, or an assembly of a number of citizens without lawful authority, tending to disturb the peace and order of the society. This offence is of different kinds: some seditions more immediately threatening the supreme power, and the subversion of the present constitution of the state; others tending only towards the redress of private grievances. Among the Romans, therefore, it was variously punished, according as its end and tendency threatened greater mischief. See lib. i. *Cod. de Seditione*, and *Mat. de Crimine*. lib. ii. n. 5. de *Lege Majestatis*. In the punishment, the authors and ringleaders were justly distinguished from those who, with less wicked intention, joined and made part of the multitude.

The same distinction holds in the law of England and in that of Scotland. Some kinds of sedition in England amount to high treason, and come within the stat. 25 Edw. III. as levying war against the king. And several seditions are mentioned in the Scotch acts of parliament as treasonable. *Bayne's Crim. Law of Scotland*, p. 33, 34. The law of Scotland makes riot-

Sedition
||
Sedley.

ous and tumultuous assemblies a species of sedition. But the law there, as well as in England, is now chiefly regulated by the riot act, made 1 Geo. I. only it is to be observed, that the proper officers in Scotland, to make the proclamation thereby enacted, are sheriffs, stewards, and bailies of regality, or their deputies; magistrates of royal boroughs, and all other inferior judges and magistrates; high and petty constables, or other officers of the peace, in any county, stewartry, city, or town. And in that part of the island, the punishment of the offence is any thing short of death which the judges, in their discretion, may appoint.

SEDATIVES, in *Medicine*, a general name for such medicines as weaken the powers of nature, such as blood-letting, cooling pills, purgatives, &c.

SE-DEFENDENDO, in *Law*, a plea used for him that is charged with the death of another, by alleging that he was under a necessity of doing what he did in his own defence: as that the other assaulted him in such a manner, that if he had not done what he did, he must have been in hazard of his own life. See HOMICIDE and MURDER.

SEDIAMENT, the settlement or dregs of any thing, or that gross heavy part of a fluid body which sinks to the bottom of the vessel when at rest.

SEDDLEY, SIR CHARLES, an English poet and writer, the son of Sir John Sedley of Aylesford in Kent, was born about the year 1639. At the restoration he came to London to join the general jubilee; and commenced wit, courtier, poet, and gallant. He was so much admired, that he became a kind of oracle among the poets; which made King Charles tell him, that Nature had given him a patent to be Apollo's vicerey. The productions of his pen were some plays, and several delicately tender amorous poems, in which the softness of the verses was so exquisite, as to be called by the duke of Buckingham *Sedley's witchcraft*. "There were no marks of genius or true poetry to be desired, (say the authors of the *Biographia Britannica*); the art wholly consisted in raising loose thoughts and low desires, without giving any alarm; and so the poison worked gently and insensibly. Our author, we may be sure, did not escape the infection of his own art, or rather was first tainted himself before he spread the infection to others."—A very ingenious writer of the present day, however, speaks much more favourably of Sir Charles Sedley's writings. "He studied human nature; and was distinguished for the art of making himself agreeable, particularly to the ladies; for the verses of Lord Rochester, beginning with, *Sedley has that pleasing gentle art*, &c. so often quoted, allude not to his writings, but to his personal address." [*Langhorn's Essays*, &c.].—But while he thus grew in reputation for wit and in favour with the King, he grew poor and debauched: his estate was impaired, and his morals were corrupted. One of his frolics, however, being followed by an inditement and a heavy fine, Sir Charles took a more serious turn, applied himself to business, and became a member of parliament, in which he was a frequent speaker. We find him in the house of commons in the reign of James II. whose attempts upon the constitution he vigorously withstood; and he was very active in bringing on the revolution. This was thought more extraordinary, as he had received favour from James. But that prince had taken a fancy to Sir Charles.

Sedley
||
Seduction.

Charles's daughter (though it seems she was not very handsome), and, in consequence of his intrigues with her, he created Miss Sedley countess of Dorchester. This honour, so far from pleasing, greatly shocked Sir Charles. However libertine he himself had been, yet he could not bear the thoughts of his daughter's dishonour; and with regard to her evaluation, he only considered it as rendering her more conspicuously infamous. He therefore conceived a hatred for the king; and from this, as well as other motives, readily joined to dispossess him of the throne. A witty saying of Sedley's, on this occasion, is recorded. "I hate ingratitude, (said Sir Charles); and therefore, as the king has made my daughter a countess, I will endeavour to make his daughter a queen;" meaning the princess Mary, married to the prince of Orange, who dispossessed James of the throne at the revolution. He lived to the beginning of Queen Anne's reign; and his works were printed in two vols. 8vo. 1710.

SEDR, or SEDRE, the high-priest of the sect of Ali among the Persians. The sedie is appointed by the emperor of Persia, who usually confers the dignity on his nearest relation. The jurisdiction of the sedre extends over all effects destined for pious purposes, over all mosques, hospitals, colleges, sepulchres, and monasteries. He disposes of all ecclesiastical employments, and nominates all the superiors of religious houses. His decisions in matters of religion are received as so many infallible oracles: he judges of all criminal matters in his own house without appeal. His authority is balanced by that of the muditehid, or first theologue of the empire.

SEDUCTION, is the act of tempting and drawing aside from the right path, and comprehends every endeavour to corrupt any individual of the human race. This is the import of the word in its largest and most general sense; but it is commonly employed to express the act of tempting a virtuous woman to part with her chastity.

The *feducer* of female innocence practises the same stratagems of fraud to get possession of a woman's person, that the *swindler* employs to get possession of his neighbour's goods or money; yet the law of honour, which pretends to abhor *deceit*, and which imels its votaries to *murder* every man who presumes, however justly, to suspect them of fraud, or to question their veracity, applauds the address of a successful intrigue, though it be well known that the *feducer* could not have obtained his end without swearing to the truth of a thousand falsehoods, and calling upon God to witness promises which he never meant to fulfil.

The law of honour is indeed a very capricious rule, which accommodates itself to the pleasures and conveniences of higher life; but the law of the land, which is enacted for the equal protection of high and low, may be supposed to view the guilt of seduction with a more impartial eye. Yet for this offence, even the laws of this kingdom have provided no other punishment than a pecuniary satisfaction to the injured family; which, in England, can be obtained only by one of the quaintest fictions in the world, by the father's bringing his action against the *feducer* for the loss of his daughter's service during her pregnancy and nursing. See Paley's *Moral Phil. Essay*, Book III. Part iii. Chap. 3.

The mercantile, however, who estimates the merit or

demeit of actions, not by laws of human appointment, but by their general consequences as established by the laws of nature, must consider the *feducer* as a criminal of the deepest guilt. In every civilized country, and in many countries where civilization has made but small progress, the virtue of women is collected as it were into a single point, which they are to guard above all things, as that on which their happiness and reputation wholly depend. At first sight this may appear a capricious regulation; but a moment's reflection will convince us of the contrary. In the married state so much confidence is necessarily reposed in the fidelity of women to the beds of their husbands, and evils so great result from the violation of that fidelity, that whatever contributes in any degree to its preservation, must be agreeable to him who, in establishing the laws of nature, intended them to be subservient to the real happiness of all his creatures. But nothing contributes so much to preserve the fidelity of wives to their husbands, as the impressing upon the minds of women the highest veneration for the virtue of chastity. She who, when unmarried, has been accustomed to grant favours to different men, will not find it easy, if indeed possible, to resist afterwards the allurements of variety. It is therefore a wise institution, and agreeable to the will of Him who made us, to train up women so as that they may look upon the loss of their chastity as the most disgraceful of all crimes; as that which sinks them in the order of society, and robs them of all their value. In this light virtuous women actually look upon the loss of chastity. The importance of that virtue has been so deeply impressed upon their minds, and is so closely associated with the principle of honour, that they cannot think but with abhorrence upon the very deed by which it is lost. He therefore who by fraud and falsehood persuades the unsuspecting girl to deviate in one instance from the honour of the sex, weakens in a great degree her moral principle; and if he reconcile her to a repetition of her crime, he destroys that principle entirely, as she has been taught to consider all other virtues as inferior to that of chastity. Hence it is that the hearts of prostitutes are generally steeled against the miseries of their fellow-creatures; that they lend their aid to the *feducer* in his practices upon other girls; that they lie and swear and steal without compunction; and that too many of them hesitate not to commit murder if it can serve any selfish purpose of their own.

The loss of virtue, though the greatest that man or woman can sustain, is not the only injury which the *feducer* brings on the girl whom he deceives. She cannot at once reconcile herself to prostitution, or even to the loss of character; and while a sense of shame remains in her mind, the misery which she suffers must be exquisite. She knows that she has forfeited what in the female character is most valued by both sexes; and she must be under the perpetual dread of a discovery. She cannot even confide in the honour of her *feducer*, who may reveal her secret in a fit of drunkenness, and thus rob her of her fame as well as of her virtue; and while she is in this state of anxious uncertainty, the agony of her mind must be insupportable. That it is so in fact, the many instances of child murder by unmarried women of every rank leave us no room to doubt. The affection of a mother to her new-born child is one of the most unequivocal and strongest instincts in human nature

Seduction.

Seduction. nature (see **INSTINCT**); and nothing short of the extremity of distress could prompt any one so far to oppose her nature as to embrace her hands in the blood of her imploring infant.

Even this deed of horror seldom prevents a detection of the mother's frailty, which is indeed commonly discovered, though no child has been the consequence of her intrigue. He who can seduce is base enough to betray; and no woman can part with her honour, and retain any well-grounded hope that her amour shall be kept secret. The villain to whom the surrendered will glory in his victory, if it was with difficulty obtained; and if the surrendered at discretion, her own behaviour will reveal her secret. Her reputation is then irretrievably lost, and no future circumspection will be of the smallest avail to recover it. She will be thinned by the virtuous part of her own sex, and treated as a mere instrument of pleasure by the other. In such circumstances she cannot expect to be married with advantage. She may perhaps be able to captivate the heart of a heedless youth, and prevail upon him to unite his fate to hers before the delirium of his passion shall give him time for reflection; he may be addressed by a man who is a stranger to her story, and married while he has no suspicion of her secret; or the may be solicited by one of a station inferior to her own, who, though acquainted with every thing that has befallen her, can barter the delicacy of wedded love for some pecuniary advantage; but from none of these marriages can the look for happiness. The delirium which prompted the suit will soon vanish, and leave the husband to the bitterness of his own reflections, which can hardly fail to produce cruelty to the wife. Of the secret, to which, in the second case, the lover was a stranger, the husband will soon make a discovery, or at least find room for harbouring strong suspicions; and suspicions of having been deceived in a point so delicate have hitherto been uniformly the parents of misery. In the third case, the man married her merely for money, of which having got the possession, he has no farther inducement to treat her with respect. Such are some of the consequences of seduction, even when the person seduced has the good fortune to get afterwards a husband; but this is a fortune which few in her circumstances can reasonably expect. By far the greater part of those who have been defrauded of their virtue by the arts of the seducer sink deeper and deeper into guilt, till they become at last common prostitutes. The public is then deprived of their service as wives and parents; and instead of contributing to the population of the state, and to the sum of domestic felicity, these outcasts of society become seducers in their turn, corrupting the morals of every young man whose appetites they can inflame, and of every young woman whom they can entice to their own practices.

All this complication of evil is produced at first by arts, which, if employed to deprive a man of his property, would subject the offender to the execration of his fellow-subjects, and to an ignominious death; but while the forger of a bill is pursued with relentless rigour by the ministers of justice, and the founder loaded with universal reproach, the man who by fraud and forgery has enticed an innocent girl to gratify his desires at the expence of her virtue, and thus introduced her into a path which must infallibly lead to her own

ruin, as well as to repeated injuries to the public at large, is not despised by his own sex, and is too often carelessly even by the virtuous part of the other. Yet the loss of property may be easily repaired; the loss of honour is irreparable! It is vain to plead in alleviation of this guilt, that women should be on their guard against the arts of the seducer. Most unquestionably they should; but arts have been used which hardly any degree of caution would have been sufficient to counteract. It may as well be said that the trader should be on his guard against the arts of the forger, and accept of no bill without previously consulting him in whose name it is written. Cases, indeed, occur in trade, in which this caution would be impossible; but he must be little acquainted with the workings of the human heart, who does not know that situations likewise occur in life, in which it is equally impossible for a girl of virtue and tenderness to resist the arts of the man who has completely gained her affections.

The mentioning of this circumstance leads us to consider another species of seduction, which, though not so highly criminal as the former, is yet far removed from innocence; we mean the practice which is too prevalent among young men of fortune of employing every art in their power to gain the hearts of heedless girls whom they resolve neither to marry nor to rob of their honour. Should a man adhere to the latter part of this resolution, which is more than common fortitude can always promise for itself, the injury which he does to the object of his amusement is yet very great, as he raises hopes of the most sanguine kind merely to disappoint them, and diverts her affections perhaps for ever from such men as, had they been fixed on one of them, might have rendered her completely happy. Disappointments of this kind have sometimes been fatal to the unhappy girl; and even when they have neither deprived her of life, nor disordered her reason, they have often kept her wholly from marriage, which, whatever it be to a man, is that from which every woman expects her chief happiness. We cannot therefore conclude this article more properly than with warning our female readers not to give up their hearts hastily to men whose station in life is much higher than their own; and we beg leave to assure every one of them, that the man who solicits the last favour under the most solemn promise of a subsequent marriage, is a base seducer, who prefers a momentary gratification of his own to her honour and happiness through life, and has no intention to fulfil his promise. Or, if he should by any means be compelled to fulfil it, the may depend upon much ill treatment in return for her premature compliance with his base desires.

SEDUM, **ORPINE**, a genus of plants belonging to the decandria class, and in the natural method ranking under the 13th order, *Succulentæ*. See **BOTANY INDEX**.

SEED, in *Physiology*, a substance prepared by nature for the reproduction and conservation of the species both in animals and plants. See **BOTANY** and **PHYSIOLOGY**.

SEEDLINGS, among gardeners, denote such roots of gilliflowers, &c. as come from seed sown. Also the young tender shoots of any plants that are newly sown.

SEEDS, PRESERVATION OF, in a state fit for vegetation, is a matter of great and general importance, be-

Seduction
||
Seeds.

See's
S. S. S.

case, it will be possible to accomplish it, we shall thus be enabled to rear many useful plants in one country which are there unknown, being indigenous only in others at a great distance from it.

A gentleman informs us, that many years ago he observed some feeds which had got accidentally among rains, being such as are raised in England with difficulty, after being sent from abroad in the usual manner. He sowed them in pots within a framing; and as every one of them grew, he sent orders to his sons, who were at that time abroad, to pack up all kinds of seeds they could procure, in absorbent paper, and send some of them surrounded by rains, and others by brown moist figs; concluding, that the preservation of the former seeds had been owing to a peculiarly favourable state of the moisture thus afforded them. He likewise concluded that, as many of our common feeds, such as clover, charlock, &c. would lie dormant for ages within the earth, well preserved for vegetation whenever they were thrown to its surface, and exposed to the influence of the atmosphere, so likewise might these foreign feeds be equally preserved, at least for many months, by the kindly covering and genial moisture afforded them by figs or raisins. This opinion was fully verified, as not one in twenty of them failed to vegetate, while the same species of feeds sent home in common parcels along with them, did not vegetate at all. Having examined them prior to their being committed to the earth, he observed that there was a prevailing dyspepsia in the latter, while the former looked healthy and fresh, not being in the smallest degree infested by insects, as was the case with the others. It has been repeatedly tried to convey feeds cloaked up in hoar, but this method has failed of success, a larger proportion of air, as well as a proper state of moisture, perhaps being necessary. It may be requisite to observe, that no difference was made in the package of the feeds, respecting their being kept in huts, pods, &c. so as to give those preserved in rains or sugar any advantage over the others, the whole being sent equally guarded by their natural teguments.

SEEDY, in the brandy trade, a term used by the dealers to denote a fault that is found in several parcels of French brandy, which renders them unsaleable. The French suppose that these brandies obtain the flavour which they express by this name, from weeds that grow among the vines from whence the wine of which this brandy is pressed was made.

SEEING, the perceiving of external objects by means of the eye. For an account of the organs of sight, and the nature of vision, see **ANATOMY** and **OPTICS Index**.

SEEKS, a religious sect settled at Patna, and so called from a word contained in one of the commandments of their founder, which signifies *learn thou*. In books giving an account of oriental sects and oriental customs, we find mention made both of *Seeks* and *Seiks*; and we are strongly inclined to think that the same tribe is meant to be denominated by both words. If so, different authors write very differently of their principles and manners. We have already related something of the character of the *Seeks* under the article **HINDOOS**; but in the Asiatic Researches, Mr Wilkins gives a much more amiable account of the *Seeks*, which we lay before our readers with pleasure.

The *Seeks* are a sect distinguished both from the

Muslims and the worshippers of Brahma; and, from our author's account of them, must be an amiable people. He asked leave to enter into their chapel: They said it was a place of worship, open to all men, but intimated that he must take off his shoes. On complying with this ceremony, he was politely conducted into the hall, and seated upon a carpet in the midst of the assembly. The whole building forms a square of about 40 feet. The hall is in the centre, divided from four other apartments by wooden arches, upon pillars of the same materials. The walls above the arches were hung with European looking-glasses in gilt frames, and with pictures. On the left hand, as one enters, is the chancel, which is furnished with an altar covered with cloth of gold, raised a little above the ground in a declining position. About it were several flower-pots and rose-water bottles, and three urns to receive the donations of the charitable. On a low desk, near the altar, stood a great book, of folio size, from which some portions are daily read in the divine service. When notice was given that it was *noon*, the congregation arranged themselves upon the carpet on each side of the hall. The great book and desk were brought from the altar, and placed at the opposite extremity. An old silver-haired man kneeled down before the desk, with his face towards the altar, and by him sat a man with a drum, and two or three with cymbals. The book was now opened, and the old man began to chant to the time of the instruments, and at the conclusion of every verse most of the congregation joined chorus in a response, with countenances exhibiting great marks of joy. Their tones were not harsh; the time was quick; and Mr Wilkins learned that the subject was a hymn in praise of the unity, omnipresence, and omnipotence of the Deity. The hymn concluded, the whole company got up and presented their faces, with joined hands, towards the altar in the attitude of prayer. The prayer was a sort of litany pronounced by a young man in a loud and distinct voice; the people joining, at certain periods, in a general response. This prayer was followed by a short blessing from the old man, and an invitation to the assembly to partake of a friendly feast. A share was offered to Mr Wilkins, who was too polite to refuse it. It was a kind of sweetmeat composed of sugar and flower mixed up with clarified butter. They were next served with a few sugar plums; and thus ended the feast and ceremony.

In the course of conversation Mr Wilkins learned that the founder of this sect was *Naneek Sah*, who lived about 400 years ago; who left behind him a book, composed by himself in verse, containing the doctrines he had established; that this book teaches, that there is but one God, filling all space, and pervading all matter; and that there will be a day of retribution, when virtue will be rewarded, and vice punished. (Our author forgot to ask in what manner). It forbids murder, theft, and such other deeds as are by the majority of mankind esteemed crimes, and inculcates the practice of all the virtues; but, particularly, a universal philanthropy and hospitality to strangers and travellers. It not only commands universal toleration, but forbids disputes with those of another persuasion. If any one show a sincere inclination to be admitted among them, any five or more *Seeks* being assembled in any place, even on the highway, they send to the first shop where sweet-

Seeks

* Description
of the
Seeks of
Ind.
no. 11.

Segele,
Segalien.

Segele
II
Segalien

meats are fold, and procure a very small quantity of a particular kind called *batigiti* (Mr Wilkins does not tell us of what it is composed), which having diluted in pure water, they sprinkle some of it on the body and eyes of the profelyte, whilst one of the best instructed repeats to him the chief canons of their faith, and extracts from him a solemn promise to abide by them the rest of his life. They offered to admit Mr Wilkins into their society; but he declined the honour, contenting himself with their alphabet, which they told him to guard as the apple of his eye, as it was a sacred character. Mr Wilkins finds it but little different from the Dewanagari. The language itself is a mixture of Persian, Arabic, and Sanscrit, grafted upon the provincial dialect of Punjab, which is a kind of Hindowee, or, as we commonly call it, *Moors*.

SEGALIEN, a large island separated from the coast of Chinese Tartary by a narrow channel. It is called Tchoka by the natives, and Oku-Jeffu by the Chinese. It is situated between 46° and 54° N. Lat.; but its breadth from east to west is unknown. The frigates under the command of Perouse came to anchor in different bays, to the finest of which, in 48° 59' N. Lat. and 140° 32' E. Long. from Paris, the French commodore gave the name of Baie d'Eltaing.

Segalien is well wooded, and mountainous towards the centre, but flat and level along the coast, the soil of which is peculiarly favourable to agriculture; and vegetation is extremely vigorous. The whole surface is almost covered with forests of pine, birch, oak, and willow trees; and the seas, rivers, and brooks, abound with excellent salmon and trout. In general, the weather is mild and foggy; and the inhabitants are healthy and strong, and many of them live to an extreme old age. The presents received by the natives from the French, were only valued in proportion to their utility. They make use of looms, which are complete instruments, though small. The inhabitants in general do not exceed five feet in height, although some of the tallest measure about five feet four inches. Their countenances are animated and agreeable; their cheeks are large, their nose rounded at the extremity; they have strong voices, and rather thick lips, which are of a dull red.

The women are not so tall as the men, but of a more rounded and delicate form, with dresses nearly similar; their upper lip is tattooed all over of a blue colour; the hair of their head is black, smooth, and of a moderate strength, worn about six inches long behind, and they cut it into a brush on the top of their head and over the temples. They wear surtouts of skin or quilted nankeen, which reaches to the calf of the leg, and sometimes lower, by which the use of drawers is in a great measure rendered unnecessary. They all wear girdles, like the lower orders among the Chinese, from which a knife is suspended as a defence against the bears, and a number of small pockets for holding their flint and steel, pipe and box of tobacco, for they are very great smokers. Their huts are small in proportion to the number of inhabitants they contain, but sufficient to defend them against the rain and other inconveniences of the atmosphere. The roof consists of two inclined planes, from 10 to 12 feet high at their union, and three or four on the sides; the breadth of the roof is 14, and its length 18 feet. They use iron pots in cooking, also shells,

vessels made of wood and birch bark, of different forms and workmanship. They have two meals a-day, the one at noon, and the other in the evening. Each family has its own hunting and fishing implements, and their arms are bows, javelins, and a kind of sponoon, which last is employed in hunting the bear.

The only domestic animals are dogs, of a middling size, with shaggy hair, pricked ears, and a long sharp muzzle, with a loud but not savage cry.

The people of Segalien are of a mild and unsuspecting disposition, and appear to hold a commercial intercourse with the Chinese through the medium of the Mantcho Tartars, with the Russians to the north of their island, and the Japanese to the south; but the articles of trade consist only of a few furs and whale oil.

SEGBERG, a town of Germany, in the duchy of Holstein, and in Wagria; with a castle standing on a high mountain, consisting of lime one, large quantities of which are carried to Hamburg and Lubeck. It belongs to Denmark, and is seated on the river Treve, in E. Long. 10. 9. N. Lat. 54. 0.

SEGEDIN, a strong town of Lower Hungary, in the county of Czongrad, with a castle. The Imperialists took it from the Turks in 1686. It is seated at the confluence of the rivers Tefse and Malroch, in E. Long. 20. 35. N. Lat. 46. 28.

SEGMENT of a CIRCLE, in Geometry, is that part of the circle contained between a chord and an arch of the same circle.

SEGMENTS, LINE OF, two particular lines on Gunter's sector. They lie between the lines of sines and superficies, and are numbered, 5, 6, 7, 8, 9, 10. They represent the diameter of a circle, so divided into 100 parts, that a right line drawn through these parts, and perpendicular to the diameter, shall cut the circle into two segments, the greater of which shall have the same proportion to the whole circle, as the parts cut off have to 100.

SEGNA, a city of Croatia, belonging to the house of Austria, and seated on the coast of the gulf of Venice. It was formerly a place of strength and great importance; but it has suffered many calamities, and its inhabitants at present do not amount to 7000. In the beginning of this century it sent 50 merchant ships to sea; but the inconviency of its situation and badness of its harbour, in which the sea is never calm, discouraged navigation, and Segna has now very few ships belonging to it. Among the customs of the Segnans, Mr Fortis mentions one relative to the dead, which for its singularity may be worthy of notice.

"All the relations and friends of the family go to kiss the corpse, by way of taking leave, before burial. Each of them uncovers the face, over which a handkerchief is spread, more or less rich according to the family; having kissed the dead person, every one throws another handkerchief over the face; all which remain to the heirs, and sometimes there are 20, 30, and more at this ceremony. Some throw all these handkerchiefs into the grave with the corpse, and this, in former times, was the general custom; but then they were rich. This seems to have been brought into use as a substitute for the ancient *casti lacrymatum*." E. Long. 15. 24. N. Lat. 47. 22.

SEGNI, an ancient town of Italy, in the Campagna.

of Rome, with a bishop's see, and the title of duchy. It is said that organs were first invented here. It is seated on a mountain. E. Long. 13. 15. N. Lat. 41. 30.

SEGO, the metropolis of the kingdom of Bambarra in Africa, on the banks of the Niger, in N. Lat. 14. 4. and W. Long. 2. 1. It consists of four distinct towns, two on the northern bank of the river, called Sego Korro, and Sego Jesso; and two on the southern bank, called Sego Sso Korro, and Sego See Korro, all surrounded with lofty mud walls, and the houses are constructed of clay, several of them two stories high, and even white-washed. Mosques are to be seen in every quarter, and the streets, though narrow, are sufficiently broad for every useful purpose, where wheel-carriages are wholly unknown. According to Mr Park, the inhabitants of Sego amount to 30,000; and it is the constant residence of the king of Bambarra, a considerable part of whose revenue arises from the fare given by passengers for crossing the river. The people, however, are not so hospitable as in many other African towns, as the Moors are here very numerous, whose bigotry renders them the implacable enemies of every white man, if suspected of being a Christian.

Mr Park being therefore prohibited from living in Sego, resided for three days in an adjacent village, and was dismissed on the fourth, after receiving 5000 kowries from the king, to enable him to buy provisions in the course of his journey; and although it amounted only to 20s. sterling, to very cheap were the necessaries of life in Bambarra, that he found it sufficient to procure provisions for himself, and corn for his horse, for not fewer than 10 days.

SEGOBDE, a town of Spain, in the kingdom of Valencia, with the title of a duchy, and a bishop's see. It is seated on the side of a hill, between the mountains, to a soil very fertile in corn and wine, and where there are quarries of fine marble. It was taken from the Moors in 1243; and the Romans thought it worth their while to carry some of the marble to Rome. W. Long. 0. 3. N. Lat. 39. 48.

SEGOVIA, an ancient city of Spain, of great power in the time of the Cæsars, is built upon two hills near the banks of the Araya in Old Castile. W. Long. 3. 48. N. Lat. 41. 0. It is still a bishop's see, and is distinguished for some venerable remains of antiquity. In the year 1525 the city contained 5000 families, but now they do not surpass 2000, a scanty population for 25 parishes; yet, beside 21 churches and a cathedral, there are 21 convents.

The first object in Segovia that attracts the eye is the aqueduct, which the singular situation of the city renders necessary. As it is built upon two hills, and the valley by which they are separated, and extends considerably in every direction, it was difficult for a part of the citizens to be supplied with water. The difficulty was removed, according to the opinion of the learned, in the reign of Trojan, by this aqueduct, which is one of the most astonishing and the best preserved of the Roman works. In the opinion of Mr Swinburne, who surveyed it in 1776, and who seems to have given a very accurate account of the curiosities of Segovia, it is superior in elegance of proportion to the Pont du Gard at Nîmes. It is so perfectly well preserved, that it does not seem leaky in any part. From the first low arches to the reservoir in the town, its length is 2400

Spanish feet, its greatest height (in the Plaza del Azobujo at the foot of the walls) is 124; it is there composed of a double row of arches, built of large square stones without mortar, and over them a hollow wall of coarser materials for the channel of the water, covered with large oblong flags. Of the lower range of arcades, which are 15 feet wide by 6½ high, there are 42. The upper arches are 119 in number, their height 27 Spanish feet, their breadth seventeen, the transverse thickness, or depth of the piers, eight feet.

The cathedral is a mixture of the Gothic and Moorish architecture. The inside is very spacious and of majestic simplicity. The windows are well disposed, and the great altar has been lately decorated with the finest Grenadan marble. But it is to be regretted, that in this cathedral, as well as in most others of Spain, the choir is placed in the middle of the nave. The church is nearly upon the model of the great church of Salamanca, but it is not so highly finished.

The alcazar, or ancient palace of the Moors, stands in one of the finest positions possible, on a rock rising above the open country. A fine river washes the foot of the precipice, and the city lies admirably well on each side on the brow of the hill; the declivity is woody, and the banks charmingly rural; the snowy mountains and dark forests of Sant Ildefonso compose an awful back-ground to the picture. Towards the town there is a large court before the great outward tower, which, as the palace of Gil Blas, is so well described by Le Sage, that the subject requires no farther explanation. The rest of the buildings form an antique palace, which has seldom been inhabited by any but prisoners since the reign of Ferdinand and Isabella, who were much attached to this situation. There are some magnificent halls in it, with much gilding in the ceilings, in a semi-barbarous taste. All the kings of Spain are seated in state along the cornice of the great saloon; but it is doubtful whether they are like the princes whose names they bear; if that resemblance, however, be wanting, they have no other merit to claim. The royal apartments are now occupied by a college of young gentlemen cadets, educated at the king's expence in all the sciences requisite for forming an engineer. The grand-matter of the ordnance resides at Segovia, which is the head establishment of the Spanish artillery.

The mint is below the alcazar, a large building, the most ancient place of coinage in the kingdom. The machines for melting, stamping, and milling the coin, are worked by water; but there is reason to believe that Seville has at present more business, as being nearer the source of riches, the port of Cadiz, where the ingots of America are landed.

The unevenness of the crown of the hill gives a wild look to this city. Most of the streets are crooked and dirty, the houses wooden and very wretched; nor do the inhabitants appear much the richer for their cloth manufactory. Indeed, it is not in a very flourishing condition, but what cloth they make is very fine.

The country about Segovia has the reputation of being the best for rearing the kind of sheep that produces the beautiful Spanish wool; but as those flocks wander over many other parts of the kingdom, Segovia seems to have no exclusive title to this reputation. Segovia (says Mr Townsend, whose valuable travels will be read with much pleasure) was once famous for its cloth made on the

Segovia
 ||
 Sejanus.
 ||
 Seregus
 ||
 Sereus
 ||
 Sereus
 ||
 Sereus
 ||
 Sereus

the king's account; but other nations have since become rivals in this branch, and the manufacture in this city has been gradually declining. When the king gave it up to a private company, he left about 30000 in trade; but now he is no longer a partner in the business. In the year 1612 were made here 27,500 pieces of cloth, which consumed 44,625 quintals of wool, employed 34,189 persons; but at present they make only about 4000 pieces. The principal imperfections of this cloth are, that the thread is not even, and that much grease remains in it when it is delivered to the dyer; in consequence of which the colour is apt to fail. Yet, independently of imperfections, so many are the disadvantages under which the manufacture labours, that foreigners can afford to pay 3*l*. for the arroba of fine wool, for which the Spaniard gives no more than 20*s*. and after all his charges can command the market even in the ports of Spain.

SEGOVIA, *Nova*, a town of North America, in New Spain, and in the audience of Guatimola; seated on the river Yare, on the confines of the province of Honduras. W. Long. 84. 30. N. Lat. 13. 25.

SEGOVIA, a town of America, in Terra Firma, and in the province of Venezuela, seated on a river, near a very high mountain, where there are mines of gold. W. Long. 65. 30. N. Lat. 8. 20.

SEGOVIA, a town of Asia, in the island of Manila, and one of the largest of the Philippines, seated at the north end of the island, 240 miles north of Manila, and subject to Spain. E. Long. 122. 59. N. Lat. 18. 36.

SEGREANT, is the herald's word for a griffin when drawn in a leaping posture, and displaying his wings as if ready to fly.

SEGUE, in the Italian music, is often found before *aria, alleluja, amen*, &c. to show that those portions or parts are to be sung immediately after the last note of that part over which it is writ; but if these words *si placet*, or *ad libitum*, are joined therewith, it signifies, that these portions may be sung or not at pleasure.

SEGUIERIA, a genus of plants belonging to the class polyandria. See *BOTANY Index*.

SEIANI, a term used in heraldry, when a lion, or other beast, is drawn in an escutcheon sitting like a cat with his fore-feet straight.

SEJANUS, *JELIUS*, a native of Vallinum in Tuscany, who distinguished himself in the court of Tiberius. His father's name was Sereus Stribo; a Roman knight, commander of the pretorian guards. His mother was descended from the Junian family. Sejanus first gained the favour of Caius Caesar, the grandson of Augustus, but afterwards he attached himself to the interest and the views of Tiberius, who then sat on the imperial throne. The emperor, who was naturally of a suspicious temper, was free and open with Sejanus, and while he distrusted others, he communicated his greatest secrets to this fawning favourite. Sejanus improved this confidence; and when he had found that he possessed the esteem of Tiberius, he next endeavoured to become the favourite of the soldiers, and the darling of the senate. As commander of the pretorian guards he was the second man in Rome, and in that important office he made use of insinuations and every mean artifice to make himself beloved and revered. His assiduity and condescension gained him the heart of the common

soldier, and, by opposing all opposition, he advanced to places of trust and honour, till in the second century of the army became devoted to his interest. The views of Sejanus in this were well known; yet, to advance with more success, he attempted to gain the affection of the senators. In this he met with no opposition. A man who has the disposal of places of honour and dignity, and who has the command of the public money, cannot but be the favourite of those who are in need of his assistance. It is even said, that Sejanus gained to his views all the wives of the senators, by a private and most sacred promise of marriage to each of them, whenever he had made himself independent and sovereign of Rome. Yet, however successful with the best and noblest families in the empire, Sejanus had to combat numbers in the house of the emperor; but these seeming obstacles were soon removed. All the children and grandchildren of Tiberius were sacrificed to the ambition of the favourite under various pretences; and Drusus the son of the emperor, by thinking Sejanus made his destruction sure and inevitable. Livia, the wife of Drusus, was gained by Sejanus; and, though the mother of many children, she was prevailed upon to assist her adulterer in the murder of her husband, and she consented to marry him when Drusus was dead. No sooner was Drusus poisoned, than Sejanus openly declared his wish to marry Livia. This was strongly opposed by Tiberius; and the emperor, by recommending Germanicus to the senators for his successor, rendered Sejanus bold and determined. He was more urgent in his demands; and, when he could not gain the consent of the emperor, he persuaded him to retire to solitude from the noise of Rome and the troubles of the government. Tiberius, naturally fond of ease and luxury, yielded to his representations, and retired to Campania, leaving Sejanus at the head of the empire. This was highly gratifying to the favourite, but he was not without a master. Prudence and moderation might have made him what he wished to be; but having offended the emperor beyond forgiveness, he resolved to retrieve his loss, and by one vigorous effort to decide the fate of the empire. He called together his friends and followers; he paid court to such as seemed disaffected; he held forth rewards and promises; and, having increased the number of his partisans, formed a bold conspiracy, resolved by any means to seize the sovereign power.

A powerful league was formed with astonishing rapidity, and great numbers of all descriptions, senators as well as military men, entered it to the plot. Among these, Satrius Scandus was the confidential friend and prime agent of the minister. Whatever was this man's motive, whether fear, or views of interest, or ingratitude (for no principle of honour can be imputed to him), he resolved to betray the secret to Tiberius. For this purpose he addressed himself to Antonia, the daughter of Anthony the triumphant, the widow of Drusus, and the mother of Germanicus. When this illustrious woman, who was honoured by the court and revered by the people, heard the particulars, she sent dispatches to the emperor by one of her slaves. Tiberius was astonished, but not dismayed. The emperor praised his faithful servants was out of reason; the time called for vigorous and decisive measures. He sent Mero to Rome, with a special commission to take upon him the command of the pretorian guards. He added full instructions for

Temper
 ere's Dis-
 tinction.

See
 the
 Back

Sejanus. his conduct in all emergencies. Early in the morning on the 15th, before the kalends of November, a report was spread, that letters had arrived at Rome, in which the emperor signified his intentions to associate Sejanus with himself in the tribunitian power. The senate was summoned to meet in the temple of Apollo, near the imperial palace. Sejanus attended without delay. A party of the pretorians followed him. Macro met him in the vestibule of the temple. He approached the minister with all demonstrations of profound respect, and taking him aside, "Be not surprised (he said) that you have no letter from the prince: it is his pleasure to declare you his colleague in the tribunitian power; but he thinks that a matter of so much importance should be communicated to the fathers by the voice of the consuls. I am going to deliver the emperor's orders." Sejanus, elated with joy, and flushed with his new dignity, entered the senate-house; Macro followed him. As soon as the consuls arrived, he delivered the letter from Tiberius, and immediately went forth to the pretorian guards. He informed them, that by order of the prince, a large donative was to be distributed among the soldiers. He added, that, by a new commission, he himself was appointed their commanding officer; and, if they followed him to the camp, they would there receive the promised bounty. The lute was not thrown out in vain: the pretorian guards quitted their station. Laco, who stood near at hand, immediately surrounded the senate-house with a body of the city cohorts.

The letter to the consuls was confused, obscure, and tedious, only glancing at Sejanus, till at last the language of invective left no room for doubt. Sejanus kept his seat like a man benumbed, senseless and stupid with astonishment. His friends, who a little before congratulated him on his new dignity, deserted him on every side. He was commanded by the consul to rise and follow him, and being loaded with irons, was conducted to prison. His downfall filled the city with exultation. The populace, who worshipped him in the hour of prosperity, rejoiced to see the sad catastrophe to which he was now reduced. They followed in crowds, sending the air with shouts, and pouring forth a torrent of abuse and scurrilous language. The prisoner endeavoured to hide his face; but the mob delighted to see remonk and shame and guilt and horror in every feature of his distracted countenance. They reviled him for his acts of cruelty; they laughed at his wild ambition; they tore down his images, and dashed his statues to pieces. He was doomed by Tiberius to suffer death on that very day; but, as he had a powerful faction in the senate, it was, not thought advisable, for the mere formality of a regular condemnation, to hazard a debate. Private orders were given to Macro to dispatch him without delay; but the consul, seeing the dispositions of the people, and the calm neutrality of the pretorian guards, judged it best to re-associate the fathers. They met in the temple of Concord. With one voice Sejanus was condemned to die, and the sentence was executed without delay. He was strangled in the prison. His body was dragged to the Gemonie, and, after every species of insult from the populace, at the end of three days was thrown into the Tiber. Such was the tragic end of that ambitious favourite. He fell a terrible example to all, who, in any age or country, may

hereafter endeavour by their vices to rise above their fellow-citizens.

SEIGNIOR, or, in its general signification, the same with lord, but is particularly used for the lord of the fee as of a manor, as *seigneur* among the feudists is he who grants a fee or benefit out of the land to another; and the reason is, because having granted away the use and profit of the land, the property or dominion he still retains in himself.

SEIGNIORAGE, is a royalty or prerogative of the king, whereby he claims an allowance of gold and silver brought in the mals to be exchanged for coin. As *seigniorage*, put of every pound weight of gold, the king had for his coin 5s. of which he paid to the master of the mint sometimes 1s. and sometimes 1s. 6d. Upon every pound weight of silver, the *seigniorage* answered to the king in the time of Edward III. was 18 penny-weights, which then amounted to about 1s. out of which he sometimes paid 8d. at others 9d. to the master. In the reign of King Henry V. the king's *seigniorage* of every pound of silver was 1 5d. &c.

SEIGNIORY, is borrowed from the French *seigneurie*, i. e. *dominatus imperium, principatus*; and signifies with us a manor or lordship, *seigniorie de sokemans*. *Seigniorie in grofs*, seems to be the title of him who is not lord by means of any manor, but immediately in his own person; as *tenure in capite*, whereby one holds of the king, as of his crown, is *seigniorie in grofs*.

SEIKS. See **HINDOSTAN.**

SEISIN, in Law, signifies possession. In this sense we say, *premier seisin*, for the first possession, &c.

Seisin is divided into that in *deed* or *in fact*, and that in *law*. A *seisin in deed* is where a possession is actually taken: but a *seisin in law* is, where lands descend, and the party has not entered thereon; or, in other words, it is where a person has a right to lands, &c. and is by wrong disseised of them. A *seisin in law* is held to be sufficient to avow on; though to the bringing of an assize, actual seisin is required; and where seisin is alleged, the person pleading it must show of what estate he is seised, &c.

Seisin of a superior service is deemed to be a seisin of all superior and casual services that are incident thereto; and seisin of a lessee for years, is sufficient for him in reversion.

Livery of SEISIN, in Law, an essential ceremony in the conveyance of landed property; being no other than the pure feudal investiture, or delivery of corporal possession of the land or tenement. This was held absolutely necessary to complete the donation; *Nam feudum sine investitura nullo modo constitui potuit*: and an estate was then only perfect when, as Fleta expresses it in our law, *fit juris et seisinæ conjunctio*. See **FEORMENT.**

Investitures, in their original title, were probably intended to demonstrate in conquered countries the actual possession of the lord; and that he did not grant a bare litigious right, which the soldier was ill qualified to prosecute, but a peaceable and firm possession. And, at a time when writing was seldom practised, a mere oral gift, at a distance from the spot that was given, was not likely to be either long or accurately retained in the memory of bystanders, who were very little interested in the grant. Afterwards they were retained as a public and notorious act, that the country might take notice of and

testify

Seisin.

testify the transfer of the estate; and that such as claimed title by other means might know against whom to bring their actions.

In all well governed nations, some notoriety of this kind has been ever held requisite, in order to acquire and ascertain the property of lands. In the Roman law, *plenum dominium* was not said to subsist unless where a man had both the right and the corporal possession; which possession could not be acquired without both an actual intention to possess, and an actual seisin or entry into the premises, or part of them in the name of the whole. And even in ecclesiastical promotions, where the freehold passes to the person promoted, corporal possession is required at this day to vest the property completely in the new proprietor; who, according to the distinction of the canonists, acquires the *jus ad rem*, or inchoate and imperfect right, by nomination and institution; but not the *jus in re*, or complete and full right, unless by corporal possession. Therefore in dignities possession is given by instalment; in rectories and vicarages by induction; without which no temporal rights accrue to the minister, though every ecclesiastical power is vested in him by institution. So also even in descents of lands, by our law, which are cast on the heir by act of the law itself, the heir has not *plenum dominium*, or full and complete ownership, till he has made an actual corporal entry into the lands: for if he dies before entry made, his heir shall not be entitled to take the possession, but the heir of the person who was last actually seised. It is not therefore only a mere right to enter, but the actual entry, that makes a man complete owner; so as to transmit the inheritance to his own heirs: *non jus, sed seisina, facit hereditatem*.

Yet the corporal tradition of lands being sometimes inconvenient, a symbolical delivery of possession was in many cases anciently allowed; by transferring something near at hand, in the presence of credible witnesses, which by agreement should serve to represent the very thing designed to be conveyed; and an occupancy of this sign or symbol was permitted as equivalent to occupancy of the land itself. Among the Jews we find the evidence of a purchase thus defined in the book of Ruth: "Now this was the manner in former time in Israel, concerning redeeming and concerning changing, for to confirm all things: a man plucked off his shoe, and gave it to his neighbour; and this was a testimony in Israel." Among the ancient Goths and Swedes, contracts for the sale of lands were made in the presence of witnesses, who extended the cloak of the buyer, while the seller cast a clod of the land into it, in order to give possession; and a staff or wand was also delivered from the vendor to the vendee, which passed through the hands of the witnesses. With our Saxon ancestors the delivery of a turf was a necessary solemnity to establish the conveyance of lands. And, to this day, the conveyance of our copyhold estates is usually made from the seller to the lord or his steward by delivery of a rod or verge, and then from the lord to the purchaser by re-delivery of the same in the presence of a jury of tenants.

Conveyances in writing were the last and most refined improvement. The mere delivery of possession, either actual or symbolical, depending on the ocular testimony and remembrance of the witnesses, was liable to be forgotten or misrepresented, and became frequent-

Seisin.

ly incapable of proof. Besides, the new occasions and necessities introduced by the advancement of commerce, required means to be devised of charging and incumbering estates, and of making them liable to a multitude of conditions and minute designations, for the purposes of raising money, without an absolute sale of the land; and sometimes the like proceedings were found useful in order to make a decent and competent provision for the numerous branches of a family, and for other domestic views. None of which could be effected by a mere, simple, corporal transfer of the soil from one man to another, which was principally calculated for conveying an absolute unlimited dominion. Written deeds were therefore introduced, in order to specify and perpetuate the peculiar purposes of the party who conveyed: yet still, for a very long series of years, they were never made use of, but in company with the more ancient and notorious method of transfer by delivery of corporal possession.

Livery of seisin, by the common law, is necessary to be made upon every grant of an estate of freehold in hereditaments corporal, whether of inheritance or for life only. In hereditaments incorporeal it is impossible to be made; for they are not the object of the senses: and leases for years, or other chattel interests, it is not necessary. In leases for years indeed an actual entry is necessary, to vest the estate in the lessee: for a bare lease gives him only a right to enter, which is called his interest in the term, or *interesse termini*: and when he enters in pursuance of that right, he is then, and not before, in possession of his term, and complete tenant for years. This entry by the tenant himself serves the purpose of notoriety, as well as livery of seisin from the grantor could have done; which, it would have been improper to have given in this case, because that solemnity is appropriated to the conveyance of a freehold. And this is one reason why freeholds cannot be made to commence in futuro, because they cannot (at the common law) be made but by livery of seisin; which livery, being an actual manual tradition of the land, must take effect *in presenti*, or not at all.

Livery of seisin is either in deed or in law.

Livery in deed is thus performed. The feoffor, lessor, or his attorney, together with the feoffee, lessee, or his attorney, (for this may as effectually be done by deputy or attorney as by the principals themselves in person), come to the land or to the house; and there, in the presence of witnesses, declare the contents of the feoffment or lease on which livery is to be made. And then the feoffor, if it be of land, doth deliver to the feoffee, all other persons being out of the ground, a clod or turf, or a twig or bough thereof growing, with words to this effect: "I deliver these to you in the name of seisin of all the lands and tenements contained in this deed." But, if it be of a house, the feoffor must take the ring or latch of the door, the house being quite empty, and deliver it to the feoffee in the same form; and then the feoffee must enter alone, and shut the door, and then open it, and let in the others. If the conveyance or feoffment be of divers lands, lying scattered in one and the same county, then in the feoffor's possession, livery of seisin of any parcel, in the name of the rest, sufficeth for all; but if they be in several counties, there must be as many liveries as there are counties. For, if the title to these lands come to be disputed, there

Señ
Selden

must be as many trials as there are counties, and the jury of one county are no judges of the notoriety of a fact in another. Besides, anciently, this seisin was obliged to be delivered *coram paribus de vicinis*, before the peers or freeholders of the neighbourhood, who attested such delivery in the body or on the back of the deed; according to the rule of the feudal law, *Pares debent interesse investitura feodi, et non alii*: for which this reason is expressly given; because the peers or vassals of the lord, being bound by their oath of fealty, will take care that no fraud be committed to his prejudice, which strangers might be apt to connive at. And though afterwards the ocular attestation of the *pares* was held unnecessary, and livery might be made before any credible witnesses, yet the trial, in case it was disputed, (like that of all other attestations), was still reserved to the *pares* or jury of the county. Also, if the lands be out on lease, though all lie in the same county, there must be as many liveries as there are tenants: because no livery can be made in this case, but by the consent of the particular tenant; and the consent of one will not bind the rest. And in all these cases it is prudent, and usual, to endorse the livery of seisin on the back of the deed, specifying the manner, place, and time of making it; together with the names of the witnesses. And thus much for livery in deed.

Livery in law is where the same is not made on the land, but in sight of it only; the feoffor saying to the feoffee, "I give you yonder land, enter and take possession." Here, if the feoffee enters during the life of the feoffor, it is a good livery, but not otherwise; unless he dares not enter through fear of his life or bodily harm; and then his continual claim, made yearly in due form of law, as near as possible to the lands, will suffice without an entry. This livery in law cannot, however, be given or received by attorney, but only by the parties themselves.

SEIZE, in the sea-language, is to make sail or bind, particularly to fasten two ropes together with rope-yeave. The seizing of a boat is a rope tied to a ring or little chain in the fore-ship of the boat, by which means it is fastened to the side of the ship.

SEIZURE, in commerce, an arrest of some merchandise, moveable, or other matter, either in consequence of some law or of some express order of the sovereign. Contraband goods, those fraudulently entered, or landed without entering at all, or at wrong places, are subject to seizure. In seizures among us, one half goes to the informer, and the other half to the king.

SELAGO, a genus of plants belonging to the diuynamia class; and in the natural method ranking under the 48th order, *Aggregate*. See *BOTANY Indica*.

SELDEN, JOHN, called by Grotius *the glory of England*, was born at Salvington in Suffex in 1584. He was educated at the free school at Chichester; whence he was sent to Hart Hall in the university of Oxford, where he staid four years. In 1612, he entered himself in Clifford's Inn, in order to study the law; and about two years after removed to the Inner Temple, where he soon acquired great reputation by his learning. He had already published several of his works; and this year wrote verses in Latin, Greek, and English, upon Mr William Browne's *Britannia's Pastorals*.

Selden

In 1614, he published his *Titles of Honour*; and in 1616, his *Notes on Sir John Fortescue's book De Laudibus Legum Angliæ*. In 1618, he published his *History of Tythes*; which gave great offence to the clergy, and was animadverted upon by several writers; and for that book he was called before the high commission court, and obliged to make a public acknowledgment of his sorrow for having published it. In 1621, being sent for by the parliament, though he was not then a member of that house, and giving his opinion very strongly in favour of their privileges in opposition to the court, he was committed to the custody of the Sheriff of London, but was set at liberty after five weeks confinement. In 1623, he was chosen burgess for Lancaster; but, amidst all the divisions of the nation, kept himself neuter, prosecuting his studies with such application, that though he was the next year chosen reader of Lyon's Inn, he refused to perform that office. In 1625, he was chosen burgess for Great Bedwin in Wiltshire, to serve in the first parliament of King Charles I. in which he declared himself warmly against the duke of Buckingham; and on his Grace's being impeached by the House of Commons, was appointed one of the managers of the articles against him. In 1627 and 1628, he opposed the court party with great vigour. The parliament being prorogued to January 20. 1629, Mr Selden retired to the earl of Kent's house at Wilt, in Bedfordshire, where he finished his *Marmor Arundelliana*. The parliament being met, he, among others, again distinguished himself by his zeal against the court; and the king dissolving the parliament, ordered several of the members to be brought before the King's Bench bar, and committed to the Tower. Among these was Mr Selden, who insisting on the benefit of the laws, and refusing to make his submission, was removed to the King's Bench prison. Being here in danger of his life on account of the plague then raging in Southwark, he petitioned the lord high treasurer, at the end of Trinity term, to intercede with his Majesty that he might be removed to the Gate-house, Westminster, which was granted: but in Michaelmas term following, the judges objecting to the lord treasurer's warrant, by which he had been removed to the Gate-house, an order was made for conveying him back to the King's Bench, whence he was released in the latter end of the same year; but fifteen years after, the parliament ordered him 5000*l*. for the losses he had sustained on this occasion. He was afterwards committed with several other gentlemen, for dispersing a libel: but the author, who was abroad, being discovered, they were at length set at liberty. In 1634, a dispute arising between the English and Dutch concerning the herring-fishery on the British coast, he was prevailed upon by Archbishop Laud to draw up his *Mare Clausum*, in answer to Grotius's *Mare Liberum*: which greatly recommended him to the favour of the court. In 1639, he was chosen member for the university of Oxford; when he again opposed the court, though he might, by complying, have raised himself to very considerable posts. In 1643, he was appointed one of the lay-members to sit in the assembly of divines at Westminster, and was the same year appointed keeper of the records in the Tower. Whilst he attended his duty in the assembly, a warm debate arose respecting the distance of Jericho from Jerusalem. The party which contended for the shortest distance, urged, as a

proof

proof of their opinion being well considered, that fishes were carried from the one city to the other, and sold in the market. Their adversaries were ready to yield to the force of this conclusive argument, when Selden, who despised both parties, as well as the frivolousness of their dispute, exclaimed, "Perhaps the fishes were sold!" This unexpected remark led the victory doubtful, and renewed the debate; and our author, who was sick of such trifling, soon found employment more suited to his genius; for, in 1645, he was made one of the commissioners of the admiralty. This same year it was unanimously elected matter of Trinity college, Cambridge; but declined accepting. He died in 1654, and was interred in the Temple church, where a monument is erected to his memory. Dr Wilkes observes, that he was a man of uncommon gravity and greatness of soul, averse to flattery, liberal to scholars, charitable to the poor; and though he had great latitude in his principles with regard to ecclesiastical power, yet he had a sincere regard for the church of England. He wrote many learned works besides those already mentioned; the principal of which are, 1. *De Jure Naturæ et Gentium juxta Disciplinam Hebræorum*. 2. *De Nuptiis et Divorciis*. 3. *De Arto Civili veterum Hebræorum*. 4. *De Nummis*. 5. *De Diis Syris*. 6. *Uxor Hebræica*. 7. *Jani Anglorum Facies altera*, &c. All his works were printed together in 1726, in 3 vols folio.

SELENITE, in *Mineralogy*, the crystallized sulphate of lime or gypsum. See **LIME**, in **MINERALOGY Index**. Selenite literally signifies *moonstone*, and is possessive of the colour and soft lustre of the mineral.

SELENOGRAPHY, a branch of cosmography, which describes the moon and all the parts and appearances thereof, as geography does those of the earth. See **MOON**, and **ASTRONOMY Index**.

SELEUCIA, in *Ancient Geography*, furnished *Babylonia*, became situated on its confines, at the confluence of the Euphrates and Tigris. Ptolemy places it in Mesopotamia. It is called also *Sela in ad Tigrim*, (Ptolemy, Strabo, Iidorus Characenus); walked on the south by the Euphrates, on the east by the Tigris, (Theophrastus); generally agreed to have been built or enlarged by Seleucus Nicator, master of the east after Alexander; by means of which Babylon came to be deserted. It is said to have been originally called *Celsa*, (Anunian, Eutropius); though others, as Arrian, distinguish it, as a village, from *Selucia*; and, according to Zosimus, the ancient name of Selucia was *Zoelasia*. Now called *Bagdad*. E. Long. 44. 21. N. Lat. 33. 10. There were many other cities of the same name, all built by Seleucus Nicator.

SELEUCIDÆ, in *Chronology. Era of the Seleucidae, or the Syro-Macedonian era, is a computation of time, commencing from the establishment of the Seleucidae, a race of Greek Kings, who reigned as successors of Alexander the Great in Syria, as the Ptolemies did in Egypt. This era we find expressed in the books of the Maccabees, and on a great number of Greek medals struck by the cities of Syria, &c. The Rabbin call it the era of *contracts*, and the Arabs *sherk al-haramain*, that is, "the era of the two horns." According to the best accounts, the first year of this era falls in the year 311 B. C. being 12 years after Alexander's death.*

SELEUCUS, Nicator, one of the chief generals

under Alexander the Great, and, after his death, founder of the race of princes called *Seleucidae*. He is equally celebrated as a renowned warrior, and as the father of his people; yet his virtues could not protect him from the fatal ambition of Ceraunus, one of his courtiers, by whom he was assassinated 250 B. C.

SELF HEAL, the *PRUNELLA VULGARIS*, Lin. This herb was recommended by the older physicians as a mild redressing and vulnerary; but its virtues appear to be very feeble, and therefore it is now rarely used.

SELF COMMAND, is that steady equanimity which enables a man in every situation to exert his reasoning faculty with coolness, and to do what the present circumstances require. It depends much upon the natural temperament of the body, and much upon the moral cultivation of the mind. He who enjoys good health, and has braced his frame by exercise, has always a greater command of himself than a man of equal mental powers, who has followed his constitution to become relaxed by indolence; and he who has from his early youth been accustomed to make his passions submit to his reason, must, in any sudden emergency, be more capable of acting properly than he who has tamely yielded to his passion. Hence it is that replete and literary men, when forced into the bustle of public life, are incapable of acting where promptness is requisite; and that men who have once or twice yielded to a sense of impending danger seldom acquire afterwards that command of themselves which may be necessary to extricate them from subsequent dangers. In one of the earliest battles fought by the late king of Prussia, the sovereignty was among the first men who quitted the field: had he behaved in the same manner a second and a third time, he would never have become that hero whose actions astonished Europe. A celebrated engineer among ourselves, who was well known to the writer of this short article, had little science, and was a stranger to the principles of his own art; but being possessed of a firm and vigorous frame, and having been accustomed to struggle with dangers and difficulties, he had such a constant command of himself, as enabled him to employ with great coolness every necessary resource in the day of battle.

But it is not only in battle, and in the face of immediate danger, that self-command is necessary to enable a man to act with propriety. There is no situation in life where difficulties, greater or less, are not to be encountered; and he who would pass through life with comfort to himself, and with utility to the public, must endeavour to keep his passions in constant subjection to his reason. No man can enjoy without inquietude what he cannot lose without pain; and no man who is overwhelmed with despondency under any sudden misfortune can exert the talents necessary to retrieve his circumstances. We ought, therefore, by every means to endeavour to obtain a constant command of ourselves; and not here shall we find better lessons for this purpose than in ancient Laocædemon. There certain occupations were appointed for each sex, for every hour, and for every season of life. In a life always active, the passions have no opportunity to deceive, seduce, or corrupt; and the nervous system acquires a firmness which makes it a fit instrument to a vigorous mind.

SELF DEFENCE implies not only the preservation of one's life, but also the protection of his property, be-

Self.

cause without property life cannot be preserved in a civilized nation. The extent of property essential to life is indeed small, and this consideration may enable us to decide a question which some moralists have made intricate. By what means, it has been asked, may a man protect his property? May he kill the person who attacks it, if he cannot otherwise repel the attack?

That a man, in the state of nature, may kill the person who makes an attack on his life, if he cannot otherwise repel the attack, is a truth which has never been controverted; and he may do the same in civil society, if his danger be so imminent that it cannot be averted by the interposition of the protection provided for individuals by the state. In all possible situations, except the three following, whatever is absolutely necessary to the preservation of life may be lawfully performed, for the law of self-preservation is the first and most sacred of those laws which are impressed on every mind by the author of nature.

The three excepted situations are those of a soldier in the day of battle, of a criminal about to suffer by the laws of his country, and of a man called upon to renounce his religion. The soldier hazards his life in the most honourable of all causes, and cannot betray his trust, or play the coward, without incurring a high degree of moral turpitude. He knows that the very profession in which he is engaged necessarily subjects him to danger; and he voluntarily incurred that danger for the good of his country, which, with great propriety, annexes to his profession peculiar privileges and much glory. The criminal under sentence of death cannot, without adding to his guilt, resist the execution of that sentence; for the power of inflicting punishment is essential to society, and society is the ordinance of God, (see SOCIETY). The man who is called upon to renounce his religion ought to submit to the cruellest death rather than comply with that request, since religion is his only security for future and permanent happiness. But in every other situation, that which is absolutely necessary to the preservation of life is undoubtedly lawful. Hence it is, that a person sinking in water is never thought to be guilty of any crime, though he drag his neighbour after him by his endeavours to save himself; and hence, too, a man in danger of perishing by shipwreck may drive another from a plank which cannot carry them both, for since one of two lives must be lost, no law, human or divine, calls upon either to prefer his neighbour's life to his own.

But though the rights of self-defence authorize us to repel every attack made upon our life, and in cases of extremity to save ourselves at the expence of the life of our innocent neighbour, it is not so evident that, rather than give to an unjust demand a few shillings or pounds, we may lawfully deprive a fellow creature of life, and the public of a citizen. A few pounds lost may be easily regained; but life when lost can never be recovered. If these pounds, indeed, be the whole of a man's property; if they include his clothes, his food, and the house where he shelters his head—there cannot be a doubt but that, rather than part with them, he may lawfully kill the aggressor, for no man can exit without shelter, food, and raiment. But it is seldom that an attempt is made, or is indeed practicable, to rob a man of once of all that he possesses. The question then of

Self.

any importance is, May a man put a robber to death rather than part with a small part of his property? Mr Paley doubts whether he could innocently do so in a state of nature, "because it cannot be contended to be for the augmentation of human happiness, that one man should lose his life or limb, rather than another a pennyworth of his property." He allows, that in civil society the life of the aggressor may be always taken away by the person aggrieved, or meant to be aggrieved, when the crime attempted is such as would subject its perpetrator to death by the laws of his country.

It is not often that we feel ourselves disposed to differ in opinion from this most valuable and intelligent writer; but on the present occasion we cannot help thinking that he does not reason with his usual precision. To us he even seems to lose sight of his own principles. No legislature can have a right to take away life in civil society, but in such cases as individuals have the same right in a state of nature. If therefore a man in the state of nature, have not a right to protect his property by killing the aggressor, when it cannot be otherwise protected, it appears to us self-evident that no legislature can have a right to inflict the punishment of death upon such offences; but if the laws inflicting death upon the crime of robbery be morally evil, it is certain that an individual cannot be innocent when he prevents robbery by the death of the robber, merely because he knows that the laws of his country have decreed that punishment against those convicted of that crime. But we think that the protection of property by the death of the aggressor may be completely vindicated upon more general principles. It is necessary, in every state, that property be protected, or mankind could not subsist; but in a state of nature every man must be the defender of his own property, which in that state must necessarily be small; and if he be not allowed to defend it by every mean in his power, he will not long be able to protect it at all. By giving him such liberty, a few individuals may, indeed, occasionally lose their lives and limbs for the preservation of a very small portion of private property; but we believe that the sum of human happiness will be more augmented by cutting off such worthless wretches than by exposing property to perpetual depredation; and therefore, if general utility be the criterion of moral good, we must be of opinion that a man may in every case lawfully kill a robber rather than comply with his unjust demand.

But if a man may without guilt preserve his property by the death of the aggressor, when it cannot be preserved by any other means, much more may a woman have recourse to the last extremity to protect her chastity from forcible violation. This, indeed, is admitted by Mr Paley himself, and will be controverted by no man who reflects on the importance of the female character, and the probable consequences of the smallest deviation from the established laws of female honour. See SEDUCTION.

SELF-Knowledge, the knowledge of one's own character, abilities, opinions, virtues, and vices. This has always been considered as a difficult though important acquisition. It is difficult, because it is disagreeable to investigate our errors, our faults, and vices; because we are apt to be partial to ourselves, even when we have done wrong; and because time and habitual attention

Those who maintain the affirmative side of this question say, that the prospect of immediate pleasure, or the dread of immediate pain, is the only apparent motive to action in the minds of infants, and indeed of all who look not before them, and infer the future from the past. They own, that when a boy has had some experience, and is capable of making comparisons, he will often decline an immediate enjoyment which he has formerly found productive of future evil more than equivalent to all its good; but in doing so they think, and they think justly, that he is still actuated by the principle of self-love, pursuing the greatest good of which he knows himself to be capable. After experiencing that truth, equity, and benevolence in all his dealings is the readiest, and indeed the only certain method of securing to himself the kindness and good offices of his fellow creatures, and much more when he has learned that they will recommend him to the Supreme Being, upon whom depends his existence and all his enjoyments, they admit that he will practice truth, equity, and benevolence; but still, from the same principle, pursuing his own ultimate happiness as the object which he has always in view. The prospect of this great object will make him feel an exquisite pleasure in the performance of the actions which he conceives as necessary to its attainment, till at last, without attending in each instance to their consequences, he will, by the great associating principle which has been explained elsewhere (see METAPHYSICS, Part I. chap. i.) feel a refined enjoyment in the actions themselves, and perform them, as occasions offer, without deliberation or reflection. Such, they think, is the origin of benevolence itself, and indeed of every virtue.

Those who take the other side of the question, can hardly deny that self-love thus modified may prompt to virtuous and apparently disinterested conduct; but they think it degrading the dignity of a man to suppose him actuated solely by motives which can be traced back to a desire of his own happiness. They observe, that the Author of our nature has not left the preservation of the individual, or the continuance of the species, to the deductions of our reason, computing the sum of happiness which the actions necessary to these ends produce to ourselves: on the contrary, He has taken care of both, by the surer impulse of instinct planted in us for these very purposes. And is it conceivable, say they, that He would leave the care of our fellow-creatures a matter of indifference, till each man should be able to discover or be taught that by loving his neighbour, and doing him all the good in his power, he would be most effectually promoting his own happiness? It is dishonouring virtue, they continue, to make it proceed in any instance from a prospect of happiness, or a dread of misery; and they appeal from theory to fact, as exhibited in the conduct of savage tribes, who deliberate little on the consequences of their actions.

Their antagonists reply, that the conduct of savage tribes is to be considered as that of children in civilized nations, regulated entirely by the examples which they have before them; that their actions cannot be the offspring of innate instincts, otherwise savage virtues would, under similar circumstances, everywhere be the same, which is contrary to fact; that virtue proceeds from an interested motive on either supposition; and that the motive which the instinctive scheme holds up is the most selfish of the two. The other theory sup-

poses, that the governing motive is the hope of future happiness and the dread of future misery; the instinctive scheme supplies a present motive in the self-complacency arising in the heart from a consciousness of right conduct. The former is a rational motive, the latter has nothing more to do with reason than the enjoyment arising from eating or drinking, or from the intercourse between the sexes. But we mean not to peruse the subject farther, as we have said enough on it in the articles BENEVOLENCE, INSTINCT, PASSION, and PHILANTHROPY. We shall therefore conclude with observing, that there is certainly a virtuous as well as a vicious self-love, and that "true self-love and social are the same."

SELF-MURDER. See SUICIDE.

SELF-PARTIALITY, is a phrase employed by some philosophers* to express that weakness of human nature through which men overvalue themselves when compared with others. It is distinguished from general partiality, by those who make use of the expression, because it is thought that a man is led to overrate his own accomplishments, either by a particular instinct, or by a process of intellect different from that by which he overrates the accomplishments of his friends or children. The former kind of partiality is wholly selfish; the latter partakes much of benevolence.

This distinction may perhaps be deemed plausible by those who consider the human mind as little more than a bundle of instincts; but it must appear perfectly ridiculous to such as resolve the greater part of apparent instincts into early and deep-rooted associations of ideas. If the partialities which most men have to their friends, their families, and themselves, be instinctive, they are certainly instincts of different kinds; but an instinctive partiality is a contradiction in terms. Partiality is founded on a comparison between two or more objects; but genuine instincts form no comparisons. See INSTINCT. No man can be said to be partial to the late Dr Johnson, merely for thinking highly of his intellectual powers; nor was the doctor partial to himself, though he thought in this respect with the generality of his countrymen; but if, upon a comparison with Milton, he was deemed the greater poet of the two, such a judgement will be allowed to be partial, whether formed by himself or by any of his admirers. We apprehend, however, that the process of its formation was the same in every mind by which it was held.

The origin of self-partiality is not difficult to be found: and our partialities to our friends may be traced to a similar source. By the constitution of our nature we are impelled to shun pain and to pursue pleasure; but remorse, the severest of all pains, is the never-failing consequence of vicious conduct. Remorse arises from the dread of that punishment which we believe will in a future state be inflicted on vice unrepented of in this; and therefore every vicious person endeavours by all possible means to bannish that dread from his own mind. One way of effecting this is to compare his own life with the lives of others; for he fancies that if numbers be as wicked as himself, the benevolent Lord of all things will not involve them in one common ruin. Hence, by magnifying to himself the temptations which led him astray, and diminishing the injuries which his conduct has done in the world, and by adopting a course diametrically the reverse, when estimating

Self.
Selim.

the morality or immorality of the conduct of his neighbours, he soon comes to believe that he is at least not more wicked than they. Thus is self-partiality formed in the mind, and quickly blinds him who is under its influence so completely, as to hide from him the very faults which he sees and blames in others. Hence the coward thinks himself only cautious, the miser frugal. Partiality is formed in the very same manner to natural or acquired accomplishments, whether mental or corporal. These always procure respect to him who is possessed of them; and as respect is accompanied with many advantages, every man wishes to obtain it for himself. If he fail in his attempts, he consoles himself with the persuasion that it is at least due to his merits, and that it is only withheld by the envy of the public. He compares the particular branch of science or bodily accomplishment in which he himself most excels, with those which have conferred splendor on his rival; and easily finds that his own excellencies are of the highest order, and entitled to the greatest share of public esteem. Hence the polite scholar despises the mathematician; the reader of Aristotle and Plato all the modern discoveries in physical and moral science; and the mere experimentalist holds in the most sovereign contempt a critical knowledge of the ancient languages. The pupil of the ancients denies the merits of the moderns, whilst the mere modern allows nothing to the ancients; and thus each becomes partial to his own acquisitions, and of course to himself, for having been at the trouble to make them.

Partiality to our friends and families is generated in the very same way. Whenever we acquire such an affection for them as to consider their happiness as adding to our own (see PASSION), we magnify their excellencies, and diminish their defects, for the same reason, and by the same process, that we magnify and diminish our own. All partialities, however, are prejudices, and prejudices of the worst kind. They ought therefore to be guarded against with the utmost care, by the same means which we have elsewhere recommended (see PREJUDICE and METAPHYSICS, N^o 98.); and he who is partial to his own virtue or his own knowledge, will do well to compare the former, not with the conduct of his neighbour, but with the express rule of his duty; and to consider the latter as no farther valuable than as it contributes to the sum of human happiness.

SELIM I. emperor of the Turks, was the second son of Bajazet II. He made war upon his father, and though defeated in 1511, he at last dethroned him and took him prisoner, and immediately dispatched him by poison, together with his elder brother Achmet, and his younger Korkud, an amiable and enlightened prince. Having established his throne by these crimes, he marched against Cambrin-Guary sovereign of Egypt, gained a great victory at Aleppo, and slew their general. But though the sultan perished in that battle, the Mameluks determined to oppose the emperor. Selim entering their country at the head of his army, defeated the Egyptians in two battles, and ordered Taoumbai, the new elected sultan, who had fallen into his hands, to be hung on a gibbet. He then took Cairo and Alexandria, and in a short time reduced all Egypt to subjection. Thus ended the dominion of the Mameluks in Egypt,

which had continued for more than 265 years. It confirmed the ancient privileges of the Venetians in Egypt and Syria, by which they carried on their commerce with India, and formed a league with them to destroy the power of the Portuguese in that country. (See INDIA, N^o 37.) Selim had before this gained a great victory over the Persians, and stripped them of Tauris and Kerman. He was preparing to attack Christendom when he was seized with an ulcerous sore in the back. Thinking that the air of Adrianople would restore his health, he ordered himself to be conducted thither; but he died at Clari in Thrace on his road to that city, in the year 1520, in the very spot where he had poisoned his father. He reigned eight years, and lived 54. He was a prince of great courage, sobriety, and liberality; he was fond of history, and wrote some verses. But these good qualities were obscured by the most abominable crimes that ever disgraced human nature; he made his way to the throne by shedding the blood of his father, and secured it by murdering his brothers and eight nephews, and every bawlah who had been faithful to his duty.

SELINUM, a genus of plants belonging to the pentandria class; and in the natural method ranking under the 25th order, *Umbellatæ*. See BOTANY Index.

SELKIRK, ALEXANDER, whose adventures gave rise to a well-known historical romance, was born at Largo, in Fifeshire in Scotland, about the year 1676, and was bred a seaman. He went from England, in 1703, in the capacity of sailing-master of a small vessel called the *Cinque-Ports Galley*, Charles Fickering captain, burthen about 90 tons, with 16 guns and 63 men, and in September the same year sailed from Cork, in company with another ship of 26 guns and 120 men, called the *St George*, commanded by that famous navigator William Dampier, intended to cruise against the Spaniards in the South Sea. On the coast of Brazil, Fickering died, and was succeeded in his command by his lieutenant Thomas Stradling. They proceeded on their voyage round Cape Horn to the island of Juan Fernandez, whence they were driven by the appearance of two French ships of 36 guns each, and left five of Stradling's men there on shore, who were taken off by the French. Hence they sailed to the coast of America, where Dampier and Stradling quarrelled, and separated by agreement, on the 17th of May 1704. In September following, Stradling came again to the island of Juan Fernandez, where Selkirk and his captain had a difference, which, with the circumstance of the ship's being very leaky, and in bad condition, induced him to determine on staying there alone; but when his companions were about to depart, his resolution was shaken, and he desired to be taken on board again. The captain, however, refused to admit him, and he was obliged to remain, having nothing but his clothes, bedding, a gun, and a small quantity of powder and ball; a hatchet, knife, and kettle; his books, and mathematical and nautical instruments. He kept up his spirits tolerably till he saw the vessel put off, when (as he afterwards related) his heart yearned within him, and melted at parting with his comrades and all human society at once.

"——— Yet believe me, Areas,
Such is the root we be but unkind,

All ruffians as they were, I never heard
A found to dismal as their parting ears;

Thomson's Rime.

Thus left sole monarch of the island, with plenty of the necessities of life, he found himself in a situation hardly less portable. He had fish, goats' flesh, turneps and other vegetables; yet he grew dejected, languid, and melancholy, to such a degree, as to be scarce able to refrain from doing violence to himself. Eighteen months passed before he could, by reasoning, reading his bible, and study, be thoroughly reconciled to his condition. At length he grew happy, employing himself in deerskin his huts, chasing the goats, whom he equalled in speed, and scarcely ever failed of catching. He also tamed young kids, liming them to prevent their becoming wild; and he kept a guard of tame cats about him, to defend him when asleep from the rats, who were very troublesome. When his clothes were worn out, he made others of goats' skins, but could not succeed in making shoes, with the use of which, however, habit, in time, enabled him to dispense. His only liquor was water. He computed that he had caught 1200 goats during his abode in the island; of which he had let go 500, after making them by flitting their ears. Commodore Anson's people, who were there about 22 years after, found the first goat which they shot upon his leg, was thus marked, and as it appeared to be very old, concluded that it had been under the power of Selkirk. But it appears by Captain Carteret's account of his voyage in the Swallow sloop, that other people predicted this mode of marking, as he found a goat with his ears thus slit on the neighbouring island of *Motoua*, where Selkirk never was. He made companions of his tame goats and cats, often dancing and playing with them. Though he constantly performed his devotions at stated hours, and read aloud; yet, when he was taken off the island, his language, in a dilute of conversation, had become scarcely intelligible. In this state he continued four years and four months; during which time only two incidents happened which he thought worth relating, the occurrences of every day being in his circumstances nearly similar. The first was, that, pursuing a goat eagerly, in a cave he discovered the entrance of a crevice, which was covered with bones, so that he did not perceive it, and he fell over it, where he lay, (according to Captain Cook's account) 24 hours senseless; but, as he relates, the *R. Sable*, he computed, by the alteration of the moon, that he had lain three days. When he came to himself, he found the goat lying under him dead. It was with great difficulty that he could crawl to his habitation, whence he was unable to stir for ten days, and did not recover his faculties for a long time. The other event was the arrival of a ship, which he at first thought to be English, and which, from a mutual love of liberty, he has imagined, that he was eager to abandon to his countrymen and friends, should it to them, should be permitted to return to their country, or reach the continent. He had some 1200 Spaniards, of whom he had taken a great deal of spoil himself in the bonds of commerce, and he thought that it required all his strength to have been able to defend himself by a battle, should the Spaniards have been so bold as to offer. Fortune, however, was not so favourable to him, though

they stayed some time under the tree where he was hid, and killed some goats just by. In this solitude Selkirk remained until the 22 of February 1750, when he saw two ships come into the bay, and knew them to be English. He immediately lighted a fire as a signal; and on their coming on shore, found they were the Duke Captain Rogers, and the Duke's Captain Courtney, two privateers from Bilbao. He gave them the best entertainment he could afford; and, as they had been a long time at sea without fresh provisions, the goats which he caught were highly acceptable. His habitation consisting of two huts, one to sleep in, the other to dress his food in, was so obscurely situated, and so difficult of access, that only one of the ship's officers would accompany him to it. Dampier, who was pilot on board the Duke, and knew Selkirk very well, told Captain Rogers, that, when on board the Cinque-Ports, he was the best seaman in the vessel; upon which Captain Rogers appointed him master's mate of the Duke. After a fortnight's stay at Juan Fernandez, the ships proceeded on their cruise against the Spaniards; plundered a town on the coast of Peru; took a Manila ship off California; and returned by way of the East Indies to England, where they arrived the 11 of October 1711; Selkirk having been absent eight years, more than half of which time he had spent alone in the island. The public curiosity being excited respecting him, he was induced to put his papers into the hands of Defoe, to arrange and form them into a regular narrative. These papers must have been drawn up after he left Juan Fernandez, as he had no means of recording his transactions there. Captain Cooke remarks, as an extraordinary circumstance, that he had contrived to keep an account of the days of the week and month; but this might be done, as Defoe makes Robinson Crusoe do, by cutting notches in a post, or many other methods. From this account of Selkirk, Defoe took the idea of writing a more extensive work, the romance of Robinson Crusoe, and very dithely defrauded the original proprietor of his share of the profits. Of the time or place or manner of this extraordinary man's death we have received no account; but in 1798 the chest and market which Selkirk had with him on the island were in the possession of his grand-nephew, John Selkirk weaver in Largo.

The circumstances of Selkirk's seclusion from human society during his stay on Juan Fernandez, and the sentiments which that situation naturally inspired, have been so finely and characteristically depicted by Mr Cowper, that many of our readers, we doubt not, will be gratified if we give the verses alluded to a place here.

I am monarch of all I survey,
My right there is none to dispute;
From the centre all round to the sea,
I am lord of the fowl and the brute.
Oh, solitude! where are the charms
That slaves have seen in thy face?
Better dwell in the midst of alarms,
Than reign in this horrible place.
I am out of humanity's reach,
I must finish my journey alone,
Never hear the sweet music of speech;
I shut at the found of my own.

The beauteous room o'er the plain
My form with indifference bears;
They are to unacquainted with man,
Their tamer's is flocking to me,
Society, friendship, and love,
Divinely beflow'd upon man,
Oh, had I the wings of a dove,
How soon would I take you again!
My furrows I then might sow
In the ways of religion and truth,
Might learn from the willow of age,
And be cheer'd by the lilies of youth,
Religion! what treasures unfold
Belides in that heavenly world!
More precious than silver and gold,
Or all that this earth can afford.
But the fount of the church-god's well
These valleys and rocks never heard,
Ne'er light'd at the fount of a knell,
Or fringed when a sabbath appear'd.
Ye winds that have made me your port,
Convey to this desolate shore
Some cordial endearing report
Of a land I shall visit no more.
My friends, do they now and then send
A wish or a thought after me?
O tell me I yet have a friend,
Though a friend I am never to be.
How fleet is a glance of the mind!
Compar'd with the speed of its flight,
The tempered fiddlers behind,
And the swift-winged arrows of light.
When I think of my own native land,
In a moment I seem to be there;
But alas! recollection at hand
Sven Lurie, me back to detain.
But the sea-fowl is gone to her nest,
The heart is laid down in his lair.
E'en here is a season of rest,
And I to my cabin repair.
There's mercy in every place;
And mercy, encouraging thought!
Gives even affliction a grace,
And reconciles man to his lot.

SELKIRK, the capital of the county of the same name, is a small town pleasantly situated on a rising ground, and enjoys an extensive prospect in all directions, especially in the course of the river Esk. It is remarkable for those productions which are produced in its neighbourhood, the natural simplicity of which are the pride of Scotland and one admiration of strangers.

The citizens of this burgh, like the other burghs of the shire, were at Ettrick burgh, rendered themselves independent, and adhering to the fortunes of their prince James IV. On 1573 he was who followed that monarch to the field of Flodden, a day renowned loaded with misfortune to the crown. On the 15th of that day, after a desperate and bloody contest, the king of Scotland was slain, and the crown of Scotland devolved on the infant Mary, the daughter of James, who, in the reign of her father, had been betrothed to the prince of Wales, the son of Henry VIII. King of England. The death of James IV. was the first step towards the union of the two kingdoms, which was effected in 1707.

with Charles II. The defects about the cities, however, to expand the English, that they remain their dear cities town to a host, but their grateful forefathers James V. showed his desire of their services by a grant of an extensive tract of Ettrick Forest, the trees for building their houses, and the property as a reward for their service. Selkirk is a royal burgh, united with Lamlash, Dalrymple and Peebles, in sending a member to parliament. W. Long, 245 N. Lat. 55. 26.

SELKIRK-STAIRS, called also the *Sherrifm of Ettrick Forest*, a county of Scotland, extending now 20 miles in length from east to west, and about 12 in breadth from south to north. It borders on the north with part of Tweeddale and Mid-Lothian; on the south and east with Teviotdale; and on the west with Annandale. This county was formerly reserved by the Scottish princes for the pleasure of the chase, and where they had houses for the reception of their train. At that time the face of the country was covered with woods, in which there were great numbers of red and fallow deer, whence it had the name of *Ettrick Forest*. The woods, however, are now almost entirely cut down, and the county is chiefly supported by the breed of sheep. They are generally sold into the south, but sometimes into the Highlands, about the month of March, where they are kept during summer; and after being improved by the mutton grass, are returned into the Lowlands in the beginning of winter.

This county, though not very populous at present, was once the seat of heroes, who were justly accounted the bulwark of their native soil, being ever ready to leave danger and death in its defence. Of this we have a reasonable proof in the pathetic lamentations of their wives and daughters for the disaster of the field of Flodden, where their brave husbands were all wed away. The rivers Ettrick and Yarrow unite a little above the town of Selkirk, and terminate in the Tweed. For five miles above its junction with the Ettrick, the Tweed is still adorned with woods, and leads the pleased imagination to contemplate what this country must have been in former times. The Yarrow, for about five miles above its junction with Ettrick, exhibits nature in a bold and striking aspect. Its native woods still remain, through which the stream has cut its turbid course, deeply impinged amidst rugged rocks. Here, certainly in a flood, stood the descriptive Thomson when he said it

“Work and boil, and foam and thunders through.”

On a rock, cut out by the ferocious stream, is the seat of a once a daily wild scene of grandeur and beauty, the ruins of Newark, which has been supposed by many to be the little place of Mary Scot the daughter of Yarrow.

The population of this county in 1801 amounted to 5775. The following is the population of the different parishes, at two different periods, according to the Statistical History.

Parishes.	Pop. in 1755.	Pop. in 1801.
Lowlands	397	677
Greenlands	6,38	5098

City of Edinburgh, 1755. 1755. 1755.

Soil
||
Season.

Parishes.

Population
in 1752.

Population in
1790-1798.

Brought over,	1395	1384
Seikil,	1793	1700
Yarrow,	1180	1230
	4368	4314
	4314	

Decrease, 54

SELL, or SILL, in building, is of two kinds, viz. *Ground Sell*, denoting the lowest piece of timber in a wooden building, and that on which the whole superstructure is raised; and *fell of a window or of a door*, which is the bottom piece in the frame of them on which they rest.

SELLA TURCICA, is a deep impression between the clinoid process of the sphenoid bone. See ANATOMY Index.

SELTZER WATER, is a mineral water which springs up at Lower Seltzer, a village in the electorate of Trier, about 10 miles from Frankfort on the Mayne, and 36 from Coelentz.

Seltzer water is brought to this country in stone bottles, which are closely corked and sealed, and contain about 3 pints each; and when they are well secured, it keeps unchanged for a considerable time.

Seltzer water, according to the analysis of Bergman, contains in an English wine pint,

Carbonate of lime	grs.
— of magnesia	3
— of soda	5
Muriate of soda	17.5
	29.5

The same quantity of water also yields 17 cubic inches of a gaseous substance, which is found to be almost entirely pure carbonic acid gas.

This water has been long in high repute, on account of its medical virtues, and we have no doubt that it may be used with considerable benefit in many of those complaints which arise from a deranged state of the stomach and bowels. The usual dose of this water is from half a pint to a pint; but in most cases it may be drunk freely. From its agreeable taste, and its exhilarating effects on the spirits, it is extensively employed at table as a common drink in Germany and Holland. In this country also, both the real and artificial Seltzer water is largely used for the same purpose. Seltzer water may be artificially imitated, by adding the ingredients diluted by analysis, and in the same proportion.

SEAM, or SEEM, the son of Noah, memorable for his filial piety in concealing the folly and disgrace of his father, for which he received a remarkable benediction, about 2476 B. C. He lived to the age of 600 years.

See *SEAM*. See *RAS SEM* and *PERISHED CITY*.

SEMECARPUS, a genus of plants belonging to the pentandria class. See *BOTANY Index*.

SEMIN. SEED. See *BOTANY Index*.

With respect to number, plants are either furnished with one seed, as sea-pink and bilboist; two, as wood-turf and the umbelliferous plants; three, as spurge; four, as the hip-flowers of Tournafort and rough-leaved

plants of Ray; or many, as ranunculus, anemone, and poppy.

The form of seeds is likewise extremely various, being either large or small, round, oval, heart-shaped, kidney-shaped, angular, prickly, rough, hairy, wrinkled, fleck or shining, black, white, or brown. Most seeds have only one cell or internal cavity; those of lesser burdock, valerian, lamb's lettuce, cornelian, cherry, and seibelen, have two.

With respect to substance, seeds are either soft, membranaceous, or of a hard bony substance; as in gromwell, tamarind, and all the nuciferous plants.

In point of magnitude, seeds are either very large, as in the cocoa-nut; or very small, as in campanula, *ammanzia*, rampions, and throat-wort.

With respect to situation, they are either dispersed promiscuously through the pulp (*semina nidulantis*), as in water-lily; affixed to a future or joining of the valves of the seed-vessel, as in the cross-shaped and pea-bloom flowers; or placed upon a *placenta* or receptacle within the seed vessel, as in tobacco and thorn-apple.

Seeds are said to be naked (*semina nuda*) which are not contained in a cover or vessel: such are those of the lip and compound flowers, the umbelliferous and rough-leaved plants. Covered seeds (*semina tecta*) are contained in some vessel, whether of the capsule, pod, berry, apple, or cherry kind.

A simple seed is such as bears neither crown, wing, nor downy *pappus*; the varieties in seeds, arising from these circumstances, are particularly enumerated under their respective heads.

In affmilating the animal and vegetable kingdoms, Linnæus denominates seeds the eggs of plants. The fecundity of plants is frequently marvellous; from a single plant or stalk of Indian Turkey wheat, are produced, in one summer, 2000 seeds; of elecampane, 3000; of sun-flower, 4000; of poppy, 32,000; of a spike of cat's tail, 10,000 and upwards; a single fruit, or seed-vessel, of tobacco, contains 1000 seeds; that of white poppy, 8000. Mr Ray relates, from experiments made by himself, that 1012 tobacco seeds are equal in weight to one grain; and that the weight of the whole quantum of seeds in a single tobacco plant, is such as must, according to the above proportion, determine their number to be 360,000. The same author estimates the annual produce of a single stalk of spleenwort to be upwards of one million of seeds.

The dissemination of plants respects the different methods or vehicles by which nature has contrived to diffuse their seeds for the purpose of increase. These by naturalists are generally reckoned four.

1. Rivers and running waters. 2. The wind. 3. Animals. 4. An elastic spring, peculiar to the seeds themselves.

1. The seeds which are carried along by rivers and torrents are frequently conveyed many hundreds of leagues from their native soil, and call upon a very different climate, to which, however, by degrees they render themselves familiar.

2. Those which are carried by the wind, are either winged, as in fir-tree, trumpet-flower, tulip-tree, birch, ash-or-vitæ, meadow rue, and jessamine, and some umbelliferous plants; furnished with a *pappus*, or downy crown, as in valerian, poplar, reed, luculent wall-wort, cotton tree, and many of the compound flowers; placed

Seme
II
Semi.

placed within a winged *calyx* or feed-vessel, as in fabious, pea-pink, dock, diocoreo, ash, maple, and elm-trees, logwood and woad; or lally, contained within a swelled *calyx* or feed vessel, as in winter cherry, cucubalus, melilot, bladder-nut, fumatory, bladder fern, heart-feed, and chick-peas.

3. Many birds swallow the feeds of vanelloe, juniper, millet, oats, millet, and other grasses, and void them entire. Squirrels, rats, parrots, and other animals, suffer from the feeds which they devour to escape, and thus in effect disseminate them. Moles, ants, earthworms, and other insects, by ploughing up the earth, admit a free passage to those feeds which have been scattered upon its surface. Again, some feeds attach themselves to animals, by means of crochets, hooks, or hairs, which are either affixed to the feeds themselves, as in hound's tongue, mouse-ear, vervain, carrot, bastard-parley, fanicle, water hump-agrimony, *arsipus* and *verberina*; to their calyx, as in burdock, agrimony, *rhevia*, small wild bugloss, dock, nettle, pellitory, and feed-wort; or to their fruit or feed-vessel, as in liquorice, enchanter's nightshade, cross-wort, cleavers, French honey-fuckle, and arrow-headed grass.

4. The feeds which disseminate themselves by an elastic force, have that force resident either in their *calyx*, as in oats, and the greater number of ferns; or in their *propus*, as in centaurea erupina; or in their *capsule*, as in geranium, herb-bennet, African pitreia, fraxinella, horsetail, balsam, Malabar nut, cucumber, claterium, and male balsam apple.

SEMEN, in the animal economy. See PHYSIOLOGY and ANATOMY Index.

SEMED SANITUM, or Santonicum. See ARTEMISIA.

SEMENDRIA, a town of Turkey in Europe, in the province of Servia, with a good citadel. It is the capital of a sangaccate, was taken by the Turks in 1650, and is seated on the Danube, in E. Long. 21. 45. N. Lat. 45. 0.

SEMENTINÆ FERIE, in antiquity, feasts held annually among the Romans, to obtain of the gods a plentiful harvest. They were celebrated in the temple of Tellus, where solemn sacrifices were offered to Tellus and Ceres. These feasts were held about seed-time, usually in the month of January; for, as Macrobius observes, they were moveable feasts.

SEMI, a word borrowed from the Latin, signifying half; but only used in composition with other words, as in the following articles.

SEMI-ARIANS, in ecclesiastical history, a branch of the ancient Arians, consisting, according to Epiphanius, of such as, in appearance, condemned the errors of that heresarch, but yet acquiesced in some of the principles thereof, only palliating and hiding them under softer and more moderate terms. Though they separated from the Arian faction (see ARIANS), they could never be brought to acknowledge that the Son was homoousio, that is, consubstantial, or of the same substance with the Father; they would only say him to be homocousios, that is, of a like substance with the Father, or similar to the Father in his essence, not by nature, but by a peculiar property.

The fundamentalism of the moderns consists in their maintaining that the Son was born of eternity begotten by the will of the Father, not any to the distinct

of the Father, who seem to teach that the eternal generation is necessary. Such at least are the respective opinions of Dr Clarke and Bishop Bull. See THEOLOGY.

SEMICIRCLE, in Geometry, half a circle, or that figure comprehended between the diameter of the circle and half its circumference.

SEMICOLON, in Grammar, one of the points or stops used to distinguish the several members of a sentence from each other.

The mark or character of the semicolon is (;), and has its name as being of somewhat less effect than a colon; or as demanding a shorter pause.

The proper use of the semicolon is to distinguish the conjunct members of a sentence. Now, by a conjunct member of a sentence is meant such a one as contains at least two simple members.—Whenever, then, a sentence can be divided into several members of the same degree, which are again divisible into other simple members, the former are to be separated by a semicolon. For instance: "If fortune bear a great sway over him, who has nicely flated and concerted every circumstance of an affair; we must not commit every thing, without reserve, to fortune, lest he have too great a hold of us." Again: *Si quantum in aere, l'elaine d'elertis audacia potest, tantum in ferro atque indiciis in prudentia valet; non minus in causa eodem estulus Cicero Sexto Tibullii impudente, quam tum in et facienda essit audacie.* An instance in a more complex sentence we have in Cicero: *Res familiaris primus sine parte fit, unde que turp. quous: tum quam plurimis, unde dignis, se uilem prebet; unde arguor ratione, diligencia, pugnancia; nec libidini potius he uraque, quam liberalitati et beneficentia parent.*

But though the proper use of the semicolon be to distinguish conjunct members, it is not necessary that all the members thus divided be conjunct. For upon dividing a sentence into great and equal parts, if one of them be conjunct, all those other parts of the same degree are to be distinguished by a semicolon.—Sometime also it happens, that members that are opposite to each other, but relate to the same verb, are separated by a semicolon. Thus Cicero: *Ex hoc parte pudor, sine pietas; sine fides, sine frugalitas; sine pietas, sine fides;* &c. To this likewise may be referred such sentences, where the whole going before, the parts follow as "The parts of oratory are four: invention, disposition, elocution, and pronunciation."

SEMICURIA, in Medicine, an half-bath, wherein the patient is only placed up to the navel.

SEMI-DIAMETER, half the diameter, or a right line drawn from the centre of a circle or sphere to its circumference; being the same with what is otherwise called the radius.

SEMI-FLOSCULES, in Botany, a term used to express the flowers of the Symplocia class. These semiflosculi are petals, hollow in their lower part, but in their upper part, and continued in the form of a tongue.

SEMITONE, in Music. See INTERVAL.

SEMINAL, something belonging to the semen or seed.

SEMINARY, in its primary sense, the ground where any thing is sown, to be afterwards transplanted.

SEMINARY, in a figurative sense, is the only appellation to places of education, where children are brought

Semi
II
Semiary.

... his life.—In Councils, &c. In a particular manner a kind of ecclesiastical discipline is to be extracted from the ecclesiastical laws of the same country. Of these there are great numbers, as being ordered by the council of Trent, that there be a faculty belonging to each cathedral, under the direction of the bishop.

SEMINATION, denotes the manner or act of sowing and dispersing the seeds of plants. See **SEMIN**.

SEMPELAGIANS, in *Theological History*, a name given to such as retain some tincture of Pelagianism. See **PELAGIANS**.

The disciples of this sect, as well as those of their predecessor the Pelagians, have their common source in Pelagius, a native of Britain, of whom we have already taken notice. He is said to have been but a simple monk, and not in orders. Having gone to Rome about the end of the fourth century, he lived there for some years with reputation, and was considered both pious and virtuous. Being a pupil of Aquilina, having come to Rome in the year 407, is affirmed by some to have been the person who suggested to Pelagius his peculiar doctrines.

In the year 420 Pelagius began to teach his opinions at Rome, both by speech and writing. He was not the only person who taught these doctrines, of which we have elsewhere enumerated the heads. His friend and companion Celestius, an older man than himself, maintained them likewise, and with much more address and subtilty. After having promulgated them in Rome, they went into Sicily, where they lived for some time. Thence, in the year 417, they sailed over into Africa. Pelagius soon after went into Palestine, whither Celestius pursued at Carthage, and was presenting himself to a bishop, in order to priesthood; but it being soon discovered that he taught a new doctrine, he was rejected by the deacon Paulinus in a synod held at Carthage in 412, at which Aureus was the bishop presided. Celestius, on being charged by Paulinus with denying original sin, made answer, "That in truth he doubted whether the sin of Adam was transmitted to his posterity." He did not however care that children had no need of baptism, although this was one of the Pelagian tenets; on the contrary, he wrote a little discourse, in which he acknowledged, that children had need of redemption, and that they could not obtain it without baptism. The bishops at the council of Carthage condemned the doctrine of Celestius, and excommunicated him. From this sentence he appealed to the bishop of Rome; but he neglected to make his appeal, and yet to Ephesus, where he endeavoured to set himself up for a prophet. In the mean time, Paulinus being returned into Palestine, was kindly received by the emperor's eunuch, John of Jerusalem. With him he entered into an agreement to attack the reputation of the emperor. St. Jerome ordered bishop Celestius to be banished, and he fled to the coast of Palestine, where he lived till the death of the emperor, as related by Jerome. After this time, Celestius being gone, Pelagius returned to Rome, and thence to Palestine, publishing his doctrine, and gaining a great number of converts. He was afterwards banished from Palestine, and came to Carthage, where he was again condemned by the council of Carthage, and banished. Pelagius, who had been banished from Carthage, and had confessed their criminalities, came to the defence of the Pelagians. They wrote

judges, as demanded that the decision of their affair, which was among the Latins, might be referred to judges who understood the language. This happened in the year 416, at which time there were in Palestine two French prelates, who, being driven from their dioceses, fled to that country, and having been apprized of the opinions of Pelagius and Celestius, drew up an abridgement from their own books of the errors imputed to them. To this they joined the articles condemned in the synod of Carthage, and some others, which were sent from Sicily by Hilarius to St. Augustine, and then presented the abridgement to the bishop of Caesarea. The matter was referred to a council of 14 bishops, at which, when the memoir was read, Pelagius explained himself upon some articles, and denied that he was the author of others. He also disowned the propositions condemned at Carthage, and some others ascribed to Celestius. He did not even hesitate to condemn them; upon which the bishops decided, that, since Pelagius approved the doctrine of the church, and rejected and condemned what was contrary to its belief, they acknowledged him to be of the ecclesiastical and catholic communion.

Orosius returning to Africa, took with him the memoir against Pelagius, and presented it to a meeting of bishops held at Carthage in 416. Having read over what had been done at a former meeting against Celestius, they declared, that both he and Pelagius ought to be anathematized if they did not publicly renounce and condemn the errors imputed to them. The bishops of this meeting, and those of Numidia assembled the same year at Milevetum, wrote upon the subject to Pope Innocent, who approved of the judgement of the African prelates, and declared Pelagius, Celestius, and their followers excommunicated. Innocent gave an account of this judgement to the bishops of the East, and the matter seemed altogether at an end, when he died; but Celestius having been made priest at Ephesus, and having gone to Constantinople, whence he was driven by Aetius bishop of that city, who also wrote against him to Asia and to Africa, he came to Rome in the beginning of the pontificate of Zozimus, and undertook to pursue the appeal, which he had formerly made from the judgement of the synod of Carthage. Having cited his accuser Paulinus, and offered to justify himself, he presented a Confession of Faith, in which he acknowledged that children ought to be baptized, in order to inherit the kingdom of heaven; but he denied that the sin of Adam was transmitted to his children. He appeared before the bishops and clergymen assembled by the pope, and declared, that he condemned all the errors with which he had been charged. The pope delayed his judgement for two months, and in the mean time received a letter and a confession of faith from Pelagius, very artfully drawn up. When the time for judgement arrived, Zozimus held a synod, at which, that he thought the doctrines of Pelagius and Celestius sufficient for their justification. He was disowned at the two French synods for not appearing to defend them, and wrote two letters on that head, one to the bishops of Africa, and another in particular to Aetius, bishop of Carthage. The African bishops, to the number of 212, with it regarded the judgment passed at Rome, assembled at Carthage, and having confirmed their criminalities, came to the defence of the Pelagians. They wrote

50mpelagi-
glans

St. Au-
gustine on
Original
Sin, and
against the
Pelagians.

The Epi-
sops of St.
Augustine.

St. Marius
Mercator's
Commentary.

Semipel-
gians

to the bishop of Rome to acquaint him, that he had been deceived by Celestius, and discovered to him the equivocations of his letter and of the Confession of Faith of Pelagius, sending him a memoir of the errors of which he should require a distinct and precise revocation from the two heretics. The pope made answer, that, although his authority was so great, that none durst dissent from his judgement, still that he was willing to communicate the matter to them, and would let it remain in the same state, until a new deliberation could take place. This letter was presented to a council held at Carthage in 418, at which eight canons were drawn up against the Pelagian heresy. The bishop of Rome, in the mean time, was inclined to examine again the affair of Celestius, and to endeavour to draw from him distinct and precise answers according to the plan suggested by the African bishops in their memoir; but Celestius would not come forward, and accordingly withdrew from Rome. From his flight the pope concluded, that he imposed upon him formerly, and that he held the new doctrines; and, accordingly, changing his opinion with respect to him, he approved of the decrees of the African prelates, and renewed the condemnations of his predecessor, Pope Innocent, against him and Pelagius. This judgement he published in a letter which was sent to all the bishops. About the same time an edict was published by the emperor Honorius against Pelagius and Celestius, ordering, that they should be banished from Rome, and that all their followers should be sent into exile.

In the following year Honorius published another edict, by which it was ordered, that the bishops who would not sign the pope's letter, should be deprived of their churches. Accordingly, Julian the bishop of Eclana, who was afterwards head of the party, and seventeen other bishops, were cashiered; upon which they wrote a letter to Rufus, bishop of Thessalonica, and demanded a universal council from the emperor, which he refused. Celestius returned again to Rome, but was again expelled the city; whilst his followers, being expelled from Italy, retired to different countries. Some of them came over into Britain, and others went into the East. Aticus banished them from Constantinople, and they were also banished from Ephesus. Theodosius, bishop of Antioch, condemned them in a synod held at Diopolis, and banished Pelagius and his followers out of Palestine, whither they had returned. Julian the bishop was condemned in a provincial synod of Cilicia, whither he had retired to Theodorus bishop of Mopsueta, who was obliged to anathematize him. What became of Pelagius is unknown, as history gives no farther account of him; but Celestius having returned to Rome, and being driven thence by Pope Celestin, went with Julian and some other bishops of their party to Constantinople, where they endeavoured to prevail upon the emperor Theodosius to assemble a council, instead of which he ordered them to leave the city. After this they joined with the Nestorians, and were condemned together with them in a general council held at Ephesus in 431; and there now remained but a small number of Pelagians dispersed in the West. Julian after having endeavoured several times to get himself reinstated in his bishopric, was at last obliged to retire into exile, where he died.

To the Pelagians succeeded the Semipelagians, who

rejected the doctrines of the former with respect to original sin and the power of free will to do good. They owned, that man had need of the grace of God to persevere in well-doing; but they believed, that the beginning of good will and faith did not necessarily depend upon grace; for that man, by the mere force of nature, might desire to do good, and that God seconded that good will by his assistance, which depended upon liberty, and was given to all men. Besides these, they maintained some other peculiar tenets. The origin of some of their opinions is founded in this, that some of the books which were written by St Augustine in his last years, with respect to the controversies which arose in the monastery of Adrumetum, relative to correction, grace, and predestination, having been carried into Gaul, happened to give offence to several persons, and particularly to the monks of Lerins, who considered his doctrines hostile to that of free will. This led them to think and to maintain, that, in order to be saved, it was necessary to leave to man the power of knowing and desiring good by the force of nature, so that the beginning might come from man. Several considerable persons in Gaul, and even some bishops, but particularly the priests, were of this opinion. Cassian, deacon of Constantinople, and afterwards priest at Marseilles, authorized it in his conferences, and Faustus, bishop of Riez, supported it very intenuously. St Augustine stood up to oppose this doctrine from its very first appearance, and was supported by Prosper and Hilarius. Pope Celestin complained to the bishops of Gaul, that they suffered their priests to speak ill of the doctrines of St Augustine; and Popes Gelasius and Hormidas condemned the books of Faustus; and last of all, the council of Orange, held in 529, condemned particularly the principal tenets of the Semipelagians, and put an end at that time to the controversy, about 100 years after the death of St Augustine.—See the histories of Moheim, Dupin and Fleury, &c. &c.

The Semipelagians were very numerous; and their doctrines, though variously explained, were received in many of the monastic schools in Gaul, whence they spread themselves far and wide through Europe. With respect to the Greeks and other Christians of the East, we may remark, that they had adopted the Semipelagian tenets, even before they were promulgated in Gaul by Cassian and Faustus.

After the period, however, at which the Semipelagian doctrines were condemned in the council of Orange, we find but little notice taken of this sect by historians. Although its tenets were maintained by a few in the succeeding centuries, the sect could boast of no eminent leaders, and sunk into obscurity. In the beginning, indeed, of the reformation, some of the Pelagian tenets were again brought into circulation. Every one is acquainted with the hostility of Luther to the doctrine of free will, who went so far into the opposite extreme as to entitle one of his works against the celebrated Erasmus on this subject, "*De Servo Arbitrio*." But notwithstanding that Luther was their leader, this doctrine of his was not adopted by some of the most eminent of the reformers. His learned friend, the mild and pious Melancthon, although he attacked either from not being sufficiently considered the subject, or because this doctrine was so unpopular to the great body of the reformers on account of the authority of Luther, yet

Semipel-
gians
Hilary's
Letters to
Pelagius

See the
Letters of
St Augu-
stine.

Prosper
in his Chro-
nicle.

with Luther in his hostility to the doctrine of free will, to far as to say, that free will could have no effect, under the influence of grace, if only after changed its opinion from even into the opposite extreme. For although Luther at his death had affirmed, that the predestination of God annihilates free will in all his creatures, he was afterwards more than once, in the line of the Saxon Confession of Faith, as to allow Melancthon, who composed it, to treat these words, "that it was necessary to allow free will to all who possessed the use of reason, not however in such things as regarded God, which they could not commence, *sed et illi tractare et uti non possunt*," without His influence and grace, but in the affairs, or works, of the present life only, and in order to perform their duty towards society." In this passage two truths are clearly admitted: 1. That there is free will in many and 2. That if it is free, only in such works as are purely Christian or religious. But although this he admitted, and although it would seem as if he attributed the efficacy of religious works solely to the grace of God, yet the remaining words "at hoc" show, that he was of opinion, that free will, by its own natural force and efficacy, though it could not complete, *could at hoc commovere*, Christian or religious works, with the assistance of grace. To such of our readers as are acquainted with ecclesiastical history, it is unnecessary to remark, that this was one of the leading tenets of the Semipelagians. But Melancthon did not stop here. He says, that, in order to keep well within the measure, he was obliged, in those public instruments which he drew up, to insinuate rather than avow his party for the doctrine of free will, the efficacy of which, he confined in the Confession of Augsburg to such religious merely as regard civil life and our duties to society. In the Saxon Confession of Faith, however, he proceeds farther, and says "that the will is free: that God neither wishes for, nor approves, nor co-operates in the production of sin; but that the free-will of man and of the devil is the true cause of their sin and of their fall." Many a doubt will be of opinion, that Melancthon merits praise for having thus corrected Luther, and for having more clearly expressed his own opinion, than he had done in the Confession of Augsburg. He even proceeds farther, and extends the exercise of free-will to religious or Christian works. For after having explained in the Saxon Confession of Faith the nature of free-will, and the manner in which it makes a choice, and having also shown, that it is not of itself sufficient in those works, or actions, which regard a future life, he affirms twice "that the will, even after having received the influence of the Holy Spirit, does not remain idle," that is to say, it is not merely passive under the influence of grace, but can reject it, or co-operate with it, at pleasure. Necessity, it is true, obliged him to express his opinion rather obscurely. But what he insinuates only in these last quoted words, is clearly and fully expressed in one of his letters to Calvin. "I had, says he, a friend who, in reasoning upon predestination, believed equally the two following things; namely, that every thing happens amongst men as it is ordained by Providence, but that there is, nevertheless, a contingency in actions or in events. He confessed, however, that he was unable to reconcile these two things. For my part, (continues Melan-

cthon), whom of opinion, that God neither wishes for, nor co-operates in, the knowledge, this contingency is a logical crisis of our judgment, in order that the ignorant may confess, that David said of himself, and voluntarily, into that that he believed it in his power to produce the grace of the Holy Spirit which he had within him, and that in his election, or trial, it is necessary to reject the same exercise or action of the will." See Cal. 1st Let. 1000
This opinion he confirms and illustrates by a passage from St. Basil, who he says, "Have but the will, or the inclination, and God is with you." By which words Melancthon seems to insinuate, that the will is not only active in the works of religion, but even begins them without grace. This, however, was not the meaning of St. Basil, as is evident from several other parts of his writings; but that it was the opinion of Melancthon is possibly from this passage, as well as from that which we have cited from the Confession of Augsburg, in which he insinuates, that the error is not in saying, that the will can of itself commence, but in thinking, that it can without grace finish or complete, religious or Christian works. Thus it appears, that he confessed the will capable of rejecting the influence of grace, free he declares, that David could preserve the Holy Spirit when he lost it, as well as he could lose it when he kept it within him. But although this was his decided opinion, he durst not avow it fully in the Saxon Confession of Faith, but was obliged to content himself with insinuating it gently in these words, "The will, even after receiving the grace of the Holy Spirit, is not idle or without action." All this precaution, however, was insufficient to save Melancthon from censure. Finckwitz, better known by the name of Illyricus, being jealous of him and his enemy, by his influence with his party procured the condemnation of these words of the Saxon Confession, and of the passage from St. Basil, at two synods held by the Reformers: at the first time, that one party of the Lutherans were unwilling to adopt Melancthon's opinion, "that the will is not passive, when under the influence of grace," we are at a loss to think how they could deny it, since they almost unanimously confess, that a person under the influence of grace may reject and lose it. This opinion is avowed in the Confession of Augsburg and in Melancthon's Apology. It was even, long after that, decided upon anew, inculcated strongly in their book of Concord, and was brought frequently against them by their opponents as a proof of inconsistency and contradiction.

These are not the only instances in which the Lutherans were charged with Semipelagian principles. One of the ablest and the most learned of their opponents, we cannot help thinking, had in more than one instance made good the charge against them. To prove this we need only refer to the remarks that have been made on the eight celebrated propositions in the third book of Concord, relative to the co-operation of the will with grace. According to the first seven of these propositions, an attentive listening to the preaching of the word of God produceth grace; and according to the fifth, any man, even a libertine or an infidel, is free, or has it in his power to listen attentively to the preaching of the word of God. He has it then in his power to give to himself that which to him is productive of grace, and may thus be the sole author of his own conversion

Seneca's
grains
Semiramis

Seneca's grain. In the 1st of his prophecies it is affirmed, that we were permitted to do it, but that the grace of the Holy Spirit, even though it may not be felt, does not deny us an attentive hearing of the word of God; and to do away every doubt as to the species of attention which they mean, we must observe, that they fix it on attention in as much as it precedes the grace of the Holy Spirit, and of that attention which, in consequence of its dependence on free-will, we have it in our power to bestow upon the word or not, just as we please. It is the exercise of this free attention which they say operates grace. But here it would first, that they were to evidence it first, as they laid upon one hand, that when the Holy Spirit begins to move us, we act not at all by it; maintained on the other, that this operation of the Holy Spirit, which converts us without any co-operation on our part, is necessarily attendant upon an act of our wills, in which the Holy Spirit has no share, and in which our liberty acts purely by its natural force or power. Each of our readers as are anxious to evince the prophecies of the Pelagian and Semi-pelagian principles after the dawn of the Reformation, we must refer to the works of the principal reformers and to those of the adversaries, as well as to the different writers upon ecclesiastical history.

SEMIRAMIS, in fabulous history, a celebrated queen of Assyria, daughter of the goddess Derceto, by a young Assyrian. She was exiled in a desert; but her life was preserved by doves for one whole year, till Simmas, one of the shepherds of Ninus, found her and brought her up as his own child. Semiramis, when grown up, married Menages, the governor of Nineveh, and accompanied him to the siege of Babilonia; where, by her advice and prudent directions, she hindered the king's operations, and took the city. These eminent services, together with her uncommon beauty, endeared her to Ninus. The monarch asked her of her husband, and offered him his daughter Sushan in her stead; but Menages, who tenderly loved Semiramis, refused; and when Ninus had added threats to entreaties, he hanged himself. No sooner was Menages dead, than Semiramis, who was of an aspiring soul, married Ninus, by whom she had a son called Ninus. Ninus was so fond of Semiramis, that at her request he resigned the crown, and commanded her to be proclaimed queen and sole empress of Assyria. Of this, however, he had cause to repent; Semiramis put him to death, the letter to ed himself off on the throne; and when she had no enemies to rest at home, she began to repair the capital of her empire, and by her means Babylon became the most famous and magnificent city in the world. She visited every part of her dominions, and left everywhere immortal monuments of her greatness and benevolence. To render the roads safe and communication easy, she hollowed mountains and filled up valleys, and water was conveyed by a great expense by large and convenient aqueducts to barren fields and unfruitful plains. She was not less distinguished as a warrior; many of the neighbouring nations were conquered; and when Semiramis was once told as she was driving her herd, that Babylon had revolted, she led her to battle with precipitation, and though only half dressed, she related to have the rest of her head adorned before the battle was quelled and tranquillity re-established. Semiramis has been accused of licentiousness; and some authors have observed that she

regularly had the most lascivious company before her, and that she might not be living in a more dissipated life. Her public behaviour was not more exact, and it was this criminal conduct which was the cause of her death in another world; she was so much beloved by Semiramis, that she had a great number of children, and received immortal honours by her name. It is said that she lived about 110 years; but the Quakers say, and that she died in the 50th year of her age, and in the 25th of her reign. Many historians have also supposed that Semiramis, and her son, had been deified; and for some time the name of Semiramis was used for her son Ninus. *Leopold's Universal History.*

SEMPERVIUM, *Thymus*, a genus of plants belonging to the class dicotyledons; and in the natural method ranking under the 12th order, *Stemmateæ*. See *BOTANY Index*.

SENAB, or SENNAAR. See *SANNAB*.

SENATE, in general, is an assembly or council of senators; that is, of the principal inhabitants of a state, who have a share in the government.

The senate of ancient Rome is of all others the most celebrated. It consisted to common judicatures; but appointed judges, either from among the knights or *patres*, to determine processes; it also appointed governors of provinces, and disposed of the revenues of the commonwealth, &c. Yet did not the whole sovereign power reside in the senate, since it could not elect magistrates, make laws, or decide of war and peace; in all which cases the senate was obliged to consult the people.

The senate, when first instituted by Romulus, consisted of 100 members; to whom he afterwards added the same number when the Sabines had migrated to Rome. Tarquin the ancient monarch made it 200 of 300, and this number remained fixed for a long time; but afterwards it increased greatly, and was increased first to 700, and afterwards to 900 by Julius Cæsar, who added the senate with men of every rank and order. Under Augustus the senate consisted to 1000, but this number was reduced, and fixed to 600. The place of senator was always bestowed upon merit; the monarchs had the privilege of electing the members; and after the expulsion of the Tarquins, it was one of the duties of the consuls, till the election of the emperor, to fill their office found most capable or most capable of men whose character was irreproachable, whose morals were pure, and relations honourable. Only particular families were admitted into the senate; and when the plebeians were permitted to have the honours of the state, it was then required that they should be born of free citizens. It was also required, that the candidates should be knighthood, and their offices into the senate. They were to be above the age of 30, and to be previously qualified through the functions of a quaestor, tribune of the people, or prætor, and consul.

The first assembly of a senate on the fall of monarchy, for the preservation of the new constitution, and in consequence of this, there were three days, viz. *Ides*, *Kalends*, and *Nones*, besides it regularly met; but it always met on extraordinary occasions, when called together by consuls, tribunes, or dictators.

To render their decrees valid and authentic, a certain number of members was requisite, and such as

were absent without some proper cause were always fined. In the reign of Augustus, 400 senators were requisite to make a senate. Nothing was transacted before sunrise or after sunset. In their office the senators were the guardians of religion, they disposed of the provinces as they pleased, they prorogued the assemblies of the people, they appointed thanksgivings, nominated their ambassadors, distributed the public money, and in short had the management of every thing political or civil in the republic, except the creating of magistrates, the enacting of laws, and the declaration of war or peace, which were confined to the assemblies of the people.

SENATOR, in general, denotes a member of some senate.

The dignity of a Roman senator could not be supported without the possession of 80,000 sesterces, or about 7000l. English money; and therefore such as squandered away their money, and whose fortune was reduced below this sum, were generally struck out of the list of senators. This regulation was not made in the first ages of the republic, when the Romans boasted of their poverty. The senators were not permitted to be of any trade or profession. They were distinguished from the rest of the people by their dress; they wore the stola, half boots of a black colour, with a crescent or silver buckle in the form of a C; but this last honour was confined only to the descendants of those hundred senators who had been elected by Romulus, as the letter C seems to imply. See the preceding article.

Among us, senator is a member of parliament. In the laws of King Edward the Confessor, we are told that the Britons called those senators whom the Saxons called afterwards *aldermen* and *borough-masters*; though not for their age, but their wisdom; for some of them were young men, but very well skilled in the laws. Kenneth king of the Mercians granted a charter, which run thus, viz. *Constito et confirmo* episcoporum et senatorum gentis sue longinus fuit dicitur monasterio, &c.

In Scotland, the lords of session are called senators of the college of justice.

SENATUS AUCTORITAS. See the next article.

SENATUS CONSULTUM, which made part of the Roman law. When any public matter was introduced into the senate, which was always called *referre ad senatum*, any senator whose opinion was asked, was permitted to speak upon it as long as he pleased, and on that account it was often usual for the senators to protract their speeches till it was too late to determine. When the question was put, they passed to the side of that speaker whose opinion they approved, and a majority of votes was easily collected, without the trouble of counting the numbers. When the majority was known, the matter was determined, and a *senatus consultum* was immediately written by the clerks of the house, at the feet of the chief magistrates, and it was signed by all the principal members of the house. When there was not a sufficient number of members to make a senate, the decision was called *senatus auctoritas*, but it was of no force if it did not afterwards pass into a *senatus consultum*.

The *senatus consulta* were at first left in the custody of the kings, and afterwards of the consuls, who could suppress or preserve them; but about the year of Rome

304, they were always deposited in the temple of Ceres, and afterwards in the treasury, by the ediles of the people.

SENECA, LUCIUS ANNEUS, a Stoic philosopher, was born at Corduba in Spain, about the beginning of the Christian era, of an equestrian family, which had probably been transplanted thither in a colony from Rome. He was the second son of Marcus Annaeus Seneca, commonly called the *rhetorician*, whose remains are printed under the title of *Senecæ et Controversiarum, cum Declamationum Excerptis*; and his youngest brother Annaeus Mela (for there were three of them) had the honour of being father to the poet Lucan. He was removed to Rome, together with his father and the rest of his family, while he was yet in his infancy. There he was educated in the most liberal manner, and under the best masters. He learned eloquence from his father; but his genius rather leading him to philosophy, he put himself under the stoics Attalus, Sotion, and Papirius Fabianus; men famous in their way, and of whom he has made honourable mention in his writings. It is probable, too, that he travelled when he was young, since we find him, in several parts of his works, particularly in his *Questiones Naturales*, making very exact and curious observations upon Egypt and the Nile. Put this, though entirely agreeable to his own humour, did not at all correspond with that scheme or plan of life which his father had drawn out for him; who, therefore, forced him to the bar, and put him upon soliciting for public employments; so that he afterwards became quaestor, pretor, and, as Lipsius will have it, even consul.

In the first year of the reign of Claudius, when Julia the daughter of Germanicus was accused of adultery by Messalina, and banished, Seneca was banished too, being charged as one of the adulterers. Corsica was the seat of his exile, where he lived eight years; "happy in the midst of those things which usually make other people miserable;" *inter eas res beatus, quæ solent miseris facere*: and here he wrote his books of consolation, addressed to his mother Helvia, and to his friend Polybius, and perhaps some of those tragedies which go under his name; for he says, *modo se levioribus studiis illi obicitasse*. Agrippina being married to Claudius, upon the death of Messalina, she prevailed with the emperor to recall Seneca from banishment; and afterwards procured him to be tutor to her son Nero, whom she designed for the empire. Africanus Burrhus, a praetorian præfect, was joined with him in this important charge; and these two preceptors, who were entrusted with equal authority, had each his respective department. By the bounty and generosity of his royal pupil, Seneca acquired that prodigious wealth which rendered him in a manner equal to kings. His houses and walks were the most magnificent in Rome. His villas were innumerable: and he had immense sums of money placed out at interest in almost every part of the world. The historian Dio reports him to have had 250,000l. sterling at interest in Britain alone; and reckons his calling it in all at a sum, as one of the causes of a war with that nation.

All this wealth, however, together with the luxury and effeminacy of a court, does not appear to have had any ill effect upon the temper and disposition of Seneca. He continued abstemious, exact in his manners, and

Seneca. and, above all, free from the vices so commonly prevalent in such places, flattery and ambition. "I had rather (said he to Nero) offend you by speaking the truth, than please you by lying and flattery: *maluerim veritatem offendere, quam placere adulando.*" How well he acquitted himself in quality of preceptor to his prince, may be known from the five first years of Nero's reign, which have always been considered as a perfect pattern of good government; and if that emperor had but been as observant of his master through the whole course of it, as he was at the beginning, he would have been the delight, and not, as he afterwards proved, the curse and detestation of mankind. But when Poppaea and Tigellinus had got the command of his humour, and hurried him into the most extravagant and abominable vices, he soon grew weary of his master, whose life must indeed have been a constant rebuke to him. Seneca, perceiving that his favour declined at court, and that he had many accusers about the prince, who were perpetually whispering in his ear the great riches of Seneca, his magnificent houses and fine gardens, and what a favourite through means of these he was grown with the people, made an offer of them all to Nero. Nero refused to accept them: which, however, did not hinder Seneca from changing his way of life; for, as Tacitus relates, he "kept no more levees, declined the usual civilities which had been paid to him, and, under a pretence of indisposition, or some engagement or other, avoided as much as possible appearing in public."

Nero, in the mean time, who, as it is supposed, had dispatched Barrhus by poison, could not be easy till he had rid himself of Seneca also: For Barrhus was the manager of his military concerns, and Seneca conducted his civil affairs. Accordingly, he attempted, by means of Cleonicus, a freedman of Seneca, to take him off by poison; but this not succeeding, he ordered him to be put to death, upon an information that he was privy to Pison's conspiracy against his person. Not that he had any real proof of Seneca's being concerned in this plot, but only that he was glad to lay hold of any pretence for destroying him.—He left Seneca, however, at liberty to choose his manner of dying; who caused his veins to be opened immediately. His wife Paulina, who was very young in comparison of himself, had yet the resolution and affection to bear him company, and thereupon ordered her veins to be opened at the same time; but as Nero was not willing to make his cruelty more odious and insupportable than there seemed occasion for, he gave orders to have her death prevented: upon which her wounds were bound up, and the blood stopped, in just time enough to save her; though, as Tacitus says, she looked so miserably pale and wan all her life after, that it was easy to read the loss of her blood and spirits in her countenance. In the mean time, Seneca, finding his death slow and lingering, desired Statius Anneus his physician to give him a dose of poison, which had been prepared some time before in case it should be wanted; but this not having its usual effect, he was carried to a hot bath, where he was at length killed with the beams. He died, as Lipsius conjectures, in the 63d or 64th year of his age, and in about the 12th or 13th of Nero's reign. Tacitus, on mentioning his death, observes, that, as he entered the bath, he took of the water, and with it sprinkled some of his nearest domestics, saying, "That he offered those libations to Jupiter the Deliverer." These words are an evident proof that Seneca

was not a Christian, as some have imagined him to have been; and that the 13 epistles from Seneca to St Paul, and from St Paul to Seneca, are supposititious. His philosophical works are well known.—They consist of 124 epistles, and distinct treatises; and, except his books of physical questions, are chiefly of the moral kind, treating of anger, consolation, providence, tranquillity of mind, constancy, clemency, the shortness of life, a happy life, retirement, benefits. He has been justly celebrated by Quintilian and other critics, as one of the first corrupters of the Roman style; but his works are highly valuable, on account of the vast erudition which they discover, and the beautiful moral sentiments which they contain.

SENECIO, GROUNDSEL; a genus of plants belonging to the class Syngenesia, and to the order of polygamia superflua; and in the natural method ranking under the 49th order, *Compositae*. See *BOTANY INDEX*.

SENEGAL, a part of Negroland in Africa, the boundaries of which are not known. See *GUINEA*.

Ile of SENEGAL, sometimes called *Saint Louis*, is a small island in the mouth of the river Senegal, and according to Maskelyne's tables is situated in N. Lat. 15. 53. W. Long. 16. 31. The Dutch were the first Europeans who settled at Senegal; but their colony was expelled by the French in 1687. It was taken by the English in 1692; and retaken by the French the year following. It was a second time taken possession of by the English in 1758; but in 1779 the French recovered it, and it was ceded by the British crown by the treaty of 1783.

The best account of this island which we have seen, is given in the interesting voyage of M. Saugnier to the coast of Africa. This adventurer visited Senegal in June 1783.

"The island (says he), properly speaking, is only a bank of sand in the middle of the river. It is 1500 geometrical paces long, and about 60 in its greatest width; is almost on a level with the river and with the sea, being defended from the latter by Barbary point, which is of greater elevation than the colony. The eastern branch of the river is the more considerable of the two, being about 400 toises across; the western branch is only from 50 to 200 toises wide. The soil consists entirely of burning sands, on the barren surface of which you sometimes meet with scattered flints, thrown out among their ballast by vessels coming from Goree, or with the ruins of buildings formerly erected by Europeans. There is scarcely such a thing as a garden upon the island; European seeds in general not thriving here. It is not surprising that the soil is so unproductive; for the air is strongly impregnated with sea salt, which pervades every thing, and consumes even iron in a very short space of time. The heats are excessive, and rendered still more insupportable by the reflection of the sand; so that from ten in the morning until four in the afternoon it is almost impossible to do any work. During the months of January, February, March, and April, the heats are moderated; but in August and the following months they become so oppressive as even to affect the natives themselves. With respect then must they have upon the Europeans, suddenly transported into this burning climate. They breathe a little less salty; not always, however, but only when the sea-breeze lets in. It is then that the inhabitants of the colony breathe a fresher air, for which they have

been blowing the whole of the day, the hot air in our climate would form a burning vapor. The nights are nevertheless troublesome, notwithstanding the comforts of the sea-breeze. The instant the sun is set, we are assailed by an infinity of gnats, which are called *mygætes*; their stings are very painful, and their multitudes incredible. The inhabitants find but a poor defence in their gauze-curtains. For my own part, accustomed as I had been to live among the Moors, I was but little annoyed by these insects. Being half a savage, I felt no desire to recommend myself to the favourable regard of the fair sex, and I was therefore under no necessity of taking care of my person. In imitation of my former masters, I smeared myself with butter, and this expedient preserved me at all times from these impudent stingers, these spiteful enemies to the repose of the human kind.

“ If the prospect of Senegal is not agreeable to the eye, much less are its environs, which are covered over only with sand, and overrun with mangoes. It may be said, without exaggeration, that there is not a more forlorn situation to be found on the face of the inhabited globe, or a place in which the common necessaries of life are procured with greater difficulties. Water, that indispensable aliment of man, is here not potable. Wells are dug in the sand to the depth of five or six feet, and water is obtained by these means; but whatever pains are taken to freshen it, it ever retains a brackish taste. I have distilled this water myself, and observed that it always had a disagreeable flavour, which cannot fail to be hurtful to the health; it is true, that when the river is high, its streams are fresh, but the water is only the more dangerous. It proves the cause of most of those maladies which carry off the Europeans so rapidly, that within the end of every three years the colony has a fresh set of inhabitants. The blacks themselves, although accustomed to the climate, are not in this season free from disease.”

The fort of St Louis is a quadrangle, and has two bastions of considerable strength; but the greatest security of the fort is its natural position. The cannon of the fort are numerous, and the arsenal well supplied with small arms and stores. Besides this fort the French had no other upon the river, except Fort St Jago, which stands at about four leagues below the entrance at Gorée, though they had a few factories in different parts.

The principal commodity of this country is that of gum Senegal (see *Geographical*), which is a valuable branch of commerce, as it is used in many arts and manufactures, particularly by the painters in water-colours, the book-binders, and dyers.

The French import from the river Senegal not only gum-arabic, but elephants teeth, hides, tortoise, gill-net, cotton, oil-rich feathers, and apples, indigo, and clove.

Next to selling the bareness of the soil, Senegal consists of a few 6000 negroes, including the captives of the Moors, or remnants of the black inhabitants of the country. They are never put up to arms, and are considered as slaves.

Their language is the best of Senegal, and they are commonly called the *Peuls*, or *Peulhs*, and upon the whole, the *Peuls* are the most civilized inhabitants of the country. They are now the most numerous, and speak in every dialect a language

from 10 to 12. The beds are composed of bundles laid upon cross-bars, supported by forked stakes at the height of about a foot from the ground. Here the slaves sleep promiscuously, men, women, girls, and boys. A fire is made in the middle of the hut, which is filled with smoke, sufficient to sizzle any man but a negro.

The men are tall, and the women are accounted the handsomest negroes of all Africa. The Senegallians may be considered as the most courageous people of that part of the world, without even excepting the Moors. Their courage, however, is more nearly allied to temerity than to bravery. In the course of the voyage to Gallina, they meet the greatest dangers with gaiety and sang; they dread neither musket nor cannon, and are equally fearless of the cayman or crocodile. Should one of their companions be killed, and devoured by these animals before their face, they are not deterred from plunging into the water, if the working of the ship require it. These excellent qualifications which distinguish them, and on which they value themselves so much, do not, however, preserve them from the common contagion of the country, which inclines them all to rapine. They are emulous to surpass one another in all the arts of over-reaching and fraud. The conduct of the Europeans has, no doubt, encouraged these vices as much as the lessons of the marabous, who inculcate the duty of plundering the Christians to the amount of their power.

The Yelof negroes of Senegal are either Christians or Mahometans, or rather one and the other, or with more truth neither; religion being a matter of indifference to them. Those on the continent are of the same way of thinking, and their religious practices are kept up only for the sake of form. A bar of iron, a few beads, will make them change their opinion at will. By such means are they acted upon; a sufficient proof of their want of all religious principle. The marabout, or priest, and the men of their law, are no better than the rest. “ I have examined the character of several of this order of men (says M. Saugrier), and even among the nation of the Peuls, who are considered as great fanatics, I discovered that they were only publicly attached to their opinions. This white man (say they) does so, he is better informed than I, and why should not I imitate his example?” This way of reasoning is common to all that tract of country.

The colony of Senegal is surrounded with islands, which enclose but of the proximity of the sea, are still more unhealthy than that on which the town is built. They are full of stinging pests, that, when dried up by the sun, exhale a putrid vapour that creates mortally with it, and delectates these islands. It is doubtless the same cause that takes off so many of the French at Senegal during the dangerous season of the year. This also may be in part explained by the bad quality of the water, which flows from the ponds in the neighbourhood of the colony, and though incorporated with that of the river, comes down little abated by the current, and is easily distinguished by a disagreeable taste. This particular is, in my opinion, essentially worthy of notice, and if properly attended to by our medical men, might become the means of preserving many lives.

Senegal-River, see *NIGER*. As so little is known respecting this river, which is one of the greatest in Africa, any additional information must be interesting.

W. de la Roche, a nobleman of the court of France, who has been employed in the service of the King of Aragon, for many years, and who has been promoted to the rank of Captain-General, and is now in the service of the King of Aragon.

The river Niger is situated in the Kingdom of Senegal, or Seneegal, and is the largest river in its country. It rises in the mountains which border the Kingdom of Senegal, and is afterwards the largest river in the country of the empire. It is the largest river of the country of Senegal, and is the largest river of the country of Senegal. It is the largest river of the country of Senegal, and is the largest river of the country of Senegal.

Of this river the rise and course is not known, but the course is from east to west, and is the largest river of the country of Senegal. It is the largest river of the country of Senegal, and is the largest river of the country of Senegal. It is the largest river of the country of Senegal, and is the largest river of the country of Senegal. It is the largest river of the country of Senegal, and is the largest river of the country of Senegal.

The depth of the river at the place of passage, which is more than a hundred miles to the south of the city of Gambia, the capital of the empire of that name, is estimated at 23 or 24 feet English. Its depth is from 10 to 12 fathoms, even of which is 27 inches.

It is well known that even at the island of Gorree, where the ferryman resides, the found of the level is very low on the northern there is several islands; and of Timbuctoo, where the name of Gambia, or black, is given to the stream, the width is described as being that of the Thames at Westminster. In the rainy season it swells above its banks, and not only floods the adjacent lands, but often sweeps before it the cattle and cottages of the short-sighted or too confident inhabitants.

That the people who live in the neighbourhood of the Niger should refuse to profit by its navigation, may justly surprise the traveller; but much greater is his astonishment, when he finds that even the food which the bounty of the stream would give, is actually offered to their acceptance; for such is the want of skill, or such the settled diffidence of the people to this sort of provision, that the fish with which the river abounds are left in undisturbed possession of its waters.

The river Niger is situated in the Kingdom of Senegal, or Seneegal, and is the largest river in its country. It rises in the mountains which border the Kingdom of Senegal, and is afterwards the largest river in the country of the empire.

The river Niger is situated in the Kingdom of Senegal, or Seneegal, and is the largest river in its country. It rises in the mountains which border the Kingdom of Senegal, and is afterwards the largest river in the country of the empire. It is the largest river of the country of Senegal, and is the largest river of the country of Senegal.

The river Niger is situated in the Kingdom of Senegal, or Seneegal, and is the largest river in its country. It rises in the mountains which border the Kingdom of Senegal, and is afterwards the largest river in the country of the empire. It is the largest river of the country of Senegal, and is the largest river of the country of Senegal. It is the largest river of the country of Senegal, and is the largest river of the country of Senegal.

Five cows are the price of the cow-keeper who inhabits the Alps. He adorns his best cows with large bells suspended from broad thongs, which are manufactured and sold by the inhabitants of the Tyrol. These are fastened round the cow's neck, by means of a large buckle. The largest of these bells measure a foot in diameter, swelling out in the middle, and tapering towards the end. The smallest of these bells, including the thong, is worth 150 schillings, while the smallest of the fun himself, even in his best attire, is 100 worth more than 20 schillings. These bells are chiefly worn in the spring, when driven to the Alps, and in the autumn or winter. It is surprising to see how proud and pleased the cows look both when ornamented with their bells. One would easily imagine how sensible their animals are of their rank, and even touched with vanity and jealousy! Should the leading cow be deprived of her honours, she is grieved at the disgrace, which is manifested by her constant lowing, obtaining from food, and growing lean. The rival, on whom the badge of distinction has devolved, feels her marked vengeance, being wounded at d perpetuated by her in the most vicious manner, until the former either receives her bell, or is removed from the herd. If never found, this may appear, it is rendered indubitable by the recurring testimony of cows.

The voice of the fann brings the cows together, when directed on the Alps, who is then led to allure them. That the cattle can well distinguish the note of their keeper,

(A) The most solid proof is that which accompanies the volume which contains the proceedings of the Academy of Sciences. This work was printed in 1791.

Senna.
Sennaar.

keeper, appears from their halting to him, though at a great distance. He furnishes that cow which is in the habit of straying farthest with a small bell, and by her arrival he knows that all the rest are assembled.

SENNA, the leaf of the cassia senna of Linnæus. See CASSIA, BOTANY and MATERIA MEDICA Index.

Montpellier's
Medical
Botany.

Senna appears to have been cultivated in England in the time of Parkinson (1642); and Miller tells us, that by keeping these plants in a hotbed all the summer, he frequently had them in flower; but adds, it is very rarely that they perfect their seeds in England. There can be little doubt, however, but that some of the British possessions may be found well enough adapted to the growth of this vegetable, and that the patriotic views of the Society for encouraging Arts, &c. which has offered a reward to those who succeed in the attempt, will be ultimately accomplished.

Senna, which is in common use as a purgative, was first known to the Arabian physicians Serapion and Mesue: the first among the Greeks who takes any notice of it is Aetorius, but he only speaks of the fruit, and not of the leaves. To remove the disagreeable taste of this medicine, Dr Cullen recommends coriander seeds; and, for preventing the gripings with which it is sometimes attended, he thinks the warmer aromatics, as cardamoms or ginger, would be more effectual.

The *Senna Italica*, or blunt-leaved senna, is a variety of the Alexandrian species; which, by its cultivation in the south of France (Provence), has been found to assume this change. It is less purgative than the pointed-leaved senna, and is therefore to be given in larger doses. It was employed as a cathartic by Dr Wright at Jamaica, where it grows on the sand banks near the sea.

Lond. Med.
four.
vol. viii.

SENNAAR, a country of Africa, bordering upon Abyssinia, with the title of a kingdom; the present government of which was established in the 16th century by a race of negroes named, in their own language, *Shillook*. This country, together with all the northern parts of Africa, had been overrun by the Saracens during the rapid conquests of the caliphs; but instead of erecting any distinct principalities here, as in other parts, they had incorporated themselves with the old inhabitants called *Shepherds*, whom they found at their arrival; had converted them to their religion, and become one people with them. In 1504 the *Shillook*, a people before unknown, came from the western banks of the river Bahiar el Abiad, which empties itself into the Nile, and conquered the country; allowing the Arabs, however, to retain their possessions on condition of paying them a certain tribute. These founded the city of Sennaar, and have ever since continued to carry on an intercourse with Egypt in the way of merchandise. At the establishment of their monarchy the whole nation were Pagans, but soon after became converts to Mohammedanism, and took the name of *Funge*, an appellation signifying "lords or conquerors," and likewise free citizens. Mr Bruce, who passed through this country in his return from Abyssinia, gives a list of 20 kings who have reigned in it since the conquest of the *Shillook*.

This country is inhabited by a people so barbarous and brutish, that no history of them can be expected. One of the most remarkable of their customs is, that the king ascends the throne with the expectation of be-

ing murdered whenever the general council of the nation thinks proper. The dreadful office of executioner belongs to one single officer, styled, in the language of the country, *Sid el Coom*; and who is always a relation of the monarch himself. It was from his regillers that Mr Bruce took the list of the kings already mention-

Sennaar

Bruce's
Travels,
vol. iv.

ed, with the number of years they reigned, and which may therefore be received as authentic. The *Sid el Coom* in office at the time that Mr Bruce visited this country was named Achmet, and was one of his best friends. He had murdered the late king, with three of his sons, one of whom was an infant at its mother's breast; he was also in daily expectation of performing the same office to the reigning sovereign. He was by no means reserved concerning the nature of his office, but answered freely every question that was put to him. When asked by Mr Bruce why he murdered the king's young son in his father's presence? he answered, that he did it from a principle of duty to the king himself, who had a right to fee his son killed in a lawful and regular manner, which was by cutting his throat with a sword, and not in a more painful or ignominious way, which the malice of his enemies might possibly have inflicted.

The king, he said, was very little concerned at the sight of his son's death, but he was so very unwilling to die himself, that he often pressed the executioner to let him escape; but finding his intreaties ineffectual, he submitted at last without resistance. On being asked whether he was not afraid of coming into the presence of the king, considering the office he might possibly have to perform? he replied, that he was not in the least afraid on this account; that it was his duty to be with the king every morning, and very late in the evening; that the king knew he would have no hand in promoting his death; but that, when the matter was absolutely determined, the rest was only an affair of decency; and it would undoubtedly be his own choice, rather to fall by the hand of his own relation in private than by a hired assassin, an Arab, or a Christian slave, in the sight of the populace. Baddy the king's father, having the misfortune to be taken prisoner, was sent to Atbara to Welled Hassan the governor of that province to be put to death there. But the king, who was a strong man, and always armed, kept so much upon his guard, that Welled could find no opportunity of killing him but by running him through the back with a lance as he was washing his hands. For this Welled himself was afterwards put to death; not on account of the murder itself, but because, in the first place, he, who was not the proper executioner, had presumed to put the king to death; and, in the next, because he had done it with a lance, whereas the only lawful instrument was a sword.

On the death of any of the sovereigns of this country, his eldest son succeeds to the throne of course; on which as many of his brothers as can be found are apprehended, and put to death by the *Sid el Coom* in the manner already related. Women are excluded from the sovereignty here as well as in Abyssinia. The princesses of Sennaar, however, are worse off than those of Abyssinia, having no settled income, nor being treated in any degree better than the daughters of private persons. The king is obliged, once in his lifetime, to plough and sow a piece of ground; whence he is named *Baddy*, the "countryman or peasant;" a

title

Sennaar.

title as common among the monarchs of Sennaar as Cæsar was among the Romans. The royal family were originally negroes; but as the kings frequently marry Arab women, the white colour of the mother is communicated to the child. This, we are told by Mr Bruce, is invariably the case, when a negro man of Sennaar marries an Arab woman; and it holds equally good, when an Arab man marries a negro woman; and he likewise informs us, that he never saw one black Arab all the time he was at Sennaar.

The soil and climate of this country is extremely unfavourable both to man and beast. The men are strong and remarkable for their size, but short lived; and there is such a mortality among the children, that were it not for a constant importation of slaves, the metropolis would be depopulated. The shortness of their lives, however, may perhaps be accounted for, from their indulging themselves from their infancy in every kind of excess. No horse, mule, or ass, will live at Sennaar or for many miles round it. The calf is the fume with bullocks, sheep, dogs, cats, and poultry; all of them must go to the sands every half-year. It is difficult to account for this mortality; though Mr Bruce assures us it is the case everywhere about the metropolis of this country, where the soil is a fat earth, during the first season of the rains. Two greyhounds which he brought along with him from Abbara, and the mules he brought from Abyssinia, lived only a few weeks after their arrival at Sennaar. Several of the kings of Sennaar have tried to keep lions, but it was always found impossible to preserve them alive after the rains. They will live, however, as well as other quadrupeds, in the sands, at no great distance from the capital. No species of tree except the lemon flowers near this city; the cultivation of the rose has often been attempted, but always without success. In other respects, however, the soil of Sennaar is exceedingly fertile, being said to yield 300 fold; but this is thought by Mr Bruce to be a great exaggeration. It is all sown with dora or millet, which is the principal food of the people; wheat and rice are also produced here, which are sold by the pound, even in years of plenty. The soil all round is strongly impregnated with salt, so that a sufficient quantity to serve the inhabitants is extracted from it.

SENNAAR, a city of Africa, the capital of the kingdom of that name. It stands according to Mr Bruce's observations, in N. Lat. $15^{\circ} 31' 36''$, E. Long. $33^{\circ} 30' 30''$, on the west side of the Nile, and close upon the banks of it; the ground on which it stands being suit high enough to prevent the inundation. The town is very populous, and contains a great many houses. In Ponsel's time they were all of one story; but now most of the officers have houses two stories high. They are built of clay mixed with a very little straw, and have all flat roofs; which shows that the rains here must be much less in quantity than to the southward. During the time of Mr Bruce's residence here, however, there was one week of continual rain, and the Nile, after loud thunder and great darkness to the south, increased violently; the whole town being covered with the streaks of water, and many families, by their being surprised it had destroyed many villages to the southward. About 12 miles to the eastward of Sennaar is a collection of villages named *Shaddly*, from a great fount of that name, who constructed several granaries here.

VOL. XIX. Part I.

There are no other than large pits dug in the ground, and well pitched in the middle with clay, then sown with grain when it is at its lowest price, and afterwards covered up and ploughed again at top; these pits they call *matamores*. On any prospect of dearth they are opened, and the corn sold to the people. About 24 miles north of Shaddly there is another set of granaries named *Wad-Aboud*, still greater than Shaddly; and upon these two the subsistence of the Arabs principally depends; for as these people are at continual war with each other, and direct their fury rather against the clergy than the persons of their enemies, the whole of them would be unavoidably starved, were it not for this extraordinary resource. Small villages of soldiers are scattered up and down this country to guard the grain after it is sown, which is only that species of millet named *dora*; the soil, it is said, being incapable of producing any other. There are great lowlands made in the earth at proper distances throughout the country, which fill with water in the rainy season, and are afterwards of great use to the Arabs as they pass from the cultivated parts to the sands. The fly, which is such a dreadful enemy to the cattle, is never seen to the northward of Shaddly.

To the westward of these granaries the country is quite full of trees as far as the river Aboud, or El-sice. In this extensive plain there are two ridges of mountains, one called *Jebel Mora*, or the *Mountain of water*; the other *Jebel Segad*, or the *Cold Mountain*. Both of them enjoy a fine climate, and serve for a protection to the farms about Shaddly and Aboud already mentioned. Here also are fortresses placed in the way of the Arabs, which serve to oblige them to pay tribute in their flight from the cultivated country, during the rains, to the dry lands of Abbara. Each of these districts is governed by a descendant of their ancient and native princes, who long resisted all the power of the Arabs. Sacrifices of a horrid nature are said to have been offered up on these mountains till about the year 1533, when one of the kings of Sennaar besieged first one and then the other of the princes in their mountains; and having forced them to surrender, he fastened a chain of gold to each of their ears, expell'd them in the market place at Sennaar, and sold them for slaves at less than a farthing each. Soon after this they were circumcised, converted to the Mahometan religion, and restored to their kingdoms.

" Nothing (says Mr Bruce) is more pleasant than the country around Sennaar in the end of August and beginning of September. The grain, being now sprung up, makes the whole of this immense plain appear a level green land, interspersed with great lakes of water, and ornamented at certain intervals with groups of villages; the conical tops of the houses presenting at a distance the appearance of small encampments. Through this very extensive plain winds the Nile, a delightful river there, at five mile brand, full to the very brim, but never overflowing. Every where on these banks are ten herds of the most beautiful cattle of various kind. The banks of the Nile about Sennaar resemble the pleasant part of Holland in the summer season; but when the water is at its highest, the fine view is almost insupportable; the dora begins to ripen, the leaves to turn yellow and to rot, the lakes to putrify, foeth, become full of vermin, and all its beauty suddenly disappears. The scorched Nubian returns, and all its terrors of poison

Sennaar.

the most common, and most violent, and is followed by a troop of terrible diseases, such as epilepsies, apoplexies, violent fevers, cholera, agues, and long, and painful dysenteries, still more abundant and mortal.

War and rebellion seem to be the only employment of the hardy people, whom Heaven has separated by a wide and deep desert from the rest of mankind; and seem to be the only amusement, seemingly to give them any satisfaction, of the only pleasure which he has afforded them from a celestial creature.

We need not inquire the climate of the country round Senaar, Mr Bruce has several very curious observations. The thermometer rises in the shade to 129 degrees, and the degree indicated by this instrument does not correspond with the sensations occasioned by the sun, or the colour of the people who live under it. In the desert of blacks (says our author) within latitude 13 degrees of Senaar, about 12 degrees south of them, nearly near the line, all the people are white, as we had an opportunity of observing daily in the Galla. Senaar, which is in latitude 13 degrees, is hotter by the thermometer 20 degrees, when the sun is most distant from it, than Gondar, which is a degree farther south, when the sun is vertical.—Cold and hot (says our author) are terms merely relative, not determined by the latitude, but elevation of the place. When, therefore, we fly far, some other explanation is necessary concerning the place where we are, in order to give an adequate idea of the situations of that heat upon the body, and the effects of it upon the lungs. The degree of the thermometer conveys this but very imperfectly; 95 degrees is excessively hot at L'ela in Arabia Felix; and yet the climate of Bel-el is but 15 degrees; whereas 60 degrees at Senaar is only warm as to senses; though Senaar, as we have already said, is in latitude 13 degrees.

At Senaar, then, I call it *calid* when one fully clothed and a full cloth himself is in want of fire. I call it *moderatum* when one fully clothed and at rest feels he could bear more covering all over, or in part, than he has at that time. I call it *tepidum*, when a man is clothed, and at rest feels no such want, and can take moderate exercise in a well building of a room without sweating. I call it *humidum*, when a man, fully clothed, does not sweat, though at rest, but, on a kind, moderate exercise, or moderate exertion. I call it *torridum*, when a man, at rest, or on moderate exertion, sweats excessively. I call it *ardens*, when a man with thin, or little clothing, at rest, though at rest. I call it *caecum*, the climate of Senaar, in that it was at rest, sweats excessively, though at moderate labour, and the knees feel cold, though at rest. I call it *systema* *zeta*, when a man, fully clothed, or with thin clothing, comes on, a violent sweat, and in the next place, as if a small vein was cut, and the blood runs out, the face is impaired, the skin is parched, the pulse is more than ordinary large and quick. The pulse is greivous, denotes death at hand; but the patient, if he is affected by the sun alone, without any violent heat, may recover, which perished us before. I call it *systema* *beta*, when a man, at rest, or on moderate exertion, sweats, and is situated in a place where he may be every thing that is in the breath of the sun. At Senaar, he was situated upon the banks of the Nile, the climate is different from the eastern part of the country. For I am convinced by experiment, that a web of

the finest muslin, wrapt round the body of a man, will occasion at mid-day a greater sensation of heat in the body, than a rise of 5 degrees in the thermometer of Fahrenheit.

At Senaar, from 70 to 78 degrees of Fahrenheit's thermometer is cool; from 79 to 92 temperate; at 92 degrees begins warmth. Although the degree of the thermometer marks a greater heat than is felt by the body of strangers, it seems to me that the sensations of the natives bear still a less proportion to that degree than ours. On the 2d of August, while I was lying perfectly enervated on a carpet in a room deluged with water at 12 o'clock, the thermometer at 110, I saw several black labourers pulling down a house, working with great vigour, without any symptoms of being inured to it.

The dress of the people of Senaar consists only of a long shirt of blue cloth, which wraps them up from the under part of the neck to the feet. It does not, however, conceal the neck in the men, though it does in the women. The men sometimes have a fish tied about their middle; and both men and women go bare-footed in the houses, whatever their rank may be. The floors of their apartments, especially those of the women, are covered with Persian carpets. Both men and women anoint themselves, at least once a-day, with camellia's grease mixed with civet, which, they imagine, softens their skins, and preserves them from cutaneous eruptions; of which they are so fearful, that they confine themselves to the house if they observe the smallest pimples on their skins. With the same view of preserving their skins, though they have a clean shirt every day, they sleep with a greased one at night, having no other covering but this. Their bed is a tanned bull's hide, which this constant greasing softens very much; it is also very cool, though it gives a smell to their bodies from which they cannot be freed by any washing.

Our author gives a very curious description of the queens and ladies of the court at Senaar. He had access to them as a physician, and was permitted to pay his visits alone. He was first shown into a large square apartment, where there were about 50 black women, all quite naked excepting a very narrow piece of cotton rag about their waists. As he was musing whether there were all queens, one of them took him by the hand, and led him into another apartment much better lighted than the former. Here he saw three women sitting upon a bench or sofa covered with blue Surat cloth; they themselves being clothed from the neck to the feet with cotton shirts of the same colour. These were three of the king's wives; his favourite, who was one of the number, appeared to be about six feet high, and so corpulent that our traveller imagined her to be the largest creature he had seen next to the elephant in all the Indies. Her features perfectly resembled those of a negro; a ring of gold passed through her under lip, and weighed it down, till, like a flap, it covered her chin, leaving her teeth bare, which were small and very fair. The inside of her lip was made black with antimony. Her ears reached down to her shoulders, and had the appearance of wings; there was a gold ring in each of them about five inches in diameter, and somewhat smaller than a man's little finger; the weight of which had drawn down the hole where her ear was pierced

Public SENSE is defined by the noble author of the Characteristics to be an innate propensity to be pleased with the happiness of others, and to be uneasy at their misery. It is found, he says, in a greater or less degree in all men, and was sometimes called *κατανοια*, or *señsus communis*, by ancient writers.

Of the reality of this public sense we have great doubts. The conduct of savages, who are more under the influence of original instinct than civilized men, gives no countenance to it. Their affections seem all to be selfish, or at least to spring from self-love variously modified. For the happiness of their wives they have very little regard, considering them merely as instruments of their own pleasure, and valuing them for nothing else. Hence they make them toil, while they themselves indulge in listless idleness. To their children we believe they exhibit strong symptoms of attachment, as soon as they derive assistance from them in war, or in the business of the chase; but during the helpless years of infancy, the child is left by the selfish father wholly to the care and protection of its wretched mother; who, impelled by the *force* of all females to their young, cherishes her offspring with great fondness.—The savage is, indeed, susceptible of strong attachments, similar to that which we call friendship; but such attachments are no proofs of disinterested benevolence, or what his Lordship calls the *public sense*. Two barbarous heroes are probably still linked together by the observation of each other's prowess in war, or their skill in pursuing their game; for such observation cannot fail to show them that they may be useful to one another; and we have elsewhere shown how real friendship may spring from sentiments originally selfish. The savage is very much attached to his horse or tribe, and this attachment resembles patriotism; but patriotism itself is not a sentiment of pure benevolence delighting in the happiness of others, and grieving at their misery; for the patriot prizes his own country to all others, and is not very scrupulous with respect to the rectitude of the means by which he promotes its interest, or depresses its rivals. The savage pursues with relentless rigour the enemies of himself or of the tribe to which he belongs; shows no mercy to them when in his power, but puts them to the cruellest death, and carries their scalps to the leader of his party. These facts, which cannot be controverted, are partially incoercible with innate benevolence, or a public sense comprehending the whole race of men; and show the truth of that theory by which we have in another place endeavoured to account for all the passions, social as well as selfish. See PASTORS.

SENSES, PLACERS AND PAINERS. The natural agreeableness, disagreeableness and indifference of our sensations and perceptions, present to the mind an important and extensive field of inquiry; and on this subject we shall here make a few observations. All our senses have been evidently bestowed upon us for wise and beneficent purposes; and, accordingly, we find, that all of them, when properly cultivated, or exercised and improved, are capable of affording us much pleasure. The senses of smell and of taste seem rather intended for the preservation of our animal existence, and in this point of view are properly an object of the natural pity of man; whilst the other three seem to be more peculiarly intended for our mental improvement, and accordingly

form an object of intellectual and of moral philosophy. And agreeably to this we know that we derive a great deal of very useful knowledge, in an easy and simple manner, concerning the objects that surround us, in the early part of life, from all the senses, particularly from sight and touch, and this too without labour or study. But this is not the only purpose for which the senses were designed.

It being thus certain, that the senses were bestowed upon us partly to preserve our animal existence, and partly for our mental improvement, it seems reasonable, even *a priori*, to expect that nature would attach some pleasure to such use and exercise of them, as are calculated to promote these ends, and pain to the contrary; particularly in those instances in which she has left the management of them subject to our own control. And accordingly we cannot but observe what delight we derive from our senses, especially in the morning of life, by which it would seem, that nature intended thus winningly to invite us to the proper exercise and improvement of them; and as it were unconsciously, acquire much useful knowledge. It is this species of pleasure that supports and excites boys in the constant and often immoderate exercise of their organs of voluntary motion; the powers of which are thus increased and invigorated.

The exercise and improvement of the senses being subservient to our intellectual improvement, nature has also kindly attached much refined and rational pleasure to the mental exertions; so that we are thus seduced, as it were, to the cultivation of the various extraordinary powers and faculties of the mind.

It is evident that nature has given such organs and faculties to man, as are calculated not only to make him live, but also to render life agreeable. Here too we obtain a slight glimpse at least of some of the final causes of the pleasures of sense. But if it be asked how it happens, that there are such wide diversities between our sensations, some being by nature very agreeable to all men, and some as disagreeable, whilst there are others so indifferent, as to give neither pleasure nor pain, we must confess, that we can give no satisfactory answer, to show how so many very different sensations are produced by various kinds of impressions made on certain organs of the body, and how all these different impressions excite such sensations as suggest not only corresponding perceptions and external qualities, but at the same time affect the mind with pleasure, pain, trouble, anxiety, or disgust. To be successful in these inquiries, we must presuppose some knowledge of the nature of the connection subsisting between the mind and body, which there is reason to think is placed beyond the limits prescribed by nature to human research.

The pleasure or pain which constantly attends certain sensations is not uniform in degree, but varies considerably, not only in different individuals, but even in the same persons at different times. It is not thus with the sensations themselves. These are always constant and uniform. The same kind of impression, when the organs &c. are found, uniformly and invariably produce similar sensations; and these are as invariably followed by their respective objects of their own peculiar exciting codes. For any particular impression is never known to excite in the same person a new sensation, or the perception of an external object different from that which it previously suggested,

Sensib.

suggested, excepting in cases of disease. And when it does rarely occur, as in those who cannot distinguish a particular colour, smell or taste, from certain others, we uniformly attribute it to disease or malformation. Were we not thus to have uniformly similar sensations and perceptions of external objects from similar impressions, the senses would not be at all subservient to our intellectual improvement; since, by giving different lessons concerning the same or similar objects at different times, they would render it impossible for us to be certain of any thing, or to benefit by experience.

The effects of custom, which are at all times to be considered and evident with respect both to the mind and body, (as in the case of particular organs or faculties much improved by attention and exercise,) have little or no influence at all in interrupting or modifying this uniformity in our sensations and perceptions. For no sound, or properly organized person will, either naturally or by custom, ever mistake hardness for softness, red for green, or sweet for bitter. But the influence of custom in modifying the pains and pleasures of sense is well known and considerable. For a person, who can most accurately distinguish sweetels from sourness, will at the same time, either by particular confirmation, or more frequently in consequence of use and habit, prefer wormwood or tobacco to honey.

But although we may despair of being ever able to discover the physical cause of the pleasures and pains of the senses, we may, however, advance a little by observing and registering particular facts. It is, accordingly, of use to remark, that every species of sensation, if its nature be otherwise exchanged, is agreeable or disagreeable in proportion to its strength or intensity. For there is no sensation, however agreeable, that will not become disagreeable, and even intolerable, if it be immoderately intense. Whilst on the contrary, those, which by their strength and nature are very troublesome, if rendered more mild and moderate become not only tolerable, but agreeable. Thus, with respect to the senses it would seem, that pain and pleasure are only different degrees of the same feeling, and when we consider the great varieties of which the sensation, not only of different organs, but even of any one of them, is susceptible, and that each degree of these may be accompanied with pleasure or pain, more or less, we must conclude that the pains and pleasures of sense are capable of numberless modifications both in degree and in kind.

We frequently observe, that sensations which were at first agreeable, if often repeated, lose their relief, though the nature and strength of the impressions be the same; whilst others from being at first very disagreeable, as the taste of tobacco and opium, become very pleasing, though the nature and strength of the impressions have suffered no change. For the explanation of such facts as these we must have recourse to the effects of custom. Thus, in both these opposite cases, the sensations from being of one or the other part of the strength, and of the novelty, of a sort, of their first impressions; and, with respect to the former instance, being unable to command the attention, become in the course of time almost wholly, or altogether neglected, whilst in the latter case, from being very disagreeable, they become highly agreeable. But if it be asked why habit and custom produce these effects, and in what

manner, we are unable to explain it farther, than by saying, since the fact is unquestionable, that such is the nature of the human constitution. O! the effects themselves, no man can entertain a doubt; and their causes, though at present unknown, may by time and inquiry be farther developed and simplified. "The labyrinth," says Dr. Reid, "may be too intricate, and the thread too fine, to be traced through all its windings; but if we stop where we can trace it no farther, and secure the ground we have gained, there is no harm done; a quaker eye may in time trace it farther."

These painless are capable of affording us still farther explanations. Why are new sensations always more agreeable and variety to pleasing? Because they fix the attention more, and are not as yet blunted by frequent repetition or by habit. It is because some sensations lose their wonted effects by custom and by repetition, that we require stronger ones, or at least stronger impressions on the organs and nerves, to increase or continue our pleasures. It is also in consequence of their becoming less poignant through habit that we neglect so many pleasures, which we hardly know to be such, till they have flown for ever; and it is because in the meaning of the every thing has more novelty, and because habit has not destroyed their relief, that the pleasures of youth are much more intense than those of age. The degree of pleasure is similar to that which a blind man would feel on being made to see, or to that which a man would enjoy on suddenly acquiring a new sensitive faculty, although by long use and habit these pleasures are at present for the most part or wholly blotted away.

Although most sensations, when strong and lively enough to make themselves accurately and easily distinguished, generally please most, each in its own kind and manner; still, as there are different kinds of pleasure, different sensations may please the mind in various ways; and accordingly, it is not from the heat of the midday sun, nor from the beautiful and lively appearance of all nature at noon, solely that the eyes derive pleasure, any more than grand musical sounds are the only things that please the ear. For we often contemplate with a very different and a very considerable degree of pleasure the soft and awful scenes of nature, the twilight darkness of the shady grove, and even the gloomy horror of night itself. We listen with delight to the tempest raking the forest, as well as to the gentle murmur of the passing stream. There is even a time when nothing gives us much pleasure as darkness, silence, and the absence of all sensation.

Amidst the great variety of good and evil with which we are every where surrounded, it is a matter of the highest importance to be able to discern aright. This we should be incapable of doing were we not endowed with a sensible as well as painful sensation. These serve to direct our choice. Whatever contributes in any degree to our preservation and to the improvement of our organs and faculties, is accompanied with pleasure; and on the contrary, when we are threatened with danger a painful sensation gives us the alarm. It is to the establishment of this law that we are indebted for the duration of our lives, the improved and vigorous state of our faculties, and the enjoyment of that small portion of happiness allotted to us by nature. "God," says Epictetus, "having endowed men with various faculties, both body as well as intellect, in order to promote their hap-

pleasure, which tends to conduct him to this noble end, not only by the deductions of reason, but also by the force of instinct and sensation, which are more powerful and efficient principles. Thus nature, by a sensation of pain, not only apprises us of what might prove hurtful to our soul, or the contrary, by an agreeable sensation, gently leads us to whatever may tend to the preservation of our existence, and to the perfect state of our faculties: thus being the two points on which our principal demands. Our faculties can neither be of use, nor display themselves farther than as we exercise them: motion or action is therefore necessary to us; that without it we must inevitably sink into a deplorable state of insensibility and languor. On the other hand, excessive weak and limited creatures, all excessive and violent action would impair and destroy our organs; we must therefore use only moderate motion or exercise, and by this means the use or perfection of our faculties is recommended with our chief interest, which is self-preservation. Now as to this happy medium, I mean to moderate exercise of our faculties: that the author of our nature has wisely annexed pleasure.

The pleasures of sense are thus confined within narrow limits, so that they cannot be much increased without pain, or often repeated without losing their relish, at least in a great measure: nor can they be long continued, partly for the same reason, and because they exert on the mind, or rather the nervous system. Hence we see that our animal appetites are confined within a narrow range, and is content from the effects of excess in eating and drinking. All our sensitive powers are immediately satisfied, on the contrary, our intellectual powers are not limited and improved by use and exercise. As I have just said, it is we ourselves our sensitive powers, our desires of images, ideas, and the pleasures, which are the objects of these desires, become regularly less pleasurable. These, indeed, are the regular uses of nature: for it would seem, as if she intended to allow us gently to us in this way, by means of practical experience, that we are not bound to the enjoyment of pleasure, at least not for that of the pleasures of the senses; for all of them, as we have already remarked, if much indulged, lead to themselves and disturb, and sometimes to a miserable pain. And indeed, just as pleasure passes thus readily into trouble and pain, so does the sudden cessation of pain, at least when this has been considerable, produce often extraordinary pleasure. So that we may here apply the beautiful allegory of the comic Scorners, "that although pleasure and pain are contrary in their nature, and have their faces turned different ways, yet that Jupiter has tied them together, that he who lays hold of the one draws the other along with it."

We have just said, that the sudden cessation of pain, at least when this has been considerable, produces often extraordinary pleasure. But this opinion seems to be decided in a late inquiry concerning taste. "Among

the pleasures of sense," says Mr Knight, "more particularly among those belonging to touch, there is a certain class, which, though arising from negative causes, are nevertheless real and positive pleasures: as when we gradually sink from any violent or excessive degree of action or irritation into a state of tranquillity and repose. I say gradually; for if the transition be sudden and abrupt, it will not be pleasant; the pleasure arising from the inverted action of the nerves, and not from the utter cessation of action. From this inverted action arises the gratification which we receive from a cool breeze, when the body has been excessively heated; or from the rocking of a cradle, or the gentle motion of a loom, or easy carriage, after having been fatigued with violent exercise. Such, too, is that twilight, or the gloomy shade of a thicket, affords to the eye after it has been dazzled by the blaze of the mid-day sun; and such, likewise, is that which the ear receives from the gradual diminution of loudness of tone in music." That pleasure follows a gradual cessation of any violent action or irritation, we mean not to deny; but we are at a loss to comprehend how it follows, that the transition from strong pain, if it be sudden and abrupt, will not be pleasant.

But although the pleasures of sense be thus limited, these limits are very different with respect to the different senses. Some of them are soon exhausted, and do not any longer distinguish well the objects that correspond to them; nor are they pleased with those objects which are not but very agreeable, and which they distinguish with sufficient accuracy; whilst others continue to perform their functions longer, and enjoy a more extended pleasure. Thus the senses of smell and of taste are soon or immediately fatigued; the sense of hearing more slowly; but the sight is in this respect the last of all to be fatigued or tired: whilst the pleasures that arise from the exercise of our mental faculties are by far the most durable effect. "Exercise of the mind is as necessary as that of the body to preserve our existence. The senses of other animals, being more quick than ours, are sufficient to direct them to follow what is agreeable to their nature, or to shun whatever is contrary thereto. But we are endowed with reason in order to surpass the insensibility of our senses; and pleasure prevents herself as an instrument to exercise, in order to keep the mind from a state of listless inactivity. Pleasure is not only the parent of frolic and amusements, but also of arts and sciences; and as the whole universe is, as it were, forced by our industry to pay tribute to our wants and desires, we cannot but acknowledge our obligation to that law of nature, which has annexed a degree of pleasure to whatever exercises without fatiguing the mind. The pleasure accompanying it is sometimes so great that it transports the very soul, so that the limbs as it were disengage from the body. We know what is recorded in history concerning Archimedes (A), and several other geometricians both ancient and modern. If

(A) When Syracuse was taken by the Romans under Marcellus, Archimedes was in his study, so intent upon some geometrical problems, that he neither heard the clamour of the Romans, nor perceived that the city was taken. In this transport of study and contemplation a soldier came on him with his drawn sword; Archimedes, on seeing him, besought him to hold his hand till he had finished the problem he was about. But the soldier, deaf to his intreaty, ran him through the body, although Marcellus, upon entering the city, had given orders that Archimedes should be spared.

had never been; it even requires attention to the operations of our minds to be convinced of their existence. For this end we may observe, that to a good ear every human voice is distinguishable from all others. Some voices are pleasant, some disagreeable; but the far greater part cannot be said to be one or the other. The same thing may be said of other sounds, and no less of tastes, smells, and colours; and if we consider, that our senses are in continual exercise while we are awake, that some sensation attends every object they present to us, and that familiar objects seldom raise any emotion pleasant or painful; we shall see reason, besides the agreeable and disagreeable, to admit a third class of sensations, that may be called indifferent. But these sensations that are indifferent are far from being useless. They serve as signs to distinguish things that differ; and the information we have concerning things external comes by these means. Thus, if a man had not a musical ear so as to receive pleasure from the harmony or melody of sounds, he would still find the sense of hearing of great utility. Though sounds gave him neither pleasure nor pain, of themselves, they would give him much useful information; and the same may be said of the sensations we have by all the other senses.

SENSIBLE NOTE, in *Music*, is that which constitutes a third major above the dominant, and a feminine beneath the tonic. *S₁* or *B*, is the sensible note in the tone of *a* or *C* *flat*; or *G* sharp, in the tone of *f*, or *A*.

They call it the *sensible note* on this account, that it causes to be perceived the tone or natural series of the Key and the tonic itself; upon which, after the chord of the dominant, the sensible note taking the shortest road, is under a necessity of rising; which has made some authors treat this sensible note as a major dissonance, for want of observing, that dissonance, being a relation, cannot be constituted unless by two notes between which it subsists.

It is not meant that the sensible note is the seventh of the tone, because, in the minor mode, this seventh cannot be a sensible note but is ascending; for, in descending, it is at the distance of a full tone from the tonic, and of a third minor from the dominant.

SENSIBILITY, is a nice and delicate perception of pleasure or pain, beauty or deformity. It is very nearly allied to taste; and, as far as it is natural, seems to depend upon the organization of the nervous system. It is capable, however, of cultivation, and is experienced in a much higher degree in civilized than in savage nations, and among persons liberally educated than among boys and illiterate mechanics. The man who has cultivated any of the fine arts has a much quicker and more exquisite perception of beauty and deformity in the execution of it, than another of equal or even greater natural powers, who has but casually imbibed its productions. He who has been long accustomed to the discernment of numbers which characterize the objects of the world, perceives most instantaneously the smallest deviation from it, and feels himself almost equally hurt by behaviour that is in itself, as by the most essential defects; and the man who has long prosecuted his study in the paths of virtue, is often pained to himself the deformity of sin, as the mechanics of which his constitution is more exquisitely pleased at any deviation from its rule, than another who, though his

life has been dashed by no crime, has yet thought less upon the principles of virtue and consequences of vice.

Every thing which can be called sensibility, and is not born with man, may be resolved into affection, and is to be regulated accordingly; for sensibilities may be acquired which are inimical to happiness and to the practice of virtue. The man is not to be envied who has so accustomed himself to the forms of polite address as to be hurt by the unaffected language and manners of the honest peasant, with whom he may have occasion to transact business; nor is he likely to acquire much useful knowledge who has so sedulously studied the beauties of composition as to be unable to read without disgust a book of science or of history, of which the style comes not up to his standard of perfection. That sensibility which we either have from nature, or necessarily acquire, of the miseries of others, is of the greatest use when properly regulated, as it powerfully impels us to relieve their distress; but if by any means become so exquisite as to make us shun the sight of misery, it counteracts the end for which it was implanted in our nature, and only deprives us of happiness, while it constitutes nothing to the good of others. Indeed there is reason to believe that all such extreme sensibilities are selfish affections, employed as apologies for withholding from the miserable that relief which it is in our power to give; for there is not a fact better established in the science of human nature, than that passive perceptions grow gradually weaker by repetition, while active habits daily acquire strength.

It is of great importance to a literary man to cultivate his taste, because, it is the source of much elegant and refined pleasure, (see *TASTE*); but there is a degree of fastidiousness which renders that pleasure impossible to be obtained, and is the certain indication of expiring letters. It is necessary to submit to the artificial rules of politeness, for they tend to promote the peace and harmony of society, and are sometimes a useful substitute for moral virtue; but he who with respect to them has so much sensibility as to be disgusted with all whose manners are not equally polished with his own, is a very troublesome member of society. It is every man's duty to cultivate his moral sensibilities, so as to make them subservient to the purposes for which they were given to him; but if he either feel, or pretend to feel, the miseries of others to so exquisite a degree as to be unable to afford them the relief which they have a right to expect, his sensibilities are of no good tendency.

That the man of true sensibility has more pains and more pleasures than the callous wretch, is universally admitted, as well as that his enjoyments and sufferings are more exquisite in their kinds; and as no man lives for himself alone, no man will acknowledge his want of sensibility, or express a wish that his heart were callous. It is, however, a matter of some moment to distinguish real sensibilities from ridiculous affections; those which tend to increase the sum of human happiness from such as have a contrary tendency; and to cultivate them all in such a manner as to make them answer the ends for which they were implanted in us by the beneficent Author of nature. This can be done only by watching over them as over other affections, (see *METAPHYSICS*, N^o 68.) For excessive sensibility, as it is not the gift of nature, is the bane of human happiness. "Too much tenderness (says Rousseau well observes) proves the bitter-

Sensitive.

est curse instead of the most fruitful blessing; vexation and disappointment are its certain consequences. The temperature of the air, the change of the seasons, the brilliancy of the sun, or thickness of the fogs, are so many moving springs to the unhappy possessor, and he becomes the wanton sport of their arbitration."

SENSITIVE-PLANT. See MIMOSA, DIONEA, and HEDYSARUM, Botany Index

The sensitive plants are well known to possess a kind of motion, by which the leaves and stalks are contracted and fall down on being slightly touched, or shaken with some degree of violence.

The contraction of the leaves and branches of the sensitive plant when touched, is a very singular phenomenon. Different hypotheses have been formed by botanists in order to explain it; but we are disposed to believe that these have generally been deduced rather from analogical reasoning than from a collection of facts and observations. We shall therefore give an account of all the important facts which we have been able to collect upon this curious subject; and then draw such conclusions as obviously result from them, without, however, attempting to support any old, or to establish a new, hypothesis.

1. It is difficult to touch the leaf of a healthy sensitive plant so delicately that it will not immediately collapse, the foliola or little leaves moving at their base till they come into contact, and then applying themselves close together. If the leaf be touched with a little more force, the opposite leaf will exhibit the same appearance. If a little more force be applied, the partial footstalks bend down towards the common footstalk from which they issue, making with it a more acute angle than before. If the touch be more violent still, all the leaves situated on the same side with the one that has been touched will instantly collapse, and the partial footstalk will approach the common footstalk to which it is attached, in the same manner as the partial footstalk of the leaf approaches the stem or branch from which it issues; so that the whole plant, from having its branches extended, will immediately appear like a weeping birch.

2. These motions of the plant are performed by means of three distinct and sensible articulations. The first, that of the foliola or lobes to the partial footstalk; the second, that of the partial footstalk to the common one; the third, that of the common footstalk to the trunk. The primary motion of all which is the closing of the leaf upon the partial footstalk, which is performed in a similar manner, and by a similar articulation. This, however, is much less visible than the others. These motions are wholly independent on one another, as may be proved by experiment. It appears that if the partial footstalks are moved, and collapse toward the petioli, or these toward the trunk, the little leaves, whose motion is usually primary to these, should be affected also; yet experiment proves that it is possible to touch the footstalks in such a manner as to affect them only, and make them apply themselves to the trunk, while the leaves feel nothing of the touch; but this cannot be, unless the footstalks are so disposed as that they can fall to the trunk, without suffering their leaves to touch any part of the plant in their passage, because, if they do, they are immediately affected.

3. Winds and heavy rains make the leaves of the sen-

sitive plant contract and close; but no such effect is seen produced from slight showers.

4. At night, or when exposed to much cold in the day, the leaves meet and close in the same manner as when touched, folding their upper surfaces together, and in part over each other, like scales or tiles, so as to expose as little as possible of the upper surface to the air. The opposite sides of the leaves (foliola) do not come close together in the night, for when touched they apply themselves closer together. Dr Darwin kept a sensitive plant in a dark place for some hours after day-break; the leaves and footstalks were collapsed as in its most profound sleep; and, on exposing it to the light, above 20 minutes passed before it was expanded.

5. In the month of August, a sensitive plant was carried in a pot out of its usual place into a dark cave, the motion that it received in the carriage shut up its leaves, and they did not open till 24 hours afterwards; at this time they became moderately open, but were afterwards subject to no changes at night or morning, but remained three days and nights with their leaves in the same moderately open state. At the end of this time they were brought out again into the air, and there recovered their natural periodical motions, shutting every night, and opening every morning, as naturally and as strongly as if the plant had not been in this forced state; and while in the cave, it was observed to be very little less affected with the touch than when abroad in the open air.

6. The great heats of summer, when there is open sunshine at noon, affect the plant in some degree like cold, causing it to shut up its leaves a little, but never in any very great degree. The plant, however, is least of all affected about nine o'clock in the morning, and that is consequently the properest time to make experiments on it. A branch of the sensitive plant cut off, and laid by, retains yet its property of shutting up and opening in the morning for some days; and it holds it longer if kept with one end in water, than if left to dry more suddenly.

7. The leaves only of the sensitive plant shut up in the night, not the branches; and if it be touched at this time, the branches are affected in the same manner as in the day, shutting up, or approaching to the stalk or trunk, in the same manner, and often with more force. It is of no consequence what the substance is with which the plant is touched, it answers alike to all; but there may be observed a little spot, distinguishable by its paler colour in the articulations of its leaves, where the greatest and nicest sensibility is evidently placed.

8. Duhamel having observed, about the 15th of September, in moderate weather, the natural motion of a branch of a sensitive plant, remarked, that at nine in the morning it formed with the stem an angle of 123 degrees; at noon, 112 degrees; at three afternoon, it returned to 120; and after touching the branch, the angle was reduced to 90. Three quarters of an hour after it had mounted to 112; and, at eight at night, it descended again, without being touched, to 90. The day after, in finer weather, the same branch, at nine in the morning, made an angle of 135 degrees with the stem; after being touched, the angle was diminished to 80; an hour after, it rose again to 135; being touched a second time, it descended again to 80; an hour and a half after, it had risen to 145; and on being

touch a third time, descended to 35; and remained in that position till five o'clock in the afternoon, when being touched a fourth time it fell to 112.

9. The parts of the plants which have collapsed afterwards unfold themselves, and return to their former expanded state. The time required for that purpose varies, according to the season of the plant, the season of the year, the hour of the day, the state of the atmosphere. Sometimes half an hour is requisite, sometimes only ten minutes. The order in which the parts recover themselves varies in like manner: sometimes it is the common footstalk; sometimes the rib to which the leaves are attached; and sometimes the leaves themselves are expanded, before the other parts leave themselves an attempt to be reinstated in their former position.

10. I, without shaking the other smaller leaves, we cut off the half of a leaf or lobe belonging to the last pair, at the extremity or summit of a wing, the leaf cut, and its antagonist, that is to say, the first pair, begin to approach each other; then the second, and so on successively, till all the lesser leaves, or lobes of that wing, have collapsed in like manner. Frequently, after 12 or 15 seconds, the lobes of the other wings, which were not immediately affected by the stroke, shut; whilst the stalk and its wing, beginning at the bottom, and proceeding in order to the top, gradually recover themselves. 11. Instead of one of the lesser extreme leaves, we cut off one belonging to the pair that is next the footstalk, its antagonist shut, as do the other pairs successively, from the bottom to the top. If all the leaves of one side of a wing be cut off, the opposite leaves are not affected, but remain expanded. With some address, it is possible even to cut off a branch without hurting the leaves, or making them fall. The common footstalk of the winged leaves being cut as far as three-fourths of its diameter, all the parts which hang down collapse, but quickly recover without appearing to have suffered any considerable violence by the shock. An incision being made into one of the principal branches to the depth of one half the diameter, the branches situated betwixt the section and the root will fall down; those above the incision remain as before, and the lesser leaves continue open; but this direction is soon destroyed, by cutting off one of the lobes at the extremity, as was observed above. Lastly, a whole wing being cut off with precaution near its insertion into the common footstalk, the other wings are not affected by it, and its own lobes do not shut. No motion ensues from piercing the branch with a needle or other sharp instrument.

11. If the end of one of the leaves be burned with the flame of a candle, or by a burning glass, or by touching it with hot iron, it closes up in a moment, and the opposite leaf does the same, and after that the whole series of leaves on each side of the partial or little footstalk; then the footstalk itself; then the branch or common footstalk; all do the same, if the burning has been in a sufficient degree. This proves that there is a very nice communication between all the parts of the plant, by means of which the burning, which only is applied to the extremity of one leaf, diffuses its influence through every part of the shrub. If a drop of aquafortis be carefully laid upon a leaf of the sensitive plant, so as not to shake it in the least, the leaf does not begin to move till the acid liquor corrods the sub-

stance of it; but at that time, not only that particular leaf, but all the leaves placed on the same footstalk, close themselves up. The vapour of burning sulphur has also this effect on many leaves at once, according as they are more or less exposed to it; but a bottle of very acid and sulphurous spirit of vitriol, placed under the branches unstoppered, produces no such effect. Wetting the leaves with spirit of wine has been observed also to have no effect, nor the rubbing oil of almonds over them; though this last application destroys many plants.

From the preceding experiments the following conclusions may be fairly drawn: 1. The contraction of the parts of the sensitive plant is occasioned by an external force, and the contraction is in proportion to the force. 2. All bodies which can exert any force affect the sensitive plant; some by the touch or by agitation, as the wind, rain, &c.; some by chemical influence, as heat and cold. 3. Touching or agitating the plant produces a greater effect than an incision or cutting off a part, or by applying heat or cold.

Attempts have been made to explain these curious phenomena. Dr Darwin, in the notes to his admired poem, entitled, *The Botanic Garden*, lays it down as a principle, that "the sleep of animals consists in a suspension of voluntary motion; and as vegetables are subject to sleep as well as animals, there is reason to conclude (says he) that the various action of closing their petals and foliage may be justly ascribed to a voluntary power; for without the faculty of volition sleep would not have been necessary to them." Whether this definition of sleep when applied to animals be just, we shall not inquire; but it is evident the supposed analogy between the sleep of animals and the sleep of plants has led Dr Darwin to admit this astonishing conclusion, that plants have volition. As volition presupposes a mind or soul, it were to be wished that he had given us some information concerning the nature of a vegetable soul, which can think and will. We suspect, however, that this vegetable soul will turn out to be a mere mechanical or chemical one; for it is affected by external forces uniformly in the same way, its volition is merely passive, and never makes any successful resistance against those causes by which it is influenced. All this is a mere abuse of words. The sleep of plants is a metaphorical expression, and has not the least resemblance to the sleep of animals. Plants are said to sleep when the flowers or leaves are contracted or folded together; but we never heard that there is any similar contraction in the body of an animal during sleep.

The fibres of vegetables have been compared with the muscles of animals, and the motions of the sensitive plant have been supposed the same with muscular motion. Between the fibres of vegetables and the muscles of animals, however, there is not the least similarity. If muscles be cut through, so as to be separated from the joints to which they are attached, their powers are completely destroyed; but this is not the case with vegetable fibres. The following very ingenious experiment, which was communicated to us by a respectable member of the University of Edinburgh, is decisive on this subject. He selected a growing poppy at that period of its growth, before unfolding, when the head and neck are bent down almost double. He cut the stalk where it was curved half through on the under side, and half through

Sentence. through at a small distance on the upper face, and half through in the middle point between the two sections, so that the ends of the fibres were separated from the stalk. Notwithstanding these several cuttings on the neck, the poppy raised its head, and assumed a more erect position. There is, therefore, a complete distinction between muscular motion and the motions of a plant, for no motion can take place in the limb of an animal when the muscles of that limb are cut.

In fine, we look upon all attempts to explain the motions of plants as absurd, and all reasoning from supposed analogy between animals and vegetables as the source of wild conjecture, and not of sound philosophy. We view the contraction and expansion of the sensitive plant in the same light as we do gravitation, chemical attraction, electricity, and magnetism, as a singular fact, the circumstances of which we may be fully acquainted with, but must despair of understanding its cause.

What has been said under this article chiefly refers to the *Mimosa sensitiva* and *pedicula*. For a full account of the motions of vegetables in general, see *Vegetable Motion*, under the article **MOTION**.

SENTENCE, in *Law*, a judgment passed in court by the judge in some process, either civil or criminal. See **JUDGEMENT**.

SENTENCE, in *Grammar*, denotes a period, or a set of words comprehending some perfect sense or sentiment of the mind. The business of pointing is to distinguish the several parts and members of sentences, so as to render the sense thereof as clear, distinct, and full as possible. See **PUNCTUATION**.

In every sentence there are two parts necessarily required; a noun for the subject, and a definite verb: whatever is found more than these two, affects one of them, either immediately, or by the intervention of some other, whereby the first is affected.

Again, every sentence is either simple or compound: a simple sentence is that consisting of one single subject, and one finite verb.—A compound sentence contains several subjects and finite verbs, either expressly or implicitly.

A simple sentence needs no point or distinction; only a period to close it: as, "A good man loves virtue for itself."—In such a sentence, the several adjuncts affect either the subject or the verb in a different manner. Thus the word *good* expresses the quality of the subject, *virtue* the object of the action, and *for itself* the end thereof.—Now none of these adjuncts can be separated from the rest of the sentence: for if one be, why should not all the rest? and if all be, the sentence will be minced into almost as many parts as there are words.

But if several adjuncts be attributed in the same manner either to the subject or the verb, the sentence becomes compound, and is to be divided into parts.

In every compound sentence, as many subjects, or as many finite verbs as there are, either expressly or implied, so many distinctions may there be. Thus, "My hopes, fears, joys, pains, all centre in you." And thus *Catiline abiit, excessit, exivit, erasit*.—The reason of which pointing is obvious; for as many subjects or finite verbs as there are in a sentence, so many members does it really contain. Whenever, therefore, there occur more nouns than verbs, or contrariwise, they are to be conceived as equal. Since, as every subject re-

quires its verbs, so every verb requires its objects, with it may agree: excepting, perhaps, the usual figurative expressions.

SENTICOSÆ (from *sentis*, a "brain or intellect") is the name of the 35th order in Linnæus's System of a natural method, consisting of rose, brounle, and other plants, which resemble them in part and external structure. See *BOTANY, Natural Method*.

SENTIMENT, according to Lord James, is a notion appropriated to such thoughts as are prompted by reflection. It differs from a perception; for a perception implies the act by which we become conscious of external objects. It differs from consciousness of an internal action, such as thinking, suspending thought, inclining, resolving, willing, &c. And it differs from the conception of a relation among objects; a conception of that kind being termed *opinion*.

SENTIMENTS, in *Poetry*. To talk in the language of music, each passion has a certain tone, to which every sentiment proceeding from it ought to be tuned with the greatest accuracy; which is no easy work, especially where such harmony ought to be supported during the course of a long theatrical representation. In order to teach such delicacy of execution, it is necessary that a writer assume the precise character and passion of the personage represented; which requires an uncommon genius. But it is the only difficulty for the writer, who, annihilating himself, can thus become another person, need be in no pain about the sentiments that belong to the assumed character: these will flow without the least study, or even pre-conception, and will frequently be as delightfully new to himself as to his reader. But if a lively picture even of a single emotion require an effort of genius, how much more will the effort to compose a passionate dialogue with a man of different tones of passion as there are speakers? With what ductility of feeling must that writer be endued, who approaches perfect in such a work; when it is necessary to assume different and even opposite characters and passions in the quickest succession? Yet this work, difficult as it is, yields to that of composing a dialogue in genteel comedy, exhibiting characters without passion. The reason is, that the different tones of character are more delicate, and less in sight, than those of passion; and, accordingly, many writers, who have a genius for drawing characters, make a short stay in present, tolerably well, an ordinary passion in its simple movements. But of all works of this kind, what is truly the most difficult, is a characteristical dialogue upon any philosophical subject; to interweave characters with reasoning, by suiting to the character of each speaker a peculiarity not only of thought but of expression, requires the perfection of genius, taste, and judgment.

How difficult dialogue-writing is, will be evident, even without reasoning, from the miserable copy-takers of that kind found without number in all languages. The art of mimicking any singularity in gesture or voice, is a rare talent, though directed by sight and hearing; the accurate and most lively of our external senses show much more rare than that of imitating the characters and internal emotions, tracing all their different tints, and representing them in a lively manner by natural sentiments properly expressed. The truth is, such execution is too delicate for an ordinary genius.

Sentiments and for that reason the bulk of writers, instead of expressing a passion as one does who feels it, content themselves with describing it in the language of a spectator. To awake passion by an internal effort merely, without any external cause, requires great sensibility; and yet that operation is necessary, not less to the writer than to the actor; because none but those who actually feel a passion can represent it to the life. The writer's part is the more complicated: he must add composition to passion: and must, in the quickest succession, adopt every different character. But a very humble flight of imagination may serve to convert a writer into a spectator, so as to figure, in some obscure manner, an action as passing in his sight and hearing. In that figured situation, being led naturally to write like a spectator, he entertains his readers with his own reflections, with cool description, and florid declamation; instead of making them eye-witnesses, as it were, to a real event, and to every movement of genuine passion. Thus most of our plays appear to be cast in the same mould; personages without character, the mere outlines of passion, a tiresome monotony, and a pompous declamatory style.

This descriptive manner of representing passion is a very cold entertainment; our sympathy is not raised by description; we must still be lulled into a dream of reality, and every thing must appear as passing in our sight. Unhappy is the player of genius who acts a part in what may be termed a *descriptive tragedy*; after assuming the very passion that is to be represented, how is he cramped in action, when he must utter, not the sentiments of the passion he feels, but a cold description in the language of a bystander? It is that imperfection, undoubtedly, in the bulk of our plays, which confines our stage almost entirely to Shakespeare, notwithstanding his many irregularities. In our late English tragedies, we sometimes find sentiments tolerably well adapted to a plain passion: but we must not in any of them expect a sentiment expressive of character: and, upon that very account, our late performances of the dramatic kind are for the most part intolerably insipid.

But it may be proper to illustrate this subject by examples. The first examples shall be of sentiments that appear the legitimate offspring of passion; to which shall be opposed what are descriptive only, and illegitimate; and in making this comparison, the instances shall be borrowed from Shakespeare and Corneille, who for genius in dramatic composition stand uppermost in the rolls of fame.

I. Shakespeare shall furnish the first example, being of sentiments dictated by a violent and perturbed passion:

Lear. ————— Filial ingratitude!

Is it not as if this mouth should tear this hand
For lifting food to't? — But I'll punish home;
No, I will weep no more. — In such a night,
To shut me out! — Pour on, I will endure.
In such a night as this! O Regan, Gonerill,
Your old kind father, whose frank heart gave all —
O! that way madness lies; let me shun that;
No more of that.

Kent. Good, my lord, enter here.

Lear. Prithce, go in thyself, seek thine own ease,

This tempest will not give me leave to ponder
On things would hurt me more: — but I'll go in;
In, boy, go fill. You houseleeks poverty —
Nay, get thee in; I'll pray, and then I'll sleep —
Poor naked wretches, where'er you are,
That bid the pelting of this pitiless storm,
How shall your houseleeks heads, and unfed sides,
Your loop'd and window'd raggedness, defend you
From seasons such as these! — O I have ta'en
Too little care of this! take physic, Pomp;
Expose thyself to feel what wretches feel,
That thou may'st shake the superfluous to them,
And show the heavens more just.

King Lear, act iii. sc. 5.

With regard to the French author, truth obliges us to acknowledge, that he describes in the style of a spectator, instead of expressing passion like one who feels it; which naturally betrays him into a tiresome monotony, and a pompous declamatory style. It is scarcely necessary to give examples, for he never varies from that tone. We shall, however, take two passages at a venture, in order to be confronted with those translated above. In the tragedy of *Cléopâtre*, after the conspiracy was discovered, *Æmilie*, having nothing in view but racks and death to herself and her lover, receives a pardon from Augustus, attended with the brightest circumstances of magnanimity and tenderness. This is a lucky situation for representing the passions of surprise and gratitude in their different stages, which seem naturally to be what follow. These passions, raised at once to the utmost pitch, and being at first too big for utterance, must, for some moments, be expressed by violent gestures only: so soon as there is vent for words, the first expressions are broken and interrupted: at last, we ought to expect a tide of intermingled sentiments, occasioned by the fluctuation of the mind between the two passions. *Æmilie* is made to behave in a very different manner: with extreme coolness she describes her own situation, as if she were merely a spectator; or rather the poet takes the talk off her hands:

Et je me rends, Seigneur, à ces hautes bontés:
Je recouvre la vue auprès de leurs clartés.
Je connois mon forfait qui me sembloit justice;
Et ce que n'avoit pu la terreur du supplice,
Je sens naître en mon âme un repentir puissant,
Et mon cœur en secret me dit, qu'il y consent.
Le ciel a résolu votre grandeur suprême;
Et pour preuve, Seigneur, je n'en veux que moi-même.
J'ose avec vanité me donner cet éclat,
Puisqu'il change mon cœur, qu'il veut changer l'état.
Ma haine va mourir, que j'ai crue immortelle;
Elle est morte, et ce cœur devient sujet fidèle;
Et prenant désormais cette haine en horreur,
L'ardeur de vous servir succède à sa fureur.

Act v. sc. 3.

So much in general on the genuine sentiments of passion. We proceed to particular observations. And, first, passions seldom continue uniform any considerable time: they generally fluctuate, swelling and subsiding by turns, often in a quick succession; and the sentiments cannot be just unless they correspond to such fluctuation. Accordingly, a climax never shows better than in expressing a swelling passion: the following passages may suffice for an illustration.

Almeria.

Almeria. — How hast thou charm'd
The wildness of the waves and rocks to this;
That thus relenting they have giv'n thee back
To earth, to light and life, to love and me?

Mourning Bride, act i. sc. 7.

I would not be the villain that thou think'st
For the whole space that's in the tyrant's grasp,
And the rich earth to boot.

Macbeth, act iv. sc. 4.

The following passage expresses finely the progress of conviction.

Let me not stir, nor breathe, lest I dissolve
That tender, lovely form, of painted air,
So like Almeria. Ha! it sinks, it falls;
I'll catch it e'er it goes, and grasp her shade.
'Tis life! 'tis warm! 'tis the! 'tis the herself!
It is Almeria! 'tis, it is my wife!

Mourning Bride, act ii. sc. 6.

In the progress of thought our resolutions become more vigorous as well as our passions.

If ever I do yield or give consent,
By any action, word, or thought, to wed
Another lord; may then just heav'n show'r down, &c.

Mourning Bride, act i. sc. 1.

And this leads to a second observation, That the different stages of a passion, and its different directions, from birth to extinction, must be carefully represented in their order; because otherwise the sentiments, by being misplaced, will appear forced and unnatural.—
Resentment, for example, when provoked by an atrocious injury, discharges itself first upon the author: sentiments therefore of revenge come always first, and must in some measure be exhausted before the person injured think of grieving for himself. In the *Cid* of Corneille, Don Diegue having been affronted in a cruel manner, expresses scarcely any sentiment of revenge, but is totally occupied in contemplating the low situation to which he is reduced by the affront:

O rage! ô desespoir! ô vieillisse ennemie!
N'ai-je donc tant veu que pour cette infamie?
Et ne suis-je blanchi dans les travaux guerriers,
Que pour voir en un jour flétrit tant de lauriers?
Mon bras, qu'avec respect tout l'Espagne admire,
Mon bras qui tant de fois a sauvé cet empire,
Tant de fois affermi le trône de son roi,
Trahit donc ma querelle, et ne fait rien pour moi!
O cruel souvenir de ma gloire passé!
Oeuvre de tant de jours en un jour effacé!
Nouvelle dignité fatale à mon bonheur!
Precipice élevé d'où tombe mon honneur!
Faut-il de votre éclat voir triompher le comte,
Et mourir sans vengeance, ou vivre dans la honte?
Comte, sois de mon prince à présent gouverneur,
Ce haut rang n'admet point un homme sans honneur;
Et ton jaloux orgueil par cet affront insigne,
Malgré le choix du roi, m'en a su rendre indigne.
Et toi, de mes exploits glorieux instrument,
Mais d'un corps tout de glace inutile ornement,
Fer jadis tant à craindre, et qui dans cette offense,
M'as servi de parade, et non pas de défense,

Va, quitte désormais le dernier des humains,
Passe pour me venger en de meilleures mains.

Le Cid, act i. sc. 7.

These sentiments are certainly not the first that are suggested by the passion of resentment. As the first movements of resentment are always directed to its object, the very same is the case of grief. Yet with relation to the sudden and severe displeasure that seized Alexander bathing in the river Cydnus, Quintus Curtius describes the first emotions of the army as directed to themselves, lamenting that they were left without a leader, far from home, and had scarce any hopes of returning in safety: their king's distress, which must naturally have been their first concern, occupies them but in the second place according to that author. In the *Aminta* of Tasso, Sylvia, upon a report of her lover's death, which she believed certain, instead of bemoaning the loss of her beloved, turns her thoughts upon herself, and wonders her heart does not break:

Oime, ben son di fallo,
Poi che questa novella non m'uccide.

Act iv. sc. 2.

In the tragedy of *Jane Shore*, Alicia, in the full purpose of destroying her rival, has the following reflection:

Oh Jealousy! thou bane of pleasing friendship,
Thou worst invader of our tender bosoms;
How does thy rancour poison all our softness,
And turn our gentle nature into bitterness!
See where she comes! Once my heart's dearest blessing,
Now my chang'd eyes are blis'd with her beauty,
Loathe that known face, and sicken to behold her.

Act iii. sc. 1.

These are the reflections of a cool spectator. A passion, while it has the ascendant, and is freely indulged, suggests not to the person who feels it any sentiment to its own prejudice: reflections like the foregoing occur not readily till the passion has spent its vigour.

A person sometimes is agitated at once by different passions; and the mind in that case, vibrating like a pendulum, vents itself in sentiments that partake of the same vibration. This we give as a third observation:

Queen. Would I had never trod this English earth,
Or felt the flatteries that grow upon it!
Ye've angels faces, but heav'n knows your hearts.
What shall become of me now? wretched lady!
I am the most unhappy woman living.
Alas! poor wenches, where are now your fortunes?

[*To her women.*]

Shipwreck'd upon a kingdom, where no pity,
No friends, no hope, no kindred, weep for me:
Almoit no grave allow'd me.

Henry VIII. act iii. sc. 1.

Othello. Oh devil, devil!
If that the earth could teem with woman's tears,
Each drop the falls would prove a crocodile.
Out of my sight!

Desdemona. I will not stay t'offend you. [*Going.*]
Lodovico. Truly, an obedient lady:
I do beseech your lordship, call her back.

Oth. Mistress—

Des. My lord.

Ob. What would you wish her, Sir?

Lord. Who, I, my lord?

Ob. Ay; you did wish that I would make her turn, Sir, she can turn and turn, and yet go on; And turn again. And she can weep, Sir, weep; And she's obedient: as you say, obedient: Very obedient—proceed you in your tears— Concerning this, Sir,—oh well painted passion!— I am commanded home—get you away, I'll send for you anon—Sir, I obey the mandate, And will return to Venice.—Hence, avaunt!

[Exit Desdemona.

Othello, act iv. sc. 6.

Æmilia. Oh! my good lord, I would speak a word with you.

Othello. Yes, 'tis *Æmilia*—By and by.—She's dead.

'Tis like she comes to speak of Cassio's death; The noise was high.—Ha! no more moving? Still as the grave. Shall she come in? we'll go? I think she'lls again—No—what's the best? If she come in, she'll, fare, speak to my wife: My wife! my wife! what wife? I have no wife; Oh insupportable! oh heavy hour!

Othello, act v. sc. 7.

A fourth observation is, That nature, which gave us passions, and made them extremely beneficial when moderate, intended undoubtedly that they should be subjected to the government of reason and conscience. It is therefore against the order of nature, that passion in any case should take the lead in contradiction to reason and conscience: such a state of mind is a sort of anarchy which every one is ashamed of and endeavours to hide or dissemble. Even love, however laudable, is attended with a conscious shame when it becomes immoderate: it is covered from the world, and disclosed only to the beloved object:

Et que l'amour souvent de remors combattu

Paraisse une faiblesse, et non une vertu.

BOILEAU, *P. Art. Poet.* chant. iii. l. 101.

O, they love least that let men know they love.

Two Gentlemen of Verona, act i. sc. 3.

Hence a capital rule in the representation of immoderate passions, that they ought to be hid or dissembled as much as possible. And this holds in an especial manner with respect to criminal passions: one never counsels the commission of a crime in plain terms; guilt must not appear in its native colours, even in thought; the proposal must be made by hints, and by representing the action in some favourable light. Of the propriety of sentiment upon such an occasion, Shakspeare, in the *Tempest*, has given us a beautiful example, in a speech by the usurping duke of Milan, advising Sebastian to murder his brother the king of Naples:

Antonis.—What might,

Worthy Sebastian,—O, what might—no more.

And yet, methinks, I see it in thy face

What thou shouldst be: the occasion speaks thee, and

My strong imagination sees a crown

Dropping upon thy head.

Act ii. sc. 2.

A picture of this kind, perhaps still finer, is exhibited

in *King John*, where that tyrant solicits (act iii. sc. 5.) *Sentiments* Hubert to murder the young prince Arthur; but it is too long to be inserted here.

II. As things are best illustrated by their contraries, we proceed to faulty sentiments, declining to be indebted, for examples to any but the most approved authors. The first class shall consist of sentiments that accord not with the passion; or, in other words, sentiments that the passion does not naturally suggest. In the second class shall be ranged sentiments that may belong to an ordinary passion, but unsuitable to it as tinctured by a singular character. Thoughts that properly are not sentiments, but rather decorations, make a third. Sentiments that belong to the passion repeated, but are faulty as being introduced too early or too late, make a fourth. Vicious sentiments exposed in their native dress, instead of being concealed or disguised, make a fifth. And in the last class shall be collected sentiments suited to no character nor passion, and therefore unnatural.

The *first* class contains faulty sentiments of various kinds, which we shall endeavour to distinguish from each other.

1. Of sentiments that are faulty by being above the tone of the passion, the following may serve as an example:

Othello.—O my soul's joy!

If after every tempest come such calms,

May the winds blow till they have waken'd death:

And let the labouring bark climb hills of seas

Olympus high, and duck again as low

As hell's from heaven? *Othello*, act ii. sc. 6.

This sentiment may be suggested by violent and inflamed passion; but is not suited to the satisfaction, however great, that one feels upon escaping danger.

2. Instance of sentiments below the tone of the passion. Ptolemy, by putting Pompey to death, having incurred the displeasure of Cæsar, was in the utmost dread of being dethroned: in that agitating situation, Cornelle makes him utter a speech full of cool reflection, that is in no degree expressive of the passion.

Ah! si je t'avois crû, je n'aurois pas de maître,

Je serois dans le trône où le ciel m'a fait naître;

Mais c'est une imprudence assez commune aux rois;

D'écouter trop d'avis, et se tromper au choix.

Le Destin les aveugle au bord du précipice,

Où si quelque lenienc en leur ame se glisse,

Cette fausseté dont il les ebloût,

Le plonge dans une gouffre, et puis s'évanouit.

La Mort de Pompée, act iv. sc. 1.

3. Sentiments that agree not with the tone of the passion: as where a pleasant sentiment is grafted upon a painful passion, or the contrary. In the following instances, the sentiments are too gay for a serious passion:

No happier task these faded eyes pursue;

To read and weep is all they now can do.

Elisba to Abalar, l. 177.

Again;

Itav'n first taught letters for some wretch's aid,

Some banish'd lover, or some captive maid:

They

They live, they speak, they breathe what love inspires,
Warm from the soul, and faithful to its fires;
The virgin's wish without her fons impart,
Excuse the blush, and pour out all the heart;
Speed the soft intercourse from soul to soul,
And waite a sigh from Indus to the pole.

India to Belshazzar, l. 51.

These thoughts are pretty: they suit Pope, but not Eliza.

Satan, enraged by a threatening of the angel Gabriel, answers thus:

Then when I am thy captive, talk of chains,
Proud liminary cherub; but ere thou
Far heavier load thyself expect to see!
From my prevailing arm, though heaven's King
Ride on thy wings, and thou with thy competitors,
Tied to the yoke, draw'st his triumphant wheels
In progress thro' the road of heav'n's starry'd.

Paradise Lost, book IV.

The concluding epithet forms a grand and delightful image, which cannot be the genuine offspring of rage.

4. Sentiments too artificial for a serious passion. The first example is a speech of Percy expiring.

O, Harry, thou hast robb'd me of my growth:
I better brook the loss of brittle life,
Than those proud titles thou hast won of me:
They wound my thoughts worse than thy sword my flesh.

But thought's the slave of life, and life time's fool;
And time, that takes survey of all the world,
Must have a stop.

First Part, Henry IV. act v. sc. 9.

The sentiments of the *Mourning Bride* are for the most part no less delicate than just copies of nature: in the following exception the picture is beautiful, but too artificial to be suggested by severe grief.

Almeria. O no! Time gives increase to my afflictions.

The circling hours, that gather all the woes
Which are diffus'd through the revolving year,
Come heavy laden with th' oppressive weight
To me; with me, successively, they leave
The sighs, the tears, the groans, the restless cares,
And all the damps of grief, that did retard their flight;
They shake their downy wings, and scatter all
The dews collected dews on my poor head:
Then fly with joy and sweetness from me. Act i. sc. 1.

In the same play, Almeria seeing a dead body, which she took to be Alphonso's, expresses sentiments strained and artificial, which nature suggests not to any person upon such an occasion:

Had they or hearts or eyes, that did this deed?
Could eyes endure to guide such cruel hands?
Are not my eyes guilty alike with theirs,
That thus can gaze, and yet not turn to stone?
— I do not weep! The fixings of tears are dry'd,
And of a sudden I am calm, as if
All things were well; and yet my husband's mur-
der'd!

Yes, yes, I know it is mine: I'll die by this heart,
The source of woe, and let the torrent run.

Act v. sc. 11.

Pope's elegy to the memory of an unfortunate lady, expresses delicately the most tender concern and sorrow that one can feel for the deplorable fate of a person of worth. Such a poem, deeply serious and pathetic, rejects with disdain all fiction. Upon that account, the following passage deserves no quarter; for it is not the language of the heart, but of the imagination indulging its flights at ease, and by that means is eminently discordant with the subject. It would be a still more severe censure, if it should be ascribed to imitation, copying indifferently what has been said by others:

What though no weeping loves thy ashes grace,
Nor polish'd marble emulate thy face?
What though no sacred earth allow thee room,
Nor hollow'd dirge be mutter'd o'er thy tomb?
Yet shall thy grave with rising dews be drest,
And the green turf lie lightly on thy breast:
There shall the morn her earliest tears bestow,
There the first roses of the year shall blow;
While angels with their silv'ry wings enthused
The ground, now sacred by thy relics made.

5. Fanciful or finical sentiments. Sentiments that degenerate into point or conceit, however they may amuse in an idle hour, can never be the offspring of any serious or important passion. In the *Jerusalem of Salo*, Tancred, after a single combat, spent with fatigue and loss of blood, falls into a swoon; in which situation, understood to be dead, he is discovered by Erminia, who was in love with him to distraction. A more happy situation cannot be imagined, to raise grief in an instant to its highest pitch; and yet, in venting her sorrow, the descends most abominably into antithesis and conceit even of the lowest kind:

E in lui versò d'ineffabile vena
Lacrime, e voce di sospir mista.
In che misero punto hor qui me mena
Fortuna? a che veduta amara e trista?
Dopo gran tempo! ti ritrovo? pena
Tancredi, e ti riveggio, e non fon vilita
Vilita non fon da te, benchè presente
Ti trovando ti perdo eternamente.

Canto xiv. st. 122.

Armida's lamentation respecting her lover Rinaldo is in the same vicious taste. *Vid.* canto xx. Stan. 121, 122, 125.

Queen. Give me no help in lamentation,
I am not barren to bring forth complaints.
All springs reduce their currents to mine eyes,
That I, being govern'd by the wat'ry moon,
May send forth plentiful tears to drown the world,
Ah, for my husband, for my dear lord Edward.

King Richard III. act ii. sc. 5.

Lucy Shore utters her last breath in a witty conceit:

Then all is well, and I shall sleep in peace—
'Tis very dark, and I have lost you now—
Was there not something I would have I sweat?

But I have nothing left me to bestow,
Nothing but one sad sigh. Oh mercy, Heav'n! [*Dies.*
Act v.

Font infensiblement à mon inimitié
Succeder—Je serois sensible à la pitié?
Athalie, act ii. sc. 7.

Guilford to Lady Jane Gray, when both were condemn'd to die:

Thou stand'st unmov'd;
Calm temper fits upon thy beauteous brow;
Thy eyes that flow'd so fast for Edward's loss,
Gaze unconcern'd upon the ruin round thee,
As if thou had'st resolv'd to brave thy fate,
And triumph in the midst of desolation.
Ha! see, it swells, the liquid crystal rises,
It starts in spite of thee—but I will catch it,
Nor let the earth be wet with dew so rich.

Lady Jane Gray, act iv. near the end.

The concluding sentiment is altogether finical, unsuitable to the importance of the occasion, and even to the dignity of the passion of love.

Cornelle, in his *Examen of the Cid*, answering an objection, That his sentiments are sometimes too much refined for persons in deep distress, observes, that if poets did not indulge sentiments more ingenious or refined than are prompted by passion, their performances would often be low, and extreme grief would never suggest but exclamations merely. This is in plain language to assert, that forced thoughts are more agreeable than those that are natural, and ought to be preferred.

The second class is of sentiments that may belong to an ordinary passion, but are not perfectly concordant with it, as insinuated by a singular character.

In the last act of that excellent comedy *The Careless Husband*, Lady Easy, upon Sir Charles's reformation, is made to express more violent and turbulent sentiments of joy than are consistent with the mildness of her character.

Lady Easy. O the soft treasure! O the dear reward of long-desiring love.—Thus! thus to have you mine, is something more than happiness; 'tis double life, and madness of abounding joy.

The following instances are descriptions rather than sentiments, which compose a third class.

Of this descriptive manner of painting the passions, there is in the *Hippolytus* of Euripides, act v. an illustrious instance, viz. the speech of Theseus, upon hearing of his son's dismal exit. In Racine's tragedy of *Esther*, the queen hearing of the decree issued against her people, instead of expressing sentiments suitable to the occasion, turns her attention upon herself, and describes with accuracy her own situation.

Juilte ciel! tout mon sang dans mes veines se glace.
Act i. sc. 3.

Again,

Aman. C'en est fait. Mon orgueil est forcé de plier.
L'Inexorable Amen est réduit à prier.

Esther, act iii. sc. 5.

Athalie. Quel prodige nouveau me trouble et m'embarrasse?

La douceur de sa voix, son enfance, sa grace,

Titus. O de ma passion fureur déseperée!
Brutus of Voltaire, act iii. sc. 6.

What other are the foregoing instances but describing the passion another feels?

The fourth class is of sentiments expressed too early or too late.

Some examples mentioned above belong to this class. Add the following from *Venice Preserv'd*, act v. at the close of the scene between Belvidera and her father Priuli. The account given by Belvidera of the danger she was in, and of her husband's threatening to murder her, ought naturally to have alarmed her relenting father, and to have made him express the most perturbed sentiments. Instead of which, he dissolves into tenderness and love for his daughter, as if he had already delivered her from danger, and as if there were a perfect tranquillity:

Canst thou forgive me all my follies past!
I'll henceforth be indeed a father; never,
Never more thus expose, but cherish thee,
Dear as the vital warmth that feeds my life,
Dear as those eyes that weep in fondness o'er thee:
Peace to thy heart.

Immoral sentiments exposed in their native colours, instead of being concealed or disguised, compose the fifth class.

The Lady Macbeth, projecting the death of the king, has the following soliloquy:

———The raven himself's not hoarse
That croaks the fatal entrance of Duncan
Under my battlements. Come, all you spirits
That tend on mortal thoughts, unsex me here,
And fill me from the crown to the toe, top full
Of direst cruelty; make thick my blood,
Stop up th' access and passage to remorse,
That no compunctious visitings of nature
Shake my fell purpose. *Macbeth*, act i. sc. 7.

This speech is not natural. A treacherous murder was never perpetrated even by the most hardened miscreant without compunction: and that the lady here must have been in horrible agitation, appears from her invoking the infernal spirits to fill her with cruelty, and to stop up all avenues to remorse. But in that state of mind it is a never-failing artifice of self-deceit to draw the thickest veil over the wicked action, and to extenuate it by all the circumstances that imagination can suggest: and if the crime cannot bear disguise, the next attempt is to thrust it out of mind altogether, and to rush on to action without thought. This last was the husband's method.

Strange things I have in head, that will to hand;
Which must be acted ere they must be scann'd.

Act iii. sc. 5.

The lady follows neither of these courses, but in a deliberate manner endeavours to fortify her heart in the commission of an execrable crime, without even attempting to colour it. This, we think, is not natural; we hope

Sentiments hope there is no such wretch to be found as is here re-
presented.

The *last* class comprehends sentiments that are unna-
tural, as being suited to no character nor passion. These
may be subdivided into three branches: first, sentiments
unsuitable to the constitution of man, and to the laws of
his nature; second, inconsistent sentiments; third, senti-
ments that are pure rant and extravagance.

When the fable is of human affairs, every event, every
incident, and every circumstance, ought to be natu-
ral, otherwise the imitation is imperfect. But an im-
perfect imitation is a venial fault, compared with that
of running crofs to nature. In the *Hippolytus* of Euripides
(act iv. sc. 5.), Hippolytus, wishing for another
self in his own situation, "How much (says he) would
I be touch'd with his misfortune!" as if it were natural
to grieve more for the misfortune of another than for
one's own.

Olymp. Yet I behold her—yet—and now no more.
Turn your lights inward, eyes, and view my thoughts;
So shall you still behold her—'twill not be.
O impotence of sight! mechanic sense
Which to exterior objects ow'll thy faculty,
Not seeing of election, but necessity.
Thus do our eyes, as do all common mirrors,
Successively reflect succeeding images.
Nor what they would, but must; as star or toad;
Just as the hand of chance administrators!

Mourning Bride, act ii. sc. 8.

No man in his senses, ever thought of applying his
eyes to discover what passes in his mind; far less of bla-
ming his eyes for not seeing a thought or idea. In Mo-
liere's *P. Avare* (act iv. sc. 7.) Harpagon, being robbed
of his money, seizes himself by the arm, mistaking it
for that of the robber. And again he expresses himself
as follows:

Je veux aller querir la justice, et faire donner la ques-
tion à toute ma maison; à servantes, à valets, à fils, à
sille, et à moi aussi.

This is so absurd as scarcely to provoke a smile, if it
be not at the author.

Of the second branch the following example may
suffice:

Now bid me run,
And I will strive with things impossible,
Yes, get the better of them.
Julius Cæsar, act ii. sc. 3.

Of the third branch, take the following fables. Lu-
can, talking of Pompey's sepulchre,

Romanum nomen, et omne
Imperium magno est tumuli modus. Obrue fixa
Crimine plena deum. Si tota est Herculis Oete,
Et juga tota vacant Bromio Nyctea; quare
Unus in Egypto Magno lapis? Omnia Lagi
Rura tenere poterit, si nullo cespite nomen
Hæserit. Irremus populi, cinerumque tuorum,
Magne, metu nullas Nili calcesum arena.

Lib. viii. l. 723.

Thus, in Rowe's translation:

Where there are seas, or air, or earth, or skies,
Where'er Rome's empire stretches, Pompey lies.
VOL. XIX. Part I.

Far be the vile memorial then convey'd!
Nor let this stone the partial gods upbraid.
Shall Hercules all Oeta's heights demand,
And Nyctea's hill for Bacchus only stand;
While one poor pebble is the warrior's doom
That fought the cause of liberty and Rome?
If Fate decrees he must in Egypt lie,
Let the whole fertile realm his grave supply,
Yield the wide country to his awful shade,
Nor let us dare on any part to tread,
Fearful we violate the mighty dead.

The following passages are pure rant. Coriolanus,
speaking to his mother,

What is this?
Your knees to me? to your corrected son?
Then let the pebbles on the hungry beach
Fillop the stars: then let the mutinous winds
Strike the proud cedars 'gainst the fiery sun:
Murdring impossibility, to make
What cannot be, slight work.

Coriolanus, act i. sc. 3.

Cæsar. — Danger knows full well,
That Cæsar is more dangerous than he.
We were two lions litter'd in one day,
And I the elder and more terrible.

Julius Cæsar, act ii. sc. 4.

Ventidius. But you, ere love misled your wand'ring
eyes,

Were sure the chief and best of human race,
Fram'd in the very pride and boast of nature,
So perfect, that the gods who form'd you wonder'd
At their own skill, and cry'd, A lucky hit
Has mendred our design. *DRYDEN, All for Love*, act i.
Not to talk of the impiety of this sentiment, it is ludi-
crous instead of being lofty.

The famous epitaph on Raphael is not less absurd than
any of the foregoing passages:

Raphael, timuit, quo sospite, vinci,
Rerum magna parens, et moriente mori.

Imitated by Pope, in his epitaph on Sir Godfrey Knell-
ler:

Living, great Nature fear'd he might outvie
Her works; and dying, fears herself may die.

Such is the force of imitation; for Pope of himself
would never have been guilty of a thought so extrava-
gant.

SENTINEL, or **SENTRY**, in military affairs, a
private soldier placed in some post to watch the ap-
proach of the enemy, to prevent surprises, to stop such
as would pass without orders or discovering who they
are. They are placed before the arms of all guards,
at the tents and doors of general officers, colonels of
regiments, &c.

SENTINEL Perdu, a soldier posted near an enemy, or
in some very dangerous post where he is in hazard of
being lost.

All sentinels are to be vigilant on their post: if they
are they to sing, smoke tobacco, nor suffer any noise to
be made near them. They are to have a watchful eye
over the things committed to their charge. They are
not to suffer any light to remain, or any fire to be
made,

made, near their posts in the night-time; neither is any sentry to be relieved or removed from his post but by the corporal of the guard. They are not to suffer any one to touch or handle their arms, or in the night time to come within ten yards of their post.

No person is to strike or abuse a sentry on his post; but when he has committed a crime, he is to be relieved, and then punished according to the rules and articles of war.

A sentry, on his post in the night, is to know nobody but by the counter-sign; when he challenges, and is answered, *Recog. he calls out, Stand, rō. I. advance, corp. all up*; which the corporal bids his men, and all kneel down within a yard of the sentry's fire-lock (but ordering his party to rest, on which the sentry draws the lance), and gives him the counter-sign, taking care that no one hear it.

SEPIA, the CUTTLE-FISH, a genus of animals belonging to the class of VERMES. See HELMINTHOLOGY *Insc.*

The official cuttle affords the cuttle-bone of the shops, which was formerly used as an amulet. The bones are frequently dug on all our shores; the animal very rarely. The larger eels, it is said, bite off their arms, or feet; but it is added they grow again, as does the lizard's tail (Plin. l. 29.). They are preyed upon by the plaice. This fish emits (in common with the other species), when alarmed or pursued, the black liquor which the ancients supposed darkened the circumambient wave, and concealed it from the enemy.

The endanger'd cuttle thus evades his fears,
And native bears of fluid fifty bears.
A pithy ink peculiar gland supplies,
Whose shades the sharpest beam of light defy.
Perfild, he bids the fable fountains flow,
And, wrapt in clouds, eludes th' impending foe.
The fish retreats unseen, while self born night,
With phas shades defends her parent's flight.

The ancients sometimes made use of it instead of ink. Puffinus mentions the species in his description of the noble student.

*Jam liber, et bicolor possit membrana capilli,
Lique manus charta, nodasq; venen' aranda.
Tum quorum, crassas colans quod pendat humor;
Nigra quod infusa crassat sepiæ lymphæ.*
At length, his book he spreads, his pen he takes;
His papers here in learned order lays,
And there his parchment's smother'd still displays.
But oh! what crosses wait on studious men!
The cuttle's juice hangs clotted at our pen.
*In all my life such stuff I never knew,
So gummy thick—Dilute it, it will do.
Nay, now 'tis sweeter!* DRYDEN.

This animal was esteemed a delicacy by the ancients, and is eaten even at present by the Italians. Rondeletius gives us two receipts for the dressing, which may be continued to this day. Athenæus also leaves us the method of making an antique cuttle fish sausage; and we learn from Aristotle, that those animals are in highest season when pregnant.

SEPIARIE, (from *sepiæ*, a hedge), the name of the 34th order of Linnaeus's Fragments of a Natural Method, consisting of a beautiful collection of woody

plants, some of which, from their size and elegance, are very proper furniture for hedges. See BOTANY *Insc.*

SEPIE, a species of LACERTA. See ERPELOGY *Insc.*

SEPTARIÆ, in *Natural History*, an old term for a variety of limestone, called also *lucus Helmontii*. This mineral is of a round compressed form, and is internally divided by septa or thin partitions of lime spar or pyrites; hence the name.

SEPTANS, a genus of plants belonging to the class of *Hydrocharia*; and in the natural system ranged under the 15th order, *Succulentæ*. See BOTANY *Insc.*

SEPTEMBER, the ninth month of the year, consisting of thirty days; it took its name as being the seventh month, reckoning from March, with which the Romans began their year.

SEPTENNIAL, any thing lasting seven years.
SEPTENNIAL Election, Blackst. in his Commentaries, vol. i. p. 189. says (after observing that the utmost extent of time allowed the same parliament to sit by the stat. 6. W. and M. c. 2. was three years), "But, by the statute 1 Geo. I. c. 2. c. 38. (in order *prospically* to prevent the great and continued expenses of frequent elections, and the violent heats and animosities consequent thereupon, and for the peace and security of the government, just then recovering from the late rebellion), this term was prolonged to seven years; and what alone is an instance of the vast authority of parliament, the very same law that was chosen for three years enacted its own continuance for seven."

SEPTENTRIO, in *Astronomy*, a constellation, more usually called *ursa minor*.

In cosmography, the term *septentrio* denotes the same with *north*; and hence septentrional is applied to any thing belonging to the north; as *septentrional signs, parallels*, &c.

SEPTICS, are those substances which promote putrefaction, chiefly the calcareous earth, magnesia, and tefaceous powder. From the many curious experiments made by Sir John Pringle to ascertain the *septic* and *antiseptic* virtues of natural bodies, it appears that there are very few substances of a truly *septic* nature. Those commonly reputed such by authors, as the alkaline and volatile salts, he found to be so wife *septic*. However, he discovered some, where it seemed least likely to find any such quality; these were chalk, common salt, and tefaceous powders. He mixed twenty grains of crabs eyes, prepared with six drams of ox's gall, and an equal quantity of water. Into another phial he put an equal quantity of gall and water, but no crabs eyes. Both these mixtures being placed in the furnace, the putrefaction began much sooner, where the powder was, than in the other phial. On making a like experiment with chalk, its *septic* virtue was found to be much greater than that of the crabs eyes; nay, what the doctor never met with before, in a mixture of two drams of flesh, with two ounces of water and thirty grains of prepared chalk, the flesh was resolved into a perfect mucus in a few days.

To try whether the tefaceous powders would also dissolve vegetable substances, the doctor mixed them with barley and water, and compared this mixture with another of barley and water alone. After a long maceration

Septuagint
Septuagint

ceramics by a fire, the plain water was found to swell the barley, and turn mucilaginous and sour; but that with the power kept the grain to its natural size, and though it softened it, yet made no mucilage, and remained sweet.

Nothing could be more unexpect'd, than to find sea salt a hastener of putrefaction; but the fact is thus; one dram of salt preserves two drams of fresh beef in two ounces of water, above thirty hours, uncorrupted, in a heat equal to that of the human body; or, which is the same thing, this quantity of salt keeps fish fresh twenty hours longer than pure water; but then half a dram of salt does not preserve it above two hours longer. Twenty-five grains have little or no antiseptic virtue, and ten, fifteen, or even twenty grains, manifestly both hasten and heighten the corruption. The quantity which had the most putrefying quality, was found to be about ten grains to the above proportion of fish and water.

Many inferences might be drawn from this experiment: one is, that since salt is never taken in aliment beyond the promotion of the corrupting quantities, it would appear that it is subservient to digestion chiefly by its *septic* virtue, that is, by softening and relaxing meats; an action very different from what is commonly believed.

It is to be observed, that the above experiments were made with the salt kept for domestic uses. See Pringle's Observ. on the Diseases of the army, p. 348, et seq.

SEPTIZON, or SEPTIZONIUM, in Roman antiquity, a celebrated mausoleum, built by Septimius Severus, in the tenth region of the city of Rome: it was so called from *septem* and *zona*, by reason it consisted of seven stories, each of which was surrounded by a row of columns.

SEPTUAGESIMA, in the kalendar, denotes the third Sunday before Lent, or before Quadragesima Sunday: supposed by some to take its name from its being about seventy days before Easter.

SEPTUAGINT, the name given to a Greek version of the books of the Old Testament, from its being supposed to be the work of seventy Jews, who are usually called the *seventy interpreters*, because seventy is a round number.

The history of this version is expressly written by Aristæus, an officer of the guards to Ptolemy Philadelphus, the substance of whose account is as follows:—Ptolemy having erected a fine library at Alexandria, which he took care to fill with the most curious and valuable books from all parts of the world, was inform'd that the Jews had one containing the laws of Moses, and the history of that people; and being desirous of enriching his library with a Greek translation of it, applied to the high-priest of the Jews; and to engage him to comply with his request, set at liberty all the Jews whom his father Ptolemy Soter had reduced to slavery. After such a step, he easily obtained what he desired; Eleazar the Jewish high-priest sent back his ambassadors with an exact copy of the Mosaic law, written in letters of gold, and six elders of each tribe, in all seventy-two; who were received with marks of respect by the king, and then conducted into the island of Pharos, where they were lodged in a house prepared for their reception, and supplied with every thing ne-

cessary. They set about the translation with out loss of time, and finish'd it in seventy-two days; and the whole being read in the presence of the king, he admir'd the profound wisdom of the laws of Moses; and put back the deputies laden with presents, but the elders, the high-priest, and the temple.

Aristæus, who was tutor to Ptolemy Phiscon, Phila was liv'd in our Saviour's time, and was a temporary with the apostles, and Jole has speak of this translation as made by seventy-two interpreters, by the care of Demetrius Phalereus in the reign of Ptolemy Philadelphus. All the Christian writers, during the first 15 centuries of the Christian era, have admitted this account of the Septuagint as an undoubted fact. But since the reformation, critics have boldly called it in question, because it was attended with circumstances which they think inconsistent, or, at least, improbable. Du Pin has asked, why were twenty-two interpreters employ'd, since twelve would have been sufficient? Such an objection is trifling. We may as well ask, why did King James I. employ six or four translators in rendering the Bible into English, since Du Pin thinks twelve would have been sufficient?

1. Prideaux objects, that the Septuagint is not written in the Jewish, but in the Alexandrian, dialect; and could not there ore be the work of natives of Palestine. But these diſcords were probably at that time the same, for both Jews and Alexandrians had received the Greek language from the Macedonians about 50 years before.

2. Prideaux further contends, that all the books of the Old Testament could not be translated at the same time; for they exhibit great difference of style. To this it is sufficient to reply, that they were the work of seventy-two men, each of whom had separate portions assigned them.

3. The Dean also urges, that Aristæus, Aristobulus, Philo, and Josephus, all directly tell us, that the law was translated without mentioning any of the other sacred books. But nothing was more common among writers of the Jewish nation than to give this name to the Scriptures as a whole. In the New Testament, law is used as synonymous with what we call the Old Testament. Besides, it is expressly said by Aristobulus, in a fragment quoted by Eusebius's *Prep. Evn.* l. 1. n. that the whole Sacred Scripture was rightly translated, through the means of Demetrius Phalereus, and by the command of Philadelphus. Josephus in deed, says the learned Dean, offers, in the preface to his Antiquities, that the Jewish interpreters did not translate for Ptolemy the whole Scriptures, but the law only. If the evidence is contradictory, and we have to determine, whether Aristobulus or Josephus be more worthy of credit. We do not mean, however, to decide either for or against, but only to inquire which led the best circumstances of knowing the truth. Aristobulus was an Alexandrian Jew, prior to an Egyptian king, and lived within 100 years after the translation was made, and certainly it is easier for him in the royal library. Josephus was a native of Palestine, and lived not until 200 years or more after the translation was made, and many years after the translation was made, and many years after the translation was made. For it was burnt along with the whole library of Alexandria in the wars of Julius Cæsar. Supposing the veracity of these testimonies equal, as we have no proof of the contrary, which of them ought we to consider as the best evidence? Aristobulus.

Septuagint. stobolus surely. Prideaux, indeed, seems doubtful whether there was ever such a man; and Dr Hody supposes that the Commentaries on the five books of Moses, which bear the name of Aristobolus, were a forgery of the second century. To prove the existence of any human being, who lived 2000 years before us, and did not perform such works as no mere man ever performed, is a task which we are not disposed to undertake; and we believe it would not be less difficult to prove that Philo and Josephus existed, than that such a person as Aristobolus did not exist. If the writings which have passed under his name were a forgery of the second century, it is surprising that they should have imposed upon Clemens Alexandrinus, who lived in the same century, and was a man of abilities, learning, and well acquainted with the writings of the ancients. Eusebius, too, in his *Prep. Evon.* quotes the Commentaries of Aristobolus. But, continues the learned Dean, "Clemens Alexandrinus is the first author that mentions them. Now, had any such commentaries existed in the time of Philo and Josephus, they would surely have been mentioned them. But is the circumstance of its not being quoted by every succeeding author a sufficient reason to disprove the authenticity of any book? Neither Philo nor Josephus undertook to give a list of preceding authors, and it was by no means the uniform practice of these times always to name the authors from whom they derived their information."

Septuagint's
Lectures on
the Canon.

4. Prideaux further contends, that the sum which Ptolemy is said to have given to the interpreters is too great to be credible. If his computation were just, it certainly would be so. He makes it 2,000,000*l.* sterling, but other writers * reduce it to 85,421*l.* and some to 56,947*l.*; neither of which is a sum so very extraordinary in our great and magnificent a prince as Philadelphus, who spent, according to a passage in Athenæus (lib. v.), not less than 100,000 talents on the furniture of one tent; which is six times more than what was spent in the whole of the embassy and translation, which amounted only to 1552 talents.

Septuagint's
Lectures on
the Canon.

5. Prideaux says, "that what convicts the whole story of Aristæus of falsity is, that he makes Demetrius Phalereus to be the chief actor in it, and a great favourite of the king; whereas Philadelphus, as soon as his father was dead, cast him into prison, where he soon after died." But it may be replied, that Philadelphus reigned two years jointly with his father Lagus, and it is not said by Hermippus that Demetrius was out of favour with Philadelphus during his father's life. Now, if the Septuagint was translated in the beginning of the reign of Philadelphus, as Eusebius and Jerome think, the difficulty will be removed. Demetrius might have been liberated during the reign of Philadelphus, and yet imprisoned on the death of Lagus. Indeed, as the cause of Philadelphus's displeasure was the advice which Demetrius gave to his father, to prefer the sons of Arinod before the son of Benice, he could scarcely show it till his father's death. The Septuagint translation might therefore be begun while Philadelphus reigned jointly with his father, but not be finished till after his father's death.

Septuagint's
Lectures on
the Canon.

6. Besides the objections which have been considered, there is only one that deserves notice. The ancient Christians not only differ from one another concerning the time in which Aristobolus lived, but even contra-

dict themselves in different parts of their work. Some-
times they tell us, he dedicated his book to Ptolemy Philometer, at other times they say, it was addressed to Philadelphus and his father. Sometimes they make him the same person who is mentioned in 2 Maccabees, chap. 1. and sometimes one of the 72 interpreters 152 years before. It is difficult to explain how authors fall into such inconsistencies, but it is probably occasioned by their quoting from memory. This was certainly the practice of almost all the early Christian writers, and sometimes of the apostles themselves. Mistakes were therefore inevitable. Josephus has varied in the circumstances of the same event, in his antiquities and wars of the Jews, probably from the same cause; but we do not hence conclude, that every circumstance of such a relation is entirely false. In the account of the Marquis of Argyle's death in the reign of Charles II. we have a very remarkable contradiction. Lord Clarendon relates, that he was condemned to be hanged, which was performed the same day: on the contrary, Burnet, Woodrow, Heath, Echard, concur in stating, that he was beheaded; and that he was condemned upon the Saturday and executed upon the Monday †. Was any reader of English history ever sceptic enough to raise from hence a question, whether the Marquis of Argyle was executed or not? Yet this ought to be left in uncertainty according to the way of reasoning in which the facts respecting the translation of the Septuagint is attempted to be disproved.

Biogra
Britan.

Such are the objections which the learned and ingenious Prideaux has raised against the common account of the Septuagint translation, and such are the answers which may be given to them. We have chosen to support that opinion which is sanctioned by historical evidence, in preference to the conjectures of modern critics however ingenious; being persuaded, that there are many things recorded in history, which, though perfectly true, yet, from our imperfect knowledge of the concomitant circumstances, may, at a distant period, seem liable to objections. To those who require positive evidence, it may be stated thus. Aristæus, Aristobolus, Philo, and Josephus, assure us, that the law was translated. Taking the law in the most restricted sense, we have at least sufficient authority to assert, that the Pentateuch was rendered into Greek under Ptolemy Philadelphus. Aristobolus affirms, that the whole Scriptures were translated by the seventy-two. Josephus confines their labours to the books of Moses. He therefore who cannot determine to which of the two the greatest respect is due, may suspend his opinion. It is certain, however, that many of the other books were translated before the age of our Saviour; for they are quoted both by him and his apostles: and, perhaps, by a minute examination of ancient authors, in the same way that Dr Lardner has examined the Christian fathers to prove the antiquity of the New Testament, the precise period in which the whole books of the Septuagint were composed might, with considerable accuracy, be ascertained.

For 400 years this translation was in high estimation with the Jews. It was read in their synagogues in preference to the Hebrew; not only in those places where Greek was the common language, but in many synagogues of Jerusalem and Judea. But when they saw that it was equally valued by the Christians, they be-

came

came jealous of it, and at length, in the second century, Aquila, an apostate Christian, attempted to substitute another Greek translation in its place. In this work he was careful to give the ancient prophecies concerning the Messiah a different turn from the Septuagint, that they might not be applicable to Christ. In the same design he was followed by Symmachus and Theodotion, who also, as St Jerome informs us, wrote out of hatred to Christianity.

In the mean time, the Septuagint, from the ignorance, boldness, and carelessness of transcribers, became full of errors. To correct these, Origen published a new edition in the beginning of the third century, in which he placed the translations of Aquila, Symmachus, and Theodotion. This edition was called *Tetrapla*, the translations being arranged opposite to one another in four columns. He also added one column, containing the Hebrew text in Hebrew letters, and another exhibiting it in Greek. In a second edition he published two additional Greek versions; one of which was found at Nicopolis, and the other at Jericho; this was called the *Hexapla*. By comparing so many translations, Origen endeavoured to form a correct copy of the Scriptures. Where they all agreed, he considered them right. The passages which he found in the LXX, but not in the Hebrew text, he marked with an obelisk: what he found in the Hebrew, but not in the LXX, he marked with an asterisk. St Jerome says, that the additions which Origen made to the LXX, and marked with an asterisk, were taken from Theodotion. From this valuable work of Origen the version of the LXX was transcribed in a separate volume, with the asterisks and obelisks for the use of the churches; and from this circumstance the great work itself was neglected and lost.

About the year 300 two new editions of the LXX were published; the one by Hefychius an Egyptian bishop, and the other by Lucian a presbyter of Antioch. But as these authors did not mark with any note of distinction the alterations which they had made, their edition does not possess the advantages of Origen's.

The best edition of the LXX is that of Dr Grabe, which was published in the beginning of the present century. He had access to two MSS, nearly of equal antiquity, the one found in the Vatican library at Rome, the other in the royal library at St James's, which was presented to Charles I. by Cyril, patriarch of Alexandria, and hence is commonly called the *Alexandrian MS*. Anxious to discover which of these was according to the edition of Origen, Dr Grabe collected the fragments of the Hexapla, and found they agreed with the Alexandrian MS. but not with the Vatican where it differed with the other. Hence he concluded that the Alexandrian MS. was taken from the edition of Origen. By comparing the quotations from scripture in the works of Athanasius and St Cyril (who were patriarchs of Alexandria at the time St Jerome says Hefychius's edition of the LXX was then used) with the Vatican MS. he found they agreed so well that he justly inferred that that MS. was taken from the edition of Hefychius.

This version was in use to the time of our blessed Saviour, and is that out of which most of the citations in the New Testament, from the Old, are taken. It was also the ordinary and canonical translation made use of by the Christian church in the earliest ages;

and it still subsists in the churches both of the east and ^{Septuagint} _{Septuagint} west.

Those who desire a more particular account of the Septuagint translations may consult *Hody de Bibliorum Textibus*, Prideaux's *Connections*, Owen's *Inquiry into the Septuagint Version*, Blair's *Lectures on the Canon*, and Michaelis's *Introduction to the New Testament*, last edition.

SEPTUAGINT Chronology, the chronology which is formed from the dates and periods of time mentioned in the Septuagint translation of the Old Testament. It reckons 1500 years more from the creation to Abraham than the Hebrew bible. Dr Kennicot, in the dissertation prefixed to his Hebrew bible, has shown it to be very probable that the chronology of the Hebrew scriptures, since the period just mentioned, was corrupted by the Jews, between the years 173 and 200, and that the chronology of the Septuagint is more agreeable to truth. It is a fact, that during the second and third centuries the Hebrew scriptures were almost entirely in the hands of the Jews, while the Septuagint was confined to the Christians. The Jews had therefore a very favourable opportunity for this corruption. The following is the reason which is given by oriental writers: It being a very ancient tradition, that the Messiah was to come in the sixth chiliad, because he was to come in the last days (founded on a mythical application of the six days creation), the contrivance was to shorten the age of the world from about 5500 to 3760; and thence to prove that Jesus could not be the Messiah. Dr Kennicot adds, that some Hebrew copies having the larger chronology were extant till the time of Eusebius, and some till the year 700.

SEPTUM, in *Anatomy*, an inclosure or partition; a term applied to several parts of the body, which serve to separate one part from another; as, *septum narium*, or partition between the nostrils, &c.

SEPULCHRAL, something belonging to sepulchres or tombs: thus a sepulchral column is a column erected over a tomb, with an inscription on its shaft; and sepulchral lamps, those said to have been found burning in the tombs of several martyrs and others. See *LAMP*.

SEPULCHRE, a tomb or place designed for the interment of the dead. This term is chiefly used in speaking of the burying-places of the ancients, those of the moderns being usually called *tombs*.

Sepulchres were held sacred and inviolable; and the care taken of them has always been held a religious duty, grounded on the fear of God, and the belief of the soul's immortality. Those who have searched or violated them have been thought odious by all nations, and were always severely punished.

The Egyptians called sepulchres *eternal houses*, in contradistinction to their ordinary houses or palaces, which they called *inns*, on account of their short stay in the one in comparison of their long abode in the other. See *TOMB*.

Regular Canons of St SEPULCHRE, a religious order, formerly instituted at Jerusalem, in honour of the holy sepulchre, or the tomb of Jesus Christ.

Many of these canons were brought from the Holy Land into Europe, particularly into France, by Louis the Younger; into Poland, by Jaxa, a Polish gentleman; and into Flanders, by the counts thereof; many

Sequestration
of
Sequestration

also came into England. This order was, however, suppressed by Pope Innocent VIII. who gave its revenues and effects to that of our Lady of Bethlehem: which also becoming extinct, they were bestowed on the knights of St John of Jerusalem. But the suppression did not take effect in Poland, where they still subsist, as also in several provinces of Germany. These canons follow the rule of St Augustine.

Knights of the Holy SEPULCHRE, a military order, established in Palestine about the year 1114.

The knights of this order in Flanders chose Philip II. king of Spain, for their master, in 1558, and afterwards his son; but the grand master of the order of Malta prevailed on the last to resign; and when afterwards the duke of Nevers assumed the same quality in France, the same grand master, by his interest and credit, procured a like renunciation of him, and a confirmation of the union of this order to that of Malta.

SEQUANI, a people anciently forming a part of Gallia Celtica, but annexed to Belgica by Augustus, separated from the Helvetii by Mount Jura, with the Rhine on the east (Strabo), bordering on the Ædui and Segutiano to the south, and Lingnes to the west (Tacitus). Now Franche Comte.

SEQUESTRATION, in *Common Law*, is setting aside the thing in controversy from the possession of both the parties that contend for it. In which sense it is either voluntary, as when done by the consent of the parties; or necessary, as where it is done by the judge, of his own authority, whether the parties will or not.

SEQUESTRATION, in the *Civil Law*, is the act of the ordinary, disposing of the goods and chattels of one deceased, while estate no man will meddle with.

A widow is also said to sequester, when she disclaims having any thing to do with the estate of her deceased husband.

Among the Romanists, in questions of marriage, where the wife complains of impotency in the husband, she is to be sequestered into a convent, or into the hands of matrimony, till the process be determined.

SEQUESTRATION is also used for the act of gathering the fruits of a benefice void, to the use of the next incumbent.

Sometimes a benefice is kept under sequestration for many years, when it is of so small value, that no clergyman fits to serve the cure will be at the charge of taking it by institution; in which case the sequestration is committed either to the curate alone, or to the curate and church-wardens jointly. Sometimes the profits of a living in controversy, either by the consent of the parties, or the judge's authority, are sequestered and placed for safety in a third hand, till the suit is determined, a minister being appointed by the judge to serve the cure, and allowed a certain salary out of the profits. Sometimes the profits of a living are sequestered for neglect of duty, for dilapidations, or for satisfying the debts of the incumbent.

SEQUESTRATION, in chancery, is a commission usually directed to seven persons therein named, empowering them to seize the defendant's personal estate, and the profits of his real, and to detain them, subject to the order of the court. It issues on the return of the serjeant at

arms, wherein it is certified, that the defendant had sequestered himself.

Sequestrations were first introduced by Sir Nicholas Bacon, lord keeper in the reign of Queen Elizabeth; before which the court found some difficulty in enforcing its process and decrees; and they do not seem to be in the nature of process to bring in the defendant, but only intended to enforce the performance of the court's decree.

A sequestration is also made, in London, upon an action of debt; the course of proceeding in which case is this: The action being entered, the officer goes to the defendant's shop or warehouse, when no person is there, and takes a padlock, and hangs it on the door, uttering these words: "I do sequester this warehouse, and the goods and merchandise therein, of the defendant in this action, to the use of the plaintiff," &c. after which he sets on his seal, and makes a return of the sequestration in the compier; and four days being passed after the return made, the plaintiff may, at the next court, have judgment to open the shop or warehouse, and to have the goods appraised by two freemen, who are to be sworn at the next court held for that matter; and then the serjeant puts his hand to the bill of appraisement, and the court grants judgment thereon; but yet the defendant may put in bail before satisfaction, and by that means dissolve the sequestration; and after satisfaction, may put in bail to disprove the debt, &c.

In the time of the civil wars, sequestration was used for a seizing of the estates of delinquents for the use of the commonwealth.

SEQUESTRATION, in *Scots Law*. See *LAW INDEX*.
SEQUIN, a gold coin, struck at Venice, and in several parts of the Grand Signior's dominions. In Turkey, it is called *dahob*, or piece of gold, and according to Volney is in value about 6s. 3d. sterling. It varies, however, considerably in its value in different countries. At Venice it is equal to about 9s. 2d. sterling.

The Venetian sequins are in great request in Syria, from the fineness of their standard, and the practice they have of employing them for women's trinkets. The fashion of these trinkets does not require much art; the piece of gold is simply pierced, in order to suspend it by a chain, likewise of gold, which flows upon the breast. The more sequins that are attached to this chain, and the greater the number of these chains, the more is a woman thought to be ornamented. This is the favourite luxury, and the emulation of all ranks. Even the female peasants, for want of gold, wear poodles or smaller pieces; but the women of a certain rank disdain silver; they will accept of nothing but sequins of Venice, or large Spanish pieces, and crusadoes. Some of them wear 260 or 300, as well living flat, as thrust one on another, and hung near the forehead, at the edge of the head dress. It is a real load: but they do not think they can pay too dearly for the satisfaction of exhibiting this treasure at the public bath, before a crowd of rivals, to awaken whose jealousy constitutes their chief pleasure. The effect of this luxury on commerce, is the withdrawing considerable sums from circulation, which remain dead; besides, that when any of these pieces return into common use, having left

Sequestration
II
Sequin.

Seraglio.

their weight by being pierced, it becomes necessary to weigh them. The practice of weighing money is general in Syria, Egypt, and all Turkey. No piece, however effaced, is refused there; the merchant draws out his scales and weighs it, as in the days of Abraham, when he purchased his sepulchre. In considerable payments, an agent of exchange is sent for, who counts paras by thousands, retorts a great many pieces of false money, and weighs all the septims, either separately or together.

SERAGLIO, formed from the Persian word *Sera*, or Turkish word *Saray*, which signifies a house, and is commonly used to express the palace or palace of a prince. In this sense it is frequently used at Constantinople; the houses of foreign ambassadors are called *Seraglio*. But it is commonly used by way of eminence for the palace of the grand signior at Constantinople, where he keeps his court, and where his consuls are lodged, and where the youth are trained up for the chief posts of the empire.

It is a triangle about three Italian miles round, wholly within the city, at the end of the promontory Chrysæus, now called the *Seraglio Point*. The buildings run back to the top of the hill, and from thence are gardens that reach to the edge of the sea. It is inclosed with a very high and strong wall, upon which there are several watch towers: and it has many gates, some of which open towards the sea side, and the rest into the city; but the chief gate is one of the latter, which is constantly guarded by a company of capuchins, or peters; and in the night it is well guarded towards the sea. The outward appearance is not very beautiful, the architecture being irregular, consisting of separate edifices in the form of pavilions and domes.

The ladies of the seraglio are a collection of beautiful young women, chiefly sent as presents from the provinces and the Greek islands, most of them the children of Christian parents. The brave prince Heraclius hath for some years past abolished the infamous tribute of children of both sexes, which Georgia formerly paid every year to the Porte. The number of women in the harem depends on the taste of the reigning monarch or sultan. Selim had 2000, Achmet had but 300, and his successor had nearly 1600. On their admission they are committed to the care of old ladies, taught sewing and embroidery, music, dancing, and other accomplishments, and furnished with the richest clothes and ornaments. They all sleep in separate beds, and between every fifth there is a preceptress. Their chief governess is called *Katon Kiaya*, or governess of the noble young ladies. There is not one servant among them, for they are obliged to wait on one another by rotation; the last that is entered serves her who preceded her and herself. These ladies are scarcely ever suffered to go abroad, except when the grand signior removes from one place to another, when a troop of black eunuchs conveys them to the boats, which are inclosed with latices and linen curtains; and when they go by land they are put into close chariots, and signals are made at certain distances, to give notice that none approach the roads through which they march. The boats of the harem, which carry the grand signior's wives, are manned with 24 rowers, and have white covered tilts, shut alternately by Venetian blinds. Among the em-

Seraglio.

perial attendants are a number of mutes, who act and converse by signs with great quickness, and some deans, who are established for the direction of his Majesty.

What he permits the women to walk in the gardens of the seraglio, all people are ordered to retire, and on every side there is a guard of black eunuchs, with sabres in their hands, while others go their rounds in order to hinder any person from leaving them. If, unfortunately, any one is found in the garden, even through ignorance or inadvertence, he is undoubtedly killed, and his head brought to the feet of the grand signior, who gives a great reward to the guard for their vigilance. Sometimes the grand signior passes into the gardens to amuse himself when the women are there; and it is then that they make use of their utmost efforts, by dancing, singing, reciting godes, and amorous blandishments, to obtain the affections of the monarch. It is not permitted that the monarch should take a virgin to his bed, except during the solemn festivals, and on occasion of some extraordinary rejoicings, or the arrival of some good news. Upon such occasions, if the sultan chooseth a new companion to his bed, he enters into the apartment of the women, who are ranged in files by the governesses, to whom he speaks, and intimates the person he likes best: the ceremony of the handkerchief, which the grand signior is said to throw to the girl that he elects, is an idle tale, without any foundation. As soon as the grand signior has chosen the girl that he has delisted to be the partner of his bed, all the others follow her to the bath, washing and perfuming her, and dressing her superbly, conducting her singing, dancing, and rejoicing, to the bed chamber of the grand signior, who is generally, on such an occasion, already in bed. Scarcely has the new-elected favourite entered the chamber, introduced by the grand eunuch who is upon guard, than she kneels down, and when the sultan calls her, she creeps into bed to him by the foot of the bed, if the sultan does not order her, by especial grace, to approach by the side: after a certain time, upon a signal given by the sultan, the governess of the girls, with all her suite, enters the apartment, and takes her back again, conducting her with the same ceremony to the women's apartments; and if by good fortune she becomes pregnant, and is delivered of a boy, she is called *afaki sultanaesi*, that is to say, sultaness-mother; for the first son of the nas the honour to be crowned, and she has the liberty of forming her court. Eunuchs are also assigned for her guard, and for her particular service. No other ladies, though delivered of boys, are either crowned or maintained with such costly distinction as the first; however, they have their service apart, and handsome appointments. After the death of the sultan, the mothers of the male children are shut up in the old seraglio, from whence they can never come out any more, unless any of their sons ascend the throne. Baron de Tott informs us, that the female slave who becomes the mother of a sultan, and lives long enough to see her son mount the throne, is the only woman who has a period alone acquires the distinction of *sultana mother*; she is till then in the interior of her prison with her son. The title of *baché kudan*, principal woman, is the first dignity of the grand signior's harem; and she has a larger allowance

Seraglio.

allowance than those who have the title of second, third, and fourth woman, which are the four free women the Koran allows.

This is a description of the grand signior's seraglio: we shall now add an account of the seraglio or harem, as it is often called, of the emperor of Morocco, from the very interesting tour of Mr Lempriere. This gentleman being a surgeon by profession, was admitted into the harem to prescribe for some of the ladies who were indisposed, and was therefore enabled to give a particular account of this female prison, and, what is still more curious, of the manners and behaviour of its inhabitants.

The harem forms a part of the palace. The apartments, which are all on the ground floor, are square, very lofty, and four of them inclose a spacious square court, into which they open by means of large folding doors. In the centre of these courts, which are floored with blue and white chequered tiling, is a fountain, supplied by pipes from a large reservoir on the outside of the palace, which serves for the frequent ablutions recommended by the Mahometan religion, as well as for other purposes. The whole of the harem consists of about twelve of these square courts, communicating with each other by narrow passages, which afford a free access from one part of it to another, and of which all the women are allowed to avail themselves.

The apartments are ornamented on the outside with beautiful carved wood. In the inside most of the rooms are hung with rich damask of various colours; the floors are covered with beautiful carpets, and there are mattresses disposed at different distances, for the purposes of sitting and sleeping.

Besides these, the apartments are furnished at each extremity with an elegant European mahogany bedstead, hung with damask, having on it several mattresses placed one over the other, which are covered with various coloured silks; but these beds are merely placed there to ornament the room. In all the apartments, without exception, the ceiling is wood, carved and painted. The principal ornaments in some were large and valuable looking-glasses, hung on different parts of the walls. In others, clocks and watches of different sizes, in glass cases, were disposed in the same manner.

The sultana Lalla Batoom and another favourite were indulged with a whole square to themselves; but the concubines were only each allowed a single room.

Each female had a separate daily allowance from the emperor, proportioned to the estimation in which they were held by him. The late emperor's allowance was very trifling: Lalla Douyaw, the favourite sultana, had very little more than half-a-crown English a-day, and the others less in proportion. It must be allowed, that the emperor made them occasional presents of money, dress, and trinkets; but this could never be sufficient to support the number of domestics and other expences they must incur. Their greatest dependence therefore was on the presents they received from those Europeans and Moors who visited the court, and who employed their influence in obtaining some particular favour from the emperor. This was the most successful mode that could be adopted. When Mr Lempriere was at Morocco, a Jew, desirous of obtaining a very advantageous favour from the emperor, for which he had been a

Seraglio.

long time unsuccessfully soliciting, sent to all the principal ladies of the harem presents of pearls to a very large amount; the consequence was, that they all went in a body to the emperor, and immediately obtained the wished-for concession.

The ladies separately furnish their own rooms, hire their own domestics, and, in fact, do what they please in the harem, but are not permitted to go out without an express order from the emperor, who very seldom grants them that favour, except when they are to be removed from one palace to another. In that case, a party of soldiers is dispatched a little distance before them, to disperse the male passengers in particular, and to prevent the possibility of their being seen. This previous step being taken, a piece of linen cloth is tied round the lower part of the face, and afterwards these miserable females cover themselves entirely with their haicks, and either mount mules, which they ride like men, or, what is more usual, are put into a square carriage or litter, constructed for this purpose, which by its lattice work allows them to see without being seen. In this manner they set off, under the charge of a guard of black eunuchs. This journey, and sometimes a walk within the bounds of the palace, with which they are, however, seldom indulged, is the only exercise they are permitted to take.

The late emperor's harem consisted of between 60 and 100 females, besides their domestics and slaves, which were very numerous. Many of the concubines were Moorish women, who had been presented to the emperor, as the Moors consider it an honour to have their daughters in the harem; several were European slaves, who had either been made captives, or purchased by the emperor; and some were Negroes.

In this group the Europeans, or their descendants, had by far the greatest claim to the character of handsome. There was one in particular, who was a native of Spain, and taken into the harem at about the same age as Lalla Douyaw, who was indeed a perfect beauty. Nor was this lady quite singular in that respect, for many others were almost equally handsome.

The eunuchs, who have the entire charge of the women, and who in fact live always among them, are the children of Negro slaves. They are generally either very short and fat, or else tall, deformed, and lame. Their voices have that particular tone which is observable in youths who are just arriving at manhood; and their persons altogether afford a disgusting image of weakness and inefficiency.

The same gentleman gives us a very curious account of the manners and ignorance of these immured females, from his own observation, when visiting the prince's harem. "Attended by an eunuch (says he), after passing the gate of the harem, which is always locked, and under the care of a guard of eunuchs, we entered a narrow and dark passage, which soon brought us to the court, into which the women's chambers open. We here saw numbers of both black and white women and children; some concubines, some slaves, and others hired domestics.

"Upon their observing the unusual figure of an European, the whole multitude in a body surrounded me, and expressed the utmost astonishment at my dress and appearance. Some stood motionless, with their hands lifted up, their eyes fixed, and their mouths open, in the

the usual attitude of wonder and surprize. Some Luril into immoderate fits of laughter; while others again come up, and with unbecoming attention eyed me from head to foot. The pairs of my arms which seemed most to attract their notice were my buckles, luteens, and flock-tees; for neither men nor women in this country wear any thing of the kind. With respect to the club of my hair, they seemed utterly at a loss in what view to consider it; but the powder which I wore they conceived to be employed for the purpose of destroying vermin. Most of the children, when they saw me, ran away in the most perfect consternation; and on the whole, I appeared as singular an animal, and I dare say had the honour of exciting as much curiosity and attention, as a lion or man-tiger jail imported from abroad, and introduced into a country town in England on a market-day. Every time I visited the harem, I was surrounded and laughed at by this curious mob, who, on my entering the gate, followed me close to the very chamber to which I was proceeding, and on my return universally escorted me out.

"The greater part of the women were uncommonly fat and unweildy; had black and full eyes, round faces, with small noses. They were of different complexions; some very fair, some fallow, and others again perfect Negroes.

"One of my new patients being ready to receive me, I was desired to walk into her room; where, to my great surprize, I saw nothing but a curtain drawn quite across the apartment, similar to that of a theatre which separates the stage from the audience. A female domestic brought a very low stool, placed it near the curtain, and told me I was to sit down there, and feel her mistress's pulse.

"The lady, who had by this time summoned up courage to speak, introduced her hand from the bottom of the curtain, and desired me to inform her of all her complaints, which she conceived I might perfectly do by merely feeling the pulse. It was in vain to ask her where her pain was seated, whether in her stomach, head, or back; the only answer I could procure was a request to feel the pulse of the other hand, and then point out the seat of the disease, and the nature of the pain.

"Having neither satisfied my curiosity by exhibiting her face, nor made me acquainted with the nature of her complaint, I was under the necessity of informing her in positive terms, that to understand the disease it was absolutely necessary to see the tongue as well as to feel the pulse; and that without it I could do nothing for her. My eloquence, or rather that of my Jewish interpreter, was, however, for a long time exerted in vain; and I am persuaded she would have dismissed me without any further inquiry, had not her invention supplied her with a happy expedient to remove her embarrassments. She contrived at last to cut a hole through the curtain, through which she extruded her tongue, and thus complied with my injunction as far as it was necessary in a medical view, but much effectually disappointed my curiosity.

"I was afterwards ordered to look at another of the prince's wives, who was afflicted with a ferocious swelling in her neck. This lady was, in the same manner as the other, at first excluded from my sight; but as she was obliged to show me her complaint, I had an

opportunity of seeing her face, and observed it to be very handsome."

It is curious to observe the strange and childish notions of persons who have been wholly secluded from the world. All the ladies of the harem expected that our author should have instantly discovered their complaints upon feeling the pulse, and that he could cure every disease instantaneously. He found them proud and vain of their perfumes, and extremely ignorant. "Among many ridiculous questions, they asked my interpreter (says Mr. Lempriere) if I could read and write; upon being answered in the affirmative, they expressed the utmost surprize and admiration at the abilities of the Christians. There was not one among them who could do either; these rudiments of learning are indeed only the lot of a few of their men, who on that account are named *Taliks*, or explainers of the Malometan law."

It is melancholy to reflect on the situation of these unfortunate women. Being considered as the necessaries of pleasure, no attention is paid to the improvement of their minds. They have no opportunity to employ their time. Their middle-work is performed by Jewesses; their food is dressed, and their chambers taken care of, by slaves and domestics. They have no amusement but a staid and barbarous kind of melancholy music, without melody, variety, or taste; and conversation with one another, which must indeed be very confined, uniform, and insipid, as they never see a new object. Excluded from the enjoyment of fresh air and exercise, so necessary for the support of health and life; deprived of all society but that of their fellow sufferers, a society to which most of them would prefer solitude; they are only to be considered as the most abject of slaves—slaves to the vices and oppression of a monstrous tyrant, who exacts even from his wives themselves a degree of submission and respect which borders on a idolatry, and which God and nature never meant should be paid to a mortal.

SERAI, a building on the high-road, or in large cities in India, erected for the accommodation of travellers.

SERAPH, or SERAPHIM, spirits of the highest rank in the hierarchy of angels; who are thus called from their being supposed to be in a continual state of divine love, by their nearer and more immediate attendance at the throne of God, and to communicate their favour to the remoter and inferior orders. *Seraphim* is the Hebrew plural of *seraph*. See ANGEL.

SERAPHIC, burning or inflamed with love or zeal, like a seraphim; thus St. Bonaventure is called the *seraphic doctor*, from his abundant zeal and fervour.

SERAPIA, a genus of plants belonging to the class of gymnosperms, and in the natural system arranged under the seventh order *Orchidaceae*. See BOTANICAL INDEX.

SERAPION, a physician of Alexandria. He and PELLICUS of the life of Cos were both scholars of Hippocrates, and were founders of the empiric sect; which happened about 280 B. C.

SERAPIS, in *Mythology*, an Egyptian deity, who was worshipped under various names and epithets, as, the tutelary god of Egypt in general, and the patron of several of their principal cities. Tacitus it seems us, that he was worshipped as a kind of universal deity that resembled Esculapius, Osiris, Jupiter, and Pluto; and

Serapis
||
Sereus.

he was sometimes taken for Jupiter Ammon, the Sun, and Neptune: and the honours that were rendered to him at Alexandria were more solemn and extraordinary than those of any other place.

§ The High Priest of Serapis.
§ The High Priest of Serapis.
§ The High Priest of Serapis.
§ The High Priest of Serapis.
§ The High Priest of Serapis.
§ The High Priest of Serapis.
§ The High Priest of Serapis.
§ The High Priest of Serapis.

Plutarch and Clemens of Alexandria, as well as Tacitus, inform us, that while the first Ptolemy was employed in fortifying Alexandria with walls, adorning it with temples and stately buildings, there appeared to him in his sleep a young man of extraordinary beauty, of a stature more than human, admonishing him to dispatch into Pontus some of his most trusty friends to bring from thence his statue: he assured him, that the city and kingdom which possessed it should prove happy, glorious, and powerful. The young man having thus spoken, disappeared, mounting up into heaven in a blaze of fire.

Ptolemy discovered his vision to the priests; but finding them ignorant of Pontus, he had recourse to an Athenian, who informed him that near Sinope, a city of Pontus, there was a temple much resorted to by the natives, which was consecrated to Pluto, where he had a statue, near which stood that of a woman. Ptolemy, neglecting the injunctious of the apparition, it again appeared to him in a menacing attitude; and the king immediately dispatched ambassadors to the Serapian monarch, loaded with presents. The king of Sinope consented; but his subjects opposed the removal of the statue. The god, however, of his own accord, as we are informed, conveyed himself to the ambassador's ship, and in three days landed in Alexandria. The statue of Serapis was erected in one of the suburbs of the city, where a magnificent temple was afterwards reared.

The statue of Serapis, according to Macrobius, was of a human form, with a basket or bushel on his head, signifying plenty; his right hand leaned on the head of a serpent, whose body was wound round a figure with three heads, of a dog, a lion, and a wolf; in his left hand he held a measure of a cubit length, as it were to take the height of the waters of the Nile. The figure of Serapis is found on many ancient medals.

The famous temple of Serapis at Alexandria was destroyed by order of Theodosius; and the celebrated statue of this deity was broken in pieces, and its limbs carried first in triumph by the Christians through the city, and then thrown into a fierce fire, kindled for that purpose in the amphitheatre. As the Egyptians ascribed the overflowing of the Nile, to which was owing the fertility of their country, to the benign influence of their god Serapis, they concluded, that now he was destroyed, the river would no longer overflow, and that a general famine would ensue; but when they observed, on the contrary, that the Nile swelled to a greater height than had been known in the memory of man, and thereby produced an immense plenty of all kinds of provisions, many of the pagans renouncing the worship of idols, adored the God of the Christians.

SERENA GUTTA, the same as *amarogita*. See MEDICINE, N^o 367.

SERENADE, a kind of concert given in the night by a lover to his mistress, under her window. These sometimes only consist of instrumental music, but at other times voices are added: the music and songs composed for these occasions are also called *serenades*.

SERENE, a title of honour given to several princes and to the principal magistrates of republics. The king

of Britain, the republic and doge of Venice, and the children of the king of Spain, are called *most serene*; and when the pope or the sacred college write to the emperor, to kings, or to the doge, they give them no other title. In like manner, the emperor gives no other title to any king, except to the king of France.

SERENUS, SAMMONICUS, a celebrated physician in the reigns of the emperors Severus and Caracalla, in and about the year 200. He wrote several treatises on history and the works of nature; but there is only one of them extant, which is a very indifferent poem on the Remedies of Diseases. He was murdered at a festival by the order of Caracalla. He had a library that contained 62,000 volumes, which Quintus Sereus Sammonicus his son gave to Gordian the Younger, to whom he was preceptor.

SERES (Ptolemy) a people of the Farther Asia; bounded on the west by Scythia extra Imaum; on the north and east, by Terra Incognita; and on the south, by India extra Gangem. According to these limits, their country answers nearly to Cathoy or North China. Other authors vary greatly in placing them, though the generality agree in placing them far to the east. Mela places them between the Indi and Scythie; and perhaps beyond the Indi, if we distinguish the Sinae from them. The ancients commend them for their cotton manufactures, different from the produce of the bombyces or silk-worms, called *seres* by the Greeks; whence *sericea*, "silk."

SERGE, a woollen quilted stuff, manufactured on a loom with four treddles, after the manner of rateens, and other stuffs that have the whale. The goodness of serges is known by the quilting, as that of cloths by the spinning. Of serges there are various kinds, denominated either from the different qualities thereof, or from the places where they are wrought. The most considerable is the London serge, now highly valued abroad, particularly in France, where a manufacture is carried on with considerable success, under the title of *serge façon de Londres*.

The method of making the London serge we shall now describe: For wool, the longest is chosen for the warp, and the shortest for the woof. Before either kind is used, it is well secured, by putting it in a copper of liquor, somewhat more than lukewarm, composed of three parts of fair water and one of urine. After having stayed long enough therein for the liquor to dissolve, and take off the grease, &c. it is stirred briskly about with a wooden peel; taken out of the liquor, drained, and washed in a running water, dried in the shade, beaten with sticks on a wooden rack to drive out the coarser dust and filth, and then picked clean with the hands. Thus far prepared, it is greased with oil of olives, and the longest part, destined for the warp, is combed with large combs, heated in a little furnace for the purpose. To clear off the oil again, the wool is put in a liquor composed of hot water, with soap melted therein: whence being taken out, wrung, and dried, it is spun on the wheel.

As to the shorter wool, intended for the woof, it is only carded on the knee with small cards, and then spun on the wheel, without being scoured of its oil. It must be remarked, that the thread for the warp is always to be spun much finer, and better twilled than that of the woof. The wool both for the warp and the

Sereus
||
Serge.

Sergeant

the wool being spun, and the thread divided into skains, that of the wool is put on spools (unless it have been spun upon them) fit for the cavity or eye of the shuttle; and that for the warp is wound on a kind of wooden bobbin; so fit for warping. When warped, it is stretched with a kind of face, whereof that made of the threads of parchment is held the best; and when dry is put on the loom.

When mounted on the loom, the workmen raising and lowering the threads (which are passed through a reed), by means of four treads placed underneath the loom, which he makes to act transversely, equally, and alternately, one after another, with his feet, in proportion as the threads are raised and lowered, throws the shuttle across from one side to the other; and each time that the shuttle is thrown, and the thread of the wool is crossed between those of the warp, strikes it with the frame to which the reed is fastened, through those teeth the threads of the warp pass; and this stroke he repeats twice or thrice, or even more, till he finishes the crossing of the serge sufficiently close: thus he proceeds till the warp is all filled with wool.

The serge now taken off the loom is carried to the fuller, who seours it in the trough of his mill with a kind of fat earth, called *fuller's earth*, first purged of all stones and fish. After three or four hours scouring, the fuller's earth is washed out in fair water, brought by little and little into the trough, out of which it is taken when all the earth is cleared; then, with a kind of iron pincers or pleyers, they pull off all the knots, ends, straws, &c. picking out on the surface on either side; and then returning it into the falling trough, where it is worked with water somewhat more than lukewarm, with soap dissolved therein for near two hours: it is then washed out till such time as the water becomes quite clear, and there be no signs of soap left; then it is taken out of the trough, the knots, &c. again pulled off, and then put on the tenter to dry, taking care as fast as it dries to stretch it out both in length and breadth till it be brought to its just dimensions. When well dried, it is taken off the tenter, and dyed, thorn, and pressed.

SERGEANT, or **SERGEANT at Law**, or *of the Coif*, is the highest degree taken at the common law, as that of Doctor is of the civil law; and as these are supposed to be the most learned and experienced in the practice of the courts, there is one court appointed for them to plead in by themselves, which is the common pleas, where the common law of England is most strictly observed; but they are not restricted from pleading in any other court, where the judges, who cannot have that honour till they have taken the degree of sergeant at law, call them *brothers*.

SERGEANT at Arms, or *Mace*, an officer appointed to attend the person of the king; to arrest traitors, and such persons of quality as offend; and to attend the lord high steward, when sitting in judgement on a traitor.

Of these, by statute 13 Richard II. cap. 6. there are not to be above 25 in the realm. There are now nine at court at 100l. per annum salary each; they are called *the King's sergeants at arms*, to distinguish them from others: they are clothed with great ceremony, the persons kneeling before the king, his majesty lays the mace in his right shoulder, and says, *Rise up, sergeant at arms*,

and *obey for ever*. They have, besides, a patent for the office, which they hold for life.

They have their attendance in the great chamber, where the band of gentlemen-pensioners wait; receiving the king at the door, they carry the maces before him to the chapel door, within the band of pensioners stand foremost, and make a lane for the king, as they do also when the king goes to the house of lords.

There are four other sergeants at arms, created in the same manner; one, who attends the lord chancellor; a second, the lord treasurer; a third, the speaker of the house of commons; and a fourth, the lord mayor of London on solemn occasions.

They have a considerable share of the fees of honour, and travelling charges allowed them when in waiting, viz. five shillings per day when the court is within ten miles of London, and ten shillings when twenty miles from London. The places are in the lord chamberlain's gift.

There are also sergeants of the mace of an inferior kind, who attend the mayor or other head officer of a corporation.

Common SERGEANT, an officer in the city of London, who attends the lord mayor and court of aldermen on court days, and is in council with them on all occasions, within and without the precincts or liberties of the city. He is to take care of orphan estates, either by taking account of them, or to sign their indentures, before their passing the lord mayor and court of aldermen: and he was likewise to let and manage the orphan estates, according to his judgement to their best advantage. See **RECORDER**.

SERGEANT, in *War*, is an uncommissioned officer in a company of foot or troop of dragoons, armed with an halbert, and appointed to see discipline observed, to teach the soldiers the exercise of their arms, to order, strain, and form their ranks, files, &c. He receives the orders from the adjutant, which he communicates to his officers. Each company generally has two sergeants.

SERGEANTY (*Serjantia*), signifies, in law, a service that cannot be due by a tenant to any lord but the king; and this is either *grand serjeanty*, or *petty*. The first is a tenure by which the one holds his lands of the king by such services as he ought to do in person to the king at his coronation; and may also concern matters military, or services of honour in peace; as to be the king's butler, carver, &c. *Petty serjeanty* is where a man holds lands of the king to furnish him yearly with some small thing towards his wars; and in effect payable as rent. Though all tenures are turned into *fee-farm*, by the 12 Car. II. cap. 24. yet the honorary services of grand serjeanty still remain, being therein excepted. See **KNIGHT-SERVICE**.

SERIES, in general, denotes a continual succession of things in the same order, and having the same relation or connection with each other: in this sense we say, a series of emperors, kings, bishops, &c.

In natural history, a series is used for an order or subdivision of some class of natural bodies; comprehending all such as are distinguished from the other bodies of that class, by certain characters which they possess in common, and which the rest of the bodies of that class have not.

1. *Series*, in *Arithmetic* or *Algebra*, a rank or progression of quantities which succeed one another according to some determinate law. For example, the numbers

$$3, 5, 7, 9, 11, 13, 15, \&c.$$

constitute a series, the law of which is that each term exceeds that before it by a given number, viz. 2. Again, the numbers

$$3, 6, 12, 24, 48, 96, 192, \&c.$$

constitute a series of a different kind, each term being the product of the term before it, and the given number 2.

(2.) As the law according to which the terms of a series are formed may be infinitely varied, there may be innumerable kinds of series; we shall enumerate a few of the most common.

1. *Arithmetical Series*. The general form of a series of this kind is

$$a, a+d, a+2d, a+3d, a+4d, \&c.$$

and its law is that the difference between any two adjacent terms is the same quantity, viz. d . The first of the two preceding examples is a series of this nature.

2. *Geometrical Series*. Its general form is

$$a, ar, ar^2, ar^3, ar^4, \&c.$$

In this kind of series each term is the product of that which precedes it and a constant number r , which is called the common ratio of the terms. The second of the above examples is a particular case of a geometrical series.

3. *Harmonic Series* is that in which the first of any three of its consecutive terms is to the third, as the difference between the first and second to the difference between the second and third: hence we readily find that putting a and b for its two first terms, its general form will be

$$a, b, \frac{ab}{2a-b}, \frac{ab}{3a-2b}, \frac{ab}{4a-3b}, \&c.$$

If we suppose $a=1$ and $b=1$, we get

$$1, \frac{1}{2}, \frac{1}{3}, \frac{1}{4}, \frac{1}{5}, \frac{1}{6}, \&c.$$

as a particular example of a harmonic series.

4. *Recurring Series*. Let its terms be denoted by

$$A, B, C, D, E, F, \&c.$$

Then, we shall form a recurring series, if m and n being put for given quantities, we take

$$\begin{aligned} C &= m A + n B, & E &= m C + n D, \\ D &= m B + n C, & F &= m D + n E. \end{aligned}$$

For example, let us suppose $A=1, B=2x, m=4x^2, n=3x$; then $C=10x^2, D=38x^3, E=154x^4, F=614x^5$, so that the first six terms of the series are

$$1, 2x, 10x^2, 38x^3, 154x^4, 614x^5.$$

We have here supposed each term to be formed from the two which come immediately before it; but the name *recurring series* is given to every one in which the terms are formed in the manner from some assigned number of the terms which precede that sought. Thus,

putting as before $A, B, C, D, \&c.$ for the terms of the series, and m, n, p, q for given quantities, we shall have another recurring series, if we suppose them to be related that

$$\begin{aligned} m A + n B + p C + q D &= 0, \\ m B + n C + p D + q E &= 0, \\ m C + n D + p E + q F &= 0, \end{aligned}$$

The two series of quantities *fin. a. fin. 2 a. fin. 3 a. &c.* and *col. a. col. 2 a. col. 3 a. &c.* are both recurring, as is manifest from the law which connects the quantities one with another. (See ALGEBRA, § 358.)

(3.) As in general it is the sum of the terms of a series which is the object of investigation, it is usual to connect them by the sign $+$ or $-$, and to apply the name *series* to the expression thus formed. Accordingly

$$1+3+5+7+9+\dots+\{1+2(n-1)\}$$

(where n denotes the number of terms) is called an arithmetical series; and in like manner

$$1+\frac{1}{2}+\frac{1}{4}+\frac{1}{8}+\dots+\frac{1}{2^{n-1}}$$

is a geometrical series.

(4.) A series may either consist of a definite number of terms, or their number may be supposed greater than any that can be assigned, and in this case the series is said to be *infinite*. The number of terms of a series may be infinite, and yet their sum finite. This is true: for example, of the series

$$\frac{1}{2}+\frac{1}{4}+\frac{1}{8}+\frac{1}{16}+\dots+\&c.$$

which is equivalent to unity, or 1.

(5.) We have already treated of several branches of the doctrine of series in the articles ALGEBRA, FLUXIONS and LOGARITHMS; and in particular we have given four different methods for expanding a quantity into a series, viz.

1. By *Division* or *Evolution*. (See ALGEBRA, § 78, and § 260.)

2. By the *Method of Indeterminate Coefficients*. (ALGEBRA, § 261.)

3. By the *Binomial Theorem*. (ALGEBRA, § 263—§ 269.)

4. By *Taylor's Theorem*. (FLUXIONS, § 66—§ 72.)

We shall here treat briefly of another branch of the theory, namely, how to find the sum of any proposed number of terms of certain series, or the sum of their terms continued *ad infinitum*, when that sum is finite.

(6.) There is a great analogy between the terms of a series and the ordinates of a curve which are supposed to stand upon the axis at equal distances from one another, the first ordinate reckoned from the extremity of the axes being analogous to the first term of the series, the second ordinate to the second term, and so on. From this analogy it follows immediately, that like as the nature of a curve is indicated by an equation expressing the value of an indefinite ordinate in terms of its corresponding abscissa, so also the nature of a series may be shown by an equation which shall express the relation between any term; and the number that denotes the place or order of that term in the series. In conformity

conformity to this method, putting the symbols $T^{(1)}$, $T^{(2)}$, $T^{(3)}$, &c. to denote the terms of any series whatever, we may express it generally thus.

$$T^{(1)} + T^{(2)} + T^{(3)} + \dots + T^{(v)}$$

where the characters (1), (2), are meant to denote the place or order of the terms to which they are joined, (the first term being supposed to have the place 1, the second term the place 2, and so on) and (v) is put for any indefinite number.

The nature of the arithmetical series

$$a + (a+d) + (a+2d) + (a+3d) + \dots,$$

will be defined by the equation

$$T^{(v)} = a + (v-1)d,$$

and, in like manner, the nature of the geometrical series

$$a + ar + ar^2 + ar^3 + \dots,$$

will be expressed by the equation

$$T^{(v)} = ar^{v-1}.$$

(7.) As the expression for the value of the indefinite term $T^{(v)}$ becomes identical with all the terms of the series in succession, by substituting the numbers 1, 2, 3, &c. one after another for v , that expression is called the *general term* of the series. In the series

$$a + b + \frac{ab}{2a-b} + \frac{ab}{3a-2b} + \frac{ab}{4a-3b} + \dots,$$

the general term is evidently $\frac{ab}{(v-1)a - (v-2)b}$.

(8.) We shall now investigate the sum of any number of such series as have their general terms expressed by any one of the following algebraic functions

$$v, \frac{v(v+1)}{1 \cdot 2}, \frac{v(v+1)(v+2)}{1 \cdot 2 \cdot 3}, \frac{v(v+1)(v+2)(v+3)}{1 \cdot 2 \cdot 3 \cdot 4}, \dots$$

PROBLEM I. It is proposed to find the sum of n terms of the series of which the general term is the first function.

By putting 1, 2, 3, &c. to v successively for v , it appears that the series to be summed is

$$1 + 2 + 3 + 4 + \dots + n.$$

Now, as $v = \frac{v(v+1)}{2} - \frac{(v-1)v}{2}$, we have, by putting in this formula 1, 2, 3, ... to n successively for v ,

$$\begin{aligned} 1 &= \frac{1 \cdot 2}{2} - 0, \\ 2 &= \frac{2 \cdot 3}{2} - \frac{1 \cdot 2}{2}, \\ 3 &= \frac{3 \cdot 4}{2} - \frac{2 \cdot 3}{2}, \\ 4 &= \frac{4 \cdot 5}{2} - \frac{3 \cdot 4}{2}, \\ &\dots \end{aligned}$$

$$\begin{aligned} n-1 &= \frac{(n-1)n}{2} - \frac{(n-2)(n-1)}{2}, \\ n &= \frac{n(n+1)}{2} - \frac{(n-1)n}{2}, \end{aligned}$$

Let the sum of the quantities on each side of the sign = be now taken; then, observing that each of the fractions on the right hand side, with the exception of $\frac{n(n+1)}{1 \cdot 2}$, occurs twice, once with the sign +, and again with the sign -, by which it happens that their aggregate is = 0, it is evident that we have

$$1 + 2 + 3 + 4 + \dots + n = \frac{n(n+1)}{1 \cdot 2}.$$

PROB. II. It is proposed to sum n terms of the series having for its general term the second function

$$\frac{v(v+1)}{1 \cdot 2}.$$

This series, by substituting 1, 2, 3, &c. successively for v , is found to be

$$\frac{1 \cdot 2}{1 \cdot 2} + \frac{2 \cdot 3}{1 \cdot 2} + \frac{3 \cdot 4}{1 \cdot 2} + \dots + \frac{n(n+1)}{1 \cdot 2}.$$

We now, following the mode of proceeding employed in last problem, put the expression $\frac{v(v+1)}{1 \cdot 2}$ under this form,

$$\frac{v(v+1)(v+2)}{1 \cdot 2 \cdot 3} - \frac{(v-1)v(v+1)}{1 \cdot 2 \cdot 3},$$

to which it is evidently equivalent, and, substituting 1, 2, 3, &c. successively for v , find

$$\begin{aligned} \frac{1 \cdot 2}{1 \cdot 2} &= \frac{1 \cdot 2 \cdot 3}{1 \cdot 2 \cdot 3} - 0, \\ \frac{2 \cdot 3}{1 \cdot 2} &= \frac{2 \cdot 3 \cdot 4}{1 \cdot 2 \cdot 3} - \frac{1 \cdot 2 \cdot 3}{1 \cdot 2 \cdot 3}, \\ \frac{3 \cdot 4}{1 \cdot 2} &= \frac{3 \cdot 4 \cdot 5}{1 \cdot 2 \cdot 3} - \frac{2 \cdot 3 \cdot 4}{1 \cdot 2 \cdot 3}, \\ \frac{4 \cdot 5}{1 \cdot 2} &= \frac{4 \cdot 5 \cdot 6}{1 \cdot 2 \cdot 3} - \frac{3 \cdot 4 \cdot 5}{1 \cdot 2 \cdot 3}, \\ &\dots \end{aligned}$$

$$\frac{v(v+1)}{1 \cdot 2} = \frac{v(v+1)(v+2)}{1 \cdot 2 \cdot 3} - \frac{(v-1)v(v+1)}{1 \cdot 2 \cdot 3}.$$

In this problem, as in the former, it appears that each quantity on the right side of the equation, except $\frac{n(n+1)(n+2)}{1 \cdot 2 \cdot 3}$, occurs twice, and with contrary signs: therefore, taking the aggregate of the terms on each side, we have

$$\begin{aligned} \frac{1 \cdot 2}{1 \cdot 2} + \frac{2 \cdot 3}{1 \cdot 2} + \frac{3 \cdot 4}{1 \cdot 2} + \frac{4 \cdot 5}{1 \cdot 2} + \dots + \frac{n(n+1)}{1 \cdot 2} \\ = \frac{n(n+1)(n+2)}{1 \cdot 2 \cdot 3}. \end{aligned}$$

(9.) It will be obvious, by a little attention to the relations of these two problems, that in each the terms of the series to be summed are the differences between the adjacent

Series. adjacent terms of another series, namely, that which has for its general term the function next in order to the general term of the series under consideration; that is, the terms of the series whose general term is v , are the differences betwixt those of the series having $\frac{v(v+1)}{1 \cdot 2}$ for its general terms; and, again, the terms of this last are the differences of the terms of the series having $\frac{v(v+1)(v+2)}{1 \cdot 2 \cdot 3}$ for its general term. Now as the sum of the differences of any series of quantities whatever which begins with 0 must necessarily be the last term of that series, it follows, that the sum of all the terms of each of the series we have considered must be equal to the last term of the next following series; and this term is necessarily the expression formed by substituting n for v in its general term, that is, the sum of the series $1+2+3+\dots+n$, which has v for its general term, is $\frac{n(n+1)}{1 \cdot 2}$; and the sum of the series

$$\frac{1 \cdot 2}{1 \cdot 2} + \frac{2 \cdot 3}{1 \cdot 2 \cdot 3} + \frac{3 \cdot 4}{1 \cdot 2 \cdot 3} + \dots + \frac{n(n+1)}{1 \cdot 2 \cdot 3}$$

$$\text{is } \frac{n(n+1)(n+2)}{1 \cdot 2 \cdot 3}.$$

The next series which has $\frac{v(v+1)(v+2)}{1 \cdot 2 \cdot 3}$ for its general term, as well as all that succeed, will be found to have the very same property, as may be proved as follows. Let p denote any term of the series of natural numbers 1, 2, 3, &c. Then, because

$$\frac{v+p}{p+1} - \frac{v-1}{p+1},$$

if we multiply these equals by the product of all the factors $v, \frac{v+1}{2}, \frac{v+2}{3}, \dots, \frac{v+p-1}{p}$, we get

$$\frac{v(v+1)(v+2)\dots(v+p-1)}{1 \cdot 2 \cdot 3 \dots p}$$

$$= \left\{ \begin{array}{l} \frac{v(v+1)(v+2)\dots(v+p)}{1 \cdot 2 \cdot 3 \dots (p+1)} \\ - \frac{(v-1)v(v+1)\dots(v+p-1)}{1 \cdot 2 \cdot 3 \dots (p+1)} \end{array} \right.$$

Now, if in this identical equation we substitute the numbers 1, 2, 3, &c. to n successively for v , the results obtained from its first member

$$\frac{v(v+1)(v+2)\dots(v+p-1)}{1 \cdot 2 \cdot 3 \dots p}$$

will be a series having this function for its general term, and the terms of which will evidently be the difference between the terms of another series having the first part of the second member of the equation, viz.

$$\frac{v(v+1)(v+2)\dots(v+p)}{1 \cdot 2 \cdot 3 \dots (p+1)},$$

for its general term: Hence it will happen, as in the two foregoing problems, that the sum of all the terms of the former series will be equal to the last term of the latter; which conclusion may be expressed in the form of a theorem, as follows:

THEOREM. *The sum of n terms of a series having for its general term the function,*

$$\frac{v(v+1)(v+2)\dots(v+p-1)}{1 \cdot 2 \cdot 3 \dots p}$$

is equal to

$$\frac{n(n+1)(n+2)\dots(n+p)}{1 \cdot 2 \cdot 3 \dots (p+1)}.$$

Or, setting aside the denominators of the terms, we may express the theorem thus: *The sum of n terms of a series, having for its general term the expression*

is equal to

$$\frac{n(n+1)(n+2)\dots(n+p)}{p+1}.$$

We shall here give a few particular cases of this last general formula.

I. $1+2+3+4+\dots+n = \frac{n(n+1)}{2}.$

II. $1 \cdot 2+2 \cdot 3+3 \cdot 4+4 \cdot 5+\dots+n(n+1) = \frac{n(n+1)(n+2)}{3}.$

III. $1 \cdot 2 \cdot 3+2 \cdot 3 \cdot 4+3 \cdot 4 \cdot 5+\dots+n(n+1)(n+2) = \frac{n(n+1)(n+2)(n+3)}{4}.$

(10.) By means of the above general theorem we may find the sum of any number of terms of a series composed of the powers of the terms of an arithmetical progression, the general term of which will, in the simplest case, be v^p , p being a given number. The manner of doing this will appear from the following problems.

PROB. III. It is proposed to find the sum of n terms of the series of squares $1+4+9+16+25+\dots$ or $1^2+2^2+3^2+4^2+5^2+\dots$ &c.

The general term of this series being v^2 , we put it under this form, $v(v+1)-v$; hence we get by substituting 1, 2, 3, &c. for v ,

$$1^2 = 1 \cdot 2 - 1,$$

$$2^2 = 2 \cdot 3 - 2,$$

$$3^2 = 3 \cdot 4 - 3,$$

$$4^2 = 4 \cdot 5 - 4,$$

$$\dots$$

$$n^2 = n(n+1) - n.$$

Therefore adding, we find

$$1^2+2^2+3^2+4^2+\dots+n^2 = \left\{ \begin{array}{l} 1 \cdot 2+2 \cdot 3+3 \cdot 4+4 \cdot 5+\dots+n(n+1) \\ - (1+2+3+4+\dots+n) \end{array} \right.$$

But

³ For example, let the quantities be a, a, b, c, d ; then it is manifest that $(a-a) + (b-a) + (c-b) + (d-c) = d.$

Series. But by the general theorem (9.)

$$1 \cdot 2 + 2 \cdot 3 + 3 \cdot 4 + \dots + n(n+1) = \frac{n(n+1)(n+2)}{3},$$

and, $1 + 2 + 3 + 4 + \dots + n = \frac{n(n+1)}{2};$

therefore $\frac{1^3 + 2^3 + 3^3 + 4^3 + \dots + n^3}{n(n+1)(n+2)} = \frac{n(n+1)}{3} \cdot \frac{n(n+1)}{2}$
 $= \frac{n(n+1)(2n+1)}{6}.$

We might have arrived at the same conclusion by considering that since v^3 , the general term of the series, is equivalent to $v(v+1) - v$, the series must be the difference between two others, one having $v(v+1)$ and the other v for its general term; for the sake of perspicuity, however, we have put down the terms of all the three series.

PROP. IV. It is proposed to find the sum of n terms of the series

$$1^3 + 2^3 + 3^3 + 4^3 + 5^3 + \&c.$$

The general term in this case is v^3 ; now to transform this function, so as to deduce the sum of the series from the general theorem, we assume

$$v^3 = v(v+1)(v+2) + A v(v+1) + B v,$$

where A and B denote quantities which are to have such values as shall render the two sides of the equation identical whatever be the value of v , taking now the product of the factors, we have

$$v^3 = v^3 + (A+3)v^2 + (A+B+2)v,$$

Therefore, by the theory of indeterminate coefficients, (ALGEBRA, § 261.)

$$A + 3 = 0, \quad A + B + 2 = 0:$$

Hence we find $A = -3$, $B = -A - 2 = 1$; thus it appears that v being any number whatever,

$$v^3 = v(v+1)(v+2) - 3v(v+1) + v.$$

Now, let S denote the sum of n terms of the series under consideration, which has v^3 for its general term, and put P, Q, R for the like sums of the three series, whose general terms are the functions $v(v+1)(v+2)$, $v(v+1)$ and v respectively; then, it is evident that $S = P - 3Q + R$. But by the theorem, (9.)

$$P = \frac{n(n+1)(n+2)(n+3)}{4},$$

$$Q = \frac{n(n+1)(n+2)}{3},$$

$$R = \frac{n(n+1)}{2},$$

therefore, $S = \frac{n(n+1)(n+2)(n+3)}{4}$

$$- n(n+1)(n+2) + \frac{n(n+1)}{2},$$

and by proper reduction, S , or

$$1^3 + 2^3 + 3^3 + 4^3 + \dots + n^3 = \frac{n^2(n+1)^2}{4}$$

Corollary. We have found (PROP. I.) that

$$1 + 2 + 3 + 4 + \dots + n = \frac{n(n+1)}{2},$$

therefore, comparing this with the result just now obtained, it is evident that

$$(1 + 2 + 3 + 4 + \dots + n)^2 = 1^3 + 2^3 + 3^3 + 4^3 + \dots + n^3;$$

this is a very curious and elegant property of numbers.

(11.) It is manifest that by the mode of proceeding employed in last problem we may investigate the sum of n terms of the series

$$1^m + 2^m + 3^m + 4^m + \&c.$$

m being any whole positive number whatever; and indeed in the very same way we may find the sum of any number of terms of a series, whose general term is

$$a + b v + c v^2 + d v^3 + \&c.$$

where a and b , &c. denote given numbers; namely, by transforming it into a function of the form

$$A + B v + C v(v+1) + D v(v+1)(v+2) + \&c.$$

where A, B , and C , &c. denote constant quantities. Our limits, however, will not allow us to go into particulars.

(12.) The next class of series we shall consider, comprehends such as may be formed by the successive substitution of $a, a+1, a+2$, &c. (a being put for any given quantity whatever) in the series of junctions

$$\frac{1}{v(v+1)}, \frac{1}{v(v+1)(v+2)}, \frac{1}{v(v+1)(v+2)(v+3)}, \&c.$$

We shall begin with the first of these.

PROP. V. It is proposed to find the sum of n terms of the series

$$\frac{1}{a(a+1)} + \frac{1}{(a+1)(a+2)} + \frac{1}{(a+2)(a+3)} + \&c.$$

which is formed by substituting $a, a+1, a+2$, &c. successively for v in the general term $\frac{1}{v(v+1)}$.

Whatever be the value of v , we have

$$\frac{1}{v(v+1)} = \frac{1}{v} - \frac{1}{v+1},$$

therefore, proceeding as in the foregoing problems, we get

$$\frac{1}{a(a+1)} = \frac{1}{a} - \frac{1}{a+1},$$

$$\frac{1}{(a+1)(a+2)} = \frac{1}{a+1} - \frac{1}{a+2},$$

$$\frac{1}{(a+2)(a+3)} = \frac{1}{a+2} - \frac{1}{a+3},$$

$$\dots \dots \dots \frac{1}{(a+n-2)(a+n-1)} = \frac{1}{a+n-2} - \frac{1}{a+n-1},$$

$$\frac{1}{(a+n-1)(a+n)} = \frac{1}{a+n-1} - \frac{1}{a+n}.$$

Here it is evident that the terms of the series to be summed

Summed are the differences betwixt every two adjoining terms of this other series.

$$\frac{1}{a} + \frac{1}{a+1} + \frac{1}{a+2} + \frac{1}{a+3} \dots + \frac{1}{a+n};$$

Hence it immediately follows, that the sum of all the terms of the former is the difference between the two extreme terms of the latter; that is

$$\frac{1}{a(a+1)} + \frac{1}{(a+1)(a+2)} \dots + \frac{1}{(a+n-1)(a+n)} \\ = \frac{1}{a} - \frac{1}{a+n}.$$

If we suppose the series to be continued *ad infinitum*, then, as n will be indefinitely great, and $\frac{1}{a+n}$ indefinitely small, the sum will be simply $\frac{1}{a}$; or in other words, the fraction $\frac{1}{a}$ is a limit to the sum of the series.

PROB. VI. Let it be required to find the sum of n terms of this series.

$$\frac{1}{a(a+1)(a+2)} + \frac{1}{(a+1)(a+2)(a+3)} + \\ \frac{1}{(a+2)(a+3)(a+4)} + \text{&c.}$$

the general term in this case being $\frac{1}{v(v+1)(v+2)}$.

Because $\frac{2}{v(v+2)} = \frac{1}{v} - \frac{1}{v+2}$, therefore, multiplying by $\frac{1}{2(v+1)}$, we have

$$\frac{1}{v(v+1)(v+2)} = \frac{1}{2} \left\{ \frac{1}{v(v+1)} - \frac{1}{(v+1)(v+2)} \right\},$$

and hence, by substituting $a, a+1, a+2, \text{&c.}$ successively for v ,

$$\frac{1}{a(a+1)(a+2)} = \frac{1}{2} \left\{ \frac{1}{a(a+1)} - \frac{1}{(a+1)(a+2)} \right\},$$

$$\frac{1}{(a+1)(a+2)(a+3)} = \frac{1}{2} \left\{ \frac{1}{(a+1)(a+2)} - \frac{1}{(a+2)(a+3)} \right\},$$

$$\frac{1}{(a+2)(a+3)(a+4)} = \frac{1}{2} \left\{ \frac{1}{(a+2)(a+3)} - \frac{1}{(a+3)(a+4)} \right\},$$

$$\frac{1}{(a+3)(a+4)(a+5)} = \frac{1}{2} \left\{ \frac{1}{(a+3)(a+4)} - \frac{1}{(a+4)(a+5)} \right\},$$

$$\dots$$

$$\frac{1}{(a+n-1)(a+n)(a+n+1)}$$

$$= \frac{1}{2} \left\{ \frac{1}{(a+n-1)(a+n)} - \frac{1}{(a+n)(a+n+1)} \right\}.$$

Hence it appears that the terms of the series to be summed are the halves of the differences of the terms of the

$$\frac{1}{a(a+1)} + \frac{1}{(a+1)(a+2)} + \frac{1}{(a+2)(a+3)} \dots \\ + \frac{1}{(a+n)(a+n+1)};$$

consequently, the sum of all the terms of the former is half the difference between the extreme terms of the latter, or is =

$$\frac{1}{2} \left\{ \frac{1}{a(a+1)} - \frac{1}{(a+n)(a+n+1)} \right\}.$$

(13.) From these two particular cases it is easy to see how we may sum the series when the general term is

$$\frac{1}{v(v+1)(v+2) \dots (v+p)},$$

ρ being any whole number whatever: for since

$$\frac{\rho}{v(v+\rho)} = \frac{1}{v} - \frac{1}{v+\rho},$$

therefore, multiplying the denominators by all the factors which are intermediate between v and $v+\rho$, we have

$$\frac{\rho}{v(v+1)(v+2) \dots (v+\rho)} = \\ \frac{1}{v(v+1)(v+2) \dots (v+\rho-1)} - \\ \frac{1}{(v+1)(v+2)(v+3) \dots (v+\rho)}.$$

Now the latter side of this equation is a general expression for the difference between any two adjacent terms of a series whose general term is

$$\frac{1}{v(v+1)(v+2) \dots (v+p-1)},$$

therefore the difference between the first and last terms of this series must be the sum of the series whose general term is the function on the other side of the equation, viz.

$$\frac{\rho}{v(v+1)(v+2) \dots (v+\rho)}.$$

Hence we have the following very general theorem.

THEOREM. Let a denote any number whatever, and let $1, 2, 3, \dots, p$ be a series of numbers, each of which exceeds that before it by unity; the sum of n terms of a series formed by substituting the numbers $a, a+1, a+2, \text{&c.}$ to $a+p-1$ successively for v in the function

$$\frac{1}{v(v+1)(v+2) \dots (v+p)}$$

is equal to

$$\left\{ \frac{1}{a(a+1)(a+2) \dots (a+p-1)} - \frac{1}{(a+n)(a+n+1)(a+n+2) \dots (a+n+p-1)} \right\}.$$

(COROLLARY.)

is equal to

$$\frac{1}{\rho} \frac{1}{a(a+1)(a+2)\dots(a+\rho-1)}$$

(14.) We shall now give a few examples of the application of this theorem.

Example 1. Required the sum of n terms of the series,

$$\frac{1}{2 \cdot 3 \cdot 4 \cdot 5} + \frac{1}{3 \cdot 4 \cdot 5 \cdot 6} + \frac{1}{4 \cdot 5 \cdot 6 \cdot 7} + \&c.$$

The terms of this series are evidently produced by the successive substitution of the numbers 2, 3, 4, 5, &c. for v in the function

$$\frac{1}{v(v+1)(v+2)(v+3)}$$

therefore, comparing this expression with the general formula, we have $a=2, \rho=3$, and the sum required

$$= \frac{1}{3} \left\{ \frac{1}{2 \cdot 3 \cdot 4} - \frac{1}{(2+n)(3+n)(4+n)} \right\}.$$

Ex. 2. Required the sum of the series

$$\frac{1}{1 \cdot 4 \cdot 7} + \frac{1}{4 \cdot 7 \cdot 10} + \frac{1}{7 \cdot 10 \cdot 13} + \frac{1}{10 \cdot 13 \cdot 16} + \&c.$$

continued ad infinitum.

By a little attention it will appear that its terms are produced by the substitution of the numbers $\frac{1}{2}, 1\frac{1}{2}, 2\frac{1}{2}, \&c.$ successively for v in the function

$$\frac{1}{3v(v+3)(3v+6)} = \frac{1}{27v(v+1)(v+2)}$$

In this case then $a=\frac{1}{2}, \rho=2$, therefore the sum is

$$\frac{1}{2} \times \frac{1}{27} \frac{1}{\frac{1}{2} \times 1\frac{1}{2}} = \frac{1}{24}.$$

(15.) When the function from which the series is derived has not the very form required in the theorem, it may be brought to that form by employing suitable transformations, as in the two following examples.

Ex. 3. It is proposed to find the sum of the series

$$\frac{1}{1 \cdot 4} + \frac{1}{2 \cdot 5} + \frac{1}{3 \cdot 6} + \frac{1}{4 \cdot 7} + \&c.$$

continued ad infinitum.

This series is evidently formed by the substitution of the numbers 1, 2, 3, &c. successively for v in the function $\frac{1}{v(v+3)}$. This expression, however, does not in its present form agree with the general formula, because the factors $v+1, v+2$ are wanting; therefore to transform it, we multiply its numerator and denominator by $(v+1)(v+2)$, and it becomes

$$\frac{(v+1)(v+2)}{v(v+1)(v+2)(v+3)}$$

we next assume its numerator

VOL. XIX. PART I.

$(v+1)(v+2) = A(v+2)(v+3) + B(v+3) + C,$
and by multiplying get

$$v^2 + 3v + 2 = Av^2 + (5A+B)v + (6A+3B+C);$$

therefore, that v may be indeterminate, we must make

$$A=1, 5A+B=3, 6A+3B+C=2,$$

from which equations we get $A=1, B=3-5A=-2, C=2-6A-3B=2$, so that

$$\begin{aligned} \frac{1}{v(v+3)} &= \frac{(v+2)(v+2) - 2(v+2) + 2}{v(v+1)(v+2)(v+3)} \\ &= \frac{1}{v(v+1)} - \frac{2}{v(v+1)(v+2)} \\ &\quad + \frac{2}{v(v+1)(v+2)(v+3)} \end{aligned}$$

Thus it appears that the proposed series is resolvable into three others, the general terms of which all agree with the theorem. Now the sum of the infinite series whose general term is $\frac{1}{v(v+1)}$ appears by the theorem

to be $\frac{1}{a}$, or 1, because $a=1$, and the sum of the infinite series whose general term is $\frac{-2}{v(v+1)(v+2)}$ is in like

manner found to be $\frac{-2}{2} + \frac{1}{2} = \frac{-1}{2}$; and lastly, the infinite series whose general term is $\frac{2}{v(v+1)(v+2)(v+3)}$

is $\frac{2}{3} \frac{1}{1 \cdot 2 \cdot 3} = \frac{1}{9}$; therefore, collecting these into one,

the sum of the proposed series is $1 - \frac{1}{2} + \frac{1}{9} = \frac{11}{18}$, the answer.

Ex. 4. Required the sum of the infinite series.

$$\frac{1}{2 \cdot 3 \cdot 4} + \frac{2}{3 \cdot 4 \cdot 5} + \frac{3}{4 \cdot 5 \cdot 6} + \frac{4}{5 \cdot 6 \cdot 7} + \&c.$$

The terms of this series are evidently formed by the substitution of the numbers 2, 3, 4, successively in the function

$$\frac{v-1}{v(v+1)(v+2)}$$

Now $v-1 = v+2-3$; therefore,

$$\frac{v-1}{v(v+1)(v+2)} = \frac{1}{v(v+1)} - \frac{3}{(v+1)(v+2)}$$

thus it appears that the proposed series is reducible to two others, one having its terms produced by the substitution of 2, 3, &c. for v in the function $\frac{1}{v(v+1)}$, and the other by a like substitution in the function

$\frac{-3}{v(v+1)(v+2)}$. Now, by our theorem, the sum of

the first of these is $\frac{1}{2}$, and that of the second is $\frac{-3}{2}$.

Z.

$\frac{1}{2 \cdot 3}$

Series, $\frac{1}{2 \cdot 3} = \frac{1}{4}$, therefore the sum of the proposed series is

$$\frac{1}{2} - \frac{1}{4} = \frac{1}{4}$$

From these examples it is sufficiently evident how the theorem is to be applied in other cases; and it appears also that by means of it we can sum any series whatever whose general term is of the form

$$\frac{A}{v(1+v)} + \frac{B}{v(1+v)(v+1)} + \frac{C}{v(v+1)(v+2)(v+3)} + \dots$$

or admits of being reduced to that form.

(16.) It deserves to be remarked that the series

$$\frac{1}{1} + \frac{1}{2} + \frac{1}{3} + \frac{1}{4} + \frac{1}{5} + \dots, \&c.$$

which is of a very simple form, and in appearance of the same nature as those we have summed, does not however admit of being treated in the same manner; and indeed, if it be continued *ad infinitum*, its sum is infinite, that is, it exceeds any number which can be assigned. The truth of this assertion will be evident if we can show that a certain definite number of its terms, beginning with any proposed term, can always be found, the sum of which shall exceed an unit or 1; for this being the case, as we can go on continually in assigning such sets of terms, we can conceive as many to be taken as there are units in any proposed number however great; and therefore their sum, and much more the sum of all the terms of the series from its beginning to the end of the last sets of terms will exceed that number. Now that this can always be done may be proved as follows:

Let the term of the series from which we are to reckon be $\frac{1}{a}$, then, if the thing be possible, and if n be the requisite number of terms, we must have

$$\frac{1}{a} + \frac{1}{a+1} + \frac{1}{a+2} + \frac{1}{a+3} \dots + \frac{1}{a+n-1} > 1.$$

Now because

$$a \left(1 + \frac{1}{a}\right) = a + 2 + \frac{1}{a},$$

$$a \left(1 + \frac{1}{a}\right)^2 = a + 3 + \frac{2}{a} + \frac{1}{a^2},$$

and in general,

$$a \left(1 + \frac{1}{a}\right)^p = a + p + \frac{p \cdot p - 1}{1 \cdot 2} \frac{1}{a} + \dots, \&c.$$

therefore, p being any whole number,

$$a \left(1 + \frac{1}{a}\right)^p > a + p, \text{ and consequently}$$

$$\frac{1}{a+p} > \frac{1}{a \left(1 + \frac{1}{a}\right)^p};$$

Hence it follows that the series

$$\frac{1}{a} + \frac{1}{a+1} + \frac{1}{a+2} \dots + \frac{1}{a+n-1}$$

will be greater than the other series

$$\frac{1}{a} + \frac{1}{a \left(1 + \frac{1}{a}\right)} + \frac{1}{a \left(1 + \frac{1}{a}\right)^2} + \frac{1}{a \left(1 + \frac{1}{a}\right)^3} \dots$$

$$+ \frac{1}{a \left(1 + \frac{1}{a}\right)^{n-1}}.$$

Now this last being evidently a geometrical series, of which the common ratio is $\frac{1}{1 + \frac{1}{a}}$, its sum is

$$1 + \frac{1}{a} - \frac{1}{\left(1 + \frac{1}{a}\right)^{n-1}};$$

therefore, the sum of the series

$$\frac{1}{a} + \frac{1}{a+1} + \frac{1}{a+2} + \frac{1}{a+3} \dots + \frac{1}{a+n-1}$$

will always be greater than this expression; but if we suppose n to be so great that the quantity $\left(1 + \frac{1}{a}\right)^{n-1}$ is equal to, or exceeds a , which is evidently always possible, then the above expression for the sum of the geometrical series will be equal to 1, or will exceed 1; therefore, the same number of terms of the series $\frac{1}{a} + \frac{1}{a+1} + \frac{1}{a+2} + \frac{1}{a+3} + \dots$ will always exceed 1; now this is the property of the series we proposed to demonstrate.

When $a = \left(1 + \frac{1}{a}\right)^{n-1}$, then $a^2 = a \left(1 + \frac{1}{a}\right)^{n-1}$, but this quantity is greater than $a+n-1$ the denominator of the last term of the series

$$\frac{1}{a} + \frac{1}{a+1} + \frac{1}{a+2} + \frac{1}{a+3} \dots + \frac{1}{a+n-1},$$

the sum of which, we have proved, will upon that hypothesis exceed unity; much more then will the sum exceed unity if we suppose the series continued until the denominator of its last term be equal to, or greater than a^2 .

Hence, beginning with the term $\frac{1}{2}$, it appears that

$$\frac{1}{2} + \frac{1}{4} + \frac{1}{4=2^2} > 1,$$

$$\frac{1}{3} + \frac{1}{6} \dots + \frac{1}{2 \cdot 3=3^2} > 1,$$

$$\frac{1}{4} + \frac{1}{8} \dots + \frac{1}{6 \cdot 7=6 \cdot 2 \cdot 3} > 1,$$

$$\frac{1}{5} + \frac{1}{10} \dots + \frac{1}{4 \cdot 5 \cdot 8 \cdot 3 \cdot 2 \cdot 9=6 \cdot 7 \cdot 7} > 1,$$

&c.

Although the sum of the series we have been considering is infinite, yet it evidently increases very slowly; indeed it is a limit to all such as have a finite sum; for

every

Series.

every infinite series, the terms of which decrease faster than the reciprocals of an arithmetical progression, is always finite.

(17.) We have already explained what is meant by a *recurring series*, (2.) we shall now treat briefly, first, of their origin, next of the way in which they may be formed, and lastly, of the manner of determining the *general term* of any particular series.

The series which is produced by the development of a rational algebraic fraction has always the property which constitutes the characteristic of the class called *Recurring*, (2.) and on the other hand, any series having that property being proposed, an algebraic fraction may be found by the expansion of which the series shall be produced.

The fraction $\frac{1+x^2y}{1-xy}$, for example, by dividing the numerator by the denominator is converted into the infinite series.

$$1 + 3x + 4x^2 + 7x^3 + 11x^4 + 18x^5 + \&c.$$

which is of such a nature that if T, T', T'' denote any three of its succeeding terms, their relation to one another is expressed by the equation

$$T'' = T'x + T'x.$$

If we employ algebraic division to convert the fraction into a series, the law of its terms will not appear so readily as if we use the method of indeterminate coefficients. By this method we assume the fraction

$$= A + Bx + Cx^2 + Dx^3 + Ex^4 + \&c.$$

and hence, multiplying by the denominator, and bringing all the terms to one side, as explained in ALGEBRA, § 261, we have

$$\begin{matrix} A+B \\ -1-A \end{matrix} \begin{matrix} +C \\ -B \end{matrix} \begin{matrix} +D \\ -C \end{matrix} \begin{matrix} +E \\ -D \end{matrix} x^3 + \&c. = 0,$$

and hence,

$$\begin{matrix} A-1=0, & C-B-A=0, \\ B-A-x=0, & D-C-B=0, \\ & \&c. \end{matrix}$$

From these equations it appears that the law of the series is such as we have assigned.

The equation expressing the relation which subsists among a certain number of succeeding terms of a recurring series, is called its *scale of Relation*. The same name is also sometimes given to the equation expressing the connection of the coefficients of the terms. Thus the scale of relation of the foregoing series is either

$$T'' = T'x + T'x,$$

where $T, T',$ and T'' denote any three succeeding terms of the series, or it is

$$R = P + Q,$$

where P, Q and R denote their numeral coefficients.

(18.) We come next to show how the sum of any proposed number of terms of a recurring series may be found. Let the series continued to n terms be

$$T + T' + T'' + \dots + T^{n-3} + T^{n-2} + T^{n-1},$$

where the characters $T, T', \&c.$ denote the successive terms, and the numbers (1, 2, &c.) their order

or place; and as whatever number of terms is contained in the scale, the manner of forming the series is the same, we shall in what follows, for the sake of brevity, suppose that it consists of three, in which case it may be expressed thus,

$$pT^{n-1} + qT^{n-2} + rT^{n-3} = 0,$$

where p, q, r denote certain given quantities.

The scale of relation affords the following series of equations,

$$\begin{aligned} pT^1 + qT^2 + rT^3 &= 0, \\ pT^2 + qT^3 + rT^4 &= 0, \\ pT^3 + qT^4 + rT^5 &= 0, \\ \dots\dots\dots \\ pT^{n-2} + qT^{n-1} + rT^n &= 0. \end{aligned}$$

Taking now the sum of these equations, we get

$$\left. \begin{aligned} p(T^1 + T^2 + T^3 + \dots + T^{n-1}) \\ + q(T^2 + T^3 + T^4 + \dots + T^{n-1}) \\ + r(T^3 + T^4 + T^5 + \dots + T^{n-1}) \end{aligned} \right\} = 0.$$

But, putting s for the sum of n terms of the series, this equation may manifestly be expressed thus,

$$\left. \begin{aligned} p(s - T^n) - (T - T^{n-1}) \\ + q(s - T^n) - (T - T^{n-1}) \\ + r(s - T^n) - (T - T^{n-1}) \end{aligned} \right\} = 0.$$

Hence, after reduction, we find $s =$

$$\frac{p(T^{n-1} + T^n) + q(T^1 + T^{n-1}) + r(T^1 + T^{n-1})}{p + q + r}.$$

From which it appears that in this case the sum depends only on the two first and the two last terms of the series.

EXAMPLE. It is proposed to find from this formula the sum of n terms of the series

$$1 + 2x + 3x^2 + 4x^3 + 5x^4 + \&c.$$

its scale of relation being

$$x^2 T^{n-2} - 2x T^{n-1} + T^n = 0.$$

Here $p = x^2, q = -2x, r = 1$, therefore, observing that the last two terms of the series must be $(n-1)x^{n-2}$ and nx^{n-1} , we have, after substituting and reducing,

$$\frac{1 - (n+1)x^n + nx^{n+1}}{1 - 2x + x^2}.$$

This formula will not apply in the case of $x=1$, because then the numerator and denominator are each $= 0$; but in such cases as this we may find the value of the fraction which expresses the sum by what is delivered at § 92, FLUXIONS.

(19.) The process by which we have determined the value of n terms of the series $T + T' + T'' + \&c.$ will also apply to the finding the rational fraction from which the series may be deduced, which is also the sum of the series continued *ad infinitum*. For in this case the equation from which we have deduced the sum being

$$\left. \begin{aligned} p(T + T' + T'' + \&c.) \\ + q(T + T' + T'' + \&c.) \\ + r(T + T' + T'' + \&c.) \end{aligned} \right\} = 0.$$

dat

$$f = (p+q)T + r + (p-T)(1-T) = 0,$$

we have

$$= \frac{(q+r)T + r + rT(1-T)}{p+q+r}.$$

For example, let it be required to find the fraction, each being developed produces the series

$$1 + 2x + 3x^2 + 4x^3 + \dots \&c.$$

The rule of relation of which is

$$x^2 T + x - 2xT + 1 - T = 0.$$

Here $p=2$, $q=1$, $r=1$, $T_1=1$, $T_2=2x$; therefore, substituting in the formula, we get

$$\frac{1}{1-2x+x^2} = \frac{1}{(1-x)^2}$$

for the fraction required, or for the sum of the series continued *ad infinitum*.

(25.) We come now to the last branch of the theory of recurring series which we proposed to consider, namely, how to find in any case the *general term*.

We shall begin with the most simple, and suppose the fraction to be $\frac{a}{1-\rho x}$, which being expanded into a series by division, is

$$a + a\rho x + a\rho^2 x^2 + a\rho^3 x^3 + \dots \&c.$$

here it is immediately manifest that the general term is $a\rho^{n-1} x^{n-1}$.

Next let us suppose the fraction to be $\frac{a+bx}{1-\alpha x-\beta x^2}$.

Let the two roots of the quadratic equation $1-\alpha x-\beta x^2=0$ be $x=\frac{1}{\rho}$, $x=\frac{1}{q}$, so that $1-\rho x=0$, and $1-qx=0$; therefore, $1-\alpha x-\beta x^2=(1-\rho x)(1-qx)$, thus, we have

$$\frac{a+bx}{1-\alpha x-\beta x^2} = \frac{a+bx}{(1-\rho x)(1-qx)}$$

Let us assume this expression equal to

$$\frac{P}{1-\rho x} + \frac{Q}{1-qx},$$

where P and Q denote quantities which are to be independent of x , then, reducing to a common denominator, we have

$$\frac{a+bx}{(1-\rho x)(1-qx)} = \frac{P+Q-(qP+\rho Q)x}{(1-\rho x)(1-qx)}.$$

Hence, that x may remain indeterminate, we must make

$$P+Q = a, \quad qP+\rho Q = -b,$$

and from these equations we get

$$P = \frac{a\rho+b}{\rho-q}, \quad Q = -\frac{c\rho+b}{\rho-q}.$$

Now, by the operation of division, we find

$$\frac{P}{1-\rho x} = P + P\rho x + P\rho^2 x^2 + \dots \&c.$$

$$\frac{Q}{1-qx} = Q + Qqx + Qq^2 x^2 + \dots \&c.$$

therefore, since $\frac{a+bx}{1-\alpha x-\beta x^2} = \frac{P}{1-\rho x} + \frac{Q}{1-qx}$, it follows that the development of the fraction $\frac{a+bx}{1-\alpha x-\beta x^2}$

which proceeds according to the powers of x , is

$$(P+Q) + (P\rho+Qq)x + (P\rho^2+Qq^2)x^2 + (P\rho^3+Qq^3)x^3 + \dots \&c.$$

And here it is evident that the general term is $(P\rho^{n-1} + Qq^{n-1})x^{n-1}$.

Let us take as a particular example the fraction $\frac{1-x}{1-x-2x^2}$, which, when expanded into a series, becomes

$$1 + 0x + 2x^2 + 2x^3 + 6x^4 + 10x^5 + 22x^6 + 42x^7 + 86x^8 + \dots \&c.$$

Here, from the equation $1-x-2x^2=0$, we get $x=\frac{1}{2}$ and $x=-1$, so that $1-2x$ and $1+x$ are divisors of the function $1-x-2x^2$, that is, $1-x-2x^2=(1+x)(1-2x)$; hence $\rho=-1$, $q=2$, and since $a=1$, $b=-1$; therefore $P=\frac{2}{3}$, $Q=\frac{1}{3}$, and the general term $(P\rho^{n-1} + Qq^{n-1})x^{n-1}$ becomes by substituting

$$\left\{ \frac{2}{3}(-1)^{n-1} + \frac{1}{3}2^{n-1} \right\} x^{n-1} = \frac{2^{n-1}+(-1)^{n-1}}{3} x^{n-1},$$

where the sign $+$ is to be taken when n is an odd number; but the sign $-$ when n is even.

Sometimes the values of ρ and q will come out imaginary quantities; these, however, will be found always to destroy one another when substituted in the general term.

Let us next suppose the fraction which produces a recurring series to be

$$\frac{a+bx+cx^2}{1-\alpha x-\beta x^2-\gamma x^3}.$$

Let $x=\frac{1}{\rho}$, $x=\frac{1}{q}$, $x=\frac{1}{r}$ be the three roots of the cubic equation $1-\alpha x-\beta x^2-\gamma x^3=0$, then the denominator of the fraction will be the product of the three factors

$$1-\rho x, \quad 1-qx, \quad 1-rx.$$

We must now assume the fraction equal to the expression

$$\frac{P}{1-\rho x} + \frac{Q}{1-qx} + \frac{R}{1-rx};$$

in which P , Q , R denote quantities which are independent of x .

The three terms of this expression are next to be reduced to a common denominator and collected into one, and the coefficients of the powers of x in the numerator of the result are to be put equal to the like powers of x in the proposed fraction, we shall then have

$$P+Q+R=a,$$

$$(q+r)P+(p+r)Q+(p+q)R=-b,$$

$$q r P+p r Q+p q R=c,$$

and by these equations the values of P, Q, R may be found.

Let $\frac{P}{1-\rho x} + \frac{Q}{1-qx} + \frac{R}{1-rx}$ be now resolved into series by division; then, adding the like powers of x in each we have

$$(P+Q+R) + (P\rho+Qq+Rr)x + (P\rho^2+Qq^2+Rr^2)x^2 + \&c.$$

for the series which is the development of the fraction

$$\frac{a+bx+cx^2}{1-\rho x-\beta x^2-\gamma x^3}$$

and here the general term is evidently

$$(P\rho^{n-1}+Qq^{n-1}+Rr^{n-1})x^{n-1};$$

and in the very same manner may the general term be found in every case in which the denominator of the fraction admits of being resolved into unequal factors.

(21.) Let us now suppose the fraction to have the form $\frac{a+bx}{(1-\rho x)^2}$, the denominator being the product of two equal factors; this fraction cannot be decomposed into other fractions, the denominators of which are the simple factors of its denominator. We may, however, transform it into two, which shall have their numerators constant quantities by proceeding as follows: Assume the numerator $a+bx = P+Q(1-\rho x)$, then, that x may remain indeterminate, we must have $P+Q=a$, $-\rho Q=b$, therefore

$$Q = -\frac{b}{\rho}, \quad P = a + \frac{b}{\rho}.$$

The assumption of $a+bx = P+Q(1-\rho x)$ gives us therefore

$$\frac{a+bx}{(1-\rho x)^2} = \frac{P}{(1-\rho x)^2} + \frac{Q}{1-\rho x}.$$

Now, putting the first term of the latter side of this equation under the form $P(1-\rho x)^{-2}$, it is resolved by the binomial theorem into the series

$$P(1+2\rho x+3\rho^2x^2+4\rho^3x^3+\&c.);$$

the other fraction $\frac{Q}{1-\rho x}$ being expanded into a series is

$$Q+Q\rho x+Q\rho^2x^2+\&c.$$

Therefore, the complete development of $\frac{a+bx}{(1-\rho x)^2}$ is

$$P+Q+(2P+Q)\rho x+(3P+Q)\rho^2x^2+\&c.$$

and here the general term is manifestly $(nP+Q)\rho^{n-1}x^{n-1}$, or, substituting for P and Q their values,

$$\left\{ n\rho a + (n-1)b \right\} \rho^{n-1}x^{n-1}.$$

(22.) In general, whatever be the form of the fraction from which a recurring series is derived, to determine the general term we must decompose the fraction into others which may be as simple as possible; and provided it be rational, and the highest power of x in the numerator at least one degree less than the highest power in the denominator, it may be always decomposed into others having one or other of these two forms

$$\frac{P}{1-\rho x}, \quad \frac{Q}{(1-qx)^2},$$

in which expr. fions P, Q, ρ , and q , denote quantities independent of x . Each partial fraction gives a recurring series, the general term of which will be sufficiently obvious; and as the series belonging to the original fraction, is the sum of these series, so all its general term will be the sum of all their general terms.

We have now treated of some of the more general methods of summing series which admit of being explained by the common principles of algebra; but the subject is of great extent, and to treat of it so as to give a tolerable notion of its various branches, would require more room than could with propriety be spared on such a work as ours.

(23.) The fluxional calculus affords a method, almost the only general one we possess, of summing series. The general principles upon which it is applied may be stated briefly as follows. Since the fluent of any fluxion containing one variable quantity may always be expressed by a series, on the contrary every series may be regarded as the expression of a fluent: when any series then is proposed, we must endeavour to find the fluxional expression of which that series is the fluent; and as we can always find the fluent of a fluxion, at least by approximation, within given limits, we may thence determine, if not the exact, at least the approximate value of any infinite series. We shall now show how this principle may be applied in some particular cases.

PROBLEM I. It is proposed to find the sum of n terms of the series

$$x+2x^2+3x^3+4x^4+\dots+nx^n.$$

Let the sum be denoted by s . Then, multiplying all the terms by $\frac{x}{x}$ we have

$$\frac{sx}{x} = x+2x^2x+3x^3x+4x^4x+\dots+nx^{n+1}x$$

Let the fluent of both sides be now taken, and the result is

$$\int \frac{sx}{x} = x+x^2+x^3+x^4+\dots+x^n.$$

Now the series on the right-hand side of this equation is a geometrical progression, the sum of which is known to be $\frac{x-x^{n+1}}{1-x}$, (ALGEBRA, § 106). Therefore,

$$\int \frac{sx}{x} = \frac{x-x^{n+1}}{1-x}.$$

and, taking the fluxions,

$$\frac{s \dot{x}}{x} = \frac{\dot{x} - (n+1)v^n \dot{x} + n x^{n-1} \dot{x}}{(1-x)^2}$$

Hence we find

$$s = \frac{v - (n+1)v^{n+1} + n x^{n+2}}{(1-x)^2}$$

This result agrees with that formerly found (17.) of this article.

PROBLEM II. It is proposed to sum the infinite series

$$1 - \frac{1}{3} + \frac{1}{5} - \frac{1}{7} + \frac{1}{9} - \frac{1}{11} +, \&c.$$

We may consider this series as a particular case of the more general series,

$$x - \frac{x^3}{3} + \frac{x^5}{5} - \frac{x^7}{7} +, \&c.$$

namely, that in which $x=1$. Putting therefore the fluxion \dot{x} , and taking the fluxions, we have

$$\dot{s} = v(1-x^2 + x^4 - x^6 +, \&c.).$$

Now the series in the parenthesis is obviously the development of the rational fraction $\frac{1}{1+x^2}$ therefore,

$$\dot{s} = \frac{\dot{x}}{1+x^2}, \text{ and taking the fluent } s = \text{arc. (tan. } = x)$$

+ c, radius being unity. (FLUXIONS § 60.) Now when $x=0$, all the terms of the series vanish, so that in this case $c=0$; and as when $x=0$, arc. (tan. $=x$) $=0$; therefore c, the constant quantity added to complete the fluent is 0, and we have simply $s = \text{arc. (tan. } = x)$, and when $x=1$, then $s = \frac{1}{2}$ a quadrant $= 7853982$.

PROBLEM III. Required the sum of the infinite series

$$\frac{v}{1 \cdot 2} + \frac{x^2}{2 \cdot 3} + \frac{x^3}{3 \cdot 4} + \frac{x^4}{4 \cdot 5} +, \&c.$$

Putting s for the sum, and taking the fluxions, we get

$$\dot{s} = \frac{\dot{x}}{x^2} \left(\frac{x^2}{2} + \frac{x^3}{3} + \frac{x^4}{4} + \frac{x^5}{5} +, \&c. \right)$$

Now the series in the parenthesis is evidently equal to $-x - \text{Nap. log. (1-x)}$. (see LOGARITHMS, page 76. column 1.) therefore

$$\dot{s} = -\frac{\dot{x}}{x} - \frac{\dot{x}}{x^2} \times \text{Nap. log. (1-x)}.$$

To find the fluent, let us put v for the function $\frac{1}{x} \log. (1-x)$, then, taking its fluxion we have

$$\dot{v} = -\frac{\dot{x}}{x^2} \times \log. (1-x) - \frac{\dot{x}}{x(1-x)}$$

and $-\frac{\dot{x}}{x^2} \times \log. (1-x) = \dot{v} + \frac{\dot{x}}{x(1-x)}$

therefore, substituting, we get

$$\dot{s} = \dot{v} + \frac{\dot{x}}{x(1-x)} - \frac{\dot{x}}{x}$$

$$= \dot{v} + \frac{\dot{x}}{1-x};$$

and taking the fluents,

$$s = v - \log. (1-x) + c \\ = \frac{\log. (1-x)}{x} - \log. (1-x) + c.$$

To determine the constant quantity c , let us take $x=0$, then, in this case all the terms of the series vanish so that $s=0$, also $\log. (1-x) = \log. 1 = 0$; and since in general $\frac{\log. (1-x)}{x} = \frac{1}{x} \left(-x - \frac{x^2}{2} - \frac{x^3}{3} -, \&c. \right) = -1 - \frac{x}{2} - \frac{x^2}{3} -, \&c.$ when $x=0$, then $\frac{\log. (1-x)}{x} = -1$; therefore $c = -1 + c$, and $c = 1$;

hence it appears that

$$s = \frac{\log. (1-x)}{x} - \log. (1-x) + 1 \\ = \frac{(1-x) \log. (1-x)}{x} + 1.$$

Example, Let $x = \frac{1}{2}$, then our formula gives

$$\frac{1}{1 \cdot 2 \cdot 2} + \frac{1}{2 \cdot 3 \cdot 2^2} + \frac{1}{3 \cdot 4 \cdot 2^3} + \frac{1}{4 \cdot 5 \cdot 2^4} +, \&c. \\ = 1 - \text{Nap. log. } 2 = .3068528.$$

PROBLEM IV. Let the series to be summed be

$$1 + \frac{m}{n} x + \frac{m+1}{n+1} x^2 + \frac{m+2}{n+2} x^3 +, \&c.$$

Putting s for this series let all its terms be multiplied by x^{n-1} so that the exponent of x in each may be identical with its denominator, the result is

$$s x^{n-1} = x^{n-1} + \frac{m}{n} x^n + \frac{m+1}{n+1} x^{n+1} + \frac{m+2}{n+2} x^{n+2} +, \&c.$$

and hence taking the fluxions

$$\dot{s} x^{n-1} + (n-1) \dot{x} x^{n-2} = (n-1) \dot{x} x^{n-2} + m \dot{x} x^{n-1} \\ + (m+1) \dot{x} x^n + (m+2) \dot{x} x^{n+1} +, \&c.$$

Let both sides of this equation be now multiplied by x^{n-1} , and it becomes

$$\dot{s} x^{2n-1} + (n-1) \dot{x} x^{2n-2} = (n-1) \dot{x} x^{2n-2} + m \dot{x} x^{2n-1} \\ + (m+1) \dot{x} x^{2n} + (m+2) \dot{x} x^{2n+1} +, \&c.$$

Putting now the single character ρ for the fluxional expression which forms the first member of this equation, we get by taking the fluents of both sides,

$$\rho = \frac{n-1}{m-1} x^{n-1} + x^n + x^{n+1} + x^{n+2} +, \&c. \\ = \frac{n-1}{m-1} x^{n-1} + x^n (1 + x + x^2 + x^3 +, \&c.),$$

but the series in the parenthesis is the development of $\frac{1}{1-x}$, therefore

$$\rho = \frac{n-1}{m-1} x^{n-1} + \frac{x^n}{1-x};$$

taking

Series taking now the fluxions, and substituting instead of \dot{p} the expression it was put to represent, we get

$$\dot{x}x^{n-1} + (n-1)\dot{x}x^{n-2} \\ = (n-1)\dot{x}x^{n-2} + \frac{m\dot{x}x^{n-1}}{1-x} + \frac{\dot{x}x^n}{(1-x)^2}$$

and this, after reduction, becomes

$$\dot{x} + \frac{n-1}{x}\dot{x} = \frac{(n-1)\dot{x}}{x} + \frac{m\dot{x}}{1-x} + \frac{\dot{x}x}{(1-x)^2}$$

This fluxional equation being of the first degree, and first order, its primitive equation may be found (from the general formula given in FLUXIONS, § 182.) to be

$$x = \frac{1}{n-1} \times \int \left\{ (n-1)\dot{x}x^{n-2} + \frac{m\dot{x}x^{n-1}}{1-x} + \frac{\dot{x}x^n}{(1-x)^2} \right\};$$

and this again, by remarking that $\int (n-1)\dot{x}x^{n-2} = x^{n-1}$, and that

$$\int \frac{m\dot{x}x^{n-1}}{1-x} = \frac{m\dot{x}x^n}{n(1-x)} - \int \frac{m\dot{x}x^n}{(1-x)^2},$$

may be reduced to

$$x = 1 + \frac{m\dot{x}}{n(1-x)} + \frac{n-m}{n\dot{x}x^{n-1}} \int \frac{\dot{x}x^n}{(1-x)^2}.$$

The remaining fluent $\int \frac{\dot{x}x^n}{(1-x)^2}$ may be found by § 129. FLUXIONS, and it must be so taken, that after being multiplied by $\frac{n-m}{n\dot{x}x^{n-1}}$, it shall vanish when $x=0$; for then this hypothesis will make the whole function which expresses the value of x vanish, except its first term 1, as it ought to do.

Example. Let us suppose $n=2$, then,

$$\int \frac{\dot{x}^2 x}{(1-x)^2} = x + \frac{x}{1-x} + 2 \log. (1-x),$$

and

$$\frac{2-m}{2x} \int \frac{\dot{x}^2 x}{(1-x)^2} = \frac{(2-m)x}{2(1-x)} \\ + \frac{2-m}{x} \log. (1-x),$$

the fluent being here taken as directed. In this case then, after collecting the terms, we get x , or

$$1 + \frac{m}{2}x + \frac{m+1}{3}x^2 + \frac{m+2}{4}x^3 + \dots \\ = \frac{1}{1-x} + \frac{(2-m)}{x} \log. (1-x).$$

(24.) There is a branch of the doctrine of series which is of considerable importance in pure mathematics as well as in many physical inquiries, and in the science of astronomy; it is called the *Interpolation of series*.

To interpolate a series is to interpolate among its terms a series which shall be subject to the same law, or which shall be formed in the same manner as the original terms of the series; or in other words, it is to find the

value of one or more terms by means of others which are given, and which may be either at equal or unequal intervals from one another, the places of the given terms as well as of those sought being supposed known.

It is easy to see that this problem may be applied to the construction of logarithmic tables; for we may regard the logarithms of the natural numbers 1, 2, 3, 4, &c. *ad infinitum* as the terms of a particular series of which the numbers themselves are then the indices. Having given the logarithms of some numbers we may by interpolating deduce from them the logarithms of others.

Again, in astronomy we may consider the numbers which express the successive observed positions of a celestial body as the terms of a series, their indices being the intervals of time between the observations, and some assumed epoch, and the problem we are considering will enable us to determine the position at any instant different from the times of actual observation, provided the intervals between the observations be small, and the instant for which the position is sought not very remote from those at which the observations were made.

(25.) With a view to illustrate the nature of the problem to be resolved, let us consider some particular case, as for example the arithmetical series

$$a, a+d, a+2d, a+3d, a+4d, \&c.$$

Let t and t' be two given terms of the series, which are at any distance from one another, and let n and n' be their indices, or numbers which den. to their places in the series. Also let y be any term whatever and x its index. Then by the nature of an arithmetical series,

$$t = a + (n-1)d, \quad t' = a + (n'-1)d, \\ y = a + (x-1)d,$$

Now, as there are here three equations, each involving the quantities a and d , we may eliminate both these quantities by the common rules, (ALGEBRA, Sect. VII.) and this being done, we get

$$(x-n')(t-t) = n'-n)(y-t);$$

and hence we find this expression,

$$y = \frac{x-n'}{n-n'}t + \frac{n-n}{n-n'}t',$$

which is a general formula for interpolating any arithmetical series, and it is observable, that it is entirely independent both of the first term and common difference.

Example. The 7th term of an arithmetical series is 15, and the 12th term is 25: It is required to find the 14th term.

Here $n=7$, $n'=12$, $x=14$;

$$t=15, \quad t'=25, \quad y \text{ is sought.}$$

Therefore by the formula,

$$y = \frac{2}{5} \times 15 + \frac{3}{5} \times 25 = 21, \text{ the answer.}$$

(26.) The mode of investigation by which we have found a formula for the interpolation of an arithmetical series will apply also to others, if the law according to which the terms are formed be known; in general, however, the law of a series to be interpolated is either

not known, or it is not taken into account, and we only consider the absolute magnitudes of certain terms, and the numbers expressing their places in the series.

To resolve the problem generally with these *data*, it is usual to proceed as follows: Let a straight line, AB, and a point A in it, be assumed as given in position, and let there be taken the segments AD, AD', AD'', AD''', &c. proportional to the numbers denoting the places of the terms of a series reckoned from any term assumed as a fixed origin, and at the points D, D', D'' let there be erected perpendiculars proportional to the terms themselves. Let us now suppose a curve to pass through C, C', C'', &c. then, if it be so chosen that its curvature may vary gradually in its progress from point to point, without any very abrupt changes of inflection, and moreover, if the terms (which we may suppose to be either at equal or unequal distances) are pretty near to one another, it is easy to conceive, that if AP be taken equal to the number expressing the place of a term between C'D'', C''D''' any two others, the term itself will, if not exactly, at least be nearly expressed by PQ, the ordinate to that term.

As an infinite variety of curves may be found that shall pass through the same given points; in this respect the problem is unlimited; it is, however, convenient to assume such as are simple and tractable. The parabolic class possesses these properties, and accordingly they are commonly employed.

Let us then express the ordinates CD, C'D', C''D'', C'''D''', &c. which are the given terms of the series by

$$t, t', t'', t''', \&c.$$

and the abscissæ AD, AD', AD'', AD''', or the numbers denoting the order of the terms by

$$n, n', n'', n''', \&c.$$

Put y for PQ, a term to be interpolated, and x for AP its place. Then, considering x and y as indefinite co-ordinates, a parabolic curve that shall pass through the points C, C', C'', &c. will have for its equation

$$y = A + Bx + Cx^2 + D^3 + \&c.$$

the number of terms on the right-hand side being supposed equal to that of the given points, and A, B, C, &c. being put to denote constant quantities. To determine these we must consider that when $x = t$, then $y = t$, and that when $x = t'$, then $y = t'$ and so on, therefore, substituting the successive corresponding values of x and y we get

$$\begin{aligned} t &= A + Bt + Ct^2 + Dt^3 + \&c. \\ t' &= A + Bt' + Ct'^2 + Dt'^3 + \&c. \\ t'' &= A + Bt'' + Ct''^2 + Dt''^3 + \&c. \\ t''' &= A + Bt''' + Ct'''^2 + Dt'''^3 + \&c. \end{aligned}$$

this series of equations must be continued until their number be the same as that of the coefficient, A, B, C, D, &c. If we now consider $t, t', t'', \&c.$ and $n, n', n'', \&c.$ as known, and A, B, C, &c. as unknown quantities, we may determine these last by eliminating them one after another from the above equations, as is taught in ALGEBRA, Sect. XVII. And the values of A, B, C, &c. being thus determined and substituted in the general equation, we shall have a general expression for y in terms of x the number denoting its place and known

quantities; and this is in substance the solution originally given of the problem by Sir Isaac Newton, who proposed it in the third book of his *Principia* with a view to its application in astronomy.

A celebrated foreign mathematician (Lagrange) has, in the *Cahiers de l'Ecole Normale*, given a different form to the expression for y . He has observed that since, when x becomes $n, n', n'', n''', \&c.$ successively, then y becomes $t, t', t'', t''', \&c.$ It follows that the expression for y must have the form.

$$y = \alpha + \beta t' + \gamma t'' + \delta t''' + \&c.$$

where the quantities $\alpha, \beta, \gamma, \delta, \&c.$ must be such functions of x , that if we put $x = n$, then $\alpha = 1$ and $\beta = 0, \gamma = 0, \&c.$ and if we put $x = n'$, then $\alpha = 0, \beta = 1, \gamma = 0, \&c.$ and again, if we make $x = n''$, then $\alpha = 0, \beta = 0, \gamma = 1, \&c.$ and so on. Hence it is easy to conclude that the values of $\alpha, \beta, \gamma, \delta, \&c.$ must have the form

$$\alpha = \frac{(x-n')(x-n'')(x-n''')}{(x-n)(x-n')(x-n'')}, \&c.$$

$$\beta = \frac{(x-n)(x-n''')(x-n''')}{(n'-n)(n''-n')(n'''-n'')}, \&c.$$

$$\gamma = \frac{(x-n)(x-n')(x-n''')}{(n''-n)(n'''-n')(n''-n'')}, \&c.$$

$$\delta = \frac{(x-n)(x-n')(x-n'')}{(n''-n)(n'''-n')(n''-n'')}, \&c.$$

and here the number of factors in the numerator and denominator must be equal each to the number of given points in the curve. This formula would be found to be identical with that which may be obtained by the method indicated in last article, if we were to take the actual product of the factors and arrange the whole expression according to powers of x . It possesses however one advantage over the other, viz. that of admitting of the application of logarithms.

We shall now then the application of this formula.

Ex. 1. Having given the logarithms of 101, 102, 104, and 105, it is required to find the logarithm of 103.

In this case we may reckon the terms of the series forward from the first given term, viz. log. 101, so that we have

$$\begin{aligned} t &= \log. 101 = 2.0043214, & n &= 0, \\ t' &= \log. 102 = 2.0086002, & n' &= 1, \\ y &= \log. 103 = \text{term sought}, & x &= 2, \\ t'' &= \log. 104 = 2.0170333, & n'' &= 3, \\ t''' &= \log. 105 = 2.0211893, & n''' &= 4. \end{aligned}$$

Substituting now in the general formula we get

$$\begin{aligned} \alpha &= \frac{1 \times -1 \times -2}{-1 \times -3 \times -4} = -\frac{1}{6}, & \gamma &= \frac{2 \times 1 \times -2}{3 \times 2 \times -1} = \frac{2}{5}, \\ \beta &= \frac{2 \times -1 \times -2}{1 \times -2 \times -3} = \frac{2}{3}, & \delta &= \frac{2 \times 1 \times -1}{4 \times 3 \times 1} = -\frac{1}{6}. \end{aligned}$$

$$\begin{aligned} \text{Therefore } y &= -\frac{t}{6} + \frac{t'}{3} + \frac{2t''}{3} - \frac{t'''}{6} \\ &= \frac{1}{6}(t' + t''') - \frac{1}{3}(t + t'') \\ &= 2.0128372 \text{ the answer.} \end{aligned}$$

Ex.

Series,
SERINGAPATAM.

Seringapatam,
Seringham.

Ex. 2. Given a comet's distance from the sun on the following days at 12 at night, to find its distance December 20th.

December 12. distance 301, Dec. 24. distance 715,
21. 620, 26. 772.

Here we shall estimate the places of the terms from the time of the first position, viz. December 12. Therefore

$$\begin{aligned} t &= 301, & n &= 0, \\ y \text{ is sought,} & & x &= 8, \\ t' &= 620, & n' &= 9, \\ t'' &= 715, & n'' &= 12, \\ t''' &= 772, & n''' &= 14. \end{aligned}$$

In this case the general formula gives us

$$\alpha = \frac{1}{63}, \beta = \frac{6}{45}, \gamma = -\frac{2}{3}, \delta = \frac{8}{35},$$

therefore

$$\begin{aligned} y &= \frac{t}{63} + \frac{64t'}{45} - \frac{2t''}{3} + \frac{8t'''}{35}. \\ &= 586.3 \text{ the answer.} \end{aligned}$$

We shall conclude this article with a brief enumeration of the best works on the subject which we have been treating of.

Arx Conjectandi, (Jac. Bernoulli). *Methodus Differentialis*, (Newton). *Methodus Incrementorum*, (Taylor). *Methodus Differentialis, sive Tractatus de Summatione et Interpolatione Serierum*, (Stirling). *Institutiones Calculi Diff.* (Euler). *Emerjan's Method of Increments*. The differential method, (same author). *Miscellanea Analytica* (De Moivre). The various writings of Lalande and Simpson. *Theorie des Fonctions Analytiques*, (Lagrange). *Du Calcul des Derivations*, (Arbogast). *Traité des différences et des Series*, (a sequel to Lacroix's work on the *Calcul Differential*, &c.). Dr Hutton's *Mathematical and Philosophical Tracts*. An Essay on the Theory of the various orders of Logarithmic Transcendents, with an Inquiry into their applications to the Integral Calculus, and the Summation of Series, by W. Spence, &c. &c.

SERINGAPATAM, the capital of Mysore, formerly the dominions of Tipoo Sultan, is situated in an island of the Cavery river, about 290 or 300 miles from Madras, and in N. Lat. 12° 32' and E. Long. 96° 47', about four miles in length, by one and a half in breadth, across the middle, where it is likewise highest, whence it gradually falls and narrows towards the extremities. The west end of the island, on which there is a fort of considerable strength, slopes more, especially towards the north; and the ground rising on the opposite side of the river commands a distinct view of every part of the fort. The fort and outworks occupy about a mile of the west end of the island, and are distinguished by magnificent buildings, and ancient Hindoo pagodas, contrasted with the more lofty and splendid monuments lately raised in honour of the Mahometan faith. The great garden, called the *Laul Bag*, covers about as much of the east end of the island as the fort and outworks do of the west; and the whole intermediate space, except a small inclosure on the north bank near the fort,

was, before the last war, filled with houses, and formed an extensive suburb, of which the greatest part was destroyed by Tipoo to make room for batteries to defend the island when attacked by the combined forces of Earl Cornwallis and the Mahratta chiefs in February 1792. This suburb, or town of modern structure, is about half a mile square, divided into regular cross streets, all wide, and shaded on each side by trees. It is surrounded by a strong mud wall, contains many good houses, and seems to have been prelerved by the Sultan for the accommodation of merchants, and for the convenience of troops stationed on that part of the island for its defence. A little to the eastward of the town is the entrance to the great garden, which was laid out in regular shady walks of large cypress trees, and abounding with fruit-trees, flowers, and vegetables of every description. It possessed all the beauty and elegance of a country retirement, and was dignified by the mausoleum of Hyder, and a superb new palace built by his son. This noble garden was devoted to destruction; and the trees which had shaded their proud master, and contributed to his pleasures, were felled into the means of protecting his enemies in subverting his empire. "Before that event, so glorious to the arms of England, this inflated metropolis (says Major Dirom) must have been the richest, most convenient, and beautiful spot possessed in the present age by any native prince in India; but when the allies left it, the Sultan's fort and city only remained in repair amidst all the wrecks of his former grandeur, the island presenting nothing but the appearance of wretched barrenness. Tipoo is a man of talents, enterprise, and great wealth; but, in the opinion of our author, the remaining years of his ill-fated life will be unequal to renew the beauties of his terrestrial paradise." This prediction was more than verified in the fate of Tipoo; for he lost his life in bravely defending his capital, which was taken by assault in 1799 by the British troops under General Baird. See INDIA, N^o 183.

SERINGHAM, an island of Indostan, formed about six miles north-west of Trinchinopoly by the river Cavery, which divides itself into two branches: that to the northward takes the name of *Coleroon*, but the southern branch preserves its old name the *Cavery*. Each of these rivers, after a course of about 90 miles, empty themselves into the sea; the Coleroon at Devicottah, and the Cavery near Tranquebar, at about 20 miles distance from one another. In this island, facing Trinchinopoly, stood a famous pagoda surrounded by seven square walls of stone, 25 feet high and four feet thick. The space between the outward and second walls measured 310 feet, and proportionably of the rest. Each inclosure had four large gates, with a high tower; which were placed, one in the middle of each side of the inclosure, and opposite to the four cardinal points. The outward wall was about four miles in circumference, and its gateway to the south was ornamented with pillars, some of which were single stones 33 feet in length and five in diameter; while those that formed the roof were still larger; and in the inmost inclosure were the chapels.—About half a mile to the east was another large pagoda called *Jumbukisna*, which had but one inclosure.

The pagoda of Seringham was held in great veneration, from a belief that it contained the identical image

of the god Vitnou worshipped by Bramā; and pilgrims came here from all parts of India with offerings of money to procure absolution. A large part of the revenue of the island was allotted for the maintenance of the Bramins who inhabited the pagoda; and these, with their families, formerly amounted to no fewer than 40,000 persons, all maintained by the superstitious liberality of the adjacent country.

SERIOLOA, a genus of plants belonging to the class Syngenesia, and in the natural system ranged under the 49th order, *Compositæ*. See **BOTANY INDEX**.

SERIPHUELLI, a genus of plants belonging to the class Syngenesia. See **BOTANY INDEX**.

SERIPHUS, in *Ancient Geography*, one of the Cyclades or islands in the Ægean sea, called *Saxum Seriphium* by Læcius, as if all a rock; one of the usual places of banishment among the Romans. The people, *Seriphii*; who, together with the Siphni, joined Greece against Xerxes, were almost the only islanders who refused to give him earth and water in token of submission, (Herodotus). *Seriphia Rana*, a proverbial saying concerning a person who can neither sing nor lay; frogs in this island being said to be dumb, (Pliny).

SERMON, a discourse delivered in public, for the purpose of religious instruction and improvement.

Funerel SERMON. See **FUNERAL ORATIONS**.

SERON OF ALMONDS, is the quantity of two hundred weight; of anise seed, it is from three to four hundred; of Castile soap, from two hundred and a half to three hundred and three quarters.

SEROSITY, in *Medicine*, the watery part of the blood.

SERPENS, in *Astronomy*, a constellation in the northern hemisphere, called more particularly *Serpens Phœnicæ*. The stars in the constellation Serpens, in Ptolemy's catalogue, are 18; in Tycho's, 13; in Hevelius's, 22; and in the Britannic catalogue, 64.

SERPENS BICEPS, or *Double-headed Snake*; a monster of the serpent kind, of which some individuals are described by naturalists.

SERPENTES, *Serpents*, in the Linnæan system of zoology, an order of animals belonging to the class of *amphibia*. See **ORHIOLOGY**.

The serpent has been always considered the enemy of man; and it has hitherto continued to terrify and annoy him, notwithstanding all the arts which have been practised to destroy it. Formidable in itself, it deters the invader from the pursuit; and from its figure, capable of finding shelter in a little space, it is not easily discovered by those who would venture to encounter it. Thus possessed at once of potent arms, and inaccessible or secure retreats, it baffles all the arts of man, though ever so earnestly bent upon its destruction. For this reason, there is scarcely a country in the world that does not still give birth to this poisonous brood, that seems formed to quell human pride, and repress the boasts of security. Mankind have driven the lion, the tiger, and the wolf, from their vicinity; but the snake and the viper still defy their power.

Their numbers, however, are thinned by human avidity; and it is possible some of the kinds are wholly destroyed. In none of the countries of Europe are they sufficiently numerous to be truly terrible. The various malignity that has been ascribed to European serpents

of old is now utterly unknown; there are not above three or four kinds that are dangerous, and their poison operates in all in the same manner. The drowsy death, the starting of the blood from every pore, the insupportable and burning thirst, the melting down the solid mass of the whole form into one heap of putrefaction, said to be occasioned by the bites of African serpents, are horrors with which we are entirely unacquainted, and are perhaps only the creatures of fancy.

But though we have thus reduced these dangers, having been incapable of wholly removing them, in other parts of the world they still rage with all their ancient malignity. In the warm countries that lie within the tropics, as well as in the cold regions of the north, where the inhabitants are few, the serpents propagate in equal proportion. But of all countries those regions have them in the greatest abundance where the fields are unpeopled and fertile, and where the climate supplies warmth and humidity. All along the swampy banks of the river Niger or Oroonoko, where the sun is hot, the forests thick, and the men but few, the serpents cling among the branches of the trees in infinite numbers, and carry on an unceasing war against all other animals in their vicinity. Travellers have assured us, that they have often seen large snakes twining round the trunk of a tall tree, encompassing it like a wreath, and thus rising and descending at pleasure.—

We are not, therefore, to reject as wholly fabulous the accounts left us by the ancients of the terrible devastations committed by a single serpent. It is probable, in early times, when the arts were little known, and mankind were but thinly scattered over the earth, that serpents, continuing undisturbed possessors of the forest, grew to an amazing magnitude; and every other tribe of animals fell before them. It then might have happened, that serpents reigned the tyrants of a district for centuries together. To animals of this kind, grown by time and rapacity to 100 or 150 feet in length, the lion, the tiger, and even the elephant itself, were but feeble opponents. That horrible factor, which even the commonest and the most harmless snakes are still found to diffuse, might, in these larger ones, become too powerful for any living being to withstand; and while they preyed without distinction, they might thus also have poisoned the atmosphere around them. In this manner, having for ages lived in the hidden and unpeopled forest, and finding, as their appetites were more powerful, the quantity of their prey decreasing, it is possible they might venture boldly from their retreats into the more cultivated parts of the country, and carry conflagration among mankind, as they had before desolation among the lower ranks of nature. We have many histories of antiquity, presenting us such a picture, and exhibiting a whole nation sinking under the ravages of a single serpent. At that time man had not learned the art of uniting the efforts of many to effect one great purpose. Opposing multitudes only added new victims to the general calamity, and increased mutual embarrasment and terror. The animal was therefore to be singly opposed by him who had the greatest strength, the best armour, and the most undaunted courage. In such an encounter, hundreds must have fallen; till one, more lucky than the rest, by a fortunate blow, or by taking the monster in its torpid interval, and furcharged with spoil, might kill, and thus rid his country

Serpens.
Serpent.

country of the destroyer. Such was the original occupation of heroes; and those who first obtained that name, from their destroying the ravagers of the earth, gained it much more deservedly than their successors, who acquired their reputation only for their skill in destroying each other. But as we descend into more enlightened antiquity, we find these animals less formidable, as being attacked in a more successful manner. We are told, that while Regulus led his army along the banks of the river Bagrada in Africa, an enormous serpent disputed his passage over. We are assured by Pliny, that it was 120 feet long, and that it had destroyed many of the army. At last, however, the battering engines were brought out against it; and these assailing it at a distance, it was soon destroyed. Its spoils were carried to Rome, and the general was decreed an ovation for his success. There are, perhaps, few facts better ascertained in history than this: an ovation was a remarkable honour; and was given only for some signal exploit that did not deserve a triumph: no historian would offer to invent that part of the story at least, without being subject to the most shameful detection. The skin was kept for several years after in the Capitol; and Pliny says he saw it there. At present, indeed, such ravages from serpents are scarcely seen in any part of the world; not but that, in Africa and America, some of them are powerful enough to brave the assaults of men to this day.

—*Nequeunt expleri corda tuendo
Terroribus oculis, vultum villosaque fetis
Pectora.*— VIRGIL.

We have given a place to the preceding remarks, not so much for their accuracy as to show what were formerly the sentiments of mankind concerning this tribe of animals.

SERPENT, a musical instrument, serving as a bass to the cornet, or *small shawm*, to sustain a chorus of singers in a large edifice. It has its name *serpent* from its figure, as consisting of several folds or wreaths, which serve to reduce its length, which would otherwise be six or seven feet.

It is usually covered with leather, and consists of three parts, a mouth-piece, a neck, and a tail. It has six holes, by means whereof it takes in the compass of two octaves.

Merlinus, who has particularly described this instrument, mentions some peculiar properties of it, e. g. that the sound of it is strong enough to drown 20 robust voices, being animated merely by the breath of a boy, and yet the sound of it may be tempered to the softness of the sweetest voice. Another peculiarity of this instrument is, that great as the distance between the third and fourth hole appears, yet whether the third hole be open or shut, the difference is but a tone.

SERPENT, in *Mythology*, was a very common symbol of the sun, and he is represented biting his tail, and with his body formed into a circle, in order to indicate the ordinary course of this luminary, and under this form it was an emblem of time and eternity. The serpent was also the symbol of medicine, and of the gods which presided over it, as of Apollo and Æsculapius; and this animal was the object of very ancient and general worship, under various appellations and characters.

In most of the ancient rites we find some allusion to the serpent, under the several titles of Os, Oph, Python, &c. This idolatry is alluded to by Moses, (Lev. xx. 27-). The woman at Endor who had a familiar spirit is called Oub, or Ob, and it is interpreted Pythonif. The place where she resided, says the learned Mr. Bryant, seems to have been named from the worship then instituted; for Endor is compounded of *En-ador*, and signifies *font Pythonis*, "the fountain of light, the oracle of the god Ador, which oracle was probably founded by the Canaanites, and had never been totally suppressed. His pillar was also called *Abador*, or *Ab-ador*, compounded of *ab* and *ador*, and meaning the serpent deity Ador, the same as Adorus.

In the orgies of Bacchus, the persons who partook of the ceremony used to carry serpents in their hands, and with horrid screams call upon Eva! Eva! Eva, being, according to the writer just mentioned, the same as epha, or opha, which the Greeks rendered *ophis*, and by it denoted a serpent. These ceremonies and this symbolic worship began among the Magi, who were the sons of Chus; and by them they were propagated in various parts. Wherever the Amonians founded any places of worship, and introduced their rites, there was generally some story of a serpent. There was a legend about a serpent at Colchis, at Thebes, and at Delphi; and likewise in other places. The Greeks called Apollo himself Python, which is the same as Opis, Oapis, and Oub.

In Egypt there was a serpent named Thermuthis, which was looked upon as very sacred; and the natives are said to have made use of it as a royal tiara, with which they ornamented the statues of Isis. The kings of Egypt wore high bonnets, terminating in a round ball, and surrounded with figures of aaps; and the priests likewise had the representation of serpents upon their bonnets.

Abadon, or Abaddon, mentioned in the Revelations xx. 2. is supposed by Mr Bryant to have been the name of the Ophite god, with whose worship the world had been so long infected. This worship began among the people of Chaldea, who built the city of Opis upon the Tigris, and were greatly addicted to divination, and to the worship of the serpent. From Chaldea the worship passed into Egypt, where the serpent deity was called Canoph, Can-eph, and C'neph. It had also the name of Ob or Oub, and was the same as the Basiliscus or royal serpent, the same as the Thermuthis, and made use of by way of ornament to the statues of their gods. The chief deity of Egypt is said to have been Vulcan, who was styled Opas. He was the same as Osiris, the Sun, and hence was often called Ob-el, or Pytho-sol, and these were pillars sacred to him, with curious hieroglyphical inscriptions bearing the same name; whence among the Greeks, who copied from the Egyptians, every thing gradually tapering to a point was styled obelos, or obeliscus.

As the worship of the serpent began among the sons of Chus, Mr Bryant conjectures, that from thence they were denominated Ethiopians and Aithiopiens, from Ath-ope or Ath-opes, the god whom they worshipped, and not from their complexion: the Ethiopians brought these rites into Greece, and called the island where they first established them, *Ellipsis, Sclis Serpentis, insula*, the same with *Eubœa*, or *Oubœa*, i. e. "the serpent island."

Serpent
SerratusSerratus
Serratus

The fame learned writer discovers traces of the serpent worship among the Hyperboreans, at Rhodes, named Ophiusa, in Phrygia, and upon the Hellespont, in the island Cyprus, in Crete, among the Athenians, in the name of Cecrops, among the natives of Thebes in Bœotia, among the Lacedæmonians, in Italy, in Syria, &c. and in the names of many places, as well as of the people where the Ophites settled. One of the most early heresies introduced into the Christian church was that of the Ophite. Bryant's Analysis of Ancient Mythology, vol. i. p. 43, &c. p. 473, &c.

SERPENT-STONES. See **COENU AMMONIS**, and **SNAKE-STONES**.

SEA-SERPENT. See **SEA SERPENT**.

SERPENTARIA, SNAKE ROOT; a species of **ARISTOLOCHIA**. See **BOTANY** and **MATERIA MEDICA Index**.

SERPENTARIUS, in *Astronomy*, a constellation of the northern hemisphere, called also Ophiuchus, and anciently *Æsculapius*. The stars in the constellation Serpentarius, in Ptolemy's catalogue, are 29; in Tycho's 15; in Hevelius's 40; in the Britannic catalogue they are 74.

SERPENTINE, in general, denotes any thing that resembles a serpent; hence the worm or pipe of a still, twisted in a spiral manner, is termed a *serpentine worm*.

SERPENTINE Stone, a species of mineral belonging to the magnesian genus. See **MINERALOGY Index**.

SERPENTINE vessels, are such as begin and end with the same word. As,

Ambo florentes-etatibus, Arcades ambo.

SERPENTINE, in the *Manege*. A horse is said to have a serpentine tongue, if it is always frisking and moving, and sometimes passing over the bit, instead of keeping in the void space, called the liberty of the tongue.

SERPICULA, a genus of plants belonging to the class monocœcia. See **BOTANY Index**.

SERPIGO, in *Surgery*, a kind of herpes, popularly called a *letter* or ringworm. See **SURGERY**.

SERPULA, a genus belonging to the class of vermes and to the order of testacea. See **CONCHOLOGY Index**.

SERRANUS, JOANNES, or John de Serres, a learned French Protestant, was born about the middle of the 16th century. He acquired the Greek and Latin languages at Lausanne, and devoted himself to the study of the philosophy of Aristotle and Plato. On his return to France he studied divinity. He began to distinguish himself in 1572 by his writings, but was obliged to forsake his country after the dreadful massacre of St Bartholomew. He became minister of Nîmes in 1582, but was never regarded as a very zealous Calvinist: he has even been suspected, though without reason, of having actually abjured the Protestant religion. He was one of the four clergymen whom Henry IV. consulted about the Romish religion, and who returned for answer, that Catholics might be saved. He wrote afterwards a treatise in order to reconcile the two communions, entitled *De fide Catholicâ, sive de principiis religionis Christianæ, communi omnium Christianorum consensu, semper et ubique rari*: This work was disliked by the Catholics, and received with such indignation by the Calvinists of Geneva, that many writers have affirmed that they poisoned the author. It is certain at least that he died at

Geneva in 1598, at the age of 50. His principal works are, 1. A Latin translation of Plato, published by Henry Stephens, which owes much of its reputation to the elegance of the Greek copy which accompanies it. 2. A Treatise on the Immortality of the Soul. 3. *De statu religionis et reipublice in Francia*. 4. *Memoire de la 3me guerre civile et derniers troubles de France sous Charles IX. &c.* 5. *Inventaire general de l'Histoire de France, illustré par la conference de l'Eglise et de l'Empire, &c.* 6. *Recueil de chose memorable avenue en France sous Henri II. François II. Charles IX. Henri III.* These three historical treatises have been justly accused of partiality and passion; faults which it is next to impossible for a contemporary writer to avoid, especially if he bore any part in the transactions which he describes. His style is exceedingly incorrect and inelegant; his mistakes too and misstatements of facts are very numerous.

SERRATED, in general, something indented or notched in the manner of a saw; a term much used in the description of the leaves of plants. See **BOTANY Index**.

SERRATULA, SAW-WORT, a genus of plants belonging to the Syngenesia class, and in the natural system ranged under the 49th order, *Compositæ*. See **BOTANY Index**.

SERRATUS, in *Anatomy*, a name given to several muscles, from their resemblance to a saw. See **ANATOMY, Table of the Muscles**.

SERRISHTEHDAH, in Bengal, keeper of records or accounts.

SERTORIUS, QUINTUS, an eminent Roman general; (see **SPAIN**), under the history of which his exploits are related.

SERTULARIA, a genus belonging to the class of vermes, and to the order of zoophyta. See **HELMINTHOLOGY Index**.

SERVAL, MOUNTAIN CAT. See **FELIS**, **MAMMALIA Index**.

SERVANDONI, JOHN NICOLAS, a celebrated architect, was born at Florence in 1695. He rendered himself famous by his exquisite taste in architecture, and by his genius for decorations, fetes, and building. He was employed and rewarded by most of the princes in Europe. He was honoured in Portugal with the order of Christ: In France he was architect and painter to the king, and member of the different academies established for the advancement of these arts. He received the same titles from the kings of Britain, Spain, Poland, and from the duke of Wirtemberg. Notwithstanding these advantages, his want of economy was so great, that he left nothing behind him. He died at Paris in 1766. Paris is indebted to him for many of its ornaments. He made decorations for the theatres of London and Dresden. The French king's theatre, called *la salle des Machines*, was under his management for some time. He was permitted to exhibit some shows consisting of simple decorations: Some of these were astonishingly sublime; his "Descent of Æneas into Hell" in particular, and his "Enchanted Forest," are well known. He built and embellished a theatre at Chambor for Mareschal Saxe; and furnished the plan and the model of the theatre royal at Dresden. His genius for fetes was remarkable; he had the management of a great number in Paris, and even in London. He conducted

servant, one at Lisbon given an account of a victory gained by the duke of Cumberland. He was employed frequently by the king of Portugal, to whom he presented several elegant plans and models. The prince of Wales, too, father to the present king, engaged him in his service; but the death of that prince prevented the execution of the designs which had been projected. He presided at the magnificent *fete* given at Vienna on account of the marriage of the archduke Joseph and the Infanta of Parma: But it would be endless to attempt an enumeration of all his performances and exhibitions.

SERVANT, a term of relation, signifying a person who owes and pays obedience for a certain time to another in quality of a waiter.

As to the several sorts of servants: It was observed, under the article **LIBERTY**, that pure and proper slavery does not, nay cannot, subsist in Britain: such we mean whereby an absolute and unlimited power is given to the master over the life and fortune of the slave. And indeed it is repugnant to reason, and the principles of natural law, that such a state should subsist anywhere. See **SLAVERY**.

The law of England therefore abhors, and will not endure, the existence of slavery within this nation: so that when an attempt was made to introduce it, by statute 1 Edw. VI. c. 3. which ordained, that all idle vagabonds should be made slaves, and fed upon bread, water, or small drink, and refuse-meat; should wear a ring of iron round their necks, arms, or legs; and should be compelled, by beating, chaining, or otherwise, to perform the work assigned them, were it ever so vile; the spirit of the nation could not brook this condition, even in the most abandoned rogues; and therefore this statute was repealed in two years afterwards. And now it is laid down, that a slave or negro, the instant he lands in Britain, becomes a freeman; that is, the law will protect him in the enjoyment of his person and his property. Yet, with regard to any right which the master may have lawfully acquired to the perpetual service of John or Thomas, this will remain exactly in the same state as before: for this is no more than the same state of subjection for life which every apprentice submits to for the space of seven years, or sometimes for a longer term. Hence, too, it follows, that the infamous and unchristian practice of withholding baptism from negro-servants, lest they should thereby gain their liberty, is totally without foundation, as well as without excuse. The law of England acts upon general and extensive principles: it gives liberty, rightly understood, that is, protection, to a Jew, a Turk, or a Heathen, as well as to those who profess the true religion of Christ; and it will not dissolve a civil obligation between master and servant, on account of the alteration of faith in either of the parties; but the slave is entitled to the same protection in England before as after baptism; and, whatever service the Heathen negro owed of right to his American master, by general, not by local law, the same (whatever it be) is he bound to render when brought to England and made a Christian.

1. The first sort of servants, therefore, acknowledged by the laws of England, are *menial servants*; so called from being *intra mania*, or domestics. The contract between them and their masters arises upon the hiring. If the hiring be general, without any particular time

limited, the law construes it to be a hiring for a year; and upon a principle of natural equity, that the servant shall serve and the master maintain him, throughout all the revolutions of the respective seasons; as well when there is work to be done, as when there is not: but the contract may be made for any larger or smaller term. All single men between 12 years old and 60, and married ones under 30 years of age, and all single women between 12 and 40, not having any visible livelihood, are compellable by two justices to go out to service in husbandry or certain specific trades, for the promotion of honest industry; and no master can put away his servant, or servant leave his master, after being so retained, either before or at the end of his term, without a quarter's warning; unless upon reasonable cause, to be allowed by a justice of the peace: but they may part by consent, or make a special bargain.

2. Another species of servants are called *apprentices*, (from *apprendre*, to learn); and are usually bound for a term of years, by deed indented or indentures, to serve their masters, and be maintained and instructed by them. This is usually done to persons of trade, in order to learn their art and mystery; and sometimes very large sums are given with them as a premium for such their instruction: but it may be done to husbandmen, nay, to gentlemen and others. And children of poor persons may be apprenticed out by the overseers, with consent of two justices, till 24 years of age, to such persons as are thought fitting; who are also compellable to take them: and it is held, that gentlemen of fortune, and clergymen, are equally liable with others to such compulsion: for which purposes our statutes have made the indentures obligatory, even though such parish-apprentice be a minor. Apprentices to trades may be discharged on reasonable cause, either at the request of themselves or masters, at the quarter-sessions, or by one justice, with appeal to the sessions; who may, by the equity of the statute, if they think it reasonable, direct restitution of a rateable share of the money given with the apprentice: and parish-apprentices may be discharged in the same manner by two justices. But if an apprentice, with whom less than 10 pounds hath been given, runs away from his master, he is compellable to serve out his time of absence, or make satisfaction for the same, at any time within seven years after the expiration of his original contract. See **APPRENTICE AND APPRENTICESHIP**.

3. A third species of servants are *labourers*, who are only hired by the day or the week, and do not live *intra mania*, as part of the family; concerning whom the statutes before cited have made many very good regulations; 1. Discharging that all persons who have no visible effects may be compelled to work; 2. Defining how long they must continue at work in summer and in winter; 3. Punishing such as leave or desert their work; 4. Empowering the justices at sessions, or the sheriff of the county, to settle their wages; and, 5. Inflicting penalties on such as either give or exact more wages than are so settled.

4. There is yet a fourth species of servants, if they may be so called, being rather in a superior, a ministerial, capacity; such as *stewards, factors, and bailiffs*; whom, however, the law considers as servants *pro tempore*, with regard to such of their acts as affect their master's or employer's property.

Servant.

Servetus
 Servetus

As to the manner in which this relation affects the matter, the servant himself, or third parties, see the article *MASTER and Servant*.

For the condition of servants by the law of Scotland, see *LAW*.

SERVETISTS, a name given to the modern Antitrinitarians, from their being supposed to be the followers of Michael Servetus; who, in the year 1553, was burnt at Geneva, together with his books.

SERVETUS, MICHAEL, a learned Spanish physician, was born at Villanueva, in Arragon, in 1509. He was sent to the university of Toulouse to study the civil law. The Reformation, which had awakened the most polished nations of Europe, directed the attention of thinking men to the errors of the Romish church and to the study of the Scriptures. Among the rest Servetus applied to this study. From the love of novelty, or the love of truth, he carried his inquiries far beyond the other reformers, and not only renounced the false opinions of the Roman Catholics, but went so far as to question the doctrine of the Trinity. Accordingly, after spending two or three years at Toulouse, he determined to go into Germany to propagate his new opinions, where he could do it with most safety. At Basil he had some conferences with Oecolampadius. He went next to Straßburg to visit Bucer and Capito, two eminent reformers of that town. From Straßburg he went to Hugenau, where he printed a book, intitled *De Trinitatis Erroribus*, in 1531. The ensuing year he published two other treatises on the same subject: in an advertisement to which, he informs the reader that it was not his intention to retract any of his former sentiments, but only to state them in a more distinct and accurate manner. To these two publications he had the courage to put his name, not suspecting that in age when liberty of opinion was granted, the exercise of that liberty would be attended with danger. After publishing these books, he left Germany, probably finding his doctrines not so cordially received as he expected. He went first to Basil, and thence to Lyons, where he lived two or three years. He then removed to Paris, where he studied medicine under Sylvius, Fernelius, and other professors, and obtained the degree of master of arts and doctor of medicine. His love of controversy involved him in a serious dispute with the physicians of Paris; and he wrote an Apology, which was suppressed by an edict of the Parliament. The misunderstanding which this dispute produced with his colleagues, and the chagrin which so unfavourable a termination occasioned, made him leave Paris in disgust. He settled two or three years in Lyons, and engaged with the Frelons, eminent printers of that age, as a corrector to their press. At Lyons he met with Pierre Palmier, the archbishop of Vienne, with whom he had been acquainted at Paris. That prelate, who was a great encourager of learned men, pressed him to accompany him to Vienne, offering him at the same time an apartment in his palace. Servetus accepted the offer, and might have lived a tranquil and happy life at Vienne, if he could have confined his attention to medicine and literature. But the love of controversy, and an eagerness to establish his opinions, always possessed him. At this time Calvin was at the head of the reformed church at Geneva. With Servetus he had been acquainted at Paris, and had there opposed his opinions. For 16 years

Calvin kept up a correspondence with him, endeavouring to reclaim him from his errors. Servetus had read the works of Calvin, but did not think they merited the high eulogies of the reformers, nor were they sufficient to convince him of his errors. He continued, however, to consult him; and for this purpose sent from Lyons to Geneva three questions, which respected the divinity of Jesus Christ, regeneration, and the necessity of baptism. To these Calvin returned a civil answer. Servetus treated the answer with contempt, and Calvin replied with warmth. From reasoning he had recourse to abusive language; and this produced a polemical hatred, the most implacable disposition in the world. Calvin having obtained some of Servetus's papers, by means, it is said, not very honourable, sent them to Vienne along with the private letters which he had received in the course of their correspondence. The consequence was, that Servetus was arrested; but having escaped from prison, he resolved to retire to Naples, where he hoped to practise medicine with the same reputation which he had so long enjoyed at Vienne. He imprudently took his route through Geneva, though he could not but know that Calvin was his mortal enemy. Calvin informed the magistrates of his arrival; Servetus was apprehended, and appointed to stand trial for heresy and blasphemy. It was a law at Geneva, that every accuser should surrender himself a prisoner, that if the charge should be found false, the accuser should suffer the punishment in which he meant to involve the accused. Calvin not choosing to go to prison himself, sent one of his domestics to present the impeachment against Servetus. The articles brought against him were collected from his writings with great care; an employment which took up three days. One of these articles was, "that Servetus had denied that Judæa was a beautiful, rich, and fertile country; and affirmed, on the authority of travellers, that it was poor, barren, and disagreeable." He was also charged with "corrupting the Latin Bible, which he was employed to correct at Lyons, by introducing impertinent, trifling, whimsical, and impious notes of his own through every page." But the main article, which was certainly fatal to him, was, "that in the person of Mr Calvin, minister of the word of God in the church of Geneva, he had defamed the doctrine that is preached, uttering all imaginable injurious, blasphemous words against it."

Calvin visited Servetus in prison, and had frequent conferences with him; but finding that, in opposition to all the arguments he could employ, the prisoner remained inflexible in his opinions, he left him to his fate. Before sentence was passed, the magistrates of Geneva consulted the ministers of Bale, of Bern, and Zurich; and, as another account informs us, the magistrates of the Protestant Cantons of Switzerland. And to enable them to form a judgment of the criminality of Servetus, they transmitted the writings of Calvin, with his answers. The general opinion was, that Servetus ought to be condemned to death for blasphemy. He was accordingly sentenced to be burnt alive on the 27th of October 1553. As he continued alive in the midst of the flames more than two hours, it is said, finding his torment thus protracted, he exclaimed, "Unhappy wretch that I am! Will the flames be insufficient to terminate my misery! What then! Will the hundred pieces of gold, and the rich collar which they took from

Servetus
 Servetus

Servetus, me, not purchase wood enough to confume me more quickly!" "Though the sentence of death was passed against Servetus by the magistrates of Geneva, with the approbation of a great number of the magistrates and ministers of Switzerland, yet it is the opinion of most historians that this dreadful sentence was imposed at the instigation of Calvin. This act of severity for holding a speculative opinion, however erroneous and absurd, has left a stain on the character of this illustrious reformer, which will attend the name of Calvin as long as history shall preserve it from oblivion. The address and art which he used in apprehending Servetus, his inhumanity to him during his trial, his dissimulation and malevolence after his condemnation, prove that he was as much influenced by personal hatred as by a desire to support the interest of religion, though probably, during the trial, Calvin believed he was performing a very pious action. This intolerant spirit of Calvin and the magistrates of Geneva gave the Roman Catholics a favourable opportunity to accuse the Protestants of inconsistency in their principles, which they did not fail to embrace. "How could the magistrates (says the author of the *Dictionnaire des Heresies*), who acknowledged no infallible interpretation of the Scriptures, condemn Servetus to death because he explained them differently from Calvin; since every man has the privilege to expound the Scripture, according to his own judgment, without having recourse to the church? It is a great injustice to condemn a man because he will not submit to the judgment of an enthusiast, who may be wrong as well as himself."

Servetus was a man of great neatness and learning, and well versed in the arts and sciences. In his own profession his genius exerted itself with success. In his treatise intitled *Christianismi Restitutio*, published in 1553, he remarks, that the whole mass of blood passes through the lungs by the pulmonary artery and vein, in opposition to the opinion which was then universally entertained, that the blood passes through the partition which divides the two ventricles. This was an important step towards the discovery of the circulation of the blood.

His works consist of Controversial Writings concerning the Trinity; an edition of Pagninus's Version of the Bible, with a preface and notes, published under the name of Michael Villanevanus; an Apology to the Physicians of Paris; and a book intitled *Ratio Scurvorum*. Moetheim has written in Latin a History of the Heresy and Misfortunes of Servetus, which was published at Helmstadt, in 4to, in 1728. From the curious details which it gives it is extremely interesting.

SERVIA, a province of Turkey in Europe, bounded on the north by the rivers Danube and Save, which separate it from Hungary; on the east, by Bulgaria; on the west, by Bosnia; and on the south, by Albania and Macedonia. It is about 192 miles in length from east to west; 93 in breadth from north to south; and is divided into four languagues. Two of these were ceded to the Christians in 1718, who united them into one. This continued till 1739, when the Turks were victorious; and then they were abandoned to the Turks by the treaty of Belgrade. Belgrade is the capital town.

SERVICE, in Law, is a duty which a tenant, on account of his fee, owes to his lord.

There are many divisions of services; as, 1. Into personal, where something is to be done by the tenant in person, as homage and fealty. 2. Real, such as wards, marriages, &c. 3. Accidental, including heriots, reliefs, and the like. 4. Entire, where, on the alienation of any part of the lands by a tenant, the services become multiplied. 5. Frank-service, which was performed by freemen, who were not obliged to perform any base service, but only to find a man and horse to attend the lord into the army or to court. 6. Knight's service, by which lands were anciently held of the king, on paying homage, service in war, &c.

As in every free and well regulated society there must be a diversity of ranks, there must be a great number of persons employed in service, both in agriculture and domestic affairs. In this country, service is a contract into which the servant voluntarily enters; and the master's authority extends no farther than to the performance of that species of labour for which the agreement was made.

"The treatment of servants (says that respectable moralist Mr Paley), as to diet, discipline, and accommodation, the kind and quantity of work to be required of them, the intermission, liberty, and indulgence to be allowed them, must be determined in a great measure by custom; for where the contract involves so many particulars, the contracting parties express a few perhaps of the principal, and by mutual understanding refer the rest to the known custom of the country in like cases.

"A servant is not bound to obey the unlawful commands of his master; to minister, for instance, to his unlawful pleasures; or to assist him in unlawful practices in his profession; as in smuggling or adulterating the articles which he deals in. For the servant is bound by nothing but his own promise; and the obligation of a promise extends not to things unlawful.

"For the same reason, the master's authority does not justify the servant in doing wrong; for the servant's own promise, upon which that authority is founded, would be none.

"Clerks and apprentices ought to be employed entirely in the profession or trade which they are intended to learn. Instruction is their wages; and to deprive them of the opportunities of instruction, by taking up their time with occupations foreign to their business, is to defraud them of their wages.

"The master is responsible for what a servant does in the ordinary course of his employment; for it is done under a general authority committed to him, which is in justice equivalent to a specific direction. Thus, if I pay money to a banker's clerk, the banker is accountable; but not if I had paid it to his bulker or his footman, whose business it is not to receive money. Upon the same principle, if I once send a servant to take up goods upon credit, whatever goods he afterwards takes up at the same shop, so long as he continues in my service, are justly chargeable to my account.

"The law of this country goes great lengths in intending a kind of concurrence in the matter, so as to charge him with the consequences of his servants' conduct. If an inn-keeper's servant rob his guests, the innkeeper must make restitution; if a farrier's servant lame your horse, the farrier must answer for the damage;

Service.

Political
Philosophy
137

Service. *mage; and still farther, if your coachman or carter drive over a passenger in the road, the passenger may recover from you a satisfaction for the hurt he suffers. But these determinations stand, I think, rather upon the authority of the law, than any principle of natural justice.*"

There is a grievance which has long and justly been complained of, the giving of good characters to bad servants. This is perhaps owing to carelessness, to a desire of getting rid of a bad servant, or to mistaken compassion. But such carelessness is inexcusable. When a man gives his sanction to the character of a bad servant, he ought to reflect on the nature and consequences of what he is doing. He is giving his name to a falsehood; he is deceiving the honest man who confides in his veracity; and he is deliberately giving a knave an opportunity of cheating an honest man. To endeavour to get quit of a bad servant in this way, is surely not less criminal than concealing the faults and disadvantages of an estate which is advertised for sale, and ascribing to it advantages which it does not possess. In this case, we know the sale would be reduced, and the advertiser disgraced. Many masters give characters to servants out of compassion; but it is to this mistaken compassion that the disorderly behaviour of servants is perhaps principally owing: for if the punishment of dishonesty be only a change of place (which may be a reward instead of a punishment), it ceases to be a servant's interest to be true to his trust.

We have said above that a master's authority over his servant extends no farther than the terms of contract; by which we meant, that a master could give no unreasonable orders to his servant, or such as was inconsistent with the terms of contract. But the relation between a master and servant is certainly closer than the mere terms of a contract: it is a moral as well as a legal relation. A master of a family ought to superintend the morals of his servants, and to restrain them from vices. This he may do by his example, by his influence, and authority. Indeed every man possessed of authority is guilty of criminal negligence if he does not exert his authority for promoting virtue in his inferiors; and no authority is so well adapted for this purpose as that of masters of families, because none operates with an influence so immediate and constant. It is wonderful how much good a nobleman or gentleman of fortune can do to his domestics by attending to their morals; and every master may be a blessing to individuals and to society, by exerting prudently that influence which his situation gives him over the conduct of his servant.

Choral SERVICE, in church-history, denotes that part of religious worship which consists in chanting and singing. The advocates for the high antiquity of singing, as a part of church-music, urge the authority of St Paul in its favour (Ephes. chap. v. ver. 19. and Colos. chap. iii. ver. 16.). On the authority of which passages it is asserted, that songs and hymns were, from the establishment of the church, sung in the assemblies of the faithful; and it appears from undoubted testimony, that singing, which was practised as a sacred rite among the Egyptians and Hebrews, at a very early period, and which likewise constituted a considerable part of the religious ceremonies of the Greeks and Romans, made a part of the religious worship of Christians, not only be-

fore churches were built, and their religion established by law, but from the first profession of Christianity. However, the era from whence others have dated the introduction of music into the service of the church, is that period during which Leontius governed the church of Antioch, i. e. between the year of Christ 347 and 356. See ANTIPHONY.

From Antioch the practice soon spread through the other churches of the East; and in a few ages after its first introduction into divine service, it not only received the sanction of public authority, but those were forbid to join in it who were ignorant of music. A canon to this purpose was made by the council of Laodicea, which was held about the year 372; and Zonas informs us, that these canonical singers were reckoned a part of the clergy. Singing was introduced into the western churches by St Ambrose about the year 374, who was the institutor of the Ambrosian chant established at Milan about the year 386; and Eusebius (lib. ii. cap. 17.) tells us, that a regular choir, and method of singing the service, were first established, and hymns used, in the church at Antioch, during the reign of Constantine, and that St Ambrose, who had long resided there, had his melodies thence. This was about 230 years afterwards amended by Pope Gregory the Great, who established the Gregorian chant; a plain, unisonous kind of melody, which he thought consistent with the gravity and dignity of the service to which it was to be applied. This prevails in the Roman church even at this day: it is known in Italy by the name of *canto fermo*; in France by that of *plain chant*; and in Germany and most other countries by that of the *cantus Gregorianus*. Although no satisfactory account has been given of the specific difference between the Ambrosian and Gregorian chants, yet all writers on this subject agree in saying, that St Ambrose only used the four authentic modes, and that the four plagal were afterwards added by St Gregory. Each of these had the same final, or key-note, as its relative authentic; from which there is no other difference, than that the melodies in the four authentic or principal modes are generally confined within the compass of the eight notes above the key-note, and those in the four plagal or relative modes, within the compass of eight notes below the fifth of the key. See MODE.

Ecclesiastical writers seem unanimous in allowing that Pope Gregory, who began his pontificate in 590, collected the musical fragments of such ancient psalms and hymns as the first fathers of the church had approved and recommended to the first Christians; and that he selected, methodized, and arranged them in the order which was long continued at Rome, and soon adopted by the chief part of the western church. Gregory is also said to have banished from the church the *canto figurato*, as too light and dissolute; and it is added, that his own chant was called *canto ye-mo*, from its gravity and simplicity.

It has been long a received opinion, that the ecclesiastical tones were taken from the reformed modes of Ptolemy; but Dr Burney observes, that it is difficult to discover any connection between them, except in their names; for their number, upon examination, is not the same: those of Ptolemy being seven, the ecclesiastical eight; and indeed the Greek names given to

Service.

the ecclesiastical modes do not agree with those of Ptolemy in the single instance of key, but with those of higher antiquity. From the time of Gregory to that of Guido, there was no other distinction of keys than that of authentic and plagal; nor were any semitones used but those from E to F, B to C, and occasionally A to B.

With respect to the music of the primitive church, it may be observed, that though it consisted in the singing of psalms and hymns, yet it was performed in many different ways; sometimes the psalms were sung by one person alone, whilst the rest attended in silence; sometimes they were sung by the whole assembly; sometimes alternately, the congregation being divided into separate choirs; and sometimes by one person, who repeated the first part of the verse, the rest joining in the close of it. Of the four different methods of singing now recited, the second and third were properly distinguished by the names of *symphony* and *antiphony*; and the latter was sometimes called *responsaria*, in which women were allowed to join. St Ignatius, who, according to Socrates (lib. vi. cap. 8.), conversed with the apostles, is generally supposed to have been the first who suggested to the primitive Christians in the East the method of singing hymns and psalms alternately, or in dialogues; and the custom soon prevailed in every place where Christianity was established; though Theodoret in his history (lib. ii. cap. 24.) tells us, that this manner of singing was first practised at Antioch. It likewise appears, that almost from the time when music was first introduced into the service of the church, it was of two kinds, and consisted in a gentle inflection of the voice, which they termed plain song, and a more elaborate and artificial kind of music, adapted to the hymns and solemn offices contained in its ritual; and this distinction has been maintained even to the present day.

Although we find a very early distinction made between the manner of singing the hymns and chanting the psalms, it is, however, the opinion of the learned Martini, that the music of the first five or six ages of the church consisted chiefly in a plain and simple chant of unisons and octaves, of which many fragments are still remaining in the *canto fermo* of the Romish missals. For with respect to music in parts, as it does not appear, in these early ages, that either the Greeks or Romans were in possession of harmony or counterpoint, which has been generally ascribed to Guido, a monk of Arezzo in Tuscany, about the year 1022, though others have traced the origin of it to the eighth century, it is in vain to seek it in the church. The choral music, which had its rise in the church of Antioch, and from thence spread through Greece, Italy, France, Spain, and Germany, was brought into Britain by the singers who accompanied Austin the monk, when he came over, in the year 596, charged with a commission to convert the inhabitants of this country to Christianity. Bede tells us, that when Austin and the companions of his mission had their first audience of King Ethelbert, in the isle of Thanet, they approached him in procession, singing litanies; and that afterwards, when they entered the city of Canterbury, they sung a litany, and at the end of it Alleluiah. But though this was the first time the Anglo-Saxons had heard the Gregorian chant, yet Bede likewise tells us, that our British ancestors had been instructed in the rites and ceremonies of the Gallican

church by St Germanus, and heard him sing Alleluiah many years before the arrival of St Austin. In 680, John, predecessor of St Peter's in Rome, was sent over by Pope Agatho to instruct the monks of Weremouth in the art of singing; and he was prevailed upon to open schools for teaching music in other places in Northumberland. Benedict Biscop, the preceptor of Bede, Adrian the monk, and many others, contributed to disseminate the knowledge of the Roman chant. At length the successors of St Gregory, and of Austin his missionary, having established a school for ecclesiastical music at Canterbury, the rest of the island was furnished with masters from that seminary. The choral service was first introduced in the cathedral church of Canterbury; and till the arrival of Theodore, and his settlement in that see, the practice of it seems to have been confined to the churches of Kent; but after that, it spread over the whole kingdom; and we meet with records of very ample endowments for the support of this part of public worship. This mode of religious worship prevailed in all the European churches till the time of the Reformation: the first deviation from it is that which followed the Reformation by Luther, who, being himself a lover of music, formed a liturgy, which was a musical service, contained in a work entitled *Psalmodia*, h. e. *Cantica sacra Veteris Ecclesie selecta*, printed at Norimberg in 1553, and at Wittemberg in 1561. But Calvin, in his establishment of a church at Geneva, reduced the whole of divine service to prayer, preaching, and singing; the latter of which he restrained. He excluded the offices of the antiphon, hymn, and motet, of the Romish service, with that artificial and elaborate music to which they were sung; and adopted only that plain metrical psalmody, which is now in general use among the reformed churches, and in the parochial churches of our own country. For this purpose he made use of Marot's version of the Psalms, and employed a musician to set them to easy tunes only of one part. In 1553, he divided the Psalms into pauses or small portions, and appointed them to be sung in churches. Soon after they were bound up with the Geneva catechism; from which time the Catholics, who had been accustomed to sing them, were forbid the use of them, under a severe penalty. Soon after the Reformation commenced in England, complaints were made by many of the dignified clergy and others of the intricacy and difficulty of the church-music of those times: in consequence of which it was once proposed, that organs and curious singing should be removed from our churches. Later in his diocese of Worcester, went first father, and issued injunctions to the prior and convent of St Mary, forbidding in their service all manner of singing. In the reign of Edward VI. a commission was granted to eight bishops, eight divines, eight civilians, and eight common lawyers, to compile a body of such ecclesiastical laws as should in future be observed throughout the realm. The result of this compilation was a work first published in 1571 by Fox the martyrologist, and afterwards in 1640, under the title of *Reformatio Legum Ecclesiasticarum*. These 32 commissioners, instead of reprobatng church-music, merely condemned figurative and operose music, or that kind of singing which abounded with figures, responsive passages, and a mixture of various and intricate proportions; which, whether extemporary or written, is by musicians termed *delectant*. How-

Service.

Service
II
Servant

ever, notwithstanding the objections against choral music, and the practice of some of the reformed churches; the compilers of the English liturgy in 1549, and the king himself, determined to retain musical service. Accordingly the Statute 2 Edw. VI. cap. 1. though it contains no formal objection on the clergy, or others, to use or join in either vocal or instrumental music in the common prayer, does clearly recognize the practice of singing; and in less than two years after the compiling of King Edward's liturgy, a formula was composed, which continues, with scarce any variation, to be the rule for choral service even at this day. The author of this work was John Marbeck, or Mabelke; and it was printed by Richard Graecum, in 1550 under the title of the Book of Common Prayer, named. Queen Mary laboured to restore it with the Romish choral service; but the accession of Elizabeth was followed by the act of uniformity; in consequence of which, and of the queen's high resolutions, the Book of Common Prayer, noted by Marbeck, was considered as the general formula of choral service. In 1562, another musical service, with some additions and improvements, was printed by John Day; and in 1568, another collection of offices, with musical notes. Many objections were urged by Cartwright and other Puritans against the form and manner of choral service, to which Hooker replied in his Ecclesiastical Polity. In 1662, the Statutes of Edward VI. and Elizabeth, for uniformity in the Common Prayer, were repealed; and the Directory for Public Worship, which allows only of the singing of psalms, established. But upon the restoration of Charles II. choral service was again revived, and has since uniformly continued. See on this subject Hawkins's History of Music, vol. i. p. 403, vol. ii. p. 264, vol. iii. p. 38—408, 820, vol. iv. p. 44—347.

SERVICE-Tree. See **SORBUS**, **BOTANY** Index.

SERVITES, a religious order in the church of Rome, founded about the year 1233, by seven Florentine merchants, who, with the approbation of the bishop of Florence, renounced the world, and lived together in a religious community on Mount Senar, two leagues from that city.

SERVITOR, in the university of Oxford, a student who attends on another for his maintenance and learning. See **SIZAR**.

SERVITUDE, the condition of a servant, or rather slave.

Under the declension of the Roman empire, a new kind of servitude was introduced, different from that of the ancient Romans: it consisted in leaving the lands of subjugated nations to the first owners, upon condition of certain rents, and servile offices, to be paid in acknowledgement. Hence the names of *servi censiti*, *ascripti*, and *addicti glebe*; some whereof were taxable at the reasonable discretion of the lord; others at a certain rate agreed on; and others were inmortable, who, having no legitimate children, could not make a will to above the value of five pence, the lord being heir of all the rest; and others were prohibited marrying, or going to live out of the lordship. Most of these services existed lately in France; but they were long ago abolished in England. Such, however, was the original of our tenures, &c. See **SLAVE**.

SERVITUDE, in *Scots Law*. See **LAW**, Part III. Sect. ix.

SERVIUS, **MATRUS HONORATUS**, a celebrated grammarian and critic of antiquity, who flourished about the time of Aeneas and Horatius; now chiefly known by his Commentaries on Virgil. There is also extant a piece of Servius upon the feet of verses and the quantities of Syllables, called *Grammaticum*.

SERUM, a thin, transparent, limpid liquor, which makes a considerable part of the mass of blood. See **ANATOMY** and **CHEMISTRY** Index.

SERRAHOEBA *ossa*, certain small bones, whence what resembling the roots of Asafoetida, whence their name. They are placed at the under part of the bones of the last joints of the fingers and toes.

SILANIUM, **OILY GRASS**; a genus of plants belonging to the class didymia; and in the natural system ranging under the 22nd order, *Trichia*. See **BOTANY** Index.

SISYLIA, **MEADOW SANITRACE**; a genus of plants belonging to the class pentandria; and in the natural system ranging under the 45th order, *Umbellatae*. See **BOTANY** Index.

SISOSTRIS, King of Egypt. See **EGYPT**, p. 591.

SISTUI, a Latin participle, signifying a whole and a half; which, joined with *advers*, *tertia*, *quarta*, &c. is much used in the Italian music to express a kind of ratios, particularly several species of triples.

SISTUI-Advers, in *Geometry* and *Arithmetic*, is a ratio between two lines, two numbers, or the like, where one of them contains the other once, with the addition of a half.

Thus 6 and 9 are in a *sempiternitate* ratio; since 9 contains 6 once, and 3, which is half of 6, over; and 22 and 30 are in the same; as 30 contains 22, and half 22 or 11.

SISTUI Duplicate ratio, is when of two terms the greater contains the less twice, and half the less remains; as 15 and 6: 30 and 20.

SISTUI Tertional proportion, is when any number or quantity contains another once and one third.

SISYLIA, among botanists. See **BOTANY**.

SESSION, in general, denotes each sitting or assembly of a court, &c.

SESSION of Parliament, is the season or space from its meeting to its prorogation. See **PARLIAMENT**.

Kirk-SESSION, the name of a petty ecclesiastical court in Scotland. See **KIRK-Session**.

SESSIONS for weights and measures. In London, four justices from among the mayor, recorder, and aldermen (of whom the mayor and recorder is to be one), may hold a session to inquire into the offences of selling by false weights and measures, contrary to the statutes; and to receive indictments, punish offenders, &c. Char. King Charles I.

Court of SESSION. See **LAW**, Part III. Sect. ii.

Kirk-Quarter-SESSIONS, an English court that must be held in every county once in every quarter of a year; which, by statute 2 Henry V. c. 4. is appointed to be in the first week after Michaelmas-day, the first week after the epiphany, the first week after the close of Easter, and in the week after the translation of St Thomas the martyr, or the 7th of July. It is held before two or more justices of the peace, one of which must be of the quorum. The jurisdiction of this court, by 24 Edward III. c. 1. extends to the trying and determining all felonies and trespasses whatsoever: though they seldom,

Servius
II
Session

dom, if ever, try any greater offences than in feloies within the benefit of clergy; their conduct in providing, that if any case of difficulty arises, they shall not proceed to judgement, but in the presence of one of the justices of the courts of king's bench or common-pleas, or one of the judges of assize; and therefore murders, and other capital felonies, are usually remitted for a more solemn trial to the assizes. They cannot also try any new-created offence, without express power given them by the statute which creates it. But there are many offences and particular matters which, by particular statutes, belong properly to this jurisdiction, and ought to be proceeded in this court; as, the smaller misdemeanors against the public or commonwealth, not amounting to felony; and especially offences relating to the game, highways, alehouses, bastard children, the settlement and provision for the poor, vagrants, servants wage, and Parish recusants. Some of these are proceeded upon by indictment: others in a summary way, by motion, and order thereupon; which order may for the most part, unless guarded against by particular statutes, be removed into the court of king's bench by writ of *certiorari facias*, and be there either quashed or confirmed. The records or rolls of the felonies are committed to the custody of a special officer, denominated *custos rotulorum*, who is always a justice of the quorum; and among them of the quorum (Guth Lambard) a man for the most part especially picked out, either for wisdom, countenance, or credit. The nomination of the *custos rotulorum* (who is the principal officer in the county, as the lieutenant is chief in military command) is by the king's sign manual: and to him the nomination of the clerk of the peace belongs; which office he is expressly forbidden to sell for money.

In most corporation-towns there are quarter-felons kept before justices of their own, within their respective limits; which have exactly the same authority as the general quarter-felons of the county, except in a very few instances; one of the most considerable of which is the matter of appeals from orders of removal of the poor, which, though they be from the orders of corporation-justices, must be to the felons of the county, by statute 8 and 9 William III. c. 35. In both corporations and counties at large, there is sometimes kept a fiscal or petty felon, by a few justices, for dispatching smaller business in the neighbourhood between the times of the general felons: as for licensing alehouses, passing the account of parish officers, and the like.

SESTERCE, SESTERTIUS, a silver coin, in use among the ancient Romans, called also simply *nummus*, and sometimes *numus sesterterius*. The sesterterius was the fourth part of the denarius, and originally contained two asses and a half. It was at first denoted by LLS; the two L's signifying two librae, and the S half. But the librarii, afterwards converting the two L's into an H, expressed the sesterterius by HS. The word *sesterterius*, which signifies two, and a half of a third, or, literally, only half a third; for in expressing half a third, it was understood that there were two before.

Some authors make the two kinds of sesterces; the less called *sesterterius*, in the masculine gender; and the great one, called *sesterterium*, in the neuter; the first, that we have already described; the latter containing a thousand

of the less. Others will have any full Latin word of great and little values unknown to the Romans; *sesterterius*, by this, was an adjective, and signified a sesterterius, or two asses and a half; and when used in the plural, as in *sestertiana sesterterius*, or *sesterterii*, it was only by way of abbreviation, and there was always understood *centena milia*, &c.

This matter has been accurately listed by Mr Bayer, in the following manner. The denomination to which sesterterius related is either *as*, or *pondus*; and *sesterterius* is two asses and a half; *sestertiana pondus*, two pondus and a half, or two hundred and thirty denarii. When the denarius passed for ten asses, the sesterterius of two asses and a half was a quarter of it; and the Romans continued to keep their accounts in this it takes long after the denarius passed for sixteen asses; till, growing rarer, they found it more convenient to reckon by quarters of the denarius, which they called *nummi*, and used the words *nummi* and *sesterterii* indifferently, as synonymous terms, and sometimes both together, as *sesterterii nummi*; in which case the word *sesterterius*, having lost its original signification, was used as a substantive; for *sesterterius nummus* was not two nummi and a half, but a single nummus of four asses. They called any sum under two thousand sesterces to many *sesterterii* in the masculine gender; two thousand sesterces they called *dena*, or *dena sesterterii*, in the neuter; for many quarters making five hundred denarii, which was twice the sesterterius; and they said *dena, vacua*, &c. *sesterterii*, till the sum amounted to a thousand sesterterii, which was a million of sesterces. But, to avoid ambiguity, they did not use the neuter *sesterterium* in the singular number, when the whole sum amounted to no more than a thousand sesterces, or one sesterterium. They called a million of sesterces *decies nummius*, or *decies sesterterium*, for *decies centena milia nummorum*, or *sestertiorum* (in the masculine gender), omitting *centena milia* for the sake of brevity. They likewise called the same sum *decies sesterterium* (in the neuter gender) for *decies centes sesterterium*, omitting *centes* for the same reason; or simply *decies*, omitting *centena milia sesterterium*, or *centes sesterterium*; and with the numeral adverbs *duos, quos, centes, milies*; and the like, either *centena milia* or *centes* was always understood. There were several other vital forms of expression; though for *dena, dena, vacua sesterterii*, they frequently said *dena, dena, vacua milia nummorum*. If the confular denarius contained 60 Troy grains of fine silver, it was worth five times more than its present value, and a half sterling; and the *as*, of 16 to the denarius, a little more than a half-penny. To reduce the ancient sesterces of two asses and a half, when the denarius passed for 16, to pounds sterling, multiply the given number by 5124, and cut off six figures on the right hand for decimals. To reduce *nummi sesterterii*, or quarters of the denarius, to pounds sterling; if the given sum be confular money, multiply it by 8722, and cut off six figures on the right hand for decimals; but for imperial money divided the said product by one eighth of itself. Phil. Trans. v. 1. 14. part II. art. 48.

To be qualified for a Roman knight, an estate of 400000 sesterces was required; and for a senator, of 800000.

Authors also mention a copper *as sere*, worth about one-third of a penny English.

SESTERCE, or *sesterterius*, was also used by the ancients

Seth
Seth.

for a thing containing two wholes and an half of another, as *ar* was taken for any whole or integer.

SETIOS, a noted fortress of European Turkey, situated at the entrance of the Hellespont or Dardanelles, 24 miles south-west of Gallipoli. This place is famous for the loves of **HERO** and **LEANDER**, sung by the poet **Museus**.

SESUVIUM, a genus of plants belonging to the class icolandria. See **BOTANY Index**.

SET, or **SETS**, a term used by the farmers and gardeners to express the young plants of the white thorn and other shrubs, with which they use to raise their quick or quick-set hedges. The white thorn is the best of all trees for this purpose; and, under proper regulations, its sets seldom fail of answering the farmer's utmost expectations.

SET-off, in *Law*, is an act whereby the defendant acknowledges the justice of the plaintiff's demand on the one hand; but, on the other, lets up a demand of his own, to counterbalance that of the plaintiff, either in the whole, or in part: as, if the plaintiff sues for 10*l*. due on a note of hand, the defendant may set off 9*l*. due to himself for merchandise sold to the plaintiff; and, in case he pleads such set-off, must pay the remaining balance into court. This answers very nearly to the *compensatio* or forpage of the civil law, and depends upon the statutes 2 Geo. II. cap. 22. and 8 Geo. II. cap. 24.

SETACEOUS WORM, in *Natural History*, a name given by Dr Lister to that long and slender water-worm, which so much resembles a horse-hair, that it has been supposed by the vulgar to be an animated hair of that creature. These creatures, supposed to be living hairs, are a peculiar sort of insects, which are bred and nourished within the bodies of other insects, as the worms of the ichneumon flies are in the bodies of the caterpillars.

Aldrovand describes the creature, and tells us it was unknown to the ancients; but called *feta aquatica*, and *vermis fetarius*, by the moderns, either from its figure resembling that of a hair, or from the supposition of its once having been the hair of some animal. We generally suppose it, in the imaginary state of the hair, to have belonged to a horse; but the Germans say it was once the hair of a calf, and call it by a name signifying *vitulus aquaticus*, or the "water calf."

Albertus, an author much revered by the common people, has declared that this animal is generated of a hair; and adds, that any hair thrown into standing water, will, in a very little time, obtain life and motion. Other authors have dissented from this opinion, and supposed them generated of the fibrous roots of water-plants; and others, of the parts of grasshoppers fallen into the water. This last opinion is rejected by Aldrovand as the most improbable of all. Standing and foul waters are most plentifully stored with them; but they are sometimes found in the clearest and purest springs, and sometimes out of the water, on the leaves of trees and plants, as on the fruit-trees in our gardens, and the elms in hedges. They are from three to five inches long, of the thickness of a large hair; and are brown upon the back, and white under the belly, and the tail is white on every part.

SETH, the third son of Adam, the father of Enos, was born 3874 B. C. and lived 912 years.

SETHIANS, in church history, Christian heretics; so called because they paid divine worship to Seth, whom they looked upon to be Jesus Christ the son of God, but who was made by a third divinity, and substituted in the room of the two families of Abel and Cain, which had been destroyed by the deluge. These heretics appeared in Egypt in the second century; and as they were addicted to all sorts of debauchery, they did not want followers; and continued in Egypt above 200 years.

SETIMO, a town of Italy, in the province of Piedmont, situated on the river Po, eight miles north of Turin.

SETON, in *Surgery*, a few horse hairs, small threads, or large packthread, drawn through the skin, chiefly the neck, by means of a large needle or probe, with a view to reitore or preserve health.

Experience shews that setons are useful in catarrhs, inflammations, and other disorders, and particularly those of the eyes; to these may be added severe headachs, with stupor, drowiness, epilepsies, and even apoplexy itself. See **SURGERY**.

SETTEE, in sea-language, a vessel very common in the Mediterranean with one deck and a very long and sharp prow. They carry some two masts, some three, without top-masts. They have generally two masts, equipped with triangular sails, commonly called *lateen sails*. The least of them are of 60 tons burden. They serve to transport cannon and provisions for ships of war and the like. These vessels are peculiar to the Mediterranean sea, and are usually navigated by Italians, Greeks, or Mahometans.

SETTING, in *Astronomy, the withdrawing of a star or planet, or its sinking below the horizon. Astronomers and poets make three different kinds of setting of the stars, viz. the **COSMICAL**, **ACRONYCAL**, and **HELLICAL**. See these articles.*

SETTING, in the sea language. To set the land or the sun by the compass, is to observe how the land bears on any point of the compass, or on what point of the compass the sun is. Also when two ships sail in sight of one another, to mark on what point the chased bears, is termed *setting the chase by the compass*.

SETTING, among sportsmen, a term used to express the manner of taking partridges by means of a dog peculiarly trained to that purpose. See **SHOOTING**.

ACT OF SETTLEMENT, in British history, a name given to the statute 12 and 13 Will. III. cap. 2. whereby the crown was limited to his present majesty's illustrious house; and some new provisions were added, at the same fortunate era, for better securing our religion, laws, and liberties: which the statute declares to be the birthright of the people of England, according to the ancient doctrine of the common law.

SEVEN STARS, a common denomination given to the cluster of stars in the neck of the sign Taurus, the bull; properly called the *Pleiades*. They are so called from their number seven, which appear to the naked eye, though some eyes can discover only six of them; but by the aid of telescopes there appears to be a great multitude of them.

SEVENTH, in *Music*, an interval called by the Greeks *heptachordon*. See **INTERVAL**.

SEVERANCE, in *Law*, the singling or severing two or more that join or are joined in the same writ or action.

Sethian
Severance.

Severance
N
Severn.

tion. As if two join in a writ, *de libertate probanda*, and the one be afterwards nonsuited; here severance is permitted, so as notwithstanding the nonsuit of the one, the other may severally proceed.

There is also severance of the tenants in affize; when one, two, or more difficulties appear upon the writ, and not the other. And severance in debt, where two executors are named plaintiffs, and the one refuses to prosecute. We also meet with severance of summons, severance in attainds, &c. An estate in joint tenancy may be severed and destroyed by destroying any of its unities.

1. That of time, which respects only the original commencement of the joint estate, cannot indeed (being now part) be affected by any subsequent transaction. But, 2. The joint-tenants estate may be destroyed without any alienation, by merely disuniting their possession. 3. The jointure may be destroyed, by destroying the unity of title. And, 4. By destroying the unity of interest.

SEVERIA, a province of the Russian empire, with the title of a duchy, bounded on the north by Smolensko and Mufcovy, on the east by Vorotinski and the country of the Cossicks, on the south by the same, and on the west by Zernegovia. It is a country overrun with woods, and on the south part is a forest of great length. Novogrodec, or Novogorod, is the capital town.

St SEVERINA, a town of Italy, in the kingdom of Naples, and in Lower Calabria, with an archbishop's see. It is very well fortified, and seated on a craggy rock, on the river Necto; in E. Long. 17. 14. N. Lat. 39. 15.

SEVERINO, a town of Italy, in the territory of the church, and in the Marche of Ancona, with a bishop's see. It has fine vineyards, and is seated between two hills on the river Petenza, in E. Long. 13. 6. N. Lat. 43. 16.

SEVERN, a river of England which rises near Plumlimmon Hill in Montgomeryshire, and before it enters Shropshire receives about 30 streams, and passes down to Ludring, where it receives the Morda, that flows from Olivestry. When it arrives at Monford, it receives the river Mon, passing on to Shrewsbury, which it almost surrounds, then to Bridgewater; afterwards it runs through the skirts of Staffordshire, enters Worcestershire, and passes by Worcester; then it runs to Tewkesbury, where it joins the Avon, and from thence to Gloucester, keeping a north-westerly course, till it falls into the Brittol Channel. It begins to be navigable for boats at Welchpool, in Montgomeryshire, and takes in several other rivers in its course, besides those already mentioned, and is the second in England. By the late inland navigation, it has communication with the rivers Mersey, Dee, Ribble, Ouse, Trent, Derwent, Humber, Thames, Avon, &c. which navigation, including its windings, extends above 520 miles in the counties of Lincoln, Nottingham, York, Lancaster, Westmoreland, Cheshire, Stafford, Warwick, Leicester, Oxford, Worcester, &c. A canal from Stroud-Water, a branch of the Severn, to join the Thames, was projected and executed for the purpose of conveying a tunnel 16 feet high and 16 feet wide, under Sapperton Hill and Hayley-Wood (very high ground), for two miles and a quarter in length, through a very hard rock, which was lined and arched with brick. This stupendous undertaking was completed, and boats passed through it the

Lucas's
English
Gazetteer.

21st of May 1789. By this opening, a communication is made between the river Severn at Framiload and the Thames near Lechlade, and will be continued over the Thames near Ingletham, into deep water in the Thames below St John-Bridge, and so to Oxford, &c. and London, for conveyance of coals, goods, &c. It is now navigable from the Severn to Themsford, by way of Stroud, Cirencester, Cricklade, &c. being filled with water for that purpose near 40 miles.

SEVERIUS, CORNELIUS, an ancient Latin poet of the Augustan age; whose *Ætina*, together with a fragment *De morte Ciceronis*, were published, with notes and a prose interpretation, by Le Clerc, 12mo, Amsterdam, 1723. They were before inserted among the *Catalœta Virgiliti* published by Scaliger; whose notes, with others, Le Clerc has received among his own.

SEVERUS, *Septimus*, a Roman emperor, who has been so much admired for his military talents, that some have called him the most warlike of the Roman emperors. As a monarch he was cruel, and it has been observed that he never did an act of humanity or forgave a fault. In his diet he was temperate, and he always showed himself an open enemy to pomp and splendor. He loved the appellation of a man of letters, and he even composed an history of his own reign, which some have praised for its correctness and veracity. However cruel Severus may appear in his punishments, and in his revenge, many have endeavoured to exculpate him, and observed that there was need of severity in an empire where the morals were so corrupted, and where no less than 3000 persons were accused of adultery during the space of 17 years. Of him, as Augustus, some were disposed to say, that it would have been better for the world if he had never been born, or had never died. See ROME, N^o 372.

SEVERUS'S Wall, in British topography, the fourth and last barrier erected by the Romans against the incursions of the North Britons. See the articles ADRIAN, and ANTONINUS'S Wall.

We learn from several hints in the Roman historians, that the country between the walls of Hadrian and Antoninus continued to be a scene of perpetual war and subject of contention between the Romans and Britons, from the beginning of the reign of Commodus to the arrival of the emperor Septimius Severus in Britain, A. D. 206. This last emperor having subdued the Maعات, and repulsed the Caledonians, determined to erect a stronger and more impetenable barrier than any of the former, against their future incursions.

Though neither Dio nor Herodian make any mention of a wall built by Severus in Britain for the protection of the Roman province, yet we have abundant evidence from other writers of equal authority, that he really built such a wall. "He fortified Britain (says Sparian) with a wall drawn across the island from sea to sea; which is the greatest glory of his reign. After the wall was finished, he retired to the next station (York), not only a conqueror, but the founder of an eternal peace." To the same purpose, Aurelius Victor and Orosius, to say nothing of Eutropius and Cassiodorus: "Having repelled the enemy in Britain, he fortified the country, which was suited to that purpose, with a wall drawn cross the island from sea to sea." "Severus drew a great ditch, and built a strong wall,

Severus,
Severus.

fortified with several turrets, from sea to sea, to protect that part of the island which he had recovered from the yet unconquered nations." As the residence of the emperor Severus in Britain was not quite four years, it is probable that the two last of them were employed in building this wall; according to which account, it was begun A. D. 209, and finished A. D. 211.

This wall of Severus was built nearly on the same tract with Hadrian's rampart, at the distance only of a few paces north. The length of this wall, from Confin's house near the mouth of the river Tyne on the east, to Baulbes on the Salway frith on the west, hath been found, from two actual measurements, to be a little more than 68 English miles, and a little less than 74 Roman miles. To the north of the wall was a broad and deep ditch, the original dimensions of which cannot now be ascertained, only it seems to have been larger than that of Hadrian. The wall itself, which stood on the south brink of the ditch, was built of freestone, and where the foundation was not good, it is built on piles of oak; the interstices between the two faces of this wall is filled with broad thin stones, placed not perpendicularly, but obliquely on their edges; the running mortar or cement was then poured upon them, which, by its great strength and tenacity, bound the whole together, and made it firm as a rock. But though these materials are sufficiently known, it is not easy to guess where they were procured, for many parts of the wall are at a great distance from any quarry of freestone; and, though stone of another kind was within reach, yet it does not appear to have been anywhere used. The height of this wall was 12 feet besides the parapet, and its breadth 8 feet, according to Bede, who lived only at a small distance from the east end of it, and in whose time it was in many places almost quite entire. Such was the wall erected by the command and under the direction of the emperor Severus in the north of England; and, considering the length, breadth, height, and solidity, it was certainly a work of great magnificence and prodigious labour. But the wall itself was but a part, and not the most extraordinary part, of this work. The great number and different kinds of fortresses which were built along the line of it for its defence, and the military ways with which it was attended, are still more worthy of our admiration, and come now to be described.

The fortresses which were erected along the line of Severus's wall for its defence, were of three different kinds, and three different degrees of strength; and were called by three different Latin words, which may be translated *stations*, *castles*, and *turrets*. Of each of these in their order.

The *stations*, or stations, were so called from their stability, and the stated residence of garrisons. They were also called *castra*, which hath been converted into *castles*, a name which many of them still bear. These were by far the largest, strongest, and most magnificent of the fortresses which were built upon the wall, and were designed for the head-quarters of the cohorts of troops which were placed there in garrison, and from whence detachments were sent into the adjoining cities and towns. These stations, as appears from the vestiges of them which are still visible, were not all exactly of the same figure nor of the same dimensions; some of them being exactly square, and others oblong, and some of

them a little larger than others. These variations were no doubt occasioned by the difference of situation and other circumstances. The stations were fortified with deep ditches at all along walls, the wall itself coinciding with and forming the north wall of each station. Within the ditches were lodgings for the officers and soldiers in great part of the battlements, there being sufficient to contain a cohort, or 600 men. Whether the walls of each station was a town, inhabited by labourers, artificers, and others, both Romans and Britons, who chose to dwell under the protection of these fortresses. The number of the stations upon the wall was exactly 18; and if they had been placed at equal distances, the interval between every two of them would have been four miles and a few paces: but the intervention of rivers, marshes, and mountains; the convenience of situations for strength, prospect, and water; and many other circumstances to us unknown, determined them to place these stations at unequal distances. The situation which was always chosen by the Romans, both here and everywhere else in Britain where they could obtain it, was the gentle declivity of a hill, near a river, and facing the meridian sun. Such was the situation of the far greater part of the stations on this wall. In general, we may observe, that the stations stood thickest near the two ends and in the middle, probably because the danger of invasion was greatest in these places. But the reader will form a clearer idea of the number of these stations, their Latin and English names, their situation and distance from one another, by inspecting the following table, than we can give him with equal brevity in any other way. The first column contains the number of the station, reckoning from east to west; the second contains its Latin, and the third its English name; and the three last its distance from the next station to the west of it, in miles, furlongs, and chains.

N ^o	Latin Name	English Name	M.	F.	C.
1	Segedunum	Confin's-house	3	5	13
2	Pons Ælii	Newcastle	2	0	9
3	Condercum	Benwell-hill	6	6	5
4	Vindobala	Batcheller	7	0	33
5	Hannum	Halton-chesters	5	1	7
6	Cilnurnum	Walwick-chesters	3	1	8
7	Procolitia	Carru-brugh	4	5	53
8	Borocovicus	Houdeleeds	1	3	8
9	Vindolana	Little-chesters	3	6	4
10	Ælica	Great-chesters	2	1	61
11	Magna	Carvoran	2	6	6
12	Amboglana	Burdoswald	6	2	8
13	Petrona	Cambeck	2	6	6
14	Aballaba	Waltercros	5	1	9
15	Conyvara	Stanwix	3	3	4
16	Axelbanum	Brugh	4	0	9
17	Corbientum	Brambrugh	3	4	1
18	Tannoclan	Baulbes	0	0	0
		Length of the wall	68	3	3

The *castella*, or castles, were the second kind of fortifications which were built along the line of this wall for its defence. These castles were neither so large nor strong

Severus. Fromg as the flutons, but much more numerous, being not over than 84. The shape and dimensions of the castles, as appears from the foundations of many of them which are still entire, were exact squares of 60 feet every way. They were finished on every side with thick and lofty walls, but without any ditch, except on the north side; on which the wall itself raised much above its usual height, with the ditch ascending, it faced the fortification. The castles were situated in the intervals between the flutons, at the distance of about seven furlongs from each other; though particular circumstances sometimes occasioned a little variation. In these castles, guards were constantly kept by a competent number of men detached from the nearest flutons.

The *turrets*, or towers, were the third and last kind of fortifications on the wall. They were still much finer than the castles, and formed by a square of about 12 feet, it being one of the wall on its fourth side. Being so small, they are more exactly round than the flutons and castles, which makes it difficult to discern their exact number. They stood in the intervals between the castles; and from the short verges of a few of them, it is conjectured that there were four of them between every two castles, at the distance of about 300 yards from one another. According to this conjecture, the number of the turrets amounted to 324. They were designed for watch-towers and places for sentinels, who, being within hearing of one another, could convey an alarm or piece of intelligence to all parts of the wall in a very little time.

Such were the flutons, castles, and turrets, on the wall of Severus; and a very considerable body of troops was constantly quartered in them for its defence. The usual complement allowed for this service was as follows:

1. Twelve cohorts of foot, consisting of 600 men each,	7200
2. One cohort of mariners in the station at Boulogne,	600
3. One detachment of Moors, probably equal to a cohort,	600
4. Four aloe or wings of horse, consisting, at the lowest computation, of 400 each,	1600
	<hr/>
	10,000

For the conveniency of marching these troops from one part of the wall to another, with the greater ease and expedition, on any service, it was attended with two military ways, paved with square stones, in the most solid and beautiful manner. One of these ways was smaller, and the other larger. The smaller military way ran close along the fourth side of the wall, from turret to turret, and called to castle, for the use of the soldiers in relieving their guards and sentinels, and such services. The larger way did not keep so near the wall, nor touch at the turrets or castles, but pursued the most direct course from one station to another, and was designed for the conveniency of marching larger bodies of troops.

It is to be regretted, that we cannot gratify the reader's curiosity, by informing him by what particular bodies of Roman troops the several parts of this great work were executed; as we were enabled to do with regard

to the wall of Antoninus Pius from inscriptions. For the English is of this nature, that there were 12 cohorts of troops, and the quantity of work performed by each of them, originally inserted in the face of this wall, yet none of them are now to be found. There have indeed been discovered, in or near the ruins of this wall, a great number of small square stones, with very short, and generally imperfect, Latin inscriptions upon them, mentioning particular names, cohorts, and centurions; but without direct inscriptions that they had built any part of the wall, or mention any number of years. On these inscriptions, they did not say less than 20 years; and this among the Northumberland and Cumberland inscriptions in Mr Hales's *British Roman*. As the stones of which the British towers are cut out of the same stone, and the walls the other fortifications of this wall, it is not improbable that they have been originally placed in the face of it. It is equally certain, from the uniformity of the inscriptions, that they were all intended to intimate the same thing, and nothing so probable as that the adjacent wall was built by the troops mentioned in them. This was, perhaps, so well understood, that it was not thought necessary to be expressed; and the distance of these inscriptions from one another showed the quantity of work performed. If this was really the case, we know in general, that this great work was executed by the second and sixth legions, these being the only legions mentioned in these inscriptions. Now, if this peculiar wall, with all its appendages or ditches, flutons, castles, turrets, and military ways, was executed in the space of two years by two legions only, which, when most complete, made no more than 12,000 men, how greatly must we admire the skill, the industry, and excellent discipline of the Roman soldiers, who were not only the valiant guardians of the empire in times of war, but its most active and useful members in times of peace?

This wall of Severus, and its fortresses, proved an impregnable barrier to the Roman territories for near 200 years. But about the beginning of the 5th century, the Roman empire being assaulted on all sides, and the bulk of their forces withdrawn from Britain, the Manx and Caledonians, now called Scots and Picts, became more daring; and some of them breaking through the wall, and others filling round the ends of it, they carried their ravages into the very heart of Provincial Britain. These invaders were indeed several times repulsed after this by the Roman legions sent to the relief of the Britons. The last of these legions, under the command of Gallo of Ravenna, having, with the assistance of the Britons, thoroughly repaired the breaches of Severus's wall and its fortresses, and exhorted the Britons to make a brave defence, took their final farewell of Britain. It soon appeared, that the troops, walls and ramparts are no security to an undisciplined and destitute rabble, as the unhappy Britons then were. The Scots and Picts met with little resistance in breaking through the wall, while the towns and castles were timely abandoned to their destructive rage. In many places they levelled it with the ground, that it might prove no obstruction to their future invasions.—From this time no attempts were ever made to repair this noble work. Its beauty and grandeur procured it no respect in the dark and tasteless ages which succeeded. It became

Seigné.

came the common quarry for more than a thousand years, out of which all the towns and villages around were built; and is now so entirely ruined, that the penetrating eyes of the most poring and patient antiquarian can hardly trace its vanishing foundations.

SEVIGNE, MARIE DE RAUTIN, MARQUISE DE, a French lady, was born in 1626. When only a year old she lost her father, who was killed in the descent of the English on the isle of Rhé, where he commanded a company of volunteers. In 1644 she married the marquis of Sevigné, who was slain in a duel by the chevalier d'Albret, in 1651. She had by him a son and a daughter, to the education of whom she afterwards religiously devoted herself. Her daughter was married in 1669 to the count of Grignan, who conducted her to Provence. Madame de Sevigné consoled herself by writing frequent letters to her daughter. She fell at last the victim to her maternal tenderness. In one of her visits to Grignan, she fatigued herself so much during the sickness of her daughter, that she was seized with a fever, which carried her off on the 14th of January 1696. We have two portraits of Madame de Sevigné; the one by the compte de Bussi, the other by Madame de la Fayette. The first exhibits her defects; the second her excellencies. Bussi describes her as a lively gay coquette, a lover of flattery, fond of titles, honour, and distinction: M. de la Fayette as a woman of wit and good sense, as possessed of a noble soul, formed for dispensing benefits, incapable of debasing herself by avarice, and blessed with a generous, obliging, and faithful heart. Both these portraits are in some measure just. That she was vain-glorious, appears evident from her own letters, which, on the other hand, exhibit undoubted proofs of her virtue and goodness of heart.

This illustrious lady was acquainted with all the wits of her age. It is said that she decided the famous dispute between Perrault and Boileau concerning the preference of the ancients to the moderns, thus, "The ancients are the finest, and we are the prettiest." She left behind her a most valuable collection of letters, the best edition of which is that of 1775, in 8 vols 12mo. "These letters (says Voltaire) are filled with anecdotes, written with freedom, and in a natural and animated style; are an excellent criticism on studied letters of wit, and still more on those fictitious letters which aim at the epistolary style, by a recital of false sentiments and feigned adventures to an imaginary correspondent." It were to be wished that a proper selection had been made of these letters. It is difficult to read eight volumes of letters, which, though inimitably written, present frequent repetitions, and are often filled with trills. What makes them in general perhaps so interesting is, that they are in part historical. They may be looked on as a relation of the manners, the ton, the genius, the fashions, the etiquette, which reigned in the court of Louis XIV. They contain many curious anecdotes nowhere else to be found: But these excellencies would be still more striking, were they sometimes stripped of that multitude of domestic affairs and minute incidents which ought naturally to have died with the mother and the daughter. A volume entitled *Sevigniana* was published at Paris in 1756, which is nothing more than a collection of the fine sentiments, literary and historical

anecdotes, and moral apophthegms, scattered throughout these letters.

SEVILLE, a large and populous city of Spain, stands on the banks of the Guadalquivir, in the midst of a rich, and to the eye a boundless, plain; in W. Long. 5° 5', N. Lat. 37° 20'. This city is supposed to have been founded by the Phœnicians, who gave it the name of *Hispalis*. When it fell under the power of the Romans, it was called *Julia*; and at last, after a variety of corruptions, was called *Sevilla* or *Sevilla*; both of which names are retained by the Spaniards. The Romans embellished it with many magnificent edifices; of which scarce any vestige now remains. The Gothic kings for some time made it their residence: but in process of time they removed their court to Toledo; and Seville was taken by storm soon after the victory obtained at Xeres over the Gothic king Rodrigo.— In 1027, Seville became an independent monarchy; but was conquered 70 years afterwards by Yulef Almoravides, an African prince. At last it was taken by Ferdinand III. after a year's siege; and 300,000 Moors were then obliged to leave the place. Notwithstanding this prodigious emigration, Seville continued to be a great and populous city, and soon after it was enlarged and adorned with many magnificent buildings, the chief of which is the cathedral. Seville arrived at its utmost pitch of grandeur a little after the discovery of America, the reason of which was, that all the valuable productions of the West Indies were carried thither. Its court was then the most splendid in Europe; but in the course of a few years all this grandeur disappeared, owing to the impediments in navigating the Guadalquivir. The superior excellence of the port of Cadiz induced government to order the galleons to be stationed there in time to come.

Seville is of a circular form, and is surrounded by a wall about five miles and a half in circumference, containing 176 towers. The ditch in many places is filled up. The streets of Seville are crooked and dirty, and most of them so narrow that two carriages can scarcely pass one another abreast.

Seville is said to contain 80,268 souls, and is divided into 30 parishes. It has 84 convents, with 24 hospitals.

Of the public edifices of this city the cathedral is the most magnificent. Its dimensions are 420 feet in length, 263 in breadth within the walls, and 126 feet in height. It has nine doors, 80 altars, at which 500 masses are daily celebrated, and 80 windows of painted glass, each of which cost 1000 ducats. At one angle stands a tower of Moorish workmanship 350 feet high. On the top of it is the giralda, or large brazen image, which, with its palm branch, weighs near one ton and a half, yet turns as a weather-cock with the slightest variation of the wind. The whole work is brick and mortar. The passage to the top is an inclined plane, which winds about in the inside in the manner of a spiral staircase, so easy of ascent that a horse might trot from the bottom to the top; at the same time it is so wide that two horsemen may ride abreast. What appears very unaccountable, the solid masonry in the upper half is just as thick again as that in the lower, though on the outside the tower is all the way of the same dimensions. In the opinion of Mr Swinburne, this cathedral is inferior to York.

Siecle de
Louis XIV.
tom. II.

Townsend's
Travels,
vol. II.

Seville. York minster. Its treasures are inestimable; one altar with all its ornaments is solid silver; of the same metal are the images of St Lidore and St Leander, which are as large as the life; and a tabernacle for the host more than four yards high, adorned with 48 columns. Before the choir of the cathedral is the tomb of the celebrated Christopher Columbus, the discoverer of America. His monument consists of one stone only, on which these words are inscribed, *A Cuestia y Aragon otro mundo de Colon*; that is, "To Castile and Aragon Columbus gave another world;" an inscription simple and expressive, the plainness of which will be acknowledged by those who have read the adventures of this illustrious but unfortunate man. The cathedral was begun by Don Sancho the Brave, about the close of the 13th century, and finished by John II. about an hundred years after. To the cathedral belongs a library of 20,000 volumes, collected by Hernando the son of Columbus; but, to the disgrace of the Spaniards, it has scarcely received any addition since the death of the founder. The organ in this cathedral is a very ingenious piece of mechanism. "I was much pleased (says Mr Townsend in his interesting travels) with the construction of a new organ, containing 5500 pipes, with 110 stops, which latter, as the builder told me, is 50 more than are in the famous one of Haerlem; yet, to ample are the bellows, that when stretched they supply the full organ 15 minutes. The mode of blowing them with air is singular; for, instead of working with his hands, a man walks backwards and forwards along an inclined plane of about 15 feet in length, which is balanced in the middle on its axis; under each end is a pair of bellows, of about six feet by three and a half. These communicate with five other pairs suited by a bar; and the latter are so contrived, that when they are in danger of being overstrained, a valve is lifted up, and gives them relief. Passing 12 times along the inclined plane fills all these vessels."

† Vol. ii.
p. 345.

Seville.
Townsend's
Travels,
p. 345.

The Canos de Carmona, or great aqueduct of Seville, is reckoned by the historians of this city one of the most wonderful works of antiquity. Mr Swinburne, however, remarks, that it is ugly, crooked, the arches unequal, and the architecture neglected. The conduit is so leaky, that a rivulet is formed by the waste water. Nevertheless, it still conveys to the city an ample supply of water sufficient to turn several mills, and to give almost every house in town the benefit of it.

Many of the convents are remarkable for the beauty of their architecture; but in Seville the eye covets only pictures, of which there is a wonderful profusion. Among these are the works of the famous painter Murillo, with many others universally admired.

The convent of the Franciscans contains 15 cloisters, with apartments for 200 monks, though, when Mr Townsend visited them, they amounted only to 120.

Townsend's
Travels,
vol. ii.
p. 346.

The annual expenditure of these, who are all fed on charity, is about 400*l*. sterling. "In the principal cloister (says the same intelligent traveller), which is entirely inclosed by a multitude of little chapels, are represented, in 14 pictures, each called a *station*, all the

sufferings of the Redeemer. These are so arranged as to mark given distances by walking round the cloister from the first to the second, and so in order to the rest. Over them is mentioned the number of steps taken by our Lord between the several incidents of his passion in his way to Calvary; and these precisely are the paces measured for the penitents in their progress from one station to another. Over one is the following inscription: "This station consists of 1087 steps. Here the blessed Redeemer fell a second time under the weight of his cross, and here is to be gained the indulgence of seven years and forty quadrants. Mental prayer, the Pater-oster, and the Ave Maria." This may serve as an example for the rest."

The principal manufacture of Seville is snuff. Mr Townsend, who paid particular attention to it, informs us, that the building in which it is carried on is elegant and simple in its form, and is about 650 feet by 480, and not less than 65 feet in height, with four regular fronts, including 28 quadrangles. It cost 37,000,000 of reals, or about 372,000*l*. At present (1785), no more than 1720 workmen are employed, and 100 horses or mules; but formerly 3000 men were engaged, and near 400 horses. This falling off is attributed by Mr Swinburne to a practice which the directors followed, of adulterating the tobacco with the red earth of Amazarzon. When Mr Townsend visited this manufacture, they had changed their system. From the year 1780, he informs us, the annual sale of tobacco from Brazil has been 1,500,000 pounds, purchased from the Post-office at three reals a pound; and of snuff from the produce of their own colonies 1,600,000 pounds, beside *cigars* (A) to a very considerable amount. They have being by them more than 5,000,000 pounds of snuff unfolded; but as it will not suffer by age, they are not uneasy at this accumulation. Besides the peculiar kind of snuff with which Spain was accustomed to supply the market, they have lately introduced the manufacture of rappee. In this branch alone are employed 220 persons, old and young, with 16 mules.

"All the workmen (continues Mr Townsend) deposit their cloaks at the door; and when they go out are so strictly examined, that they have little chance of being able to conceal tobacco; yet they sometimes venture to hide it about their persons. An officer and a guard is always attending to take delinquents into custody; and that they may prevent resistance, no workman is permitted to enter with a knife. Were it not for this precaution, the consequence of a detection might be fatal. The whole business is conducted by a director, with a salary of 40,000 reals a-year, and 54 superior officers, assisted by as many subordinate to them. For grinding their snuff, they have 40 mills, each consisting of a stone roller, moved by a large horse or mule, with the trees fastened to a beam of eight feet in length, in the angle of 45 degrees, consequently losing precisely half his force."

Before Mr Townsend left Seville, according to his usual practice, which was truly laudable, he enquired into the prices of labour and provisions. As a piece of

C c curicus

curious and useful information, and as an example to other travellers, we present them to our readers. They are as follows :

Day-labourers	4½ reals, about L. 0	o 10½
Carpenters from 7 to 11	—	—
Joiners, if good workmen,	21 — or	o 4 9
Weavers, if good workmen, about	15 reals,	o 3 o
Bread, for 3 lb. of 16 oz. 16 quartos,	—	o o 4½
— sometimes 28 quartos, or	—	o o 7½
Beef, 30 quartos for 32 oz. per lb. about	—	o o 4½
Mutton, 38 do. do.	—	o o 5½
Kid, 24 do.	—	o o 3½
Pork from 36 to 42 quartos, do.	{ or	o o 5½
	{ to	o o 5½

The price of wheat has at different periods been very remarkable. In 1632, it sold at the rate of 15s. 3½d. the bushel; and in 1637, it fell so low as 1s. 4½d. per bushel, reckoning the fanega at 129½ lb. and the bushel at 72.

SEVUM MINERALE, mineral tallow; a substance somewhat resembling tallow, found on the sea-coasts of England in the year 1726. It burns with a blue flame, and full of greale, leaving a black viscid matter which cannot easily be consumed. It is extremely light; being only of the specific gravity of 0.772; whereas tallow is not less than 0.960. It is partly soluble in highly rectified spirit of wine, but entirely so in expressed oils when boiling. It is met with in some of the rocky parts of Paris, but there it appears to be mixed with petroleum. Dr H. man of Strasbourg mentions a spring in the neighbourhood of that city which contains a substance of this sort diffused through it, separating, and capable of being collected on ebullition.—A fat mineral matter resembling butter or tallow has lately been extracted from coal in Lancashire. See PEAT.

SEWACHRY, a Hindoo word used in Bengal, and signifying the train of attendants that accompany a noble or great man.

SEWER, *in the II. of Feild*, an officer who arranged on the table the duties of a king or nobleman.

SEWER is also a passage or gutter made to carry water into the sea or a river, whereby to preserve the land, &c. from inundations and other annoyances.

Chart of Commissions **SEWERS** in England, a temporary tribunal, created by virtue of a commission under the great seal; which formerly used to be granted *ex officio* at the pleasure of the crown, but now at the discretion and nomination of the lord chancellor, lord treasurer, and chief justices, pursuant to the statute 23 Hen. VIII. c. 5. Their jurisdiction is to enquire the repairs of churches and parishes, and the clearing of rivers, public streams, ditches, and other conduits, whereby any waters are carried off; and is confined to that county or particular district as the commission shall expressly name. The commissioners are a court of record, and may fine and imprison for contempts; and in the execution of their duty may compel by writ, or upon their own view, and may take aid by the removal of any waters, or by the filling up and excavation of the rivers, or by the raising of any water according to

the laws and customs of Romney-march, or otherwise at their own discretion. They may also take such rates or foots upon the owners of lands within their district as they shall judge necessary; and if any person refuses to pay them, the commissioners may levy the same by distress of his goods and chattels; or they may, by statute 23 Hen. VIII. c. 5. sell his freehold lands (and by the 7 Ann. c. 10. his copyhold also), in order to pay such foots or assessments. But their conduct is under the controul of the court of King's-bench, which will prevent or punish any illegal or tyrannical proceedings. And yet in the reign of King James I. (8th Nov. 1616.), the privy-council took upon them to order, that no action or complaint should be prosecuted against the commissioners unless before that board; and committed several to prison who had brought such actions at common law, till they should release the same; and one of the reasons for discharging Sir Edward Coke from his office of lord chief-justice, was for countenancing these legal proceedings. The pretence for these arbitrary measures was no other than the tyrant's plea of the necessity of unlimited powers in works of evident utility to the public, "the supreme reason above all reasons, which is the salvation of the king's lands and people." But now it is clearly held, that this (as well as all other inferior jurisdiction) is subject to the discretionary coercion of his majesty's court of King's-bench.

Common SEWERS, in Rome, were executed at a great expense. It was proposed that they should be of sufficient dimensions to admit a waggon loaded with hay. When these common sewers came to be obstructed, or out of repair, under the republic, the censors contracted to pay a thousand talents, or about 153,000*l.* for clearing and repairing them. They were again in disrepair at the accession of Augustus Cæsar, and the repairing them is mentioned among the great works of Agrippa. He is said to have turned the course of seven rivers into these subterraneous passages, to have made them navigable, and to have actually passed in barges under the streets and buildings of Rome. These works are still supposed to remain; but as they exceed the power and resources of the present city to keep them in repair, they are quite concealed, except at one or two places. They were, in the midst of the Roman greatness, and still are, reckoned among the wonders of the world; and yet they are said to have been works of the elder Tarq. in a place whose territory did not extend, in any direction, above 12 miles; and, on this supposition, they must have been made to accommodate a city that was calculated chiefly for the reception of cattle, herdsmen, and banditti. Rude nations sometimes execute works of great magnificence, as fortresses and temples, for the purposes of war and superstition; but seltom palaces, and still more seltom works of mere convenience and cleanliness, in which for the most part they are long defective. It is not unreasonable, therefore, to question the authority of tradition in respect to this singular monument of antiquity, which so greatly exceeds what the best accommodated city of modern Europe could undertake by its own convenience. And as these works are still entire, and may continue so for thousands of years, it may be supposed that they were even prior to the settlement of the Romans, and may have been the remains of some ancient city, or the ruins of some ancient city, which has since been buried under the present ruins of Rome.

for a (which) an impartial inquiry will most certainly be made, that women fill up their appointed circle of nobility with greater regularity than men, the claim of preference cannot justly be decided in our favour. In the prudential and economical parts of life, it is undeniable that they sit far above us; and if true friends of mankind be discovered by a cheerful resignation to the measures of Providence, we shall not find reason, perhaps, to claim that most singular of the human virtues as our peculiar privilege. There are numbers of the other sex who, from the natural delicacy of their constitution, pass through one continued scene of suffering from their sorrows to their graves, with a firmness of resolution that would deserve so many statutes to be erected to their memories, if heroism were not esteemed more by the splendor than the merit of actions.

But whatever real difference there may be between the moral or intellectual powers of the male and female mind, Nature does not seem to have marked the distinction so strongly as our vanity is willing to imagine; and after all, perhaps, education will be found to constitute the principal superiority. It must be acknowledged, at least, that in this article we have every advantage over the softer sex that art and industry can possibly secure to us. The most animating examples of Greece and Rome are set before us, as early as we are capable of any observation; and the noblest compositions of the ancients are given into our hands almost as soon as we have strength to hold them; while the employments of the other sex, at the same period of life, are generally the reverse of every thing that can open and enlarge their minds, or fill them with just and rational notions. The truth of it is, female education is so much worse than none, as it is better to leave the mind to its natural and uninstructed suggestions, than to lead it into false pursuits, and contract its views, by turning them upon the lowest and most trifling objects. We seem, indeed, by the manner in which we suffer the youth of that sex to be trained, to consider women agreeably to the opinion of certain Mahometan doctors, and treat them as if we believed they had no souls: why else are they

Bred only, and completed to the tulle
Of lawful appearance, to sing, to dance,
To dress, and trowl the tongue, and toll the eye.

MILTON.

This strange neglect of cultivating the female mind can hardly be allowed as good policy, when it is considered how much the interest of society is concerned in the rectitude of their understandings. That season of every man's life which is most susceptible of the strongest impressions, is necessarily under female direction; as there are few instances, perhaps, in which that sex is not one of the secret springs which regulates the most important movements of private or public transactions. What Cato observes of his countrymen is in one respect true of every nation under the sun: "The Romans (said he) govern the world, but it is the women that govern the Romans."

If it be true then (as true beyond all peradventure it is) that female influence is thus extensive, nothing certainly can be of more importance than to give it a proper tendency, by the assistance of a well-directed education. Far are we from recommending any attempts

to render women learned; yet surely it is necessary they should be raised above ignorance. Such a general tincture of the most useful sciences as may serve to free the mind from vulgar prejudices, and give it a relish for the rational exercise of its powers, might very justly enter into a plan of female education. That sex might be taught to turn the course of their reflections into a proper and advantageous channel, without any danger of rendering them too elevated for the feminine duties of life. If a woman, they ought to be considered as designed by Providence for use as well as show, and trained up, not only as women, but as rational creatures.

SEX OF *Bees*. See *BEE*.

SEX OF *Plants*. See *POFANY Index*.

SEXAGENARY, something relating to the number sixty: thus sexagenary or sexagesimal arithmetic is a method of computation proceeding by sixties; such is that used in the division of a degree into sixty minutes, of the minute into sixty seconds, of the second into sixty thirds, &c. Also sexagenary tables are tables of proportional parts, showing the product of two sexagenaries that are to be multiplied, or the quotient of the two that are to be divid'd.

SEXAGESIMA, the second Sunday before Lent, or the next to St.rove-Sunday; so called as being about the 63^d day before Easter.

SEXAGESIMALS, or SEXAGESIMAL *Fractions*, fractions whose denominators proceed in a sexagesimal ratio; that is, a prime, or the first minute = $\frac{1}{60}$; a second = $\frac{1}{3600}$; a third = $\frac{1}{216000}$. Anciently, there were no other than sexagesimals used in astronomy; and they are still retained in many cases, though Decimal arithmetic begins to grow in use now in astronomical calculations. In these fractions, which seem call *astronomical fractions*, the denominator being always 60, or a multiple thereof, is usually omitted, and the numerator only written down: thus $4^{\circ} 59' 3'' 50'' 15'''$, is to be read, 4 degrees, 59 minutes, 32 seconds, 10 thirds, 16 fourths, &c.

SEXTANS, SEXTANT, a sixth part of certain things. The Romans having divided their *as* into 12 ounces or uncia, the sixth part of that, or two ounces, was the sextans—*Sextans* was also a measure which contained two ounces of liquor, or two cyath.

SEXTANS, in *Astronomy*, a constellation of the southern hemisphere, made by Helvicus out of six stars. In Hevelius's catalogue it contains 11, but in the Britannic catalogue 41 stars.

SEXTANT, in *Mathematics*, denotes the sixth part of a circle, or an arch comprehending 60 degrees.

The word *sextant* is more particularly used for an astronomical instrument made like a quadrant, excepting that its limb only comprehends 60 degrees. The use and application of the sextant is the same with that of the quadrant. See *QUADRANT*; and *NAVIGATION*, p. 600, &c.

SEXTILE, SEXTIUS, the position or aspect of two planets when at 60 degrees distance, or at the distance of two signs from one another. It is marked thus (*). See *ASCIC*.

SEXTIUS, QUINTUS, a Pythagorean philosopher, flourished in the time of Augustus. He seemed formed to rise in the republic; but he shrank from civil honours, and declined accepting the rank of senator when it was offered him by Julius Cæsar, that he might live
time

time to apply to philosophy. It appears that he wished to establish a school at Rome, and that his tenets, though chiefly drawn from the doctrines of Pythagoras, in some particulars resembled those of the Stoics.

He soon found himself involved in many difficulties. His laws were dictated with great severity; and in an early period of this establishment, he found his mind harassed, and the hardships of the doctrines which he wished to establish to repulsive to his feelings, that he had nearly worked himself up to such an height of desperation as to resolve on putting a period to his existence.

Of the school of Sextus were Fabianus, Sotio, Flavianus, Crassitius, and Celsus. Of his works only a few fragments remain; and whether any of them formed a part of the work which Seneca admired so much, cannot now be determined. Some of his maxims are valuable. He recommended an examination of the actions of the day to his scholars when they retired to rest; he taught, that the road to heaven (*ad astra*) was by frugality, temperance, and fortitude. He used to recommend holding a looking glass before persons disordered with passion. He enjoined his scholars to abstain from animal food.

SEXTON, a church-officer, thus called by corruption of the Latin *secr. sta.* or *Sexton segefrone*, which denotes the same. His office is to take care of the vessels, vestments, &c. belonging to the church; and to attend the minister, church-warden, &c. at church. He is usually chosen by the parson only. Sextons, as well as parish clerks, are regarded by the common law as persons who have freehold in their offices; and, therefore, though they may be punished, yet they cannot be deprived, by ecclesiastical censures.

The office of sexton in the pope's chapel is appropriated to the order of the hermits of St. Augustine. He is generally a bishop, though sometimes the pope only gives a bishopric, *in partibus*, to him on whom he confers the office. He takes the title of *Profrat* of the *Pope's Sacristy*, and has the keeping the vessels of gold and silver, the relics, &c. When the pope is unwell, the sexton always takes the bread and wine first. If it be in private he says mass, his holiness, of two wafers, gives him one to eat; and, if in public, the cardinal, who assists the pope in quality of deacon, of three wafers, gives him one to eat. When the pope is desperately sick, he administers to him the sacrament of extreme unction, &c. and enters the conclave in quality of first conclavist.

The office of a sexton in Sweden is sometimes singular. During M. O. Thier's stay at Stockholm in 1736 he visited the church of St. Clara, and during divine service he observed a sexton going about with a long rod, making those persons who had fallen asleep.

SEXTUPLE, in *Musick*, denotes a mixed sort of triple, which is beaten in double time.

SEXTUS EMPERICUS, a famous Pyrrhonian philosopher, lived in the second century, under the reign of Antoninus the Dominant. He was a physician of the sect of the Empirics, and is said to have been one of the precursors of Antoninus the philosopher. There are still extant his *Percho* in Institution, and a large work against the mathematicians, &c. The best edition of Sextus Empiricus is that of Fabricius in Greek and Latin, printed at Leipsic in 1718, folio.

SEXUALISTE, among botanical writers, those who have established the classes of plants upon the differences of the sexes and parts of fructification in plants, according to the modern method; as Linnæus, &c.

SLZAWUL, a Hindoo word, used in Bengal to express an officer employed at a monthly salary to collect the revenues.

SFORZA, JAMES, was the founder of the illustrious house of Sforza, which acted so conspicuous a part in Italy during the 15th and 16th centuries, which gave six dukes to Milan, and contracted alliances with almost every sovereign in Europe. James Sforza was born on the 25th of May 1369, at Catignola, a small town in Italy, lying between Imola and Ferrisara. His father was a day labourer, or, according to Commine, a shoemaker. A company of soldiers happening one day to pass through Catignola, he was seized with the desire of accompanying them to the wars. "I will go (said he to himself), and dart my hatchet against that tree, and if it stick fast in the wood, I will immediately become a soldier." The hatchet accordingly stuck fast, and our adventurer enlisted; and because, says the Abbé de Choisy, he had thrown the axe with all his force, he assumed the name of Sforza; for his true name was Guacozazzo, or James Attendulo. He rose rapidly in the army, and soon became commander of 7000 men. He defended the cause of Jane II. queen of Naples for many years, and was made count of her kingdom. He was created Count of Catignola by Pope John XXII. by way of paying a debt of 14000 ducats which the church of Rome owed him. His exploits became every day more illustrious: He obliged Alfonso king of Aragon to raise the siege of Naples; and reduced several places that had revolted in Abruzzo and Le Labour; but while in pursuit of his enemies he was unfortunately drowned in the river Aterno on the 31 January 1424, at the age of 54 years. His heroic qualities, and the continual wars in which he was engaged, did not prevent him from forming an attachment to the law. In his youth he fell in love with a woman called *Luca Trezana*, whom he married after he had born him several children. He married afterwards Antonette Salenbini, who brought him several excellent estates; the best him *Castellazzo*, county of Santa-Flora, a warrior and governor of Orvieto for Pope Martin V. His third wife was Catherine Aloya, sister of Rodolpho, grand chamberlain to the sovereign of Naples. His last wife, for he was four times married, was Mary Mazzina, daughter to the duke of Sessa. She bore him Charles Sforza, who was general of the order of Augustines, and archbishop of Milan.

SFORZA, Francis, the son of James Sforza by Luca Trezana, was born in 1421, and trained up by his father to the profession of arms. At the age of 23 he defended the troops of Braccio, who disputed with him the passage of the Aterno. In this action his father was drowned, and Francis, though illegitimate, succeeded him. He fought successfully against the Spaniards, and contributed a great deal both towards raising the siege of Naples, and to the victory which was gained over the troops of Braccio near Aquila in 1425, where that general was killed. After the death of Queen Jane, in 1435, he opposed the interests of the duke of Anjou, to whom she had left her crown, and by his courage and abilities ably supported that on-

SHADOW, in *Optics*, the appearance of an opaque body, and of shadows, whose rays diverge, as in a certain lamp, each being given to the eye, and appearance of the shadow, according to the law of perspective. The method is this: From the luminous body, which is here considered as a point, let fall a perpendicular to the perspective plane or table; i. e. find the perpendicular of a point upon which a perpendicular drawn from the middle of the luminary, falls on the perspective plane, and from the several angles, or radii of pencils of the body, let fall perpendiculars to the plane. These pencils, when the perpendiculars fall, connect by right lines, with the point upon which the perpendicular let fall from the luminary falls; and continue the lines to the side opposite to the luminary. Lastly, through the radiated points draw lines through the centre of the luminary, intersecting the former; the points so intersected are the terms or bounds of the shadow.

SHADOWS, *COMETARY*, a curious phenomenon in optics, which was observed by Professor Scherffer of Vienna, and afterwards by Count Bonifacio, who made the discovery while prosecuting his experiments on light.

"*Luciferus*" says the count, "of comparing the intensity of the light of a clear blue sky by day with that of a common wax candle, I darkened my room, and letting the day-light from the north, coming through a hole near the top of the window-shutter, fall at an angle of about 72° upon a sheet of very fine white paper, I placed a burning wax candle in such a position that its rays fell upon the same paper, and, as near as I could guess, in the line of reflection of the rays of day-light from without; when, interposing a cylinder of wood, about half an inch in diameter, before the centre of the paper, and at the distance of about 2 inches from its surface, I was much surpris'd to find that the two shadows projected by the cylinder upon the paper, instead of being merely shades without colour, as I expected, the one of them, that which, corresponding with the beam of day light, was illuminated by the candle, was yellow; while the other, corresponding to the light of the candle, and consequently illuminated by the light of the heavens, was of the most beautiful blue that is possible to imagine. This appearance, which was not easily expected, but was really in itself in the highest degree striking and beautiful, I found upon repeated trials, and after varying the experiment in every way I could think of, to be so perfectly permanent, that it is absolutely impossible to produce two shadows at the same time, from the same body, the one answering to a beam of day-light, and the other to the light of a candle or lamp, without those shadows being coloured, the one yellow, and the other blue.

SHACK, in ancient customs, a sort of winter-purpurgage. In the counties of Norfolk and Suffolk, the lord of the manor his flock, i. e. a liberty of feeding his sheep at pleasure in his tenants lands during the five winter months. In Norfolk, *shack* also extends to the common for hogs, in all men's grounds, from the end of harvest till seed time. Whence to go *ack*, is to feed at large.

SHACKLES, aboard a ship, are those along iron rings, bigger at one end than at the other, with which they secure that part, by thrusting the wooden bars of the mast through them. There is also a sort of shackles with the hatches up with, of a like figure, but smaller. They are fastened at the corners of the hatches.

SHAD, a species of *CLEPTE*. See *INSECTOLOGY* *Ind.*

SHADDUCK, a species of *CORVUS*, the fruit of which is of a very large size, and of a very grateful taste. In the West Indies it is eaten after dinner to give a zest to the wine.

SHADOW, in *Optics*, a privation or diminution of light, by the interception of an opaque body; or it is a plane where the light is of a different or obstructed, or nearly weakened, by the interception of some opaque body between it and the ambient.

SHADOW, in *Psychology*, an imitation of a real shadow, which is commonly heightened and darkening the colours of such figures by their different distances cannot receive such rays from the luminary that is supposed to enlighten the picture.

Shagreen. It was incorporated by Queen Elizabeth and Charles II. and is governed by a mayor, recorder, twelve aldermen, justices, and a common council. It contains about 320 houses, many of which are of free-stone. Water is so scarce, that it used to be supplied from Motcomb; but it was obtained more commodiously in 1778, by means of engines, which raised the water above 300 feet perpendicular, and conveyed it to a large cistern in the middle of the town, from the distance of two miles. Yet even this is laid aside, and they have dug several pits, in which they preserve the rain-water; and the poor get their living to this day by fetching it in pails or on horses. It gives the title of earl to the noble family of Cooper.

SHAFTESBURY, *Earl of*. See COOPER.

SHAG. See PELICANUS, ORNITHOLOGY Index.

SHAGREEN, or CHAGREEN, in *Commerce*, a kind of grained leather prepared of the skin of a species of *SQUALUS*, and much used in covering cases, books, &c.

The best is that brought from Constantinople, of a brownish colour; the white is the worst. It is extremely hard; yet, when steeped in water, it becomes very soft and pliable; whence it is of great use among case-makers. It takes any colour that is given it, red, green, yellow, or black. It is frequently counterfeited by morocco, formed like shagreen; but this last is distinguished by its peeling off, which the first does not.

The following is the method of preparing shagreen, as it is described by Professor Pallas.

"All kinds of horses or asses skins, which have been dressed in such a manner as to appear grained, are, by the Tartars, called *seuacer*, by the Persians *segre*, and by the Turks *segr*, from which the Europeans have made *shagreen* or *chagrin*. The Tartars who reside at Astracan, with a few of the Armenians of that city, are the only people in the Russian empire acquainted with the art of making shagreen. Those who follow this occupation not only gain considerable profit by the sale of their production to the Tartars of Cuban, Astracan, and Casan, who ornament with it their Turkey leather boots, slippers, and other articles made of leather, but they derive considerable advantage from the great sale of horse hides, which have undergone no other process than that of being scraped clean, and of which several thousands are annually exported, at the rate of from 75 to 85 roubles per hundred, to Persia, where there is a scarcity of such hides, and from which the greater part of the shagreen manufactured in that country is prepared. The hind part only of the hide, however, which is cut out in the form of a crescent about a Russian ell and a half in length across the loins, and a short ell in breadth along the back, can properly be employed for shagreen. The remaining part, as is proved by experience, is improper for that purpose, and is therefore rejected.

"The preparation of the skins, after being cut into the above form, is as follows:—They are deposited in a tub filled with pure water, and suffered to remain there for several days, till they are thoroughly soaked, and the hair has dropped off. They are then taken from the tub, one by one, extended on boards placed in an oblique direction against a wall, the corners of

them, which reach beyond the edges of the board, being made fast, and the hair with the epidemis is then scraped off with a blunt iron scraper called *urak*. The skins thus cleaned are again put in pure water to soak. When all the skins have undergone this part of the process, they are taken from the water a second time, spread out one after the other as before, and the flesh side is scraped with the same kind of instrument. They are carefully cleaned also on the hair side, so that nothing remains but the pure fibrous tissue, which serves for making parchment, consisting of coats of white medullary fibres, and which has a resemblance to a swine's bladder softened in water.

"After this preparation, the workmen take a certain kind of frames called *paizi*, made of a straight and a semicircular piece of wood, having nearly the same form as the skins. On these the skins are extended in as smooth and even a manner as possible by means of cords; and during the operation of extending them, they are several times besprinkled with water, that no part of them may be dry, and occasion an unequal tension. After they have been all extended on the frames, they are again moistened, and carried into the house, where the frames are deposited close to each other on the floor with the flesh side of the skin next the ground. The upper side is then thickly bedewed with the black exceedingly smooth and hard seeds of a kind of goose foot (*cheopodium album*), which the Tartars call *aiakuta*, and which grows in abundance, to about the height of a man, near the gardens and farms on the south side of the Volga; and that they may make a strong impression on the skins, a piece of felt is spread over them, and the seeds are trod down with the feet, by which means they are deeply imprinted into the soft skins. The frames, without shaking the seeds, are then carried out into the open air, and placed in a reclining position against a wall to dry, the side covered with the seeds being next the wall, in order that it may be sheltered from the sun. In this state the skins must be left several days to dry in the sun, until no appearance of moisture is observed in them, when they are fit to be taken from the frames. When the impressed seeds are beat off from the hair side, it appears full of indentations or inequalities, and has acquired that impression which is to produce the grain of the shagreen, after the skins have been subjected to the last smoothing or scraping, and have been dipped in a ley, which will be mentioned hereafter, before they receive the dye.

"The operation of smoothing is performed on an inclined bench or board, which is furnished with an iron hook, and is covered with thick felt of sheep's wool, on which the dry skin may gently rest. The skin is suspended in the middle of the bench or board to its iron hook, by means of one of the holes made in the edge of the skin for extending it in its frame as before mentioned; and a cord, having at its extremity a stone or a weight, is attached to each end of the skin, to keep it in its position while under the hands of the workman. It is then subjected to the operation of smoothing and scraping by means of two different instruments. The first used for this purpose, called by the Tartars *tokar*, is a piece of sharp iron bent like a hook, with which the surface of the shagreen is pretty closely scraped to remove all the projecting inequalities.

This

Shagreen. This operation, on account of the corneous hardness of the dry skin, is attended with some difficulty; and great caution is at the same time required that too much of the impression of the *alabuta* seed be not destroyed, which might be the case if the iron were kept too sharp. As the iron, however, is pretty blunt, which occasions inequalities on the shagreen, this inconvenience must afterwards be remedied by means of a sharp scraping iron or *urak*, by which the surface acquires a perfect uniformity, and only faint impressions of the *alabuta* seed then remain, and such as the workman wishes. After all these operations, the shagreen is again put into water, partly to make it pliable, and partly to raise the grain. As the seeds occasion indentations on the surface of the skin, the intermediate spaces, by the operations of smoothing and scraping, lose some part of their projecting substance; but the points which have been depressed, and which have lost none of their substance, now swell up above the scraped parts, and thus form the grain of the shagreen. To produce this effect, the skins are left to soak in water for 24 hours; after which they are immersed several times in a strong warm ley, obtained, by boiling, from a strong alkaline earth named *schora*, which is found in great abundance in the neighbourhood of Astracan. When the skins have been taken from this ley, they are piled up, while warm, on each other, and suffered to remain in that state several hours; by which means they swell, and become soft. They are then left 24 hours in a moderately strong pickle of common salt, which renders them exceedingly white and beautiful, and fit for receiving any colour. The colour most usual for these skins is a sea-green; but old experienced workmen can dye them blue, red, or black, and even make white shagreen.

“For the green colour nothing is necessary but filings of copper and sal ammoniac. Sal ammoniac is dissolved in water till the water is completely saturated; and the shagreen skins, still moist, after being taken from the pickle, are washed over with the solution on the ungrained flesh side, and when well moistened a thick layer of copper filings is strewn over them: the skins are then folded double, so that the side covered with the filings is innermost. Each skin is then rolled up in a piece of felt; the rolls are all ranged together in proper order, and they are pressed down in an uniform manner by some heavy bodies placed over them, under which they remain 24 hours. During that period, the solution of sal ammoniac dissolves a quantity of the cupreous particles sufficient to penetrate the skin, and to give it a sea-green colour. If the first application be not sufficient, the process is repeated in the same manner; after which the skins are spread out and dried.

“For the blue dye, indigo is used. About two pounds of it, reduced to a fine powder, are put into a kettle; cold water is poured over it, and the mixture is stirred round till the colour begins to be dissolved. Five pounds of pounded *alakar*, which is a kind of barilla or crude soda, prepared by the Armenians and Calmucs, is then dissolved in it, with two pounds of lime and a pound of pure honey, and the whole is kept several days in the sun, and during that time frequently stirred round. The skins intended to be dyed blue must be moistened only in the natrious ley *schora*, but not in

the salt bine. When full moist, they are folded up and sewed together at the edge, the flesh side being innermost, and the shagreened hair side outwards; after which they are dipped three times in the remains of an exhausted kettle of the same dye, the superfluous dye being each time expelled; and after this process they are dipped in the fresh dye prepared as above, which must not be expressed. The skins are then hung up in the shade to dry; after which they are cleaned and paired at the edges.

“For black shagreen, gall nuts and vitriol are employed in the following manner.—The skins, moist from the pickle, are thickly bedewed with finely pulverized gall nuts. They are then folded together, and laid over each other for 24 hours. A new ley, of bitter saline earth or *schora*, is in the mean time prepared, and poured hot into small troughs. In this ley each skin is several times dipped; after which they are again bedewed with pounded gall nuts, and placed in heaps for a certain period, that the galls may thoroughly penetrate them, and they are dried and beat, to free them from the dust of the galls. When this is done, they are rubbed over, on the shagreen side, with melted sheep's tallow, and exposed a little in the sun, that they may imbibe the grease. The shagreen makers are accustomed also to roll up each skin separately, and to press or squeeze it with their hands against some hard substance, in order to promote the absorption of the tallow. The superfluous particles are removed by means of a blunt wooden scraper (*urac*); and when this process is finished, and the skins have lain some time, a sufficient quantity of vitriol of iron is dissolved in water, with which the shagreen is moistened on both sides, and by this operation it acquires a beautiful black dye. It is then dressed at the edges, and in other places where there are any blemishes.

“To obtain white shagreen, the skins must first be moistened on the shagreen side with a strong solution of alum. When the skin has imbibed this liquor, it is daubed over on both sides with a paste made of flour, which is suffered to dry. The paste is then washed off with alum water, and the skin is placed in the sun till it is completely dry. As soon as it is dry, it is gently besmeared with pure melted sheep's tallow, which it is suffered to imbibe in the sun; and to promote the effect, it is pressed and worked with the hands. The skins are then fastened in succession to the before-mentioned bench, where warm water is poured over them, and the superfluous fat is scraped off with a blunt wooden instrument. In the last operation the warm water is of great service. In this manner shagreen perfectly white is obtained, and nothing remains but to pair the edges and dress it.

“But this white shagreen is not intended so much for remaining in that state, as for receiving a dark red dye; because, by the above previous process, the colour becomes much more perfect. The skins destined for a red colour must not be immersed first in ley of bitter salt earth (*schora*), and then in pickle, but after they have been whitened, must be left to soak in the pickle for 24 hours. The dye is prepared from cochineal, which the Tartars call *kirmiz*. About a pound of the dried herb *schagann*, which grows in great abundance in the neighbourhood of Astracan, and is a kind

Shagreen
Shake-
green.

of foda plant or kali (*Salsola ericoides*) (A), is boiled a full hour in a kettle containing about four common pailfuls of water; by which means the water acquires a greenish colour. The herb is then taken out, and about half a pound of pounded cochineal is put into the kettle, and the liquor is left to boil a full hour, care being taken to stir it that it may not run over. About 15 or 20 drams of a substance which the dyers call *lute* (orchilla) is added, and when the liquor has been boiled for some time longer, the kettle is removed from the fire. The skins taken from the pickle are then placed over each other in troughs, and the dye-liquor is poured over them four different times, and rubbed into them with the hands, that the colour may be equally imbibed and diffused. The liquor each time is expressed; after which they are fit for being dried. Skins prepared in this manner are sold at a much dearer rate than any of the other kinds."

SHAKI properly signifies an old man. In the east it is used to denote a lord or chief, a man of eminence and property. See SHERKHS.

SHAKE, in singing. See TRILL.

SHAKESPEARE or SHAKSPEARE, *William*, the prince of dramatic writers, was born at Stratford upon Avon in Warwickshire, on the 23d of April 1564. From the register of that town, it appears that a plague broke out there on the 22th of June following, which raged with great violence; but fortunately it did not reach the house in which this infant prodigy lay. His father, John Shakespeare, enjoyed a small patrimonial estate, and was a considerable dealer in wool; his mother was the daughter and heir of Robert Arden of Wellingcote. Our illustrious poet being designed for the business of his father, received no better education than the instructions which the free-school of Stratford could afford. After applying some time to the study of Latin, he was called home to assist his father, who seems by some accident to have been reduced in his circumstances. Before arriving at the age of 10, he married the daughter of Mr Hathaway, a substantial yeoman in the neighbourhood of Stratford. This lady was eight years older than her husband. Having the misfortune to fall into bad company, he was seduced into some profligate actions, which drew on him a criminal prosecution, and at length forced him to take refuge in the capital. In concert with his associates, he broke into a park belonging to Sir Thomas Lucy of Charlecote, and carried off some of his deer. Every admirer of Shakespeare will regret that such a blemish should have stained his character; but, perhaps, if any thing can extenuate his guilt, we might ascribe it to the opinions of the age, which, perhaps, as was formerly the case in Scotland, might not distinguish the killing of deer by any mark of disgrace, or any charge of criminality. One thing at least is certain, that Shakespeare himself thought that the prosecution which Sir Thomas raised against him was carried on with too great severity; an opinion which he

Shake-
peare.

could not have entertained had this action been at that time viewed in the same criminal light as it is at present. Shakespeare testified his resentment against Sir Thomas, by writing a satirical ballad, which exasperated him so much, that the process was carried on with redoubled violence; and the young poet, in order to avoid the punishment of the law, was obliged to make his escape. This ballad would be considered as a curious relic, on account of its being the first production of Shakespeare; it would also be interesting to peruse a poem which could irritate the baronet to so high a degree. Tradition has preserved the first stanza:

A parlamente member, a justice of peace,
At home a poor scare-crow, at London an affe.

If lowfie is Lucy, as some volke miscale it,
Then Lucy is lowfie whatever befall it:

He thinks him'self greate,

Yet an affe in his flate,

We allowe by his ears, but with affes to mate.

If Lucy is lowfie, as some volke miscale it,
Sing lowfie Lucy whatever befall it.

If the rest of the ballad was of a piece with this stanza, it might assist us to form some opinion of the irritability of the baronet, but will enable us to form no idea of the opening genius of Shakespeare.

Thus expelled from his native village, he repaired to London, where he was glad to accept a subordinate office in the theatre. It has been said that he was first engaged, while the play was acting, in holding the horses of those who rode to the theatre; but this story rests on a slender foundation. As his name is found printed among those of the other players before some old plays, it is probable that he was some time employed as an actor; but we are not informed what characters he played; we are only told, that the part which he acted best was that of the Ghost in Hamlet; and that he appeared in the character of Adam in *As you like it*. If the names of the actors prefixed to Ben Jonson's play of *Every Man in his Humour* were arranged in the same order as the persons represented, which is very probable, Shakespeare played the part of Old Knowell. We have reason therefore to suppose, as far as we can argue from these few facts, that he generally represented old men. See Malone's Chronology, in his edition of Shakespeare.

But though he was not qualified to shine as an actor, he was now in the situation which could most effectually rouse those latent sparks of genius which afterwards burst forth with so resplendent a flame. Being well acquainted with the mechanical business of the theatre and the taste of the times; possessed of a knowledge of the characters of men resembling intuition, an imagination that ranged at large through nature, seeking the grand, the sublime, and the beautiful; a judicious caution, that disposed him to prefer those plots which had already been found to please; an uncommon fluency

(A) The beautiful red Turkev leather is dyed with cochineal prepared in the same manner. Professor Gmelin junior, in the second part of his Travels through Russia, explains the herb *Schagaran* by *artemisia annua*, having doubtless been deceived by the appearance the plant acquires after it has been dried. Besides, this *artemisia* is found only in the middle of Siberia, and never on the west side of the Urals.

Shake-
speare.

fluency and force of expression; he was qualified at once to eclipse all who had gone before him.

Notwithstanding the unrivalled genius of Shakespeare, most of his plots were the invention of others; which, however, he certainly much improved, if he did not entirely new-model. We are assured, that prior to the theatrical compositions of Shakespeare, dramatic pieces were written on the following subjects, viz. King John, King Richard II. and III. King Henry IV. and V. King Henry VIII. King Lear, Antony and Cleopatra, Measure for Measure, the Merchant of Venice, the Taming of a Shrew, and the Comedy of Errors.

Among his patrons, the earl of Southampton is particularly honoured by him, in the dedication of two poems, Venus and Adonis, and Lucrece; in the latter especially, he expressed himself in such terms as gives countenance to what is related of that patron's distinguished generosity to him. In the beginning of King James I.'s reign (if not sooner) he was one of the principal managers of the playhouse, and continued in it several years afterwards; till, having acquired such a fortune as satisfied his moderate wishes and views in life, he quitted the stage, and all other business, and passed the remainder of his time in an honourable ease, at his native town of Stratford, where he lived in a handsome house of his own purchasing, to which he gave the name of *New Place*; and he had the good fortune to save it from the flames in the dreadful fire that consumed the greatest part of the town in 1614.

In the beginning of the year 1616, he made his will, wherein he testified his respect to his quondam partners in the theatre: he appointed his youngest daughter, jointly with her husband, his executors, and bequeathed to them the best part of his estate, which they came into the possession of not long after. He died on the 23d of April following, being the 53d year of his age; and was interred among his ancestors on the north side of the chancel, in the great church of Stratford, where there is a handsome monument erected for him, inscribed with the following elegant distich in Latin:

*Judicio Pylium, genio Socratem, arte Maronem,
Terra tegit, Populus in aere, Olympus habet.*

In the year 1745, another very noble one was raised to his memory, at the public expence, in Westminster abbey; an ample contribution for this purpose being made upon exhibiting his tragedy of Julius Cæsar, at the theatre-royal in Drury-Lane, April 28th 1738.

Nor must we omit mentioning another testimony of the veneration paid to his names by the public in general, which is, that a mulberry-tree planted upon his estate by the hands of this revered bard, was cut down not many years ago; and the wood being converted to several domestic uses, was all eagerly bought at a high price, and each single piece treated up by its purchaser as a precious memorial of the planter.

The character of Shakespeare as a dramatic writer has been often drawn, but perhaps never with more accuracy than by the pen of Dr Johnson: "Shakespeare (says he) is above all writers, at least above all modern writers, the poet of nature; the poet that holds up to his readers a faithful mirror of manners and of life.

His characters are not modified by the customs of particular places, unpractised by the rest of the world; by the peculiarities of studies or professions, which can operate but upon small numbers; or by the accidents of transient fashions or temporary opinions: they are the genuine progeny of common humanity, such as the world will always supply, and observation will always find. His persons act and speak by the influence of those general passions and principles by which all minds are agitated, and the whole system of life is continued in motion. In the writings of other poets, a character is too often an individual; in those of Shakespeare, it is commonly a species.

"It is from this wide extension of design that so much instruction is derived. It is this which fills the plays of Shakespeare with practical axioms and domestic wisdom. It was said of Euripides, that every verse was a precept; and it may be said of Shakespeare, that from his works may be collected a system of civil and economical prudence. Yet his real power is not shown in the splendor of particular passages, but by the progress of his fable, and the tenor of his dialogue; and he that tries to recommend him by select quotations, will succeed like the pedant in Hierocles, who, when he offered his house to sale, carried a brick in his pocket as a specimen.

"Upon every other stage the universal agent is love, by whose power all good and evil is distributed, and every action quickened or retarded. But love is only one of many passions; and as it has no great influence upon the sum of life, it has little operation in the dramas of a poet who caught his ideas from the living world, and exhibited only what he saw before him. He knew that any other passion, as it was regular or exorbitant, was a cause of happiness or calamity.

"Characters thus ample and general were not easily discriminated and preserved; yet perhaps no poet ever kept his personages more distinct from each other.

"Other dramatists can only gain attention by hyperbolical or aggravated characters, by fabulous and unexampled excellence or depravity, as the writers of barbarous romances invigorated the reader by a giant and a dwarf; and he that should form his expectations of human affairs from the play, or from the tale, would be equally deceived. Shakespeare has no heroes, his scenes are occupied only by men, who act and speak as the reader thinks that he should himself have spoken or acted on the same occasion: Even where the agency is supernatural, the dialogue is level with life. Other writers disguise the most natural passions and most frequent incidents; so that he who contemplates them in the book will not know them in the world: Shakespeare approximates the remote, and familiarizes the wonderful; the event which he represents will not happen, but if it were possible, its effects would probably be such as he has assigned; and it may be said, that he has not only shown human nature as it acts in real exigencies, but as it would be found in trials to which it cannot be exempted.

"This therefore is the praise of Shakespeare, that his drama is the mirror of life; that he who has named his imagination, in following the phantoms which other writers raise up before him, may have the cure of his delirious ecstasies, by reading human sentiments in human language: by scenes from which a hermit may esti-

Shake-
speare.

Shake-
speare.

mate the transactions of the world, and a confessor predict the progress of the passions."

The learning of Shakespeare has frequently been a subject of inquiry. That he possessed much classical knowledge does not appear, yet he was certainly acquainted with the Latin poets, particularly with Terence, as Colman has justly remarked, which appears from his using the word *trifonical*. Nor was he unacquainted with French and Italian. We are indeed told, that the passages in which these languages occur might be impertinent additions of the players; but it is probable, that any of the players so far surpassed Shakespeare?

That much knowledge is scattered over his works is very justly observed by Pope; but it is often such knowledge as books did not supply. "There is, however, proof enough (says Dr Johnson) that he was a very diligent reader; nor was our language then so indigent of books, but that he might very liberally indulge his curiosity without excursion into foreign literature. Many of the Roman authors were translated, and some of the Greek; the Reformation had filled the kingdom with theological learning; most of the topics of human disquisition had found English writers; and poetry had been cultivated, not only with diligence, but success. This was a stock of knowledge sufficient for a mind so capable of appropriating and improving it."

The works of Shakespeare consist of 35 dramatic pieces. The following is the chronological order which Mr Malone has endeavoured to establish, after a minute investigation, in which he has in general been successful:

1. First Part of King Henry VI.	-	1589
2. Second Part of King Henry VI.	-	1591
3. Third Part of King Henry VI.	-	1591
4. A Midsummer Night's Dream	-	1592
5. Comedy of Errors	-	1593
6. Taming of the Shrew	-	1594
7. Love's Labour Lost	-	1594
8. Two Gentlemen of Verona	-	1595
9. Romeo and Juliet	-	1595
10. Hamlet	-	1596
11. King John	-	1596
12. King Richard II.	-	1597
13. King Richard III.	-	1597
14. First Part of King Henry IV.	-	1597
15. Second Part of King Henry IV.	-	1598
16. The Merchant of Venice	-	1598
17. All's Well that Ends Well	-	1598
18. King Henry V.	-	1599
19. Much Ado about Nothing	-	1600
20. As you like it	-	1600
21. Merry Wives of Windsor	-	1601
22. King Henry VIII.	-	1601
23. Troilus and Cressida	-	1602
24. Measure for Measure	-	1603
25. The Winter's Tale	-	1604
26. King Lear	-	1605
27. Cymbeline	-	1605
28. Macbeth	-	1606
29. Julius Cæsar	-	1607
30. Antony and Cleopatra	-	1608
31. Timon of Athens	-	1609
32. Coriolanus	-	1610

33. Othello	-	1611
34. The Tempest	-	1612
35. Twelfth Night	-	1614

Shake-
speare.

The first three of these, Mr Malone thinks, there is very strong reason to believe are not the original productions of Shakespeare; but that he probably altered them, and added some new scenes.

In the first folio edition in 1623, these plays were entitled "Mr William Shakespeare's Comedies, Histories, and Tragedies." They have been published by various editors. The first folio edition by Isaac Jaggard and Edward Blount; the second, folio, 1632, by Thomas Cotes for Robert Allot; the third, 1664, for P. C.; the fourth, 1685, for H. Herringman, E. Brewster, and R. Bentley. Rowe published an 8vo edition in 1709, in 7 vols, and a 12mo edition in 1714, in 9 vols; for which he received 36l. 12s. Pope published a 4to edition in 1725, in 6 vols, and a 12mo in 1728, in 10 vols; for which he was paid 217l. 12s. Theobald gave a new edition in 8vo in 1733, in 7 vols, another in 12mo in 1740, in 8 vols; and received for his labour 652l. 10s. Sir Thomas Hanmer published an edition in 1744, in 6 vols 4to. Dr Warburton's 8vo edition came out in 1747, in 8 vols; for which he was paid 560l. The editions published since that time, are Dr Johnson's in 1765, in 8 vols 8vo. Stevens's in 1766, in 4 vols 8vo. Capell's in 1768, in 10 vols, crown 8vo; for this the author was paid 300l. A second edition of Hanmer's in 1771, 6 vols. Johnson's and Stevens's in 1773, in 10 vols 8vo; a second edition in 1778; a third by Reed in 1785; and Malone's crown 8vo edition in 1789, in 10 vols.

The most authentic of the old editions is that of 1623. "At last (says Dr Johnson) an edition was undertaken by Rowe; not because a poet was to be published by a poet, for Rowe seems to have thought very little on correction or explanation, but that our author's works might appear like those of his fraternity, with the appendages of a life and commendatory preface. Rowe has been clamorously blamed for not performing what he did not undertake; and it is time that justice be done him, by confessing, that though he seems to have had no thought of corruption beyond the printer's errors, yet he has made many emendations, if they were not made before, which his successors have received without acknowledgment, and which, if they had produced them, would have filled pages with censures of the stupidity by which the faults were committed, with displays of the absurdities which they involved, with ostentatious expostions of the new reading, and self-congratulations on the happiness of discovering it."

The nation had been for many years content enough with Mr Rowe's performance, when Mr Pope made them acquainted with the true state of Shakespeare's text, shewed that it was extremely corrupt, and gave reason to hope that there were means of reforming it. Mr Pope's edition, however, he observes, fell below his own expectations; and he was so much offended, when he was found to have left any thing for others to do, that he passed the latter part of his life in a state of hostility with verbal criticism.

The only task, in the opinion of Mr Malone, for which Pope was eminently and indisputably qualified, was

was

Shak-
peare

was to mark the faults and beauties of his author.—When he undertook the office of a commentator, every anomaly of language, and every expression that was currently in use, were considered as errors or corruptions, and the text was altered or amended, as it was called, at pleasure. Pope is openly charged with being one of the great corruptors of Shakespeare's text.

Pope was succeeded by Theobald, who collated the ancient copies, and rectified many errors. He was, however, a man of narrow comprehension and of little learning, and what is worse, in his reports of copies and editions, he is not to be trusted without examination. From the liberties taken by Pope, the edition of Theobald was justly preferred, because he professed to adhere to the ancient copies more strictly, and illustrated a few passages by extracts from the writers of our poet's age. Still, however, he was a considerable innovator; and while a few arbitrary changes made by Pope were detected, innumerable sophistications were silently adopted.

Sir Thomas Hanmer, who comes next, was a man of critical abilities, and of extensive learning. His corrections are commonly just, but sometimes capricious. He is censurable, too, for receiving without examination almost all the innovations of Pope.

The original and predominant error of Warburton's commentary, is acquiescence in his first thoughts; that precipitation which is produced by consciousness of quick discernment; and that confidence which presumes to do, by surveying the surface, what labour only can perform, by penetrating to the bottom. His notes exhibit sometimes perverse interpretations, and sometimes improbable conjectures; he at one time gives the author more profundity of meaning than the sentence admits, and at another discovers absurdities where the sense is plain to every other reader. But his emendations are likewise often happy and just; and his interpretation of obscure passages learned and sagacious.

It has indeed been said by his defenders, that his great object was to display his own learning; and certainly, in spite of the clamour raised against him for substituting his own chimerical conceits instead of the genuine text of Shakespeare, his work increased his reputation. But as it is of little value as a commentary on Shakespeare, since Warburton is now gone, his work will probably soon sink into oblivion.

In 1765 Dr Johnson's edition, which had long been impatiently expected, was given to the public. His vigorous and comprehensive understanding threw more light on his author than all his predecessors had done. The character which he gave of each play is generally just. His refutation of the false glosses of Theobald and Warburton, and his numerous explications of involved and difficult passages, entitle him to the gratitude of every admirer of Shakespeare.

The last editor is Mr Malone, who was eight years employed in preparing his edition. By collating the most authentic copies, he has been careful to purify the text. He has been so industrious, in order to discover the meaning of the author, that he has ransacked many volumes, and trusts that, besides his additional illustrations, not a single valuable explication of any obscure passage in these plays has ever appeared, which he has not inserted in his edition. He rejects Titus Andronicus, as well as the three plays formerly mentioned, as

not being the authentic productions of Shakespeare. To the whole he has added an appendix, and a copious glossary.—Of this work a Leeds expensive edition has been published in 7 vols 12mo, in which the general introductory observations prefixed to the different plays are preserved, and the numerous notes abridged.

This judicious commentator has certainly done more for the elucidation and correction of Shakespeare than all who came before him, and has followed with indefatigable patience the only road which a commentator of Shakespeare ought to observe.

Within 30 years after our poet's death, Dryden says that he was become "a little obsolete;" and in the beginning of the 18th century Lord Shaftesbury complains of his rude unpolished style, and his antiquated phrase and wit. These complaints were owing to the great revolution which the English language has undergone, and to the want of an enlightened commentator. These complaints are now removed, for an enlightened commentator has been found in Mr Malone.

We have only farther to add, that in the year 1795 a copious index to the remarkable passages and words in the plays of Shakespeare was published by the Reverend Mr Aylcough; a gentleman to whom the literary world is much indebted for several very valuable keys of knowledge. In fine, the admirers of Shakespeare are now, by the labours of several eminent men, furnished with every help that can enable them to understand the sense and to taste the beauties of this illustrious poet.

SHAKLES. See SHACKLES.

SHALE, in MINERALOGY, a kind of SCHISTUS, of a black colour and slaty structure, or a clay hardened into a stony confluence, and so much impregnated with bitumen that it becomes somewhat like a coal. The acid emitted from shale, during its calcination, uniting itself to the argillaceous earth of the shale, forms alum. About 120 tons of calcined shale will make one ton of alum. The shale, after being calcined, is steeped in water, by which means the alum, which is formed during the calcination of the shale, is dissolved: this dissolved alum undergoes various operations before it is formed into the alum of the shops. *Watson's Chemical Essays*, vol. ii. p. 315. See ALUM, CHEMISTRY *Index*.

This kind of slate forms large strata in Derbyshire; and that which lies near the surface of the earth is of a softer and more silvery texture than that which lies deeper. It is also found in large strata, generally above the coal, in most coal counties of this kingdom.

SHALLOP, SHALLOOP, or STOOOP, is a small light vessel, with only a small main-mast and fore-mast, and lug-sails, to haul up, and let down, on occasion.—Shallops are commonly good failers, and are therefore often used as tenders upon men of war.

SHALLOT, or ESCHALOT. See ALLIUM, BOTANY and GARDENING *Index*.

SHAMANS are wizards or conjurers, in high repute among several idolatrous nations inhabiting different parts of Russia. By their enchantments they pretend to cure diseases, to divert misfortunes, and to forestall futurity. They are great observers of dreams, by the interpretation of which they judge of their good or bad fortune. They pretend likewise to chironomy, and to forestall a man's good or ill success by the lines of

Shake-
peare
||
Shamans.

his hand. By these and such like means they have a very great ascendancy over the understandings, and a great influence on the conduct, of those people.

SHAMBLES, among miners, a sort of niches or landing places, left at such distances in the adits of the mines, that the thovel-men may conveniently throw up the ore from shamble to shamble, till it comes to the top of the mine.

SHAMOIS, CHAMOIS, or SHAMMY, a kind of leather, either dressed in oil or tanned, much esteemed for its softness, pliancy, &c. It is prepared from the skin of the chamois, or shamois, a kind of rupicapra, or wild goat, called also ibard, inhabiting the mountains of Dauphiny, Savoy, Piedmont, and the Pyrenees. Besides the softness and warmth of the leather, it has the faculty of bearing soap without damage; which renders it very useful on many accounts.

In France, &c. some wear the skin raw, without any preparation. Shammy leather is used for the purifying of mercury, which is done by passing it through the pores of this skin, which are very close. The true chamois leather is counterfeited with common goat, kid, and even with sheep skins, the practice of which makes a particular profession, called by the French *chamoiserie*. The last, though the least esteemed, is yet so popular, and such vast quantities of it are prepared, especially about Orleans, Marseilles, and Thoulouse, that it may be proper to give the method of preparation.

Manner of shamoying, or of preparing sheep, goat, or kid skins in oil, in imitation of shammy.—The skins, being washed, drained, and smeared over with quicklime on the fleshy side, are folded in two lengthwise, the wool outwards, and laid in heaps, and so left to ferment eight days, or, if they had been left to dry after flaying, then fifteen days.

Then they are washed out, drained, and half dried; laid on a wooden leg, or horse, the wool stripped off with a round staff for that purpose, and laid in a weak pit, the lime whereof had been used before, and has lost the greatest part of its force.

After 24 hours they are taken out, and left to drain 24 more; they are then put in another stronger pit. This done, they are taken out, drained, and put in again, by turns; which begins to dispose them to take oil; and this practice they continue for six weeks in summer, or three months in winter: at the end whereof they are washed out, laid on the wooden leg, and the surface of the skin on the wool side peeled off, to render them the softer; then made into parcels, steeped a night in the river, in winter more, stretched six or seven over one another on the wooden leg, and the knife passed strongly on the flesh side, to take off any thing superfluous, and render the skin smooth. Then they are steeped, as before, in the river, and the same operation is repeated on the wool side; they are then thrown into a tub of water, with bran in it, which is brewed among the skins till the greatest part sticks to them, and then separated into distinct tubs, till they swell, and rise of themselves above the water. By this means the remains of the lime are cleared out; they are then wrung out, hung up to dry on ropes, and sent to the mill, with the quantity of oil necessary to fatten them: the best oil is that of flock-fish. Here they are first thrown in bundles into the river for 12 hours, then laid in the mill-trough, and sullen without oil till they be well soft-

ened; then oiled with the hand, one by one, and thus formed into parcels of four skins each; which are milled and dried on cords a second time; then a third; and then oiled again, and dried. This process is repeated as often as necessity requires; when done, if there be any moisture remaining, they are dried in a stove, and made up into parcels wrapped up in wool; after some time they are opened to the air, but wrapped up again as before, till such time as the oil seems to have lost all its force, which it ordinarily does in 24 hours. The skins are then returned from the mill to the chamoisier to be scoured; which is done by putting them in a lixivium of wood-ashes, working and beating them in it with poles, and leaving them to steep till the ley hath had its effect; then they are wrung out, steeped in another lixivium, wrung again; and this is repeated till all the grease and oil be purged out. When this is done, they are half dried, and passed over a sharp-edged iron instrument, placed perpendicular in a block, which opens, softens, and makes them gentle. Lastly, they are thoroughly dried, and passed over the same instrument again; which finishes the preparation, and leaves them in form of shammy.

Kid and goat skins are shamoyed in the same manner as those of sheep, excepting that the hair is taken off without the use of any lime; and that when brought from the mill they undergo a particular preparation called *ramaling*, the most delicate and difficult of all the others. It consists in this, that, as soon as brought from the mill, they are steeped in a fit lixivium, taken out, stretched on a round wooden leg, and the hair is scraped off with the knife; this makes them smooth, and in working to cast a kind of fine knap. The difficulty is in scraping them evenly.

SHANK, or SHANK-Pointer, in a ship, is a short chain fastened under the foremast shrouds, by a bolt, to the ship's sides, having at the other end a rope fastened to it. On this shank-pointer the whole weight of the aft part of the anchor rests, when it lies by the ship's side. The rope, by which it is hauled up, is made fast about a timber head.

SHANK, in the manege, that part of a horse's fore leg which lies between the knee and the fetlock.

SHANKER, or CHANCER, in *Medicine*, a malignant ulcer, usually occasioned by some venereal disorder. See *MEDICINE*, N^o 250.

SHANNON, the largest river in Ireland, and one of the finest in the British dominions, not only on account of its rolling 200 miles, but also of its great depth in most places, and the gentleness of its current, by which it might be made exceedingly serviceable to the improvement of the country, the communication of its inhabitants, and consequently the promoting of inland trade, through the greatest part of its long course. But the peculiar prerogative of the Shannon is its situation, running from north to south, and separating the province of Connaught from Leinster and Munster, and of consequence dividing the greatest part of Ireland into what lies on the east and that on the west of the river; watering in its passage the valuable county of Leitrim, the plentiful shire of Roscommon, the fruitful county of Galway, and the pleasant county of Clare; the small but fine shire of Longford, the King's county, and fertile county of Meath in Leinster, the populous county of Tipperary, the spacious shire of Lime-

Shanferit
of
Sharon.

rick, and the rough but pleasant county of Kerry in Munster; visiting to counties in its passage, and having on its banks the following remarkable places, viz. Leitrim, Jamestown, Lanesborough, Athlone, Clonsfert, Killybeg, and Limerick: at 22 leagues below the latter it spreads gradually several miles in extent, so that some have considered its expansion as a lake. It at last joins its waters to the sea, being navigable all that way for the largest vessels.

SHANSCRIP, the language of the Bramins of Hindustan. See PHRASEOLOGY, sect. v.

SHARE *of a PLOUGH*, that part which cuts the ground; the extremity forwards being covered with a sharp-pointed iron, called the *point of the share*, and the end of the wood behind the *tail of the share*.

SHARK. See SQUALUS, ICITHOLOGY Index.

SHARON, a name common to three cantons of Palestine. The first lay between Mount Tabor and the sea of Iberia; the second between the city of Cæsarea of Palestine, and Joppa; and the third lay beyond Jordan. To give an idea of perfect beauty, Isaiah bid, the glory of Lebanon and the beauty of Carmel must be joined to the abundance of Sharon. (Isaiah xxxiii. 9. xxxi. 2.). The plains of Sharon are of vast extent; and, when farveyed by the Abbé Mariti a few years ago, they were sown with cucumbers; and he informs us, that such a number is annually produced, as not only to supply the whole neighbourhood, but also all the coasts of Cyprus and the city of Damascus. In the middle of the plain, between Arfus and Lydia, rises a small mountain, upon the ridge of which there is a small village called Sharon, from the name of the ancient city whose king was conquered by Joshua.

SHARP, JAMES, archbishop of St Andrew's, was born of a good family in Basle-suire in 1618. He devoted himself very early to the church, and was educated for that purpose in the university of Aberdeen. When the solemn league and covenant was framed in 1638, the learned men in that seminary, and young Sharp in particular, declared themselves decidedly against it. To avoid the insults and indignities to which he was subjected in consequence of this conduct, he retired to England, where he contracted an acquaintance with some of the most celebrated divines in that country.

At the commencement of the civil war he returned to Scotland. During his journey thither, he accidentally met with Lord Oxenford, who was so charmed with his conversation, that he invited him to his house. While he resided with that nobleman, he became known to the earl of Rothes, who procured him a professorship at St Andrew's. By the interest of the earl of Crawford he was soon after appointed minister of Crail; where he conducted himself, it is said, in an exemplary manner.

Sharp had always inclined to the cause of royalty, and had for some time kept up a correspondence with his exiled prince. After the death of the protector he began to declare himself more openly, and seems to have enjoyed a great share of the confidence of Monk, who was at that time planning the restoration of Charles II. When that general marched to London, the presbyterians sent Sharp to attend him in order to support their interests. At the request of General Monk and the chief presbyterians in Scotland, Mr Sharp was

sent over to the king at Breda to procure from him, if possible, the establishment of presbyterianism. On his return, he assured his friends that "he had found the king very affectionate to Scotland, and resolved not to wrong the settled government of the church; but he apprehended they were mistaken who went about to establish the presbyterian government."

Cavies was soon after rejected without any terms. All the laws passed in Scotland since the year 1633 were repealed; the king and his ministers resolved at Edinburgh to restore prelacy. Mr Sharp, who had been commissioned by the Scotch presbyterians to manage their interests with the king, was prevailed upon to abandon the party; and, as a reward for his compliance, he was made archbishop of St Andrew's. This conduct rendered him very odious in Scotland; and he was accused of treachery and perjury, and reproached by his old friends as a traitor and renegade. The absurd and wanton cruelties which were afterwards committed, and which were imputed in a great measure to the archbishop, rendered him still more detested. Nor is it probable that these accusations were without foundation: the very circumstance of his having been formerly of the presbyterian party would induce him, after forsaking them, to treat them with severity. Besides, it is certain, that when after the rout at Pentland-hills he received an order from the king to stop the executions, he kept it for some time before he produced it to council.

There was one Mitchell a preacher, and a desperate fanatic, who had formed the design of taking vengeance for these cruelties by assassinating the archbishop. He fired a pistol at him as he was sitting in his coach; but the bishop of Orkney, lifting up his hand at the moment, intercepted the ball. Though this happened in the midst of Edinburgh, the primate was so much detested, that nobody stopped the assassin; who, having walked leisurely home, and thrown off his disguise, returned, and mixed unsuspected with the crowd. Some years after, the archbishop observing a man eyeing him with keenness, suspected that he was the assassin, and ordered him to be brought before him. It was Mitchell. Two loaded pistols were found in his pocket. The primate offered him a pardon if he would confess the crime; the man complied; but Sharp, regardless of his promise, conducted him to the council. The council also gave him a solemn promise of pardon if he would confess his guilt, and discover his accomplices. They were much disappointed to hear that only one man was privy to his purpose, who was since dead. Mitchell was then brought before a court of justice, and ordered to make a third confession, which he refused. He was imprisoned for several years, and then tried. His own confession was urged against him. It was in vain for him to plead the illegality of that evidence, and to appeal to the promise of pardon previously given. The council took an oath that they had given no such promise; and Mitchell was condemned. Lauderdale, who at that time governed Scotland, would have pardoned him, but the primate insisted on his execution; observing, that if assassins were permitted to go unpunished, his life must be continually in danger. Mitchell was accordingly executed.

Sharp had a servant, one Carmichael, who by his cruelty had rendered himself particularly odious to the zealots. Nine men formed the resolution of waylaying him in Magus-moor, about three miles from St Andrew's.

Share.

Sharp. drew's. While they were waiting for this man, the primate himself appeared with very few attendants. This they looked upon as a declaration of heaven in their favour; and calling out, "the Lord has delivered him into our hands," they ran up to the carriage. They fired at him without effect; a circumstance which was afterwards imputed to magic. They then dispatched him with their bows, regardless of the tears and intreaties of his daughter, who accompanied him (A).

This fell Archbishop Sharp, whose memory is even at present detested by the common people of Scotland. His abilities were certainly good, and in the early part of his life he appears with honour and dignity. But his conduct afterwards was too cruel and insincere to merit approbation. His treatment of Mitchell was mean and vindictive. How far he contributed to the measures adopted against the presbyterians is not certain. They were equally cruel and impolitic; nor did their effects cease with the measures themselves. The unheard-of cruelties exercised by the ministers of Cha. II. against the adherents of the covenant, raised such a flame of enthusiasm and bigotry as is not yet entirely extinguished.

SHARP, *Dr John*, archbishop of York, was descended from the Sharps of Little Norton, a family of Bradford Dale in Yorkshire; and was son of an eminent tradesman of Bradford, where he was born in 1614. He was educated at Cambridge, and in 1667 entered into orders. That same year he became domestic chaplain to Sir Heneage Finch, then attorney-general. In 1672 he was collated to the archdeaconry of Berkshire. In 1675 he was installed a prebendary in the cathedral church of Norwich; and the year following was instituted into the rectory of St Bartholomew near the Royal Exchange, London. In 1681 he was, by the interest of his patron Sir Heneage Finch, then lord high chancellor of England, made dean of Norwich; but in 1686 was suspended for taking occasion, in some of his sermons, to vindicate the doctrine of the church of England in opposition to Popery. In 1688 he was sworn chaplain to King James II. being then probably restored after his suspension for it is certain that he was chaplain to King Charles II. and attended as a court chaplain at the coronation of King James II. In 1689 he was declared dean of Canterbury; but never could be persuaded to fill up any of the vacancies made by the deprived bishops. Upon the death of Dr Lamplugh, he was promoted to the see of York. In 1702 he preached the sermon at the coronation of Queen Anne; and the same year was sworn of the privy-council, and made lord almoner to her majesty. He died at Bath in 1713; and was interred in the cathedral of York, where a monument is erected to his memory.—His sermons, which

were collected after his death and published in 7 vols 8vo, are justly admired.

SHARP, *Abraham*, an eminent English mathematician, and astronomer, was born at Little Horton, near Bradford, in the year 1651. He was put apprentice to a merchant at Manchester; but so strongly was he inclined to the study of mathematics, that he soon found his situation both irksome and disagreeable. By the mutual consent, therefore, of his master and himself, he quitted the business of a merchant. He then removed to Liverpool, where he wholly devoted himself to mathematical studies, and where, for a subsistence, he taught writing and accounts.

Soon after this a merchant from London, in whose house the celebrated Mr Flamsteed then lodged, engaged Mr Sharp to be his book-keeper. With this eminent astronomer he soon contracted an intimate friendship, and by his recommendation he obtained a more profitable employment in the dock-yard of Chatham, where he continued till his friend and patron called him to his assistance. Mr Sharp was chiefly employed in the construction of the mural arch, which he finished in the course of 14 months so entirely to the satisfaction of Mr Flamsteed, that he spoke of him in terms of the highest praise. In the opinion of Mr Smeaton, this was the first good instrument of the kind, and Mr Sharp the first artist who cut delicate divisions on astronomical instruments. When this instrument was constructed, Mr Sharp was but 25, and Mr Flamsteed 30 years of age. Mr Sharp assisted his friend in making a catalogue of nearly 3000 fixed stars, with their longitudes and magnitudes, their right ascensions and polar distances, with the variations of the same while they change their longitude by one degree.

But from the fatigue of constantly observing the stars by night, in a cold thin air, added to a weakly constitution, his health was much impaired; for the recovery of which he requested leave to retire to his house at Horton, where, as soon as he felt himself recovering, he began to fit up an observatory of his own, and the telescopes he made use of were all of his own construction, and the lenses ground and adjusted with his own hands.

It was about this time that he assisted Mr Flamsteed in calculating most of the tables in the second volume of his *Historia Cœlestis*, as appears by their letters, to be seen in the hands of Mr Sharp's friends at Horton. The mathematician, says Dr Hutton, meets with something extraordinary in Sharp's elaborate treatise of *Geometry Improved*; by a large and accurate table of segments of circles, its construction and various uses in the solution of several difficult problems, with compendious tables for finding a true proportional part; and their use in these or any other tables exemplified in making logarithms,

(A) Such is the account given by all our historians of the murder of Archbishop Sharp; and that he fell by the hands of fanatics, whom he persecuted, is certain. A tradition, however, has been preserved in different families descended from him, which may be mentioned, and is in itself certainly not incredible. The primate, it seems, who, when minister of Crail, was peculiarly severe in punishing the sin of fornication, had, in the plenitude of his archiepiscopal authority, taken notice of a criminal amour carried on between a nobleman high in office and a lady of some fashion who lived within his diocese. This interference was in that licentious age deemed very impertinent; and the archbishop's descendants believe that the proud peer infligated the deluded rabble to murder their ancestor.

Sharp
||
Shafer.

logarithms, or their natural numbers, to 65 places of figures; there being a table of them for all primes to 1100, true to 61 figures. His concise treatise of Polyedra, or solid bodies of many bases, both of the regular ones and others; to which are added, 12 new ones, with various methods of forming them, and their exact dimensions in solids or species, and in numbers; illustrated with a variety of copper-plates, neatly engraved by his own hands. Indeed, few of the mathematical instrument makers could exceed him in exactly graduating or neatly engraving mathematical or astronomical instruments. He possessed a remarkably clear head for contriving, and an extraordinary hand for executing any thing, not only in mechanics, but likewise in drawing, writing, and making the most beautiful figures in all his calculations and constructions.

The quadrature of the circle was undertaken by him for his own amusement, in the year 1699, deduced from two different series, by which the truth of it was proved to 72 places of figures, as may be seen in Sherwin's Tables of Logarithms. In the same book may likewise be seen his ingenious improvements on the making of logarithms, and the constructing of the natural sines, tangents, and secants.

Mr Sharp kept up a correspondence with most of the eminent mathematicians and astronomers of his time, as Flamsteed, Newton, Halley, Wallis, Hodgson, &c. the answers to whose letters are all written on the backs or empty spaces, of the letters he received, in a short hand of his own invention. Being one of the most accurate and indefatigable computers whoever existed; he was many years the common resource for Flamsteed, Sir Jonas Moor, Halley, and others, in all sorts of troublesome and delicate calculations.

Mr Sharp was never married, and spent his time as a hermit. He was of a middle stature, very thin, of a weekly constitution; but remarkably feeble during the last 3 or 4 years before his death, which happened on the 18th of July 1742, in the 61st year of his age.

He was very irregular as to his meals, and uncommonly sparing in his diet, which he frequently took in the following manner. A little square hole, resembling a window, formed a communication between the room where he usually studied, and another where a servant could enter; and before this hole he had contrived a sliding board. It often happened, that the breakfast, dinner, and supper, have remained untouched, when the servant has gone to remove what was left,—so deeply was he engaged in calculations.

SHARP, in *Musick*. See INTERVAL.

SHASTAH, the same as SHASTER.

SHASTER, SHASTAH, or BEDANG, the name of a sacred book, in high estimation among the idolaters of Hindostan, containing all the dogmas of the religion of the bramins, and all the ceremonies of their worship; and serving as a commentary on the VEDAM.

The term *Shaster* denotes "science" or "system"; and is applied to other works of astronomy and philosophy, which have no relation to the religion of the Indians. None but the bramins and rajahs of India are allowed to read the Vedam; the priests of the Banians, called *Shudrers*, may read the *Shaster*; and the people, in general, are allowed to read only the *Paran* or *Pouran*, which is a commentary on the *Shaster*.

VOL. XIX. Part I.

Shafer.

The *Shaster* is divided into three parts: the first containing the moral law of the Indians; the second, the rites and ceremonies of their religion; and the third, the distribution of the people into tribes or classes, with the duties pertaining to each class.

The principal precepts of morality, contained in the first part of the *Shaster*, are the following: that no animal be killed, because the Indians attribute souls to brute animals as well as to mankind; that they neither hear nor speak evil, nor drink wine, nor eat flesh, nor touch any thing that is unclean; that they observe the fasts, prayers, and washings, which their law prescribes; that they tell no lies, nor be guilty of deceit in trade; that they neither oppress nor offer violence to one another; that they celebrate the solemn feasts and fairs, and appropriate certain hours of ordinary sleep to cultivate a disposition for prayer; and that they do not steal or defraud one another.

The ceremonies, contained in the second part of the *Shaster*, are such as these: that they wash often in the rivers, hereby obtaining the pardon of their sins; that they mark their forehead with red, in token of their relation to the Deity; that they present offerings and prayers under certain trees, set apart for this purpose; that they pay in the temples, make oblations to their pagodas or idols, sing hymns, and make processions, &c.; that they make pilgrimages to distant rivers, and especially to the Ganges, there to wash themselves and make offerings; that they make vows to particular saints, according to their respective departments; that they render homage to the Deity at the full moon, and at the new moon, which are the two eyes of the Deity; and that they treat with particular veneration those animals that are deemed more pure than others; as the cow, buffalo, &c.; because the souls of men have transmigrated into these animals.

The third part of the *Shaster* records the distribution of the people into four classes: the first being that of the bramins or priests, appointed to instruct the people; the second, that of the kutteris or nobles, who are the magistrates; the third, that of the shudrers or merchants; and the fourth, that of the mechanics. Each person is required to remain in the class in which he was born, and to pursue the occupation assigned to him by the *Shaster*. According to the bramins, the *Shaster* was imparted by God himself to Brahma, and by him to the bramins; who communicated the contents of it to the people.

Modern writers have given us very different accounts of the antiquity and importance of the *Shaster*. Mr Holwell, who had made considerable progress in the translation of this book, apprehends, that the mythology as well as the cosmogony of the Egyptians, Greeks, and Romans, was borrowed from the doctrines of the bramins, contained in it, even to the copying of their exterior forms of worship, and the distribution of their idols, though grossly mutilated and adulterated. With respect to the Vedam and *Shaster*, or scriptures of the Gentoos, this writer informs us, that *Vedam*, in the Malabar language, signifies the same as *Shaster* in the Shanferit; and that the first book is followed by the Gentoos of the Malabar and Coromandel coasts, and also of the island of Ceylon. The *Shaster* is followed by the Gentoos of the provinces of Bengal, and by all the

Shafter. Gentoos of the rest of India, commonly called *India Proper*, along the course of the rivers Ganges and Jumna to the Indus. Both these books (he says) contain the institutes of their respective religion and worship, as well as the history of their ancient rajahs and princes, often couched under allegory and fable. Their antiquity is contended for by the partisans of each; but he thinks, that the similitude of their names, idols, and great part of their worship, leaves little room to doubt, may plainly evince, that both these scriptures were originally one. He adds, if we compare the great purity and chaste manners of the Shafter with the great absurdities and impurities of the Vedam, we need not hesitate to pronounce the latter a corruption of the former.

With regard to the high original of these scriptures, the account of the bramins is as follows. Brahma (that is, "Mighty Spirit"), about 4566 years ago, assumed the form of man and the government of Indostan. He translated the divine law (designed for the redemption of mankind, who had offended in a pre-existent state, and who are now in their last scene of probation, to the dignity from which they were degraded) out of the language of angels into the well known Sanscrit language, and called his translation the *Chariah Bhade Shajrah of Bramah*, or the *Six Scriptures of Divine Words of the Mighty Spirit*. He appointed the bramins, deriving their name from him, to preach the word of God; and the doctrines of the Shafter were accordingly preached in their original purity 1000 years. About this time there was published a paraphrase on the Chariah Bhade; and about 500 years afterwards, a second exposition, called the *Avghorrah Bhade Shafia*, or *Eighteen Books of Divine Words*, written in a character compounded of the common Indostan and the Sanscrit. This innovation produced a schism among the Gentoos; on which occasion, it is said, those of Coromandel and Malabar formed a scripture of their own, which they pretended to be founded on the Chariah Bhade of Bramah, and called it the *Volum of Bramah*, or *Discs Words of the Mighty Spirit*. The original Chariah Bhade was thrown aside, and at length wholly unknown, except to a few families; who can still read and expound it in the Sanscrit character. With the establishment of the Aughtorrah Bhade, and Vedam, which, according to the Gentoos account, is 3566 years ago, their polytheism commenced; and the principles of religion became so obscure, and their ceremonies so numerous, that every head of a family was obliged to keep a bramim as a guide both in faith and practice. Mr Holwell is of opinion, that the Chariah Bhade, or Original Scriptures, are not copied from any other system of doctrine, promulgated to or obtained upon mankind. The Gentoos do not attribute them to Zerobah; and Mr Holwell supposes, that both Zerobah and Pythagoras visited Indostan, not to instruct, but to be instructed.

From the account of Mr Dow, we learn, that the books which contain the religion and philosophy of the Hindoos are distinguished by the name of *Books*; that they are four in number, and like the sacred writings of other nations, said to be penned by the Divinity. *Beha*, he says, in the Sanscrit language, literally signifies *Law*; and these books treat not only of religion and moral duties, but of every branch of philosophy

Shafter. knowledge. The bramins maintain, that the *Bedas* are the divine laws, which Brinaha, at the creation of the world, delivered for the instruction of mankind; but they affirm, that their meaning was perverted in the first age by the ignorance and wickedness of some princes, whom they represent as evil spirits, who then haunted the earth.

The first credible account we have of the *Bedas* is, that about the commencement of the Cal Jug, of which era the year 1765 was the 4886th year, they were written, or rather collected, by a great philosopher and reputed prophet, called *Beis's Muni*, or *Deis's the Inspired*.

The Hindoos (says Mr Dow) are divided into two great religious sects: the followers of the doctrine of *Bedang*, which is the original Shafter, or commentary upon the *Bedas*; and those who adhere to the principles of the *Nendiken*. The original Shafter is called *Bedang*, and is a commentary upon the *Bedas*. This book, he says, is erroneously called in Europe the *Vedam*. It is ascribed to *Beis's Muni*, and is said to have been revised some years after by one *Serrider Swami*, since which it has been reckoned sacred, and not subject to any further alterations.

Almost all the Hindoos of the Deccan, and those of the Malabar and Coromandel coasts, are of this sect. The followers of the *Bedang* Shafter do not allow that any physical evil exists; they maintain that God created all things perfectly good; but that man, being a free agent, may be guilty of moral evil, which may be injurious to himself, but can be of no detriment to the general system of nature. God, they say, being perfectly benevolent, never punished the wicked otherwise than by the pain and affliction which are the natural consequences of evil actions; and hell, therefore, is no other than a consciousness of evil.

The *Nendiken* Shafter is said to have been written by a philosopher called *Gowam*, near four thousand years ago. The bramins, from Mr Dow's account of their sacred books, appear to believe invariably in the unity, eternity, omnipotence, and omnipresence of God; and the polytheism of which they have been accused is no more than a symbolical worship of the divine attributes, which they divide into three classes. Under the name of *Brinaha*, they worship the wisdom and creative power of God; under the appellation of *Deisen*, his providential and preserving quality; and under that of *Shahah*, that attribute which tends to destroy.

As few of our readers may have an opportunity of perusing the Shafter, we shall, by way of specimen, subjoin a passage from it, which, though it contains some metaphysical notions concerning the creation, yet discovers views of God so enlightened that they would not disgrace more refined nations. The passage which we shall quote is the first chapter of the Shafter, which is a dialogue between Brinaha the Wisdom of the Divinity, and Nared or Beatin, who is represented as the son of Brinaha. Nared desires to be instructed by his father; and that purpose, puts the following questions to him:

"Nared. O father! thou first of God, thou first to have created the world, and thy son Nared, who is called what he beholds, is desirous to be instructed by what thou hast first made.

"Brinaha. Be not desirous, my son! do not imagine that

Shadr. that I was the creator of the world, independent of the Divine Maker, who is the great original cause and creator of all things. Look, therefore, only upon me as the instrument of the great will, and a part of his being, whom he called forth to execute his eternal designs.

“*Narrad.* What do I think of God?”

“*Brinla.* Being immaterial, he is above all conception; being invisible, he can have no form; but, from what we behold in his works, we may conclude that he is eternal, omnipotent, knowing all things, and present everywhere.

“*Narrad.* How did God create the world?”

“*Brinla.* Affection dwelt with God for all eternity. It was of three different kinds; the creative, the preserving, and the destructive. This first is represented by Brimh, the second by Bohen, and the third by Shiroh. You, O Narrad, are taught to worship all the three in various shapes and likenesses, as the Creator, the Preserver, and the Destroyer. The affection of God then produced power, and power, at a proper conjunction of time and place, embraced goodness, and produced matter. The three qualities then acting upon matter, produced the subjects in the following manner: From the opposite actions of the creative and destructive quality in matter, self-motion first arose. Self-motion was of three kinds; the first inclining to pleasurable, the second to discord, and the third to rest. The discordant actions then produced the Akash (a kind of celestial element), which invisible element possessed the quality of conveying sound; it produced air, a palpable element; fire, a visible element; water, a fluid element; and earth, a solid element.

“The Akash diffused itself above. Air formed the atmosphere; fire, collecting itself, flamed forth in the host of heavens; water rose to the surface of the earth, being raised from beneath by the gravity of the latter element. This broke forth the world from the veil of darkness, in which it was formerly comprehended by God. Order rose over the universe. The seven heavens were formed, and the seven worlds were fixed in their places; there to remain till the great dissolution, when all things shall be absorbed into God.

“God raised the earth in full bloom, and that vegetation was sprung from its seeds, called forth for the first time intellect, which he endued with various organs and powers, to form a diversity of animals upon the earth. He endued the animals with five senses; feeling, seeing, smelling, tasting, and hearing; but to man he gave reason, to raise him above the beasts of the field.

“The creatures were created male and female, that they might propagate their species upon the earth. Every herb bore the seed of its kind, that the world might be clothed with verdure, and all animals provided with food.

“*Narrad.* What dost thou mean, O father! by Intellect?”

“*Brinla.* It is a portion of the great soul of the universe, breathed into all creatures, to animate them for a certain time.

“*Narrad.* What becomes of it after death?”

“*Brinla.* It animates other bodies, or returns, like wind, into that universal ocean from which it first arose.

“*Narrad.* Shall not then the souls of good men receive rewards? nor the souls of the bad meet with punishment?”

“*Brinla.* The souls of men are still absorbed into those of other animals; for the first are endued with reason, and with a consciousness of right and wrong. Therefore men shall adhere to the first, as for as his power doth extend; but that, when disengaged from the body's death, first be absorbed into the divine essence, and shall never more reunite to it: For the souls of those who do evil are not, at death, disengaged from all the elements. They are immediately taken with a body of fire, air, and akash, in which they are for a time purified in hell. After the term of their grief is over, they reunite to other bodies; but still they shall arrive at a state of purity they can never be absorbed into God.

“*Narrad.* What is the nature of that absorbed soul, which the souls of good men enjoy after death?”

“*Brinla.* It is a participated part of the divine nature, whose all passions are utterly unknown, and whose knowledge is lost in bliss.

“*Narrad.* Then I say, O father, that mind if the soul is perfectly pure it cannot be absorbed into God; now, as the actions of the generality of men are partly good and partly bad, whatever are their faults first immediately at death.”

“*Brinla.* They must atone for their crimes in hell, where they must remain for a space proportioned to the degree of their iniquities; then they rise to be rewarded for a time for their virtues; and from thence they will return to the world to reunite to the bodies.

“*Narrad.* What is time?”

“*Brinla.* Time existed from all eternity with God; but it can only be estimated since motion was produced, and only be conceived by the mind, from its own constant progress.

“*Narrad.* How long shall this world remain?”

“*Brinla.* Until the four yugs shall have revolved. Then Shadr (the same with Shiroh), the destroying quality of God, with the ten spirits of dissolution, shall roll a comet under the moon, that shall involve all things in fog, and reduce the world into ashes. God shall then call aloud, for matter will be totally annihilated.”

Those who desire more information on this subject may consult Don's History of Indouan, and Huxley's Interesting Historical Events.

SAW. DR. THOMAS, known to the learned world to be a credit to Barbary and the Levant, was born at Kendal in Westmoreland about the year 1702. He was an excellent captain in the English service at Algiers, in which it soon he continued for several years; and from thence to his great opportunities of travelling into different parts. He returned in 1733, and selected the town of the Royal Society, and published an account of his travels at Oxford, Feb. 1738. In 1742 he was nominated principal of St Edmund-hall, which he held from thence till he by his munificence, and was regular preacher of Greek at Oxford until his death, which happened in 1751. Dr. Thomas, bishop of Exeter, being dead, that it is worthy to be mentioned that Dr. Shaw published a sermon by way of vindication.

Shawl or **Shawling**, which is incorporated into the second edition of his *Travels*, prepared by himself, and published in 4to. 1757.

SHAWIA, a genus of plants, belonging to the class syngenesia, and order polygama segregata, of which the characters are the following; the calyx is imbricated with five or six leaves, the three interior of which are larger; the corolla is five-cleft; there is one oblong seed. One species only has been discovered, which is a native of New Zealand.

SHAWLS, are woollen handkerchiefs, an ell wide, and near two long. The wool is so fine and silky, that the whole handkerchief may be contained in the two hands cloled. It is the produce of a Tibet sheep; but some say that no wool is employed but that of lambs torn from the belly of their mother before the time of birth. The most beautiful shawls come from Cashmere: their price is from 150 livres (about six guineas) to 1200 livres (or 50l. sterling).

In the Transactions of the Society for Encouraging Arts, Manufactures, &c. for the year 1792, we are informed that a shawl counterpane, four yards square, manufactured by Mr P. J. Knights of Norwich, was presented to the society; and that, upon examination, it appeared to be of greater breadth than any goods of equal fineness and texture that had ever before been presented to the society, or to their knowledge woven in this country. The shawls of Mr Knights's manufacture, it is said, can scarcely be distinguished from Indian shawls, though they can be afforded at one-twentieth part of the price. When the shawl is 16 quarters square, Mr Knights says it may be retailed at 20l.; if it consisted of 12 quarters, and embroidered as the former, it will cost 3l.; if plain, with a fringe only, a shawl of 16 quarters square may be sold at 8l. 8s.; if 12 quarters and fringed, at 6l. 6s.

Mr Knights maintains, that his counterpane of four yards square is equal in beauty, and superior in strength, to the Indian counterpanes, which are sold at 200 guineas. The principal consumption of this cloth is in train-dresses for ladies; as likewise for long scarfs, in imitation of the real Indian scarfs, which are sold from 62l. to 80l.; whereas scarfs of this fabric are sold for as many shillings, and the ladies square shawls in proportion.

SHEADING, a riding, tything, or division, in the life of Man; the whole island being divided into six sheadings; in every one of which is a coroner or chief constable, appointed by the delivery of a rod at the annual convention.

SHEARBILL, the *Rhynchops Nigra* of Linnæus, the *Black Skimmer* of Pennant and Latham, and *Cut-water* of Catesby. See ORNITHOLOGY *Indec.*

SHEATHING, in the sea-language, is the casing that part of a ship which is to be under water with fir-board of an inch thick; first laying hair and tar mixed together under the boards, and then nailing them on, in order to prevent worms from eating the ship's bottom.—Ships of war are now generally sheathed with copper: but copper sheathing is liable to be corroded by the action of salt water, and something is still wanted to effect this purpose. It is very probable that tar might answer very well.

In the Cornish mines, copper or brass pimps are often placed in the deepest parts, and are consequently expo-

sed to the vitriolic or other mineral waters with which some of these mines abound, and which are known to have a much stronger effect on copper than sea water. These pimps are generally about six feet long, and are screwed together, and made tight by the interposition of a ring of lead, and the joinings are afterwards tarred. One of these pimps was so much corroded as to render it unfit for use; but the spots of tar, which by accident had dropped on it, preserved the parts they covered from the action of the water. These projected in some places more than a quarter of an inch; and the joints were so far defended by the thin coat of tar, that it was as perfect as when it came from the hands of the manufacturer. If tar thus effectually defends copper from these acrid waters, can there remain a doubt of its preserving it from the much milder waters of the sea?

SHEATS, in a ship, are ropes bent to the clews of the sails, serving in the lower fails to haul at the clews of the sail; but in topsails they serve to haul home the clew of the fall close to the yard-arm.

SHEAVE, in *Mechanics*, a solid cylindrical wheel, fixed in a channel, and moveable about an axis, as being used to raise or increase the mechanical powers applied to remove any body.

SHEBBEARE, JOHN, a political writer, was born at Bideford in Devonshire, in the year 1709. He received the rudiments of his education at the free grammar school of Exeter. It has been often observed, that the future life of a man may be gathered from his puerile character; and accordingly Shebbeare, while a boy at school, gave the strongest indications of his future eminence in philanthropy and learning, by the extraordinary tenaciousness of his memory and the readiness of his wit, as well as the malignity of his disposition; being universally regarded as a young man of surprising genius, while at the same time he was despised for his malicious temper.

About the age of 16, Shebbeare was bound apprentice to an eminent surgeon in his native town, under whom he acquired a considerable share of medical knowledge. His talent for lampoon appeared at this early period, and he could not forbear from exercising it on his master; but the chief marks for the arrows of his wit were the gentlemen of the corporation, some of whom laughed at such trifles, while such as were irritable often commenced prosecutions against him, but without success. He was frequently summoned to appear at the sessions, for daring to speak and write disrespectfully of the magistrates; but the laugh was always on the side of Shebbeare.

When his time was out, he set up for himself, then discovering a taste for chemistry; soon after which he married an amiable young woman with no fortune, but of respectable connections. Failing in business at Bideford, he went to Bristol in 1736, entering into partnership with a chemist, and never afterwards visited his native town.

The attention of the public was, in the year 1739, attracted by an epitaph to the memory of Thomas Corser, Esq. M. P. for Bristol, in which he contrived to raise emotions of pity, grief, and indignation. In the following year he published a pamphlet on the Bristol waters, after which we know little or nothing respecting him for a number of years. He was at Paris in 1752, where he obtained, it is said, the degree of doctor in medicine,

Shebbeare, a fact, however, which many are disposed to question. About this time he began to emerge from obscurity, and draw the attention of the public, by pamphlets written with such violence and celebrity as it would be difficult to equal in the most intemperate times. In 1754 he commenced his career with a work denominated the *Marriage Act*, a political novel, in which he treated the legislature with such freedom that he was apprehended, but soon after set at liberty.

The most celebrated performances, however, were a series of letters to the People of England, written in a vigorous and energetic style, well calculated to make an impression on common readers; and they were of course read with avidity, and diligently circulated. They galled the ministry, who at first were too eager to punish the author. When the third letter was published, warrants were issued by Lord Holdernesse in March 1756, to take up both the publisher and the author; a prosecution which appears to have been dropt. On the 12th of January 1758, the same nobleman signed a general warrant for apprehending the author, printer, and publishers of a wicked, audacious, and treasonable libel, entitled, "A sixth letter to the people of England, on the progress of national ruin, in which is shewn that the present grandeur of France and calamities of this nation are owing to the influence of Hanover on the councils of England;" and then having found, to seize and apprehend, together with their books and papers.

Government having received information that a seventh letter was in the press, all the copies were seized and suppressed by virtue of another warrant, dated January 23. In Easter term an information was filed against him by the attorney-general, and on the 17th of June the information was tried, when Shebbeare was found guilty; and on the 23th of November he received sentence, by which he was fined gl . ordered to stand in the pillory December 5, at Charing Cross, to be confined three years, and to give security for his good behaviour for seven years, himself in 500*l*. and two others in 250*l*. each. During his confinement, he declared he never received as presents more than 20 guineas from all the world.

He was detained in prison during the whole time of the sentence, and with some degree of rigour; for when his life was in danger from a bad state of health, and he applied to the court of king's-bench for permission to be carried into the rules a few hours in a day; though Lord Mansfield acceded to the petition, the prayer of it was denied and defeated by Judge Foster. At the termination of the time of his sentence, a new reign commenced; and shortly afterwards, during Mr Grenville's administration, a pension of 250*l*. a-year was granted him by the crown, through the influence of Sir John Phillips; and he ever after became devoted to the service of government. He was of course abused in almost every periodical work, which he seems in general to have had the good sense to neglect. Dr Smollet introduced him, in no very respectful light, under the name of Ferret, in Sir Launcelet Greaves; and Mr Hogarth made him one of the group in the third election print.

During the latter part of his life he seems to have written but little. He strenuously supported the ministry during the American war, having published, in

1775, an answer to the printed speech of Edmund Burke, Esq. spoken in the house of commons, April 19, 1774, wherein he investigates his knowledge of policy, legislature, human kind, history, commerce, and finance; his arguments are examined; the conduct of administration is boldly defended, and his talents as an orator clearly exposed to view. An essay on the origin, progress, and establishment of National Society; in which the principles of government, the definition of physical, moral, civil, and religious liberty contained in Dr Price's observations, &c. are examined and controverted; together with a justification of the legislature in reducing America to obedience by force.

His publications of a satirical, political, and medical nature, amount to 34, besides a novel called Filled Piety, in which hypocrisy and blustering courage are very properly chastised. He died on the 11th of August 1788, leaving behind him the character of a benevolent man among those who were best acquainted with him; a character which, from the manner he speaks of his connections, he probably deserved.

SHEEP, in *Zoology*. See OVIS and WOOL.

Amongst the various animals with which Divine Providence has stored the world for the use of man, none is to be found more innocent, more useful, or more valuable, than the sheep. The sheep supplies us with food and clothing, and finds ample employment for our poor at all times and seasons of the year, whereby a variety of manufactures of woollen cloth is carried on without interruption to domestic comfort and loss to friendly society or injury to health, as is the case with many other occupations. Every lock of wool that grows on its back becomes the means of support to tapers, dyers, pickers, scourers, scriblers, carders, combers, spinners, spoolers, waspers, queilers, weavers, fullers, tuckers, barbers, shearmen, profers, clothiers, and pickers, who, one after another, tumble and toil, and twist and bake, and boil, this raw material, till they have each extracted a livelihood out of it; and then comes the merchant, who, in his turn, ships it (in its highest state of improvement) to all quarters of the globe, from whence he brings back every kind of riches to his country, in return for this valuable commodity which the sheep affords.

Besides this, the useful animal, after being deprived of his coat, produces another against the next year; and when we are hungry, and kill him for food, he gives us his skin to employ the fell-mongers and parchment-makers, who supply us with a durable material for securing our estates, rights, and possessions; and if our enemies take the field against us, supplies us with a powerful instrument for rousing our courage to repel their attacks. When the parchment-maker has taken as much of the skin as he can use, the glue-maker comes after and picks up every morsel that is left, and there-with supplies a material for the carpenter and cabinet-maker, which they cannot do without, and which is essentially necessary before we can have elegant furniture in our houses; tables, chairs, looking-glasses, and a hundred other articles of convenience: and when the winter nights come on, while we are deprived of the cheering light of the sun, the sheep supplies us with an artificial mode of light, whereby we preserve every pleasure of domestic society, and with whose assistance we can continue our work, or write or read, and improve

our hands, or enjoy the social mirth of our tables. Another part of the slaughtered animal supplies us with an ingredient necessary for making good common soap, a useful store for producing cleanliness in every family, rich or poor. Neither need the bones be thrown away; for they are converted by the button-makers and turners into a cheap kind of buttons, tips for bows, and many useful ornaments. From the very testicles an oil is extracted useful for many purposes, and they afford good food when baked in an oven.

Even the bones are useful also; for by a late invention of Dr Higgins, they are found, when reduced to ashes, to be an useful and essential ingredient in the composition of the finest artificial stone in ornamental work for chimney-pieces, carnicies of rooms, houses, &c. which renders the composition more durable by effectually preventing its cracking (A).

It is objected to the meek inoffensive creature, that he is expensive while living, in eating up our grass, &c. &c. It may be answered that it is quite the contrary; for he may be said where every other animal has been before him and grazed all they could find; and that if he takes a little grass on our downs, or in our fields, he amply repays us for every blade of grass in the richness of the manure which he leaves behind him. He protects the hands from the cold wintry blast, by providing them with the finest leather gloves. Every gentleman's library is also indebted to him for the neat binding of his books, for the sheath of his sword, and for cases for his instruments; in short, not to be tedious in mentioning the various uses of leather, there is hardly any furniture or utensil of life but the sheep contributes to render either more useful, convenient, or ornamental.

As the sheep is so valuable an animal, every piece of information concerning the proper method of managing it must be of importance. It will not therefore be useless or unentertaining to give some account of the manner of managing sheep in Spain, a country famous for producing the best wool in the world.

In Spain there are two kinds of sheep: the coarse-wooled sheep, which always remain in their native country, and are housed every night in winter; and the fine-wooled sheep, which are always in the open air, and travel every summer from the cool mountains of the northern parts of Spain, to feed in winter on the southern warm plains of Andalusia, Mancha, and Extrama-

da. Of these latter, it appears from accurate computations, that there are about five millions (B); and that the wool and flesh of a flock of 10,000 sheep produced yearly about 24 real's a head, about the value of 12 English shillings, one of which belongs to the owner, three to the king, and the other eight are allowed for the expenses of pasture, tithes, shepherds, dogs, salt, tanning, &c. Ten thousand sheep form a flock, which is divided into ten tribes, under the management of one person, who has absolute dominion over fifty shepherds and fifty dogs.

M. Bougoanne, a French gentleman, who resided many years in Spain, and directed his inquiries chiefly to the civil government, trade, and manufactures, of that country, gives the following account of the wandering sheep of Segovia. "It is (says he) in the neighbouring mountains that a part of the wandering sheep feed during the fine season. They leave them in the month of October, pass over those which separate the two Castiles, cross New Castile, and disperse themselves in the plains of Extremadura and Andalusia. For some years past, those of the two Castiles, which are within reach of the Sierra-Morena, go thither to pass the winter; which, in that part of Spain, is more mild; the length of their day's journey is in proportion to the pasture they meet with. They travel in flocks from 1200 to 1200 in number, under the conduct of two shepherds; one of whom is called the *Mayoral*, the other the *Zagal*. When arrived at the place of their destination, they are admitted in the pastures previously assigned them. They return in the month of April; and whether it be habit or natural instinct that draws them towards the climate, which at this season becomes most proper for them, the inquietude which they manifest might, in case of need, serve as an alarm to their conductors."

Mr Arthur Young, in that patriotic work which he conducted with great industry and judgement, the Annals of Agriculture, gives us a very accurate and interesting account of the Pyrenean or Catalonian sheep.

"On the northern ridge, bearing to the west, are the pastures of the Spanish flocks. This ridge is not, however, the whole; there are two other mountains, quite in a different situation, and the sheep travel from one to another as the pasturage is short or plentiful. I examined the soil of these mountain pastures, and found it in general stony; what in the west of England would be

(A) Any curious person would be much entertained to see the manufactory of bone-ash, now (about 1794) carried on by Mr Finch of White-chapel, New Road, wherein the bones of sheep and cows undergo many ingenious processes. 1. There is a mill to break them; 2. A cauldron to extract their oil, marrow, and fat; 3. A reverberatory to heat them red hot; 4. An oven, for these bones to moulder to ashes; 5. A mill to collect the flames of the burnt bones into a heavy fluid, from whence hartshorn is made; 6. Furnaces for making parts thereof into Ghobel's salts; 7. A final lead containing twelve jars, for collecting a crystallizing vapour into sal-ammoniac.

(B) In the 16th century the travelling flocks were estimated at seven millions; under Phillip III. the number was diminished to two millions and a half. Ullrich, who wrote at the beginning of the 18th century, made it amount to four millions. The general opinion is, that at present it does not exceed five millions. If to this number there be added the stationary flocks, it will make nearly thirteen millions of animals, all managed contrary to the true interests of Spain, for the advantage of a few individuals. For the proprietors of stationary flocks will have privileges which greatly resemble those of the members of the Meda. According to Arrueboer, Spain consists of 12 millions of fine-wooled sheep, ten millions of coarse-wooled, and five hundred thousand bullocks, cows, and ewes.

Sheep.

this county, it is no uncommon thing to give fifty guineas for a ram, and a guinea for the admission of an ewe to one of these valuable males, or twenty guineas for the use of it for a certain number of ewes during one season. Suffolk also breeds a very valuable kind of sheep. The northern counties in general breed sheep with long but hairy wool: however, the wool which is taken from the neck and shoulders of the Yorkshire sheep is used for mixing with Spanish wool in some of their finest cloths.

Wales bears a small hardy kind of sheep, which has the best tasted flesh, but the worst wool of all. Nevertheless it is of more extensive use than the finest Segovian fleeces; for the benefit of the flannel manufacture is universally known. The sheep of Ireland vary like those of Great Britain; those of the south and east being large and their flesh rank: those of the north and the mountainous parts small and their flesh sweet. The fleeces in the same manner differ in degrees of value. Scotland breeds a small kind, and their fleeces are coarse.

But the new Leicestershire breed is the most fashionable, and of course the most profitable breed in the island. Joseph Alton of Clifton, who raised himself from a plough-boy, was the first who distinguished himself in the midland counties of England for a superior breed of sheep. How he improved his breed is not known; but it was customary for eminent farmers in his time to go to Clifton in summer to choose and purchase ram-lambs, for which they paid two or three guineas. This man was succeeded by Mr Bakewell; and it may reasonably be supposed that the breed, by means of Alton's flock, had passed the first stage of improvement before Mr Bakewell's time. Still, however, it must be acknowledged, that the Leicestershire breed of sheep owes its present high state of improvement to the ability and care of Mr Bakewell.

"The manner in which Mr Bakewell raised his sheep to the degree of celebrity in which they deservedly stand, is, notwithstanding the recentness of the improvement, and its being done in the day of thousands now living, a thing in dispute; even among men high in the profession, and living in the very district in which the improvement has been carried on!

"Some are of opinion that he effected it by a cross with the Wiltshire breed; an improbable idea, as their form altogether contradicts it: others, that the Ryeland breed were used for this purpose; and with some show of probability. If any cross whatever was used the Ryeland breed, whether we view the form, the size, the wool, the flesh, or the fatting quality, is the most probable instrument of improvement.

"These ideas, however, are registered merely as matters of opinion. It is more than probable that Mr Bakewell alone is in possession of the several minutæ of improvement; and the public can only hope that at a proper time the facts may be communicated for the direction of future improvers.

"Whenever this shall take place, it will most probably come out that no cross with any alien breed whatever has been used; but that the improvement has been ef-

fected by selecting individuals from kindred breeds; from the several breeds or varieties of long-woolled sheep, with which Mr Bakewell was furnished on almost every side, and by breeding, *inandin* (C), with this selection: solicitously seizing the superior accidental varieties produced; associating these varieties; and still continuing to select, with judgement, the superior individuals.

"It now remains to give a description of the superior class of individuals of this breed, especially ewes and widders, in full condition, but not immoderately fat. The rams will require to be distinguished afterwards.

"The head is long, small, and hornless, with ears somewhat long, and standing backward, and with the nose shooting forward. The neck thin, and clean toward the head; but taking a conical form; standing low, and enlarging every way at the base; the fore-end altogether short. The bosom broad, with the shoulders, ribs, and chine extraordinary full. The loin broad, and the back level. The haunches comparatively full toward the hips, but light downward; being altogether small in proportion to the fore-parts. The legs, at present, of a moderate length; with the bone extremely fine. The bone throughout remarkably light. The carcass, when fully fat, takes a remarkable form; much wider than it is deep, and almost as broad as it is long. Full on the shoulder, widest on the ribs, narrowing with a regular curve towards the tail; approaching the form of the turtle nearer perhaps than any other animal. The pelt is thin, and the tail small. The wool is shorter than long wools in general, but much longer than the middle wools; the ordinary length of staple five to seven inches, varying much in fineness and weight."

"This breed surpasses every other in beauty of form; they are full and weighty in the fore quarters; and are remarkable for smallness of bone. Mr Marshall, who has been of so much benefit to agriculture and his country by his publications, informs us, in his Rural Economy of the Midland Counties, that he has seen a rib of a sheep of this breed contrasted with one of a Norfolk sheep: the disparity was striking; the latter nearly twice the size; while the meat which covered the former was three times the thickness; consequently the proportion of meat to bone was in the one incomparably greater than in the other. Therefore, in this point of view, the improved breed has a decided preference: for surely while mankind continue to eat flesh and throw away bone, the former must be, to the consumer at least, the more valuable.

"The criterions of good and bad flesh while the animal is alive differ in different species, and are not properly settled in the same species. One superior breeder is of opinion, that if the flesh is not loose, it is of course good; holding, that the flesh of sheep is never found in a state of hardness, like that of ill-fleshed cattle: while others make a fourfold distinction of the flesh of sheep; as loofeness, mellowness, firmness, hardness: considering the first and the last equally exceptionable, and the second and third equally desirable; a happy mixture of the two being deemed the point of perfection.

The

(C) *Inandin* is a term used in the midland counties of England to express breeding from the same family.

A FIRST-RATE SHIP OF WAR with Rigging &c. at Anchor.

Fig 4.

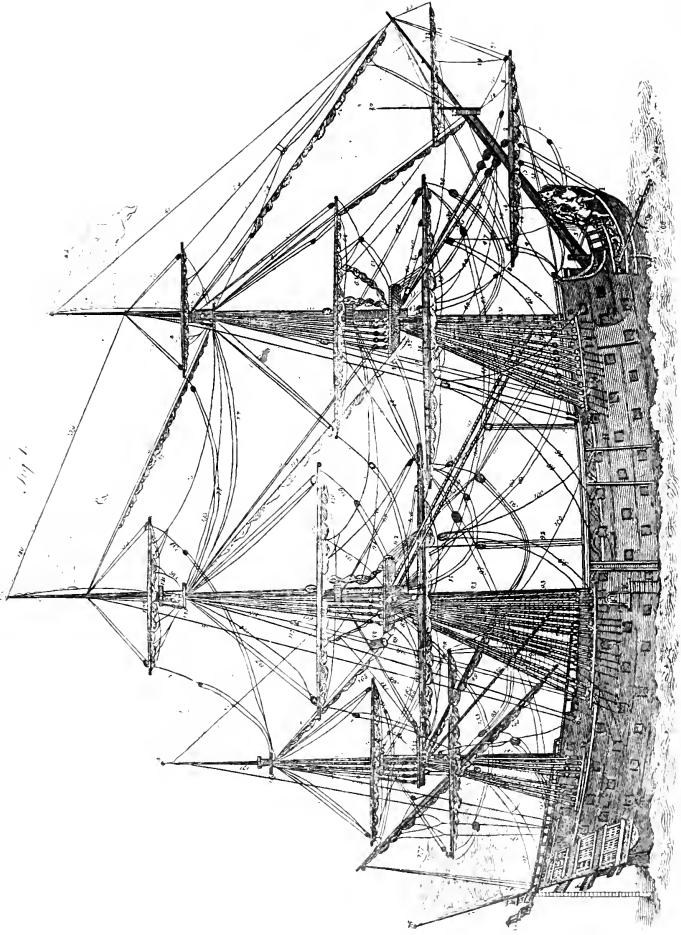

Fig. 3.

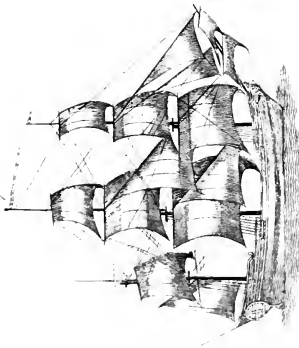

Fig. 4.

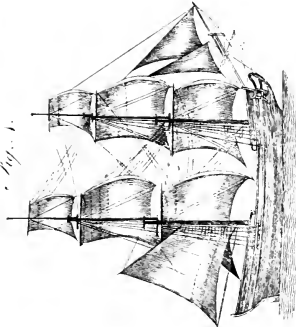

Fig. 5.

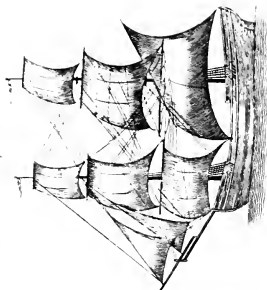
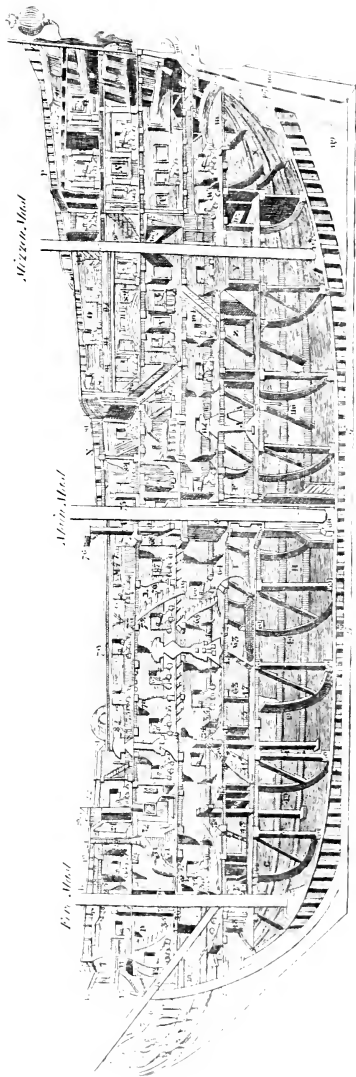

Fig. 6.

The Section of a First Rate Ship of War, Shewing its various Timbers and Apartments.





S. 1000

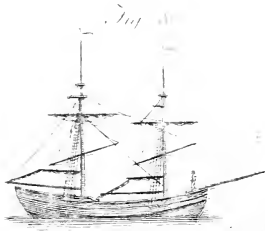

Fig. 8

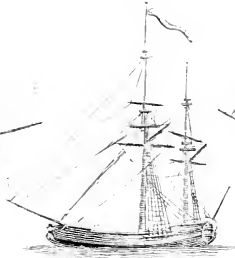

Fig. 9

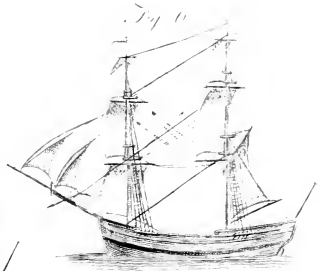

Fig. 10

Fig. 10

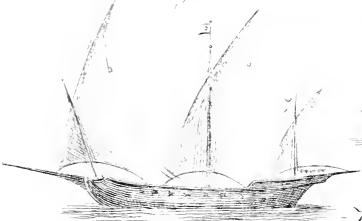

Fig. 12

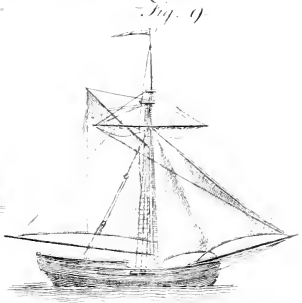

Fig. 13

Fig. 14



Fig. 15

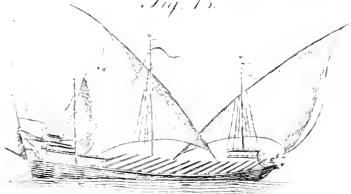
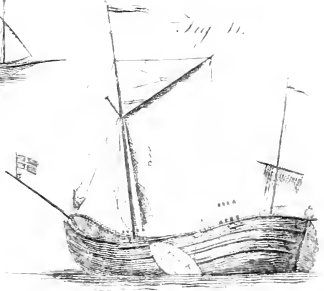
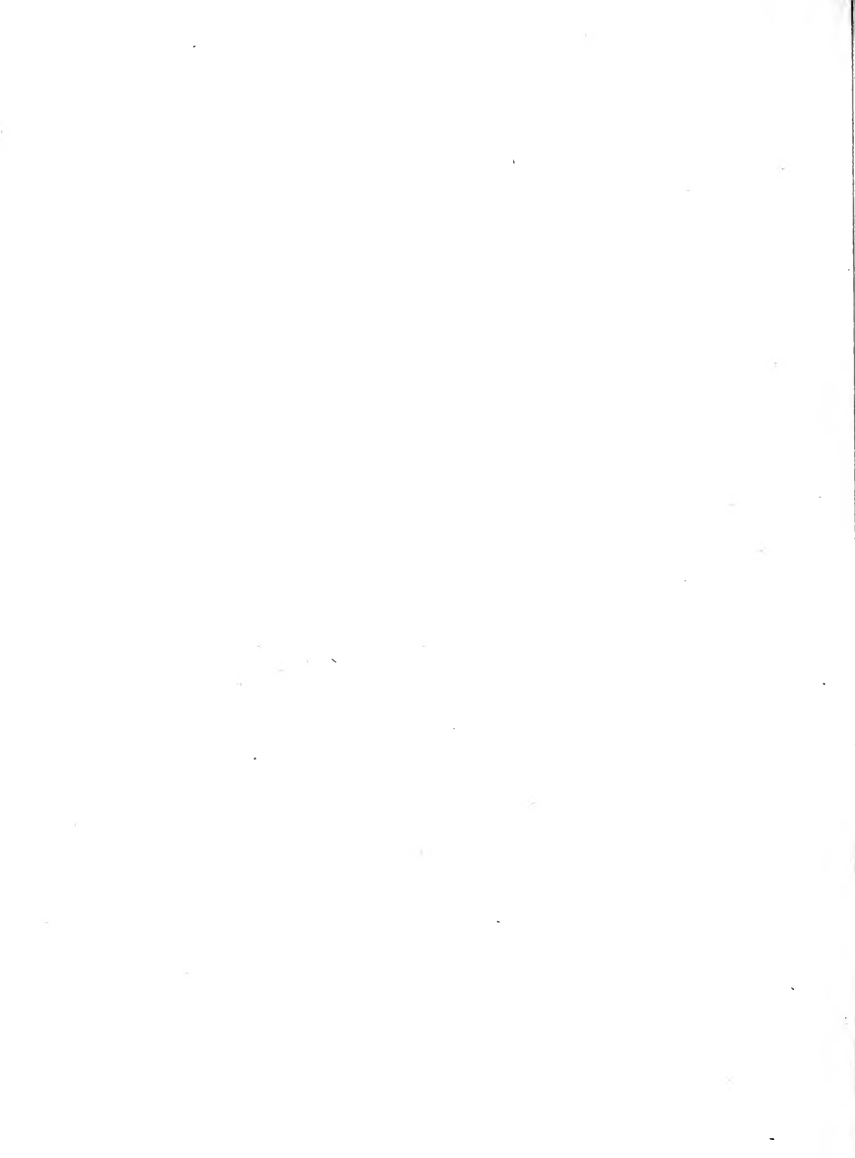
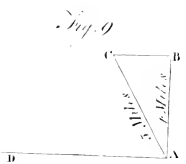
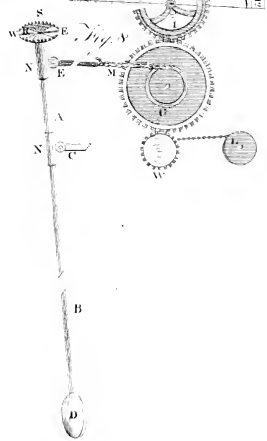
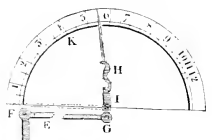
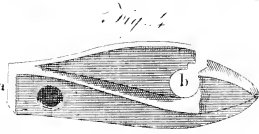
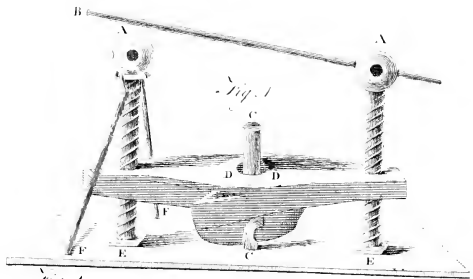

Fig. 16





Screw Bolts



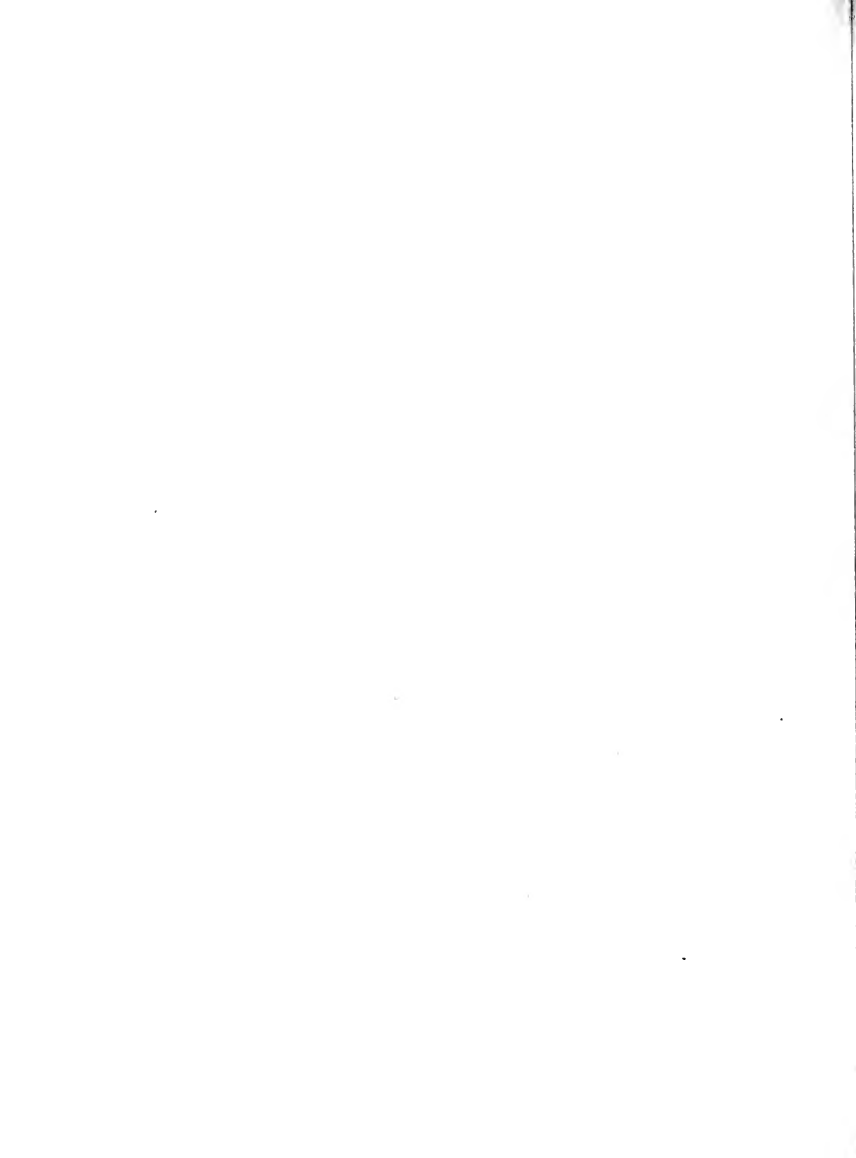

Sheep.

The flesh of sheep, when slaughtered, is well known to be of various qualities. Some is composed of large coarse grains, interspersed with wide empty pores like a sponge; others, of large grains, with wide pores filled with fat; others, of fine close grains, with smaller pores filled with fat; and a fourth, of close grains, without any intermixture of fats.

The flesh of sheep, when dressed, is equally well known to possess a variety of qualities: some mutton is coarse, dry, and insipid; a dry sponge, affording little or no gravy of any colour. Another sort is somewhat firmer, imparting a light-coloured gravy only. A third plump, short, and palatable; affording a mixture of white and red gravy. A fourth likewise plump and well-flavoured, but discharging red gravy, and this in various quantities.

It is likewise observable, that some mutton, when dressed, appears covered with a thick, tough, parchment-like integument; others with a membrane comparatively fine and flexible. But these, and some of the other qualities of mutton, may not be wholly owing to breed, but in part to the age and the state of fatness at the time of slaughter. Examined in this light, whether we consider the degree of fatness, or their natural propensity to a state of fatness, even at an early age, the improved breed of Leicestershire sheep appears with many superior advantages.

The degree of fatness to which the individuals of this breed are capable of being raised, will perhaps appear incredible to those who have not had an opportunity of being convinced by their own observation. "I have seen widders (says Mr Marshall) of only two shear (two or three years old) so loaded with fat as to be scarcely able to make a run; and whose fat lay so much without the bone, it seemed ready to be shaken from the ribs on the smallest agitation.

"It is common for the sheep of this breed to have such a projection of fat upon the ribs, immediately behind the shoulder, that it may be easily gathered up in the hand, as the flank of a fat bullock. Hence it has gained, in technical language, the name of the *fire-rank*; a point which a modern breeder never fails to touch in judging of the quality of this breed of sheep.

"What is, perhaps, still more extraordinary, it is not rare for the rams, at least of this breed, to be 'cracked on the back'; that is, to be cloven along the top of the chine, in the manner fat sheep generally are upon the rump. This mark is considered as an evidence of the best blood.

"Extraordinary, however, as are these appearances while the animals are living, the facts are still more striking after they are slaughtered. At Litchfield, in February 1785, I saw a fore quarter of mutton, fatted by Mr Prince of Croxall, and which measured upon the ribs four inches of fat. It must be acknowledged, however, that the Leicestershire breed do not produce so much wool as most other long-woolled sheep."

As the practice of letting rams by the season is now become profitable, it may be useful to mention the method of rearing them.

"The principal ram-breeders five annually twenty, thirty, or perhaps forty ram lambs; castration being seldom applied, in the first instance, to the produce of a valuable ram, for in the choice of these lambs they are led more by blood or parentage, than by form; and

which, at an early age, little dependence can be placed. Their treatment from the time they are weaned, in July or August, until the time of shearing, the first week in June, consists in giving them every indulgence of keep, in order to push them forward for the show; it being the common practice to let such as are fit to be let the first season, while they are yet yearlings—provincially 'sharhogs.'

"Their first pasture, after weaning, is pretty generally, I believe, clover that has been mown early, as I has got a second time into head; the heads of clover being considered as a most forcing food of sheep. After this goes off, turnips, cabbages, colewort, with hay, and (re ort says) with corn. But the use of this the breeders severally deny, though collectively they may be liable to the charge.

"Be this as it may, something considerable depends on the art of *making up*, not lambs only, but rams of all ages. Fat, like charity, covers a multitude of faults; and besides, is the best evidence of their fattening quality which their owners can produce (*i. e.* their natural propensity to a state of fatness), while in the fatness of the sharhogs is seen their degree of inclination to fat at an early age.

"Fattening quality being the one thing needful in grazing stock, and being found, in some considerable degree at least, to be hereditary, the fatter rams are of course the best; though other attachments, well or ill placed, as to form or fashionable points, will perhaps have equal or greater weight in the minds of some men, even in this enlightened age. Such yearlings as will not make up sufficiently as to form and fatness, are either kept on to another year to give them a fair chance, or are castrated, or butchered while sharhogs."

From the first letting, about 40 years ago, to the year 1780, the prices kept gradually rising from fifteen shillings to a guinea, and from one to ten. In 1780 Mr Bakewell let several at ten guineas each; and what is rather inexplicable, Mr Parkinson of Quardon let one the same year for twenty-five guineas; a price which then astonished the whole country.

From that time to 1786 Mr Bakewell's stock rose rapidly from ten to a hundred guineas; and that year he let two thirds of one ram (reserving one third of the usual number of ewes to himself) to two principal breeders, for a hundred guineas each, the entire services of the ram being rated at three hundred guineas! Mr Bakewell making that year, by letting twenty rams only, more than a thousand pounds!

Since that time the prices have been still rising. Four hundred guineas have been repeatedly given. Mr Bakewell, this year (1780) makes, says Mr Marshall, twelve hundred guineas by three rams (brothers, we believe); two thousand of seven; and of his whole letting, full three thousand guineas!

Beside this extraordinary sum made by Mr Bakewell, there are six or seven other breeders who make from five hundred to a thousand guineas each. The whole amount of moneys produced that year in the inland counties, by letting rams of the modern breed for one season only, is estimated, by those who are adequate to the subject, at the almost incredible sum of ten thousand pounds.

Rams previous to the season are reduced from the cumbersome fat state in which they are shown. The usual

Midland
Counties,
v. 1.
p. 398.

10
How the
rams are
reared.

What sums
Mr Bakewell
well received
for letting
them.

Sheep.

The feeding sheep with turnips is one great advantage to the farmers. When they are made to eat turnips they soon fatten, but there is some difficulty in bringing this about. The old ones always refuse them at first, and will sometimes eat three or four days, till almost famished; but the young lambs fall to at once. The common way, in some places, of turning a flock of sheep at large into a field of turnips, is very disadvantageous, for they will thus destroy as many in a fortnight as would keep them a whole winter. There are three other ways of feeding them on this food, all of which have their several advantages.

15
The first way of feeding sheep with turnips.

The first way is to divide the land by hurdles, and allow the sheep to come upon such a portion only at a time as they can eat in one day, and so advance the hurdles further into the ground daily till all be eaten. This is infinitely better than the former random method; but they never eat them clean even this way, but leave the bottoms and outides scooped in the ground; the people pull up these indeed with iron crooks, and lay them before the sheep again, but they are commonly so fouled with the creature's dung and urine, and with the dirt from their feet, that they do not care for them; they eat but little of them, and what they do eat does not nourish them like the fresh roots.

16
The second way of feeding sheep with turnips.

The second way is by inclosing the sheep in hurdles, as in the former; but in this they pull up all the turnips which they suppose the sheep can eat in one day, and daily remove the hurdles over the ground whence they have pulled up the turnips; by this means there is no waste, and less expence, for a person may in two hours pull up all those turnips; the remaining shells of which would have employed three or four labourers a day to get up with their crooks out of the ground trodden hard by the feet of the sheep; and the work is, that as in the method of pulling up first, the turnips are eaten up clean, in this way, by the hook, they are wasted, the sheep do not eat any great part of them, and when the ground comes to be tilled afterwards for a crop of corn, the fragments of the turnips are seen in such quantities on the surface, that half the crop at least seems to have been wasted.

17
The third way of feeding sheep with turnips, which is the best.

The third manner is to pull up the turnips, and remove them in a cart or wagon to some other place, spreading them on a fresh place every day; by this method the sheep will eat them up clean, both root and leaves. The great advantage of this method is, when there is a piece of land not far off which wants dung more than that where the turnips grew, which perhaps is also too wet for the sheep in winter, and then the turnips will, by the too great moisture and dirt of the soil, sometimes spoil the sheep, and give them the rot. Yet such ground will often bring forth more and larger turnips than dry land, and when they are carried off, and eaten by the sheep on ploughed land, in dry weather, and on green sward in wet weather, the sheep will succeed much better; and the moist soil where the turnips grew not being trodden by the sheep, will be much fitter for a crop of corn than if they had been fed with turnips on it. The expence of hurdles, and the trouble of moving them, are saved in this case, which will counterbalance at least the expence of pulling the turnips and carrying them to the places where they are to be eaten. They must always be carried off for oxen.

18
Diseases of sheep.

The diseases to which sheep are subject are these,

rot, red-water, foot-rot and hooving, *fever*, *distemper*, *flux*, *and* *burning*. Of each of these we shall give the best description in our power, with the most approved remedies.

The rot, which is a very pernicious disease, has of late engaged the attention of scientific farmers. Not neither its nature nor its cause has yet been fully ascertained. Some valuable and judicious observations have, however, been made upon it, which ought to be circulated, as they may perhaps, in many cases, furnish an antidote for this malignant distemper, or be the means of leading others to some more efficacious remedy. Some have supposed the rot owing to the quick growth of grass or herbs that grow in wet places. Without premitting, that all bounteous Providence has given to every animal its peculiar taste, by which it distinguishes the food proper for its preservation and support, if not vitiated by fortuitous circumstances, it seems very difficult to discover on philosophical principles why the quick growth of grass should render it noxious, or why any herb should at one season produce fatal effects, by the admission of pure water only into its component parts, which at other times is perfectly innocent, although brought to its utmost strength and maturity by the genial influence of the sun. Besides, the constant practice of most farmers in the kingdom, who with the greatest security feed their meadows in the spring, when the grass shoots quick and is full of juices, militates directly against this opinion.

Mr Arthur Young ascribes this disease to moisture. In confirmation of this opinion, which has been generally adopted, we are informed, in the Bath Society papers, by a correspondent, that there was a paddock adjoining to his park which had for several years called the rot in most of the sheep which were put into it. In 1769 he drained it, and from that time his sheep were free from this malady. But there are facts which render it doubtful that moisture is the sole cause. We are told, the dry limed land in Derbyshire will produce the rot as well as water meadows and stagnant marshes; and that in some wet grounds sheep sustain no injury for many weeks.

Without attempting to enumerate other hypotheses, which the ingenious have formed on this subject, we shall pursue a different method in order to discover the cause. On dissecting sheep that die of this distemper, a great number of insects called *flukes* (the *Distomatæ*) are found in the liver. That these flukes are the cause of the rot, therefore, is evident; but to explain how they come into the liver is not so easy. It is probable that they are swallowed by the sheep along with their food while in the egg state. The eggs deposited in the tender germ are conveyed with the food into the stomach and intestines of the animals, whence they are received into the lacteal vessels, carried off in the chyle, and pass into the blood; nor do they meet with any obstruction until they arrive at the capillary vessels of the liver. Here, as the blood filters through the extreme branches, answering to those of the *vena porta* in the human body, the filtering vessels are too minute to admit the impregnated ova, which, adhering to the membrane, produce those animalcules that feed upon the liver and destroy the sheep. They much resemble the flat fish called plaice, are sometimes as large as a silver two pence, and are found both in the liver and in

the pipe (answering to that of the *vena cava*) which conveys the blood from the liver to the heart.

The common and most obvious objection to that opinion is, that this insect is never found but in the liver, or in some parts of the viscera, of sheep that are diseased more or less; and that they must therefore be bred there. But this objection will lose its force, when we consider that many insects undergo several changes, and exist under forms extremely different from each other. Some of them may therefore appear and be well known under one shape, and not known to be the same under a second or third. The fluke may be the last state of some aquatic animal which we at present very well know under one or other of its previous forms.

If this be admitted, it is easy to conceive that sheep may, on wet ground especially, take multitudes of these ova or eggs in with their food; and that the stomach and viscera of the sheep being a proper nidus for them, they of course hatch, and appearing in their fluke or last state, feed on the liver of the animal, and occasion this disorder.

It is a singular fact, "that no ewe ever has the rot while she has a lamb by her side." The reason of this may be, that the impregnated ovum passes into the milk, and never arrives at the liver. The rot is fatal to sheep, hares, and rabbits, and sometimes to calves; but never infects animals of a larger size.

Miller says that parsley is a good remedy for the rot in sheep. Perhaps a strong decoction of this plant, or the oil extracted from its seeds, might be of service. Salt is also a useful remedy. It seems to be an acknowledged fact, that salt marshes never produce the rot. Salt indeed is pernicious to most insects. Common salt and water expel worms from the human body; and sea-weed, if laid in a garden, will drive away insects; but if the salt is separated by steeping it in the purest spring-water for a few days, it abounds with animalcules of various species.

Lille, in his book of husbandry, informs us of a farmer who cured his whole flock of the rot by giving each sheep a handful of Spanish salt for five or six mornings successively. The hint was probably taken from the Spaniards, who frequently give their sheep salt to keep them healthy. On some farms perhaps the utmost caution cannot always prevent this disorder. In wet and warm seasons the prudent farmer will remove his sheep from the lands liable to rot. Those who have it not in their power to do this may give each sheep a spoonful of common salt, with the same quantity of flour, in a quarter of a pint of water, once or twice a week. At the commencement of the rot the same remedy given four or five mornings successively will in all probability effect a cure. The addition of the flour and water, it is supposed, not only abates the pungency of the salt, but disposes it to mix with the chyle in a more gentle and efficacious manner.

A farmer of a considerable lordship in Bohemia visiting the hot-wells of Carlsbad, related how he prefer-

red his flocks of sheep from the mortal distemper which raged in the wet year 1760, of which so many perished. His preservative was very simple and very cheap: "He fed them every night, when turned under a shed, cover, or stable, with halved fodder straw; and, by eating it greedily, they all escaped."

"Red water is a disorder most prevalent on wet ²² grounds. I have heard (says Mr Arthur Young) that it has sometimes been cured by tapping, as for a drop sy. This operation is done on one side of the belly towards the flank, just below the wool.

"The *foot-rot* and *hooves*, which is very common on low fenny grounds, is cured by keeping the part clean, and lying at rest in a dry pasture."

The *scab* is a cutaneous disease owing to an impurity of the blood, and is most prevalent in wet lands or in rainy seasons. It is cured by tobacco-water, brimstone, and alum, boiled together, and then rubbed over the sheep. If only partial, tar and grease may be sufficient. But the simplest and most efficacious remedy for this disease was communicated to the Society for the Encouragement of Arts, &c. by Sir Joseph Banks.

"Take one pound of quicksilver, half a pound of Venice turpentine, half a pint of oil of turpentine, and four pounds of hogs lard (C). Let them be rubbed in a mortar till the quicksilver is thoroughly incorporated with the other ingredients; for the proper mode of doing which, it may be proper to take the advice, or even the assistance, of some apothecary or other person used to make such mixtures.

"The method of using the ointment is this: Beginning at the head of the sheep, and proceeding from between the ears along the back to the end of the tail, the wool is to be divided in a furrow till the skin can be touched; and as the furrow is made, the finger slightly dipped in the ointment is to be drawn along the bottom of it, where it will leave a blue stain on the skin and adjoining wool: from this furrow similar ones must be drawn down the shoulders and thighs to the legs, as far as they are woolly; and if the animal is much infected, two more should be drawn along each side parallel to that on the back, and one down each side between the fore and hind legs.

"Immediately after being dressed, it is usual to turn the sheep among other stock, without any fear of the infection being communicated; and there is scarcely an instance of a sheep suffering any injury from the application. In a few days the blotches dry up, the itching ceases, and the animal is completely cured: it is generally, however, thought proper not to delay the operation beyond Michaelmas.

"The *hippobosca ovina*, called in Lincolnshire *sheep fuge*, an animal well known to all shepherds, which lives among the wool, and is hurtful to the thriving of sheep both by the pain its bite occasions and the blood it sucks, is destroyed by this application, and the wool is not at all injured. Our wool-buyers purchase the fleeces on which the stain of the ointment is visible, rather in preference to others, from an opinion that the use of it

(C) By some unaccountable mistake the last ingredient, the four pounds of hogs lard, is omitted in the receipt published in the Transactions of the Society; a circumstance that might be productive of bad effects.—The leaf which contained the receipt has since been cancelled, and a new one printed.

Sheep.

it having perceived the animal to be being vexed either with the scab or fogs, the wool is less liable to the defects of joints or knots; a fault observed to proceed from every sudden stop in the thriving of the animal, either from want of food or from disease.

"This mode of curing was brought into that part of Lincolnshire where my property is situated about 12 years ago, by Mr. Stephen of March, and is now so generally received, that the scab, which used to be the terror of the farmers, and which frequently detested the more careful of them from taking the advantage of putting their sheep in the fertile and extensive commons with which that district abounds, is no longer regarded with any apprehension: by far the most of them have their flock anointed in autumn, when they return from the common, whether they show any symptoms of scab or not; and having done so, conclude them safe for some time from either giving or receiving infection. There are people who employ themselves in the business, and contract to anoint our large sheep at five shillings a score, insuring for that price the success of the operation; that is, agreeing, in case many of the sheep break out afresh, to repeat the operation gratis even some months afterwards."

26
The dunt.

The *dunt* is a dilemper caused by a bladder of water gathering in the head. No cure for this has yet been discovered.

27
Rickets.

The *rickets* is a hereditary disease for which no antidote is known. The first symptom is a kind of light-headedness, which makes the affected sheep appear wilder than usual when the shepherd or any person approaches him. He bounces up suddenly from his laze, and rams to a distance, as though he were pursued by dogs. In the second stage the principal symptom is the sheep's rubbing himself against trees, &c. with such fury as to pull off his wool and tear away his flesh. "The distressed animal has now a violent itching in his skin, the effect of a highly inflamed blood; but it does not appear that there is ever any cutaneous eruption or salutary critical discharge. In short, from all circumstances, the fever appears now to be at its height."—The last stage of this disease "seems only to be the progress of dissolution, after an unfavourable crisis. The poor animal, as condemned by Nature, appears stupid, walks irregularly (whence probably the name *rickets*), generally lies, and eats little: these symptoms increase in degree till death, which follows a general consumption, as appears upon dissection of the carcass; the joints and even solids having suffered a general dissolution.

In order to discover the seat and nature of this disease, sheep that die of it ought to be dissected. This is said to have been done by one gentleman, Mr. Beal; and he found in the brain or membranes adjoining a maggot about a quarter of an inch long, and of a brownish colour. A few experiments might easily determine this fact.

28
Fly struck.

The *fly-struck* is cured by clipping the wool off as far as infected, and rubbing the parts dry with lime or wood-ashes; carriers oil will heal the wounds, and prevent their being struck any more; or they may be cured with care, without clipping, with oil of turpentine, which will kill all the vermin where it goes; but the former is the surest way.

29
Flux.

The *flux* is another disease to which sheep are sub-

ject. The best remedy is said to be, to house the sheep immediately when this dilemper appears, to keep them very warm, and feed them on dry hay, giving them frequent quantities of warm milk and water. The cause of that dilemper is either their feeding on wet lands, or on grass that is become mofsy by the loads having been fed many years without being ploughed. When the farmer perceives his sheep-walks to become mofsy, or to produce bad grass, he should either plough or manure with hot lime, making kians either very near or in the sheep-walks, because the hotter the lime is put on, the swifter the grass comes up, and that early in the year.

Baying, or as it is called in some places the *blag*, attacks sheep when driven into fresh grass or young clover. They overeat themselves, foam at the mouth, swell exceedingly, breathe very quick and short, then jump up, and instantly fall down dead. In this case, the only chance of saving their life is by flabbing them in the jaw with an instrument made for the purpose. The instrument is a hollow tube, with a pointed weapon passing through it. A hole is made with the pointed weapon; which is immediately withdrawn, and the hole is kept open by inserting the tube till the wind is discharged.

Sheep are infested with worms in their nose called *Account of* *afirus oves*, and produced from the egg of a large two-winged fly. The frontal sinuses above the nose in sheep and other animals are the places where these worms live and attain their full growth. These sinuses are always full of a soft white matter, which furnishes these worms with a proper nourishment, and are sufficiently large for their habitation; and when they have here acquired their destined growth, in which they are fit to undergo their changes for the fly-state, they leave their old habitation, and, falling to the earth, bury themselves there; and when these are hatched into flies, the female, when she has been impregnated by the male, knows that the nose of a sheep or other animal is the only place for her to deposit her eggs, in order to their coming to maturity. Mr. Vallinier, to whom the world owes so many discoveries in the insect class, is the first who has given any true account of the origin of these worms. But though their true history had been till that time unknown, the creatures themselves were very early discovered, and many ages since were esteemed great medicines in epilepsies.

The fly produced from this worm has all the time of its life a very lazy disposition, and does not like to make any use either of its legs or wings. Its head and corselet together are about as long as its body, which is composed of five rings, situated on the back; a pale yellow and brown are there disposed in irregular spots; the belly is of the same colours, but they are there more regularly disposed, for the brown here makes three lines, one in the middle, and one on each side, and all the intermediate spaces are yellow. The wings are nearly of the same length with the body, and are a little inclined in their position, so as to lie upon the body; they do not, however, cover it, but a naked space is left between them. The alderous or petty wings which are found under each of the wings are of a whitish colour, and perfectly cover the balancers, so that they are not to be seen without lifting up them.

The fly will live two months after it is first produced.

Sheep.

29
And built.31
Account of
the nose-
worms
which in-
fest sheep.

Sheep
Sheers.

ced, but will take no nourishment of any kind; and possibly it may be of the same nature with the batteries, which never take any food during the whole time of their living in that state. Resumar, *Ind. Inf.* vol. iv. p. 552, &c.

32
Composition
for
marking
sheep.

To find a proper composition for marking sheep is a matter of great importance, as great quantities of wool are every year rendered useless by the pitch and tar with which they are usually marked. The requisite qualities for such a composition are, that it be cheap, that the colour be strong and lasting, so as to bear the changes of weather, and not to injure the wool. Dr Lewis recommends for this purpose melted tallow, with so much charcoal in fine powder stirred into it as is sufficient to make it of a full black colour, and of a thick consistence. This mixture, being applied warm with a marking iron, on pieces of flannel, quickly fixed or hardened, bore moderate rubbing, resisted the sun and rain, and yet could be washed out freely with soap, or ley, or stale urine. In order to render it still more durable, and prevent its being rubbed off, with the tallow may be melted an eighth, sixth, or fourth, of its weight of tar, which will readily wash out along with it from the wool. Lewis's *Com. Phil. Techn.* p. 361.

SHEEP-Stealing. See THEFT.

SHEERING, in the sea-language. When a ship is not steered readily, they say the sheers, or goes sheering; or when, at anchor, the goes in and out by means of the current of the tide, they also say the sheers.

SHEERNESS, a fort in Kent, seated on the point where the river Medway falls into the Thames. It was built by King Charles II. after the insult of the Dutch, who burnt the men of war at Chatham. The buildings belonging to it, in which the officers lodge, make a pretty little neat town; and there is also a yard and a dock, a chapel and a chaplain. Mr Lyons, who sailed with the honourable Captain Phipps in his voyage towards the pole, fixed the longitude of Sheerness to 0.45° E. its latitude $51^{\circ}25'$.

SHEERS, a name given to an engine used to hoist or displace the lower masts of a ship. The sheers employed for this purpose in the royal navy are composed of several long masts, whose heels rest upon the side of the hull, and having their heads declining outward from the perpendicular, so as to hang over the vessel whose masts are to be fixed or displaced. The tackles, which extend from the head of the mast to the sheers-heads, are intended to pull in the latter toward the mast-head, particularly when they are charged with the weight of a mast after it is raised out of any ship, which is performed by strong tackles depending from the sheers-heads. The effort of these tackles is produced by two capsterns, fixed on the deck for this purpose.

In merchant ships this machine is composed of two masts or props, erected in the same vessel wherein the mast is to be planted, or from whence it is to be removed. The lower ends of these props rest on the opposite sides of the deck, and their upper parts are fastened across, so as that a tackle which hangs from the inflexion may be almost perpendicularly above the station of the mast to which the mechanical powers are applied. These sheers are secured by stays which extend forward and aft to the opposite extremities of the vessel.

SHEERS, aboard a ship, an engine used to hoist or displace the lower masts of a ship.

SHEERHEAD. See PLUMBERY.

SHEER, in sea-language, a rope fastened to one or both the lower corners of a sail, to extend and retain it in a particular station. When a ship sails with a lateral wind, the lower corner of the main and fore sail are fastened by a tuck and a sheet; the former being to windward, and the latter to leeward; the tuck, however, is entirely diffused with a stern wind, whereas the sail never treads without the assistance of one or both of the sheets. The stay-fails and studding-fails have only one tuck and one sheet each: the stay-fail tacks are always fastened forward, and the sheet drawn aft; but the studding-fail tuck draws the under clew of the sail to the extremity of the boom, whereas the sheet is employed to extend the innail.

SHEFFIELD, a town in the west riding of Yorkshire, about 162 miles from London, is a large, thriving town on the borders of Derbyshire, with a population of 31,314 souls; has a fine stone bridge over the Don, and another over the Sheaf, and a church built in the reign of Henry I. It had a castle built in the reign of Henry III. in which, or else in the nether-house of the Park, Mary queen of Scots was prisoner 16 or 17 years; but after the death of Charles I. it was with several others, by order of parliament demolished. In 1673 an hospital was erected here, and endowed with 200l. a-year. There is a charity-school for 30 boys, and another for 30 girls. This town has been noted several hundred years for cutlers and smiths manufactures, which were encouraged and advanced by the neighbouring mines of iron, particularly for files, and knives or whittles; for the last of which especially it has been a staple for above 300 years; and it is reputed to excel Birmingham in these wares, as much as it is surpassed by it in locks, hinges, nails, and polished steel. The mill-mills in England for turning grindstones were also set up here. The hoeses look black from the continual smoke of the forges. Here are 600 master cutlers, incorporated by the style of the *Cutlers of Hellamshire* (of which this is reckoned the chief town), who employ no less than 40,000 persons in the iron manufactures; and each of the masters gives a particular stamp to his wares. There is a large market on Tuesday for many commodities, but especially for corn, which is bought up here for the whole west riding, Derbyshire, and Nottinghamshire. It has fairs on Tuesday after Trinity-Sunday, and November 28. In the new market-place, erected by the duke of Norfolk, the stables are built upon a most excellent plan, and strongly inclosed. There are several other new good buildings, such as a large and elegant octagon chapel belonging to the hospital or almshouses; likewise a good assembly room and theatre. We must not omit the large steam-engine, lately finished, for the purpose of polishing and grinding the various sorts of hardware. The parish being very large, as well as populous, Mary I. incorporated 12 of the chief inhabitants, and their successors for ever, by the style of the *Twelve Capital Burgesses of Sheffield*, empowering them to elect and ordain three priests to visit the vicar, who were to be paid out of certain lands and rents which she gave out of the crown; and since this settlement two more chapels have been built in two hamlets of this parish,

Sheer
Head.

rich, which are served by two of the still-lants, while the third, in his turn, helps the vicar in his parish church. James I. founded a free grammar school here, and appointed 13 school-burgesses to manage the revenues, and appoint the master and usher. A new chapel was built lately by the contributions of the people of the town and of the neighbouring nobility and gentry. Water is conveyed by pipes into bachelors' houses, but no one pays but a man's domestic rent for it. In the neighbourhood there are some mines of alum. The ruins of the Roman fortification between this town and Rotherham, which is six miles lower down the river, are still visible; and here also is the famous trench of five miles long, by some called *Devil's* or *Dane's Bank*, and by others *Kemp Bank* and *Temple's bank*. *Went Lett.* 1. 29. N. Lett. 13. 20.

SHELDON, J. A. Duke of Buckinghamshire, an eminent warrior of the 17th and 18th century, of great personal bravery, and an able minister of state, was born about 1652. He lost his father at nine years of age; and his mother marrying Lord Mulgrave, the care of his education was left entirely to a governor, who did not greatly improve him in his studies. Finding that he was deficient in many parts of literature, he resolved to devote a certain number of hours every day to his studies; and thereby improved himself to the degree of learning he afterwards attained. Though possessed of a good estate, he did not abandon himself to pleasure and indolence, but entered a volunteer in the second Dutch war; and accordingly was in that famous naval engagement where the duke of York commanded as admiral: on which occasion his lordship behaved so gallantly, that he was appointed commander of the Royal Catharine. He afterwards made a campaign in the French service under M. de Turenne. As Tangier was in danger of being taken by the Moors, he offered to head the forces which were sent to defend it; and accordingly was appointed to command them. He was then earl of Mulgrave, and one of the lords of the bed-chamber to King Charles II. The Moors retired on the approach of his majesty's forces: and the result of the expedition was the blowing up of Tangier. He continued in several great posts during the short reign of King James II. till that unfortunate prince was dethroned. Lord Mulgrave, though he paid his respects to King William before he was advanced to the throne, yet did not accept of any post in the government till some years after. In the sixth year of William and Mary he was created marquis of Normanby in the county of Lincoln. He was one of the most active and zealous opposers of the bill which took away Sir John Fenwick's life; and exerted the utmost vigour in carrying through the Treason Bill, and the bill for Triennial Parliaments. He enjoyed some considerable posts under King William, and enjoyed much of his favour and confidence. In 1702 he was sworn lord privy-seal; and in the same year was appointed one of the commissioners to treat of an union between England and Scotland. In 1703 he was created duke of Normanby, and soon after duke of Buckinghamshire. In 1711 he was made steward of her majesty's household, and president of the council. During Queen Anne's reign he was but once out of employment; and then he voluntarily resigned, being attached to what were called the *Tory principles*. Her majesty

offered to make him lord chancellor; but he declined the office. He was instrumental in the change of the ministry in 1712. A circumstance that reflects the highest honour on him is, the vigour with which he acted in the case of the unhappy Catala, who afterwards was so indignantly sacrificed. He was married by only one legitimate son (who died at Rome in 1735); but left several natural children. He died in 1727. He was admired by the poets of his age; by Dryden, Prior, and Garth. His *Essay on Poetry* was approved by Addison, and his *Reminiscences* are read with pleasure. His writings were splendidly printed in 1723, in two volumes 4to; and have since been reprinted in 1729, in two volumes 8vo. The first contains his poems on various subjects; the second, his prose works; which consist of historical memoirs, speeches in parliament, characters, dialogues, critical observations, essays, and letters. It may be proper to observe, that the edition of 1729 is corrected; some particulars relating to the revolution in that of 1723 having given offence.

SHEFFIELDIA, a genus of plants belonging to the class of pentandria, and to the order of monocotyledons. The corolla is bell-shaped; the filaments are ten; of which every second is barren. The capsule consists of one cell, which has four valves. There is only one species, the *repens*, a native of New Zealand.

SHEIBON, a district in Africa, lying on the south-east of the kingdom of Dar-Fur, where much gold is found both in dust and in small pieces. The idolatrous natives and savages collect the dust in quills of the ostrich and vulture, and in that condition dispose of it to the merchants. On discovering a large piece of gold, they kill a sheep on it before it is removed. Their marriage is a simple agreement to cohabit. The slaves bought in great numbers from this quarter, are partly prisoners of war among themselves, and partly reduced by treachery, and sold. In times of scarcity, it is said, a father has been known to sell his children.

There are some Mahometans at Sheibon, who wear clothing, and live among the idolaters; but it is not said whether they are Arabs or not.

SHEIK, in the oriental customs, the person who has the care of the mosques in Egypt; his duty is the same as that of the imams at Constantinople. There are more or fewer of these to every mosque, according to its size or revenue. One of these is head over the rest, and answers to a parish-priest with us; and has under him, in large mosques, the readers, and people who cry out to go to prayers; but in small mosques the sheik is obliged to do all this himself. In such it is their business to open the mosque, to cry to prayers, and to begin their short devotions at the head of the congregation, who stand rank and file in great order, and make all their motions together. Every Friday the sheik makes an harangue to his congregation.

SHEIK-BELLET, the name of an officer in the Oriental nations. In Egypt the sheik-bellet is the head of a city, and is appointed by the pacha. The business of this officer is to take care that no innovations be made which may be prejudicial to the Porte, and that they send no orders which may hurt the liberties of the people. But all his authority depends on his credit and interest, not his office: for the government of Egypt is of such a kind, that often the people of the least power

Sheld
17
Sheld

by their polls have the greatest influence: and a caia of the janizaries or Arabs, and sometimes one of their movent officers, an oda-baïha, finds means, by his parts and abilities, to govern all things.

SHEILDS. See **SHEIELDS.**

SHEKEL, the name of a weight and coin current among the ancient Jews. Dr Aibuthnot makes the weight of the shekel equal to 9 pennyweights $2\frac{1}{2}$ grains Troy weight; and the value equal to 2s. $3\frac{1}{2}$ d. Sterling. The golden shekel was worth 1l. 16s. 6d.

SHELDRAKE. See **ANAS, ORNITHOLOGY Index.**

SHELL, among miners, the same with what they otherwise call *soil ground*, or *soil country*; being that part of the internal structure of the earth which they find lying even and in an orderly manner, and evidently retaining its primitive form and situation.

SHELL, in *Natural History*, a hard, and, as it were, stony covering, with which certain animals are defended, and these called *shell fish*. For the classification and history, see **CONCHOLOGY.**

SHELLS, in *Gunnery*, are hollow iron balls to throw out of mortars or howitzers, with a fuse-hole of about an inch diameter, to load them with powder, and to receive the fuse. The bottom, or part opposite to the fuse, is made thicker than the rest, that the fuse may fall uppermost. But in small elevations this does not always happen, nor indeed is it necessary; for, let the shell fall as it will, the fuse sets fire to the powder within, which bursts the shell, and causes great devastation. The shells had much better be of an equal thickness; for then they burst into more pieces.

Message SHELLS, are likewise more than howitz-shells, in the inside of which a letter or other papers are put; the fuse-hole is stopped up with wood or cork, and the shells are fired out of a royal or howitz, either into a garriſon or camp. It is supposed, that the person to whom the letter is sent knows the time, and accordingly appoints a guard to look out for its arrival.

SHELL-Fish. These animals are in general oviparous, very few instances having been found of such as are viviparous. Among the oviparous kinds, anatomists have found that some species are of different sexes, in the different individuals of the same species; but others are hermaphrodites, every one being in itself both male and female. In both cases their increase is very numerous, and scarce inferior to that of plants, or of the most fruitful of the insect class. The eggs are very small, and are hung together in a sort of clusters by means of a glutinous humour, which is always placed about them, and is of the nature of the jelly of frog's spawn. By means of this, they are not only kept together in the parcel, but the whole cluster is fastened to the rocks, shells, or other solid substances; and thus they are preserved from being driven on shore by the waves, and left where they cannot succeed.

SHELL-Gold. See **GOLD.**

SHELTIE, a small but strong kind of horse, so called from Shetland, or Zetland, where they are produced.

SHELVES, in sea-language, a general name given to any dangerous shallows, sand banks, or rocks, lying immediately under the surface of the water, so as to intercept any ship in her passage, and endanger her destruction.

SHENAN. See *Dyeing of LEATHER.*

SHENSTONE, WILLIAM, an admired English poet, the eldest son of a plain country gentleman, who farmed his own estate in Shropshire, was born in November 1714. He learned to read of an old dame, whom his poem of the "School-mistress" has delivered to posterity; and soon received such delight from books, that he was always calling for new entertainments, and expected that, when any of the family went to market, a new book should be brought him, which, when it came, was in fondness carried to bed, and laid by him. It is said, that when his requiel had been neglected, his mother wrapped up a piece of wood of the same form, and pacified him for the night. As he grew older, he went for a while to the grammar-school in Hales Owen, and was placed afterwards with Mr Crumpton, an eminent school-master at Solihull, where he distinguished himself by the quickness of his progress. When he was young (June 1724), he was deprived of his father; and soon after (August 1726) of his grandfather; and was, with his brother, who died afterwards unmarried, left to the care of his grandmother, who managed the estate. From school he was sent, in 1732, to Pembroke college in Oxford, a society which for half a century has been eminent for English poetry and elegant literature. Here it appears that he found delight and advantage; for he continued his name there ten years, though he took no degree. After the first four years he put on the civilian's gown, but without showing any intention to engage in the profession. About the time when he went to Oxford, the death of his grandmother devolved his affairs to the care of the reverend Mr Dolman, of Broms, in Staffordshire, whose attention he always mentioned with gratitude.—At Oxford he applied to English poetry; and, in 1737, published a small Miscellany, without his name. He then for a time wandered about, to acquaint himself with life, and was sometimes at London, sometimes at Bath, or any place of public resort; but he did not forget his poetry. He published, in 1740, his "Judgement of Hercules," addressed to Mr Lyttleton, whose interest he supported with great warmth at an election; this was two years afterwards followed by the "School-mistress." Mr Dolman, to whose care he was indebted for his ease and leisure, died in 1745, and the care of his fortune now fell upon himself. He tried to escape it a while, and lived at his house with his tenants, who were diltantly related; but, finding that imperfect possession inconvenient, he took the whole estate into his own hands, an event which rather improved its beauty than increased its produce. Now began his delight in rural pleasures, and his passion of rural elegance; but in time his expences occasioned clamours that overpowered the lamb's bleat and the linnets' song, and his groves were haunted by beings very different from fauns and fairies. He spent his estate in adorning it, and his death was probably hastened by his anxieties. He was a lamp that spent its oil in blazing. It is said, that if he had lived a little longer, he would have been assisted by a pension; such bounty could not have been more properly bestowed, but that it was ever asked is not certain; it is too certain that it never was enjoyed.—He died at the Leafowes, of a putrid fever, about five on Friday morning, Feb. 11. 1763; and was buried by the side of his brother, in the churchyard of Hales-Owen.

Shenstone In his private opinions, our author adhered to no particular sect, and hated all religious disputes. Tendernefs, in every sense of the word, was his peculiar characteristic; and his friends, domestics, and poor neighbours, daily experienced the effects of his benevolence. This virtue he carried to an excess that seemed to border upon weakness; yet if any of his friends treated him ungenerously, he was not easily reconciled. On such occasions, however, he used to say, "I never will be a revengeful enemy; but I cannot, it is not in my nature, to be half a friend." He was no economist; for the generosity of his temper prevented his paying a proper regard to the use of money: he exceeded therefore the bounds of his paternal fortune. But, if we consider the perfect paradise into which he had converted his estate, the hospitality with which he lived, his charities to the indigent, and all out of an estate that did not exceed 2000*l.* a-year, one should rather wonder that he left any thing behind him, than blame his want of economy: he yet left more than sufficient to pay all his debts, and by his will appropriated his whole estate to that purpose. Though he had a high opinion of many of the fair sex, he forbore to marry. A passion he entertained in his youth was with difficulty surmounted. The lady was the subject of that admirable pastoral, in four parts, which has been so universally read and admired, and which, one would have thought, must have softened the proudest and most obdurate heart. His works have been published by Mr Doddley, in 3 vols 8vo. The first volume contains his poetical works, which are particularly distinguished by an amiable elegance and beautiful simplicity; the second volume contains his prose works; the third his letters, &c. *Eng. Dict.*

SHEPPEY, an island at the mouth of the river Medway, about 20 miles in circumference. It is separated from the main land by a narrow channel; and has a fertile soil, which feeds great flocks of sheep. The borough town of Queenborough is seated thereon; besides which it has several villages.

SHERARDIA, a genus of plants belonging to the tetrandria class, and in the natural method ranking under the 47th order, *Stellatae*. See *BOTANY Index*.

SHERBET, or **SHERBIT**, a compound drink, first brought into England from Turkey and Persia, consisting of water, lemon-juice, and sugar, in which are dissolved perfumed cakes made of excellent Damascus fruit, containing an infusion of some drops of rose water. Another kind of it is made of violets, honey, juice of raisins, &c.

SHERIDAN, THOMAS, D. D. the intimate friend of Dean Swift, is said by Shield, in Cibber's "Lives of the Poets," to have been born about 1684, in the county of Cavan, where, according to the same authority, his parents lived in no very elevated state. They are described as being unable to afford their son the advantages of a liberal education; but he, being observed to give early indications of genius, attracted the notice of a friend to his family, who sent him to the college of Dublin, and contributed towards his support while he remained there. He afterwards entered into orders, and set up a school in Dublin, which long maintained a very high degree of reputation, as well for the attention bestowed on the morals of the scholars as for their proficiency in literature. So great was the estimation in

which this feminary was held, that it is asserted to have produced in some years the sum of 1200*l.* It does not appear that he had any considerable preferment; but his intimacy with Swift, in 1725, procured for him a living in the south of Ireland worth about 150*l.* a-year, which he went to take possession of, and, by an act of inadvertence, destroyed all his future expectations of rising in the church; for being at Cork on the 1st of August, the anniversary of King George's birthday, he preached a sermon, which had for its text, "Sufficient for the day is the evil thereof." On this being known, he was struck out of the list of chaplains to the lord lieutenant, and forbidden the castle.

This living Dr Sheridan afterwards changed for that of Dunboyne, which, by the liberality of the farmers, and power of the gentlemen in the neighbourhood, fell to low as 8*l.* per annum. He gave it up for the free school of Cavan, where he might have lived well in so cheap a country on 2*l.* a-year salary, besides his scholars; but the air being, as he said, too moist and unwholesome, and being disgusted with some persons who lived there, he sold the school for about 200*l.*; and having soon spent the money, he fell into bad health, and died Sept. 10. 1738, in his 54th year.

Lord Corke has given the following character of him. "Dr Sheridan was a school-master, and in many instances perfectly well adapted for that station. He was deeply versed in the Greek and Roman languages, and in their customs and antiquities. He had that kind of good nature which absence of mind, indolence of body, and carelessness of fortune, produce; and although not over strict in his own conduct, yet he took care of the morality of his scholars, whom he sent to the university remarkably well founded in all kinds of classical learning, and not ill instructed in the social duties of life. He was slovenly, indigent, and cheerful. He knew books much better than men; and he knew the value of money least of all. In this situation, and with this disposition, Swift fastened upon him as upon a prey with which he intended to regale himself whenever his appetite should prompt him." His Lordship then mentions the event of the unlucky sermon, and adds: "This ill-starred, good-natured, improvident man, returned to Dublin, unbegging from all favour at court, and even banished from the castle. But still he remained a punster, a quibbler, a fiddler, and a wit. Not a day passed without a rebus, an anagram, or a madrigal. His pen and his fiddlestick were in continual motion; and yet to little or no purpose, if we may give credit to the following verses, which shall serve as the conclusion of his poetical character:

- "With music and poetry equally blest'd,
 "A bard thus Apollo most humbly address'd;
 "Great author of poetry, music, and light,
 "Instructed by thee, I both fiddle and write;
 "Yet unheeded I serape, or I scribble all day,
 "My tunes are neglected, my verse flung away.
 "Thy substitute here, Vice-Apollo diffams
 "To vouch for my numbers, or list to my strains.
 "Thy manual sign he refuses to put
 "To the airs I produce from the pen or the gut:
 "Be thou then propitious, great Ptolebus, and grant
 "Relief, or reward, to my merit or want.

She. Sher.
She. ff.

"Tho' the Dean and Delany transcendently shine,
"O! brighten one solo or sonnet of mine :
"Make one work immortal, 'tis all I request.
"Apollo look'd pleas'd, and resolving to jet,
"Replied—Homel friend, I've consider'd your case,
"Nor dislike your unmeaning and innocent face.
"Your petition I grant, the boon is not great,
"Your works shall continue, and here's the receipt :
"On roudens hereafter your fiddle-strings spend,
"Write verses in circles, they never shall end."

"One of the volumes of Swift's miscellanies consists almost entirely of letters between him and the Dean. He published a prose translation of Perius; to which he added the best notes of former editors, together with many judicious ones of his own. This work was printed at London, 1739, in 12mo. *Biog. Diet.*

SHERIDAN, *Mrs Frances*, wife to Thomas Sheridan, M. A. was born in Ireland about the year 1724, but descended from a good English family which had removed thither. Her maiden name was Chamberlaine, and she was grand daughter of Sir Oliver Chamberlaine. The first literary performance by which she distinguished herself was a little pamphlet at the time of a violent party dispute relative to the theatre, in which Mr Sheridan had newly embarked his fortune. So well-timed a work exciting the attention of Mr Sheridan, he by an accident discovered his fair patroness, to whom he was soon afterwards married. She was a person of the most amiable character in every relation of life, with the most engaging manners. After lingering some years in a very weak state of health, she died at Blois, in the fourth of France, in the year 1767. Her "Sydney Biddulph" may be ranked with the first productions of that class in ours or in any other language. She also wrote a little romance in one volume called *Nourjahad*, in which there is a great deal of imagination productive of an admirable moral. And she was the authoress of two comedies, "The Discovery" and "The Dupe."

SHERIFF, an officer, in each county in England, nominated by the king, invested with a judicial and ministerial power, and who takes place of every nobleman in the county during the time of his office.

The sheriff is an officer of very great antiquity in this kingdom, his name being derived from two Saxon words, signifying the *reeve*, *latiff*, or *officer* of the shire. He is called in Latin *the comes*, as being the deputy of the earl or *comes*, to whom the custody of the shire is said to have been committed at the first division of this kingdom into counties. But the earls, in process of time, by reason of their high employments and attendance on the king's person, not being able to transact the business of the county, were delivered of that burden; referring to themselves the honour, but the labour was laid on the sheriff. So that now the sheriff does all the king's business in the county; and though he be still called *the comes*, yet he is entirely independent of, and not subject to, the earl; the king, by his letters patent, appointing *quosdam comes* to the shire, and to him alone.

Sheriffs were formerly chosen by the inhabitants of the several counties. In confirmation of which it was ordained, by statute 28 Edw. I. c. 8. that the people should have an election of sheriffs in every shire where the shire is not of franchise. For anciently in some

counties the sheriffs were hereditary; as we apprehend they were in Scotland till the statute 22 Geo. II. c. 33; and still continue in the county of Westmorland to this day; the city of London having also the inheritance of the shirealty of Middlesex veiled in their body by charter. The reason of these popular elections is assigned in the same statute, c. 13. "that the commons might chosse such as would not be a burden to them." And herein appears plainly a strong trace of the democratical part of our constitution; in which form of government it is an indispensable requisite, that the people should chosse their own magistrates. This election was in all probability not absolutely veiled in the commons, but required the royal approbation. For in the Gothic constitution, the judges of their county courts (which office is executed by the sheriff) were elected by the people, but confirmed by the king; and the form of their election was thus managed; the people, or *meete territorii*, chose twelve electors, and they nominated three persons, *ex quibus rex unum confirmabat*. But, with us in England, these popular elections, growing tumultuous, were put an end to by the statute 9. Edw. II. ff. 2. which enacted, that the sheriffs should from thenceforth be assigned by the chancellor, treasurer, and the judges; as being persons in whom the same trust might with confidence be reposed. By statutes 14. Edw. III. c. 7. 23 Hen. VI. c. 8. and 21 Hen. VIII. c. 20. the chancellor, treasurer, president of the king's council, chief justices, and chief barons, are to make this election; and that on the morrow of All Souls, in the exchequer. And the king's letters patent, appointing the new sheriffs, used commonly to bear date the sixth day of November. The statute of Cambridge, 12 Ric. II. c. 2. ordains, that the chancellor, treasurer, keeper of the privy seal, steward of the king's house, the king's chamberlain, clerk of the rolls, the justices of the one bench and the other, barons of the exchequer, and all other that shall be called to ordain, name, or make justices of the peace, sheriffs, and other officers of the king, shall be sworn to act indifferently, and to name no man that such to be put in office, but such only as they shall judge to be the best and most sufficient. And the custom now is (and has been at least ever since the time of Fortescue, who was chief justice and chancellor to Henry the sixth), that all the judges, together with the other great officers, meet in the exchequer chamber on the morrow of All Souls yearly, (which day is now altered to the morrow of St Martin, by the lit. act for abbreviating Michaelmas term), and then and there propose three persons to the king, who afterwards appoints one of them to be sheriff. This custom of the twelve judges proposing three persons seems borrowed from the Gothic constitution before mentioned; with this difference, that among the Goths the 12 nominors were first elected by the people themselves. And this usage of ours, at its first introduction, there is reason to believe, was founded upon some statute, though not now to be found among our printed laws; first, because it is materially different from the direction of all the statutes before-mentioned; which it is hard to conceive that the judges would have countenanced by their concurrence, or that Fortescue would have inferred in his book, unless by the authority of some statute; and next, because a statute is expressly referred to in the record, which Sir Edward Coke

Sheriff.

28 Edw. I. c. 8.
23 Hen. VI. c. 8.
9 Edw. II. ff. 2.

Sheriff tells us he transferred from the council book of 31 March, 24 Hen. VI. and which is in substance as follows. The king had of his own authority appointed a man sheriff of Lincolnshire, which office he refused to take upon him; whereupon the opinions of the judges were taken, what should be done in this behalf. And the two chief justices, Sir John Fortescue and Sir John Priour, delivered the unanimous opinion of them all; "that the king did an error when he made a person sheriff that was not chosen and presented to him according to the statute; that the person refusing was liable to no fine for disobedience, as if he had been one of the three persons chosen according to the tenor of the statute; that they would advise the king to have recourse to the three persons that were chosen according to the statute, or that some other thirly man be intrusted to occupy the office for this year; and that, the next year, to eschew such inconveniences, the order of the statute in this behalf made be observed." But, notwithstanding this unanimous resolution of all the judges of England, thus entered in the council-book, and the statute 34 and 35 Hen. VIII. c. 26. § 61. which expressly recognizes this to be the law of the land, some of our writers have affirmed, that the king, by his prerogative, may name whom he pleases to be sheriff, whether chosen by the judges or not. This is grounded on a very particular case in the fifth year of Queen Elizabeth, when, by reason of the plague, there was no Michaelmas term kept at Westminster; so that the judges could not meet there in *capite animarum* to nominate the sheriff: whereupon the queen named them herself, without such previous assembly, appointing for the most part one of two remaining in the last year's list. And this case, thus circumstanced, is the only authority in our books for the making these extraordinary sheriffs. It is true, the reporter adds, that it was held that the queen by her prerogative might make a sheriff without the election of the judges, *non obstante aliquo statuto in contrarium*; but the doctrine of *non obstante*, which less the prerogative above the laws, was effectually demolished by the bill of rights at the revolution, and abdicating Westminster-hall when King James abdicated the kingdom. However, it must be acknowledged, that the practice of occasionally naming what are called *procer-sheriffs*, by the authority of the crown, hath uniformly continued to the reign of his present majesty; in which, it is believed, few (if any) instances have occurred.

Sheriffs, by virtue of several old statutes, are to continue in their office no longer than one year; and yet it hath been said that a sheriff may be appointed *durante bene placito*, or during the king's pleasure; and so is the form of the royal writ. Therefore, till a new sheriff be named, his office cannot be determined, unless by his own death, or the demise of the king; in which last case it was usual for the successor to find a new writ to the old sheriff; but now, by statute 1 Anne c. 1. s. 8. all officers appointed by the present king may hold their offices for six months after the king's demise, unless sooner displaced by the successor. We may farther observe, that by statute 1 R. II. c. 12. no man that has served the office of sheriff for one year can be compelled to serve the same again within three years after.

We shall find it is of the utmost importance to have

the sheriff appointed according to law, when we consider his power and duty. There are either two judges, as the keeper of the king's peace, as a ministerial officer of the superior courts of justice, or as the king's bailiff.

In his judicial capacity he is to hear and determine all causes of 40 shillings value and under, in his county-court; and he has also a judicial power in divers other civil cases. He is likewise to decide the elections of knights of the shire, (subject to the controul of the House of Commons), of coroners, and of verderers; to judge of the qualification of voters, and to return such a he shall determine to be duly elected.

As the keeper of the king's peace, both by common law and special commission, he is the first man in the county, and superior in rank to any noblemen therein, during his office. He may apprehend, and commit to prison, all persons who break the peace, or attempt to break it; and may bind any one in a recognizance to keep the king's peace. He may, and is bound, *ex officio*, to pursue and take all traitors, murderers, felons, and other offenders, and commit them to gaol for safe custody. He is to defend his county against any of the king's enemies when they come into the land; and for this purpose, as well as for keeping the peace and pursuing felons, he may command all the parishes of his county to attend him; which is called the *pye-committment*, or power of the county; which summons, every person above 15 years old, and under the degree of a peer, is bound to attend upon warning, under pain of fine and imprisonment. Mac though the sheriff is thus the principal conservator of the peace in his county, yet, by the express directions of the great charter, he, together with the constable, coroner, and certain other officers of the king, are forbidden to hold any pleas of the crown, or, in other words, to try any criminal offence. For it would be highly unbecoming, that the executors of justice should be also the judges; should impose, as well as levy, fines and amercements; should one day condemn a man to death, and personally execute him the next. Neither may he act as an ordinary judge of the peace during the time of his office; for this would be equally inconsistent, he being in many respects the servant of the justices.

In his ministerial capacity, the sheriff is bound to execute all process issuing from the king's courts of justice. In the commencement of civil causes, he is to serve the writ, to arrest, and to take bail; when the cause comes to trial, he must summon and return the jury; when it is determined, he must see the judgment of the court carried into execution. In criminal matters, he also arrests and imprisons, he returns the jury, he has the custody of the delinquent, and he executes the sentence of the court, though it extend to death itself.

As the king's bailiff, it is his business to preserve the rights of the king within his bailiwick; for so his county is frequently called in the writs, a word introduced by the princes of the Norman line; in imitation of the French, whose territory is divided into bailiwicks, as that of England into counties. He must see to the King's ale and bread, devolved to the crown by the charter of Henry II. he levies all fines and forfeitures, and keeps and keeps all wails, or castles, towers, and the like, unless they

Sheriff,
Sheriff.

Sherlock,
Sheriff.

they be granted to some subject; and must also collect the king's rents within his bailiwick, if commanded by process from the exchequer.

To execute these various offices, the sheriff has under him many inferior officers; an under-sheriff, bailiffs, and gaolers, who must neither buy, sell, nor farm their offices, on forfeiture of 500*l*.

The under-sheriff usually performs all the duties of the office; a very few only excepted, where the personal presence of the high sheriff is necessary. But no under-sheriff shall abide in his office above one year; and if he does, by statute 23 Hen. VI. c. 8, he forfeits 20*l*. a very large penalty in those early days. And no under-sheriff or sheriff's officer shall practise as an attorney during the time he continues in such office: for this would be a great inlet to partiality and oppression. But these salutary regulations are shamefully evaded, by practising in the names of other attorneys, and putting in them deputies by way of nominal under-sheriffs: by reason of which, says Dr Iton, the under-sheriffs and bailiffs do grow so cunning in their several places, that they are able to deceive, and it may well be feared that many of them do deceive, both the king, the high sheriff, and the county.

SHERIFF, in Scotland. See LAW, Part iii. sect. 3.

SHERLOCK, WILLIAM, a learned English divine in the 17th century, was born in 1641, and educated at Eton school, where he distinguished himself by the vigour of his genius and his application to study. Thence he was removed to Cambridge, where he took his degrees. In 1669 he became rector of the parish of St George, Botolph-lane, in London; and in 1681 was collected to the prebend of Pancras, in the cathedral of St Paul's. He was likewise chosen master of the Temple, and had the rectory of Therfield in Hertfordshire. After the Revolution he was suspended from his preferment, for refusing the oaths to King William and Queen Mary; but at last he took them, and publicly justified what he had done. In 1691 he was installed dean of St Paul's. His Vindication of the Doctrine of the Trinity engaged him in a warm controversy with Dr South and others. Bishop Burnet tells us, he was "a clear, a polite, and a strong writer; but apt to assume too much to himself, and to treat his adversaries with contempt." He died in 1727. His works are very numerous; among these are, 1. A Discourse concerning the Knowledge of Jesus Christ, against Dr Owen. 2. Several pieces against the Papists, the Socinians, and Dissenters. 3. A practical Treatise on Death, which is much admired. 4. A practical Discourse on Providence. 5. A practical Discourse on the Future Judgment; and many other works.

SHERLOCK, Dr Thomas, bishop of London, was the son of the preceding Dr William Sherlock, and was born in 1678. He was educated in Catharine hall, Cambridge, where he took his degrees, and of which he became master: he was made master of the Temple very young, on the resignation of his father; and it is remarkable, that this mastership was held by father and son successively for more than 70 years. He was at the head of the opposition against Dr Hoadley bishop of Bangor; during which contest he published a great number of pieces. He attacked the famous Collins's "Grounds and Reasons of the Christian Religion," in

a course of six sermons, preached at the Temple church, which he intitled "The Use and Intent of Prophecy in the several Ages of the World." In 1728, Dr Sherlock was promoted to the bishopric of Bangor; and was translated to Salisbury in 1734. In 1747 he refused the archbishopric of Canterbury, on account of his ill state of health; but recovering in a good degree, accepted the see of London the following year. On occasion of the earthquakes in 1750, he published an excellent Pastoral Letter to the clergy and inhabitants of London and Westminster: of which it is said there were printed in 4to, 5000; in 8vo, 20,000; and in 12mo, about 30,000; beside pirated editions, of which not less than 50,000 were supposed to have been sold. Under the weak state of body in which he lay for several years, he revised and published 4 vols of Sermons in 8vo, which are particularly admired for their ingenuity and elegance. He died in 1762, and by report worth 150,000*l*. "His learning," says Dr Nicholls, "was very extensive: God had given him a great and an understanding mind, a quick comprehension, and a solid judgment. These advantages of nature he improved by much industry and application. His skill in the civil and canon law was very considerable; to which he had added such a knowledge of the common law of England as few clergymen attain to. This it was that gave him that influence in all causes where the church was concerned; as knowing precisely what it had to claim from its constitutions and canons, and what from the common law of the land." Dr Nicholls then mentions his constant and exemplary piety, his warm and fervent zeal in preaching the duties and maintaining the doctrines of Christianity, and his large and diffusive munificence and charity; particularly by his having given large sums of money to the corporation of clergymen's sons, to several of the hospitals, and to the society for propagating the gospel in foreign parts: also his bequeathing to Catharine hall in Cambridge, the place of his education, his valuable library of books, and his donations for the founding a librarian's place and a scholarship, to the amount of several thousand pounds.

SHERRIFFE of Mecca, the title of the descendants of Mahomet by Hassan Ibn Ali. These are divided into several branches, of which the family of Ali Bunemi, consisting at least of three hundred individuals, enjoy the sole right to the throne of Mecca. The Ali Bunemi are, again, subdivided into two subordinate branches, Darri Sajid, and Darri Barkad; of whom sometimes the one, sometimes the other, have given sovereigns to Mecca and Medina, when these were separate states.

Not only is the Turkish sultan indifferent about the order of succession in this family, but he seems even to foment the dissensions which arise among them, and favours the strongest, merely that he may weaken them all. As the order of succession is not determinately fixed, and the sheriffs may all aspire alike to the sovereign power, this uncertainty of right, aided by the intrigues of the Turkish officers, occasions frequent revolutions. The grand sherriffe is seldom able to maintain himself on the throne; and it still seldom happens that his reign is not disturbed by the revolt of his nearest relations. There have been instances of a nephew succeeding his uncle, an uncle succeeding his nephew; and

Sheriff. and sometimes of a person, from a remote branch, coming in the room of the reigning prince of the ancient house.

When Niebuhr was in Arabia, in 1763, the reigning Sheriff Mehad had sitten fourteen years on the throne, and, during all that period, had been continually at war with the neighbouring Arabs, and with his own nearest relations sometimes. A few years before, the pasha of Syria had deposed him, and raised his younger brother to the sovereign dignity in his stead. But after the departure of the caravan, Jafar, the new sheriff, not being able to maintain himself on the throne, was obliged to resign the sovereignty again to Mehad. Ahmet, the second brother of the sheriff, who was much beloved by the Arabs, threatened to attack Mecca while Niebuhr was at Jidda. Our traveller was soon after informed of the termination of the quarrel, and of Ahmet's return to Mecca, where he continued to live peacefully in a private character.

These examples show that the Mussulmans observe not the law which forbids them to bear arms against their holy places. An Egyptian bey even profaned, a few years since, to plant some small cannons within the compass of the Kaaba, upon a small tower, from which he fired over that sacred mansion, upon the palace of Sheriff Mehad, with whom he was at variance.

The dominions of the sheriff, comprehend the cities of Mecca, Medina, Jambou, Taaf, Sa'ie, Ghunfede, Haif, and thirteen others less considerable, all situated in Hedjas. Near Taaf is the lofty mountain of Gazvan, which according to Arabian authors, is covered with snow in the midst of summer. As these dominions are neither opulent nor extensive, the revenue of their sovereign cannot be considerable.

He finds a rich resource, however, in the imposts levied on pilgrims, and in the gratuities offered him by Mussulman monarchs. Every pilgrim pays a tax of from ten to an hundred crowns, in proportion to his ability. The Great Mogul remits annually sixty thousand roupes to the sheriff, by an assignment upon the government of Surat. Indeed, since the English made themselves masters of this city, and the territory belonging to it, the nabob of Surat has no longer been able to pay the sum. The sheriff once demanded it of the English, as the possessors of Surat; and, till they should satisfy him, forbade their captains to leave the port of Jidda. But the English disregarding this prohibition, the sheriff complained to the Ottoman Porte, and they communicated his complaints to the English ambassador. He at the same time opened a negotiation with the nominal nabob, who resides in Surat. But all these steps proved fruitless: and the sovereign of Mecca seems not likely to be ever more benefited by the contribution from India.

The power of the sheriff extends not to spiritual

matters; these are entirely managed by the heads of the clergy, of different sects, who are resident at Mecca. Rigid Mussulmans, such as the Turks, are not very favourable in their sentiments of the sheriff, but suspect their orthodoxy, and look upon them as secretly attached to the tolerant sect of the Zaidi.

Sheriff.
Shetland.

SHEFLAND, the name of certain islands belonging to Scotland, and lying to the northward of Orkney. There are many convincing proofs that these islands were very early inhabited by the Picts, or rather by those nations who were the original possessors of the Orkneys; and at the time of the total destruction of these nations, if any credit be due to tradition, their woods were entirely ruined (A). It is highly probable that the people in Shetland, as well as in the Orkneys, flourished under their own princes dependent upon the crown of Norway; yet this seems to have been rather through what they acquired by fishing and commerce, than by the cultivation of their lands. It may also be reasonably presumed, that they grew thinner of inhabitants after they were annexed to the crown of Scotland; and it is likely that they revived again, chiefly by the very great and extensive improvements which the Dutch made in the herring fishery upon their coasts, and the trade that the crews of their boats, then very numerous, carried on with the inhabitants, necessarily resulting from their want of provisions and other conveniences.

There are many reasons which may be assigned why these islands, though part of our dominions, have not hitherto been better known to us. They were commonly placed two degrees too far to the north in all the old maps, in order to make them agree with Ptolemy's description of Thule, which he asserted to be in the latitude of 63 degrees; which we find urged by Camden as a reason why Thule must be one of the Shetland Isles, to which Speed also agrees, though from their being thus wrong placed he could not find room for them in his maps. Another, and that no light cause, was the many false, fabulous, and impertinent relations published concerning them (B), as if they were countries inhospitable and uninhabitable; and lastly, the indolence, or rather indifference, of the natives, who, contenting themselves with those necessaries and conveniences procured by their intercourse with other nations, and conceiving themselves neglected by the mother country, have seldom troubled her with their applications.

There are few countries that have gone by more names than these islands; they were called in Icelandic, *Haitlandia*, from *hait*, the "hilt of a sword;" this might be possibly corrupted into *Heiland*, *Ililand*, or *Hethland*, though some tell us this signifies a "high land." They have been likewise, and are still in some maps, called *Zetland* and *Zeland*, in reference, as has been supposed, to their situation. By the Danes, and by

(A) The tradition is, that this was done by the Scots when they destroyed the Picts; but is more probably referred to the Norwegians rooting out the original possessors of Shetland.

(B) They represented the climate as intensely cold; the soil as composed of crags and quagmire, so barren as to be incapable of bearing corn; to supply which, the people, after drying fish-bones, powdered them, then kneaded and baked them for bread. The larger fish-bones were said to be all the fuel they had. Yet, in so dreary a country, and in such miserable circumstances, they were acknowledged to be very long-lived, cheerful, and contented.

by the natives, they are styled *Ushaland*; and notwithstanding the oddness of the orthography, this differs very little, if at all, from their manner of pronouncing Zealand, out of which pronunciation grew the modern names of *Sheland* and *Sotland*.

The islands of *Sheland*, as we commonly call them, are well situated for trade. The nearest continent to them is Norway; the port of Bergen lying 44 leagues east, whereas they lie 46 leagues north-north-east from E. hannels; east-north-east from Sanda, one of the Oskneys, about 16 or 18 leagues; six or seven leagues north-east from Fair Isle; 28 leagues east from the Ferroe isles; and at nearly the same distance north-east from Lewis. The southern promontory of the Mainland, called *Sumbourgh Head*, lies in 59 degrees and 59 minutes of north latitude; and the northern extremity of Unil, the most remote of them all, in the latitude of 61 degrees 15 minutes. The meridian of London passes through this last island, which lies about 2 degrees 55 minutes west from Paris, and about 5 degrees 15 minutes east from the meridian of Cape Lizard. According to Giffard's Historical Description of Zealand, the inhabited islands are 23, of which the principal is styled *Lanulem*, and extends in length from north to south about 65 miles, and is in some places 20 broad, though in others not more than two.

It is impossible to speak with precision; but, according to the best computation which we have been able to form, the 5 island isles contain near three times as much land as the Oskneys; and they are considered as not inferior to the provinces of Utrecht, Zealand, and all the rest of the Dutch islands taken together; but of climate and soil they have not much to boast. The longest day in the island of Unil is 19 hours 15 minutes, and of consequence the shortest day 4 hours and 45 minutes. The spring is very late, the summer very short; the autumn also is of no long duration, dark, foggy, and rainy; the winter sets in about November, and lasts till April, and sometimes till May. They have frequently in that season storms of thunder, much rain, but little frost or snow. High winds are indeed very frequent and very troublesome, yet they seldom produce any terrible effects. The aurora borealis is as common here as in any of the northern countries. In the winter season the sea swells and rages in such a manner, that for five or six months their ports are inaccessible, and of course the people during that space have no correspondence with the rest of the world.

The soil in the interior part of the Mainland, for the most part, is mountainous, moorish, and boggy, yet not to such a degree as to render the country utterly impassable; for many of the roads here, and in some of the northern isles, are as good as any other natural roads, and the people travel there frequently on all occasions. Near the coast there are sometimes for miles together flat pleasant spots, very fertile both in pasture and corn. The mountains produce large crops of very nutritive grass in the summer; and they cut considerable quantities of hay, with which they feed their cattle in the winter. They might with a little attention bring more of their country into cultivation; but the people are so much addicted to their fishery, and feel so little necessity of having recourse to this method for subsistence, that they are content, how strange soever that may seem to

us, to let four parts in five of their land remain in a state of nature.

They want not considerable quantities of man in different islands, though they use but little; hitherto there has been no chalk found; limestone and freestone there are in the southern parts of the Mainland in great quantities, and also in the neighbouring islands, particularly Fetlar; and considerable quantities of slate, very good in its kind. No mines have been hitherto wrought to any great extent; but there are in many places appearances of metallic ores, as those of copper and iron; and it is said, pieces of silver ore have been found. In some of the smaller isles there are strong appearances of iron; but, though the want of proper experiments being made, there is, in this respect at least, hitherto nothing certain. Their meadows are inclosed with dikes, and produce very good grass. The little corn they grow is chiefly barley, with some oats; though even in the northern extremity of Unil the little land which they have is remarkable for its fertility. The hills abound with medicinal herbs; and their kitchen-gardens thrive as well, and produce as good greens and roots, as any in Britain. Of late years, and since this has been attended to, some gentlemen have had even greater success than they expected in the cultivating of tulips, roses, and many other flowers. They have no trees, and hardly any shrubs except juniper, yet they have a tradition that their country was formerly overgrown with woods; and it seems to be a confirmation of this, that the roots of timber-trees have been, and are still, dug up at a great depth; and that in some, and those too inaccessible, places, the mountain-ash is still found growing wild. That this defect, viz. the want of wood at present, does not arise entirely from the soil or climate, appears from several late experiments; some gentlemen having raised ash, maple, horse-chestnuts, &c. in their gardens. Though the inhabitants are without either wood or coals, they are very well supplied with fuel, having great plenty of heath and peat. The black cattle in this country are in general of a larger sort than in Oskney, which is owing to their having more extensive pastures; a clear proof that still further improvements might be made in respect to size. Their horses are small, but strong, stout, and well-shaped, live very hardy, and to a great age. They have likewise a breed of small swine, the flesh of which, when fat, is esteemed very delicious. They have no goats, hares, or foxes; and in general no wild or venomous creatures of any kind except rats in some few islands. They have no moor-fowl, which is the more remarkable, as there are everywhere immense quantities of heath; but there are many fowls of wild and water-fowl, particularly the dunter-goose, cack-goose, solen-goose, swans, ducks, teal, whips, foils, lynes, kittiwakes, maws, plovers, cormorants, &c. There is likewise the ember-goose, which is said to hatch her egg under her wing. Eagles and hawks, as also ravens, crows, mevs, &c. abound here.

All these islands are well watered; for there are everywhere excellent springs, some of them mineral and medicinal. They have indeed no rivers; but many pleasant rills or rivulets, of different sizes; in some of the largest they have admirable trouts, some of which are of 15 and even of 20 pounds weight. They have likewise

Shetland. Likewise many fresh-water lakes, well stored with trout and eels, and in most of them there are also large and fine flounders; in some very excellent eel. These fresh-water lakes, if the country was better peopled, and the common people more at their ease, are certainly capable of great improvements. The sea-coasts of the Mainland of Shetland, in a straight line, are 55 leagues; and therefore there cannot be a country conceived more proper for establishing an extensive fishery. What the inhabitants have been hitherto able to do, their natural advantages considered, does not deserve that name, notwithstanding they export large quantities of eel, tusk, ling, and skate, inasmuch that the bounty allowed by acts of parliament amounts from 1400l. to 2000l. annually. They have, besides, halibouts, whiting, turbot, and a variety of other fish. In many of the inlets there are prodigious quantities of excellent oysters, lobsters, mussels, cockles, and other shell-fish. As to amphibious creatures, they have multitudes of otters and seals; add to these, that amber, ambergris, and other spoils of the ocean, are sometimes found upon the coasts.

The inhabitants are a stout, well-made, comely people; the lower sort of a swarthy complexion. The gentry are allowed, by all who have conversed with them, to be most of them polite, shrewd, sensible, lively, active, and intelligent persons; and thick, to the number of 100 families, have very handsome, strong, well-built houses, neatly furnished; their tables well served; polished in their manners, and exceedingly hospitable and civil to strangers. Those of an inferior rank are a hardy, robust, and laborious people, who, generally speaking, get their bread by fishing in all weathers in their youth, which are little bigger than Graveland wherries; live hardily, and in the summer season mainly on fish; their drink, which, in reference to the British dominions, is peculiar to the country, is called *bladd*, and is a sort of butter-milk, long kept, and very sour. Many live to great ages, though not so long as in former times. In respect, however, to the bulk of the inhabitants, from the poornefs of living, from the nature of it, and from the drinking great quantities of corn-spirits of the very worst sort, multitudes are afflicted with an inveterate fever; from which those in better circumstances are entirely free, and enjoy as good health as in any other country in Europe. As they have no great turn to agriculture, and are persuaded that their country is not fit for it, they do not (though probably they might) raise corn enough to support them for more than two-thirds of the year. But they are much more successful in their produce-grounds, which are kept well inclosed, in good order, and, together with their commons, supply them plentifully with beef and mutton. They pay their rents generally in butter at Lannas, and in money at Mortinass. As to manufactures, they make a strong combed cloth for their own use, as also linen. They make the use of their own wool very fine looking. They also rear, besides the different kinds of fish already mentioned, some hens, geese, a considerable quantity of butter and tallow, and a few sheep, and no inconsiderable quantity of the best of which is just mentioned. Their chief trade is to Linn, Lerwick, Humbergh, Souda, and to the Orkneys. They import timber, dials, and furniture of their best oak, from Norway; and flour from the Orkneys, and from North B-

tain; fish, and some other things from Humbergh; dials and latter sort of linen from Leids, gracely, household furniture, and other necessaries, from London. The reparitor-duties to the earl of Morton are generally let in farm; and are paid by the people in butter, oil, and money. The remains of the old Norwegian constitution are still visible in the division of their lands; and they have some ushers or freeholders amongst them. But the Scots laws, customs, manners, diet, and language, prevail; and they have a sheriff, and other magistrates for the administration of justice, as well as a customs-house, with a proper number of officers. In reference to their ecclesiastical concerns, they have a presbytery, 12 ministers, and an itinerant for Folia, Fair Island, and the Skerries. Each of these ministers has a stipend of between 40 and 50 pounds, besides a house and a glebe free from taxes. The number of souls in these islands may be about 20,000.

SHEW-BREAD, the loaves of bread which the priest of the week put every Sabbath-day upon the golden-table in the sanctuary, before the Lord, in the temple of the Jews. They were twelve in number, and were offered to God in the name of the twelve tribes of Israel. They were shaped like a brick, were ten palms long and five broad, weighing about eight pounds each. They were unleavened, and made of fine flour by the Levites. The priests set them on the table in two rows, six in a row, and put frankincense upon them to receive them from moulding. They were changed every Sabbath, and the old ones belonged to the priest upon duty. Of this bread none but the priests might eat, except in case of necessity. It was called the *bread of faces*, because the table of the shew-bread, being almost over-against the ark of the covenant, the faces might be laid to be set before the face of God. The original table was carried away to Babylon, but a new one was made for the second temple. It was of wood overlaid with gold. This, with the candlestick and some other spoils, was carried by Titus to Rome.

SHIELD, an ancient weapon of defence, in form of a light buckler, bound to the arm to fend off lances, darts, &c. The form of the shield is reckoned by the chronicles in coats of arms. The shield was that part of the ancient armour on which the persons of distinction in the field of battle always had their arms painted; and most of the words used at this time to express the space which holds the arms of a shield are derived from the Latin name for a shield, *scutum*. The French *écu* and *escuyer*, and the English word *shield*, &c. as we commonly speak it, *scutum*, are evidently of the same origin; and the Italian *scudo* signifies but the shield or arms, and that used in war. The Latin name *scutum*, for the same thing, seems also to be derived from the Greek word *σκιον*, *to engrave*; and it had this name from the several figures engraved on it, as marks of distinction of the person who wore it.

The shield is now among the Greeks and Romans, very common and in the service of the body, but it was also a mark of nobility or honour, to the warriors; and he who wore it in his breast without it was always treated with the name of coward. People have at all times distinguished themselves in the manner the most noble, from the meanest, by the arms on their shields; and it is not possible to be distinguished in the manner, without some mark to distinguish the noble from the mean, and the valiant from the cowardly.

Shetland
II
Shetland

Shield. ways chose to represent them upon the figure of a shield, but with several exterior additions and ornaments; as the helmet, supporters, and the reel.

The form of the shield has not only been found different in various nations, but even the people of the same nation, at different times, have varied its form extremely; and among several people there have been shields of several forms and sizes in use, at the same period of time, and suited to different occasions. The most ancient and universal form of shields, in the earlier ages, seems to have been the triangular. This we see instances of in all the monuments and gems of antiquity: our own most early monuments show it to have been the most antique shape also with us, and the heralds have found it the most convenient for their purposes, when they had any odd number of figures to represent; as if three, then two in the broad bottom part, and one in the narrow upper end, it held them very well; or if five, they stood as conveniently, as three below, and two above. The other form of a shield, now universally used, is square, rounded and pointed at the bottom: this is taken from the figure of the Samnitic shield used by the Romans, and since copied very generally by the English, French, and Germans.

The Spaniards and Portuguese have the like general form of shields, but they are round at the bottom without the point; and the Germans, beside the Samnitic shield, have two others pretty much in use: these are, 1. The bulging shield, distinguished by its swelling or bulging out at the flanks; and, 2. The indented shield, or shield chancree, which has a number of notches and indentings all round its sides. The use of the ancient shield of this form was, that the notches served to give the lance upon, that it might be firm while it raved the thrust; but this form being less proper for the receiving armorial figures, the two former have been much more used in the heraldry of that nation.

Beside this different form of the shields in heraldry, we find them also often distinguished by their different positions, some of them standing erect, and others slanting various ways, and in different degrees; this the heralds express by the word *pendant*, "hanging," they seeming to be hung up not by the centre, but by the right or left corner. The French call these *ecu pendant*, and the common antique triangular ones *ecu ancien*. The Italians call this *scuto pendente*; and the reason given for exhibiting the shield in these figures in heraldry is, that in the ancient tilts and tournaments, they who were to joust at these military exercises, were obliged to hang up their shields with their armories, or coats of arms on them, out at the windows and balconies of the houses near the place; or upon trees, pavilions, or the barriers of the ground, if the exercise was to be performed in the field.

Those who were to fight on foot, according to Columbian, had their shields hung up by the right corner, and those who were to fight on horseback had theirs hung up by the left. This position of the shields in heraldry is called *concele* by some writers, though by the generality *pendant*.

It was very frequent in all parts of Europe, in arms given between the 11th and 14th centuries; but it is to be observed, that the hanging by the left corner, as it was the token of the owner's being to fight on horseback, so it was esteemed the most honourable and

noble situation; and all the pendant shields of the sons of the royal family of Scotland and England, and of our nobility at that time, are thus hanging from the left corner. The hanging from this corner was a token of the owner's being of noble birth, and having fought in the tournaments before; but no sovereign ever had a shield pendant any way, but always erect, as they never formally entered the lists of the tournament.

The Italians generally have their shields of arms of an oval form; this seems to be done in imitation of those of the popes and other dignified clergy: but their herald Petro Sancto seems to regret the use of this figure of the shield, as an innovation brought in by the painters and engravers as most convenient for holding the figures, but derogatory to the honour of the possessor, as not representing either antiquity or honours won in war, but rather the honours of some citizen or person of learning. Some have carried it so far as to say, that those who either have no ancient title to nobility, or have sullied it by any unworthy action, cannot any longer wear their arms in shields properly figured, but were obliged to have them painted in an oval or round shield.

In Flanders, where this author lived, the round and oval shields are in the disrepute he speaks of; but in Italy, beside the popes and dignified prelates, many of the first families of the laity have them.

The secular princes, in many other countries, also retain this form of the shield, as the most ancient and truly expressive of the Roman clypeus.

SHIELD, in *Heraldry*, the escutcheon or field on which the bearings of coats of arms are placed. See HERALDRY. SHIELDRAKE, or SHIEDRAKE. See ANAS, ORNITHOLOGY *Index*.

SHIELDS, NORTH and SOUTH, two sea-port towns, at the mouth of the Tyne, the one in Northumberland, the other in the county of Durham. South Shields contained above 200 salt-pans, 50 years ago; but now there are not more than five or six; and the duty, which is now only 10,000*l.* per annum, amounted formerly to 82,000*l.* South Shields has a considerable trade, in which not less than 500 vessels from 100 to 500 tons burden are employed; and has nine dry docks for repairing, and 10 yards for building ships. This town has been much improved of late years. In the centre there is a large square, in which there is a handsome town-hall, with a colonnade under it for the weekly market, and from which streets branch out on all sides. North Shields contains also some fine streets and squares. The harbour is very commodious, and so spacious, that it is capable of receiving 2000 ships. It is defended by a fort, in which there is also a lighthouse, corresponding with another on the top of the bank, to direct vessels into the harbour. The population of North and South Shields is estimated at 25,000. W. Long. 1. 12. N. Lat. 55. 44.

SHIFTERS, on board a man of war, certain men who are employed by the cooks to shift and change the water in which the flesh or fish is put, and laid for some time, in order to fit it for the kettle.

SHIFTING A TACKLE, in sea-language, the act of removing the blocks of a tackle to a greater distance from each other, on the object to which they are applied, in order to give a greater scope or extent to their purchase. This operation is otherwise called *flitting*. Shifting the helm denotes the alteration of its position.

Shilling. by pushing it towards the opposite side of the ship. Shifting the voyal, signifies changing its position on the capitem, from the right to the left, and *vice versa*.

SHILLING, an English silver coin, equal to twelve pence, or the twentieth part of a pound.

Freherus derives the Saxon *scilling*, whence our shilling, from a corruption of *siliqua*; proving the derivation by several texts of law, and, among others, by the 26th law, *De annuis legatis*. Skinner deduces it from the Saxon *scild*, "shield," by reason of the elucecheon of arms thereon.

Bishop Hooper derives it from the Arabic *sheele*, signifying a weight; but others, with greater probability, deduce it from the Latin *scilicet*, which signified in that language a quarter of an ounce, or the 48th part of a Roman pound. In confirmation of this etymology it is alleged, that the shilling kept its original signification, and bore the same proportion to the Saxon pound as scilicet did to the Roman and the Greek, being exactly the 48th part of the Saxon pound; a discovery which we owe to Mr Lambarde*.

However, the Saxon laws reckon the pound in the round number at 50 shillings, but they really coined out of it only 48; the value of the shilling was five pence; but it was reduced to fourpence above a century before the conquest; for several of the Saxon laws, made in Athelstan's reign, oblige us to take this estimate. Thus it continued to the Norman times, as one of the Conqueror's laws sufficiently ascertains; and it seems to have been the common coin by which the English payments were adjusted. After the conquest, the French *solidus* of twelvepence, which was in use among the Normans, was called by the English name of shilling; and the Saxon shilling of fourpence took a Norman name, and was called the *great*, or great coin, because it was the largest English coin then known in England.

It has been the opinion of the bishops Fleetwood and Gibson, and of the antiquaries in general, that, though the method of reckoning by pounds, marks, and shillings, as well as by pence and farthings, had been in constant use even from the Saxon times, long before the Norman conquest, there never was such a coin in England as either a pound or a mark, nor any shilling, till the year 1524 or 1525, when a few silver shillings or twelvepences were coined, which have long since been solely confined to the cabinets of collectors.

Mr Clarke combats this opinion, alleging that some coins mentioned by Mr Folkes, under Edward I. were probably Saxon shillings new minted, and that Archbishop Aelfric expressly says †, that the Saxons had three names for their money, viz. mancuses, shillings, and pennies. He also urges the different value of the Saxon shilling at different times, and its uniform proportion to the pound, as an argument that their shilling was a coin; and the testimony of the Saxon gospels, in which the word we have translated *pieces of silver* is rendered *shilling*, which, he says, they would hardly have done, if there had been no such coin as a shilling then in use. Accordingly the Saxons expressed their shilling in Latin by *scelus* and *argentus*. He farther adds, that the Saxon shilling was never expressed by *solidus* till after the Norman settlements in England; and howsoever it altered during the long period that elapsed from the conquest to the time of Henry VII. it

was the most constant denomination of money in all payments, though it was then only a species of account, or the twentieth part of the pound sterling; and when it was again revived as a coin, it lessened gradually as the pound sterling lessened, from the 28th of Edward III. to the 43d of Elizabeth.

In the year 1562 there was a peculiar sort of shilling struck in Ireland, of the value of ninepence English, which passed in Ireland for twelvepence. The motto on the reverse was, *posui Deum adiutorem meum*. Eighty-two of these shillings, according to Malynes, went to the pound; they therefore weighed 20 grains, one-fourth each, which is somewhat heavier in proportion than the English shilling of that time, 62 whereof went to the pound, each weighing 92 grains seven-eighths; and the Irish shilling being valued at the Tower at ninepence English, that is, one-fourth part less than the English shilling, it should therefore proportionally weigh one-fourth part less, and its full weight be somewhat more than 62 grains; but some of them found at this time, though much worn, weighed 69 grains. In the year 1598, five different pieces of money of this kind were struck in England for the service of the kingdom of Ireland. These were shillings to be current in Ireland at twelvepence each; half shillings to be current at sixpence, and quarter shillings at threepence. Pennies and halfpennies were also struck of the same kind, and sent over for the payment of the army in Ireland. The money thus coined was of a very base mixture of copper and silver; and two years after there were more pieces of the same kinds struck for the same service, which were still worse; the former being three ounces of silver to nine ounces of copper; and these latter only two ounces eighteen pennyweights to nine ounces two pennyweights of the alloy.

The Dutch, Flemish, and Germans, have likewise their shilling, called *schelin*, *schilling*, *schelin*, &c. but these not being of the same weight or fineness with the English shilling, are not current at the same value. The English shilling is worth about 23 French sols; those of Holland and Germany about 11 sols and a half; those of Flanders about nine. The Dutch shillings are also called *sols de gros*, because equal to twelve gros. The Danes have copper shillings worth about one-fourth of a farthing sterling.

SHILLUK, a town in Africa on the banks of the true Nile. The houses are built of clay, and the clothing of the inhabitants consists of long grass, which they pass round the waist and between the thighs. They are all black, and both sexes shave their heads. These people have the dominion of the river, and exact toll of all passengers. The meaning of the word Shilluk seems to be unknown. When they transport Mahometans across the ferry, they sometimes shew the importance which their situation gives them. After the Mahometan has placed himself in the boat, they ask him, who is the master of that river? The other replies Ulloh or Rubbaric, God is the master of it. No, you must say that such a one (naming his chief) is the master of it, or you shall not pass. They are said to be hospitable to such as come among them in a peaceable manner, and as never betraying those to whom they have once afforded protection. The particulars of their worship have not been described. Shilluk, according to Mr Brown's map, is in 13° N. Lat. 36° 30' E. Long.

Shilling.

Shilling.

* *Explicatio Rerum et Verborum in Leg. Sax. voc. Libra.*

† *Gram. Saxon.* p. 51.

Shiloh

SHILOH, is a term famous among interpreters and commentators upon Scripture. It is found (Gen. xiv. 18.) to denote the Messiah. The patriarch Jacob foretells his coming in the words: "The sceptre shall not depart from Judah, nor a lawgiver from between his feet, until Shiloh come; and unto him shall the gathering of the people be." The Hebrew text reads, *וְיָשֵׁב וְיָשֵׁב וְיָשֵׁב* and *שִׁלֹּחַ* come. All Christian commentators agree, that this word ought to be understood of the Messiah, or Jesus Christ; but all are not agreed about its literal and grammatical signification. St Jerome, who translates it by *Qui venturus est*, manifestly reads *Shiloh* "sent," instead of *Shiloh*. The Septuagint have it *Εως ου ουδεις ανθρωπος ονομασται οτι, Εως ου ουδεις ανθρωπος*, (as if they had read *for* instead of *and*), i. e. "Until the coming of him to whom it is referred;" or, "Till we be alive that which is reserved for him."

It may be owned, that the signification of the Hebrew word *Shiloh* is not well known. Some translate, "the sceptre shall not depart from Judah, till he come to whom it belongs;" *שִׁלֹּחַ* or *שִׁלֹּחַ* instead of *שִׁלֹּחַ*. Others, "till the coming of the peace-maker;" or, "the pacifier;" or, "of prosperity;" *שִׁלֹּחַ* *prospicitur est*. *Shiloh* signifies, "to be in peace, to be in prosperity;" others, "till the birth of him who shall be born of a woman that shall conceive without the knowledge of a man," *שִׁלֹּחַ* or *שִׁלֹּחַ secundum, Fovus*; or, otherwise, "the sceptre shall not depart from Judah, till his end, his ruin; till the downfall of the kingdom of the Jew;" *שִׁלֹּחַ* or *שִׁלֹּחַ* *is* *conject.* *it has for a d.* Some Rabbinists have taken the name *Shiloh* or *Shiloh*, as if it signified the city of this name in Palestine: "The sceptre shall not be taken away from Judah till it comes to Shiloh; till it shall be taken from him to be given to Shiloh." But in what part of Scripture is it said, that *Shiloh* was acknowledged as king or consecrated at Shiloh? If we would understand it of Jeroboam the son of Nebat, the matter is still as uncertain. The Scripture mentions no assembly at Shiloh that admitted him as king. A more modern author derives *Shiloh* from *שִׁלֹּחַ*, *faciens*, which sometimes signifies *to be weary, to labor*; "till his labours, his sickness, his passion, shall happen."

But not to amuse ourselves about seeking out the grammatical signification of *Shiloh*, it is sufficient for us to show, that the ancient Jews are in this matter agreed with the Christians: they acknowledge, that this word stands for the *Messiah the King*. It is thus that the paraphrasis Onkelos and Jetham, that the ancient Hebrew commentaries upon Genesis, and that the Talmudists themselves, explain it. If Jesus Christ and his apostles did not make use of this passage to prove the coming of the Messiah, it was because then the completion of this prophecy was not sufficiently manifest. The sceptre still continued among the Jews: they had still kings of their own nation in the persons of the Herods; but soon after the sceptre was entirely taken away from them, and has never been restored to them since.

The Jews seek in vain to put forced meanings upon this prophecy of Jacob; as if, for example, that the sceptre intimates the dominion of Princes, to which they have been in possession, or the hope of seeing one day the sceptre or supreme power settled again among themselves. It is easy to perceive, that all this is contrived to deliver themselves out of perplexity. In vain

while they take refuge in certain pieces of the captivity, whom they pretend to have subsided beyond the Egyptians, exceeding an authority over their nation little differing from absolute, and being of the race of David. This pretended succession of princes is perfectly chimerical; and though at certain times they could show a succession, it continued but a short time, and their authority was too obscure, and too much limited, to be the object of a prophecy so remarkable as this was.

SHINGLES, in building, small pieces of wood, or quartered osken boards, sawn to a certain length, or, as is more usual, cleft to about an inch thick at one end, and made like wedges, four or five inches broad, and eight or nine inches long.

Shingles are used instead of tiles or slates, especially for churches and temples; however, this covering is dear; yet, where tiles are very scarce, and a light covering is required, it is preferable to slates; and where they are made of good oak, cleft, and not fived, and well season'd in water and the sun, they make a sure, light, and durable covering.

The building is first to be covered all over with boards, and the shingles nailed upon them.

SHIP, a general name for all large vessels, particularly those equipped with three masts and a bowsprit; the masts being composed of a lowermast, tonmast, and topgallant-mast: each of these being provided with yards, sails, &c. Ships, in general, are either employed for war or merchandise.

Ships of War are vessels properly equipped with artillery, ammunition, and all the necessary martial weapons and instruments for attack or defence. They are distinguished from each other by their several ranks or classes, called *rates*, as follows: Ships of the first rate mount from 100 guns to 110 guns and upwards; second rate, from 90 to 95 guns; third rate, from 64 to 74 guns; fourth rate, from 50 to 60 guns; fifth rate, from 22 to 44 guns; and sixth rates, from 20 to 28 guns. See the article *RATE*. Vessels carrying less than 20 guns are denominated *ships, cutters, brigs, and ketches*. It has lately been proposed to reduce the number of these rates, which would be a saving to the nation, and also productive of several material advantages.

In Plate CCCCXXX, is the representation of a first rate, with rigging, &c. the several parts of which are as follows:

Parts of the hull.—Fig. 1. A, The outboard; B, The fore-chain-wales, or chains; C, The main-chains; D, The mizen-chains; E, The entering post; F, The hauck-holes; G, The poop-hatchers; H, The chest-tree; I, The head; K, The Stern.

1, The bowsprit. 2, Yard and sail. 3, Gunmonning. 4, Mastion. 5, Bobstay. 6, Spirit-sail-sheets. 7, Pendant. 8, Braces and pendant. 9, Halliards. 10, Lifts. 11, Chace-lines. 12, Spirit-sail-boards. 13, Buntlines. 14, Standing lifts. 15, Bow-sprit-bleud. 16, Jib-boom. 17, Jib-bay and sail. 18, Halliards. 19, Sheets. 20, H-rig. 21, Jib-guy. 12, Spirit-sail-top-sail yard. 23, Holes. 24, Sheets. 25, Lifts. 26, Braces and pendant. 27, Cap of bowsprit. 28, Jack staff. 29, Truck. 30, Jack-log.—31, Fore-mast. 32, Runner and tackle. 33, Strouds. 34, Linnards. 35, Stay and linnard. 36, Preventer-stay and linnard. 37, Wrecking of the mast. 38, Foreyard and sail. 39, Hoist.

Plate
CCCCXXX
Fig. 1.

Shiloh
Shiloh
Shiloh

A Le Clerc
in Geogr.

Ship. Mast, 41, Top, 41, Crowmast, 22, Jeers, 43, Yard-booms, 44, Lifts, 45, Braces and pendants, 46, Sheets, 47, Foretacks, 48, Bowlines and bridles, 49, Fore buntlines, 50, Fore leechlines, 51, Preventer-brace, 52, Futtock-threads,—53, *Fore-top-mast*, 54, Shrouds and laniards, 55, Fore-top-fall yard and fall, 56, Stay and fall, 57, Runner, 58, Backstays, 59, Halliards, 60, Lifts, 61, Braces and pendants, 62, Holes, 63, Clewlines, 64, Bowlines and bridles, 65, Reef-tackles, 66, Sheets, 67, Buntlines, 68, Cross-trees, 69, Cap, 70, Fore-top-gallant-mast, 71, Shroud, 72, Yard and fall, 73, Backlays, 74, Stay, 75, Lifts, 76, Clewlines, 77, Braces and pendants, 78, Bowlines and bridles, 79, Flag-staff, 80, Truck, 81, Flag-stay-staff, 82, Flag of the lord high admiral—83, *Mainmast*, 84, Shrouds, 85, Laniards, 86, Runner and tackle, 87, Futtock-threads, 88, Top-boom, 89, Crank of ditto, 90, Stay, 91, Preventer-stay, 92, Stay-tackles, 93, Wooding of the mast, 94, Jeers, 95, Yard-tackles, 96, Lifts, 97, Braces and pendants, 98, Holes, 99, Sheets, 100, Tacks, 101, Bowlines and bridles, 102, Crow-foot, 103, Cap, 104, Top, 105, Buntlines, 106, Leechlines, 107, Yard and fall,—108, *Main-top-mast*, 109, Shrouds and laniards, 110, Yard and fall, 111, Futtock-threads, 112, Backlays, 113, Stay, 114, Stay-fall and halliards, 115, Tye, 116, Halliards, 117, Lifts, 118, Clewlines, 119, Braces and pendants, 120, Holes, 121, Sheets, 122, Bowlines and bridles, 123, Buntlines, 124, Reef-tackles, 125, Cross-trees, 126, Cap,—127, *Main-top-gallant-mast*, 128, Shroud and laniards, 129, Yard and fall, 130, Backlays, 131, Stay, 132, Stay-fall and halliards, 133, Lifts, 134, Braces and pendants, 135, Bowlines and bridles, 136, Clewlines, 137, Flagstaff, 138, Truck, 139, Flagstaff-fly, 140, Flag-stand,—141, *Mizenmast*, 142, Shrouds and laniards, 143, Cap, 144, Yard and fall, 145, Block for signal halliards, 146, Sheet, 147, Pendant lines, 148, Peckbrails, 149, Stay-ail, 150, Stay, 151, Derrick and span, 152, Top, 153, Crossjack yard, 154, Crossjack lifts, 155, Crossjack braces, 156, Crossjack flings—157, *Mizen-top-mast*, 158, Shrouds and laniards, 159, Yard and fall, 160, Backlays, 161, Stay, 162, Halliards, 163, Lifts, 164, Braces and pendants, 165, Bowlines and bridles, 166, Sheets, 167, Clewlines, 168, Stay-fall, 169, Cross-trees, 170, Cap, 171, Flagstaff, 172, Flagstaff-fly, 173, Truck, 174, Flag-union, 175, Ensign-staff, 176, Truck, 177, Ensign, 178, Stern ladder, 179, Bower cable.

Fig. 2. Plate CCCCLXXI. is a vertical longitudinal section of a fire rate clip of war, with references to the principal parts, which are as follows:

A, Is the head, containing,—1, The stem; 2, The knee of the head or cutwater; 3, The lower and upper cheeks; 4, The trail-rod; 5, The figure; 6, The gratings; 7, The brackets; 8, The false stern; 9, The breast hooks; 10, The haule-holes; 11, The bulkhead forward; 12, The cathed; 13, The cathook; 14, Necessary seats; 15, The manger within board; 16, The bowsprit.

B, Upon the forecable—17, The gratings; 18, The partners of the mast; 19, The gunwale; 20, The belly; 21, The funnel for smoke; 22, The gangway going off the forecable; 23, The forecable guns.

C, In the forecable—24, The fore- or middle gun-deck forward; 25, Officers cabins; 26, The hold; 27, Fore-top-fall sheet bits; 28, The beams; 29, The catmasts.

D, The middle gun-deck forward—30, The fore-jack bit; 31, The oven and furnace of copper; 32, The capstern's cork room; 33, The ladder or way to the forecable.

E, The lower gun-deck for ward—34, The partners for and aft; 35, The fore-threads, or the first track next to each deck, the next under the beams being called *catmasts*; 36, The beams of the middle gun-deck fore and aft; 37, The corings of the middle gun-deck fore and aft; 38, The fore-bits; 39, The after or main bit; 40, The hatchway to the gunner's and boatwain's fore-rooms; 41, The fore cabin.

F, The orlop—42, 43, 44, The gunner's, boatwain's, and carpenter's fore-rooms; 45, The beams of the lower gun-deck; 46, 47, The pillars and the riders, fore and aft; 48, The bulkhead of the fore-rooms.

G, The hold—49, 50, 51, The foot-hook rider, the floor rider, and the standard, fore and aft; 52, The pillars; 53, The fep of the foremast; 54, The keelson, or false deck, and dead rising; 55, The dead-wood.

H, At midships in the hold—56, The floor timbers; 57, The keel; 58, The well; 59, The chain pump; 60, The fep of the mainmast; 61, 62, Beams and carlings of the orlop, fore and aft.

I, The orlop amidships—63, The cable tire; 64, The main hatchway.

K, The lower gun-deck amidships—65, The ladder leading up to the middle gun-deck; 66, The lower tire of ports.

L, The middle gun-deck amidships—67, The middle tire of ports; 68, The entering part; 69, The main jere bits; 70, Twisted pillars or stanchions; 71, The caplins; 72, Gratings; 73, The ladder leading to the upper deck.

M, The upper gun-deck amidships—74, The maintop-fall-sheet bits; 75, The upper partners of the mainmast; 76, The galleys on which spare topmasts &c. are laid; 77, The fore-sheet blocks; 78, The remets; 79, The gunwale; 80, The upper gratings; 81, The drift brackets; 82, The pit-dale; 83, The capstern-pall.

N, Aft of the mainmast—84, The gangway off the quarter-deck; 85, The bulkhead of the cockpit; 86, The shaftcase down to the middle gun-deck; 87, The beams of the upper deck; 88, The gratings about the mainmast; 89, The coach or council chamber; 90, The shaftcase up to the quarter-deck.

O, The quarter-deck—91, The beams; 92, The carling; 93, The partners of the mainmast; 94, The gangway up to the poop; 95, The bulkhead of the cockpit.

P, The poop—96, The trumpeter's cabin; 97, The taffrail.

Q, The captain's cabin.

R, The cockpit, usually divided for the master and secretary's offices.

S, The fore-room, out of which is made the bed-chamber and other conveniences for the commander in chief; 98, The entrance into the gallery; 99, The bulkhead of the great cabin; 100, The stern lights and other galleries.

T, The ward-room, allotted for the lieutenants and

Ship. marine officers: 101, The lower gallery; 102, The steerage and bulkhead of the wardroom; 103, The whiplaft, commanding the tiller; 104, The after staircase leading down to the lower gun-deck.

V, Several officers cabins abaft the mainmast, where the soldiers generally keep guard.

W, The gun room—105, The tiller commanding the rudder; 106, The rudder; 107, The stern-post; 108, The tiller tranfom; 109, The feveral tranfoms, viz. 1, 2, 3, 4, 5; 110, The gun-room ports, or stern-chafe; 111, The bread-room icuttle, out of the gun-room; 112, The main capitan; 113, The pall of the capitan; 114, The partner; 115, The bulkhead of the bread-room.

X, The bread-room.

Y, The steward's room, where all provisions are weighed and ferved out.

Z, The cockpit, where are fubdivifions for the purfer, the furgeon, and his mates.

A A, The platform or erlop, where provision is made for the wounded in the time of fervice; 116, The hold abaft the main-maft; 117, The ftep of the mizen-maft; 118, The keelon, or fallie keel; 119, The dead wood, or fizing.

Ships of war are fitted out either at the expence of the ftate or by individuals. Thofe fitted out at the public expence are called *King's fhips*, and are divided into *fhips of the line, frigates, floops*, &c. For an account of each of thefe, fee the refpective articles. Ships of war fitted out by individuals are called *privaters*. See the article **PRIVATEER**.

Armed SHIP. See **ARMED-Ship**.

Bomb-SHIP. See **BOMB Veffels**.

Double-SHIP. See **SHIP-Building**.

Fire-SHIP. See **FIRE-Ship**.

Hofpital-SHIP, a veffel fitted up to attend on a fleet of men of war, and receive their fick or wounded; for which purpofe her decks fhould be high, and her ports fufticiently large. Her cables ought alfo to run upon the upper deck, to the end that the beds or cradles may be more commodioufly placed between decks, and admit a free paffage of the air to difperfe that which is offenfive or corrupted.

Merchant-SHIP, a veffel employed in commerce to carry commodities of various forts from one port to another.

The largeft merchant fhips are thofe employed by the different companies of merchants who trade to the Eaft Indies. They are in general larger than our 40 gun fhips; and are commonly mounted with 20 guns on their upper-deck, which are nine pounders; and fix on their quarter-deck, which are fix pounders.

Regifter-SHIP. See **REGISTER-Ship**.

Store-SHIP, a veffel employed to carry artillery or naval ftores for the ufe of a fleet, fortrefs, or garrifon.

Transport-SHIP, is generally ufed to conduct troops from one place to another.

Befides the different kinds of fhips abovementioned, which are denominated from the purpofe for which they are employed, veffels have alfo, in general, been named according to the different manner of rigging them. It would be an endless, and at the fame time an unneceffary tafk, to enumerate all the different kinds of veffels with refpect to their rigging; and therefore a few only are here taken notice of. Fig. 3.

is a *fhip* which would be converted into a *bark* by ftripping the mizen maft of its yards and the fails belonging to them. If each maft, its corresponding topmaft and topgallant-maft, inftead of being compofed of feperate pieces of wood, were all of one continued piece, then this veffel with very little alteration would be a *palacore*. Fig. 4. reprefents a *fnaw*; fig. 5. a *bilander*; fig. 6. a *brig*; fig. 7. a *ketch*; fig. 8. a *fchooner*; fig. 9. a *floop*; fig. 10. a *xebec*; fig. 11. a *galliot*; fig. 12. a *digger*; fig. 13. a *galley* under fail; fig. 14. ditto rowing.

Ships are alfo fometimes named according to the different modes of their conftruction. Thus we fay, a *cat-built fhip*, &c.

To *SHIP*, is either ufed actively, as to embark any perfon or put any thing aboard fhip: or paffively, to receive any thing into a fhip; as, "we fhipped a heavy fea at three o'clock in the morning."

To *SHIP*, alfo implies to fix any thing in its place; as, to fhip the oars, that is, to put them in their rowlocks; to fhip the fwivel guns, is to fix them in their fockets; to fhip the handpikes, &c.

Machine for drawing Bolts out of SHIPS, an inftrument invented by Mr William Hill for this purpofe. His account of which is as follows *

"First, The ufe of this machine is to draw the keelsons and dead wood bolts out, and to draw the knee of the head bolts.—Secondly, The heads of the keelson bolts heretofore were all obliged to be driven through the keelson, floor-timbers, and keel, to get them out; by this means the keelson is often entirely deftroyed, and the large hole the head makes materially wounds the floors; and frequently, when the bolt is much corroded, it icarcs, and the bolt comes out of the fide of the keel.—Thirdly, The dead-wood bolts that are driven with two or three drifts, are feldom or never got out, by which means the dead-wood is condemned, when fome of it is really ferviceable.—Fourthly, In drawing the knee of the head-bolts, fometimes the knee flarts off, and cannot be got to again, but furs up, and with this machine may be drawn in; for it has been proved to have more power in flarting a bolt than the maul."

In fig. 1. "A, A, represent two ftrong male fcrews, working in female fcrews near the extremities of the checks, againft plates of iron E, E. C C is the bolt to be drawn; which, being held between the chaps of the machine at DD, is, by turning the fcrews by the lever B. forced upwards out of the wood or plank of the fhip. F, F, are two dogs, with hooks at their lower extremities; which, being driven into the plank, ferve to fupport the machine till the chaps have got faft hold of the bolt. At the upper part of thefe dogs are rings paffing through holes in a collar, moveable near the heads of the fcrews. Fig. 2. is a view of the upper fide of the checks when joined together; a, a, the holes in which the fcrews work; b, the chaps by which the bolts are drawn. Fig. 3. The under fide of the cheek: a, a, the holes in which the fcrews work; b, the chaps by which the bolts are drawn, and where the teeth that gripe the bolt are more diftinctly fhown. Fig. 4. One of the checks feperated from the other, the letters referring as in fig. 2. and 3.

This machine was tried in his majesty's yard at Deptford, and was found of the greateft utility.—"First, it drew a bolt that was driven down fo tight as only to go one

Ship. one inch in sixteen blows with a double headed maul, and was well clenched below : the bolt drew the ring a considerable way into the wood, and wire drew itself through, and left the ring behind. Secondly, it drew a bolt out of the Venus's dead wood that could not be got out by the maul. That part of it which went through the keel was bent close up to the lower part of the dead-wood, and the machine drew the bolt straight, and drew it out with ease. It also drew a keelson bolt out of the Stanley West Indianman, in Messrs Well's yard, Deptford; which being a bolt of two drifts, could not be driven out.

Management of SHIPS at single anchor, is the method of taking care of a ship while riding at single anchor in a tide-way, by preventing her from fouling her anchor, &c. The following rules for this purpose, with which we have been favoured by Henry Taylor * of North Shields, will be found of the utmost consequence.

*** Taylor's Instructions to Young Mariners Riding at Anchor in moderate Weather.** Riding in a tide way, with a fresh wind, the ship should have what is called a *short or windward service*, say 45 or 50 fathoms of cable, and always sheered to windward (A), not always with the helm hard down, but more or less so according to the strength or weakness of the tide. It is a known fact, that many ships sheer their anchors home, drive on board of other ships, and on the sands near which they rode, before it has been discovered that the anchor had been moved from the place where it was let go.

1 When the wind is cross, or nearly cross, off shore, or in the opposite direction, ships will always back. This is done by the mizen-top-sail, assisted, if needful, by the mizen stay-sail; such as have no mizen-top-sail commonly use the main-top-sail, or if it blows fresh, a topgallant-sail, or any such sail at the gaff.

In backing, a ship should always wind with a taught cable, that it may be certain the anchor is drawn round. In case there is not a sufficiency of wind for that purpose, the ship should be hove apeak.

2 Riding with the wind afore the beam, the yards should be braced forward; if abaft the beam, they are to be braced all aback.

3 If the wind is so far aft that the ship will not back (which should not be attempted if, when the tide eases, the ship forges ahead, and brings the buoy on the lee quarter), she must be set ahead: if the wind is far aft, and blows fresh, the utmost care and attention is necessary, as ships riding in this situation often break their sheer, and come to windward of their anchors again. It should be observed, that when the ship lies in this

ticklish situation, the after-yards must be braced forward, and the fore-yards the contrary way: she will lay safe, as the buoy can be kept on the lee quarter, or suppose the helm is apeak, as long as the buoy is on the larboard quarter. With the helm thus, and the wind right aft, or nearly so, the starboard main and fore braces should be hauled in. This supposes the main braces to lead forward.

When the ship begins to tend to leeward, and the buoy comes on the weather quarter, the first thing to be done is to brace about the fore-yard; and when the wind comes near the beam, let the fore stay-sail, and keep it flanking until it shakes; then brace all the head-yards flap forward, especially if it is likely to blow strong.

If lying in the aforesaid position, and she breaks her sheer, brace about the main-yard immediately; if she recovers and brings the buoy on the lee or larboard quarter, let the main-yard be again braced about; but if she come to a sheer the other way, by bringing the buoy on the other quarter, change the helm and brace the fore-yard to.

Riding leeward tide with more cable than the windward service, and expecting the ship will go to windward of her anchor, begin as soon as the tide eases to shorten in the cable. This is often hard work; but it is necessary to be done, otherwise the anchor may be fouled by the great length of cable the ship has to draw round; and even if that could be done, the cable would be damaged against the bows or cut-water. It is to be observed, that when a ship rides windward tide the cable should be cackled from the short service towards the anchor, as far as will prevent the bare part touching the ship.

When the ship tends to windward and must be set ahead, hoist the fore-stay-sail as soon as it will stand, and when the buoy comes on the lee quarter, haul down the fore-stay-sail, brace to the fore-yard, and put the helm a-lee; for till then the helm must be kept a-weather and the yards full.

When the ship rides leeward tide, and the wind increases, care should be taken to give her more cable in time, otherwise the anchor may start, and probably it will be troublesome to get her brought up again; and this care is the more necessary when the ship rides in the haufe of another ship. Previous to giving a long service it is usual to take a weather-bit, that is, a turn of the cable over the windlass end, so that in veering away the ship will be under command. The service ought

(A) It has been thought by some theorists, that ships should be sheered to leeward of their anchors; but experience and the common practice of the best informed seamen are against that opinion: for it is found, that when a ship rides leeward tide and sheered to windward, with the wind two or three points upon the bow, and blowing hard in the interval between the squalls, the sheer will draw her towards the wind's eye; so that when the next squall comes, before she be pressed astream of her anchor, it is probable there will be a lull again, and the spring which the cable got by the sheer will greatly ease it during the squall.

Every seaman knows that no ship without a rudder, or the helm left loose, will wear; they always in such situations fly to: this proves that the wind pressing upon the quarter and the helm alee, a ship will be less liable to break her sheer than when the helm is a-weather. Besides, if the helm is a-lee when she breaks her sheer, it will be a-weather when the wind comes on the other quarter, as it ought to be until the either swing to leeward, or bring the buoy on the other quarter. Now if the ship breaks her sheer with the helm a-weather, it throws her head to the wind so suddenly as scarce to give time to brace the yards about, and very probably she will fall over her anchor, before the fore-stay-sail can be got up.

ought to be graded, which will prevent its chafing in the haul.

If the gale continues to increase, the topmasts should be struck in time; but the fore-yard should seldom, if ever, be lowered down, that in case of parting the fore-fall may be ready to be set. At such times there should be more on deck than the common anchor-watch, that no accident may happen from inattention or falling asleep.

In a tide-way a second anchor should never be let go but when absolutely necessary; for a ship will sometimes ride easier and safer, especially if the sea runs high, with a very long scope of cable and a second anchor, than will less length and two cables; however, it is advisable, as a preventive, when ships have not room to drive, and the night is dark, to let fall a second anchor under tows, with a range of cable along the deck. If this is not thought necessary to be done, the deep fore lead should be thrown overboard, and the line frequently handled by the watch, that they may be assured the rides fall.

3
Caution
respecting
the anchor
watch.

If at any time the anchor-watch, presuming on their own knowledge, should wind the ship, or flutter her to break her sheer without calling the mate, he should immediately, or the very first opportunity, oblige the crew to heave the anchor in sight; which will prevent the commission of the like fault again; for besides the share of trouble the watch will have, the rest of the crew will blame them for neglecting their duty.

9
The port-
main duty
of the ship's
mate.

Prudent mates seldom lie a week in a roadstead without heaving their anchor in sight; even though they have not the least suspicion of its being foul. There are other reasons why the anchor should be hauled at; sometimes the cable receives damage by sweeping wrecks or anchors that have been lost, or from rocks or bones; and it is often necessary to trip the anchor, in order to take a clearer birth, which should be done as often as any ship but go up too near.

Method for the safe removal of such SHIPS as have been driven on shore. For this purpose empty casks are usually employed to float off the vessel, especially if she is small, and at the same time near the port to which it is proposed to conduct her. In other cases, the following method adopted by Mr. Barnard* will answer.

1770
The
P. H. C.
1771
1772
1773

"On January 1, 1770 (says Mr. Barnard), in a most dreadful storm, the York Lait Indianan, of eight hundred tons, bound toward home, with a pepper cargo, parted her cables in Mangrove cove, and was driven on shore, within one hundred feet of the head and thirty feet of the side of Margate pier, then drawing twenty to a foot six inches water, the flow of a good spring tide being only four or five feet at that place.

"On the third of the same month I went down, as a ship builder, to assist, as much as lay in my power, my worthy friend Sir Richard Mordaunt, to whom the ship belonged. I found her perfectly upright, and her three or four sides of pressure the same as when first built, but sunk to the twelve feet water mark, and all in a bed of chalk mixed with a stiff blue clay, exactly the shape of her Lady's dress that float of water; and from the saddle being torn from her as the break coming on shore, and the violent agitation of the sea after her being there, her stern was so greatly injured as to admit no care to be taken, which filled her for four days equal to the flow of the tide. It was fully informed myself of her situation and the flow of spring tides, and being

clearly of opinion she might be again got off, I recommended, as the first necessary step, the immediate discharge of the cargo; and, in the progress of that business, I found the tide always flowed to the same height on the ship; and when the cargo was half discharged, and I knew the remaining part should not make her draw more than eighteen feet water, and while I was observing the water at twenty-two feet six inches by the ship's marks, she instantly lifted to fifteen feet eight inches; the water and air being before excluded by her pressure on the clay, and the atmosphere acting upon her upper part equal to six hundred tons, which is the weight of water displaced at the difference of these two drafts of water.

"The moment the ship lifted, I discovered she had received more damage than was at first apprehended, her leaks being such as filled her from four to eighteen feet water in an hour and a half. As nothing effectual was to be expected from pumping, several scuttles or holes in the ship's side were made, and valves fixed thereto, to draw off the water at the lowest ebb of the tide, to facilitate the discharge of the remaining part of the cargo; and, after many attempts, I succeeded in an external application of sheep-skins sewed on a sail and thrust under the bottom, to stop the body of water from rushing so furiously into the ship. This business effected, moderate pumping enabled us to keep the ship to about six feet water at low water, and by a vigorous effort we could bring the ship to light as (when the cargo should be all discharged) to be easily removed into deeper water. But as the external application might be disturbed by so doing, or totally removed by the agitation of the ship, it was absolutely necessary to provide some permanent security for the lives of those who were to navigate her to the river Thames. I then recommended as the cheapest, quickest, and most effectual plan, to lay a deck in the hold, as low as the water could be pumped to, framed so solidly and securely, and caulked so tight, as to swim the ship independent of her own leaky bottom.

"Beams of six-timber twelve inches square were placed in the hold under every lower-deck beam in the ship, as low as the water would permit; these were in two pieces, for the convenience of getting them down, and also for the better fixing them of an exact length, and well bolted together when in their places. Over these were laid long Dutch deals of two inches and a half thick, well nailed and caulked. Against the ship's sides, all fore and aft, was well nailed a piece of fir twelve inches broad and six inches thick on the lower and three inches on the upper edge, to prevent the deck from rising at the side. Over the deck, at every beam, was laid a cross piece of fir timber six inches deep and twelve inches broad, reaching from the pillar of the hold to the ship's side, on which the shores were to be placed to resist the pressure of the water beneath. On each of these, and against the lower-deck beam, at equal distances from the side and middle of the ship, was placed an upright shore, six inches by twelve, the lower end set two inches into the cross-piece. From the foot of this shore to the ship's side, under the end of every lower-deck beam, was placed a diagonal shore six inches by twelve, to ease the ship's deck of part of the strain by throwing it on the side. An upright shore of three inches by twelve was placed from the end of every cross

Ship. piece to the lower deck to meet the sides, and of three inches by twelve on the middle and upper decks piece to the lower deck below, and as high to the planks in the hold. Thus from the deck to the partitions were inside as well as the extremities of the ship open air. The ceiling or false plank of the ship was very secure y

et to the lower deck, and the sides formed a complete room. The construction which I have given in the cut is not very exact, but that it is not being directed by the eye, and the artist's water, round the ship's side, it should be equal to the masts and rigging on the side and duty conveyed her to the dry-dock at Deptford.

S H I P - B U I L D I N G .

SHIP-BUILDING, or NAVAL ARCHITECTURE, is the art of constructing a ship so as to answer a particular purpose either of war or merchandise.

To whom the world is indebted for the invention of ships, is, like all other things of equal antiquity, uncertain.

A very small portion of art or contrivance was seen in the first ships; they were neither strong nor durable; but consisted only of a few planks laid together, without tenon or ornament, and just so compacted as to keep out the water. In some places they were only the hulls or flanks of trees hollowed, and then consisted only of one piece of timber. Nur was wood alone applied to this use; but any other buoyant materials, as the Egyptian reed papyrus; or kender, of which the primitive ships were frequently composed; the bottom and sides being executed on a frame of thin staves or framings, of flexible wood, or bight with wickers, such as we have frequently beheld amongst the American savages. In this manner they were often navigated upon the rivers of Ethiopia, Egypt, and Sabaean Arabia, even in latter times. But in the end of them, we find no mention of any thing but leather or hides sewed together. In a vessel of this kind, Darius secured his retreat to the country afterwards called Thrace, when he was compelled by a terrible deluge to forsake his former habitation of Sinothrace. According to Virgil, Charon's infernal boat was of the same composition.

But as the other arts extended their influence, naval architecture likewise began to emerge from the gloom of ignorance and barbarism; and as the ships of those ages were increased in bulk, and better proportioned for commerce, the appearance of the floating citadels of unusual form, full of living men, flying with seemingly expanded wings over the surface of the untravelled ocean, struck the ignorant people with terror and astonishment; and hence, as we are told by Aristophanes, arose the fable of Perseus flying in a ship. Hence, in all probability, the famous story of Hippocampus riding on a winged dragon is deduced, only because he failed from Athens, in the time of great dearth, to a more plentiful country, to supply the necessities of his people. The fission of the living horse Pegasus may be joined with these, who, as several mythologists report, was nothing but a ship with sails, and thence said to be the offspring of Neptune the sovereign of the sea; nor does there appear any other foundation for the fables of griffins, or of ships transformed into birds and fishes, which we so often meet with in the ancient poets. So acceptable to the first ages of the world were inventions of this nature, that whoever made any improvements in navigation or naval architecture, building new ships better fit-

ted for strength or boldness than those used before, or rendered the old more commodious by a liberal convenience, or discovered contrivances unknown to former travellers, were thought worthy of the greatest honours, and often elevated into the number of their deified heroes. Hence we have in mythology the fables of Atlas and Tantalus, which are no other than two ships; the former transported Phœnix from Greece to Cadiz, and the latter Europa from Phœnicia to Crete. Argos, Pegasus, and Perseus, were likewise new ships of a different sort from the former, which being greatly admired by the barbarous and uneducated people of those times, were translated amongst the stars, in commemoration of their inventors, and metamorphosed into constellations by the poets of their own and of succeeding ages.

The chief parts, of which ships anciently consisted, were three, viz. the belly, the prow, and the stern; these were again composed of other smaller parts, which shall be briefly described in their order. In the description, we chiefly follow Scheffer, who has so copiously treated this subject, and with such industry and learning collected whatever is necessary to illustrate it, that very little room is left for enlargement by those who incline to pursue this investigation.

1. In the belly, or middle part of the ship, there was *κερας, carina*, or the "keel," which was composed of wood; it was placed at the bottom of the ship, being designed to cut and glide through the waves, and therefore was not broad, but narrow and sharp; whence it may be perceived that not all ships, but only the *ποικυλαι*, which ships of war were called, whose bellies were freight, and of a small circumference, were provided with keels, the rest having usually flat bottoms. Around the outside of the keel were fixed pieces of wood, to prevent it from being damaged when the ship was first launched into the water, or afterwards struck on any rocks; these were called *χαλινοματα*, in Latin *cuttle*.

Next to the keel was *θαλαμος* the "pump-room, or well-room," within which was contained the *πηληνη*, or "pump," through which water was conveyed out of the ship.

After this, there was *διεστηρον πορτιον*, or the "second keel," somewhat resembling what is now called *lock-joint*; it was placed beneath the pump, and called *αυθαιον*, *χαλιον*, *κλυνοστωλον*; by some it is falsely supposed to be the same with *θαλαμος*.

Above the pump was a hollow place, called by Herodotus *καυλα πηληνη*, by Pollux *κερας* and *πηληνη*, a small ledge and capacious, after the form of an *αυθαιον*, in Latin *isthudo*. This was formed by crooked ribs, which it was furnished, which were placed round the ribs from the keel upwards, and called by Herodotus

History.

ομάς, and by others *εγκλίωσις*, the belly of the ship being contained within them: in Latin, *coëlis*; and in English, *timbers*. Upon these were placed certain planks, which Aristophanes calls *επιτοίχια*, or *επιτοίχια*.

The *πλευρά*, *latera*, or "sides" of the ship, encompassed all the former parts on both hands; these were composed of large rafters extended from prow to stern, and called *ζυγιστοί*, and *ζυγισματά*, because by them the whole fabric was begirt or surrounded.

In both these sides the rowers had their places, called *τοίχη* and *ιδώλια*, in Latin *fori* and *irastra*, placed above one another; the lowest was called *θαλαμῶσι*, and those that laboured therein *θαλαμῶσι*; the middle, *ζόλη*, and the men *ζόλιοι*; the uppermost *θρανῶσι*, whence the rowers were termed *θρανῆται*. In these apartments were spaces through which the rowers put their oars: these were sometimes one continued vacuity from one end to the other, called *πρωτόξυ*, but more usually distinct holes, each of which was designed for a single oar; these were styled *πρωτόξυ*, *πρωτομακτα*, as also *οφθαλμοί*, because not unlike the eyes of living creatures. All of them were by a more general name termed *εγκλίωσις*, from containing the oars; but *εγκλίωσις* seems to have been another thing, signifying the spaces between the banks of oars on each side, where the passengers appear to have been placed. On the top of all there was a passage or place to walk, called *παράδοσι*, and *παράβρασι*, as joining to the *θρανῶσι*, or uppermost bank of oars.

2. *Πρωά*, the "prow, or fore deck," whence it is sometimes called *μάστωσι*, and commonly distinguished by other metaphorical titles taken from human faces. In some ships there is mention of two prows, as also two sterns; such as Danaus's ship adorned by Minerva when he fled from Egypt. It was usual to beautify the prow with gold and various sorts of paint and colours; in the primitive times red was most in use; whence Homer's ships were generally dignified with the titles of *μυλταπρωί*, and *φοινικταπρωί*, or "red faced;" the blue, likewise, or sky-colour, was frequently made use of, as bearing a strict resemblance to the colour of the sea; whence we find ships called by Homer *κυανοπρωί*, by Aristophanes *κυανισθοί*. Several other colours were also made use of; nor were they barely varnished over with them, but very often annealed by wax melted in the fire, so that neither the sun, winds, nor water, were able to deface them. The art of doing this was called from the wax *κερωστική*, from the fire *εκαυστική*, which is described by Vitruvius, and mentioned in Ovid.

—*Pisita coloribus ipsis*

Cæruleam matrem cœneava puppis habet.

The painted ship with melted wax anneal'd
Had Tethys for its deity——

In these colours the various forms of gods, animals, plants, &c. were usually drawn, which were likewise often added as ornaments to other parts of the ships, as plainly appears from the ancient monuments presented to the world by Baylus.

The sides of the prow were termed *πτερά*, or "wings," and *πτεριά*, according to Scheffer, or rather *πτερίαι*; for since the prow is commonly compared to a human face, it will naturally follow that the sides should be called *σώματα*. These are now called *δούρι* by our mariners.

1

History.

3. *Πρωά*, "the hind-deck or poop," sometimes called *οπίσθια*, the "tail," because the hindmost part of the ship; it was of a figure more inclining to round than the prow, the extremity of which was sharp, that it might cut the waters; it was also built higher than the prow, and was the place where the pilot sat to steer; the outer-bending part of it was called *επιστήσι*, answering to our term *quarter*.

They had various ornaments of sculpture on the prow; as helmets, animals, triumphal wreaths, &c.—The stern was more particularly adorned with wings, shields, &c. Sometimes a little mast was erected whereon to hang ribbands of divers colours, which served instead of a flag to distinguish the ship; and a weather-cock, to signify the part from whence the wind blew.

On the extremity of the prow was placed a round piece of wood, called the *πρωά*, from its bending; and sometimes *οφθαλμός*, the "eye" of the ship, because fixed in the fore-deck; on this was inscribed the name of the ship, which was usually taken from the figure painted on the flag. Hence comes the frequent mention of ships called *Pegasi*, *Scyllæ*, *bulls*, *rams*, *tigers*, &c. which the poets took the liberty to represent as living creatures that transported their riders from one country to another.

The whole fabric being completed, it was fortified with pitch, and sometimes a mixture of rosin, to secure the wood from the waters; whence it comes that Homer's ships are everywhere mentioned with the epithet of *μυλταπρωί*, or "black." Pitch was first used by the inhabitants of Phœacia, since called Corsica; sometimes wax was employed for the same purpose; whence Ovid,

Cærulea ceratas accipit unda rates.

The azure waves receive the waxed ships.

After all, the ship being bedecked with garlands and flowers, the mariners also adorned with crowns, she was launched into the sea with loud acclamations and other expressions of joy; and being purified by a priest with a lighted torch, an egg and brimstone, or after some other manner, was consecrated to the god whose image she bore.

The ships of war of the ancients were distinguished from other kinds of vessels by various turrets and accessions of building, some to defend their own soldiers, and others to annoy the enemy; and from one another, in latter ages, by several degrees or ranks of oars, the most usual number of which was four or five, which appear not to have been arranged, as some imagine, on the same level in different parts of the ship; nor yet, as others have supposed, directly above one another's heads; but their seats being placed one behind another, ascended gradually, like stairs. Ptolemy Philopater, urged by a vain-glorious desire of exceeding all the world besides in naval architecture, is said to have farther enlarged the number of banks to 40; and the ship being otherwise in equal proportion, this raised her to such an enormous bulk, that she appeared at a distance like a floating mountain or island; and, upon a nearer view, like a prodigious castle on the ocean. She was 285 cubits long, 38 broad, and 48 high (each cubit being 1 English foot 5½ inches), and carried 400 rowers, 400 sailors, and 3000 soldiers. Another which the

same

History. fame prince made to sail on the Nile, we are told, was half a stadium long. Yet there were nothing in comparison of Hiero's ship, built under the direction of Archimedes; on the structure of which Mofkion wrote a whole volume. There was wood enough employed in it to make 52 galleys; it had all the variety of apartments of a palace; such as banqueting-rooms, galleries, gardens, fish-ponds, stables, mills, baths, and a temple to Venus. The floors of the middle apartment were all inlaid, and represented in various colours the stories of Homer's Iliad. The ceilings, windows, and all other parts, were finished with wonderful art, and embellished with all kinds of ornaments. In the uppermost apartment there was a spacious gymnasium, or place for exercise, and water was conveyed to the garden by pipes, some of hardened clay, and others of lead. The floors of the temple of Venus were inlaid with agates and other precious stones; the inside lined with cypress wood; the windows adorned with ivory paintings and small statues. There was likewise a library. This vessel was adorned on all sides with fine paintings. It had 20 benches of oars, and was encompassed with an iron rampart, eight towers, with walls and bulwarks, furnished with machines of war, particularly one which threw a stone of 500 pounds, or a dart 12 cubits long, the space of half a mile, with many other particulars related by Athenæus. Caligula likewise built a vessel adorned with jewels in the poop, with sails of many colours, and furnished with large porticoes, bagnios, and banqueting-rooms, besides rows of vines, and fruit-trees of various kinds. But these, and all such monstrous fabrics, served only for show and ostentation, being rendered by their vast bulk unwieldy and unfit for service. Athenæus informs us, the common names they were known by, were *Cycloides*, or *Ætna*, i. e. "islands, or mountains," to which they seemed nearly equal in bigness; consisting, as some report, of as many materials as would have composed 50 triremes, or ships of three banks.

The vessels employed by the northern nations appear to have been still more imperfect than those of the Romans; for a law was enacted in the reign of the emperor Honorius, 24th September, A. D. 418, inflicting capital punishment on any who should instruct the barbarians in the art of ship-building; a proof at once of the great estimation in which this science was then held, and of the ignorance of the barbarians with regard to it.

The fleet of Richard I. of England, when he weighed anchor for the holy war from Messina, in Sicily, where he had passed the winter, A. D. 1190-1, is said to have consisted of 150 great ships and 53 galleys, besides barks, tartans, &c. What kinds of ships these were is not mentioned. To the crusades, however pernicious in other respects, this science seems to owe some improvements; and to this particular one we are indebted for Richard's marine code, commonly called the *Lawes of Oleron*, from the name of a small island on the coast of France, where he composed them, and which most of the nations in Europe have made the basis of their maritime regulations. Those ships, if they merited the name of ships, were probably very small, as we find that no long after as the time of Edward I. anno 1204, 40 men were deemed sufficient to man the best and largest vessels in England; and that Edward the Third, anno

1333, ordained the mayor and sheriffs of London to "take up all ships in their port, and all other ports in the Kingdom, of the burden of 40 tons and upwards, and to furnish the same with armed men and other necessaries of war, against the Scots his enemies, confederated with certain persons of foreign nations." Edward the Third's fleet before Calais, anno 1347, consisted of 728 English ships, carrying 14,936 mariners, being on an average but 20 men to each ship; 15 ships and 459 mariners, from Bayonne in Guienne, being 30 men to each ship; 7 ships and 184 men from Spain, which is 26 men to each ship; one from Ireland, carrying 27 men; 14 from Flanders, with 133 men, being scarcely 10 men to each ship; and one from Gueldenland, with 24 mariners. Fifteen of these were called the king's own ships, manned with 119 mariners, being somewhat under 17 to each ship.

Historians require not the vessels of Venice and Genoa as the largest and the best at this time, but they were soon exceeded in size by the Spanish vessels called *carrioles*, some of which carried cannon, and these again were exceeded by the vessels built by the northern people, particularly those belonging to the Hanse-towns.—In the 14th century, the Hanseatics were the sovereigns of the northern seas, as well without as within the Baltic; and their ships were so large, that foreign princes often hired them in their wars. According to H. K. Luyt, an English ship from Newcastle, of 200 tons burden, was seized in the Baltic by those of Wilmar and Rollock, anno 1304; and another English vessel of the same burden was violently seized in the port of Lisbon, anno 1412.

Soon after ships of a much larger size were constructed. It is mentioned that a very large ship was built, anno 1449, by John Taverner of Hull; and in the year 1455, King Henry IV. at the request of Charles king of Sweden, granted a licence for a Swedish ship of the burden of a thousand tons or under, laden with merchandize, and having 120 persons on board, to come to the ports of England, there to dispose of their lading, and to re-embark with English merchandize, paying the usual customs. The inscription on the tomb of William Canning, an eminent merchant, who had been five times mayor of Bristol, in Ratcliffe-church at Bristol, anno 1474, mentions his having forfeited the king's peace, for which he was condemned to pay 500 marks; in lieu of which sum, King Edward IV. took of him 2470 tons of shipping, amongst which there was one ship of 900 tons burden, another of 500 tons, and one of 400 tons, the rest being smaller.

In the year 1526, King James IV. of Scotland built the largest ship which had hitherto been seen, but which was lost in her way to France in the year 1512, owing probably to a defective construction, and the unwieldiness of the crew in managing so large a ship.—About this time a very large ship was likewise built in France. In the fleet fitted out by Henry VIII. anno 1512, there was one ship, the Regent, of 1000 tons burden; one of 500, and three of 400 each. A ship still larger than the Regent was built soon after, called *Henry Grace Dieu!* In the year 1522 the first voyage round the globe was finished.

The English naval historians think that ships carried cannon on their upper decks only, and had no gun-ports before the year 1515; and it is certain that many

History.

of the largest ships in former times were fitted out from harbours, where ships of a moderate size now would not have water enough to float them. In 1575 the whole of the royal navy did not exceed 24 ships, and the number of merchant-ships belonging to England amounted to no more than 135 vessels above 100 tons, and 636 between 40 and 100 tons. At Queen Elizabeth's death, anno 1603, there were not above four merchant-ships in England of 400 tons burden each.—The largest of Queen Elizabeth's ships of war was 1000 tons burden, carrying but 340 men, and 40 guns, and the smallest 600 tons, carrying 150 men and 30 guns. Smaller vessels were occasionally hired by her from private owners.

In the memorable sea-fight of Lepanto between the Turks and Christians, anno 1571, no vessels were employed but galleys; and it would appear from the carcasses of some of them, which are still preserved in the arsenal at Venice, that even these were not so large or so well constructed as those of our times. The invincible Armada, as Spanish vanity lyled it, once the terror and admiration of nations, in the pompous and exaggerated descriptions of which the Spanish authors of those times dwelt with so much apparent pleasure, consisted of 130 ships, near 100 of which were the themselves that had yet been seen on the ocean. The largest of these, however, would be no more than a third rate vessel in our navy, and they were so ill constructed, that they would neither move easily, sail near the wind, nor be properly worked in tempestuous weather. The whole of the naval force collected by Queen Elizabeth to oppose this formidable fleet, including hired vessels, tenders, store-ships, &c. amounted to no more than 143.

Ship-building began now to make a considerable progress in Britain. Both war and trade required an increase of shipping; so that, in the year 1679, the annual charge of the navy was reported to be 500,000*l.*; and in 1678 the navy consisted of 83 ships, of which 68 were of the line. At this time the exports amounted to ten millions per annum; and the balance of trade was two millions. In 1689 there were 173 ships, great and small, in the royal navy, and it has been constantly increasing; so that in 1761 the ships in the navy amounted to 372, of which 129 were of the line; and in the beginning of the year 1795, the total amount was above 430.

As ships of the common construction are found to be very defective in many particulars, various methods have therefore from time to time been proposed to remove some of the bad qualities they possessed. As it would be an endless task to enumerate the different inventions for this purpose, a few of them only will now be mentioned.

In 1663 Sir William Petty constructed a double ship, or rather a single ship with a double bottom, which was found to sail considerably faster than any of the ships

with which it had an opportunity of being tried. Her first voyage was from Dublin to Holyhead; and in her return "she turned into that narrow harbour against wind and tide, among rocks and ships, with such dexterity as many ancient seamen confessed they had never seen the like." This vessel with 70 more was lost in a dreadful tempest.

This subject was again revived by Mr Gordon, in his Principles of Naval Architecture, printed at Aberdeen anno 1784; where, having delivered his sentiments on Mr Gordon, the construction of large masts, he says: "These experiments likewise point out to us methods by which two vessels may be laterally connected together, though at a considerable distance from each other, in a manner sufficiently strong, with very little increase of weight or expence of materials, and without exposing much surface to the action or influence of the wind or the waves, or obstructing their motion in any considerable degree, and consequently without being much opposed by them on that account under any circumstances; and if vessels are judiciously constructed with a view to such a junction, it would be no easy matter to enumerate all the advantages that may be obtained by this means." He then enumerates the advantages that double vessels would have over those of the common construction. Soon after double ships were actually built by Mr Miller of Dalwhinton.

Another plan was proposed by Mr Gordon to make a ship sail fast, draw little water, and to keep a good wind. For this purpose, "the bottom (he says) should be formed quite flat, and the sides made to rise perpendicular from it, without any curvature; which would not only render her more steady, as being more opposed to the water in rolling, but likewise more convenient for stowage, &c. while the simplicity of the form would contribute greatly to the ease and expedition with which she might be fabricated. Though diminishing the draught of water is, *ceteris paribus*, undoubtedly the most effectual method of augmenting the velocity with which vessels go before the wind; yet, as it proportionally diminishes their hold of the water, it renders them extremely liable to be driven to leeward, and altogether incapable of keeping a good wind. This defect may, however, be remedied, in a simple and effectual manner, by proportionally augmenting the depth of keel, or, as so large a keel would be inconvenient on many accounts, proportionally increasing their number; as, in place of adding a keel eight feet deep to a vessel drawing six feet water, to affix to different parts of her flat bottom, which would be well adapted for receiving them, six different keels of two feet deep each at equal distances from each other, with proper intervals between which will be found equally effectual for preventing their pernicious effects. Four such, indeed, would have answered the purpose as well as the eight feet keel, were it not for the superior pressure or resistance of the lower water (A).

Thus

(A) It is frequently repeated on the authority of Mr Gordon and others. Theory says otherwise; and the experiments of Sir Isaac Newton show in the most unexceptionable manner, that the resistance of a ball descending through the water is the same at all depths; nay, the heaping up of the water on the bow, occasioning a hydrostatic pressure in addition to the real resistance, will make the whole resistance on an equal surface, but of greater horizontal dimensions, greater, because it bears a greater proportion to the resistance.

History. Thus then it appears, that a vessel drawing eight feet water only, keels and all, may be made to keep as good a wind, or be as little liable to be driven to leeward, as the sharpest built vessel of the same length drawing 14, nay 20 or upwards, if a few more keels are added, at the same time that the would be little more refilled in moving in the line of the keels than a vessel drawing six feet water only. These keels, besides, would strengthen the vessel considerably, would render her more steady, and less liable to be overfet, and thereby enable her to carry more fail; and Mr Gordon then enumerates the several advantages that a ship of this construction will possess.

12 The plan farther improved by the adoption of sliding keels. This plan has been put into execution by Captain Schank, with this difference only, that instead of the keels being fixed as proposed by Mr Gordon, Captain Schank constructed them so as to slide down to a certain depth below the bottom, or to be drawn up within the ship as occasion might require.

13 The utility of sliding keels proved by experiment. Captain Schank having communicated his plans to the Navy Board, two vessels were in consequence ordered to be built of 13 tons each, and similar in dimensions, one on the old construction, and the other flat-bottomed, with sliding keels. In 1795 a comparative trial in presence of the commissioners of the navy was made on the river Thames, each having the same quantity of fail; and although the vessel on the old construction had leechboards, a greater quantity of ballast, and two Thames pilots aboard, yet Captain Schank's vessel with three sliding keels beat the other vessel, to use the allotment of all present, one half of the whole distance sailed; and no doubt she would have beat her much more had she been furnished with a Thames pilot.

14 And advantage put in practice upon a larger scale. This trial gave so much satisfaction, that a king's cutter of 120 tons was immediately ordered to be built on the same construction, and Captain Schank was requested to superintend its building. This vessel was launched at Plymouth in 1791, and named the *Trial*. The length of this vessel is 66 feet, breadth 21 feet, and depth of the hold seven feet: her bottom is quite flat, and draws only six feet water, with all her guns, stores, &c. whereas all other vessels of her tonnage on the old construction draw 14 feet; so that she can go with safety into almost any harbour or creek. She has three sliding keels inclosed in a case or well; they are each 14 feet in length; the fore and the after keels are three feet broad each, and the middle keel is six feet broad. The keels are moveable by means of a winch, and may be let down seven feet below the real keel; and they work equally well in a storm as in still water. Her hold is divided in a several compartments, all water-tight, and so contrived, that should even a plank or two start at sea in different parts of the vessel, she may be navigated with the greatest security to any place. If she should be driven on shore in a gale of wind, she will not soon become a wreck, as her keels will be driven up into their cases, and the ship being flat-bottomed, will not be easily or ever; and being able to go into such shallow water, the crew may all be easily saved. By means of her sliding keel she is kept steady in the greatest gales: she is quite easy in a great sea, does not strike in the lead, and never takes in water on her deck; and when at a choir, she rides more upright and even than any other ship can do: she sails

very fast either before or upon a wind; no vessel she has ever been in company with, of equal size, has been able, upon many trials, to beat her in sailing; and yet her fails seem too small.

It has also been proposed to construct vessels of other materials than wood; and a vessel was built whole bottom, instead of being plank, was copper.

BOOK I. Containing the Method of Delineating the several Sections of a Ship.

CHAP. I. Of the Properties of Ships.

A SHIP ought to be constructed so as to answer the particular purpose for which she is intended. It would be an easy matter to determine the form of a ship intended to sail by means of oars; but, when sails are used, a ship is then act'd upon by two elements, the wind and water: and therefore it is much more difficult than is commonly imagined to ascertain the form of a ship so as to answer in an unfavourable as well as a favourable wind; the ship at the same time having a cargo of a certain weight and magnitude.

Every ship ought to sail well, but particularly when the wind is upon the beam; for this purpose a considerable length in proportion to the breadth is necessary, and the plane of resistance should be the least possible. The main frame should also be placed in a proper situation; but according to the experiments of Mr Chapman*, its place is variable with the velocity of the ship: the mean place of the main frame has, however, been generally estimated to be about one-twelfth of the length of the keel before the middle. Without a sufficient degree of stability a ship will not be able to carry a press of sail: a great breadth in proportion to the length and low upper-works will augment the stability. The following particulars being attended to, the above property will be gained, and the ship will also steer well. The wing transom should be carried pretty high; the fashion-pieces well formed, and not full below the load water-line: the lower part of the stem to be a portion of a circle, and to have a considerable rake; the sternpost to be nearly perpendicular to the keel; and all the upper works kept as low as possible.

Many ships from construction are liable to make much leeway. This may in a great measure be avoided by giving the ship a long keel, little breadth, and a considerable depth in the hold: whence the bow will meet with little resistance in comparison to the side, and therefore the ship will not fall much to the leeward.

Another very great retardation to the velocity of a ship is her pitching. The principal remedy for this is to increase the length of the keel and floor, to diminish the rising ribs and abaft, and to construct the hull in such a manner that the contents of the fore-body may be duly proportioned to the contents of the after-body.

In a ship of war the lower tier of guns ought to be of a sufficient height above the water, otherwise it will be impossible to work the lee-guns when it blows hard. This property will be obtained by giving her a long floor-timber, little rising, a full midship frame, light upper works, and the wing transom not too high. And the water in every ship the extreme breadth ought always to be higher afore and abaft than at midships.

Properties of Ships. 20
 Properties of a merchant ship, to take great cargo, and to have stability.

A merchant ship, besides being a fast sailer, ought to carry a considerable cargo in proportion to its length, to sail with little ballast, and to be navigated with few hands.

21
 22
 23

That a ship may take in a considerable cargo, it should have a great breadth and depth in proportion to its length, a full bottom, and a long and flat floor. But a ship of this construction will neither sail fast, nor carry much fail.

24
 25

If a ship be filled out much towards the line of flotation, together with low upper works, she will require little ballast: and that ship which is stiff from construction is much better adapted for sailing fast than one which, in order to carry the same quantity of canvas, is obliged to be loaded with a much greater weight: for the resistance is as the quantity of water to be removed, or nearly as the area of a transverse section of the immersed part of the body at the midship frame; and a body that is broad and shallow is much stiffer than one of the same capacity that is narrow and deep.

26
 27
 28

The advantages (says Mr Gordon) are numerous, important, and obvious. For it is evident, that by enlarging, perhaps doubling, the breadth of vessels, and forming their bottoms that are well furnished with keels, they must, in the first place, become much headier, roll little, if any, and be enabled to carry greatly more fail, and that in a better direction, at the same time that they would be in no danger of being dimasted or overset, unless the masts were of a most extraordinary height indeed. Secondly, they would have little or no occasion for ballast, and if any was used, could incur less danger from its shifting. Thirdly, That there would be much more room upon deck, as well as accommodation below; the breadth being so much increased without any diminution of the height above the load-water line. Fourthly, That they would deviate much less from the intended course, and penetrate the water much easier in the proper direction: for doubling the breadth, without any increase of weight, would diminish the depth or draught of water one half; and though the extent of the directly opposing surface would be the same as before, yet the vessel in moving would meet with half the former resistance only; for so great is the difference between the pressure, force, or reaction, of the upper and the under water. Fifthly, That they would by this means be adapted for lying unsupported in docks and harbours when dry, be rendered capable of being navigated in shallow water, and of being benefited by all the advantages attending that very important circumstance: and it is particularly to be observed, that making vessels which may be navigated in shallow water, may, in many respects, justly be regarded as a matter of equal importance with increasing the number of harbours, and improving them, as having identically the same effects with regard to navigation; at the same time, that the benefits which would result from such circumstances are obtained by this means without either expence, trouble, or inconvenience: besides, it would not only enable vessels to enter many rivers, bays, and creeks, formerly inaccessible to ships of burden, but to proceed to such places as are most landlocked, where they can lie or ride most secure, and with least expence of men and ground tackle. As ships of war would carry their guns well by being so

29
 30
 31
 32

Examples of Naval Architecture. 23
 Advantages of a ship of small draught of water.

Properties of Ships. 24
 25
 26
 27
 28
 29
 30
 31
 32

Ready, there could be but little occasion for a high topside, or much height of hull above water; and as little or no ballast would be required, there would be no necessity, as in other vessels, for increasing their weight on that account, and thereby pressing them deeper into the water. These are very important circumstances, and would contribute much to improve the sailing of such vessels." From whence it appears, that there would be united, what has hitherto been deemed irreconcilable, the greatest possible stability, which is nearly as the area of a transverse section of the immersed part of the body at the midship frame: and a body that is broad and shallow is much stiffer than one of the same capacity that is narrow and deep. A ship of this construction may take in a considerable cargo in proportion to her size; but if deeply loaded will not sail fast, for then the area of a section of the immersed part at the midship frame will be very considerable; and as the sails of such a ship must necessarily be large, more hands will therefore be required.

33
 34
 35
 36
 37
 38
 39
 40

The less the breadth of a ship, the fewer hands will be necessary to work her; as in that case the quantity of fail will be less, and the anchors also of less weight. We shall gain much (says Mr Bouguer) by making the extreme breadth no more than the fifth or sixth part of the length, if, at the same time, we diminish the depth proportionally; and likewise this most surprising circumstance, that by diminishing these two dimensions, or by increasing the length, a ship may be made to go sometimes as fast as the wind.

41
 42
 43
 44
 45
 46
 47
 48
 49
 50

In order to obtain the preceding properties, very opposite rules must be followed; and hence it appears to be impossible to construct a ship so as to be possessed of them all. The body, however, must be so formed, that as many of these properties may be retained as possible, always observing to give the preference to those which are most required. If it is known what particular trade the ship is to be employed in, those qualities are then principally to be adhered to which are most essentially necessary for that employment.

51
 52
 53
 54
 55
 56
 57
 58
 59
 60

It may easily be demonstrated that small ships do not have the same advantages as large ones of a similar form, when employed in the same trade: for a large ship will not only sail faster than a small one of a similar form, but will also require fewer hands to work her. Hence, in order that a small ship may possess the same advantages as a large one, the corresponding dimensions will not be proportional to each other. The reader will see in Chapman's *Archiectura Navalis Mercatoria* ample tables of the several dimensions of ships, of different classes and sizes, deduced from theory combined with experiment. Tables of the dimensions of the principal ships of the British navy, and of other ships, are contained in the Ship-builder's Repository, and in Murray's Treatise on Ship-building.

CHAP. II. Of the different Plans of a Ship.

WHEN it is proposed to build a ship, the proportional size of every part of her is to be laid down; from whence the form and dimensions of the timbers, and of every particular piece of wood that enters into the construction, is to be found. As a ship has length, breadth, and depth, three different plans at least are necessary to exhibit

Different Plans of a Ship exhibit the form of the several parts of a ship: these are usually denominated the *floor plan*, the *half breadth* and *body plan*.

The *floor plan* or *draught*, otherwise called the *plan of elevation*, is that section of the ship which is made by a vertical plane passing through the keel. Upon this plan are laid down the length of the keel; the height and rake of the stem and sternpost; the situation and height of the midship and other frames; the place of the masts and channels; the projection of the head and quarter gallery; and their appendages; and in a ship of war the position and dimensions of the gun-ports. Several imaginary lines, namely, the upper and lower height of breadth lines, water lines, &c. are also drawn in this plane.

The *half breadth* or *floor plan*, or, as it is frequently called the *horizontal plane*, contains the several half-breadths of every frame or timbers at different heights; ribbands, wavy lines, &c. are also described on this plane.

The *body plan*, or *plane of projection*, is a section of the ship at the midship frame or broadest place, perpendicular to the two former. The several breadths, and the particular form of every frame of timbers, are described on this plane. As the two sides of a ship are similar to each other, it is therefore unnecessary to lay down both; hence the frames contained between the main frame and the stem are described on one side of the middle line, commonly on the right hand side, and the after frames are described on the other side of that line.

Several lines are described on these planes, in order the more readily to assist in the formation of the timbers; the principal of which are the following:

The *top timber line*, is a curve limiting the height of the ship at each timber.

The *top-timber half breadth line*, is a section of the ship at the height of the top-timber line, perpendicular to the plane of elevation.

The *height of breadth lines*, are two lines named the *upper* and *lower* heights of breadth. These lines are described on the plane of elevation to determine the height of the broadest part of the ship at each timber; and being described in the body plan, limit the height and breadth of each frame at its broadest part.

Main half breadth, is a section of the ship at the broadest part, perpendicular to the floor plan, and represents the greatest breadth at the outside of every timber.

Water lines, are lines supposed to be described on the bottom of a ship when all at by the surface of water; and the uppermost of these lines, or that described by the water on the ship's bottom when sufficiently loaded, is called the *load water line*. According as the ship is lightened, it will rise higher out of the water; and hence new water lines will be formed. If the be lightened in such a manner that the keel may preserve the same inclination to the surface of the water, these lines will be parallel to each other; and if they are parallel to the keel, they will be represented by straight lines parallel to each other in the body plan; otherwise by curves. In the half breadth plan, these lines are curves limiting the half breadth of the ship at the height of the corresponding lines in the floor plan. In order to distinguish these lines, they are usually drawn in green.

Ribband lines, are curves on a ship's bottom by the intersection of a plane inclined to the plane of elevation; and are denominated *diagonal* or *horizontal*, according as they are measured upon the diagonal, or in a direction perpendicular to the plane of elevation. Both these answer to the same curve on the ship's bottom, but give very different curves when delineated on the half breadth plan.

Frames, are circular pieces of timber bolted together, and fitted upon the keel at certain distances, and to which the planks are fastened. A frame is composed of one floor-timber, two or three futtocks, and a top-timber on each side: which being united together, form a circular inclosure, and that which incloses the greatest space is called the *midship* or *main frame*. The arms of the floor-timber of this frame form a very obtuse angle; but in the other frames this angle decreases with the distance of the frame from midships. Those floor-timbers which form very acute angles are called *crutches*. The length of the midship floor-timber is in general about half the length of the main frame.

A frame of timbers is commonly formed by arches of circles called *sweps*. There are generally five sweeps; 1st, The *floor sweep*; which is limited by a line in the body plan perpendicular to the plane of elevation, a little above the keel; and the height of this line above the keel at the midship frame is called the *dead rising*. The upper part of this arch forms the head of the floor timber. 2^d, The *lower breadth sweep*; the centre of which is in the line representing the lower height of breadth. 3^d, The *rising sweep*. This sweep joins the two former, without intersecting either; and makes a fair curve from the lower height of breadth to the rising line. If a straight line is drawn from the upper edge of the keel to touch the back of the floor sweep, the form of the midship frame below the lower height of breadth will be obtained. 4th, The *upper breadth sweep*; the centre of which is in the line representing the upper height of breadth of the timber. This sweep described upwards forms the lower part of the top timber. 5th, The *top timber sweep* is that which forms the hollow of the top timber. This hollow is, however, very often formed by a mould, so placed as to touch the upper breadth sweep, and pass through the point limiting the half breadth of the top timber.

The main frame, or as it is usually called *dead-flat*, is denoted by the character \oplus . The timbers before dead-flat are marked A, B, C, &c. in order; and those abaft dead-flat by the figures 1, 2, 3, &c. The timbers adjacent to dead-flat, and of the same dimensions nearly, are distinguished by the characters (A), (B), &c. and (1), (2), &c. That part of the ship abaft the main frame is called the *after body*; and that before it the *fore body*.

All timbers are perpendicular to the half breadth plan. Those timbers whose planes are perpendicular to the floor plan, are called *square timbers*; and those whose planes are inclined to it are called *raked timbers*.

The *rising line*, is a curve drawn in the floor plan, at the heights of the centres of the floor sweeps in the body plan. As, however, this line, if drawn in this manner, would extend beyond the upper line of the figure, it is therefore usually drawn that its lower part may touch the upper edge of the keel. This is performed by taking the heights of each of the centres in

Different Plans of a Ship.

Plan of a floor timber, futtocks, and top-timber.

Sweps of the several parts of a frame.

Name of frames.

the body plan, from the height of the centre of the sweep of dead-flat, and setting them off on the corresponding timbers in the sheer plan from the upper edge of the keel.

Half breadth of the ribs, is a curve in the floor plan, which limits the distances of the centres of the floor sweeps from the middle line of the body plan.

The rising of the floor, is a curve drawn in the sheer plan, at the height of the ends of the floor timbers. It is limited at the main frame or dead flat by the dead rising, and in flat ships is nearly parallel to the keel for some timbers above and about the midship frame; for which reason these timbers are called *flats*: but in sharp ships it rises gradually from the main frame, and ends on the stem and post.

Cutting-down line, is a curve drawn on the plane of elevation. It limits the depth of every floor timber at the middle line, and also the height of the upper part of the dead wood above and a mast.

Timber and room, or room and space, is the distance between the moulding edges of two timbers, which must always contain the breadth of two timbers and an interval of about two or three inches between them. In forming the timbers, one mould leaves for two, the fore-side of the one being supposed to unite with the aft-side of the other, and to make only one line, which is called the *joint of the timbers*.

In order to illustrate the above, and to explain more particularly the principal pieces that compose a ship, it will be necessary to give a description of them. These pieces are for the most part represented according to the order of their disposition in fig. 1.

A. Represents the pieces of the keel to be securely bolted together and clinched.

B. The sternpost, which is tenanted into the keel, and connected to it by the knee G.

E. The back of the post, which is also tenanted into the keel, and securely bolted to the post; the intention of it is to give sufficient breadth to the post, which seldom can be got broad enough in one piece. C is the false post, which is fayed (B) to the fore part of the stem, &c.

C. The stem, in two pieces, to be scarfed together. The stem is joined to the fore foot, which makes a part of the bow.

H. The apron, in two pieces, to be scarfed together, and fixed on the inside of the stem, to support the scarf there; and therefore the scarf of the apron must be at some distance from that of the stem.

I. The stemion, in two pieces, to support the scarf of the apron.

D. The beams which support the decks; and F the knees by which the beams are fastened to the sides of the ship.

K. The wing transom: it is fayed across the sternpost, and fitted to the head of it, and its extremities are fastened to the fashion pieces. L. Is the deck transom, parallel to the wing transom. M. N. Two of the lower transoms: these are fastened to the sternpost and stem in the same manner as the wing transom. O. The knee which fastens the transom to the ship's

side. And, P. The fashion piece, of which there is one on each side. The keel of the fashion piece is connected with the dead-wood, and the head is fastened to the wing transom.

Difference
Plan of a
Ship.

R. S. Breat-holes: these are fayed in the inside to the stem, and to the bow on each side of it, to which they are fastened with proper bolts. There are generally four or five in the hold, in the form of that marked R, and one in the form of that marked S, into which the lower deck planks are rabbeted: There is also one imbedded under the insole holes, and another under the second deck.

T. The rudder, which is joined to the sternpost by the rudder iron, upon which it turns round in the goings, fastened to the sternpost for that purpose. There is a mortise cut in the head of the rudder, into which a long bar is fitted called the *tiller*, and by which the rudder is turned.

U. A floor timber: it is laid across the keel, to which it is fastened by a bolt through the middle. V, V, V, V. The lower, the second, third, and fourth futtocks. W, W. The top timbers. These represent the length and scarf of the several timbers in the midship frame.

X. The pieces which compose the kelson. They are scarfed together in the same manner as the keel, and placed over the middle of the floor timbers, being scored about an inch and a half down upon each side of them, as represented in the figure.

Y. The several pieces of the knee of the head; the lower part of which is fayed to the stem, and its keel is scarfed to the head of the forefoot. It is fastened to the bow by two knees, called *checks*, in the form of that represented by Z; and to the stem, by a knee called a *standard*, in the form of that marked @.

a. The cathead, of which there is one on each side of the bow, projecting so far as to keep the anchor clear of the ship when it is hove up.

b. The bits, to which the cable is fastened when the ship is at anchor.

c. The side counter-timbers, which terminate the ship about within the quarter gallery.

e, e. Two pieces of dead wood, one afore and the other abaft, fayed on the keel.

Fig. 2. is a perfective representation of a ship framed and ready for the planking; in which A, A is the keel; B, the sternpost; C, the stem; K, L, M, the transoms; F, F, F, F, F, the ribsands.

CHAP. III. Containing Preliminary Problems, &c.

THE general dimensions of a ship are the *length*, *breadth*, and *depth*.

To ascertain those dimensions that will best answer the intended purpose is, no doubt, a problem of considerable difficulty; and, from theory, it may be shown that there are no determinate proportions subsisting between the length, breadth, and depth, by which these dimensions may be settled; yet, by combining theory and practice, the proportional dimensions may be approximated to pretty nearly.

55
Proportional dimensions
of a ship
to be determined
by theory
combined
with practice;

(n) To say, is to join two pieces of timber close together.

Preliminary Problems. As ships are constructed for a variety of different purposes, their principal dimensions must therefore be altered accordingly, in order to adapt them as nearly as possible to the proposed intention; but since there is no fixed standard whereby to regulate these dimensions, the methods therefore introduced are numerous, and in a great measure depend upon custom and fancy.

With regard, however, to the proportional dimensions, they perhaps may be inferred from the circle. Thus, if the extreme breadth be made equal to the diameter, the length at the load water line, or the distance between the rabbets of the stem and post at that place, may be made equal to the circumference of the same circle; and the depth of the hold equal to the radius, the upper works being continued upwards according to circumstances. A ship formed from these dimensions, with a bottom more or less full according as may be judged necessary, will no doubt answer the proposed intention. Nevertheless, one or other of these dimensions may be varied in order to gain some essential property, which the trade that the vessel is intended for may require.

The following hints are given by Mr Hutchinsoⁿ * towards fixing rules for the best construction of ships bottoms.

1. "I would recommend (says he), to prevent ships bottoms from hogging & upwards amiddhip, to have the fore and after part of their keels deep enough, that the upper part may be made to admit a rabbet for the garboard streak, that the main body and bearing part of the ships bottoms may be made to form an arch downwards in their length, suppoie with the same rise as their bends, at the rate of about 2 inches for every 30 feet of the extreme length of the keel towards the midship or main frame, which may be reckoned the crown of the arch; and the lower part of the keel to be made straight, but laid upon blocks so that it may form a regular convex curve downwards at the rate of an inch for every 30 feet of the extreme length of the keel, the lowest part exactly under the main frame; which curve, I reckon, is only a sufficient allowance for the keel to become straight below, after they are launched afloat, by the pressure of the water upward against their floors amiddhip, which causes their tendency to hog. And certainly a straight keel is a great advantage in sailing, as well as to support them when laid upon level ground or on straight blocks in a repairing dock, without taking damage.

2. "As square sterned ships, from experience, are found to answer all trades and purposes better than round or pink sterned ships, I would recommend the fore part of the sternpost, on account of drawing the water lines in the draught, only to have a few inches rake, that the after part may stand quite upright perpendicular to the keel; and for the rake of the stem I would propose the rabbet for the hudding ends for the entrance, and bows from the keel upwards, to form the same curve as the water line from the stem at the garpin towards the main head, and the bows at the garpin to be formed by a sweep of a circle of half the three-fourths of the main breadth; and the main transom to be three-fourths of the main breadth; and the buttocks, at the load or fullow mark, to be beyond, in the same number as the bows at the garpin, with a sweep of a circle of half the three-fourths of the main breadth, to

extend just as far from the stem and stern post as to admit a regular convex curve to the main frame, and from thence down to the keel to form regular convex water-lines, without any of those unnatural, hollow, concave ones, either in the entrance or run; which rules, in my opinion, will agree with the main body of the ship, whether the is designed to be built full for burden or sharp below for sailing.

3. "This rule for raking the stem will admit all the water-lines in the ship's entrance to form convex curves all the way from the stem to the midship or main frame, which answers much better for sailing as well as making a ship more easy and lively in bad weather. And the bows should flange off, rounding in a circular form from the bends up to the gunwale, in order to meet the main breadth the sooner, with a sweep of half the main breadth at the gunwale amiddhips; which will not only prevent them greatly from being plunged under water in bad weather, but spread the standing fore-rigging the more, to support these material masts and sails forward to much greater advantage than in those over sharp bowed ships, as has been mentioned. And as the sailing trim of ships in general is more or less by the stem, this makes the water lines of the entrance in proportion the sharper to divide the particles of water the easier, so that the ship may pass through it with the least resistance.

4. "The run ought to be formed shorter or longer, fuller or sharper, in proportion to the entrance and main body, as the ship is designed for burden or sailing fast. The convex curves of the water lines should lessen gradually from the load or sailing mark aft, as has been mentioned, downwards, till a fair straight taper is formed from the after part of the floor to the sternpost below, without any concavity in the water lines; which will not only add buoyancy and burden to the after body and run of the ship, but, in my opinion, will help both her sailing and steering motions; for the pressure of the water, as it closes and rises upon it to come to its level again, and fill up that hollow which is made by the fore and main body being pressed forward with sail, will imbringe, and act with more power to help the ship forward in her progressive motion, than upon those unnatural concave runs, which have so much more flat dead wood, that must, in proportion, be a hindrance to the stern being turned so easily by the power of the keel to steer the ship to the greatest advantage."

Many and various are the methods which are employed to describe the several parts of a ship. In the following problems, however, those methods only are given which appear to be most easily applied to practice, and which, at the same time, will answer any proposed purpose.

PROBLEM I. To describe in the plane of elevation the sheer or curvature of the top timbers.

Let QR (Fig 3.) be the length of the ship between the wing transom and the rabbet of the stem. Then, since it is generally agreed, especially by the French constructors, that the broadest part of the ship ought to be about one-twelfth of the length before the main frame or dead flat; therefore make H⊙ equal to five-sixths of the length QR, and ⊙ will be the station of the main frame; and from the other frames on the keel, and from these points let perpendiculars be drawn to the keel, and let ⊙P be the height of the ship at the main transom.

Pr. timber problems.
The height of the fore-body to the top-timber line.

VF the height at the aftermoft frame, and RK the height at the stem. Through P draw EPL parallel to the keel; describe the quadrants PGI, PMN, the radius being P⊕; make PH equal to EF, and PO equal KL, and draw the parallels GH, OM: Divide GH fimilar to ⊕C, and OM fimilar to ⊕B. Through thefe points of divifion draw lines perpendicular to EL, and the feveral portions of thefe perpendiculars contained between EL and the arch will be the rifings of the top-timber line above EL. A curve drawn through thefe points will form the top-timber line.

This line is more eafily drawn by means of a curved or bent ruler, fo placed that it may touch the three points E, P, and K.

PRON. II. To defcribe the ftem.

Let K (fig. 3.) be the upper part of the ftem, through which draw KS parallel to the keel, and equal to twice KR: Through the termination of the wales on the ftem draw TW parallel to QR. Then from the centre S, with the diftance SK, describe an arch: Take an extent equal to the nearest diftance between the parallels WT, QR; and find the point W, fuch that one point of the compafs being placed there, the other point will touch thefe parallels: and from this point W, and from this point as a centre describe an arch until it meets the keel, and the ftem will be formed.

PRON. III. To defcribe the fternpoft.

Set off QV (fig. 2) for the rake of the poft: draw VX perpendicular to the keel, and equal to the height of the wing tranfom, join QX, and it will represent the aft fide of the poft.

PRON. IV. To defcribe the half breadth line.

Let MN (fig. 4.) be the given length: Make N⊕ equal to five-twelfths of MN; draw the line ⊕P perpendicular to MN, and equal to the propofed extreme half breadth. Let ME be the round aft of the ftem or wing tranfom; make EO perpendicular to MN, and equal to the given half breadth at the ftem, which is generally between two-thirds and three-fourths of the main half breadth; and defcribe the arch MO, the centre of which is in the middle line. Space the frames (A), A, B, &c. and (1), 1, 2, &c. From the centre ⊕, with the radius ⊕P, describe the quadrant PRS; describe alfo the quadrant PCT. Through the point O draw ORU parallel to MN; divide the ftraight line RU fimilar to M⊕; and through thefe points of divifion draw lines perpendicular to MN, and meeting the arch. Transfer thefe lines to the correspondent frames each to each, and a curve drawn through the extremities will represent that part of the fide contained between the main frame and the ftem. Again, through O, the extremity of the foremoft frame, draw QV parallel to MN. Or make PV a fourth or third part of PU, according as it is intended to make the fhip more or lefs full towards the bow. Divide VC fimilar to ⊕C: through thefe points draw lines perpendicular to MN, and terminating in the quadrantal arch: Transfer thefe lines to the corresponding timbers in the fore part, and a curve drawn through the extreme points will limit that part of the fhip's fide contained between P and Q. Continue the curve to the next timber at X. From O draw OZ perpendicular to QX; make the angle ZNQ equal to ZQN, and the point Z will be the centre of the arch forming the bow. Remark,

if it is propofed that the breadth of the fhip at the frames Preintimber adjacent to the main frame fhall be equal to the breadth at the main frame; in this cafe, the centres of the quadrantal arches will be at the points of interfection of thefe frames with the line MN; namely, at (A) and (1). Alfo, if the height of the fhip at the frames (A) and (1) is to be the fame as at dead flat, the quadrantal arches in fig. 3. are to be defcribed from the points of interfection of thefe frames with the line EL.

Thefe rules, it is evident, are variable at pleafure; and any perfon acquainted with the firft principles of mathematics may apply calculation to find the radii of the feveral fweeps.

PRON. V. To defcribe the main frame or dead flat.

This frame is that which contains the greateft fpace, and the particular form of each of the other frames depends very much on it. If the fhip is intended to carry a great burden in proportion to her principal dimenfions, this frame is made very full; but if it is intended to fail faft, it is ufually made fharp. Hence arifes diversity of opinions refpecting its form; each contructor ufing that which to him appears preferable. In order to fave repetition, it is judged proper to explain certain operations which neceffarily arife in to all the different methods of contructing this frame.

In the plan of the upper fide of the keel produced, draw the line AB (fig. 5.) equal to the propofed breadth of the fhip; bifect AB in C, and draw AL, CL, and LE, perpendicular to AB. Then, fince the two fides of a fhip are fimilar, it is the eafieft thought fufficient to defcribe the half of each frame between the main frame and the ftem on one fide of the middle line CE, and the half of each of thofe before the main frame on the other fide of it. The firft half is called the after-body, and the other the fore-body. The after-body is commonly defcribed on the left fide of the middle line; and the fore-body on the right fide of it: hence the line AD is called the *feeling line* of the after body, and BF the fide line of the fore body. Make AD and BF each equal to the height of the fhip at the main frame. Make AG, BG, and AH, BH, equal to the lower and upper heights of frames refpectively, taken from the fteer plan. Let IH be the load water line, or line of flotation when the fhip is loaded, and KK the height of the rifing line of the floor at this frame. Make CN, CO, each equal to half the length of the floor timber, and N, O, will be the heads of the floor timber, through which draw perpendiculars to AB. Make Cm, Em, each equal to half the thicknefs of the fternpoft, and Cn, En, equal to half the thicknefs of the ftem, and join mn, nn.

Method I. Of defcribing a main frame.—From the centre a (fig. 6.) in the lower breadth line, defcribe the lower breadth fweep Gae, make Nb equal to the propofed radius of the floor fweep, and from the centre b defcribe the floor fweep Nfb. Let the radius of the reconciling fweep be Ag, equal to about the half of AC; then make Ah equal to Nb, and Am equal to Ga. Now from the centre a, with an extent equal to gm, defcribe an arch, and from the centre b, with the extent gh, defcribe an arch interfecing the former in c, which will be the centre of the reconciling fweep ef. Join Nm by an inverted curve, the centre of which may be in the line bN produced downwards; or it may be joined

40
Main ftem
Fig. 3.

41
aft part
Fig. 2.

42
Main half
breadth
line.
Fig. 4.

43
Of the mid-
dle frame.

44
Of the keel
line
Fig. 5.

Preliminary Problems. joined by two curves, or by a straight line if there is little rising; and hence the lower part of the main frame will be described.

Preliminary Problems.

In order to form the top timber, make Fk equal to such part of the half breadth, agreeable to the proposed round of the side, as one-seventh; join Hk , and make ki equal to about two-thirds of Hk : make the angle Hil equal to iHl ; and from the centre l at the distance lH describe the arch Hil ; and from the centre o , the intersection of li , and kF produced, describe the arch ik , and the top timber will be formed.

II. To describe a main frame of an intermediate capacity, that is, neither too flat nor too sharp.—Divide the line AX (fig. 6), which limits the head of the floor timber, into three equal parts; and make ab equal to one of them. Divide the line dB , the perpendicular distance between the load water line and the plane of the upper side of the keel, into seven equal parts; and set off one of these parts from d to c , and from c to m . Let GH be the lower deck, join Gm , and produce it to g . Draw the straight line Va , bisect it in n , and from the points n, a , describe arches with the radius Gg intersecting each other in P , which will be the centre of the arch na . The centre of the arch Vn is found by describing arches downwards with the same radius.

Fig. 6.

With an extent equal to once and a half of Be , describe arches from the points b, e , intersecting each other in A , and from this point as a centre describe the arch eb ; make al equal to dm , and join As, Al . Then, in order to reconcile two arches so as to make a fair curve, the centres of these arches and of the points of contact must be in the same straight line. Hence the point k will be the centre of the arch dm , and o the centre of the arch al . The arch lm is described from the centre A .

To form the top timber, set back the tenth part of the half breadth from K to S upon the line of the second deck; then with an extent equal to two-thirds of the whole breadth describe an arch through the points S and H , the upper height of breadth. Again, make MI equal to the fifth part of the half breadth: describe an arch of a circle through the points S and T , taking the diagonal GB for the radius. As this arch is inverted in respect of the arch dS , the centre will be without the figure. Hence one-half of the main frame is formed, and the other half is described by similar operations.

Remark. This frame may be made more or less full by altering the several radii.

III. To describe a main frame of a circular form.—

Let the several lines be drawn as before: Then make Oa (fig. 7.) equal to the half breadth Ga , and from the centre a , with the radius Ga , describe the arch $bGcO$. Let d be the head of the floor-timber, and dx the rising. Assume the point f in the arch, according to the proposed round of the second futtock, and describe the arch df ; the centre of which may be found as in the former method: from the centre a , with the distance ad , describe the arch dco ; make dc equal to one-third of dO , and the angle dch equal to cdh , and from the centre h describe the arch dc . The inverted arch cO may be described as before.

IV. To describe a very full main frame.—

Let the vertical and horizontal lines be drawn as before: let b , fig. 8. be the floor-head, and bx the rising. Divide Gc

Plate Ccccxxxvii. Fig. 7.

Fig. 8.

into two equal parts in the point u , and upon cd describe the square $dbac$, in which inscribe the quadrant dca . Divide the line bd into any number of equal parts in the points O, N, M, L , and draw the lines Lm, Me, Nn, Ob , perpendicular to db . Divide the line Gc , the depth of the hold, the rising being deducted, into the same number of equal parts in the points E, F, I, K , and make the lines Ee, Ff, Ir, Kk , in the frame, equal to the lines Ob, Nn, Me, Lm , in the square, each to each respectively; and through the points G, p, q, r, s, b , describe a curve. The remaining part of the frame may be described by the preceding methods.

V. To describe the main frame of a ship intended to be a fast sailer.—

The principal lines being drawn as before, let the length of the floor-timber be equal to half the breadth of the ship, and the rising one-fifth or one-sixth of the whole length of the floor-timber, which lay off from x to E , fig. 9. Through the point E draw the line Tx perpendicular to GC , and dE perpendicular to AG . Join Td , which bisect in B , and draw BF perpendicular thereto, and meeting CG produced in F , from the centre F , at the distance Ff , describe the semicircle TdD . Divide GT into any number of parts, VW , &c. and bisect the intervals DV, DW , &c. in the points X, Z , &c.; then, from the centre X , with the extent XV , describe the semicircle DbY , intersecting AG in b . Let VP be drawn perpendicular to GT , and bP perpendicular to AG , and the point of intersection P will be one point through which the curve is to pass. In like manner proceed for the others, and a curve drawn through all the points of intersection will be part of the curve of the main frame. The remaining part of the curve from E to Y will be composed of two arches, the one to reconcile with the former part of the curve at E , and the other to pass through the point Y , the centre of which may be found by any of the preceding methods. In order to find the centre of that which joins with the curve at E , make TR equal to the half of GD , and join ER , in which a proper centre for this arch may be easily found.

The portion Gbe of the curve is a parabola, whose vertex is G and parameter GD .

For $GD : Gb :: Gb : GV$ by construction.

Hence $DG \times GV = Gb^2$, which is the equation for a parabola.

VI. To describe a main frame of a midding capacity.—

Let the length of the floor-timber be equal to one-half of the breadth of the ship. Make Od , fig. 10. equal to one-fourth of the length of the floor-timber, and draw the perpendicular dc equal to the rising, and divide it into two equal parts in the point e . Describe an arch through e , and the extremity a of the floor-timber, the radius being equal to the half breadth, or more or less according to the proposed round of the floor-head. Then with the radius Ol , half the length of the floor-timber, describe the arch eY .

Draw lm perpendicular to OA : bisect An in p , and draw the perpendicular pq . From the middle of Ap draw the perpendicular rs , and from the middle of Ar draw the perpendicular tu . Make nx, py , each equal to ln : make the distances py, rv , each equal to ag : rF, tE , each equal to ab ; and tx equal to aE . The curve drawn through the points a, s, y, F, x, T , will form the under part of the midding frame.

We shall finish these methods of describing the main frame

frame of a ship with the following remark from M. Vidal du Cluisois: "It seems (says he) that they have affected to avoid straight lines in naval architecture; yet, geometrically speaking, it appears that a main frame formed of straight lines will have both the advantage and simplicity over others." To illustrate this, draw the straight line MN (fig. 9.) in such a manner that the inclined piece Ma may be equal to the vertical piece DNY. Hence the capacity of the main frame formed by the straight lines MN, NY will be equal to that of the frame formed by the curve Ma DNY; and the frame formed by the straight lines will for the most part be always more susceptible of receiving a load that will easily divide the fluid. It is also evident, that the cargo or ballast, being lower in the frame formed of straight lines than in the other, it will therefore be more advantageously placed, and will enable the ship to carry more sail (fig. 10) that having a how equally well or better formed, the will fall faster.

PROB. VI. To describe a stern having a square tuck. Let AB (fig. 11.) be the middle line of the poit, and let CD be drawn parallel thereto at a distance equal to half the thickness of the poit. Make CE equal to the height of the lower part of the fashion-piece above the keel: make CF equal to the height of the extremity G of the transom above the plane of the keel produced, and CH equal to the height of the transom on the poit, HT being equal to above one-ninth or one-tenth of GT, and describe the arch GH, the centre of which will be in BA produced: make EK equal to five-twelfths of ET: through K draw KL perpendicular to CD, and equal to EK; and with an extent equal to EL describe the arch EL. Make GI equal to the half of ET, and from the centre I describe the arch GM, and draw the reconciling curve ML.—Let the curve of the fashion-piece be produced upwards to the point representing the upper height of breadth as at O. Make ON equal to the height of the top-timber, and BN equal to the half breadth at that place, and join ON. Through N and the upper part of the counter, let arches be described parallel to GH. The taffarel, windows, and remaining part of the stern, may be finished agreeable to the fancy of the artist.

In fig. 12. the projection of the item on the plane of elevation is laid down, the method of doing which is obvious from inspection.

If the transom is to round aft, then since the fashion-pieces are always filed straight, their planes will intersect the sheer and floor planes in a straight line. Let Gg (fig. 14.) be the intersection of the plane of the fashion-piece with the floor plane. From the point g draw gW perpendicular to gM: make yg equal to the height of the tuck, and Wk being joined will be the intersection of the plane of the fashion-piece with the sheer plane. Let the water lines in the sheer plane produced meet the line kW in the points a, s, h , and draw the perpendiculars $aa', \beta\beta', hh'$. From the points a, s, h (fig. 14.) draw lines parallel to Gg to intersect each corresponding water line in the floor plane in the points 3, 2, 1.

From the points G, 3, 2, 1, in the floor-plane draw lines perpendicular to gM, intersecting the water lines (fig. 13.) in the points G, 3, 2, 1; and through these points describe the curve G 3 2 1 k; and WG 3 2, 1 k will be the projection of the plane of the fashion-piece on the sheer plane. Through the points G, 3, 2, 1 (fig. 13.) draw the lines GF, 3 A, 2 S, 1 H, perpendicular to Wk; and make the lines WF, a A, s S, h H, equal to the lines g G, a 3, s 2, h 1 (fig. 14.) respectively, and WFASH k will be the true form of the plane of the aft side of the fashion-piece. When it is in its proper position, the line WT will be in the same plane with the sheer line; the line a A in the same plane with the water line s 3; the line s S in the same plane with the water line s 2; and the line h H in the same plane with the water line h 1. If lines be drawn from the several points of intersection of the water lines with the rabbet of the port (fig. 13.), perpendicular to g M, and curved lines being drawn from these points to G, 3, 2, 1 (fig. 14.) respectively, will give the form and dimensions of the tuck at the several water lines.

PROB. VII. To bevel the fashion-piece of a square tuck by water-lines.

As the fashion-piece both takes and cants, the planes of the water-lines will therefore intersect it higher on the aft than on the fore-side: but before the heights on the fore-side can be found, the breadth of the timber must be determined; which let be bn (fig. 15.). Then, as it cants, the breadth in the direction of the water-line will exceed the true breadth. In order to find the true breadth, form the aft-side of the fashion-piece as directed in the last problem.

Let $r s$ (fig. 13.) be the aft-side of the rabbet on the outside of the poit, WM the common section of the plan of the fashion-piece and the sheer-plan. Before this last line can be determined, the several water-lines 1, 2, 3, 4, and 5, must be drawn parallel to the keel, which may represent to many transoms.—Let these water-lines be formed and ended at the aft-side of the rabbet, as in fig. 14. where the rounds aft of the several transoms are described, limiting the curves of the water-lines. Now the line WM must make so as to leave room for half the thickness of the poit, at the tuck: in order to which, produce Wg to r; make rg half the thickness of the poit; through r draw a line parallel to g M to intersect g G in b; then with the radius r h, from x the point of the tuck as a centre, describe an arch, and draw the line WM just to touch the back of that arch.

The line WM being drawn, let any point k in it be assumed at pleasure: from k draw ky perpendicular to g M: through y draw yf (fig. 14.) parallel to g G, intersecting the line Mf drawn perpendicular to g M in the point f. From M draw Mi perpendicular to yf, and from y draw yn perpendicular to WM (fig. 13.). Make Mn (fig. 15.) equal to M i (fig. 14.); then Mi (fig. 15.) being equal to yk (fig. 13.), join n i, and the angle i n M will be the beveling to the horizontal plane. Again, make M s, M f (fig. 15.) respectively equal to y n (fig. 13.) and M f (fig. 14.), and join s f; and

(c) It is not a general rule, that lowering the cargo of a ship augments her stability. This is demonstrated by the Chevalier de Borda, in a work published by M. de Gouinny upon this subject. See also *L'Architecture Navale par M. Vidal du Cluisois*, p. 23.

Preceding will the angle Mef will be the bevelling to the floor-plane.

The bevelling being now found, draw the line ab (fig. 15.) parallel to sn , ax or bn being the scantling of the timber. Then nx will be the breadth of the timber on the horizontal plane, and xe its breadth on the floor-plane, and ae what it is within a square.

Now as the lines gG , a , 3 , s , 2 , h , 1 , y , represent the aft-side of the fashion-piece on the horizontal plane (fig. 14.), dotted lines may be drawn parallel to them to represent the fore-side, making nx (fig. 15.) the perpendicular distance between the lines representing fore and aft sides of the fashion-piece. By these lines form the fore-side of the fashion-piece in the same manner as the aft-side was formed. The water-lines on the fore-side of the plane of the fashion-piece must, however, be first drawn in fig. 13. thus: Draw the lines eb , ed parallel to WM , and whose perpendicular distances therefrom may be equal to ac and ae (fig. 15.) respectively. Draw a line parallel to aA through the point where the line ed intersects the fifth water-line. Draw a line parallel to aA through the point where the fourth water-line intersects the line ed ; in like manner proceed with the other water-lines. The fore-side of the fashion-piece is now to be described by means of these new water-lines, observing that the distances in the floor-plane must be set off from the line eb , and not from WM , as in the former case; and a curve described through the points 1 , 3 , 2 , 1 , where these distances reach to, will represent the fore-side of the fashion-piece.

The nearest distance between the points 5 , 3 , 2 , 1 and the aft side of the fashion-piece is what the bevelling is beyond the square when both stock and tongue of the beam are perpendicular to the timber. Make Mp (fig. 16.) equal to the breadth of the timber, and M 5 equal to the perpendicular distance of the point 5 (fig. 13.) from the aft-side of the fashion-piece, and join $5p$. In like manner proceed with the others, and the bevellings at these parts will be obtained; but, in order to avoid confusion, the perpendiculars 4 , 3 , 2 (fig. 15.), instead of being laid off from M (fig. 16.), were set off from points as far below M as the other extremities of the lines drawn from these points are below the point p .

PROB. VIII. To describe the transoms of a round poop.

The transoms are fastened to the stern-post in the same manner that the floor-timbers are fastened to the keel, and have a rising called the *flight* similar to the rising of the floor-timbers. The upper transom is called the wing transom, the next the deck transom, and the others the *first*, *second*, and *third* transoms in order. The wing transom has a round aft and a round up; the round up of the deck transom is the same as that of the beams.

The fashion-piece of a square tuck must be first described, together with the three adjacent frames, by the method to be explained. The part of the stern above the wing transom is to be described in the same manner as before, and may therefore be omitted in this place. The part below the keel of the fashion-piece is also the same in both cases. Let fig. 17. represent the fashion-piece of a square tuck, and the three adjoining frames. Divide the interval AB into four equal parts in the points C , D , E , and draw the perpendiculars AF , CG ,

DH , EI , and BK ; these will be the positions of water-lines P , Q , R , S , T , U , V , W , X , Y , Z , AA , BB , CC , DD , EE , FF , GG , HH , II , JJ , KK , LL , MM , NN , OO , PP , QQ , RR , SS , TT , UU , VV , WW , XX , YY , ZZ , AAA , BBB , CCC , DDD , EEE , FFF , GGG , HHH , III , JJJ , KKK , LLL , MMM , NNN , OOO , PPP , QQQ , RRR , SSS , TTT , UUU , VVV , WWW , XXX , YYY , ZZZ , AAA , BBB , CCC , DDD , EEE , FFF , GGG , HHH , III , JJJ , KKK , LLL , MMM , NNN , OOO , PPP , QQQ , RRR , SSS , TTT , UUU , VVV , WWW , XXX , YYY , ZZZ , AAA , BBB , CCC , DDD , EEE , FFF , GGG , HHH , III , JJJ , KKK , LLL , MMM , NNN , OOO , PPP , QQQ , RRR , SSS , TTT , UUU , VVV , WWW , XXX , YYY , ZZZ , AAA , BBB , CCC , DDD , EEE , FFF , GGG , HHH , III , JJJ , KKK , LLL , MMM , NNN , OOO , PPP , QQQ , RRR , SSS , TTT , UUU , VVV , WWW , XXX , YYY , ZZZ , AAA , BBB , CCC , DDD , EEE , FFF , GGG , HHH , III , JJJ , KKK , LLL , MMM , NNN , OOO , PPP , QQQ , RRR , SSS , TTT , UUU , VVV , WWW , XXX , YYY , ZZZ , AAA , BBB , CCC , DDD , EEE , FFF , GGG , HHH , III , JJJ , KKK , LLL , MMM , NNN , OOO , PPP , QQQ , RRR , SSS , TTT , UUU , VVV , WWW , XXX , YYY , ZZZ , AAA , BBB , CCC , DDD , EEE , FFF , GGG , HHH , III , JJJ , KKK , LLL , MMM , NNN , OOO , PPP , QQQ , RRR , SSS , TTT , UUU , VVV , WWW , XXX , YYY , ZZZ , AAA , BBB , CCC , DDD , EEE , FFF , GGG , HHH , III , JJJ , KKK , LLL , MMM , NNN , OOO , PPP , QQQ , RRR , SSS , TTT , UUU , VVV , WWW , XXX , YYY , ZZZ , AAA , BBB , CCC , DDD , EEE , FFF , GGG , HHH , III , JJJ , KKK , LLL , MMM , NNN , OOO , PPP , QQQ , RRR , SSS , TTT , UUU , VVV , WWW , XXX , YYY , ZZZ , AAA , BBB , CCC , DDD , EEE , FFF , GGG , HHH , III , JJJ , KKK , LLL , MMM , NNN , OOO , PPP , QQQ , RRR , SSS , TTT , UUU , VVV , WWW , XXX , YYY , ZZZ , AAA , BBB , CCC , DDD , EEE , FFF , GGG , HHH , III , JJJ , KKK , LLL , MMM , NNN , OOO , PPP , QQQ , RRR , SSS , TTT , UUU , VVV , WWW , XXX , YYY , ZZZ , AAA , BBB , CCC , DDD , EEE , FFF , GGG , HHH , III , JJJ , KKK , LLL , MMM , NNN , OOO , PPP , QQQ , RRR , SSS , TTT , UUU , VVV , WWW , XXX , YYY , ZZZ , AAA , BBB , CCC , DDD , EEE , FFF , GGG , HHH , III , JJJ , KKK , LLL , MMM , NNN , OOO , PPP , QQQ , RRR , SSS , TTT , UUU , VVV , WWW , XXX , YYY , ZZZ , AAA , BBB , CCC , DDD , EEE , FFF , GGG , HHH , III , JJJ , KKK , LLL , MMM , NNN , OOO , PPP , QQQ , RRR , SSS , TTT , UUU , VVV , WWW , XXX , YYY , ZZZ , AAA , BBB , CCC , DDD , EEE , FFF , GGG , HHH , III , JJJ , KKK , LLL , MMM , NNN , OOO , PPP , QQQ , RRR , SSS , TTT , UUU , VVV , WWW , XXX , YYY , ZZZ , AAA , BBB , CCC , DDD , EEE , FFF , GGG , HHH , III , JJJ , KKK , LLL , MMM , NNN , OOO , PPP , QQQ , RRR , SSS , TTT , UUU , VVV , WWW , XXX , YYY , ZZZ , AAA , BBB , CCC , DDD , EEE , FFF , GGG , HHH , III , JJJ , KKK , LLL , MMM , NNN , OOO , PPP , QQQ , RRR , SSS , TTT , UUU , VVV , WWW , XXX , YYY , ZZZ , AAA , BBB , CCC , DDD , EEE , FFF , GGG , HHH , III , JJJ , KKK , LLL , MMM , NNN , OOO , PPP , QQQ , RRR , SSS , TTT , UUU , VVV , WWW , XXX , YYY , ZZZ , AAA , BBB , CCC , DDD , EEE , FFF , GGG , HHH , III , JJJ , KKK , LLL , MMM , NNN , OOO , PPP , QQQ , RRR , SSS , TTT , UUU , VVV , WWW , XXX , YYY , ZZZ , AAA , BBB , CCC , DDD , EEE , FFF , GGG , HHH , III , JJJ , KKK , LLL , MMM , NNN , OOO , PPP , QQQ , RRR , SSS , TTT , UUU , VVV , WWW , XXX , YYY , ZZZ , AAA , BBB , CCC , DDD , EEE , FFF , GGG , HHH , III , JJJ , KKK , LLL , MMM , NNN , OOO , PPP , QQQ , RRR , SSS , TTT , UUU , VVV , WWW , XXX , YYY , ZZZ , AAA , BBB , CCC , DDD , EEE , FFF , GGG , HHH , III , JJJ , KKK , LLL , MMM , NNN , OOO , PPP , QQQ , RRR , SSS , TTT , UUU , VVV , WWW , XXX , YYY , ZZZ , AAA , BBB , CCC , DDD , EEE , FFF , GGG , HHH , III , JJJ , KKK , LLL , MMM , NNN , OOO , PPP , QQQ , RRR , SSS , TTT , UUU , VVV , WWW , XXX , YYY , ZZZ , AAA , BBB , CCC , DDD , EEE , FFF , GGG , HHH , III , JJJ , KKK , LLL , MMM , NNN , OOO , PPP , QQQ , RRR , SSS , TTT , UUU , VVV , WWW , XXX , YYY , ZZZ , AAA , BBB , CCC , DDD , EEE , FFF , GGG , HHH , III , JJJ , KKK , LLL , MMM , NNN , OOO , PPP , QQQ , RRR , SSS , TTT , UUU , VVV , WWW , XXX , YYY , ZZZ , AAA , BBB , CCC , DDD , EEE , FFF , GGG , HHH , III , JJJ , KKK , LLL , MMM , NNN , OOO , PPP , QQQ , RRR , SSS , TTT , UUU , VVV , WWW , XXX , YYY , ZZZ , AAA , BBB , CCC , DDD , EEE , FFF , GGG , HHH , III , JJJ , KKK , LLL , MMM , NNN , OOO , PPP , QQQ , RRR , SSS , TTT , UUU , VVV , WWW , XXX , YYY , ZZZ , AAA , BBB , CCC , DDD , EEE , FFF , GGG , HHH , III , JJJ , KKK , LLL , MMM , NNN , OOO , PPP , QQQ , RRR , SSS , TTT , UUU , VVV , WWW , XXX , YYY , ZZZ , AAA , BBB , CCC , DDD , EEE , FFF , GGG , HHH , III , JJJ , KKK , LLL , MMM , NNN , OOO , PPP , QQQ , RRR , SSS , TTT , UUU , VVV , WWW , XXX , YYY , ZZZ , AAA , BBB , CCC , DDD , EEE , FFF , GGG , HHH , III , JJJ , KKK , LLL , MMM , NNN , OOO , PPP , QQQ , RRR , SSS , TTT , UUU , VVV , WWW , XXX , YYY , ZZZ , AAA , BBB , CCC , DDD , EEE , FFF , GGG , HHH , III , JJJ , KKK , LLL , MMM , NNN , OOO , PPP , QQQ , RRR , SSS , TTT , UUU , VVV , WWW , XXX , YYY , ZZZ , AAA , BBB , CCC , DDD , EEE , FFF , GGG , HHH , III , JJJ , KKK , LLL , MMM , NNN , OOO , PPP , QQQ , RRR , SSS , TTT , UUU , VVV , WWW , XXX , YYY , ZZZ , AAA , BBB , CCC , DDD , EEE , FFF , GGG , HHH , III , JJJ , KKK , LLL , MMM , NNN , OOO , PPP , QQQ , RRR , SSS , TTT , UUU , VVV , WWW , XXX , YYY , ZZZ , AAA , BBB , CCC , DDD , EEE , FFF , GGG , HHH , III , JJJ , KKK , LLL , MMM , NNN , OOO , PPP , QQQ , RRR , SSS , TTT , UUU , VVV , WWW , XXX , YYY , ZZZ , AAA , BBB , CCC , DDD , EEE , FFF , GGG , HHH , III , JJJ , KKK , LLL , MMM , NNN , OOO , PPP , QQQ , RRR , SSS , TTT , UUU , VVV , WWW , XXX , YYY , ZZZ , AAA , BBB , CCC , DDD , EEE , FFF , GGG , HHH , III , JJJ , KKK , LLL , MMM , NNN , OOO , PPP , QQQ , RRR , SSS , TTT , UUU , VVV , WWW , XXX , YYY , ZZZ , AAA , BBB , CCC , DDD , EEE , FFF , GGG , HHH , III , JJJ , KKK , LLL , MMM , NNN , OOO , PPP , QQQ , RRR , SSS , TTT , UUU , VVV , WWW , XXX , YYY , ZZZ , AAA , BBB , CCC , DDD , EEE , FFF , GGG , HHH , III , JJJ , KKK , LLL , MMM , NNN , OOO , PPP , QQQ , RRR , SSS , TTT , UUU , VVV , WWW , XXX , YYY , ZZZ , AAA , BBB , CCC , DDD , EEE , FFF , GGG , HHH , III , JJJ , KKK , LLL , MMM , NNN , OOO , PPP , QQQ , RRR , SSS , TTT , UUU , VVV , WWW , XXX , YYY , ZZZ , AAA , BBB , CCC , DDD , EEE , FFF , GGG , HHH , III , JJJ , KKK , LLL , MMM , NNN , OOO , PPP , QQQ , RRR , SSS , TTT , UUU , VVV , WWW , XXX , YYY , ZZZ , AAA , BBB , CCC , DDD , EEE , FFF , GGG , HHH , III , JJJ , KKK , LLL , MMM , NNN , OOO , PPP , QQQ , RRR , SSS , TTT , UUU , VVV , WWW , XXX , YYY , ZZZ , AAA , BBB , CCC , DDD , EEE , FFF , GGG , HHH , III , JJJ , KKK , LLL , MMM , NNN , OOO , PPP , QQQ , RRR , SSS , TTT , UUU , VVV , WWW , XXX , YYY , ZZZ , AAA , BBB , CCC , DDD , EEE , FFF , GGG , HHH , III , JJJ , KKK , LLL , MMM , NNN , OOO , PPP , QQQ , RRR , SSS , TTT , UUU , VVV , WWW , XXX , YYY , ZZZ , AAA , BBB , CCC , DDD , EEE , FFF , GGG , HHH , III , JJJ , KKK , LLL , MMM , NNN , OOO , PPP , QQQ , RRR , SSS , TTT , UUU , VVV , WWW , XXX , YYY , ZZZ , AAA , BBB , CCC , DDD , EEE , FFF , GGG , HHH , III , JJJ , KKK , LLL , MMM , NNN , OOO , PPP , QQQ , RRR , SSS , TTT , UUU , VVV , WWW , XXX , YYY , ZZZ , AAA , BBB , CCC , DDD , EEE , FFF , GGG , HHH , III , JJJ , KKK , LLL , MMM , NNN , OOO , PPP , QQQ , RRR , SSS , TTT , UUU , VVV , WWW , XXX , YYY , ZZZ , AAA , BBB , CCC , DDD , EEE , FFF , GGG , HHH , III , JJJ , KKK , LLL , MMM , NNN , OOO , PPP , QQQ , RRR , SSS , TTT , UUU , VVV , WWW , XXX , YYY , ZZZ , AAA , BBB , CCC , DDD , EEE , FFF , GGG , HHH , III , JJJ , KKK , LLL , MMM , NNN , OOO , PPP , QQQ , RRR , SSS , TTT , UUU , VVV , WWW , XXX , YYY , ZZZ , AAA , BBB , CCC , DDD , EEE , FFF , GGG , HHH , III , JJJ , KKK , LLL , MMM , NNN , OOO , PPP , QQQ , RRR , SSS , TTT , UUU , VVV , WWW , XXX , YYY , ZZZ , AAA , BBB , CCC , DDD , EEE , FFF , GGG , HHH , III , JJJ , KKK , LLL , MMM , NNN , OOO , PPP , QQQ , RRR , SSS , TTT , UUU , VVV , WWW , XXX , YYY , ZZZ , AAA , BBB , CCC , DDD , EEE , FFF , GGG , HHH , III , JJJ , KKK , LLL , MMM , NNN , OOO , PPP , QQQ , RRR , SSS , TTT , UUU , VVV , WWW , XXX , YYY , ZZZ , AAA , BBB , CCC , DDD , EEE , FFF , GGG , HHH , III , JJJ , KKK , LLL , MMM , NNN , OOO , PPP , QQQ , RRR , SSS , TTT , UUU , VVV , WWW , XXX , YYY , ZZZ , AAA , BBB , CCC , DDD , EEE , FFF , GGG , HHH , III , JJJ , KKK , LLL , MMM , NNN , OOO , PPP , QQQ , RRR , SSS , TTT , UUU , VVV , WWW , XXX , YYY , ZZZ , AAA , BBB , CCC , DDD , EEE , FFF , GGG , HHH , III , JJJ , KKK , LLL , MMM , NNN , OOO , PPP , QQQ , RRR , SSS , TTT , UUU , VVV , WWW , XXX , YYY , ZZZ , AAA , BBB , CCC , DDD , EEE , FFF , GGG , HHH , III , JJJ , KKK , LLL , MMM , NNN , OOO , PPP , QQQ , RRR , SSS , TTT , UUU , VVV , WWW , XXX , YYY , ZZZ

P. Limb
ry Pro
blems.

tors is by means of an equilateral triangle, which is constructed as follows.

Fig. 21.

Draw the line ME (fig. 22.), limited at M, but produced towards E: take M 1 equal to any convenient extent; make 1, 2 equal to twice that extent, 2, 3 equal to five times, and 3, 4 equal to seven times the above extent; and continue this division to E, always increasing by two, until there be as many points as there are frames, including the main and stern frames. Upon ME describe the equilateral triangle MSE, and draw lines from the vertex S to each point of division; then the line SM will be that answering to the main frame, and SE that corresponding to the stern; and the other lines will be those answering to the intermediate frames in order.

Fig. 22.

Let fig. 23. be the projection of part of the stern on the plane of elevation, together with the eighth and ninth frames. From the points L, N, G, (fig. 21.) draw the lines LO, NP, GQ, perpendicular to the plane of the upper edge of the keel. Make AB (fig. 23.) equal to AF (fig. 21.), and draw the water line BCD. Draw the line BC (fig. 22.) so that it may be parallel to the base of the triangle, and equal to CD (fig. 23.), which produce indefinitely towards H. Make BD equal to EC (fig. 23.), and draw the dotted line SD (fig. 22.). The ribband FC (fig. 21.) is to be applied to the triangle, so that it may be parallel to the base, and contained between the line MS and the dotted line SD. Let *cf* represent this line; then transfer the several divisions from *cf* to the ribband CF (fig. 21.), and number them accordingly. Again, make EF (fig. 23.) equal to LO (fig. 21.), and draw the water line FGH; make BF (fig. 22.) equal to FG (fig. 23.), and draw the dotted line SF; apply the second ribband LK to the triangle, so that the extremity K may be on the line SM, and the other extremity L on the dotted line SF, and making with SM an angle of about 62½ degrees. Let *kl* be this line, and transfer the divisions from it to the ribband KL. In like manner make IK (fig. 23.) equal to NP (fig. 21.), and draw the water line KLM. Make EG (fig. 22.) equal to KL (fig. 23.), and draw the dotted line SG; then the ribband MN is to be applied to the triangle in such a manner that its extremities M and N may be upon the lines SM, SG respectively, and that it may make an angle of about 68 degrees with the line SM; and the divisions are to be transferred from it to the ribband MN. The same process is to be followed to divide the other ribbands, observing to apply the fourth ribband to the triangle, so that it may make an angle of 86 degrees with the line SM; the fifth ribband to make an angle of 65 degrees, and the sixth an angle of 60 degrees with the line SM.

The quantities of these angles are, however, far from being precisely fixed. Some constructors, in applying the ribbands to the triangle, make them all parallel to its base; and others vary the measures of these angles according to fancy. It may also be remarked, that a different method of dividing the base of the triangle is used by some. It is certainly proper to try different

methods; and that it is to be preferred which best answers the intended purpose.

P. Limb
ry Pro
blems.

Beside the frames already mentioned, there are other two laid down by some constructors in the several plans, called *balance frames*. The after balance frame is placed at one fourth of the length of the ship before the stern-post; and the other, commonly called the *loof frame*, at one fourth of the ship's length aft of a perpendicular to the keel from the rabbet of the stem. Let the dotted line at X, between the fifth and sixth frames, (fig. 23.) be the place of the after balance frame in the plane of elevation. Then, in order to lay down this frame in the plane of projection, its representation must be previously drawn in the triangle. To accomplish this, draw the line SV (fig. 22.) so that the interval SV may have the same ratio to 5 6 (fig. 22.) that 5 X has to 5 6 (fig. 23.) (D). Then the several points in the ribbands in the plane of projection answering to this frame are to be found by means of the triangle in the same manner as before.

The loof frame is nearly of the same dimensions as the after balance frame, or rather of a little greater capacity, in order that the centre of gravity of that part of the ship may be nearly in the plane of the midship frame. Hence the loof frame may be easily drawn in the plane of projection, and hence also the other frames in the fore body may be readily described.

PROB. X. To describe the frames in the fore body.

Draw the middle line of the stem AB (fig. 24.); Fig. 24. make AC, BD each equal to half the thickness of the stem, and draw the line CD; describe also one half of the main frame CEFH. Let *e*, *f*, *g*, *h*, be water lines at the heights of the ribbands on the main frame; also let *a* be the termination of the floor ribband, and *b* that of the breadth ribband on the stem. Divide the interval *ab* into three equal parts in the points *c*, *d*, and draw the ribbands *a*, *e*, *c*, *f*, *d*, *g*, and *b*, *h*. Make *e*, *i*, *f*, *k*, *g*, *l*, *h*, *m* (fig. 24.) equal to *e*, *i*, *f*, *k*, *g*, *l*, *h*, *m* (fig. 21.) respectively, and draw the curve *Ciklm*, which will be the projection of the loof frame. Or since it is necessary that the capacity of the loof frame should be a little greater than that of the after balance frame, each of the above lines may be increased by a proportional part of itself, as one tenth or one twentieth, as may be judged proper.

Construct the triangle (fig. 25.) in the same manner Fig. 25. as fig. 22. only observing, that as there are fewer frames in the fore than in the after body, its base will therefore be divided into fewer parts. Let there be eight frames in the fore body, then there will be eight divisions in the base of the triangle beside the extremes.

Let fig. 26. represent the stem and part of the fore-body in the plane of elevation, and let O be the place of the loof frame. Divide the interval 4, 5 (fig. 25.) so that 4, 5 may be to 4 Z as 4, 5 to 4, 0 (fig. 26.), and draw the dotted line SZ, which will be the line denoting the loof frame in the triangle.

Draw the lines AB, CD, EF, GH (fig. 26.) paral- Fig. 26. lel to the keel, and whose perpendicular distances therefrom may be equal to C a, C c, C d, C b, (fig. 24.) the intersections

(D) It is evident, from the method used to divide the base of the triangle, that this proportion does not agree exactly with the construction: the difference, however, being small, is therefore neglected in practice.

Fig. 25.
Principles

intersections of these lines with the rabbet of the stem, namely, the points I, K, L, M will be the points of termination of the several ribbands on the stem in the plane of elevation. Divide S A (fig. 25.) so that 8 B, 8 C, 8 D, and 8 E, may be respectively equal to BI, DK, EL, and HM (fig. 26.), and draw the dotted lines SB, SC, SD, SE (fig. 25.). Apply the edge of a slip of card to the first ribband (fig. 24.), and mark thereon the extremities of the ribband *a*, E, and also the point of intersection of the roof frame. Then apply this slip of card to the triangle in such a manner that the point *a* may be on the dotted line SB, the point E on the line SM, and the point answering to the roof frame on the dotted line SZ; and mark upon the card the several points of intersection of the lines S 1, S 2, &c. Now apply the card to the ribband *a* E (fig. 24.) as before, and transfer the several points of division from it to the ribband. In like manner proceed with the other ribbands; and lines drawn through the corresponding points in the ribbands will be the projection of the lower part of the frames in the fore body. The projections of the top-timbers of the several frames may be taken from the half breadth plan; and hence each top-timber may be easily described.

In large ships, particularly in those of the French navy, a different method is employed to form the top-timbers in the fore body, which is as follows:

Let BI (fig. 27.) be one fourth of the breadth of the ship, and draw IK parallel to AB. Take the height of the foremast frame from the plane of elevation, and lay it off from A to B: from the point B draw BH perpendicular to AB, and equal to half the length of the wing transom. Let E be the place of the breadth ribband on the main frame, and F its place on the stem at the height of the wing transom. With a radius equal to five sixths of half the greatest breadth of the ship describe the quadrant EFG (fig. 28.): Make EH equal to FG (fig. 27.), the point F being at the height of the wing transom. Through H draw HO perpendicular to EH, and intersecting the circumference in O; then draw OL parallel to HE, and EL parallel to HO. Divide EL into as many equal parts as there are frames in the fore body, including the main frame, and from these points of division draw the perpendiculars 11, 22, &c. meeting the circumference as in the figure. Take the distance 11, and lay it off from G (fig. 27.) towards F to the point 1; and from the same point G lay off towards F the several perpendiculars contained between the straight line and the curve to the points 2, 3, &c. and through these points draw lines parallel to EG.

Take any line AB (fig. 29.) at pleasure: divide it equally in two in the point 8: divide 8 B in two parts in the point 7, and continue this method of division until there are as many points as there are frames in the fore body, including the main frame. Upon AB construct the equilateral triangle ACB, and draw the lines C 8, C 7, &c. Place a slip of card on the parallel *a* K 8 (fig. 27.), and mark thereon the points opposite to *a*, K, and 8; and let them be denoted accordingly. Then apply this slip of card to the triangle, so that the point *a*, which is that answering to the rabbet of the stem, may be on the line AC; that the point answering to K may be on C 8, and the extremity 8 on the line CB; and mark on the card the points of intersec-

tion of the lines C 7, C 6, &c. and number them accordingly. Now apply this slip of card to the seventh parallel (fig. 23.), the point *a* being on the line CD, and mark on this parallel the point of intersection 7; slide the card down to the sixth parallel, to which transfer the point N^o 6. In like manner proceed with the other parallels.

The point K, at the intersection of the line IK with the eighth parallel, is one point through which the eighth frame passes. From this point upwards a curve is to be described so as to reconcile with the lower part of this frame already described, and the upper part, forming an inverted arch, which is to terminate at H. This top-timber may be formed by two sweeps, whose radii and centres are to be determined partly from circumstances and partly according to fancy. It however may be more readily formed by hand.

Let LM (fig. 27.) be the line of the second deck at the main frame, and let LN be the difference of the draught of water, if any. Make GN (fig. 28.) equal to LN: draw NM perpendicular to GN, meeting the circle in M; and through the points G and M draw the parallels GV and MV; divide GN as before, and from the several points of division draw perpendiculars terminating in the curve. Transfer these perpendiculars from L upwards (fig. 27.), and through the points thus found draw the lines 11, 22, &c. parallel to LM. Apply a slip of card to the eighth parallel, and mark upon it the point answering to the stem, the eighth and main frames: carry this to the triangle, and place it so that these points may be on the corresponding lines. Then the points of intersection of the lines C 7, C 6, &c. are to be marked on the card, which is now to be applied first to the eighth parallel (fig. 27.), then to the seventh, &c. transferring the several points of division in order as before.

Draw the line HO (fig. 27.); mark its length on a slip of card, and apply it to the triangle, so that it may be parallel to its base, and its extremities one on the eighth and the other on the main frame: mark on the card the points of intersection of the several intermediate lines as before; then apply the card to HO, and transfer the divisions.

There are now three points determined through which each top-timber must pass, namely, one in the breadth ribband, one in the fifth, and one in the upper ribband. Through these curves are to be described, so as to reconcile with the lower part of the frame, and partake partly of the curvature of the eighth frame, and partly of that of the main frame, but most of that of the frame to which it is nearest: and hence the plane of projection is so far finished, that it only remains to prove the several frames by water lines.

Another method of describing the frames in the body plan is by sweeps. In this method it is necessary, in the first place, to describe the height of the breadth lines, and the rising of the floor, in the plane of elevation. The half breadth lines are next to be described in the floor plan. The main frame is then to be described by three or more sweeps, and giving it such a form as may be most suitable to the service the ship is designed for. The lower, upper, and top-timber heights of breadth, and the risings of the floor, are to be set upon the middle line in the body plan, and the several half breadths are then to be laid off on lines drawn through

Preliminary Principles

Plate
cccxxix.
Fig. 27.

Fig. 28.

Fig. 29.

Distances
of Plank
beams.

these points perpendicular to the middle line. A mould may then be made for the main frame, and laid upon the several ribs, as in whole mouldings, explained in Chapter V. with this difference, that here an under breadth sweep is described to pass through the point which limits the half breadth of the timber, the centre of which will be in the breadth line of that timber. The proper centres for all the frames being found, and the arches described, the bend mould must be so placed on the rising line of the floor, that the back of it may touch the back of the under breadth sweep. But the general practice is, to describe all the floor sweeps with compasses, as well as the under breadth sweeps, and to reconcile these two by a mould which is an arch of a circle, its radius being the same with that of the reconciling sweep by which the midship frame was formed. It is usual for all the floor sweeps to be of the same radius; and in order to find their centres a line is formed on the floor plan for the half breadth of the floor. As this line cannot be described on the surface of a ship, it is therefore only an imaginary line. Instead of it some make use of a diagonal in the body plane to limit the half breadth of the floor upon every rising line, and to erect perpendiculars at the several intersections, in the same manner as for the midship frame.

After the sweeps are all described, recourse is had to moulds, or some such contrivance, to form the hollow of the timbers, much in the same manner as in whole moulding; and when all the timbers are formed, they must be proved by ribband and water lines, and altered, if necessary to make fair curves.

The preceding methods of describing the several planes or sections of a ship being well understood, it will be a very easy matter to construct draughts for any proposed ship: and as the above planes were described separately and independent of each other, it is therefore of little consequence which is first described. In the following application, however, the plane of elevation will be first drawn, then part of the floor plan, and lastly the body plan: and in connecting these plans the most rational and simple methods will be employed.

CHAP. IV. Application of the foregoing Rules to the Construction of Ships.

SECT. I. To construct a Ship intended to carry a considerable Burden in Proportion to her general Dimensions, and to draw little Water.

DIMENSIONS.

Length between the wing transome and a perpendicular from the rib bet of the stem at the height of breadth line	F. In.	80	0
Main half breadth moulded		11	0
Half breadth at the height of breadth line at the stem		7	6
Top timber half breadth		10	6
Height of the stem above the upper edge of the keel		17	0
Height of the breadth line at the stem		13	6
Height of the breadth line at the stern		12	3
Upper height of breadth at the main frame		7	4
Lower height of breadth		5	10
Height of middle line of wales at the stem		10	0

Height of middle line of wales at the main frame	F. In.	6	10	Application of the foregoing Rules to the Construction of Ships.
Height of middle line of wales at the stern		10	6	
Breadth of the wales		1	9	
Height of top-timber at midships		14	0	
at stern		18	0	

Draw the line ab (fig. 30.) equal to 80 feet, from a convenient scale: divide it into as many equal parts plus one as there are to be frames, which let be 16, and through each point of division draw perpendiculars. Make bce equal to 17 feet, the perpendicular height of the top of the stem above the upper edge of the keel, and describe the stem by Prob. II. Make ad equal to 10½ feet, the height of the middle line of the wales at the stem, and ae equal to the proposed rake of the post, which may be about 2 feet: join de ; and draw the line fg representing the aft-side of the post. Describe the counter and stern by Problem VI. and VII. Make $\odot h$ equal to 14 feet, the top-timber height at the main frame, and ih equal to 18 feet, the height at the stern; and through the three points c, h, k , describe the curve limiting the top-timbers by Problem I. Make bde equal to 10 feet, the height of the middle line of the wales at the stem, and $\odot H$ equal to 6 feet 10 inches, the height at the main frame; and the curve dHd being described will represent the middle line of the wales. At the distance of 10½ inches on each side of this line draw two curves parallel thereto, and the wales will be completed in this plan. Make bl equal to 13½ feet, the height of the breadth line at the stem; am equal to 12½ feet, the height at the stern; and $\odot K$ equal to 5 feet 10 inches and 7 feet 4 inches respectively; and draw the upper breadth line lKm and lower breadth line lIm . From the line ab lay downwards the breadth of the keel, which may be about one foot, and draw the line lt parallel to ab .

Let the line Lr , which is the lower edge of the keel, represent also the middle line of the floor plan. Produce all the perpendiculars representing the frames: make $\odot M$ (fig. 31.) equal to 11 feet, the main half breadth at midships; through m (fig. 30.) draw the line mN perpendicular to ab , and make pN equal to 7½ feet, and draw the main half breadth line NMr by Problem IV. Describe also the top-timber half breadth line POr , $\odot O$ being equal to 10½ feet, and form the projecting part of the stem $qrst$.

In order that the top-timber line may look fair on the bow, and to prevent the foremost top-timbers from being too short, it is necessary to lift or raise the sheer from the round of the bow to the stem. For this purpose the following method is usually employed: Produce the circular sheer before the stem in the plane of elevation at pleasure; then place a batton to the round of the bow in the half breadth plan, and mark on it the stations of the square timbers and the side of the stem; apply the batton to the sheer plan, and place it to the sheer of the ship, keeping the stations of the timbers on the batton well with those on the sheer plan for several timbers before dead-flat, where they will not alter; then mark the other timbers and the stem on the sheer line produced; through these points draw lines parallel to the keel, to intersect their corresponding timbers and the stem in the sheer plan: then a curve described these last points will be the sheer of the ship round the

Plate
CCCCX.
Fig. 30.

Fig. 31.

Application in the bow, lifted as required; and the heights of the timbers at the keel, thus lengthened, are to be transferred to the body plan as before.

Draw the line AB (fig. 30) equal to 22 feet, the whole breadth; from the middle of which draw the perpendicular CD ; make CE equal to half the thickness of the post, and CF equal to half that of the stem, and from the points A, E, F, B , draw lines parallel to CD . Make AG, BG each equal to 14 feet, the height at the main frame, and draw the line GG parallel to AB . Make GH, GH each equal to half of AI , the difference between the main and top timber half breadths. From A and B set up the heights of the lower and upper breadth lines to I and K , and draw the straight lines IK, IK . Let CL be the rising at the main frame, and \odot, \ominus the extremities of the floor timber. Hence, as there are now five points determined in each half of the main frame, it may be very easily described.

Make CM equal to $L\oplus$, join $M\oplus$, and draw the other ribbands NO, PQ . In order, however, to simplify this operation, the rectilinear distance $\oplus I$ was trifled, and through the points of division the lines NO, PQ were drawn parallel to the floor ribband $M\oplus$.

Take the distance bc (fig. 30), and lay it off from F to (fig. 32); also make Fb (fig. 32) equal to Fc (fig. 30); through b draw bc parallel to AB , and equal to FR (fig. 31). In like manner take the heights of each top-timber from fig. 30, and lay them off from C towards D (fig. 32); through these points draw lines parallel to AB , and make them equal each to each, to the corresponding half breadth lines taken from the floor-plan: Then through the several points $a, c, \&c.$, thus found, draw a line $a c H$, which will be the projection of the top-timber line of the fore body in the body plan. Proceed in the same manner to find the top-timber line in the after body.

Transfer the height of the main-breadth line on the stem bd (fig. 30), from F to d (fig. 32). Transfer also the heights of the lower and upper breadth lines at timber F (fig. 30), namely, FW, FX , from F to e and f (fig. 32); through which draw the parallels eg, fh ; make them equal to ES (fig. 31), and draw the straight line gh . In this manner proceed to lay down the portions of the extreme breadth at each frame, both in the fore and in the after body in the body plan, and draw the upper and lower breadth lines $d h K, d g I$ in the fore body and $K i, I i$ in the after body. Hence the portions of the several top-timbers contained between the top-timber and main breadth lines may be easily described. It was before remarked that their forms were partly arbitrary. The midship top-timber has generally a hollow, the form of which is left entirely to the artist, though in some ships, especially small ones, it has none. It is the common practice to make a mould for this hollow, either by a sweep or some other contrivance, which is produced considerably above the top-timber line, in a straight line or very near one. The midship top-timber is formed by this mould, which is so placed that it breaks in four with the back of the upper breadth sweep. The other top-timbers are formed by the same mould, observing to place it so that the straight part of it may be parallel to the straight part of the midship timber, and moved up or down, still keeping it in that direction till it just touches the back of the upper breadth sweep.

Some authors begin in the after timber, after the mould is made for the midship top-timber, because they think it easier to keep the straight part of the mould parallel to this than to the midship timber; and by this means the top side is kept from winding. Others, again, make a mark upon the mould where the breadth line of the midship timber crosses it, and with the same mould they form the after timber: this will occasion the mark that was made on the mould when at the main frame to fall below the breadth line of the after timber, and therefore another mark is made at the height of the breadth line at the after timber; the straight part of the mould is then laid out equally across the breadth lines of the top-timbers in such a manner that it may intersect the breadth line of the midship timber at one of these marks and the breadth line of the after timber at the other mark; then the several inter-sections of the breadth lines of the timbers are marked upon the mould; which must now be placed in forming each timber, that the proper mark may be applied to its proper breadth, and it must be turned about so as just to touch the upper breadth sweep. Any of these methods may make a fair deal, and they may be easily proved by forming another intermediate half breadth line.

The remaining parts of the frames may be described by either of the methods laid down in Problems IX. and X. In order, however, to illustrate this still farther, it is thought proper to subjoin another method of forming the intermediate frames, the facility of which will recommend it.

Take FZ (fig. 30), and lay it from F to k (fig. 32); then describe the lower part of the foreform frame, making it more or less full according as proposed; and intersecting the ribbands in the points l, m, n . Describe also the aftermost frame o, p, q . Make ab (fig. 30) equal to Fr (fig. 32), and produce it to a (fig. 31); also draw yd and $z\epsilon$ (fig. 30) equal to Ea and Ez (fig. 32) respectively; and produce them to b and c : Make Fe, Ff, FR (fig. 31) equal to Ml, Nm, Pn (fig. 32) each to each. Let also $\odot h, \oplus i, \oplus k$, and $g l, g m, g n$ (fig. 31) be made equal to $M \ominus, NO, PQ$, and Mz, Ng, Pp (fig. 32); then through these points trace the curves $a c n h l b, r f i m c$, and $r R k n p$, and they will be the projections of the ribbands in the floor plane. Now transfer the several intervals of the frames contained between the middle line and the ribbands (fig. 31) to the corresponding ribbands in the body plan (fig. 32). Hence there will be five points given in each frame, namely, one at the lower breadth line, one at each ribband, and one at the keel; and consequently these frames may be easily described. In order to exemplify this, let it be required to lay down the frame E in the plane of projection. Take the interval En (fig. 31), and lay it from M to u (fig. 32). Lay off also $L v, E e$ (fig. 31) from N to v and from P to n (fig. 32); then through the points F, u, v, n and the lower breadth line describe a curve, and it will be the representation of the frame E in the body plan. In like manner the other frames may be described.

The ribbands may now be transferred from the body plan to the plane of elevation, by taking the several heights of the intersection of each ribband with the frames, and laying them off on the corresponding frame in the floor plan; and if the line drawn through these

Application of the former Rules to the Construction of the

Fig. 32

Application of the frames are rightly laid down in the body plan. Only one of these ribbands, namely, the first, is laid down in fig. 30. These curves may also be farther proved, by drawing water lines in the plane of elevation, and in the body plan, at equal distances from the upper edge of the keel. Then the distances between the middle line of the body plan, and the several points of intersection of these lines with the frames, are to be laid off from the middle line in the floor plan upon the corresponding frames; and if the line drawn through these points form a fair curve, the frames are truly drawn in the body plan.

In figs. 30, and 32, there are drawn four water lines at any equal distances from the keel, and from each other. These lines are then transferred from fig. 32, to fig. 31; and the lines passing through these points make fair curves.

The transoms are described by Problem VIII. it is therefore unnecessary to repeat the process. A rising line of the floor timbers is commonly drawn in the plane of elevation.

As this is intended only as an introductory example, several particulars have therefore been omitted; which, however, will be exemplified in the following section.

SECT. IV. To describe the several Plans of a Ship of War proposed to carry 80 Guns upon two Decks.

As it is proposed in this place to show the method of describing the plans of a ship of a very considerable size, it therefore seems proper to give the dimensions of every particular part necessary in the delineation of these plans. The several parts of this ship are contained in figs. 33, and 34. But as it would very much confuse the figures to have a reference to every operation, and as the former example is deemed a sufficient illustration, the letters of reference are upon these accounts omitted in the figures.

PRINCIPAL DIMENSIONS.

<i>Ship Builder's Repository.</i>	<i>Lengths.</i>	<i>Length on the gun or lower deck from the aft part of the rabbet of the stem to the aft part of the rabbet of the post</i>	<i>F. In.</i>
	Length from the foremost perpendicular to dead flat		182 0
	Length from the foremost perpendicular to timber Y		63 11½
	Length from after perpendicular to timber 37		4 0
	Room and space of the timbers		3 4
	Length of the quarter-deck from the aft part of the stem		2 8½
	Length of the forecastle from the fore part of the beak-head		95 0
	Length of round-house deck from the aft part of the stem		49 0
	Height of the gun or lower deck from the upper edge of the keel to the under side of the plank at dead flat		51 8
	Height of the gun or lower deck from the upper edge of the keel to the under side of the plank at foremost perpendicular		24 0
	Height of the gun or lower deck from the		26

<i>F. In.</i>	<i>Application of the foregoing Rules to the Construction of Ships.</i>
26 3	upper edge of the keel to the under side of the plank at after perpendicular
7 0	Height from the upper side of the gun-deck plank to the under side of the upper deck plank, all fore and aft
6 10	Height from the upper side of the upper deck plank to the under side } afore
6 11	of the greater deck plank } abaft
6 6	Height to the under side of forecastle plank, afore and abaft
6 9	Height from the upper side of the quarter deck plank to the under side of the round-house plank } afore
6 10	} abaft
24 6	Height of the lower edge of the main wales at foremost perpendicular
20 0	Height of the lower edge of the main wales at dead flat
26 6	Height of the lower edge of the main wales at after perpendicular
8 2 6	Height of the lower edge of the channel wales at foremost perpendicular
29 0	Height of the lower edge of the channel wales at dead flat
34 0	Height of the lower edge of the channel wales at after perpendicular
28 4	Height of the upper side of the wing transom
33 5	Height of the touch of the lower counter at the middle line
36 2	Height of the touch of the upper counter at the middle line
44 7	Height of the top-timber line at the after part of the stern timber
4 6	Breadths.—Main wales in breadth from lower to upper edge
3 0	Channel wales in breadth from lower to upper edge
0 7	Waist rail in breadth
2 9	Distance between the upper edge of the channel wales and the under edge of the waist rail
0 6	Sheer rail in breadth
2 5	Distance between the sheer rail and the rail above from timber 13 to the stern
1 4	Distance between the sheer rail and the rail above from timber 7 to timber 11
1 2	Distance between the sheer rail and the rail above from timber C to the forepart of beak-head
0 6	And the said rail to be in breadth
0 2½	Plank sheer to be in thickness
103 2	Centres of the masts.—From the foremost perpendicular to the centre of the mainmast on the gun-deck
20 5	From the foremost perpendicular to the centre of the foremast on the gun-deck
28 6	From the after perpendicular to the centre of the mizenmast on the gun-deck
0 4	Stem.—The centre of the sweep of the stem abaft timber P
26 1	Height of ditto from the upper edge of the keel
1 3	Stem moulded
Foremost	

Application of the foregoing Rules to the Construction of Ships.	Foremost part of the head above the perpendicular	F. In.	Round aft of the wing transom	F. In.	Application of the foregoing Rules to the Construction of Ships.
	Height of ditto from the upper edge of the keel	2 4	Draught of water.—Load draught of water from the upper edge of the keel	38 3	0 6 0 5½ 20 5 20 5
	<i>Stem-post</i> .—Aft part of the rabbet above the perpendicular on the upper edge of the keel	3 4	<i>Channels</i> .—Foremost end of the fore channel above timber R	2 6	1 0
	Aft part of the port abaft the rabbet at the upper edge of the keel	2 6	The channel to be in length	1 1	37 0
	Aft part of the port abaft the rabbet at the wing transom	1 1	And in thickness at the outer edge	3 1	0 4½
	Stern-port fore and aft on the keel	3 1	The dead eyes to be 12 in number, and in diameter	2 2½	1 6
	Ditto square at the head	2 2½	Foremost end of the main channel above timber 9	7 6	0 10 38 0
	<i>Counters</i> .—The touch of the lower counter at the middle line, abaft the aft part of the wing transom	7 6	The channel to be in length	1 4	0 4½
	Round aft of the lower counter	1 4	And in thickness at the outer edge	0 9	1 6
	Round up of the lower counter	0 9	The dead eyes to be 14 in number, and in diameter	9 9	2 4
	The touch of the upper counter at the middle line, abaft the aft part of the wing transom	9 9	Foremost end of the mizen-channel abaft timber 27	1 3½	20 0
	Round aft of the upper counter	1 3½	The channel to be in length	0 10	0 4
	Round up of the upper counter	0 10	And in thickness at the outer edge	12 6	1 0
	Aft part of the stem-timber at the middle line, at the height of the top timber line, abaft the aft part of the wing transom	12 6	The dead eyes to be 7 in number, and in diameter		

DIMENSIONS of the several Parts of the Bodies.

Fore Body.	Timbers Names.									
	⊕	C	G	L	P	T	W	Y		
	Ft. In.	Ft. In.	Ft. In.	Ft. In.	Ft. In.	Ft. In.	Ft. In.	Ft. In.	Ft. In.	Ft. In.
Lower height of breadth	22 6	22 6	22 7	23 0	23 11	25 7	26 10	28 8		
Upper height of breadth	24 10	24 10	24 10	24 10	25 3½	26 4	27 4½	29 0		
Height of the top-timber line	37 5	37 7	38 0	38 5	39 1	39 10	40 4	40 9		
Height of the rising line*	0 0	0 5½	3 10	9 10	18 6					
Height of the cutting down	2 3½	2 3½	2 3½	2 8	3 10	6 4				
Main half breadth	24 5½	24 5½	24 4½	24 0½	23 2½	20 2	17 0	11 0	11 0	11 0
Top-timber half breadth	20 11	20 10	20 9	20 0	20 0	18 9½	17 10	16 6		
Half breadth of the rising	8 7	8 4	6 5½	2 9	5 7					
					Outside					
Length of the lower breadth sweeps	19 2	18 0	18 3	17 3	15 11	14 1	12 7	12 0		
First diagonal line	7 9	7 8½	7 7	7 1	6 3	3 8				
Second ditto	13 9	13 8½	13 4	12 1	10 3	7 1½	4 6			
Third ditto	20 0	19 11	19 2	17 7	15 1	11 1	8 3½	3 4	4 1	
Fourth ditto	23 4½	23 4	23 0	21 8½	18 11	14 8½	11 5	6 0		
Fifth ditto	24 8	24 8	24 4½	23 5½	21 2½	17 1	13 8½	7 11		
Sixth ditto										
Seventh ditto	24 1½	24 1½	24 0	23 9	22 10	20 10½	18 6½	14 7		

* Rising height 11 feet 10 inches at dead flat, from which all the other risings must be set off.

After Body.	Timbers Names.																					
	1		5		9		13		17		21		25		29		33		35		37	
	Ft.	In.	Ft.	In.	Ft.	In.	Ft.	In.	Ft.	In.	Ft.	In.	Ft.	In.	Ft.	In.	Ft.	In.	Ft.	In.	Ft.	In.
Lower height of breadth	22	6	22	6	22	6	22	7 $\frac{1}{2}$	22	9	23	0	27	7 $\frac{1}{2}$	24	6	25	10 $\frac{1}{2}$	26	9 $\frac{1}{2}$	28	3
Upper ditto	24	10	24	10	24	10	24	11	25	1	25	4	25	8	26	3	27	1	27	9	28	8
Height of the top-timber line	37	5	37	5	37	6	37	10	38	3 $\frac{1}{2}$	38	11	39	8	40	6	41	5	42	0	42	6
Height of the cutting down	2	3 $\frac{1}{2}$	2	3 $\frac{1}{2}$	2	3 $\frac{1}{2}$	2	3 $\frac{1}{2}$	2	4	2	7 $\frac{1}{2}$	3	5	2 $\frac{1}{2}$	8	7					
Height of the rifting	0	2 $\frac{1}{2}$	0	8 $\frac{1}{2}$	1	9 $\frac{1}{2}$	3	6 $\frac{1}{2}$	6	0	10	1	17	0								
Main half breadth	24	5 $\frac{1}{2}$	24	4 $\frac{1}{2}$	24	4 $\frac{1}{2}$	24	3 $\frac{1}{2}$	24	1	23	8 $\frac{1}{2}$	23	0 $\frac{1}{2}$	21	10						
Half breadth of the rifting	8	6	8	3	7	9	6	10 $\frac{1}{2}$	5	3 $\frac{1}{2}$	2	8	2	6	Outside							
Top-timber half breadth	20	11	20	10	20	9 $\frac{1}{2}$	20	9	20	7	20	3	19	5	18	2	16	8	15	10 $\frac{1}{2}$	15	0 $\frac{1}{2}$
Topfides half breadth													19	7	18	4	17	0	15	10	14	11
Length of lower breadth sweeps	19	2	19	2	19	0	18	7	17	1	16	0	14	5	12	5	9	10 $\frac{1}{2}$	7	11	4	8
Firft diagonal	7	9	7	8 $\frac{1}{2}$	7	7	5	7	2 $\frac{1}{2}$	6	7	5	9	4	7	2	10	1	8 $\frac{1}{2}$	0	7	0
Second ditto	13	9	13	8 $\frac{1}{2}$	13	6	13	1	12	6	11	2	9	7	7	7	4	8 $\frac{1}{2}$	3	1	0	11
Third ditto	20	0	19	11 $\frac{1}{2}$	19	7 $\frac{1}{2}$	19	0	18	14	16	6	14	2	11	5 $\frac{1}{2}$	7	8 $\frac{1}{2}$	5	5	2	1 $\frac{1}{2}$
Fourth ditto	23	4 $\frac{1}{2}$	23	3	23	1 $\frac{1}{2}$	22	6 $\frac{1}{2}$	21	11	20	3	18	0	15	3 $\frac{1}{2}$	11	4	8	7	4	6 $\frac{1}{2}$
Fifth ditto	24	8	24	7	24	6	24	1 $\frac{1}{2}$	23	6 $\frac{1}{2}$	22	3 $\frac{1}{2}$	20	6 $\frac{1}{2}$	18	2	14	4	11	5	7	0
Sixth ditto															18	8 $\frac{1}{2}$	16	0	18	8 $\frac{1}{2}$	11	8
Seventh ditto										23	9 $\frac{1}{2}$	23	0	21	8 $\frac{1}{2}$	20	0	18	11	17	8 $\frac{1}{2}$	

DIAGONAL LINES for both the FORE and AFTER BODIES.

Fore and After Bodies.	Names of the Diagonal Lines.													
	1ft		2d		3d		4th		5th		6th		7th	
	Ft.	In.	Ft.	In.	Ft.	In.	Ft.	In.	Ft.	In.	Ft.	In.	Ft.	In.
Height up the middle line	6	11	11	4	16	5 $\frac{1}{2}$	20	8	23	5 $\frac{1}{2}$	27	5	43	9
Distance from the middle line on the base line	4	8	9	1	15	6								
Height up the side line							0	9 $\frac{1}{2}$	6	7	12	7 $\frac{1}{2}$	32	8 $\frac{1}{2}$

I. Of the Sheer Draught or Plane of Elevation.

Fig 33. Draw a straight line (fig. 33.) to represent the upper edge of the keel, erect a perpendicular on that end to the right, and from thence set off 182 feet, the length on the gun-deck, and there erect another perpendicular; that to the right is called the *foremost* perpendicular, and the other the *after* one: upon these two perpendiculars all the foremast and aftermast heights must be set off, which are expressed in the dimensions.

Then set off the distance of the main frame or dead flat from the foremast perpendicular, and at that place erect a third perpendicular, which must be distinguished by the character \oplus . From dead flat the room and space of all the timbers must be set off; but it will only be necessary to erect a perpendicular at every frame timber; which in the fore body are called *dead flat*, A, C, E, &c. and in the after body (2), 1, 3, 5, &c.: hence the distance between the frame perpendiculars will be double the room and space expressed in the dimensions. Then set off the heights of the gun-deck afore at midship or dead flat, and abaft from the upper side of the keel; and a curve described through these three points will be the upper side of the gun-deck. Set off

the thickness of the gun-deck plank below that; and another curve being drawn parallel to the former, the gun-deck will then be described at the middle line of the sheer plan.

The centre of the stem is then to be laid down by means of the table of dimensions; from which centre, with an extent equal to the nearest distance of the upper edge of the keel, describe a circle upwards: describe also another circle as much without the former as the stem is moulded. Then set off the height of the head of the stem, with the distance afore the perpendicular, and there make a point; and within that set off the moulding of the stem, and there make another point: from this last mentioned point let a line pass downwards, intersecting the perpendicular at the height of the gun-deck, and breaking in fair with the inner circle, and the after part of the stem is drawn. Draw another line from the foremast point downwards, parallel to the former, and breaking in fair with the outer circle; then the whole stem will be formed, except the after or lower end, which cannot be determined till hereafter.

The stern-post must be next formed. Set off on the upper edge of the keel a spot for the aft part of the rabbit taken from the dimensions, and from that forward set off another point at the distance of the thick-

net.

Application
of the fore-
going Rules
to the Con-
struction of
Ships.

ness of the plank of the bottom, which is four inches and a half; and from this last-mentioned point draw a line upwards intersecting the perpendiculars at the height of the lower deck; then set up the perpendicular the height of the wing transom, and draw a level line, and where that line intersects, the line first drawn will be the aft side of the wing transom; on the upper part of the middle line set off from that place the distance of the aft side of the stern-post; set off also the distance of the after part from the rabbet on the upper edge of the keel, and a line drawn through these two points will be the aft side of the post. A line drawn parallel to the first drawn line at the distance of four inches and a half, the thickness of the plank on the bottom, will be the aft side of the rabbet; and hence the stern-post is described, except the head, which will be determined afterwards.

From the dimensions take the several heights of the upper deck above the gun-deck, afore, at midship, and abaft, and set them off accordingly; through these points describe a curve, which will be the under side of the upper deck; describe also another curve parallel thereto, at the distance of the thickness of the plank, and the upper deck will be then represented at the middle line of the ship.

Set off the height of the lower counter, at the middle line, from the upper edge of the keel, and draw a horizontal line with a pencil; then on the pencil line set off the distance the touch of the lower counter is abaft the aft side of the wing transom: from this point to that where the fore part of the rabbet of the stern-post intersects the line drawn for the upper part of the wing transom, draw a curve at pleasure, which curve will represent the lower counter at the middle line. The height of the upper counter is then to be set off from the upper edge of the keel, and a horizontal line is to be drawn as before, setting off the distance the touch of the upper counter is abaft the aft side of the wing transom; and a curve described from thence to the touch of the lower counter will form the upper counter at the middle line.

Both counters being formed at the middle line, the upper part of the stern timber above the counters is to be described as follows: On the level line drawn for the upper side of the wing transom set off the distance of the aft side of the stern timber at the middle line from the aft side of the wing transom, at the height of the top-timber line, and erect a perpendicular: then upon this perpendicular, from the upper edge of the keel, set off the height at the middle line of the top-timber line at the after side of the stern timber; through this point draw a straight line to the touch of the upper counter, and the upper part of the stern timber will be described.

As the stern rounds two ways, both up and aft, the stern timber at the side will consequently alter from that at the middle line, and therefore remains to be represented. Take the round up of the upper counter from the dimensions, and set it below the touch at the middle, and with a pencil draw a level line; take also the round aft, and set it forward from the touch on the touch line, and figure it down to the pencil line last drawn, and the point of intersection will be the touch of the upper counter at the side. In the same manner find the touch of the lower counter; and a curve, si-

Application
of the fore-
going Rules
to the Con-
struction of
Ships.

milar to that at the middle line, being described from the one touch to the other, will form the upper counter at the side.

Take the round up of the wing transom, and set it off below the line before drawn for the height of the wing transom, and draw another horizontal line in pencil: then take the round aft of the wing transom, and set it forward on the upper line from the point representing the aft side of the wing transom; square it down to the lower line, and the intersection will be the touch of the wing transom: then a curve, similar to that at the middle line, being drawn from the touch of the wing transom to the touch of the lower counter at the side, will be the lower counter at the side. Draw a line from the upper counter upwards, and the whole stern timber at the side will be represented. But as the straight line drawn for the upper part of the side timber should not be parallel to that at the middle line, its rake is therefore to be determined as follows.

Draw a line at pleasure, on which let off the breadth of the stern at the upper counter; at the middle of this line set off the round aft of the upper counter, then through this point and the extremities of the stern describe a curve. Now take the breadth of the stern at the top-timber line, and through the point where that breadth will intersect the curve for the round aft of the stern draw a line parallel to that first drawn, and the distance from the line last drawn to the curve at the middle of the line is the distance that the side timber must be from the middle line at the height of the top-timber line.

The sheer is to be described, which is done by setting off the heights afore, at midships, and abaft; and a curve described through these three points will be the sheer. But in order that the sheer may correspond exactly with the dimensions laid down, it will be necessary to proceed as follows: The perpendicular representing timber dead flat being already drawn, set off from that the distances of the other frame timbers, which is double the room and space, as the frames are only every other one; and erect perpendiculars, writing the name under each: then on each of these perpendiculars set off the corresponding heights of the top-timber line taken from the table of dimensions for constructing the bodies; and through these points a curve being described, will represent the sheer of the ship or top-timber line agreeable to the dimensions.

The quarter-deck and forecalle are next to be described, which may be done by taking their respective heights and lengths from the dimensions, and describing their curves. In the same manner also, the round-house may be drawn. The decks being described representing their heights at the middle, it is then necessary to represent them also at the side. For this purpose take the round of the decks from the dimensions, and set them off below the lower line drawn for the middle; and a curve described both fore and aft, observing to let it be rather quicker than the former, will be the representation of the decks at the side.

The ports come next under consideration. In the placing of them due attention must be paid, so as to preserve strength; or that they shall be so disposed as not to weaken the ship in the least, which is often done by cutting off principal timbers, placing them in too large openings, having too short timbers by the side of them.

of the fore-
part of the
gun-deck
ports, &c.
of the fore-
part of the
gun-deck
ports, &c.
of the fore-
part of the
gun-deck
ports, &c.

The frames represented by the lines already drawn must be first consulted. Then with a pencil draw two curves, for the lower and upper parts of the lower deck posts, parallel to the line representing the lower deck; and the distances of these lines from the deck are to be taken from the dimensions, observing, however, to add to these heights the thickness of the deck, as the deck line at the side represents the under part of the deck.

The foremast port is then to be described, observing to place it as far aft as to give sufficient room for the manger; the most convenient place will therefore be to put it between the frames R and T, and equally distant from each. It will then be placed in the most conspicuous point of strength, as it will have a long top-timber on the aft side and a long fourth futtock on the fore side of it. The second port may be placed in like manner between the next two frames, which will be equally well situated for strength as the former; and by proceeding in this manner, the ports on the gun deck may also be placed, taking care to have two frames between every two ports, all fore and aft.

The upper deck ports are then to be described; and in order to dispose of them in the strongest situation possible, they must be placed over the middle between the gun-deck ports, so that every frame in the ship will run up to the top of the side, by their coming between a gun and upper deck port; and every port will be between the frames, which will in a great measure contribute towards the strength of the ship. With regard to the ports on the quarter deck, it is not of such material consequence if they cut the head of the frame, as in placing them the situation of the dead eyes must be considered, placing a port where there is a vacancy between the dead eyes large enough to admit of one; observing always to place them as nearly as possible at equal distances from each other; and where it happens that they do not fall in the wake of a frame, then that frame must by all means be carried up to the top of the side.

The necessary length of the round house being determined in the dimensions, it may be set off; observing, however, to let it be no longer than is just sufficient for the necessary accommodations, as the shorter the round-house the works abaft may be kept lower, and a low ring stern is always accounted the handsomest. Then set off the round of the deck at the foremast end, below the line drawn; the deck at the side may be described by another curve drawn quite aft. Now, from the point for the round of the deck to the stern timber, draw a curve parallel to the top-timber line, and that will be the extreme height of the top of the side abaft, which height continues to range fair along to the foremast end of the round house, and at that place may have a fall about 14 inches, which may be turned off with a slight scroll. At the fore part of the quarter-deck, the topside may have a rise of 14 inches, which may also be turned off with a scroll. But as the raising of the topside only 14 inches at that place will not be sufficient to unite with the heights abaft, it will therefore be necessary to raise 14 inches more upon that, and break it off with a scroll invented on the first scroll, and continue these two lines, parallel to the top-timber line, to the distance of about seven feet aft. At the foremast end of the round-house there is a break of 14

inches already mentioned; and in order to make that part uniform with the breaks at the foremast end of the quarter-deck, there must be set down 14 inches more below the former; and at these two heights continue two curves parallel to the top-timber line, from the aft part of the item to the ends of the two curves already drawn at the foremast end of the quarter-deck. If they should happen not to break in fair with them, they must be turned off with a round; but to make them appear more handsome, the lower line may be turned off with a scroll. These lines being drawn will represent the upper edges of the rails.

The height of the top side at the fore part of the ship must next be considered; which, in order to give proper height for the forecastle, must have a rise there of 14 inches, the break being at the after end of the forecastle, and turned off as before. But as this part of the ship is still considerably lower than the after part, it will be necessary to give another of eight inches upon the former, and turn it off with a scroll inverted. Hence this part of the ship will appear more uniform to the stern part.

The finishing parts, namely the wales, stern, head, rails, &c. remain to be described. The wales may be first drawn; and as the strength of the ship depends very much on the right placing of them, great care must therefore be taken that they may be as little as possible wounded by the lower deck ports, and to place that the lower deck bolts shall bolt in them, and also that they come as near as possible on the broadest part of the ship. In the first place, therefore, the height of breadth lines must be chosen for our guide. These heights of breadth are to be taken from the dimensions, and set off on the respective frames, and curves drawn through these points will be the upper and lower heights of breadth lines. The height of the wales may be now determined; which in general is in such a manner that the upper height of breadth line comes about six inches below their upper edge, and the wales are then placed right upon the breadth lines. Take the heights and breadths of the wales above, at midships, and abaft, from the table of dimensions; draw curves through the points thus found, and the wales will be represented.

The channel wales are then to be described. They are principally intended to strengthen the top side, and must be placed between the lower and upper deck ports; and the lower end of them at midships should be placed as low as possible, in order to prevent them from being cut by the upper deck ports fore and abaft. Take their heights and breadths from the dimensions; lay them off, and describe curves through the corresponding points, and the channel wales will be represented.

Lay off the dimensions of the waste rail found in the table; and through the points draw a line parallel to the top-timber line all fore and aft. This rail terminates the lower part of the paint work on the top side, as all the work above this rail is generally painted, and the work of the top side below it payed with a varnish, except the main wales, which are always payed with pitch.

Take the draught of water from the dimensions, and draw the load water-line, which is always done in green. Divide the distance between the load water-line and the upper edge of the keel into five equal parts, and through these points draw four more water-lines.

Application of the foregoing Rules to the Construction of Ships. Set off the centres of the masts on the gun deck; their rake may likewise be taken from the unifications. Set off also the centre of the bowsprit, letting it be four feet from the deck at the after part of the stem, which will give sufficient height for a light and dry figure.

Draw the knight-heads as far as to be sufficiently high above the bowsprit to admit of a chock between them for the better security of the bowsprit. The timber heads may also be drawn above the bowsprit, observing to place the most convenient for the timbers of the frame, being those which come over the upper deck ports, as they may be allowed long enough to form handsome heads. There should be one placed about the cat-head, to which the foremast block is to be bolted, and there may be two ports on the forecable formed by them, and placed where it is most convenient to the dead eyes.

Describe the channels, taking their lengths and thicknesses from the dimensions, and place their upper edges well with the lower edge of the floor rib. The dead eyes may then be drawn, observing to place them in such a manner that the chains may not interfere with the ports; and the preventer plates must all be placed on the channel wales, letting them be of such a length that the preventer bolt at each end may bolt on each edge of the channel wales. It must also be observed to give each of the chains and preventer plates a proper rake, that is, to let them lie in the direction of the threads, which may be done in the following manner: Produce the mast upwards, upon which set off the length of the mast to the lower part of the head; these straight lines drawn from that point through the centre of each dead eye will give the direction of the chains and preventer braces.

The fenders may be then drawn, observing to place them right ahead of the main hatchway, in order to prevent the ship's side from being hurt by whatever may be hoisted on board. The proper place for them will therefore be at timber 3; and the distance between them may be regulated by the distance between the ports. The chest tree may also be drawn, which must be placed at a proper distance abaft the foremast, for the conveniency of hauling home the fore tack. It may therefore be drawn at the aft side of timber C from the top of the side down to the upper edge of the channel wales; and the fenders may reach from the top of the side down to the upper edge of the main wales. As the fenders and chest tree are on the outside of the planks, wales, &c. the lines representing the wales, &c. should not be drawn through them.

Draw the steps on the side, which must be at the fore part of the main dunnage or break, making them as long as the distance between the upper and lower deck ports will admit of. They may be about six inches slender, and five inches deep, and continued from the top of the side down to the middle of the main wales.

In order to describe the head, the height of the beak-head must be first determined, which may be about two feet above the upper deck. At that place draw a horizontal line, upon which set off the length of the beak-head, which may be 7½ feet abaft the fore part of the stem, and from thence figure a line up to the forecable deck; which line will represent the aft part of the beak head, and will likewise terminate the foremast end

of the forecable. The length of the head may now be determined, which by the proportions will be found to be 15 feet six inches from the fore part of the stem. Set it on from the fore part of the stem, and erect a perpendicular, which will be the utmost limits of the figure forwards; then take the breadth of the figure from the proportions, which is four feet four inches, and set it off forward; and another perpendicular being drawn will show the utmost extent of the hair bracket forward, or aft part of the figure. Then draw the lower cheek, letting the upper edge be well with the upper edge of the main wales, and the after end ranging well with the beak head line; set off the depth of it on the stem; which is about 11 inches, and let a curved line pass from the after end through the point on the stem, and to break in fair with the perpendicular first drawn for the length of the head, the fore part of the curve will then represent the position of the figure.

The upper cheek may next be drawn; but, in order to know the exact place of it on the stem, the place of the main rail must first be set off on the stem, the upper edge of which may be kept on a level with the beak-head; then setting off the depth of it below that, the place for the upper cheek may be determined, letting it be exactly in the middle between that and the lower cheek; then, by drawing curves for the upper and lower edges of the cheek from the after end parallel to the lower cheek, to break in fair with the perpendicular, drawn for the back of the figure; then the upper cheek will be formed. The upper part may run in a serpentine as high as where the shoulder of the figure is supposed to come, at which place it may be turned off with a scroll. The distance from the scroll to the heel of the figure is called the hair bracket.

The head of the block may be formed by continuing the line at the breast round to the top of the hair-bracket, observing to keep the top of it about six inches clear of the under side of the bowsprit.

Having the distance set off on the stem for placing the main rail, it may next be described, keeping the bag of it as level as possible for the conveniency of the gratings, and letting the foremost end rise gradually according to the rise of the upper cheek and hair bracket, and may turn off on the round of the scroll before drawn for the hair-bracket. To form the after end, set off the size of the head of the rail about the beak-head line, and erect a perpendicular; then describe the arch of a circle from that perpendicular, to break in fair with the lower side of the rail in the middle, and also another from the beak-head perpendicular, to break in fair with the upper side of the rail at the middle, observing to continue the head of it sufficiently high to range with the timber heads above the forecable.

The head timbers are next to be drawn, placing the stem timber its own thickness about the stem, and the foremost must be so placed that the fore side may be up and down with the heel of the block or figure, which has not yet been set off. Take therefore the distance from the breast to the heel on a square which is seven feet, and erect a perpendicular from the lower part of the lower cheek to the lower part of the upper cheek; which perpendicular will terminate the foremost end of the lower cheek and the heel of the figure, and will also terminate the lower end of the hair bracket; then, by continuing the same perpendicular from the upper part of

Application
of the fore-
going Rules
to the Con-
struction of

Ships.

the lower deck to the under part of the main-rail, the fore side of the foremost head timber will be described; and by setting off its thickness aft, the other side may be drawn. The middle head timber may be spaced between the two former ones; and there may also be one timber placed abait the stem, at a distance from the stem, equal to that between the others, and the lower end of it may step on the upper edge of the lower rail.

To describe the middle and lower rails, divide the distance between the lower part of the main rail and the upper part of the upper cheek equally at every head timber; and curves being described through these points will form the middle and lower rails. The after end of the lower rail must terminate at the after edge of the after head timber.

The cat-head ought to be represented in such a manner as to come against the aft side of the head of the main rail, to rake forward four inches in a foot, and to sivee up $5\frac{1}{2}$ inches in a foot, and about one foot six inches square. The lower part of it comes on the plank of the deck at the side, and the supporter under it must form a fair curve to break in with the after end of the middle rail.

The hawse holes must come between the cheeks, which is the most convenient place for them; but their place fore and aft cannot be exactly determined until they are laid down in the half-breadth plan.

The knee of the head is to project from the breast of the figure about two inches; and particular care must be taken that in forming it downwards it be not too full, as it is then liable to rub the cable very much: it may therefore have no more substance under the lower cheek at the heel of the figure than is just sufficient to admit of the bobstay holes, and may be $3\frac{1}{2}$ feet distant from the stem at the load water-line, making it run in an agreeable serpentine line from the breast down to the third water line, where it may be $1\frac{1}{2}$ feet from the stem. By continuing the same line downwards, keeping it more distant from the stem as it comes down, the *gripe* will be formed. The lower part of it must break in fair with the under part of the false keel; and the breadth of the gripe at the broadest place will be found by the proportions to be $4\frac{1}{2}$ feet. As the aft part of the gripe is terminated by the fore foot, or foremost end of the keel, it will now be proper to finish that part as follows: From the line representing the upper edge of the keel set down the depth of the keel, through which draw a line parallel to the former, and it will be the lower edge of the keel. From that point, where the aft side of the stem is distant from the upper edge of the keel by a quantity equal to the breadth of the keel at midships, erect a perpendicular, which will limit the foremost end of the keel; and the after or lower end of the stem may be represented by setting off the length of the keel from the foremost end of the keel, which may be six feet. Set down from the line representing the lower edge of the keel the thickness of the false keel, which is seven inches; and a line drawn through that point parallel to the lower edge of the keel will be the under edge of the false keel, the foremost end of which may be three inches afore the foremost end of the main keel.

The head being now finished, proceed next to the stem, the side and middle timbers of which are already drawn. From the side timber set off forward 14 feet,

the length of gallery, and draw a pencil line parallel to the side timber; draw also a line to intersect the touch of the upper counter at the side, producing it forwards parallel to the floor as far as the pencil line first drawn; and this line will represent the upper edge of the gallery rim. From which set down eight inches, the breadth of the gallery rail, and draw the lower edge of the rail. At the distance of eight inches from the fore side of the side timber draw a line parallel thereto; and from the point of intersection of this line with the upper edge of the gallery rim, draw a curve to the middle timber parallel to the touches of the upper counter, which line will represent the upper edge of the upper counter rail as it appears on the sheer draught. The lower edge of this rail may be formed by setting off its depth from the upper edge. In the same manner the lower counter rail may be described: then take the distance between that and the upper counter rail, and set it off below the rim rail; and hence the rail that comes to the lower stool may be drawn, keeping it parallel to the rim rail. Underneath that, the lower finishing may be formed, making it as light and agreeable as possible.

Set off from the middle timber on the end of the quarter-deck the projection of the balcony, which may be about two feet, and draw a line with a pencil parallel to the middle timber. On this line set off a point $1\frac{1}{2}$ inches below the under side of the quarter-deck, from which draw a curve to the side timber parallel to the upper counter rail, which curve will represent the lower side of the foot space rail of the balcony as it appears in the sheer draught.

Take the distance between the point of intersection of the upper edge of the upper counter with the middle line, and the point of intersection of the under side of the foot space rail with the middle line, which set up on a perpendicular from the upper edge of the rim rail at the foremost end. Through this point draw a line parallel to the rim rail to intersect the lower part of the foot space rail, and this line will represent the lower edge of the rail that comes to the middle stool, and will answer to the foot space rail. Then between this line and the rim rail three lights or fathes may be drawn, having a muntin or pillar between each light of about 14 inches broad, and the lower gallery will be finished. Set off the depth of the middle stool rail above the line already drawn for the lower edge, and the upper edge may be drawn. Then set off the same depth above the curve drawn for the lower edge of the foot space rail, and the upper edge of that rail may then be drawn.

The quarter-piece must be next described, the heel of which must step on the after end of the middle stool. Draw a line with a pencil parallel to the middle timber, and at a distance therefrom, equal to the projection of the balcony. Upon this line set up from the round-house deck the height of the upper part of the stem or taff rail, which may be four feet above the deck. At that height draw with a pencil a horizontal line, and from its intersection with the line first drawn describe a curve to the middle stool rail, observing to make the lower part of this curve run nearly parallel to the side timber, and the lower part about three inches abait the side timber; and this curve will represent the aft side of the quarter-piece at the outside. There set off the thick-

Application
of the fore-
going Rules
to the Con-
struction of
Ships.

Application of the foregoing Rules to the Construction of Ships.

ness of the quarter-piece, which is one foot six inches, set off the curve already drawn; and another curve being described parallel to it from the lower part to the top of the sheer, and the quarter-piece at the outside will be represented. On the horizontal line drawn for the upper part of the taff-rail set off forward the thickness of the taff-rail, which is one foot; then draw a curve down to the head of the quarter-piece parallel to the first, and that part of the taff-rail will be described. Instead of a fair curve, it is customary to form the upper part of the taff-rail with one or two breaks, and their curves inverted. Either way may, however, be used according to fancy.

Set off the depth of the taff-rail, which may be about $3\frac{1}{2}$ feet, on the line drawn for the projection; from the upper part, and from this point, describe a curve as low as the heel of the quarter-piece, and about five inches abaft it at that place; observing to make it run nearly parallel to the after edge of the quarter-piece; and the after part of the quarter-piece, which comes nearest to the side, will be represented.

Set up on the line drawn for the projection of the balcony the height of the upper part of the balcony or breast rail, which is $3\frac{1}{2}$ feet from the deck; set off the thickness of the rail below that, and describe the balcony, keeping it parallel to the foot space rail, and terminating it at the line drawn for the after part of the quarter-piece nearest the side; and the whole balcony will then be represented.

The upper gallery is then to be described. In order to this, its length must be determined, which may be 11 feet. Set off this distance from the side timber forward with the sheer; and at this point draw a line parallel to the side timber, which line will represent the fore part of the gallery. Then take the distance between the upper part of the foot space rail and the upper part of the breast rail on a perpendicular, and set it off on a perpendicular from the upper part of the middle stool rail on the line drawn for the fore part of the gallery, from which to the fore part of the quarter-piece draw a straight line parallel to the rail below, which line will be the upper edge of the upper rim rail; and its thickness being set off, the lower edge may also be drawn. From the upper edge of that rail set up an extent equal to the distance between the lower rim rail and middle stool rail, and describe the upper stool rail, the after end of which will be determined by the quarter-piece, and the fore end by the line for the length of the gallery. There may be three fathoms drawn between these two rails as before; and hence the upper gallery will be formed.

The upper finishing should be next drawn, the length of which may be $1\frac{1}{2}$ foot less than the upper gallery. Draw a line parallel to the rake of the stern for the fore end of it, and let the upper part of the top side be the upper part of the upper rail, from which set down three inches for the thickness of the rail, and describe it. Describe also another rail of the same length and thickness as the former, and eight inches below; from the end of which a serpentine line may be drawn down to the upper stool rail, and the upper finishing will be completed.

The stern being now finished, the rudder only remains to be drawn. The breadth of the rudder at the lower part is to be determined from the proportions, and

set off from the line representing the aft part of the stern-post; which line also represents the fore part of the rudder. Then determine on the lower lance, letting it be no higher than is just sufficient, which may be about one foot above the load water-line, and set off its breadth at that place taken from the proportions. Then a line drawn from thence to the breadth let off at the lower part will be the aft side of the rudder below the lower lance. There may also be another lance about the height of the lower deck. The use of these breaks or lances is to reduce the breadth as it rises toward the head. The aft part may be drawn above the lower lance, the break at the lower lance being about ten inches, and the break at the upper lance six inches.—The back may be then drawn. It is of elm, about four inches thick on the aft part. That thickness being set off, and a line drawn from the lower lance to the lower end, will represent the back. The head of the rudder should be as high as to receive a tiller above the upper deck. Therefore set off the size of the head above the upper deck, and draw a line from thence to the break at the upper lance, and the aft part of the rudder will be represented all the way up. The bearding should be drawn, by setting off the breadth of it at the keel from the fore side of the rudder, which may be nine inches. Set off also the breadth at the head of the wing transom, which may be a foot. Then a line being drawn through these two points, from the lower part of the rudder to about a foot above the wing transom, and the bearding will be represented. As the bearding is a very nice point, and the working of the rudder depending very much upon it, it should always be very particularly considered. It has been customary to beard the rudder to a sharp edge at the middle line, by which the main piece is reduced more than necessary. The rudder should, however, be bearded from the side of the pintles, and the fore side made to the form of the pintles.

The pintles and braces may next be drawn. In order to which determine the place of the upper one, which must be so disposed that the straps shall come round the head of the standard, which is against the head of the stern-post on the gun-deck, and meet at the middle line. By this means there is double security both to the brace and standard. To obtain these advantages, it will therefore be placed about four inches above the wing transom: the second must be placed just below the gun-deck so as to bolt in the middle of the deck transom, and the rest may be spaced equally between the lower one, which may be about six inches above the upper edge of the keel. The number of them is generally seven pair upon this class of ships; but the number may be regulated by the distance between the second and upper one, making the distance between the rest nearly the same. The length of all the braces will be found by letting off the length of the lower one, which may be eight feet above the back of the stern-post, and also the length of the third, which is four feet and a half above the back of the stern-post; and a line drawn from the one extremity to the other will fit the intermediate ones, as will appear on the sheer draught. The braces will seem to diminish in length very much as they go up; but when measured or viewed on the slope of the body, they will be nearly of an equal length. The length of the straps of the pintles should

Application of the foregoing Rules to the Construction of Ships.

A rudder come upon the rudder may all be within four inches of the aft side of the rudder; and the rudder being a flat surface, they will all appear of the proper thickness.

II. *Of the half-breadth and body plans.*—The half-breadth plan must be first drawn. They produce the lower edge of the keel both ways, and let it also represent the middle line of the half-breadth plan. Produce all the frames downwards, and also the fore and after perpendiculars. Then fix in the place in the sheer-plan, where the height of breadth-lines intersect the stem, square down to the middle line the fore and aft part of the rabbet and the fore part of the stem. Take from the dimensions what the stem is sided at that place, and set off half of it from the middle line in the half-breadth plan, through which draw a line parallel to the middle line through the three lines squared down, and the half breadth of the stem will be represented in the half-breadth plan. Take the thickness of the plank of the bottom which is $4\frac{1}{2}$ inches, and describe the rabbet of the stem in the half-breadth plan.

From the points of intersection of the height of breadth lines with the counter timber at the side, and with the counter timber at the middle line, draw lines perpendicular to the middle line of the half-breadth plan, from which set off the half breadth of the counter on the line first drawn; and from this point to the intersection of the line last drawn, with the middle line draw a curve, and the half breadth of the counter will be represented at the height of breadth, which will be the broadest part of the stem.

Take the main half breadth of timber dead flat from the dimensions, and lay it off from the middle line on dead flat in the half-breadth plan. Take also from the dimensions the main half breadth of every timber, and set off each from the middle line on the corresponding timbers in the half-breadth plan. Then a curve drawn from the end of the line representing the half breadth of the counter through all the points, set off on the timbers, and terminating at the aft part of the stem, will be the main half-breadth line. Take from the dimensions the top-timber half breadth, and describe the top-timber half-breadth line in the half-breadth plan, in the same manner as the main half-breadth line.

Take from the dimensions the half breadth of the rising, and set it off from the middle line on the corresponding timbers in the half-breadth plan, observing, where the word *outside* is expressed in the tables, the half breadth for that timber must be set off above or on the outside of the middle line. Then a curve drawn through these points will be the half breadth of rising in the half-breadth plan.

It will now be necessary to proceed to the body plan. Draw a horizontal line (fig. 35.), which is called the *base line*, from the right hand extremity of which erect a perpendicular. Then set off on the base line the main half breadth at dead flat, and erect another perpendicular, and from that set off the main half breadth again, and erect a third perpendicular. The first perpendicular, as already observed, is called the side line of the fore body; the second the middle line; and the third the side line of the after body.

Take from the dimensions the heights of the diagonals up the middle line, and set them from the base up the middle line in the body plan. Take also their di-

stances from the middle line on the base, and set them off. Set off also their heights up the side lines, and draw the diagonals. Then take from the sheer plan the heights of the lower height of breadth line, and set them off upon the middle line in the body plan; through these points lines are to be drawn parallel to the base, and terminating at the side lines. In like manner proceed with the upper height of breadth line.

The rising is next to be set off on the body plan; it must, however, be first described in the sheer plan: Take, therefore, the heights from the dimensions, and set them off on the corresponding timbers in the sheer plan, and a curve described through these points will be the rising line in the sheer plan. Then take from the dimensions the rising heights of dead flat. Set it off in the body plan, and draw a horizontal line. Now take all the rising heights from the sheer plan, and set them off in the body plan from the line drawn for the rising height of dead flat, and draw horizontal lines through these points. Take from the half-breadth plan the half breadths of the rising, and set them off from the middle line in the body plan, and the centres of the floor sweeps of the corresponding timbers will be obtained.

From the half-breadth plan take the main half-breadth lines, and set them off from the middle line in the body plan on the corresponding lines before drawn for the lower height of breadth; and from the extremities of these lines set off towards the middle line the lengths of the lower breadth sweeps respectively.

Take from the dimensions the distance of each frame from the middle line on the diagonals, and set them off from the middle line on their respective diagonal lines. Now these distances being set off, and the lower breadth and floor sweeps described, the shape of the frames below the breadth line may easily be drawn as follows: Place one point of a compass in the distance set off for the length of the lower breadth sweep, and extend the other to the point which terminates the breadth, and describe an arch of a circle downwards, which will intersect the points set off on the upper diagonal lines, letting it pass as low as convenient. Then fix one point of the compass in the centre of the floor sweep, and extend the other to the point set off on the fourth diagonal, which is the floor head; and describe a circle to intersect as many of the points set off on the diagonals as it will. Then draw a curve from the back of the lower breadth sweep, through the points on the diagonals, to the back of the floor sweep. Describe also another curve from the back of the floor sweep through the points on the lower diagonals, and terminating at the upper part of the rabbet of the keel, and that part of the frame below the breadth will be formed. In like manner describe the other frames.

Through the extremities of the frames at the lower height of breadth draw lines parallel to the middle line, and terminating at the upper height of breadth line, and from thence set off the upper breadth sweeps; now fix one point of the compass in the centres of the upper breadth sweeps successively, and the other point to the extremities of the frames, and describe circles upwards. Then from the sheer plan take off the heights of the top-timber lines, and set them off in the body plan, drawing horizontal lines; upon which set off the top-timber half breadths taken from the corresponding tim-

Application
of the fore-
going Rules
to the Con-
struction of
Ships.

Application
of the fore-
going Rules
to the Con-
struction of
Ships.

Application
of the fore-
going Rules
to the Con-
struction of
Ships.

bers in the half-breadth plan; and by describing curves from the back of the upper breadth sweeps through the points set off on the seventh or upper diagonal; and intersecting the top-timber half-breadths, the timbers will then be formed from the keel to the top of the side.

The upper end of the timbers may be determined by taking the several heights of the upper part of the top side above the top-timber line, and letting them off above the top-timber line on the corresponding timbers in the body plan. The lower parts of the timbers are ended at the rabbet of the keel as follows: With an extent of four inches and a half, the thickness of the bottom, and one leg of the compasses at the place where the line for the thickness of the keel intersects the base line; with the other leg describe an arch to intersect the keel line and the base. Then fix one point at the intersection of the arch and keel, and from the point of intersection of the keel and base describe another arch to intersect the former. Then from the intersection of these arches draw one straight line to the intersection of the keel and base, and another to the intersection of the lower arch and the keel, and the rabbet of the keel will be described at the main frame. All the timbers in the middle part of the ship which have no riving terminate at the intersection of the upper edge of the rabbet with the base line; but the lower part of the timbers, having a riving, end in the centre of the rabbet, that is, where the two circles intersect. Those timbers which are near the after end of the keel must be ended by setting off the half breadth of the keel at the port in the half-breadth plan, and describe the tapering of the keel. Then at the corresponding timbers take off the half breadth of the keel; set it off in the body plan, and describe the rabbet as before, letting every timber end where the two circles for its respective rabbet intersect.

To describe the side counter or stern timber, take the height of the wing transom, the lower counter, upper counter, and top-timber line at the side; from the sheer plan transfer them to the body plan, and through these points draw horizontal lines. Divide the distance between the wing transom and lower counter into three equal parts, and through the two points of division draw two horizontal lines. Draw also a horizontal line equidistant from the upper counter and the top-timber line in the sheer plan, and transfer them to the body plan.

Now, from the point of intersection of the aft side of the stern timber at the side, with the wing transom at the side in the sheer plan, draw a line perpendicular to the middle line in the half-breadth plan. Draw also perpendicular lines from the points where the upper and lower transoms touch the stern-post; from the points of intersection of the stern timber with the two horizontal lines drawn between, and from the intersection of the stern timber with the horizontal line drawn between the upper counter and top-timber line. Then curves must be formed in the half-breadth plan for the shape of the body at each of these heights. In order to which, begin with the horizontal or level line representing the height of the wing transom in the body plan. Lay a slip of paper to that line, and mark on it the middle line and the timbers 37, 35, 33, and 29; transfer the slip to the half-breadth plan, placing the point marked on it for the middle line exactly on the middle in the

half-breadth plan, and set off the half breadths on the corresponding timbers 37, 35, 33, and 29, and describe a curve through these points, and to intersect the perpendicular drawn from the sheer plan. In like manner proceed with the horizontal lines at the heights of the counters, between the lower counter and wing transom, above the upper counter and top-timber line; and from the intersections of the curve drawn in the half-breadth plan, with the perpendicular lines drawn from the sheer plan, take the distances to the middle line, and set them off on the corresponding lines in the body plan; then a curve described through the several points thus set off will be the representative of the item timber.

The round-up of the wing transom, upper and lower counter, may be taken from the sheer draught, and set off at the middle line above their respective level lines in the body plan, by which the round-up of each may be drawn. The round aft of the wing transom may also be taken from the sheer plan, and set off at the middle line, about the perpendicular for the wing transom in the half-breadth plan, whence the round aft of the wing transom may be described.

The after body being now finished, it remains to form the fore body; but as the operation is nearly the same in both, a repetition is therefore unnecessary, except in those parts which require a different process.

The foremost timbers end on the stem, and consequently the method of describing the ending of them differs from that used for the timbers used in the after body. Draw a line in the body plan parallel to the middle line, at a distance equal to the half of what the stem is sided. In the sheer plan take the height of the point of intersection of the lower part of the rabbet of the stem with the timber which is required to be ended, and set it off on the line before drawn in the body plan. Then take the extent between the points of intersection of the timber with the lower and upper parts of the rabbet, and with one leg of the compasses at the extremity of the distance laid off in the body plan describe a circle, and the timbers may then pass over the back of this circle. Now, by applying a small square to the timber, and letting the back of it intersect the point set off for the lower part of the rabbet, the lower part of the rabbet and the ending of the timbers will be described.

The foremost timbers differ also very much at the head from those in the after body: For since the ship carries her breadth so far forward at the top-timber line, it therefore occasions the two foremost frames to fall out at the head beyond the breadth, whence they are called *knuckle* timbers. They are thus described: The height of the top-timber line being set off in the body plan, set off on it the top half breadth taken from the half-breadth plan, and at that place draw a perpendicular; then from the sheer plan take the height of the top of the side, and set it off on the perpendicular in the body plan: Take also the breadth of the rail at the top-timber line in the sheer plan, and set it off below the top-timber line at the perpendicular line in the body plan, and the straight part of the knuckle timber to be drawn will be determined. Then from the last-mentioned point set off describe a curve through the points set off for the timber down to the upper breadth, and the whole knuckle timber will be formed. It will

Application of the foregoing Rules to the Construction of Shps.

hence be seen that those timbers forward will fall out beyond the main breadth with a hollow, contrary to the rest of the top side, which falls within the main breadth with a hollow.

The fore and after bodies being now formed, the water lines must next be described in the half-breadth plan, in order to prove the fairness of the bodies. In this draught the water lines are all represented parallel to the keel; their heights may, therefore, be taken from the sheer plan, and transferred to the body plan, drawing horizontal lines, and the water lines will be represented in the body plan. In ships that draw more water abaft than afore, the water lines will not be parallel to the keel; in this case, the heights must be taken at every timber in the sheer plan, and set off on their corresponding timbers in the body plan; and curves being described through the several points, will represent the water lines in the body plan.

Take the distances from the middle line to the points where the water lines intersect the different timbers in the body plan, and set them off on their corresponding timbers in the half-breadth plan. From the points where the water lines in the sheer plan intersect the aft part of the rabbet of the sternpost draw perpendiculars to the middle line of the half-breadth plan, and upon these perpendiculars set off from the middle line the half thickness of the sternpost at its corresponding water line; which may be taken from the body plan, by setting off the size of the post at the head and the keel, and drawing a line for the tapering of it; and where the line so drawn intersects the water lines, that will be the half thickness required: then take an extent in the compasses equal to the thickness of the plank, and fix one point where the half thickness of the post intersects the perpendicular, and with the other describe a circle, from the back of which the water lines may pass through their respective points set off, and end at the fore part of the half-breadth plan, proceeding in the same manner as with the after part. A line drawn from the water line to the point set off for the half thickness of the post will represent the aft part of the rabbet of the post; and in like manner the rabbet of the stem may be represented. The water lines being all described, it will be seen if the body is fair; and if the timbers require any alteration, it should be complied with.

The cant-timbers of the after body may next be described in the half-breadth plan; in order to which the cant of the fashion-piece must first be represented. Having therefore the round aft of the wing transom represented in the half-breadth plan, and also the shape of a level line at the height of the wing transom; then set off the breadth of the wing transom at the end, which is one foot four inches, and that will be the place where the head of the fashion-piece will come: now to determine the cant of it, the shape of the body must be considered; as it must be canted in such a manner as to preserve as great a straightness as is possible for the shape of the timber, by which means the timber will be much stronger than if it were crooked; the cant must also be considered, in order to let the timber have as little bevelling as possible. Let, therefore, the heel of the timber be set off on the middle line, two feet afore timber 35; and then drawing a line from thence to the point set off on the level line for the wing transom, the

cant of the fashion-piece will be described, and will be before situated in the best manner possible to answer the before mentioned purposes.

The cant of the fashion-piece being represented, the cant of the other timbers may now be easily determined. Let timber 29 be the foremost cant timber in the after body, and with a pencil draw timber 28; then observe how many frames there are between timber 28 and the fashion-piece, which will be found to be nine, namely, 29, 30, 31, 32, 33, 34, 35, 36, and 37. Now divide the distance between timber 28 and the fashion-piece on the middle line into 12 equal parts: Divide also the corresponding portion of the main half-breadth lines into the same number of equal parts; and straight lines joining the corresponding points at the middle line with those in the half-breadth line will represent the cant timbers in the after body.

The line drawn for the cant of the fashion-piece represents the aft side of it, which comes to the end of the transoms; but in order to help the conversion with regard to the lower transoms, there may be two more fashion-pieces abaft the former; therefore the foremost fashion-piece, or that which is already described in the half-breadth plan, may only take the ends of the three upper transoms, which are, the wing, filling, and deck: the middle fashion-piece may take the four next, and the after fashion-piece the lower ones: therefore set off in the half-breadth plan the siding of the middle and after fashion-piece, which may be 13 inches each; then by drawing lines parallel to the foremost fashion-piece, at the aforesaid distance from each other, the middle and after fashion-piece will be represented in the half-breadth plan.

The fashion-piece and transoms yet remain to be represented in the sheer plan; in order to which, let the number of transoms be determined, which, for so large a buttock, may be seven below the deck transom: draw them with a pencil, beginning with the wing, the upper side of which is represented by a level line at its height; set off its siding below that, and draw a level line for the lower edge. The filling transom follows; which is merely for the purpose of filling the vacancy between the under edge of the wing and the upper part of the deck plank: it may therefore be represented by drawing two level lines for the upper and lower edge, leaving about two inches between the upper edge and lower edge of the wing transom, and four inches between the lower edge of the gun-deck plank; then the deck transom must be governed by the gun-deck, letting the under side of the gun-deck plank represent the upper side of it, and setting off its siding below that; the under edge may also be drawn: the transoms below the deck may all be sided equally, which may be 11 inches; they must also have a sufficient distance between to admit the circulation of the air to preserve them, which may be about three inches.

The transoms being now drawn with a pencil, the fashion-piece must next be described in the sheer plan, by which the length of the transoms as they appear in that plan will be determined. As the foremost fashion-piece reaches above the upper transom, it may therefore be first described: in order to which, draw a sufficient number of level lines in the sheer plan; or, as the water lines are level, draw therefore one line between the upper water line and the wing transom, and one above

Application of the foregoing Rules to the Construction of Shps.

Application of the foregoing Rules to the Construction of Ships.

the wing transom at the intended height of the head of the fashion-piece, which may be about five feet: then take the height of these two level lines, and transfer them to the body plan: and take off two or three timbers and run them in the half-breadth plan, in the same manner as the water lines were done; then from the point where the line drawn for the cant of the fashion-piece, in the half-breadth plan, intersects the level line drawn for the head of the fashion-piece, draw up a perpendicular to the said line in the sheer plan, making a point. Again, from the intersection of the cant line, with the level line for the wing transom in the half-breadth plan, draw a perpendicular to the wing transom in the sheer plan. Also draw perpendiculars from the points where the cant line in the half-breadth plan intersects the level line below the wing transom, and also the water lines to the corresponding lines in the sheer plan; then a curve described through these points will be the representation of the foremost fashion-piece in the sheer plan. In the same manner the middle and after fashion-pieces may be described; observing to let the middle one run up no higher than the under part of the deck transom, and the after to the under side of the fourth transom under the deck. The transoms may now be drawn with ink, as their lengths are limited by the fashion-pieces.

Neither the head nor the fore-side of the stem-post are yet described; take, therefore, from the dimensions, the breadth of the post on the keel, and set it off on the upper edge of the keel from the aft side of post. The head of the post must next be determined, which must just be high enough to admit of the helm-post transom and the tiller coming between it and the upper deck beam; the height therefore that is necessary will be one foot nine inches above the wing transom. Now draw a level line at that height, upon which set off the breadth of the stem-post at that place, taken from the dimensions, and a line drawn from thence to the point set off on the keel will be the fore-side of the stem-post; observing, however, not to draw the line through the transoms, as it will only appear between them. The inner post may be drawn, by setting off its thickness forward from the stem-post, and drawing a straight line as before, continuing it no higher than the under side of the wing transom.

The cant timbers in the after body being described, together with the parts dependent on them, those in the fore body may be next formed; in order to which, the foremost and aftermost cant timbers must be first determined, and also the cant of the foremost ones. The foremost cant timber will extend so far forward as to be named *S*; the cant on the middle line may be one foot four inches afore square timber *W*, and on the main half-breadth line one foot nine inches afore timber *Y*; in which situation the line may be drawn for the cant; the aftermost may be timber *Q*. The cant timbers may now be described in the same manner as those in the after body, namely, by spacing them equally between the cant timber *S* and the square timber *P*, both on the main half-breadth, and middle lines, and drawing straight lines between the corresponding points, observing to let them run out to the top-timber half-breadth line, where it comes without the main half-breadth line.

The hawse pieces must next be laid down in the half-breadth plan; the sides of which must look fore and aft

with the ship, upon account of the round of the bow. Take the siding of the apron, which may be about four inches more than the stem, and set off half of it from the middle line, drawing a line from the main half-breadth to the foremost cant timber, which will represent the foremost edge of the knight-head; then from that set off the siding of the knight-head, which may be one foot four inches, and draw the aft side of it. The hawse pieces may then be drawn, which are four in number, by setting off their sidings, namely, one foot six inches parallel from the knight-head and from each other; and straight lines being drawn from the main half-breadth line to the foremost cant timber will represent them.

The hawse holes should be described in such a manner as to wound the hawse pieces as little as possible; they may therefore be placed so that the joint of the hawse pieces shall be in the centre of the holes, whence they will only cut half the hawse pieces. Take the dimensions of the hawse holes, which is one foot six inches, and set off the foremost one, or that next the middle line, on the joint between the first and second hawse piece; then set off the other on the joint between the third and fourth hawse piece; and small lines being drawn across the main half-breadth at their respective places will represent the hawse holes in the half-breadth plan.

The hawse holes should next be represented in the sheer plan. In this class of ships they are always placed in the middle between the cheeks; therefore set off their diameter, namely, one foot six inches, between the cheeks, and draw lines parallel to the cheeks for their upper and lower part. Then to determine their situation agreeable to the half-breadth plan, which is the fore and aft way, draw perpendiculars from their intersections with the main half-breadth line to the lines drawn between the cheeks, and their true situations, the fore and aft way, will be obtained; and, by describing them round or circular, according to the points set off, they will be represented as they appear in the sheer plan.

The apron may be drawn in the sheer plan, setting off its bigness from the stem, and letting it come so low that the scarf may be about two feet higher than the foremost end of the fore foot; by which it will give ship to the keels of the stem. It may run up to the head of the stem.

The cutting down should next be drawn. Take therefore from the tables of dimensions the different heights there expressed, and set them off from the upper edge of the keel on the corresponding timbers in the sheer plan; then a curve described through the points set off, from the inner post aft to the apron forward, will be the cutting down. Next set off from the cutting down the thickness of the timber stake, which is eight inches and a half, and a curve described parallel to the former will represent the timber stake, from which the depth of the hold is always measured.

The keelson is drawn, by taking its depth from the dimensions, and set it off above the cutting down line; and a curve described parallel to the cutting down will represent the keelson.

The cutting down line being described, the knee of the dead wood abaft timber 27, being the after floor timber, may then be represented. Set off the siding of the floor abaft it, and erect a perpendicular in the sheer plan, which will terminate the foremost end of

the dead wood: then the fore and aft arm of the knee may be half the length of the whole dead wood, and the up and down arm may reach to the under part of the lower transom; and the whole knee may be placed in such a manner that the upper piece of the dead wood shall bow over it, and be of as much substance as the knee itself: therefore the knee must consequently be placed its whole thickness below the cutting down line representing the upper part of the dead wood.

The sheer draught, the body, and half-breadth pl are now finished, from whence the ship may be laid down in the mould loft, and also the whole frame erected. As, however, the use of the diagonal lines in the body plan has not been sufficiently explained, it is therefore thought proper to subjoin the following illustration of them.

The diagonal lines in the body plan are mentioned in the tables of dimensions merely for the purpose of forming the body therefrom; but after the body is formed, they are of very principal use, as at their stations the ribbands and harpins which keep the body of the ship together while in her frames are all described, and the heads of the different timbers in the frame likewise determined.

The lowermost diagonal, or N^o 1. which is named the *lower firmark*, at which place the bevellings are taken for the hollow of the floors; its situation is generally in the middle between the keel and the floor firmark.

Second diagonal is placed in the midships, about 18 inches below the floor head, and is the station where the floor ribband is placed in midships, and likewise the floor harpin forward; there is also a bevelling taken at this diagonal all the way fore and aft, from which it is termed the *floor firmark*.

Third diagonal, terminates the length of the floors, and is therefore called the *floor head*. There are likewise bevellings taken at this diagonal as far forward and aft as the floor extends. The placing of this diagonal is of the utmost consequence to the strength of the ship, it being so near to that part of the bulge which takes the ground, and of consequence is always liable to the greatest strain; it should therefore be placed as much above the bearing of the body in midships as could be conveniently allowed by conversion of the timber; but fore and abaft it is not of so much consequence.

Fourth diagonal is placed in the middle between the floor head and the fifth diagonal, at which place a ribband and harpin are stationed for the security of the first or lower futtock, from whence it is named the *first futtock firmark*. There are also bevellings taken at this diagonal all fore and aft, which being part of the body where the timbers most vary, occasions them to be the greatest bevellings in the whole body.

Fifth diagonal terminates the heads of the first futtocks, and is therefore called the *first futtock head*. It should be placed at a convenient distance above the floor head, in order to give a sufficient scarf to the lower part of the second futtocks. There are likewise bevellings for the timbers taken at this diagonal, all fore and aft.

Sixth diagonal should be placed in the middle between the first futtock head and the seventh diagonal; at which place the ribband and harpin are stationed for the support of the second futtocks. Bevellings are taken at

this diagonal all fore and aft. It is named the *second futtock firmark*.

Seventh diagonal terminates the second futtock head, from the fore to the aftermost floors, and afore and abaft them it terminates the double futtock heads in the fore and aft cant bodies. It should be placed in midships, as much above the first futtock head as the first futtock is above the floor head: by which it gives the same scarf to the lower part of the third futtock as the first futtock does to the second. There are bevellings taken all fore and aft at this diagonal. It is named the *second futtock head*.

Eighth diagonal is the station for the ribband and harpin which supports the third futtocks, and is therefore placed between the second futtock head and ninth diagonal. It is also a bevelling place, and is named the *third futtock harpin*.

Tenth and last diagonal is placed the same distance above the second futtock head as that is above the first, and terminates all the heads of the third futtocks which are in the frames, as they come between the ports; but such as are between the frames, and come under the lower deck ports, must run up to the under part of the ports, as no short timbers should by any means be admitted under the ports, which require the greatest possible strength. This diagonal is likewise a bevelling place for the heads of the third futtocks, and is therefore called the *third futtock head*.

The fourth futtock heads are terminated by the under part of the upper deck ports all fore and aft, and a ribband is placed fore and aft at the height of the upper breadth line, another between the lower and upper deck ports, and one at the top-timber line; which, with the ribbands and harpins before mentioned, keep the whole body of the ship together, and likewise in its proper form and shape.

It must be observed, that the diagonal lines laid down in the dimensions will not correspond to what has been said above upon diagonals, as they were drawn directionally upon the body for the purpose of giving the true dimensions of it. Therefore, when the body is drawn in fair, the first diagonals (which should only be in pencil) are to be rubbed out, and the proper diagonals drawn with red ink, strictly adhering to what has been said above.

SECT. III. Of the Inboard Works of the Ship described in the preceding Section.

DRAGHTS of the outboard works being now constructed, in which every part is described that is necessary to enable the artist to put the ship in her frames, we must now proceed to form another draught of the cavity of the ship or inboard works, which must be so contrived that every thing within the ship may be arranged in the most commodious manner and to the best advantage.

It is usual to draw the inboard works in the sheer-draught; but as this generally occasions much confusion, it is therefore the best and easiest method to appropriate a draught to this particular purpose.

Take from the sheer-draught the stem, stern-post, counter timbers, and keel, and describe them on another paper; draw in also the cutting down, keelson, apron, transoms, fashion-pieces, and decks, and the upper line of the sheer all fore and aft, also pass the timbers and ports.

Application
of the fore-
going Rules
to the Con-
struction of
Ships.

The beams come first under consideration, and should be so disposed as to come one under and one between each port, or as near as can be to answer other works of the ship; but where it happens that a beam cannot possibly be placed under the port, then a beam arm should be introduced to make good the deficiency. Every beam, and also the beam arms, should be kneed at each end with one lodging and one hanging knee; and in those parts of the ship which require the knees to be very acute, such as the after beams of the gun-deck, and in some ships, whose bodies are very sharp, the foremost beams of the gun-deck, there should be knees of iron. Care should be taken always to let the upper side of the knees be below the surface of the beams, in large ships one inch and a half, and in small ships an inch, by which means the air will have a free passage between the knees and under part of the deck.

In the conversion of the beams the side next the lodging knee should be left as broad at the end of the beam as can possibly be allowed by the timber, the beam retaining its proper scantling at the end of the lodging knee: by so doing the lodging knees will be more without a square, which consequently makes them the more easy to be provided.

In ships where the beams can be got in one piece, they should be so disposed as to have every other one with the butt end the fame way; for this reason, that the butts will decay before the tops. In large ships the beams are made in two or three pieces, and are therefore allowed to be stronger than those that are in one piece. The beams in two pieces may have the scarf one-third of the length, and those in three pieces should have the middle piece half the length of the whole beam. The customary way of putting them together is to table them; and the length of the tablings should be one-half more than the depth of the beam. It is very common to divide the tablings in the middle of the beam, and that part which is taken out at the upper side to be left at the lower side, and then kerley or flannel is put into the scarf: but in this case the water is liable to lie in the scarf, and must be the means of rotting the beams. If, however, the beams were tabled together in dovetails, and taken through from side to side, putting tar only between them, which hardens the wood; then the water occasioned by the leaking of the decks would have a free passage, and the beam would dry again; and this method would not be found inferior in point of strength to the other. The length of the fore and aft arm of the lodging knee should extend to the side of the hanging knee next to it; but there is no necessity for that arm to be longer than the other. In fattening the knees, care would be taken to let one bolt pass exactly through the middle of the throat, one foot six inches from each end, and the rest divided equally between; observing always to have the holes bored square from the knee. The bolts for the thwartship arms of both hanging and lodging knees may go through the arms of each knee, and drive every one the other way.

In order to draw the beams in the draught, take the moulding of the lower deck beams, and set it off below the line representing the deck at the side, and draw a line in pencil parallel thereto, which will represent the under side of the beams. In like manner represent the

under side of the beams for the upper deck, quarter deck, forecalle, and roundhouse. Then take the siding of the lower deck beams, and place one under and one between each port, all fore and aft, drawing them in pencil. Determine the dimensions of the well fore and aft, which is ten feet, and set it off abait the beam: under the eighth port, placing the beam under the ninth port at that distance: those two beams may then be drawn in ink, and will terminate the extent of the well fore and aft way; and as a beam cannot go across the ship at that place upon account of its being the well and main room, there must therefore be a beam arm between these two beams.

The main hatchway should then be determined, letting the beam that forms the fore part of the well form the aft part of it, and the beam under the next part may form the fore side of it, which beam may also be now drawn in ink: there should also be another beam arm introduced in the wake of the main hatchway.

The fore hatchway may be next determined; the fore side of which should range well up and down with the after end of the forecalle, and it may be fore and aft about four-sevenths of the main hatchway. At the fore-side of the fore hatchway there must be a ladderway down to the orlop, which may be as much fore and aft as the beams will allow. The rest of the beams above the fore hatchway may remain as first placed, there being nothing in the way to alter the ship. Then determine on the after hatchway, the fore-side of which comes to the aft side of the mainmast room.

There should also be a hatchway, the fore-side of which may be formed by the aft side of the beam under the twelfth port; which is for the convenience of the spirit and fish rooms: and there should be a ladderway abait it to lead down to the cockpit. There may be also another hatchway, the fore-side of it to be formed by the aft side of the beam under the eleventh port. The size of the ladder and hatchways must be governed by the beams, as when there is a good shift of beams they should not be altered for ladder and hatchways, unless it is the three principal hatchways, which must always be of a proper size, according to the size of the ship.

The after capitan must be placed between the two hatchways last described, and the beams abait may stand as they are already shifted, observing only the mizenmast. There should be a small scuttle placed afore the second beam from aft, for the convenience of the bread room: it must be on one side of the middle lines, as there is a carling at the middle under the four or five after beams to receive the pillars for the support thereof.

The bits may be placed, letting the fore-side of the after ones come against the aft side of the beam abait the third port, and the fore-side of the foremost ones against the next beam but one forward: then at the fore-side of each bit there should be drawn a small scuttle for the convenience of handing up the powder from the magazine. The breast hook should also be drawn, which may be three feet the moulting away, and sided nine-tenths of the beams of the lower deck.

The gun-deck, beams, knees, &c. being described; in which, as well as all the decks having ports, the same precautions are to be used as in the gun-deck; and ob-

serv'g

Application
of the fore-
going Rules
to the Con-
struction of
Ships.

Application
of the fore-
going Rules
to the Con-
struction of
Ships.

servings to keep the beams upon one deck as nearly as possible over the beams of the other, for the convenience of pillaring, as they will then support each other.

The hatchways are to be placed exactly over those on the lower deck, each over each; and therefore, where there is a beam arm in the lower deck there must also be one above it in the upper deck, and the same in the middle deck in three-deck ships. It commonly happens in ships of the line that there cannot be a whole beam between the deck breast hook and the beam that supports the step of the bowsprit, because the bowsprit passes through that place: in this case, there must be a beam arm placed, letting the end come equally between the beam and the breast hook: but in ships that the bowsprit will allow of a whole beam, then the ports and the rest of the beams must be consulted in order to space it; and when it so happens that the fore mast comes in the wake of a port, then a beam arm must be necessarily introduced.

Having placed the beams according to the disposition of the other beams below, the ladderways should be contrived: there should be one next abaft the fore hatchway, which is a single ladderway, and one next afore the main hatch, which is a double ladderway; the ladders standing the fore and aft way. There should also be another next abaft the after hatch, and one over the cockpit corresponding with that on the lower deck.

The capstans are next to be considered; the after one is already placed on the lower deck, the barrel of which must pass through the upper deck to receive the whelps and drumhead there, it being a double capstan. In ships having three decks, the upper part of each capstan is in the middle deck; but in ships with one deck there is only this one capstan, the upper part of which is placed on the quarter deck. The foremast capstan should be placed in the most convenient spot, to admit of its being lowered down to the orlop out of the way of the long boat: it may therefore be placed between the main and fore hatchways; the beam under the sixth port of the lower deck may form the aft side of its room, and the beams on each side of it should be placed exactly over or under the beams on the other decks, and they should be at a distance from each other sufficient to let the drumheads pass between them. The centre of the capstan should then be placed in the middle between the beams which compose its room; and the partners should be fitted in such a manner as to shift occasionally when wanted, which is by letting them be in two pieces fitted together. The partners on the lower deck, wherein the capstan steps, must be supported by a pillar on the orlop deck, the lower part of which may be fitted in an oak chock; so that when the pillar is taken away, and the capstan lowered down, that chock serves as a step for the capstan. Those two beams on the orlop, by having the pillar and chock upon them, have therefore the whole weight of the capstan pressing downwards: for the support of them, there should be a carling placed underneath the fore and aft way, with three pillars, one under each beam, and one between: all of them being fixed in the keelson, by which the orlop deck will be well supported in the wake of the capstan, and the other decks will feel no strain from it.

The fire hatch is next to be disposed; which is applied differently according to the size of the ship. In three-deckers it is found most convenient to place it on the middle deck; whence there is much more room under the forecalle than there would have been had it been placed diere. In all two-deck ships it is placed under the forecalle, because on the deck underneath the bits are in the way. It is also under the forecalle in one-deck ships, though confined between the bits: in this case it should be kept as near as possible to the after bits, that there may be more room between it and the foremost bits to make a good galley.

The positions of the main-top-sail-sheet bits are next to be determined; the foremast of which must be so placed as to let its fore-side come against the aft side of the beam abaft the main hatchway, and to pass down to the lower deck, and there step in the beams: admitting it to be a straight piece, it would come at the aft side of the lower deck beam the same as it does at the upper deck beam, in consequence of those two beams ranging well up and down with each other: it must therefore have a cut under the upper deck beam, by which the lower part may be brought forward sufficient to step in the lower deck beam. The aftermast must be placed against the fore-side of the beam abaft the mast, and step on the beam below; but there is no necessity to provide a crooked piece as before, for the beam of the upper deck may be moved a little farther aft, till it admit of the bit stepping on the lower deck beam, unless the beam comes under a port, as in that case it must not by any means be moved. The cross pieces to the bits should be on the fore-side, and in height from the upper deck about one-third of the height between it and the quarter deck. With regard to the heads of the bits, the length of the ship's waist should be considered; and if there is length enough from the forecalle to the foremast bits to admit of the spare gear being stowed thereon without reaching farther aft, the quarter deck may then run so far forward that the head of the foremast bits shall tenon in the foremast beam; this gives the mainmast another deck, and admits of the quarter deck being all that longer: but if there is not the room before mentioned, then the quarter deck must run no further forward than the after bits, which will then tenon in the foremast beam; and the foremast bits must have a cross piece let on their heads, which is termed a *horfe*, and will be for the purpose of receiving the ends of the spare gear.

The length of the quarter deck being now determined, the beams are then to be placed. For this purpose the several contrivances in the quarter deck must be previously consulted. It is necessary to observe, that there are neither carlings nor lodges, the carlings of the hatches excepted, in the quarter deck, nor a J-house, and forecalle; as they would weaken instead of strengthening the beams, which should be as small as the size of the ship will permit, in order that the upper works may be as light as possible. Hence, as there are to be neither carlings nor lodges, the deck will require a greater number of beams, and a good round up, as on the contrary the deck will be apt to bend with its own weight. The most approved rule is therefore to have double the number of beams in the quarter deck as there are in a space of the same length in the upper deck.

Then proceed to shift the beams to the best advantage.

Application
to the fore-
going Rules
to the Con-
struction of
Ships.

Application of the foregoing Rules to the Construction of Ships

tage, consulting the hatch ways, ladder-ways, masts, bits, wheel, &c. With respect to the ladder-ways on the quarter deck of all ships, there should be one near the fore part of the great cabin for the officers, and another near the foremast end of the quarter deck, consisting of double ladders for the conveyance of the men up from the other decks in cases of emergency; and likewise one on each side of the fore part of the quarter deck from the gangway; and in every ship of the line all the beams from the foremast ladder-way to the after one should be open with gratings, both for the admission of air, and for the greater expedition of conveying different articles in the time of action.

Two cuttles are to be disposed one on each side of the mainmast, if it happens to come through the quarter deck, for the top tackles to pass through, to hook to the eye bolts drove in the upper deck for that purpose.

The steering wheel should be placed under the forepart of the roundhouse, and the two beams of the quarter deck, which come under it, should be placed conformable to the two uprights, so that they may tenon in them. The quarter deck beams should be knee'd at each end with one hanging and one lodging knee; which adds greatly to the strength of the side. The hanging knees which come in the great cabin may be of iron; their vertical arms to be two-thirds of the length of that of wood, and to reach the spirketing. It should be observed, that the beam abaft, which comes under the foreen bulkhead, should round aft agreeable to the round of the bulkhead, for the support of the same.

The forecalle beams should be placed according as the works of the deck will admit. The hatchways are therefore to be considered first. There should be one for the funnel of the fire hearth to pass through, and one for the copper to admit of vent for the steam; and also one or two over the galley as the forecalle will admit of. The fore-top-sail-sheet bits should be so disposed as to come one pair on the fore and one on the aft side of the mast, to let into the side of the forecalle beams, and sit on the upper deck beams below: there should also be a ladder-way at the fore part of the forecalle for the conveyance of the fore part of the ship.

The beams may now be placed agreeable thereto, their number being four more than there are in a space in the upper deck equal in length to the forecalle; and where there happens to be a wide opening between the beams, as in the case of a hatchway, mast room, &c. then half a beam of fir may be introduced to make good the deficiency. The foremast beam should be of a breadth sufficient to take the aft side of the inboard arms of the catheads, as they are secured upon this beam by being bolted thereto. Every beam of the forecalle should be knee'd at each end with one hanging and one lodging knee: the vertical arms of the hanging knees should reach the spirketing, and the knees well bolted and carefully clenched.

Proceed to the roundhouse; the same things being observed with respect to the beams as in the quarter deck: for as the roundhouse beams are sided very small, it hence follows that they must be near to each other. Let therefore the number of beams on the roundhouse be four more than in the same length of the quarter

deck; every other beam being of fir for lightness, and every oak beam may be knee'd at each end with one hanging and one lodging knee; the hanging knees above may be of iron, their vertical arms to be in length two-thirds of those of wood. The roundhouse should always have a great round up, both for strength and convenience. There must be on the roundhouse a small pair of knees-bits on each side of the mizenmast, turned round and bolted over each other, and bolted through the mast catlings. There must also be a companion on the roundhouse placed over the middle of the coach, in order to give light thereto.

With regard to placing the roundhouse beams, the uprights of the steering wheel and the mizenmast are to be observed; as when the beams which interfere with those parts are properly spaced, the rest may be disposed of at discretion, or at an equal distance from each other, and letting the beam over the foreen bulkhead have a proper round aft, agreeable to the quarter deck beam underneath.

The upper parts of the inboard works being now described, proceed next to the lower parts, or to those which come below the lower deck. Draw in the orlop, by taking the heights afore, at midships, and abaft, between that and the gun-deck, from the dimensions, and a curve described through these points will represent the upper part of the deck. Set off the thickness of the plank below, and the under side of the plank will be represented. As this deck does not run quite forward and aft as the other decks, the length of it must be therefore determined; for this purpose let the after beam be placed at a sufficient distance from aft to admit of the bread rooms being of a proper size for the ship, which will be under that beam of the gun-deck that comes at the second part from aft. The after beam being drawn in, proceed to space the other beams, placing them exactly under those of the gun-deck; and that which comes under the foremast beam of the gun-deck may terminate the fore part of the orlop. Draw the limber strake, by setting off its thickness above the cutting down line, and a line drawn parallel thereto will represent the limber strake. That part of the orlop which is over the after magazine, spirit room, and fish room, and also that which is over the fore magazine, is laid with thicker planks than the rest of the deck; which is for the better security of those places, the planks being laid over the beams; but in the midships, from the fore part of the spirit room to the aft part of the fore magazine, the beams are laid level with the surface of the deck, and the planks are rabbeted in from one beam to the other.

In order to represent the orlop as just described, the dimensions of the different apartments above mentioned must be determined: Let the aft side of the after beam be the aft side of the after magazine, and from thence draw the bulkhead down to the limber strake; and the fore side of the third beam may be the fore side of the after magazine, drawing that bulkhead likewise, which will also form the aft side of the fish room; the fore side of the fifth beam may be drawn from the aft side of the fifth beam, which will also represent the aft side of the spirit room; then the fore side of the spirit room may be drawn from the fore side of the sixth beam. Hence from the fore side of the sixth beam quite aft the deck

Application will be represented by the two lines already drawn, and the upper side of the beams will be represented by the lower line.

Proceed next to the fore part of the orlop, letting the fore-side of the after bits be the aft part of the foremost magazine, drawing the bulkhead thereof, which will come to the aft side of the sixth beam; therefore, from the sixth beam to the foremost end of the orlop, the plank and beams will be represented just in the same manner as before mentioned for the after part of the orlop: then the midship part of the deck will be represented by letting the upper line be the upper side of the plank, and likewise the upper side of the beams; and the lower line will represent the lower edge of the plank, only drawing it from beam to beam, and observing not to let it pass through them.

The hatchways, &c. may now be represented on the orlop, letting the main, fore, and after hatchway, be exactly under those of the gun-deck: there must be one over the fish room, and one over the spirit room. There must be two scuttles over the after magazine for the passage to the magazine and light room. There should also be one afore the fourth beam from forward for the passage to the fore magazine, and one abaft the second beam for the passage to the light room.

The bulkheads for the fore and after parts of the well may be drawn from the lower deck beams to the orlop, and from thence to the limber strake in the hold. The shot lockers may also be represented, having one afore and one abaft the well: there should also be one abaft the foremost magazine, the ends of which may be formed by the after bits. The steps of the masts may be drawn in by continuing their centres down to the limber strake; and likewise two crutches abaft the mizen step divided equally between that and the after part of the cutting down: the breast hooks may also be drawn letting them be five in number below the lower deck hook, and all equally divided between that and the fore step. Hence every part of the inboard is described as far as necessary.

CHAP. V. Of the Method of Whole-moulding.

HAVING now finished the methods of laying down the several plans of a ship, any farther addition on this subject might appear unnecessary. We cannot, however, with propriety, omit to describe the method called *whole-moulding*, used by the ancients, and which still continues in use among those unacquainted with the more proper methods already explained. This method will be illustrated by laying down the several plans of a long-boat; the length of the keel being 29 feet, and breadth moulded nine feet.

Draw the straight line PO (fig. 37.) equal to 29 feet, the extreme length of the boat, and also to represent the upper edge of the keel. Let \oplus be the station of the midship frame. From the points, P, \oplus , and O, draw the lines PT, \oplus M, and OS, perpendicular to PO. Make \oplus M, \oplus N, equal to the upper and lower heights of breadth respectively at the main frame, PT the height of breadth at the tranform, and OS the height at the stem. Describe the curve TMS to represent the sheer or extreme height of the side, which in a ship would be called the *upper height of breadth line*, or upper edge of the wale. Through the point N draw a

curve parallel to TMS, to represent the breadth of the upper strake of a boat, or lower edge of the wale if in a ship. The dotted line TNS may also be drawn to represent the lower height of breadth.

Set off the rake of the port from P to ρ , and draw the line ρt to represent the aft side of the port; then Tt will represent the round-up of the tranform. Set off the breadth of the port from ρ to r , and from T to s, and draw the line rs to represent the fore-side of the port, which may either be a curve or a straight line at pleasure. Set up the height of the tuck from ρ to k. Let kX be the thickness of the tranform, and draw the line ZX to represent the fore-side of the tranform.

There is given the point S, the height of the sheer on the fore-side of the stem; now that side of the stem is to be formed either by sweeps or some other contrivance. Set off the breadth of the stem, and form the aft side of it.

Set up the dead-rising from \oplus to d, and form the rising line ris. Draw the line KL parallel to PO to represent the lower edge of the keel, and another to represent the thickness of the plank or the rabbet. The rabbet on the post and stem may also be represented; and the stations of the timbers assigned, as \oplus , (1), 1, 2, 3, 4, 5, 6, 7, 8, 9; and \oplus , (A), A, B, C, D, E, F, G, H; and the sheer plan will be completed.

The half-breadth plan is to be formed next; for this purpose the perpendiculars TP, 9, 8, &c. must be produced. Upon M \oplus produced let off the half breadth from the line KL to R (fig. 38.); set off also the half breadth at the tranform from K to b, and describe the extreme half-breadth line bRX, making the forepart of the curve agreeable to the proposed round of the tranform.

We may next proceed to form the timbers in the body plan. Let AB (fig. 39.) be the breadth moulded at \oplus . Erect the perpendicular CD in the middle of the line AB; draw the line mn distant therefrom the half thickness of the post, and xy the half thickness of the stem. Then take off the several portions of the perpendiculars \oplus , 1, 2, &c. intercepted between the upper edge of the keel and the rising line in the sheer plan, and set them up from C upon the line CD; through these points draw lines parallel to AC; take off also the several lower heights of breadth at \oplus , 1, 2, &c. from the sheer plan; and set them up from C upon the middle line in the body plan; and draw lines parallel to AC through these points: Then take off the several half breadths corresponding to each from the floor plan; and set them off on their proper half-breadth lines from the middle line in the body plan.

Construct the midship frame by Problem V. the form of which will in some measure determine the form of the rest. For if a mould be made on any side of the middle line to fit the curve part of it, and the rising line, or that marked *bend mould* (fig. 40.), and laid in such a manner that the lower part of it, which is straight, may be set upon the several rising lines, and the upper part just touch the point of the half breadth in the breadth line corresponding to that rising upon which the mould is placed, a curve may then be drawn by the mould to the rising line. In this manner we may proceed so far as the rising line is parallel to the lower height of the breadth line. Then a hollow mould must be made, the upper end of which is left straight, as

Method of Whole-moulding

Fig. 38.

Fig. 39.

Fig. 40.

46
Method of whole-moulding, Murray's Ship-Building.

47
App'd to a long-boat. Plate CCCXIII Fig. 37.

Method
of Whole-
moulding.

that marked *hollow mould* (fig. 45.). This is applied in such a manner, that some part of the hollow may touch the side of the keel, and the straight part touch the back of the curve before described by the bend mould; and, beginning abaft, the straight part will always come lower on every timber, till we come to the midship timber, when it comes to the side of the keel. Having thus formed the timbers, so far as the whole mouldings will serve, the timbers abaft them are next formed. Their half breadths are determined by the floor and floor plans, which are the only fixed points through which the curves of these timbers must pass. Some form these after timbers before the whole is moulded, and then make the hollow mould, which will be straighter than the hollow of either of these timbers. It is indifferent when are first formed, or what methods are used; for after the timbers are all formed, though every timber may appear very fair when considered by itself, it is uncertain what the form of the side will be. In order to find which, we must form several ribband and water lines; and if these do not make fair curves, they must be rectified, and the timbers formed from these ribband and water lines. In using the hollow mould, when it is applied to the curve of each timber, if the straight part is produced to the middle line, we shall have as many points of intersection as there are timbers; and if the heights above the base be transferred to the corresponding timbers in the sheer plan, a curve passing through these points is what is called a *rising frait*. This may be formed by fixing a point for the aftermost timber that is whole moulded, and transferring that height to the sheer plan. The curve must pass through this point, and fall in with the rising line somewhere abaft dead flat; and if the several heights of this line be transferred from the sheer to the middle line in the body plan, these points will regulate what is called the *heaving down* of the hollow mould.

The timbers in the after body being all formed, those in the fore body are formed in the same manner, by transferring the several heights of the rising and breadth lines from the sheer to the body plans; the half breadths corresponding to each height must also be transferred from the floor to the body plan. The same hollow mould will serve both for the fore and after body; and the level lines, by which the water lines to prove the after body were formed, may be produced into the fore body, and by them the water lines to prove the fore body may be described.

Another method of proving the body is by ribband lines, which are formed by sections of planes inclined to the sheer plan, and intersecting the body plan diagonally, as before observed, of which there may be as many as may be judged necessary. As this has been already explained, we shall therefore lay down only one, represented in the body plan by the lines *na* *kd* &c. These are drawn in such a manner as to be perpendicular to as many timbers as conveniently may be. After they are drawn in the body plan, the several portions of the diagonal intercepted between the middle line and each timber must be transferred to the floor plan. Thus, fix one foot of the compasses in the point where the diagonal intersects the middle line in the body plan; extend the other foot to the point where the diagonal intersects the timber; for example, timber 9: Set off the

same extent upon the perpendicular representing the plane of timber 9 from the point where it intersects the line *KL* on the floor plan; in like manner proceed with all the other timbers both in the fore and after body; and these shall have the points through which the curve must pass. If this should not prove a fair curve, it must be altered, or serving to conform to the points as nearly as the nature of the curve will admit: so it may be carried within one point, and without another, according as we find the timbers will allow. For after all the ribband lines are formed, the timbers must, if needful, be altered by the ribband lines; this is only the reverse of forming the ribband lines; for taking the portions of the several perpendiculars intercepted between the line *KL* and the curve of the ribband line in the floor plan, and setting them off upon the diagonal from the point where it intersects the middle line, we shall have the points in the diagonal through which the curves of the timbers must pass. Thus the distance between the line *KL* and the ribband at timber 3 on the floor plan, when transferred to the body plan, will extend on the diagonal from the middle line to the point where the curve of timber 3 intersects that diagonal. The like may be said of all the other timbers; and if several ribband lines be formed, they may be so contrived that their diagonals in the body plan shall be at such distances, that a point for every timber being given in each diagonal, will be sufficient to determine the form of all the timbers.

In fitting on the timbers upon the keel for a boat, there must be room for two futtocks in the space before or abaft \odot ; for which reason, the distance between these two timbers will be as much more than that between the other as the timber is broad. Here it is between \odot and (A); which contains the distances between \odot and (1), and the breadth of the timber besides.

The timbers being now formed, and proved by ribband and water lines, proceed then to form the transom, fashion-pieces, &c. by Problem VI.

This method of whole moulding will not answer for the long timbers afore and abaft. They are generally cutted in the same manner as those for a ship. In order to render this method more complete, we shall here describe the manner of moulding the timbers after they are laid down in the mould last, by a rising square, bend, and hollow mould.

It was shown before how to form the timbers by the bend and hollow moulds on the draught. The same method must be used in the loft; but the moulds must be made to their proper scantlings in real feet and inches. Now when they are set, as before directed, for moulding each timber, let the middle line in the body plan be drawn across the bend mould, and draw a line across the hollow mould at the point where it touches the upper edge of the keel; and let them be marked with the proper name of the timber, as in fig. 47. The graduations of the bend mould will therefore be exactly the same as the narrowing of the breadth. Thus, the distance between \odot and 7 on the bend mould is equal to the difference between the half breadth of timber 7 and that of \odot . The height of the head of each timber is likewise marked on the bend mould, and also the floor and breadth firm-arks. The floor firm-ark is in that point where a straight edged batten touches the

Method
of Whole-
moulding.

Method
of
drawing
the
mould.

back of the bend mould, the batten being so placed as to touch the lower edge of the keel at the same time. The several rulings of the floor and heights of the cutting-down line are marked on the rising square, and the half breadth of the keel is set off from the side of it.

The moulds being thus prepared, we shall apply them to mould timber 7. The timber being first properly fitted to its breadth, lay the bend mould upon it, so as may best answer the round according to the grain of the wood; then lay the rising square to the bottom of the bend mould, so that the line drawn across the bend mould at timber 7 may coincide with the line representing the middle of the keel upon the rising square; and draw a line upon the timber by the side of the square, or let the line be scored or cut by a tool made for that purpose, called a *raising knife* (K); this line is said will be the side of the keel. Then the square must be moved till the side of it comes to 7 on the bend mould, and another line must be raised in by the side of it to represent the middle of the keel. The other side of the keel must likewise be raised after the same manner, and the point 7 on the rising square be marked on each side of the keel, and a line raised across at these points to represent the upper edge of the keel. From this line the height of the cutting-down line at 7 must be set up, and then the rising square may be taken away, and the timber may be raised by the bend mould, both inside and outside, from the head to the floor-irons, or it may be carried lower if necessary. After the firmness and head of the timbers are marked, the bend mould may likewise be taken away, and then the hollow mould applied to the back of the sweep in such a manner that the point 7 upon it may intersect the upper side of the keel, before set off by the rising square; and when in this position the timber may be raised by it, which will complete the outside of the timbers. The inside of the timbers may likewise be formed by the hollow mould. The finishing at the keel is given by the cutting-down before set off. The mould must be so placed as to touch the sweep of the inside of the timber formed before by the bend mould, and pass through the cutting-down point.

The use of the firmness is to find the true places of the futtocks; for as they are cut off three or four inches short of the keel, they must be so placed that the futtock and its firmness may be compared and coincide. Notwithstanding which, if the timbers are not very carefully trimmed, the head of the futtock may be either too thin or too out its proper half breadth; to prevent which a half breadth staff is made as follows.

The half breadth staff may be one inch square, and twenty or twenty-five feet long. Upon one side of it are set off from one end the several half breadths of all the timbers in the after-body, and those of the fore-body upon the opposite side. On the other two sides are let off the several half breadths of the sheer, to either body on one side, and the base body on its opposite. Two sides of the staff are marked off *firmness*, and the other two sides *half breadths*.

The staff being thus prepared, and the floor timbers

fastened on the keel, and levelled across, the futtocks must next be fitted to the floor timbers; but they must be set first to their proper half breadth and height. The half breadth staff, with the assistance of the ram-line*, serves to fit them to the half breadth; for as the keel of a boat is generally perpendicular to the horizon, therefore the line at which the plummet is suspended, and which is moveable on the ram line, will be perpendicular to the keel. Whence we may by it set the timbers perpendicular to the keel, and then set them to their proper half breadths by the staff; and when the two firmness coincide, the futtock will be at its proper height, and may be nailed to the floor timbers, and also to the breadth ribband, which may be set to the height of the sheer by a level laid across, taking the height of the sheer by the staff from the upper side of the keel; by which means we shall discover if the ribband is exactly the height of the sheer; and if not, the true height may be set off by a pair of compasses from the level, and marked on the timbers.

Practice
of
Ship-
building.

* See next
chapter.

CHAP. VI. Of the Practice of Ship-building.

THE elevation, projection, and half breadth plans, of a proposed ship being laid down on paper, we must next proceed to lay down these several plans on the mould loft of the real dimensions of the ship proposed to be built, and from which moulds for each separate part are to be made. The method of laying down these plans, from what has been already said, will, it is presumed, be no very difficult task to accomplish, as it is no more than enlarging the dimensions of the original draughts; and with respect to the moulds, they are very easily formed agreeable to the figure of the several parts of the ship laid down in the mould loft.

Blocks of wood are now to be prepared upon which the keel is to be laid. These blocks are to be placed at nearly equal distances, as of five or six feet, and in such a manner that their upper surfaces may be exactly in the same plane, and their middle in the same straight line. This is easily done by means of a line stretched a little more than the proposed length of the keel; and the upper planes of these blocks may be verified by a long and straight rule; and the utmost care and precaution must be taken to have these blocks properly bedded. Each block may be about six or eight inches longer than the keel is in thickness; their breadth from 12 to 14 inches, and their depth from a foot to a foot and half.

The dimensions of the keel are to be taken from the mould loft, and the keel is to be prepared accordingly. As, however, it is seldom possible to procure a piece of wood of sufficient length for a keel, especially if for a large ship, it is, therefore, for the most part necessary to compose it of several pieces, and these pieces are to be fastened together, and securely bolted, so as to make one entire piece. It must, however, be observed, that the pieces which compose the keel ought to be of such lengths, that a seam may not be opposite to the step of any of the masts. Rabbits are to be formed on each side of the keel to receive the edge of the planks next

* The term *firmness* is used when any line is drawn by a line instrument instead of a pencil.

Practice
of ship-
building.

to it, or garboard plank, and the keel is to be laid on the blocks (F).

The stem, and the post, and the several transoms belonging to it, are to be prepared from the materials, and mounted in like manner as the keel, to receive the ends of the planks. The transoms are to be bolted to the post or under middle, and its rise to be the height taken from the elevation in the main part, and the extremities of the transoms are to be duly connected with the fashion-pieces. Both stem and post are also to be erected, each at its respective extremity of the keel. The transoms at the heel or main being the largest, are prepared to receive them, and being set to their proper rake or angle with the keel, are to be secured by props or shores. Pieces of wood called *stanchions* are to be laid upon and fixed to the upper side of the keel towards the fore and aft parts of it; the deeper of the dead wood increasing with its distance from the middle, agreeable to the proper form of the cuttings-down line.

A line is to be stretched from the middle of the head of the stem to that of the post, called the *stem line*, upon which is a moveable line with a plummet fixed to it. The midship and other frames are to be erected upon the keel at their proper distances. The extremities of each frame are set at equal distances from the vertical longitudinal section of the ship, by moving the frame in its own plane until the plumb-line coincides with a mark at the middle between the arms of each frame; and although the keel is inclined to the horizon, yet the frames may also be set perpendicular to the keel by means of the plumb-line. The shores which are supporting the frames are now to be finally fixed, that the position of the frames may not be altered. The ribbands are now to be nailed to the frames at their proper places, the more effectually to secure them; and the intermediate vacancies between the frames filled up with filling timbers. For a perspective view of a ship framed, see fig. 2.

Plate
exclusive
Fig. 2.

The frames being now stationed, proceed next to fit on the planks, of which the wales are the principal, being much thicker and stronger than the rest. The larboard, which may be considered as a continuation of the wales at their fore ends, are fixed across the hawse pieces, and forward the fore part of the ship. The planks that include the ship's ribs are then brought about the timbers; and the clamps, which are of equal thickness with the wales, fixed opposite to the wales within the ship. These are used to support the ends of the beams, and accordingly fixed from one end of the ship to the other. The thick *stiff* or *iron* planks of the bottom within board are then placed opposite to the several parts of the timbers, to reinforce them throughout the ship's length. The planks employed to line the ship, called the *carling* or *fastenings*, is next fixed in the intervals between the thick *stiff* of the hull. The beams are afterwards laid across the ship to support the deck, and are cemented to the side by *clamps* and hanging knees; the former of which are exhibited in F.

PLATE CLINIK. See also my article Dredging and the English Channel, together with the breadth, thickness, and position of the keel, floor timbers, futtocks, top timbers, and clamps, thick and, planks within and without, and the blocks, &c.

The carling being next erected, the *carlines* and *z-planks* are fixed in Plate CLINIK, are opposed to the ribs, and are to strengthen the deck. The transoms are also set on the ends of the beams through the ship's length, and the finishing fixed close to the stem.—The upper deck is of a plank, and the posts are placed under the *z-plank* in the cabin.

Then proceed next to plank the upper-deck and futtocks, and to fix the *parties* of the masts and supports with the *causing* of the hulls. The *tree-boards* are then bolted across the stem and bow within-board, the top of the stern is fixed on the *falling*, and the *posts* are set to the *z-plank*; the timbers are reinforced the ribs in different parts of the ship's hull. The *posts*, if any, are now ready for their use in the hold, ready to support the masts; and the *crosses* are fixed in the fore hold to support the *hull* timbers. The *logs* of the masts and *crosses* are next fixed; the planks of the lower deck are now fixed; the *deck-boards* are laid to the hawse holes; and the *deck-boards*, or *cutwaters*, cemented to the frame. The figure of the head is then erected, and the *trawboard* and *cleeks* fixed on the side of the keel.

The *topgall* and *quarter-pieces*, which terminate the ship about the former above and the latter on each side, are then disposed, and the beam and quarter galleries framed and supported by their brackets. The *parpets*, with their well, are next fixed in the hold; the *larboard* *boards* laid on each side of the keel; and the *garboard* *boards* fixed on the ship's bottom next to the keel without.

The hull being thus fabricated, proceed to separate the apartments by bulkheads or partitions, to frame the *ports*, to fix the catheads and chock-trees; to form the hatchways and futtocks, and fit them with proper covers or gratings. Next fix the ladders at the different hatchways, and build the manger on the lower deck, to carry off the water that runs in at the hawse-holes when the ship rides at anchor in a sea. The bread-room and magazines are then lined; and the gunnel, rails, and gratings fixed on the upper part of the ship. The cleats, levels, and ranges, by which the ropes are fastened, are afterwards bolted or nailed to the sides in different places.

The rudder, being fitted with its *iron*, is next hung to its *post*, and the tiller or bar, by which it is managed, let into a mortise at its upper end. The *galleys*, or *lower* *tubes*, that carry the water off from the decks, are then placed in holes cut through the *planks*, and the *standards* bolted to the beams and fixed on the sides to which they belong. The poop is to be raised half feet up on their ends over the deck, and the *gunner* or *crew* *boards* laid under the bottom to cover the ship cleanly from the water which launches.

N 2

A

(F) In ships of war, which are a large vessel, the hull being built in this manner, it has been found that the keel is often apt to rot before they are finished. To prevent this, therefore, some builders have begun with the floor timbers, and added the keel afterwards.

As the various pieces which have been mentioned above are explained at large in their proper places, it is therefore superfluous to enter into a more particular description of them here.

CHAP. VII. Of Improvements in the Masts and Leads.

An account of a method for restoring masts of ships when wo, or other, is injured, in an easy, cheap, and efficacious manner, by Captain Edward Pakenham of the royal navy, has been published in the tenth volume of the Transactions of the Society for the Encouragement of Arts, &c. Captain Pakenham introduces his invention with the following observations:

"Among the various accidents which ships are liable to at sea, none call more for the attention and exertion of the officer than the speedy raising of the masts; and having observed, in the course of his war, the very great destruction made among the lower masts of our ships from the enemy's mode of fighting, as well as the very great expence and delay in restoring a fleet after an action, particularly across the Atlantic—a very simple expedient has suggested itself to me as a resource in part; which appears to very speedy and secure, that the capacity of the masts for sail will at once conceive it. I therefore think it my duty to state my ideas of the advantages likely to result from it; and I shall feel myself exceedingly happy should they in anywise contribute to remedy the evil.

"My plan, therefore, is, to have the heels of all lower masts so formed as to become the leads; but it is not the intention of the above plan to have the smallest alteration made in the heels of the present lower masts; for as all line-of-battle ships masts are nine inches in diameter larger at the heel than at the head, it will follow, that by letting in the trellis-trees to their proper depth, the mast will form its own cheeks or hounds; and I flatter myself the following advantages will result from the above alteration.

First, I must beg to observe, that all line-of-battle ships bury one third of their lower masts, particularly three-deckers; it therefore follows, that if the wounds are in the upper third, by turning the mast so as to make the heel the head, it will be as good as new; for, in eight actions I was present in last war, I made the following observations:

"That in the said actions fifty-eight lower masts were wounded, and obliged to be fluted, thirty-two of which had their wounds in the upper third, and of course the ships detained until new masts were made. And when it is considered that a lower mast for a 62 or 74 funds government in a fun not less, I am informed, than 2200l. or 2300l. the advantages across the Atlantic resulting from the forefiled plan will be particularly obvious; not to mention the probability of there being no lost spars in the country, which was the case in the instances of the *His and Prince's Royal*; and as I was one of the lieutenants of the *His* at that time, I am more particular in the circumstance of that ship. The *His* had both her lower masts wounded above the collar pins in her action with the *Cesar*, a French 74; and as there were no spars at New York, the *His* was detained five weeks at that place.—Now, if her masts had been fitted on the plan I have proposed, I am con-

vinced the would have been ready for sea in 45 hours; and as a further proof, I beg leave to add, that the whole fleet, on the glorious 12th of April, had not the least accident of any consequence except what met their lower masts, which detained them between eight and ten weeks at Jamaica.

"The duty of a ship while a new mast is making, and probably the fleet being detained for want of that ship, which frequently occurred in the course of last war, the taking of shipwrights from other work, with a variety of inconveniences not necessary to mention here, must be obvious to every officer that has made the smallest observations on sea-actions.

"You will further observe, that this substitute is formed on the most simple principle, fitted to the meanest capacity, and calculated to benefit all ships, from a first-rate down to the smallest merchantman, in cases of an accident by shot, a spring, a rottenset, particularly as these accidents generally happen in the upper third of the mast and above the cheeks.

"It might probably be objected, that a difficulty and some danger might arise from the wounded part of the mast being below; but this will at once be obviated, when it is remembered, that as the wounded part is below the wedges, it may with ease be both filled, caled, and secured, to any size or degree you please, with the addition of its being wedged on each deck."

Fig. 41. represents a mast of a first-rate in its proper state, the figures representing its thickness at the different divisions.

Fig. 42. the same mast inverted, the heel forming the head, and the trellis-trees let into their proper depth, the additional thickness of the mast forming its own cheeks.

Fig. 43. the proposed mast, the figures representing the thickness of the mast in the proposed alterations; *a*, the heel made square; *b*, the letting in of the trellis-trees; *c*, the third proportion of thickness continued up to where the fourth is in the present mast, or at least some little distance above the lower part of the cheeks, which is always looked upon as the weakest part of the mast; and by its being so proportioned, the mast, when turned, will be nearly as strong in the part as before.

As the expence of a mast is much greater than is generally imagined, it is therefore thought proper to subjoin the following statement of the several articles used in making a 74 gun ship's mainmast.

	Value.	Tons on Mast Structure.
Fishes for a spindle, 21 inches, 2 nails of two masts,	L. 101 3	11
Two side fishes, 22 inches, 2 ditto,	133 10	9
Fore and aft fishes, 22 inches, 2 nails of one mast,	66 13	10
Fish } 21½ inches, 1 nail of half a mast,	29 8	5
Iron } On the fore part		
Iron } 3 qrs. 19 lbs.	1 5	9
Aries load bank, 2 loads 22 feet,	12 2	5
Ereathing } 2 loads 7 feet,	11 1	7
Ereathing } Danzig fir timber.		
5 Cheeks } 4 loads 2 feet,	20 18	4
Iron, 5 cent. 2 qrs. 24 lb.	8 0	0
Knees, elm timber, 13 feet,	6 15	2
Iron, 2 qrs. 14 lb.	0 17	6

Load wa-
ter Line
and ship's
centre of
gravity.

rudder by an accident was unhipped, this alteration might endanger the tearing away of the counter, the hole is made much larger than the transverse section of the cylindrical part of the rudder, and the space between, a filled up with pieces of wood fitted to the counter as to be capable of withstanding the shock of the sea, but to be easily carried away with the rudder, leaving the counter, under such circumstances, in as flat a state as it would be agreeable in the present form of making rudders in the navy.

CHAP. VIII. Upon the Position of the Load-water Line, and the Capacity of a Ship.

Load wa-
ter Line
and ship's
centre of
gravity.

THE weight of the quantity of water displaced by the bottom of a ship is equal to the weight of the ship with its rigging, provisions, and every thing on board. If, therefore, the exact weight of the ship when ready for sea be calculated, and also the number of cubic feet in the ship's bottom below the load-water line, and hence the weight of the water she displaces; it will be known if the load-water line is properly placed in the draught.

Load wa-
ter Line
and ship's
centre of
gravity.

The position of the ship in the draught may be either on an even keel, or to draw most water abaft; but an even keel is judged to be the best position in point of velocity, when the ship is constructed suitable thereto, that is, when her natural position is such. For when a ship is constructed to swim by the Stern, and when brought down to her load-water made to swim on an even keel (as is the case with most ships that are thus built), her velocity is by that means greatly retarded, and also her strength greatly diminished: for the fore-part being brought down lower than it should be, and the middle of the ship maintaining its proper depth in the water, the after part is by that means lifted, and the ship is then upon an even keel: but in consequence of her being out of her natural position, the after part is always pressing downwards with a considerable strain, which will continue till the ship's keel is entirely broken, and in time would fall into its natural position again: for which reason we see so many ships with broken backs, that is, with their keels altered in such a manner that the keel rounds up, and the highest part is in the middle.

Such are the disadvantages arising from not paying a due attention to those points in the construction of a draught; therefore, when the load-water line is found to be so situated at a proper height on the draught, according to the weight given for such a ship, and also drawn parallel to the keel, as supposing that to be the best sailing tim, the next thing is to examine whether the body is constructed suitable thereto, in order to avoid the above-mentioned ill consequences.

In the first place, therefore, we must divide the ship equally in two lengthwise between the fore and after perpendiculars; and the exact number of cubic feet in the whole bottom beneath the load-water line being known, we must find whether the number of cubic feet in each part be divided in the same; and if they are found to be equal, the body of the ship may then be

found to be constructed in all respects suitable to her swimming on an even keel, let the shape of the body be what ever it will; and which will be found to be her natural position at the load-water line. But if either of the parts should contain a greater number of cubic feet than the other, that part which contains the greater will swim the most out of the water, and consequently the other will swim deeper, keeping the ship in her natural position for that construction. In order, therefore, to render the ship suitably constructed to the load-water line in the draught, which is parallel to the keel, the number of cubic feet in the less part must be subtracted from the number contained in the greater part, and that part of the body is to be filled out till it has increased half the difference of their quantities, and the other part is to be drawn in as much: hence the two parts will be equal, that is, each will contain the same number of cubic feet, and the ship's body will be constructed in a manner suitable to her swimming on an even keel.

If it is proposed that the ship laid down on the draught shall not swim on an even keel, but draw more water abaft than afore, then the fore and after parts of the ship's body below the load-water line are to be compared; and if these parts are unequal, that part which is least is to be filled out by half the difference, and the other part drawn in as much as before.

It will be necessary, in the first place, to calculate the weight of a ship ready equipped for sea, from the knowledge of the weight of every separate thing in her and belonging to her, as the exact weight of all the timber, iron, lead, masts, sails, rigging, and in short all the materials, men, provisions, and every thing else on board of her, from which we shall be able afterwards to judge of the truth of the calculation, and whether the load-water line in the draught be placed agreeable thereto. This is indeed a very laborious task, upon account of the several pieces of timber, &c. being of so many different figures, and the specific gravity of some of the timber entering the construction not being precisely determined.

In order to ascertain the weight of the hull, the timber is the first thing which comes under consideration: the number of cubic feet of timber contained in the whole fabric must be found; which we shall be able to do by help of the draught and the principal dimensions and scantlings; observing to distinguish the different kinds of timber from each other, as they differ considerably in weight; then the number of cubic feet contained in the different sorts of timber being reduced into pounds, and added, will be the weight of the timber. In like manner proceed to find the weight of the iron, lead, paint, &c. and the true weight of the whole will be found.

In reducing quantity to weight, it may be observed that a cubic foot of oak is equal to 66 pounds, and the specific gravity of the other materials is as follows:

Water being	1000	Oak is	891.80
Lead is	11345	Dry elm	702.70
Iron	7643	Dry fir	638.64

Load wa-
ter Line
and ship's
centre of
gravity.

See Hypo-
thesis.

Load-water Line and Ship's Capacity. Plates C. C. X. CCCCXCI.

Load-water Line and Ship's Capacity.

An Estimate of the Weight of the Eighty Gun Ship in Plates CCCCXC and CCCCXCI, as fitted for Sea, with Six Months Provisions.

Weight of the Men, &c.

	No.	FT.	IN.	WT.	LB.
Oak timber at 66 lb. to the cubic foot	48497	3200	822	1428	2082
Fir timber at 48 lb. to the cubic foot	4457	2139	36	95	1136
Elm timber at 52 lb. to the cubic foot	520	275	40	12	160
Carve work and lead work				46	1
Iron work, rudder irons, chain-plates, nails, &c.				88	254
Pitch, tar, oakum, and paint				179	22
Cook-room fitted with fire hearth				161	23
Sum				35687	261503

Seven hundred men with their effects, including the officers and their effects	316961	141	1121
Ballast	1478400	660	
Sum	1795361	801	1121

REQUISITIONS.

The hull	3568726	1393	406
The furniture	437525	195	720
Guns and ammunition	521427	232	1747
Officers stores	66359	29	1599
Provisions	1792875	800	875
Weight of the men and ballast	1795361	801	1121
Sum	8182463	3652	1983

Weight of the Furnitures.

	No.	FT.	IN.	WT.	LB.
Complete set of masts and yards, with the spare gear	161200	71	1960		
Anchors with their stocks, and mallet's stores	39996	17	1916		
Rigging	69128	30	1028		
Sails, complete set, and spare	32208	14	618		
Cables and hawsers	78882	32	1652		
Blocks, pumps, and boats	62236	27	1376		
Sum	437525	195	720		

Weight of the Guns and Ammunition.

Guns with their carriages	377534	168	714
Powder and shot, powder barrels, &c.	116320	51	2080
Implements for the powder	6300	2	2220
Ditto for guns, crow's, handspikes, &c.	21573	9	1413
Sum	521427	232	1747

Weight of the Officers Stores, &c.

Carpenter's stores	20187	9	27
Boatwain's stores	21112	9	952
Gunner's stores	8763	4	4
Cook's stores	5200	2	720
Burgeone and captain's effects	11296	4	2136
Sum	66359	29	1599

Weight of the Provisions.

Provisions for six months for 700 men, including the captain's table	521427	333	1050
Water, casks, and captain's table	67529	116	2060
Sum	1196726	449	1356

Agreeable to the above estimate, we find that the eighty gun ship, with every thing on board and fit for sea, when brought down to the load-water line, weighs 8,182,463 pounds, or nearly 3653 tons. It may now be known if the load-water line in the drawing be properly placed, by adding the immersed part of the body into cubic feet. For if the eighty gun ship, when brought down to the load-water line, weighs 3653 tons, the quantity of water displaced must also be 3653 tons: now a cubic foot of salt water being supposed to weigh 74 pounds, the number 8182463 will be divided by 74, the quotient is 110573, the number of cubical feet which the hull displaces above the water.

It is now necessary to find the number of cubic feet contained in the ship's bottom below the load-water line by calculation. If the bottom was a regular solid, this might be very easily done; but if it is otherwise, we must be satisfied with the following method by approximation, first given by M. Bouguer.

Take the length of every other of the lines that represent the frames in the horizontal plane upon the upper water line; then add the length of these together with half the sum of all the other frames. Now multiply the sum by the distance between the frames, and the product is the area of the water line contained between the foremast and aftermost frames: they find the area of that part of the after frame, which forms a trapezium, and also the part and rudder; and also the area of that part of the foremast frame, and also of the stem and stern, then these areas being added to that of the main, and the sum divided by the area of the surface of the whole water line. The reason of this rule will be obvious to those acquainted with the first principles of mathematics.

The areas of the other water line may be found in the same manner; then the sum of all these areas, except that of the uppermost and lowermost, of which only one half of each may be taken, being multiplied by the distance between the water lines (thick lines in the plane of elevation being parallel to those each other), and the product will be the solid content of the space contained between the lower and the upper water lines.

Load water Line and Ship's Capacity. Add the area of the lower water line to the area of the upper side of the keel; multiply half that sum by the distance between them, the product will be the solid content of that part between the lower water line and upper edge of the keel, supposing them parallel to each other. But if the lower water line is not parallel to the keel, the above half sum is to be multiplied by the distance between them at the middle of the ship.

The solid contents of the keel must be next found, by multiplying its length by its depth, and that product by the breadth. Then the sum of these solid contents will be the number of cubic feet contained in the immersed part of the ship's bottom, or that part below the load water line.

Determination of the number of Cubic Feet contained in the Bottom of the Eighty Gun Ship. See Plates CCCCXC. and CCCCXCI.

⁴⁴ Applied to the eighty gun ship. The fore body is divided into five, and the after body into ten, equal parts in the horizontal plane; besides the parts contained between the foremast timber and the stem, and the aftermost timber and the post. The plane of elevation is also divided into five equal parts by water lines drawn parallel to the keel. These water lines are also described upon the horizontal plane.

It is to be observed that there must be five inches added to each line that represents a frame in the horizontal plane for the thickness of the plank, that being nearly a mean between the thickness of the plank next the water and that on the lower part of the bottom.

Upper Water Line abaft Dead Flat.

	Ft.	In.
frame dead flat is 24 feet 10 inches, one-half of which is	12	5
frame (4)	24	10
frame 3	24	10
frame 7	24	10
frame 11	24	10
frame 15	24	9½
frame 19	24	5
frame 23	24	10
frame 27	22	9
frame 31	20	11
frame 35 is 16 feet 3 inches, the half of which is	8	1½
Sum	236	7
Distance between the frames	10	11
Product	2382	8½
Area of that part abaft frame 35	78	0
rudder and post	5	6
Sum	2666	2½
Area of the load water line from dead flat aft	5332	5

Second Water Line abaft Dead Flat.

	Ft.	In.	Load water Line and Ship's Capacity.
frame dead flat is 23 feet 10½ inches, the half of which is	11	11½	
frame (4)	23	10½	
frame 3	23	10½	
frame 7	23	10½	
frame 11	23	10½	
frame 15	23	8½	
frame 19	23	5½	
frame 23	22	5	
frame 27	20	10	
frame 31	17	8	
frame 35 is 8 feet 6 inches, the half of which is	4	3	
Sum	219	7½	
Distance between the frames	10	11	
Product	2397	4	
Area of that part abaft frame 35	31	7	
rudder and post	5	5	
Sum	2434	4	
Area of the 2d water line from dead flat aft	4868	8	

Third Water Line abaft Dead Flat.

	Ft.	In.
frame dead flat is 22 feet 1½ inches—half	11	0½
frame (4)	22	1½
frame 3	22	1½
frame 7	22	1½
frame 11	22	1
frame 15	21	5
frame 19	20	8½
frame 23	19	3½
frame 27	16	5
frame 31	11	2½
frame 35 is 4 feet 3 inches—half	2	1½
Sum	190	8½
Distance between the frames	10	11
Product	2081	8
Area of that part abaft frame 35	14	5½
rudder and post	5	6
Sum	2101	7½
Area of the 3d water line from dead flat aft	4203	3

Fourth Water Line abaft Dead Flat.

	Ft.	In.
frame dead flat is 20 feet 1 inch—half	10	0½
frame (4)	20	1
frame 3	20	1
frame 7	19	11
frame 11	19	7½
frame 15	19	0
Sum	108	9
Carry over		
Sum	108	9

Load water
Line
and Ship's
Capacity.

Fourth Water Line afore Dead Flat.

The breadth at		Ft.	In.
{ frame dead flat is 20 feet 1 inch—half { frame E { frame I { frame N { frame Q { frame W is 2 feet nine inches—half		10	0½
		19	0½
		19	3
		16	5
		11	2
		1	4½
Sum		78	3½
Distance between the frames		10	11
Product		834	8
Area of part before W, with the stem and gripe		8	10½
Sum		863	6½
			2
Area of fourth water line from dead flat forward		1727	1½

Fifth Water Line afore Dead Flat.

Breadth at		Ft.	In.
{ frame dead flat is 17 feet 2 inches—half { frame E { frame I { frame N { frame Q is 5 feet—half		8	7
		16	9
		14	10
		10	9½
		2	6
Sum		53	5½
Distance between the frames		10	11
Product		583	7
Area of part afore Q stem and knee		26	2½
		5	11½
Sum		615	9
			2
Area of the fifth or lower water line from dead flat forward		1231	6
Area of the upper side of the keel		87	4
Sum		1318	10
Half		659	5
Distance between the lower water line and keel		4	1
Content of the part contained between the lower water line and the keel in cub. feet		2692	7½
Half of the area of the load water line		1343	9
Area of the second water line		2435	0
third water-line		2115	4
fourth water-line		1727	1½
Half the area of the fifth or lower water line		615	9
Sum		8236	11½
Distance between the water lines		4	1

Cubic feet contained between the lower and load water lines	33634	2½	Tonnage of a Ship
Cubic feet contained between lower water line and keel	2692	7½	
Content of the keel and false keel	196	6	
Content afore midship frame under water when loaded	36523	4	
Content abaft midship frame	74050	6	
Content under water	110573	10	
Weight of a cubic foot of salt water		74	lbs.
Weight of the whole ship with every thing on board	8182463.8		lbs.

As the weight of the ship, with every thing on board, found by this calculation, is equal to that found by estimate; it hence appears that the water line is properly placed in the draught. It now only remains to find whether the body is constructed suitably thereto, that is, whether the ship will be in her natural position when brought down to that line. For this purpose a perpendicular must be erected 27 feet ¼ inch. abaft dead flat, which will be the middle between the two perpendiculars and the place where the centre of gravity should fall, that the ship may swim on an even keel. The solidity of that part of the bottom contained between the said perpendicular and dead flat is then to be calculated, which will be found to be 25846 feet 7 inches.

Solidity of the bottom afore dead flat	36523 f.	4 in.
between the middle and dead flat	25846	7
Solid content of the fore part of the bottom	62369	11
Solidity of the bottom abaft dead flat	74050	6
between the middle and dead flat	25846	7
Solid content of the aft. part of the bottom	48203	11
fore part of the bottom	62369	11
Difference	14166	
Half	7083	

Hence the after part of the ship's bottom is too lean by 7083 cubic feet, and the fore part as much too full. The after part must therefore be filled out until it has received an addition of 7083 feet, and the fore part must be drawn in till it has lost the same quantity, and the bottom will then be constructed suitable to the ship's swimming on an even keel.

CHAP. IX. Of the Tonnage of a Ship.

THIS is a question of equal importance and difficulty. By the tonnage of a ship is meant the weight of every thing that can with safety and expediency be taken on board that ship for the purpose of conveyance; it is also called the *ship's burthen*; and it is totally different from the weight of the whole as the floats in the water. It is perhaps best expressed by calling it the *weight of the cargo*. It is of importance, because it is by this that the merchant or freighter judges of the fitness

55
Proper method of calculating the tonnage of a ship.

Tonnage of the ship for his purpose. By this government judge of the ship requisite for transport service, and by this are all revenue charges on the ship computed. It is no less difficult to answer this question by any general rule which shall be very exact, because it depends not only on the cubical dimensions of the ship's bottom, but also on the scantling of her whole frame, and in short on the weight of every thing which properly makes part of a ship ready to receive on board her cargo. The weight of timber is variable; the scantling of the frame is no less so. We must therefore be contented with an average value which is not very remote from the truth; and this average is to be obtained, not by any mathematical discussion, but by observation of the burthen or cargo actually received, in a great variety of cases. But some sort of rule of calculation must be made out. This is and must be done by persons not mathematicians. We may therefore expect to find it incapable of being reduced to any principle, and that every builder will have a different rule. Accordingly the rules given for this purpose are in general very whimsical, measures being used and combined in a way that seems quite unconnected with geometry or the measurement of solids. The rules for calculation are even affected by the interests of the two parties oppositely concerned in the result. The calculation for the tonnage by which the customs are to be exacted by government are quite different from the rule by which the tonnage of a transport hired by government is computed; and the same ship hired as a transport will be computed near one half bigger than when paying importation duties.

Yet the whole of this might be made a very simple business and very exact. When the ship is launched, let her light water line be marked, and this with the cubical contents of the innermost part be noted down, and be ingrossed in the deed by which the property of the ship is conveyed from hand to hand. The weight of her masts, sails, rigging, and sea-stores, is most easily obtained; and every builder can compute the cubical contents of the body when immersed to the load water line. The difference of these is unquestionably the burthen of the ship.

It is evident from what has been already said in the last chapter, that if the number of cubic feet of water which the ship displaces when light, or, which is the same, the number of cubic feet below the light water line, found by the preceding method of calculation, be subtracted from the number of cubic feet contained in the bottom below the load water line, and the remainder reduced to tons by multiplying by 74, the number of pounds in a cubic foot of sea water, and divided by 2240, the number of pounds in a ton, the quotient will be the tonnage.

But as this method is very troublesome, the following rule for this purpose is that which is used in the king's and merchants service.

Let fall a perpendicular from the fore-side of the stem at the height of the hawse holes (H), and another perpendicular from the back of the main post at the height

of the wing transom. From the length between these two perpendiculars deduct three-fifths of the extreme breadth (1), and also as many times 2½ inches as there are feet in the height of the wing transom above the upper edge of the keel; the remainder is the length of the keel for tonnage. Now multiply this length by the extreme breadth, and the product by half the extreme breadth, and this last product divided by 94 is the tonnage required.

Or, multiply the length of the keel for tonnage by the square of the extreme breadth, and the product divided by 188 will give the tonnage.

Calculation of the Tonnage of an Eighty Gun Ship.

I. According to the true method.

	Tons.	lbs.	Calculation of the tonnage of the eighty gun ship.
The weight of the ship at her launching draught of water	1593	426	⁵⁷ of the tonnage of the eighty gun ship.
The weight of the furniture	195	720	
The weight of the ship at her light water mark	1788	1126	
The weight of the ship at the load water mark	3652	1983	
Real burthen	1864	857	

II. By the common rule.

Length from the fore-side of the stem at the height of the hawse holes, to the aft side of the main post, at the height of the wing transom	185	15	Ft. Inch.
Three-fifths of the extreme breadth is	29	9½	in.
Height of the wing transom is 28 f. 4 in. which multiplied by 2½ inches is	6	8½	
Sum	36	6	
Length of the keel for tonnage	149	4	
Extreme breadth	49	8	
Product	7416	104	
Half the extreme breadth	24	10	
	921	184	8½
Burthen according to the common rule	1959	929	
Real burthen	1864	857	
Difference	95	72	⁶⁸

Hence an eighty gun ship will not carry the tonnage she is rated at by about 95 tons. As the body of this ship is fuller than in ships of war in general, there is therefore a nearer agreement between the tonnages found by the two different methods. It may be observed that ships of war carry less tonnage than they are rated at by the common rule, and that most merchant ships carry ⁶⁸ more than the truth.

(H) In the merchant service this perpendicular is let fall from the fore side of the stem at the height of the wing transom, by reason of the hawse-holes being generally so very high in merchant ships, and their stems also having a great rake forward.

(1) The breadth understood in this place is the breadth from outside to outside of the plank.

Tonnage of a great deal more. In confirmation of this, it is thought proper to subjoin the dimensions of several ships, with the tonnage calculated therefrom.

1. *Audacious of seventy-four guns.*

Length on the gun deck	-	168 f. 0 in.
Length of the keel for tonnage	-	138 0
Extreme breadth	-	46 9
Depth of the hold	-	19 9
Launching draught of water	{ aforeside	12 0
	{ abaft	17 4
Load draught of water	{ aforeside	20 6
	{ abaft	21 6
The weight of the ship at her launching draught of water	-	1509 t. 678 lbs.
The weight of the furniture	-	120 1500

Weight of the ship at her light water mark	-	1629 2178
Weight of the ship at her load water mark	-	2776 498

Real burthen	-	1146 560
By the common rule.		
Length of the keel for tonnage	-	138 f. 0 in.
Extreme breadth	-	46 9
Product	-	6451 6
Half the extreme breadth	-	23 4½

94)150803

Tonnage according to the common rule	-	1654 643
Real burthen	-	1146 560
Difference	-	458 83

2. *An Eagle Indianan.*

Length between the perpendiculars forward and aft	-	132 f. 8 in.
Length of the keel for tonnage	-	105 0
Extreme breadth	-	38 0
Depth in hold	-	16 0
Launching draught of water	{ aforeside	7 10
	{ abaft	11 10
Load draught of water	{ aforeside	19 8
	{ abaft	20 8

The weight of the ship at her launching draught of water	-	6221. 2116 lbs.
The weight of the furniture	-	50 124
Weight of the ship at her light water mark	-	653
Weight of the ship at her load water mark	-	1637 1670

Real burden	-	984 1670
By the common rule.		
Keel for tonnage	-	105 f.
Extreme breadth	-	38
Product	-	3999
Half extreme breadth	-	19

94)75810

Tonnage	-	-	806 1096	Tonnage of
Real tonnage	-	-	984 1670	a Ship.
Difference	-	-	178 574	

3. *A Cutter.*

Length of the keel for tonnage	-	58 f. 0 in.
Extreme breadth	-	29 0
Launching draught of water	{ aforeside	5 10
	{ abaft	9 8
Load draught of water	{ aforeside	9 0
	{ abaft	12 0
The weight of the cutter at her launching	-	147 t. 640 lbs.
Weight of the furniture	-	9 199

Weight of the cutter at her light water mark	-	156 839
Weight of the cutter at her load water mark	-	266 1970
Real burthen	-	110 1131

By the common rule.

Keel for tonnage	-	58 f.
Extreme breadth	-	29
Product	-	1682
Half extreme breadth	-	14½

94)24389

Tonnage by the common rule	-	259 1024
Real tonnage	-	110 1131
Difference	-	148 2133

The impropriety of the common rule is hence manifest, as there can be no dependence on it for ascertaining the tonnage of vessels.

We shall now subjoin the following experimental method of finding the tonnage of a ship.

Construct a model agreeable to the draught of the proposed ship, to a scale of about one fourth of an inch to a foot, and let the light and load water lines be marked on it. Then put the model in water, and load it until the surface of the water is exactly at the light water line; and let it be suspended until the water drains off, and then weighed. Now since the weights of similar bodies are in the triplicate ratio of their homologous dimensions, the weight of the ship when light is, therefore, equal to the product of the cube of the number of times the ship exceeds the model by the weight of the model, which is to be reduced to tons. Hence, if the model is constructed to a quarter of an inch scale, and its weight expressed in ounces; then to the constant logarithm 0,4893556, add the logarithm of the weight of the model in ounces, and the sum will be the logarithm of the weight of the ship in tons.

Again, the model is to be loaded until the surface of the water coincides with the load water line. Now the model being weighed, the weight of the ship is to be found by the preceding rule: then the difference between the weights of the ship when light and loaded is the tonnage required.

Tonnage of a Ship. It will also be worth while to add the following exact rule of Mr Parkins, who was many years foreman of the shipwrights in Chatham dockyard.

1. For Men of War.

Take the length of the gun-deck from the rabbet of the stem to the rabbet of the stern-post. $\frac{3}{4}$ of this is to be assumed as the length for tonnage, = L.

Take the extreme breadth from outside to outside of the plank; add this to the length, and take $\frac{1}{3}$ of the sum; call this the depth for tonnage, = D.

Set up this height from the limber strake, and at that height take a breadth also from outside to outside of plank in the timber when the extreme breadth is found, and another breadth in the middle between that and the limber strake; add together the extreme breadth and these two breadths, and take $\frac{1}{2}$ of the sum for the breadth for tonnage, = B.

Multiply L, D, and B together, and divide by 49. The quotient is the burthen in tons.

The following proof may be given of the accuracy of this rule. Column 1. is the tonnage or burthen by the king's measurement; col. 2. is the tonnage by this rule; and, col. 3. is the weight actually received on board these ships at Blackflakes:

Victory	100 guns.	2162	1839	1840
London		90	1845	1575
Arrogant		74	1614	1308
Diadem		64	1369	1141
Adamant		50	1044	870
Dolphin		44	879	737
Amphion		32	667	554
Daphne		20	439	329

2. For Ships of Burthen.

Take the length of the lower deck from the rabbet of the stem to the rabbet of the stern-post; then $\frac{1}{2}$ of this is the length for tonnage, = L.

Add the length of the lower deck to the extreme breadth from outside to outside of plank; and take $\frac{1}{3}$ of the sum for the depth for tonnage, = D.

Set up that depth from the limber strake, and at this height take a breadth from outside to outside. Take another at $\frac{2}{3}$ of this height, and another at $\frac{1}{3}$ of the height. Add the extreme breadth and these three breadths, and take the 4th of the sum for the breadth for tonnage, = B.

Multiply L, D, and B, and divide by 367. The quotient is the burthen in tons.

This rule rests on the authority of many such trials, as the following:

	King's Measfm.	Rule.	Actually rec ^d . on b ^d .
Northington Indiaman	676	1053	1064
Granby Indiaman	786	1179	1179
Union coallier	193	266	289
Another coallier	182	254	277

CHAP. X. Of the Scale of Solidity.

By this scale the quantity of water displaced by the bottom of the ship, for which it is constructed, answering to a given draught of water, is easily obtained; and

also the additional weight necessary to bring her down to the load water line.

In order to construct this scale for a given ship, it is necessary to calculate the quantity of water displaced by the keel, and by that part of the bottom below each water line in the draught. Since the areas of the several water lines are already computed for the eighty gun ship laid down in Plates CCCCXC. and CCCCXCL the contents of these parts may hence be easily found for that ship, and are as follow.

Scale of Solidity.

Draught of water.	Water displaced in		
	Cubic feet.	tons. lbs.	
Keel and false keel	2 f. 3 in.	660.9	21 18 55
Diit. bet. keel and 5th w. line	4 1	8583.11	283 12 33
Sum	6 4	9243.10 1/8	305 8 48
Diit. 5th and 4th w. line	4 1	18657.8 1/2	616 8 28
Sum	10 5	27901.7 1/8	921 16 76
Diit. 4th and 3d w. line	4 1	23574.6 1/2	778 1 795
Sum	14 6	51476.2 1/2	1700 12 31
Diit. 3d and 2d w. line	4 1	27812.1 1/4	918 1 775
Sum	18 7	79288.3 1/2	2619 7 66
Diit. 2d and 1st w. line	4 1	31285.7 1/8	1033 1 218
Sum	22 8	110573.11 1/2	3652 1 984

Construct any convenient scale of equal parts to represent tons, as scale N^o 1. and another to represent feet, as N^o 2.

Draw the line AB (fig. 36.) limited at A, but produced indefinitely towards B. Make AC equal to the depth of the keel, 2 feet 3 inches from scale N^o 2. and through C draw a line parallel to AB, which will represent the upper edge of the keel; upon which set off Cc equal to 21 tons 18 55 lbs. taken from scale N^o 1. Again, make AD equal to the distance between the lower edge of the keel and the fifth water line, namely, 6 feet 4 inches, and a line drawn through D parallel to AB will be the representation of the lower water line; and make Db equal to 305 tons 8 48 lbs. the corresponding tonnage. In like manner draw the other water lines, and lay off the corresponding tonnages accordingly: then through the points A, c, b, e, f, g, h, draw the curve A c b e f g h. Through h draw hB perpendicular to AB, and it will be the greatest limit of the quantity of water expressed in tons displaced by the bottom of the ship, or that when the is brought down to the load water line. And since the ship displaces 1788 tons at her light water mark, take therefore that quantity from the scale N^o 1. which being laid upon AB from A to K, and KL drawn perpendicular to AB, will be the representation of the light

Plate CCCCXCIL
60
Construct
the scale of
solidity for
the ship of
eighty
guns.

Scale of
Solidity.
of the
above scale.

water line for tonnage. Hence the scale will be completed.

Let it now be required to find the number of cubic feet displaced when the draught of water is 17 feet, and the number of additional tons necessary to bring her down to the load water mark.

Take the given draught of water 17 feet from the scale N° 2, which laid from it will reach to I; through which draw the line IMN parallel to AB, and intersecting the curve in AC; then the distance IM applied to the scale N° 1, will measure about 2248 tons, the displacement answerable to that draught of water; and MN applied to the same scale will measure about 1405 tons, the additional weight necessary to bring her down to the load water mark. Also the nearest distance between M and the line KL will measure about 460 tons, the weight already on board.

It will conduce very much to facilitate this operation to divide KB into a scale of tons taken from the scale N° 1, beginning at B, and also hL, beginning at h. Then when the draught of water is taken from the scale N° 2, and laid from it to I, as in the former example, and IMN drawn parallel to AB, and intersecting the curve in M. Now through M draw a line perpendicular to AB, and it will meet KB in a point representing the number of tons aboard, and also hL in a point denoting the additional weight necessary to load her.

Again, if the weight on board be given, the corresponding draught of water is obtained as follows.

Find the given number of tons in the scale KB, through which draw a line perpendicular to AB; then through the point of intersection of this line with the curve draw another line parallel to AB. Now the distance between A and the point where the parallel intersected AH being applied to the scale N° 2, will give the draught of water required.

Any other case to which this scale may be applied will be obvious.

BOOK II. *Containing the Properties of Ships, &c.*

CHAP. I. *Of the Equilibrium of Ships.*

SINCE the pressure of fluids is equal in every direction, the bottom of a ship is therefore acted upon by the fluid in which it is immersed; which pressure, for any given portion of surface, is equal to the product of that portion by the depth and density of the fluid: or it is equal to the weight of a column of the fluid whose base is the given surface, and the altitude equal to the distance between the surface of the fluid and the centre of gravity of the surface pressed. Hence a floating body is in equilibrio between two forces, namely, its gravity and the vertical pressure of the fluid; the horizontal pressure being destroyed.

Let ABC (fig. 49.) be any body immersed in a fluid whose line of floatation is GH: hence the pressure of the fluid is exerted on every portion of the surface of the immersed part AFCH. Let EF, CD be any two small portions contained between the lines ED, FC, parallel to each other, and to the line of floatation GH: then

the pressure exerted upon EF is expressed by $EF \times IK$, IK being the depth of EF or CD; the density of the fluid being supposed equal to 1. In like manner the pressure upon CD is equal to $CD \times IK$. Now since the pressure is in a direction perpendicular to the surface, draw therefore the line EL perpendicular to EF, and DM perpendicular to DC, and make each equal to the depth IK, below the surface. Now the effort or pressure of the fluid upon EF will be expressed by $EL \times EL$, and that upon CD by $CD \times DM$. Complete the parallelograms ON, QS, and the pressure in the direction EL is resolved into EN, EO, the first in a horizontal, and the second in a vertical direction. In like manner, the pressure in the direction DM is resolved into the pressures DS, DQ. Hence the joint effect of the pressures in the horizontal and vertical directions, namely, $EF \times EN$, and $EF \times EO$, will be equal to $EF \times EL$: For the same reason, $CD \times DP + CD \times DQ = CD \times DM$. But the parts of the pressures in a horizontal direction $EF \times EN$, and $CD \times DP$, are equal. For, because of the similar triangles ENL, ERF, and DPM, DSC, we have $\frac{EL}{EN} = \frac{EF}{FR}$ and $\frac{DM}{DP} = \frac{DC}{CS}$: Hence $DM \times CS = DP \times DC$, and $EL \times FR = EN \times EF$. Now since $EL = DM$, and $FR = CS$, therefore $EL \times FR = DM \times CS = DP \times DC = EN \times EF$. Hence since $EF \times EN = DP \times CD$, the effects of the pressures in a horizontal direction are therefore equal and contrary, and consequently destroy each other.

The pressure in a vertical direction is represented by $EO \times EF$, $DQ \times DC$, &c. which, because of the similar triangles EOL, ERF, and DLM, DSC, become $EL \times ER$, $DM \times DS$, &c. or $IK \times ER$, $IK \times DS$, &c. By applying the same reasoning to every other portion of the surface of the immersed part of the body, it is hence evident that the sum of the vertical pressures is equal to the sum of the corresponding displaced columns of the fluid.

Hence a floating body is pressed upwards by a force equal to the weight of the quantity of water displaced; and since there is an equilibrium between this force and the weight of the body, therefore the weight of a floating body is equal to the weight of the displaced fluid. Hence also the centre of gravity of the body and the centre of gravity of the displaced fluid are in the same vertical, otherwise the body would not be at rest.

CHAP. II. *Upon the Efforts of the Water to bend a Vessel.*

WHEN it is said that the pressure of the water upon the immersed part of a vessel counterbalances its weight, it is supposed that the different parts of the vessel are so closely connected together, that the forces which act upon its surface are not capable of producing any change. For we may easily conceive, if the connection of the parts were not sufficiently strong, the vessel would run the risk either of being broken in pieces, or of suffering some alteration in its figure.

The vessel is in a situation similar to that of a rod

AB

EF of the Water to bend a Vessel.

AB (fig. 50), which being acted upon by the forces Aa , Cc , Dd , Bb , may be maintained in equilibrium, provided it has a sufficient degree of stiffness; but as soon as it begins to give way, it is evident it must bend in a convex manner, since its middle would obey the forces Cc and Dd , while its extremities would be actually drawn downwards by the forces Aa and Bb .

The vessel is generally found in such a situation; and since similar effects continually act whilst the vessel is immersed in the water, it happens but too often that the keel experiences the bad effect of a strain. It is therefore very important to inquire into the true cause of this accident.

For this purpose, let us conceive the vessel to be divided into two parts by a transverse section through the vertical axis of the vessel, in which both the centre of gravity G (fig. 51.) of the whole vessel and that of the immersed part are situated: so that one of them will represent the head part, and the other that of the stern, each of which will be considered separately. Let g be the centre of gravity of the entire weight of the first, and o that of the immersed part corresponding. In like manner, let γ be the centre of gravity of the whole after part, and w that of its immediate portion.

Now it is plain, that the head will be acted upon by the two forces gm and on , of which the first will press it down, and the latter push it up. In the same manner, the stern will be pressed down by the force γu , and pushed by the force ow . But these four forces will maintain themselves in equilibrium, as well as the total forces reunited in the points G and O , which are equivalent to them; but whilst neither the forces before nor those behind fall in the same direction, the vessel will evidently sustain efforts tending to bend the keel upwards, if the two points ow are nearer the middle than the two other forces gm and γu . A contrary effect would happen if the points o and w were more distant from the middle than the points g and γ .

But the first of these two causes usually takes place almost in all vessels, since they have a greater breadth towards the middle, and become more and more narrow towards the extremities; whilst the weight of the vessel is in proportion much more considerable towards the extremities than at the middle. From whence we see, that the greater this difference becomes, the more also will the vessel be subject to the forces which tend to bend its keel upwards. It is therefore from thence that we must judge how much strength it is necessary to give to this part of the vessel, in order to avoid such a consequence.

If other circumstances would permit either to load the vessel more in the middle, or to give to the part immersed a greater capacity towards the head and stern, such an effect would no longer be apprehended. But the destination of most vessels is entirely opposite to such an arrangement: by which means we are obliged to strengthen the keel as much as may be necessary, in order to avoid such a disaster.

We shall conclude this chapter with the following practical observations on the hogging and sagging of ships by Mr Hutchinson of Liverpool.

"When ships with long floors happen to be laid a-dry upon mud or sand, which makes a solid resistance against the long straight floors amidships, in comparison with the two sharp ends, the entrance and run meet with

little support, but are pressed down, so that the flat of the floor, and in proportion hogs the ship amidships; which is too well known from experience to occasion many total losses, or do so much damage by hogging them, as to require a vast deal of trouble and expence to live and repair them, so as to get the hog taken out and brought to their proper lacer again; and to do this the more effectually, the owners have often been induced to go to the expence of lengthening them; and by the common method, in proportion as they add to the burden of these ships, by lengthening their two long straight floors in their main bodies amidships, so much do they add to their general weakness to bear hardships either on the ground or afloat; for the seaming of their old timber and plank is not proportionable to bear the additional burden that is added to them.

"But defects of this kind are best proved from real and incontestable facts in common practice. At the very time I was writing upon this subject, I was called upon for my advice by the commander of one of those strong, long, straight floored ships, who was in much trouble and distraction of mind for the damage his ship had taken by the pilot laying her on a hard, gentle sloping sand, at the outside of our docks at Liverpool, where it is common for ships that will take the ground to lie for a tide, when it proves too late to get into our wet docks. After recommending a proper ship carpenter, I went to the ship, which lay with only a small keel, yet was greatly hogged, and the butts of her upper works strained greatly on the lee side; and the seams of her bottom, at the lower futtock heads, vastly opened on the weather side: all which strained parts were agreed upon not to be caulked, but filled with tallow, putty, or clay, &c. with raw bullocks hides, or canvas nailed with batons on her bottom, which prevented her sinking with the flow of the tide, without hindering the pressure of water from righting and closing the seams again as she floated, so as to enable them to keep her free from pumping. This vessel, like many other instances of ships of this construction that I have known, was fixed and repaired at a very great expence in our dry repairing docks. And that their bottoms not only hog upwards, but sag (or curve) downwards, to dangerous and fatal degrees, according to the strain or pressure that prevails upon them, will be proved from the following facts:

"It has been long known from experience, that when ships load deep with very heavy cargoes or materials that are stowed too low, it makes them so very labour-some at sea, when the waves run high, as to roll away their masts; and after that misfortune causes them to labour and roll the more, so as to endanger their working and straining themselves to pieces: to prevent which, it has been long a common practice to leave a great part of their fore and after holds empty, and to stow them as high as possible in the main body at midships, which causes the bottoms of these long straight-floored ships to sag downwards, in proportion as the weight of the cargo stowed there exceeds the pressure of the water upwards, so much as to make them dangerously and fatally leaky.

"I have known many instances of these strong ships of 500 or 600 tons burthen built with long straight floors, on the east coast of England, for the coal and timber trade, come loaded with timber from the Baltic

EF of the Water to bend a Vessel.

Plate CCCXXV. Fig. 51.

64 The cause of a ship's hogging.

65 Sagging.

Practical Seaman-ship, p. 12.

Efforts of
the Water
to bend a
Vessel.

to Liverpool, where they commonly load deep with rock salt, which is too heavy to fill their holds, so that for the above reasons they stowed it high amidships, and left large empty spaces in their fore and after holds, which caused their long straight floors to sag downwards, so much as to make their hold stanchions amidships, at the main hatchway, settle from the beams three or four inches, and their mainmasts settle so much as to oblige them to set up the main rigging when rolling hard at sea, to prevent the masts being rolled away; and they were rendered so leaky as to be obliged to return to Liverpool to get their leaks stopped at great expence. And in order to save the time and expence in discharging them, endeavours were made to find out and stop their leaks, by laying them ashore dry on a level sand; but without effect: for though their bottoms were thus fagged down by their cargoes when afloat, yet when they came a-dry upon the sand, some of their bottoms hogged upwards so much as to raise their mainmasts and pumps so high as to tear their coats from their decks; so that they have been obliged to discharge their cargoes, and give them a repair in the repairing dock, and in some to double their bottoms, to enable them to carry their cargoes with safety, stowed in this manner. From this cause I have known one of these strong ships to founder.

“Among the many instances of ships that have been distressed by carrying cargoes of lead, one failed from hence bound to Marseilles, which was soon obliged to put back again in great distress, having had four feet water in the hold, by the commander’s account, owing to the ship’s bottom sagging down to such a degree as made the hold stanchions settle six inches from the lower deck beams amidships; yet it is common with these long straight floored ships, when these heavy cargoes are discharged that make their bottoms sag down, then to hog upwards: so that when they are put into a dry repairing dock, with empty holds, upon straight blocks, they commonly either split the blocks close fore and aft, or damage their keels there, by the whole weight of the ship lying upon them, when none lies upon the blocks under the flat of their floors amidships, that being hogged upwards; which was the case of this ship’s bottom; though fagged downwards six inches by her cargo, it was now found hogged so much that her keel did not touch the blocks amidships, which occasioned so much damage to the after part of the keel, as to oblige them to repair it; which is commonly the case with these ships, and therefore deserving particular notice.”

In order to prevent these defects in ships, “they should all be built with their floors or bottoms lengthwise, to form an arch with the projecting part downwards, which will naturally not only contribute greatly to prevent their taking damage by their bottoms hogging and straining upwards, either aground or afloat, as has been mentioned, but will, among other advantages, be a help to their sailing, steering, staying, and waring.”

CHAP. III. Of the Stability of Ships.

WHEN a vessel receives an impulse or pressure in a horizontal direction, so as to be inclined in a small degree, the vessel will then either regain its former position as the pressure is taken off, and is in this case

Stability of Ships.

be possessed of stability; or it will continue in its inclined state; or, lastly, the inclination will increase until the vessel is overturned. With regard to the first case, it is evident that a sufficient degree of stability is necessary in order to sustain the efforts of the wind; but neither of the other two cases must be permitted to have place in vessels.

Let CED (fig. 52.) be the section of a ship passing through its centre of gravity, and perpendicular to the floor and floor plans; which let be in equilibrium in a fluid; AB being the water line, G the centre of gravity of the whole body, and g that of the immerfed part AEB. Let the body receive now a very small inclination, so that aEb becomes the immerfed part, and γ its centre of gravity. From γ draw γM perpendicular to ab , and meeting gG , produced, if necessary, in M. If, then, the point M thus found is higher than G the centre of gravity of the whole body, the body will, in this case, return to its former position, the pressure being taken off. If the point M coincides with G, the vessel will remain in its inclined state; but if M be below G, the inclination of the vessel will continually increase until it is entirely overfet.

The point of interfection M is called the *metacenter*, and is the limit of the altitude of the centre of gravity of the whole vessel. Whence it is evident, from what has already been said, that the stability of the vessel increases with the altitude of the metacenter above the centre of gravity: But when the metacenter coincides with the centre of gravity, the vessel has no tendency whatever to move out of the situation into which it may be put. Thus, if the vessel be inclined either to the right or left side, it will remain in that position until a new force is impressed upon it: in this case, therefore, the vessel would not be able to carry sail, and is hence unfit for the purposes of navigation. If the metacenter is below the common centre of gravity, the vessel will instantly overfet.

As the determination of the metacenter is of the utmost importance in the construction of ships, it is therefore thought necessary to illustrate this subject more particularly.

Let AEB (fig. 52.) be a section of a ship perpendicular to the keel, and also to the plane of elevation, and passing through the centre of gravity of the ship, and also through the centre of gravity of the immerfed part, which let be g .

Now let the ship be supposed to receive a very small inclination, so that the line of floatation is a, b , and γ the centre of gravity of the immerfed part aEb . From γ draw γM perpendicular to ab , and intersecting GM in M, the metacenter, as before. Hence the pressure of the water will be in the direction γM .

In order to determine the point M, the metacenter, the position of γ with respect to the lines AB and gG , must be previously ascertained. For this purpose, let the ship be supposed to be divided into a great number of sections by planes perpendicular to the keel, and parallel to each other, and to that formerly drawn, these planes being supposed equidistant. Let AEB (fig. 53.) Fig. 53. be one of these sections, g the centre of gravity of the immerfed part before inclination, and γ the centre of gravity of the immerfed part when the ship is in its inclined state; the distance $g\gamma$ between the two centres

Stability of gravity in each section is to be found. Let AB be the line of floatation of the ship, when in an upright state, and *ab* the water line when inclined. Then, because the weight of the ship remains the same, the quantity of water displaced will also be the same in both cases, and therefore $AEB = aEb$, each sustaining the same part of the whole weight of the ship. From each of these take the part AEb , which is common to both, and the remainders AOa , BOb will be equal; and which, because the inclination is supposed very small, may be considered as rectilinear triangles, and the point O the middle of AB .

Now, let H, I, K , be the centres of gravity of the spaces AOa , AEb , and BOb , respectively. From these points draw the lines Hh, Ii , and Kk , perpendicular to AB , and let IL be drawn perpendicular to EO . Now to ascertain the distance γg of the centre of gravity γ of the part aEb from the line AB , the momentum of aEb with respect to this line must be put equal to the difference of the momentums of the parts AEb , AOa , which are upon different sides of AB . Hence $AEB \times \gamma g$, or $AEB \times \gamma g = AEB \times Ii - AOa \times Hh$. But since g is the common centre of gravity of the two parts AEb , BOb , we have therefore $AEB \times gO = AEB \times Ii + BOb \times Kk$. Hence by expunging the term $AEB \times Ii$ from each of these equations, and comparing them, we obtain $ALB \times \gamma g = AEB \times gO - BOb \times Kk = AOa \times Hh$.

Now, since the triangles AOa , BOb , are supposed infinitely small, their momentums or products, by the infinitely little lines Hh, Kk , will also be infinitely small with respect to $AEB \times gO$; which therefore being rejected, the former equation becomes $AEB \times \gamma g = AEB \times gO$, and hence $\gamma g = gO$. Whence the centres of gravity γ, g , being at equal distances below AB , the infinitely little line γg is therefore perpendicular to EO . For the same reason $g\gamma$, fig. 52. may be considered as an arch of a circle whose centre is M .

To determine the value of $g\gamma$, the momentum of aEb with respect to EO must be taken, for the same reason as before, and put equal to the momentums of the two parts AOa , AEb ; and we shall then have $aEb \times g\gamma$, or $AEB \times g\gamma = AEB \times IL + AOa \times Ok$. But since g is the common centre of gravity of the two spaces AEb , BOb , we shall have $AEb \times IL = BOb \times Ok = O$, or $AEb \times IL = BOb \times Ok$. Hence $AEB \times g\gamma = BOb \times Ok + AOa \times Ok = 2 BOb \times Ok$; because the two triangles AOa , BOb are equal, and that the distances Ok, Ok , are also evidently equal.

Let x be the thickness of the section represented by ABC . Then the momentum of this section will be $2 BOb \times x \times Ok$, which equation will also serve for each particular section.

Now let f represent the sum of the momentums of all the sections. Hence $f, AEB \times x \times g\gamma = f, 2 BOb \times x \times Ok$. Now the first member being the sum of the momentums of each section, in proportion to a plane passing through the keel, ought therefore to be equal to the sum of all the sections, or to the volume of the immerged part of the bottom multiplied by the distance $g\gamma$. Hence V representing the volume, we shall have $V \times g\gamma = f, 2 BOb \times x \times Ok$.

In order to determine the value of the second member of this equation, it may be remarked, that when the ship is inclined, the original plane of floatation $CBPQ$

(fig. 54.) becomes $Cb\rho Q$. Now the triangles $NI n$, $Stability of EO b$, being the same as those in figures 52. and 53.; and as each of these triangles has one angle equal, they may, upon account of their infinite smallness, be considered as similar; and hence $BO b : NI n :: OB, b^2 : IN, n^2$; whence $BO b = \frac{OB, b^2}{IN, n^2} \times NI n$. Moreover, we have (fig. 53.) $O b = \frac{1}{2} OB$, for the points K and l may be considered as equidistant from the point O ; whence $BO b \times O b = \frac{1}{4} \frac{OB, b^3}{IN, n^2} \times NI n$.

Hence $V \times g\gamma = f, \frac{1}{4} \frac{OB, b^3}{IN, n^2} \times x \times NI n$. From this equation the value of $g\gamma$ is obtained.

To find the altitude gM (fig. 55.) of the meta-centre above the centre of gravity of the immerged part of the bottom, let the arc NS be described from the centre I with the radius IN ; then $NI n = \frac{IN \times NS}{2}$. Now since the two straight lines $\gamma M, gM$ are perpendicular to an and AN respectively, the angles M and $NI n$ are therefore equal: and the infinitely little portion $g\gamma$, which is perpendicular to gM , may be considered as an arch described from the centre M . Hence the two sectors $NI S, gM \gamma$ are similar; and therefore $gM : g\gamma :: IN : NS$. Hence $NS = \frac{IN \times g\gamma}{gM}$; and consequently

$$NI n = \frac{IN^2 \times g\gamma}{2gM}$$

Now this being substituted in the former equation, and reduced, we have $V \times g\gamma = f \frac{1}{4} \frac{OB, b^3}{gM} \times x \times g\gamma$. But since gM and $g\gamma$ are the same, whatever section may be under consideration, the equation may therefore be expressed thus, $V \times g\gamma = \frac{1}{4} \frac{OB, b^3}{gM} \times x$. Hence $gM = \frac{1}{4} \frac{OB, b^3 \times x}{V}$. Let $y = OB$, and the equation becomes $gM = \frac{1}{4} \frac{y^3 \times x}{V}$.

Whence to have the altitude of the meta-centre above the centre of gravity of the immerged part of the bottom, the length of the section at the water-line must be divided by lines perpendicular to the middle line of this section into a great number of equal parts, so that the portion of the curve contained between any two adjacent perpendiculars may be considered as a straight line. Then the sum of the cubes of the half perpendiculars or ordinates is to be multiplied by the distance between the perpendiculars, and two-thirds of the product is to be divided by the volume of the immerged part of the bottom of the ship.

It is hence evident, that while the section at the water line is the same, and the volume of the immerged part of the bottom remains also the same, the altitude of the meta-centre will remain the same, whatever may be the figure of the bottom.

CHAP. IV. Of the Centre of Gravity of the immerged Part of the Bottom of a Ship.

The centre of gravity * of a thin, supple homogeneous, and in an upright position in the water, is in a vertical

* Besant's Mechanics, art. 203.

Stability of Ship.

Centre of Gravity. of a ship is by a mechanical operation, as follows: Construct a block of as light wood as possible, exactly similar to the parts of the proposed draught or ship, by a scale of about one-fourth of an inch to a foot. The block is then to be suspended by a silk-thread or very fine line, placed in different situations until it is found to be in a state of equilibrium, and the centre of gravity will be pointed out. The block may be proved by fastening the line which suspends it to any point in the line joining the middles of the stem and poit, and weights are to be suspended from the extremities of this middle line at the stem and poit. If, then, the block be properly constructed, a plane passing through the line of suspension, and the other two lines, will also pass through the keel, stem, and poit. Now, the block being suspended in this manner from any point in the middle line, a line is to be drawn on the block parallel to the line of suspension, so that the plane passing through these two lines may be perpendicular to the vertical plane of the ship in the direction of the keel. The line by which the block is suspended is then to be removed to some other

convenient point in the middle line, and another line is to be drawn on the block parallel to the line suspending it, as before. Then the point of intersection of this line with the former will give the position of the centre of gravity on the block, which may now be laid down in the draught.

Centre of Gravity.

69
A mechanical method for ascertaining the centre of gravity of a ship.

CHAP. V. Application of the preceding Rules to the Determination of the Centre of Gravity and the Height of the Metacenter above the Centre of Gravity of a Ship of 74 Guns.

In fig. 59. are laid down the several sections in a horizontal direction, by planes parallel to the keel, and at equal distances from each other, each distance being 10 feet 0 inches 4 parts.

I. Determination of the Centre of Gravity of the upper Horizontal Section.

To find the distance of the centre of gravity of the plane 8 g o G from the first ordinate 8 g.

Ordinates.	Double Ord.	1st Factors	1st Products.	2d Factors.	2d Products.
Feet. In. P.	Feet. In. P.		Feet. In. P.		Feet. In. P.
14 9 0	29 6 0	$\frac{1}{2}$	4 11 0	$\frac{1}{2}$	14 9 0
17 1 6	34 3 0	1	34 3 0	1	34 3 0
18 9 0	37 6 0	2	75 0 0	1	37 6 0
19 10 0	39 8 0	3	119 0 0	1	39 8 0
20 7 6	41 3 0	4	165 0 0	1	41 3 0
21 1 9	42 3 6	5	211 5 6	1	42 3 6
21 6 3	43 0 6	6	258 3 0	1	43 0 6
21 7 9	43 3 6	7	303 0 6	1	43 3 6
21 7 9	43 3 6	8	346 4 0	1	43 3 6
21 7 6	43 3 0	9	389 3 0	1	43 3 0
21 4 0	42 8 0	10	426 8 0	1	42 8 0
20 10 6	41 9 0	11	459 3 0	1	41 9 0
19 9 0	39 6 0	12	474 0 0	1	39 6 0
17 4 6	34 9 0	13	451 9 0	1	34 9 0
13 1 3	26 2 6	$(3 \times 15) - 4 \times \frac{1}{2}$	179 1 1	$\frac{1}{2}$	13 1 3
291 1 3	582 2 6		3897 3 1		534 4 3

Now $\frac{3897 \cdot 3 \cdot 1}{554 \cdot 4 \cdot 3} \times 10 \cdot 0 \cdot 4 = \frac{3897 \cdot 25}{554 \cdot 25} \times 10 \cdot 0 \cdot 3 = 70 \cdot 5$.

Hence the distance of the centre of gravity of double the plane 8 g o G from the first ordinate, 8 g, is

Distance of this ordinate from the aft side of stern-poit, - - - - - 70.5

Distance of the centre of gravity from the aft side of poit, - - - - - 84.0

Distance of the centre of gravity of double the trapezium AR g 8 from its ordinate AR, - - - - - 84.2

Distance of this ordinate from the aft side of the stern-poit, - - - - - 0.58

Distance of the centre of gravity of this plane from the aft-side of the stern-poit - - - - - 9.0

Distance of the centre of gravity of double the trapezium G o 7 7 from its ordinate G o, - - - - - 5.44

Distance of this ordinate from the aft-side of the poit, - - - - - 153.78

Distance of the centre of gravity of this trapezium from the aft side of the poit, - - - - - 159.22

Distance of the centre of gravity of the section of the stern-poit from the aft part of the poit, - - - - - 0.29

Distance of the centre of gravity of the section of the stern from the aft side of the poit, - - - - - 169.76

SHIP-BUILDING.

The areas of these several planes, calculated by the common method, will be as follow :

5558.90 for that of the plane, and its momentum 5558.9×84	=	466947.6000
199.13 for that of double the trapezium ARG 8, and its momentum 199.13×9	=	1792.1700
214.59 for that of double the trapezium G 0 7 2, and its momentum 214.59×159.22	=	34167.0236
0.77 for that of the section of the stern-post, and its momentum 0.77×0.29	=	0.2233
0.77 for that of the section of the stem, and its momentum 0.77×169.76	=	130.7152
5974.16 Sum		503037.7321

Now $\frac{503037.7321}{5974.16} = 84.2$, the distance of the centre of gravity of the whole section from the aft side of the stern-post.

II. Determination of the Centre of Gravity of the second Horizontal Section.

To find the distance of the centre of gravity of double the plane 8fnG from its first ordinate 8f.

Ordinates.			Double Ord.			1. Factors.			2. Fact.			3. Products.		
Feet.	In.	Pts.	Feet.	In.	Pts.		Feet.	In.	Pts.		Feet.	In.	Pts.	
11	2	3	22	4	6	$0\frac{1}{8}$	3	8	9	$0\frac{1}{2}$	11	2	3	
15	3	0	30	6	0	1	30	6	0	1	30	6	0	
17	5	0	34	10	0	2	69	8	0	1	34	10	0	
18	10	3	37	8	6	3	113	1	6	1	37	8	6	
19	10	6	39	9	0	4	159	0	0	1	39	9	0	
20	7	0	41	2	0	5	205	10	0	1	41	2	0	
21	0	3	42	0	6	6	252	3	0	1	42	0	6	
21	2	0	42	4	0	7	296	4	0	1	42	4	0	
21	0	6	42	1	0	8	336	8	0	1	42	1	0	
20	10	9	41	9	6	9	376	1	6	1	41	9	6	
20	6	6	41	1	0	10	410	10	0	1	41	1	0	
19	10	0	39	8	0	11	436	4	0	1	39	8	0	
18	6	0	37	0	0	12	444	0	0	1	37	0	0	
15	9	6	31	7	0	13	410	7	0	1	31	7	0	
11	2	9	22	5	6	$(3 \times 15) - 4$	$\times \frac{1}{8}$	153	5	6	$0\frac{1}{2}$	11	2	9
273	2	3	546	4	6			3698	5	3		523	11	6

Hence the distance of the centre of gravity of double the plane 8fnG from its first ordinate 8n is $\frac{3698 \frac{5}{6} \times 3}{523 \frac{11}{6}} \times 10.04 = \frac{3698.13}{523.95} \times 10.03 =$ - - - - - 70.79

Distance of this ordinate from the aft side of the stern-post - - - - - 13.5

Distance of the centre of gravity of the above planes from the aft side of post - - - - - 84.29

Distance of the centre of gravity of double the trapezium ARf8 from its ordinate AR - - - - - 8.38

Distance of this ordinate from aft side of stern-post - - - - - 0.57

Distance of the centre of gravity of the trapezium from the aft side of the post - - - - - 8.95

Distance of the centre of gravity of the trapezium before the ordinate G n from that ordinate - - - - - 5.74

Distance of that ordinate from the aft side of the post - - - - - 153.78

Distance of the centre of gravity of the trapezium from the aft side of the post - - - - - 159.52

Distance of the centre of gravity of the section of the stern-post from the aft side of the post - - - - - 0.29

Distance of the centre of gravity of the section of the stem from the aft side of the post - - - - - 169.76

The

The areas of these several planes being calculated, will be as follow .

525.22 for that of the plane <i>8fnG</i> , and its momentum $525.22 \times 84.29 =$	442962.4938
153.11 for that of double the trapezium <i>ARf8</i> , and its momentum $153.11 \times 8.95 =$	1370.3345
182.40 the area of the trapezium before, and its momentum $182.40 \times 159.52 =$	29096.4480
0.77 the area of the section of the stern-post, and its momentum $0.77 \times 0.29 =$	0.2233
0.77 the area of the section of the stem, and its momentum $0.77 \times 169.76 =$	130.7152
5592.27 Sum	473560.2148

Now $\frac{473560.2148}{5952.27} = 84.68$, the distance of the centre of gravity of the whole section from the aft-side of the stern-post.

III. Determination of the Centre of Gravity of the third Horizontal Section.

Distance of the centre of gravity of double the plane *8emG* from its first ordinate *8e*.

Ordinates.	Double Ord.	1st Factors.	1st Products.	2d Fact.	2d Products.
Feet. In. Pts.	Feet. In. Pts.		Feet. In. Pts.		Feet. In. Pts.
6 7 6	13 3 0	$\frac{1}{2}$	2 2 6	$\frac{1}{2}$	6 7 6
11 7 6	23 3 0	1	23 3 0	1	23 3 0
15 1 0	30 2 0	2	60 4 0	1	30 2 0
17 1 3	34 2 6	3	102 7 6	1	34 2 6
18 3 0	36 6 0	4	144 0 0	1	36 6 0
19 3 0	38 6 0	5	192 6 0	1	38 6 0
19 9 0	39 6 0	6	237 0 0	1	39 6 0
20 0 0	40 0 0	7	280 0 0	1	40 0 0
20 0 0	40 0 0	8	320 0 0	1	40 0 0
19 8 3	39 4 6	9	354 4 6	1	39 4 6
19 1 3	38 2 6	10	382 1 0	1	38 2 6
18 1 0	36 2 0	11	397 10 0	1	36 2 0
16 3 9	32 7 6	12	391 6 0	1	32 7 6
13 2 3	26 4 6	13	342 10 6	1	26 4 6
8 4 6	16 9 0	$\left((3 \times 15) - 4 \right) \times \frac{1}{3} = 114$	5 6	$\frac{1}{2}$	8 4 6
242 5 3	484 10 6		3347 0 6		469 10 6

Hence the distance of the centre of gravity of double the plane *8emG* from its first ordinate *8e* is = $\frac{3347}{469} \times \frac{0}{10} \times \frac{6}{6} \times 10 \times 0 = 4 = \frac{3347.04}{469.87} \times 10.03 =$ - - - - - 71.44

Distance of this ordinate from the aft side of the post - - - - - 13.5

Hence the distance of the centre of gravity of this plane from the aft side of the post is - - - - - 84.94

Distance of the centre of gravity of double the trapezium *ARe8*, from its ordinate *AR* - - - - - 8.03

Distance of this ordinate from the aft side of the post - - - - - 0.38

Distance of the centre of gravity of this trapezium from the aft side of the post - - - - - 8.61

Distance of the centre of gravity of the foremost trapezium from its ordinate *Gm* - - - - - 5.19

Distance of this ordinate from the aft side of the post - - - - - 153.78

Distance of the centre of gravity of this trapezium from the aft side of the post - - - - - 158.97

Distance of the centre of gravity of the section of the post from the aft side of the post - - - - - 0.29

Distance of the centre of gravity of the section of the stem from the aft side of the post - - - - - 169.76

The

SHIP-BUILDING.

The areas of these several planes will be found to be as follows :

4712.7961	for that of double the plane $8 e m G$, and its momentum $4712.7961 \times 84.94 =$	400304.9207
93.84	the area of double the trapezium $AR 3 e 88$, and its momentum $93.84 \times 8.61 =$	807.9624
131.1	for the area of foremoit trapezium, and its momentum $131.1 \times 158.97 =$	20840.967
0.77	the area of the section of the post, and its momentum $0.77 \times 0.29 =$	0.2233
0.77	the area of the section of the item, and its momentum $0.77 \times 169.76 =$	130.7152
<hr/> 4939.2761	Sum	<hr/> 422084.7706

Now $\frac{422084.7706}{4939.2761} = 85.45$, the distance of the centre of gravity of the whole section from the aft side of the post.

IV. Determination of the Centre of Gravity of the Fourth Horizontal Section.

Distance of the centre of gravity of double the plane $8 d / G$ from its first ordinate $8 d$.

Ordinates.	Double Ord.	1. Factors.	1. Products.	2. Fact.	2. Products.
Fect. In. Pts.	Fect. In. Pts.		Fect. In. Pts.		Fect. In. Pts.
3 3 6	6 7 0	$0\frac{1}{2}$	1 1 2	$0\frac{1}{2}$	3 3 6
7 9 0	15 6 0	1	15 6 0	1	15 6 0
11 11 0	23 10 0	2	47 8 0	1	23 10 0
14 8 9	29 5 6	3	88 4 6	1	29 5 6
16 3 0	32 6 0	4	130 0 0	1	32 6 0
17 4 9	34 9 6	5	173 11 5	1	34 9 6
18 1 9	36 3 6	6	217 9 0	1	36 3 6
18 5 0	36 10 0	7	257 10 0	1	36 10 0
18 3 0	36 6 0	8	292 0 0	1	36 6 0
17 10 9	35 9 6	9	322 1 6	1	35 9 6
17 2 6	34 5 0	10	340 10 0	1	34 5 0
15 10 3	31 8 6	11	348 9 6	1	31 8 6
13 6 0	27 0 0	12	324 0 0	1	27 0 0
9 7 6	19 3 0	13	250 3 0	1	19 3 0
5 4 9	10 9 6	$((3 \times 15) - 4) \times \frac{1}{2}$	73 8 11	$0\frac{1}{2}$	5 4 9
<hr/> 205 7 6	<hr/> 411 3 0		<hr/> 2883 11 0		<hr/> 402 6 9

Hence the distance of the centre of gravity of double the plane $8 d / G$ from its first ordinate $8 d$, is
 $= \frac{2883 \ 11 \ 0}{402 \ 6 \ 9} \times 10 \ 0 \ 4 = \frac{2883.916}{402.56} \times 10.03 =$ - - - 71.85

Distance of this ordinate from the aft side of the post - - - 13.5

Distance of the centre of gravity of the plane from the aft side of the post - - - 85.35

Distance of the centre of gravity of double the trapezium $AR d 8$ from its ordinate AR - - - 7.89

Distance of this ordinate from the aft side of the post - - - 0.58

Distance of the centre of gravity of the trapezium from the aft side of the post - - - 8.47

Distance of the centre of gravity of the foremoit trapezium from its ordinate $G l$ - - - 4.83

Distance of this ordinate from aft side of the post - - - 153.78

Distance of the centre of gravity of the trapezium from the aft side of the post - - - 158.61

Distance of the centre of gravity of the section of the post from its aft side - - - 0.29

Distance of the centre of gravity of the section of the item from the aft side of the post - - - 169.76

SHIP-BUILDING.

303

Centre of Gravity.

Centre of Gravity.

The areas of these several planes being calculated, will be as follow :

4237.6768	for that of double the plane $8 d l G$, and its momentum $4237.6768 \times 85.35 =$	344615.7149
51.12	the area of double the trapezium $AR d 8$, and its momentum $51.12 \times 8.47 =$	432.9804
79.16	the area of the foremoft trapezium, and its momentum $79.16 \times 18.61 =$	12555.5676
0.77	the area of the fection of the poft, and its momentum $0.77 \times 0.29 =$	0.2233
0.77	the area of the fection of the Item, and its momentum $0.77 \times 169.76 =$	130.7152
4169.4968	Sum	357735.2074

Then $\frac{357735.2074}{4169.4968} = 85.35$, the diftance of the fourth horizontal fection from the aft fide of the Item-poft.

V. Determination of the Centre of Gravity of the fifth Horizontal Section.

Diftance of the centre of gravity of double the plane $8 e k G$ from its firft ordinate $8 c$.

Ordinates.		Double Ord.		1. Factors.	1. Products.	2. Fact.	2. Products.		
Feet.	In. L.	Feet.	In. L.		Feet.	In. L.	Feet.	In. L.	
1	9	0	3	6	0	$\frac{1}{2}$	1	9	0
4	6	0	9	0	1	0	9	0	0
8	3	0	16	6	2	33	16	6	0
11	8	3	23	4	6	3	23	4	6
13	10	3	27	8	6	4	27	8	6
15	3	0	30	6	0	5	30	6	0
16	0	3	32	0	6	6	32	0	6
16	5	0	32	10	0	7	32	10	0
16	3	0	32	6	0	8	32	6	0
15	9	0	31	6	0	9	31	6	0
14	10	0	29	8	0	10	29	8	0
12	10	3	25	8	6	11	25	8	6
9	8	9	19	5	6	12	19	5	6
6	1	6	12	3	0	13	12	3	0
3	3	0	6	6	0	$\left((3 \times 15) - 4 \right) \times \frac{1}{2}$	44	5	0
166	6	3	333	0	7		2358	3	0
									328

Hence the diftance of the centre of gravity of double the plane $8 e k G$ from its firft ordinate is $\frac{2358.3}{328} = 0.6$

$\times 10 = 0.4 = \frac{2358.25}{328.04} \times 10.03 =$ - - - - - 72.16

Diftance of this ordinate from the aft fide of the poft - - - - - 13.50

Diftance of the centre of gravity of the plane from the aft fide of the poft] - - - - - 85.60

Diftance of the centre of gravity of double the trapezium $AR c 8$ from its ordinate AR - - - - - 7.42

Diftance of this ordinate from the aft fide of poft - - - - - 0.58

Diftance of centre of gravity of trapezium from aft fide of the poft - - - - - 8.00

Diftance of the centre of gravity of the foremoft trapezium from its ordinate $G k$ - - - - - 4.22

Diftance of this ordinate from the aft fide of poft - - - - - 153.78

Diftance of the centre of gravity of the foremoft trapezium from the aft fide of the poft - - - - - 158.00

Diftance of the centre of gravity of the fection of the poft from the aft fide of poft - - - - - 0.29

Diftance of the centre of gravity of the fection of the Item from the aft fide of poft - - - - - 169.76

The

SHIP-BUILDING.

The areas of these several planes being calculated, will be as follow.

		Centre of Gravity.
3290.2412	for the area of double the plane 8 e k G, and its momentum 3290.2412 × 85.6 =	281644.6467
31.21	the area of double the trapezium AR c 8, and its momentum 31.21 × 8 =	249.68
42.43	the area of the foremoft trapezium, and its momentum 42.43 × 15½ =	6703.94
0.77	the area of the fection of the poft, and its momentum 0.77 × 29 =	0.2233
0.77	the area of the fection of the ftem, and its momentum 0.77 × 169.76 =	130.7152
<hr/>		
3365.4212	Sum	288729.2052

Now $\frac{288729.2052}{3365.4212} = 85.79$, the diftance of the centre of gravity of the whole fection from the aft fide of the ftem.

VI. Determination of the Centre of Gravity of the fixth Horizontal Section.

Diftance of the centre of gravity of double the plane 8 b i G from its firft ordinate 8 b.

Ordinates.		Double Ord.		1. Factors.		1. Products.		2. Fact.		2. Products.	
Feet.	In. L.	Feet.	In. L.		Feet	In	L.		Feet.	In.	L.
1	0 0	2	0 0	0½	0	4	0	0½	1	0	0
2	5 0	4	10 0	1	4	10	0	1	4	10	0
4	5 0	8	10 0	2	17	8	0	1	8	10	0
7	3 6	14	7 0	3	43	9	0	1	14	7	0
10	1 9	20	3 6	4	81	2	0	1	20	3	6
12	1 3	24	2 6	5	121	0	6	1	24	2	6
13	3 0	26	6 0	6	159	0	0	1	26	6	0
13	9 9	27	7 6	7	193	4	6	1	27	7	6
13	7 0	27	2 0	8	217	4	0	1	27	2	0
12	8 0	25	4 0	9	228	0	0	1	25	4	0
10	6 6	21	1 0	10	210	10	0	1	21	1	0
7	1 0	14	2 0	11	155	10	0	1	14	2	0
4	7 3	9	2 6	12	110	6	0	1	9	2	6
2	10 6	5	9 0	13	74	9	0	1	5	9	0
1	6 9	3	1 6	$6 \times ((3 \times 15) - 4) \times \frac{1}{2}$		21	4 3	0½	1	6	9
<hr/>		<hr/>		<hr/>		<hr/>		<hr/>		<hr/>	
117	4 3	234	8 6		1639	9 3			232	1 9	

Hence the diftance of the centre of gravity of double the plane 8 b v G from its firft ordinate 8 b is

$$\frac{1639.9}{232.1} \times 10.0 = \frac{1639.77}{232.14} \times 10.03 = 70.84$$

Diftance of this ordinate from aft fide of poft - - - - - 13.50

Hence the diftance of the centre of gravity of the plane from the aft fide of the poft is - - - 84.34

Diftance of the centre of gravity of the trapezium AR b 8 from its ordinate AR - - - 6.88

Diftance of this ordinate from the aft fide of the poft - - - 0.58

Diftance of the centre of gravity of the trapezium from the aft fide of the poft - - - 7.46

Diftance of the centre of gravity of the foremoft trapezium from the ordinate G i - - - 2.92

Diftance of this ordinate from the aft fide of poft - - - 153.78

Diftance of the centre of gravity of this trapezium from the aft fide of the poft - - - 156.70

Diftance of the centre of gravity of the fection of the poft from its aft fide - - - 0.29

Diftance of the centre of gravity of the fection of the ftem from the aft fide of the poft - - - 169.76

The areas of these planes will be found to be as follow :

2328.3642	for that of double the plane 8 b i G, and its momentum 2328.3642 + 84.34 =	196374.2366
21.52	for the area of double the trapezium AR b 8, and its momentum 21.52 × 7.46 =	160.5392
15.04	the area of the foremoft trapezium, and its momentum 15.04 × 156.7 =	2356.7680
0.77	the area of the fection of the poft, and its momentum 0.77 × 0.29 =	0.2233
0.77	the area of the fection of the ftem, and its momentum 0.77 × 169.76 =	130.7152
<hr/>		
2366.4642	Sum	199022.4823

Centre of Gravity.

Centre of Gravity.

Now $\frac{109222.4823}{2366.4642} = 84.1$, the distance of the centre of gravity of the whole from the aft side of the post.

VII. Determination of the Centre of Gravity of the seventh Horizontal Section.

Distance of the centre of gravity of double the plane *S a h G* from its first ordinate *a a*.

Ordinates.	Double Ord.	1. Factors.	1. Products.	2. Fact.	2 Products.
Feet. In. Lin.	Feet. In. L.		Feet. In. Lin.	Feet. In. Lin.	Feet. In. Lin.
0 8 0	1 4 0	0 $\frac{1}{2}$	0 2 8	0 8 0	0 8 0
1 1 6	2 3 0	1	2 3 0	1 2 3 0	2 3 0
1 7 6	3 3 0	2	6 6 0	1 3 3 0	3 3 0
1 10 9	3 9 6	3	11 4 6	1 3 9 6	3 9 6
2 1 3	4 2 6	4	16 10 0	1 4 2 6	4 2 6
2 1 0	4 2 0	5	20 10 0	1 4 2 0	4 2 0
1 10 9	2 9 6	6	22 9 0	1 3 9 6	3 9 6
1 8 0	3 4 0	7	23 4 0	1 3 4 0	3 4 0
1 1 0	2 2 0	8	17 4 0	1 2 2 0	2 2 0
0 9 0	1 6 0	9	13 6 0	1 1 6 0	1 6 0
0 8 0	1 4 0	10	13 4 0	1 1 4 0	1 4 0
0 8 0	1 4 0	11	14 8 0	1 1 4 0	1 4 0
0 8 0	1 4 0	12	16 0 0	1 1 4 0	1 4 0
0 8 0	1 4 0	13	17 4 0	1 1 4 0	1 4 0
0 8 0	1 4 0	$((3 \times 15) - 4) \times \frac{1}{3}$	9 1 4	0 8 0	0 8 0
18 2 9	36 5 6		205 4 6	35 1 6	

Hence the distance of the centre of gravity of double this plane from its first ordinate is $\frac{205\ 4\ 6}{35\ 1\ 6} \times 10 = 4$

$\frac{205.37}{35.12} \times 10.83 = 58.65$

The distance of this ordinate from aft side of post = 13.50

Hence the distance of the centre of gravity of this plane from the aft side of the post is 72.15

Distance of the centre of gravity of double the rectangle *AR a 8* from its ordinate *AR* 6.45

Distance of this ordinate from the aft side of the post 0.58

Distance of the centre of gravity of this rectangle from the aft side of the post 7.53

Distance of the centre of gravity of the fore-moilt rectangle from its ordinate *7' 7 e 7'* 1.25

Distance of this ordinate from the aft side of the post 153.78

Distance of the centre of gravity of this rectangle from the aft side of the post 155.03

Distance of the centre of gravity of the section of the post from its aft side 0.29

Distance of the centre of gravity of the section of the item from the aft side of the post 169.76

Now, the areas of these several plans being calculated will be as follows.

352.2536, the area of double the plan *S a h G*, and its momentum 25415 9 2

17.1570, the area of double the rectangle *AR a 8*, and its momentum 120.6137

3.3250, the area of the foremoilt rectangle, and its momentum 515.4747

0.77, the area of the section of the post, and its momentum 0.2233

0.77, the area of the section of the item and its momentum 130.7152

374.2756

Sum 26182.1242

Then $\frac{26182.1242}{374.2756} = 69.95$, the distance of the centre of gravity of the whole section from the aft side of the post.

VIII. Determination of the Centre of Gravity of the eighth Plane.

This plane is equal in length to the seventh horizontal plane, and its breadth is equal to that of the keel. The distance between the seventh and eighth planes is three feet, but which is here taken equal to 2 feet 11 $\frac{1}{2}$ inches.

Centre of Gravity.	Distance between the aft side of the post and the first ordinate	13.5	Hor. Planes.	1st Fac.	1st Products.	2d Fac.	2d Products.	Centre of Gravity.	
	Fourteen intervals between the fifteen ordinates, each interval being 10.03 feet	140.42	208.00	0 $\frac{1}{2}$	31.67	c $\frac{1}{2}$	104.00		
	Distance of the last ordinate from the fore foot	2.2	374.27	1	374.27	1	374.27		
	Hence the length of the eighth plane is	136.12	2369.40	2	4732.92	1	2366.46		
	Which multiplied by the breadth	1.33	3365.42	3	10096.26	1	3365.42		
	The product is the area of this plane	208.	4169.50	4	16678.00	1	4169.50		
	The distance of its centre of gravity from the aft side of the post, being equal to half its length, is	78.06	4939.27	5	24669.35	1	4939.27		
			5592.27	6	33553.62	1	5592.27		
			5974.16	$((5 \times 8) - 4) \times \frac{1}{2}$		19913.87	c $\frac{1}{2}$	2987.08	
					110079.96		23898.27		

The centres of gravity of these eight planes being found, the distance of the centre of gravity of the bottom of the ship from the aft side of the post, and also its altitude, may from thence be easily determined.

From the principles already explained, the distance of the centre of gravity of the bottom from the aft side of the post, is equal to the sum of the momentums of an infinite number of horizontal planes, divided by the sum of these planes, or, which is the same, by the solidity of the bottom. As, however, we have no more than eight planes, we must therefore conceive their momentums as the ordinates of a curve, whose distances may be the same as that of the horizontal planes. Now the sum of these ordinates minus half the sum of the extreme ordinates being multiplied by their distance, gives the surface of the curve; of which any ordinate whatever represents the momentum of the horizontal plane at the same altitude as these ordinates; and the whole surface will represent the sum of the momentums of all the horizontal planes.

Hor. Planes.	Fac.	Products.	Momentums.	Fac.	Products.
5974.16	c $\frac{1}{2}$	2987.08	503037.73	c $\frac{1}{2}$	251518.86
5592.27	1	5592.27	473560.21	1	473560.21
4939.27	1	4939.27	422084.77	1	422084.77
4169.50	1	4169.50	357735.21	1	357735.21
3365.42	1	3365.42	288729.20	1	288729.20
2366.46	1	2366.46	199022.48	1	199022.48
374.27	1	374.27	21682.12	1	21682.12
208.00	c $\frac{1}{2}$	104.00	16236.48	c $\frac{1}{2}$	8118.24
		23898.27			2022451.09

Now $\frac{2022451.09}{23898.27} = 84.63$, the distance of the centre of gravity of the bottom of the ship from the aft side of the post.

The height of the centre of gravity of the bottom above the lower edge of the keel may be determined by the same principles. Thus,

To one-sixth of the lowermost horizontal section add the product of one-sixth of the uppermost section by three times the number of sections minus four the second section in ascending, twice the third, three times the fourth, &c.; and to half the sum of the extreme planes add all the intermediate ones. Now the first of these sums, multiplied by the distance between the planes or sections, and divided by the second sum, gives the altitude of the centre of gravity of the bottom of the ship above the lower edge of the keel as required.

Now $\frac{110079.96}{23898.27} \times 2.95 = 13.588$, the height of the centre of gravity of the bottom of the ship above the lower edge of the keel.

We have now found the distance of the centre of gravity of the bottom of the ship from the aft side of the post, and its altitude above the lower edge of the keel. Hence the ship being supposed in an upright position, this centre of gravity will necessarily be in the vertical longitudinal section which divides the ship into two equal and similar parts; the position of this centre is therefore determined.

It now remains to find the height of the metacenter above the centre of gravity; the expression for this altitude, as found in Chap. III. is $\frac{3}{V} \int g^2 x$; which we shall now apply to determine the metacenter of the ship of 74 guns, whose centre of gravity we have already found.

Ord. of the Plane of Floatation.		Cub. of Ordinate.
Feet. Inches.	Feet and dec. of Feet.	
14 9 0	14.7	3209.046
17 1 6	17.1	5000.211
18 9 0	18.7	6591.797
19 10 0	19.8	7762.392
20 7 6	20.6	8741.816
21 1 9	21.2	9595.703
21 6 3	21.5	9938.375
21 7 9	21.7	10289.109
21 7 9	21.7	10289.109
21 7 6	21.7	10289.109
21 4 0	21.3	9663.597
20 10 6	20.9	9129.329
19 9 0	19.7	7793.734
17 4 6	17.4	5268.624
13 1 3	13.1	2248.091
291 1 3	291.1	115719.442

Ordinate at 10.03 feet abaft the ordinate 8g, = 4, of which the cube is 64, and $64 \times \frac{1}{2} = 32$.

Ordinate at 10.03 feet afore the ordinate G = 6, cube of which is 216 and $216 \times \frac{1}{2} = 108$.

Sum	115859.442
Distance between the ordinates	10.03
Product	1162070.20326
	Product

Centre of Gravity.	Product	-	1162770.20326
	Half the cube of the aftermoit ordinate	-	32.
	Half the cube of the thickness of the stem	-	0.14
	Sum	-	32.14
	Distance between the ordinates	-	3.0
	Product	-	96.42
	Half the cube of the foremoit ordinate	-	128.
	Half the cube of the thickness of the stem	-	.14
	Sum	-	108.14
	Distance between the ordinates	-	5.5
	Product	-	594.77
	$f y^3 x$	-	1162761.39326
	$2 f y^2 x$	-	2325522.78652
	$\frac{1}{3} f y^3 x$	-	775174.26217

The solidity of the bottom is $2527\frac{1}{2}$ tons = 70018.67 cubic feet; hence $\frac{\frac{1}{3} f y^3 x}{V} = \frac{77517.26}{70018.67} = 11.07$ feet, the altitude of the metacenter above the centre of gravity of the bottom of the ship.

APPENDIX.

WHEN a ship is built, the mast be fitted with masts, yards, fails, ropes, and blocks, or, in other words, the mast be *rigged* before the can go to sea. To complete this article, it may therefore be thought necessary to treat of the art of rigging vessels; but we have elsewhere (see *MAST-RIGGING, ROPE-MAKING, and SAIL*) shown how the several parts of a ship's rigging are made; and the art of putting them properly together, so as to make the ship bear answer the purpose for which she is intended, depends upon a full knowledge of the impulse and resistance of fluids, and of the theory and practice of seamanship. (See *RESISTANCE of Fluids and SEAMANSHIP*.) Nothing, therefore, of the subject is left to us here, except we wish to state in few words the progressive method of rigging ships; but there is no one undeviating mode which is pursued, as the nature of the operation is such that all the parts of it may be advancing at the same time. We shall therefore take our leave of *ships and ship-building* with a few general observations on *fail-making*, and refer our readers for farther information to the very elegant work on the *Elements and Practice of Rigging and Seamanship* in two volumes quarto.

Sails are made of canvas, of different textures, and are extended on or between the masts, to receive the wind that forces the vessel through the water. They are quadrilateral or triangular, as has been elsewhere described, and are cut out of the canvas cloth by cloth. The width is governed by the length of the yard, gaff, boom, or stay; the depth by the height of the mast.

In the valuable work to which we have just referred, Appendix.

The following directions are given for cutting fails. "The width and depth being given, find the number of cloths the width requires, allowing for seams, tabling on the leeches, and slack cloth; and, in the depth, allow for tabling on the head and foot. For fails cut square on the head and foot, with gores only on the leeches, as some topsails, &c. the cloths on the head, between the leeches, are cut square to the depth; and the gores on the leeches are found by dividing the depth of the fail by the number of cloths gored, which gives the length of each gore. The gore is set down from a square with the opposite selvage; and the canvas being cut diagonally, the longest gored side of one cloth makes the shortest side of the next; consequently, the first gore being known, the rest are cut by it. In the leeches of topsails cut hollow, the upper gores are longer than the lower ones; and in fails cut with a roach leech, the lower gores are longer than the upper ones. This must be regulated by judgment, and care taken that the whole of the gores do not exceed the depth of the leech. Or, by drawing on paper the gored side of the fail, and delineating the breadth of every cloth by a convenient scale of equal parts of an inch to a foot, the length of every gore may be found with precision. Sails, gored with a sweep on the head or the foot, or on both, have the depth of their gores marked on the selvage, from the square of the given depth on each cloth, and are cut as above; the longest selvage of one serving to measure the shortest selvage of the next, beginning with the first gored cloth next the middle in some fails, and the first cloth next to the mast leech in others. For those gores that are irregular so strict rule can be given; they can only be determined by the judgment of the fail-maker, or by a drawing.

"In the royal navy, mizen topsails are cut with three quarters of a yard hollow in the foot; but, in the merchant service, top and topgallant fails are cut with more or less hollow in the foot. Flying jibs are cut with a roach curve on the stay, and a three-inch groove in each cloth, shortening from the tack to the clew. Lower fludding fails are cut with square leeches, and topmast and topgallant-mast fludding fails with goring leeches.

"The length of reef and middle bands is governed by the width of the fail at their respective places; the leech-linings, buntline-cloths, top linings, mast-cloths, and corner-pieces, are cut agreeably to the depth of the fail; each cloth and every article should be properly marked with charcoal, to prevent confusion or mistake. Sails that have bonnets are cut out the whole depth of the fail and bonnet included, allowing enough for the tablings on the foot of the fail and head and foot of the bonnet. The bonnet is cut off after the fail is sewed together. If a drabler is required, it is allowed for in the cutting out the same as the bonnet.

When the cloth is thus properly cut, the different pieces are to be joined together in the form of a fail; and for doing this properly we have the following directions in the work already quoted. "Sails have a double flat seam, and should be sewed with the best English made twine of three threads, spun 360 fathoms to the pound, and have from one hundred and eight to one hundred and sixteen stitches in every yard in length. The twine for large fails, in the royal navy, is waxed.

Appendix.

by hand, with genuine bees wax, mixed with one sixth part of clear turpentine; and, for small sails, in a mixture made with bees wax, 4 lb. hogs head 5 lb. and clear turpentine 1 lb. In the merchant service, the twine is dipped in tar (1.), softened with a proper proportion of oil.

"It is the erroneous practice of some sailmakers not to sew the seams any farther than where the edge is creased down for the tabling; but all sails should be sewed quite home to the end, and, when finished, should be well rubbed down with a rubber. In the merchant service seams are sometimes made broader at the foot than at the head, being stronger. Broad seams are not allowed to be made on courses, in the royal navy, but goring leeches are adopted in lieu of them. Boom mainfalls and the falls of floops generally have the seams broader at the foot than at the head. The seams of courses and topfalls are fluck or flitched up, in the middle of the seams, along the whole length, with double seaming twine; and have from 68 to 72 flitches in a yard. In the merchant service it is common to flick the seams with two rows of flitches, when the sail is half worn, as they will then last till the sail is worn out.

"The breadth of the seams of courses, topfalls, and other falls, in the royal navy, to be as follows, viz. courses and topfalls, for 50 gun ships and upwards, one inch and a half, and for 44 gun ships and under, one inch and a quarter, at head and foot; all other falls, one inch at head and foot.

"The tablings of all sails are to be of a proportionable breadth to the size of the sail, and sewed at the edge, with 68 to 72 flitches in a yard. Those for the heads of main and fore courses to be four to six inches wide; for sprit courses and mizens, drivers, and other boom falls, 3 to 4 inches wide; for topfalls, 3 inches to 4 inches and a half; topgallant and sprit topfalls, 3 inches; royal falls, 2 inches and a half; jib and other stayfalls, 3 inches to 4 inches and a half, on the stay or hoist; and for studding falls, 3 inches to 4 inches on the head. Tablings on the foot and leeches of main and fore courses to be 3 inches to 5 inches broad; sprit course and topfalls, 3 inches; topgallant and sprit topfalls, 2 inches and a half; royals, 2 inches; fore leeches of mizen, driver, and other boomfalls, 3 inches and a half to 4 inches; after leech, 3 inches; and on the foot 2 or 3 inches. Tablings on the after leech of jibs and other stayfalls to be from 2 to 3 inches broad; and, on the foot, 2 to 2 inches and a half; on studding sail leeches one inch and a half to two inches and a half; and on the foot, from one to two inches.

"Main and fore courses are lined on the leeches, from clue to earing, with one cloth seamed on and fluck or flitched in the middle, and have a middle band half way between the lower reef band and the foot, also four buntline cloths, at equal distances between the leeches, the upper ends of which are carried under the middle band, that the lower side of the band may be tabled upon or sewed over the end of the buntline pieces. They have likewise two reef bands; each in breadth one third

of the breadth of the canvas; the upper one is one sixth of the depth of the sail from the head, and the lower band is at the same distance from the upper one; the ends go four inches under the leech linings, which are seamed over the reef bands. All linings are seamed on, and are fluck with 68 to 72 flitches in a yard.

"Main, fore, and mizen, topfalls have leech linings, mast and top linings, buntline cloths, middle bands and reef bands. The leech linings are made of one breadth of cloth, to cut and sewed as to be half a cloth broad at the head, and a cloth and a half broad at the foot; the piece cut out being half the breadth of the cloth at one end, and tapering to a point at the other. The middle bands are put on half way between the lower reef and foot, the buntline cloths join the top linings, and the buntline cloths and top linings are carried up to the lower side of the middle band, which is tabled on them. The mast lining is of two cloths, and extends from the foot of the sail to the lower reef, to receive the beat or chafe of the mast. The middle band is made of one breadth of canvas, of the same number as the top lining. It is first folded and rubbed down, to make a crease at one third of the breadth; then tabled on the selvage, and fluck along the crease; then turned down, and tabled and fluck through both the double and single parts, with 68 to 72 flitches in a yard. It is the opinion of many, that middle bands should not be put on until the sail is half worn.

"Main and fore topfalls have three and sometimes four reef bands from leech to leech, over the leech linings; the upper one is one eighth of the depth of the sail from the head, and they are the same distance asunder in the royal navy, but more in the merchant service. The reef bands are each of half a breadth of canvas put on double; the first side is fluck twice, and the last turned over, so that the reef holes may be worked upon the double part of the band, which is also fluck with 68 to 72 flitches in a yard.

"The top lining of topfalls is of canvas, N^o 6 or 7. The other linings of this, and all the linings of other sails, should be of the same quality as the sails to which they belong.

"Top linings and mast cloths are put on the aft side, and all other linings on the fore side, of sails. Mizens are lined with one breadth of cloth from the clue five yards up the leech, and have a reef band sewed on, in the same manner as on other sails, at one fifth the depth of the sail from the foot; they have also a neck-piece and a peek-piece, one cut out of the other, so that each contains one yard. Mizen topfalls of 50 gun ships and upwards have three reefs, the upper one is one eighth of the depth of the sail from the head, and the reefs are at the same distance asunder. Mizen topfalls of ships of 44 guns and under have two reefs one seventh part of the depth of the sail asunder, the upper one being at the same distance from the head. Main and main top studding sails have each one reef, at one eighth of the depth of the sail from the head. Reef bands should not be put on until the sail is sewed up, a contrary practice being very erroneous. Lower stayfalls,

Appendix.

(1.) The dipping of the twine in tar, we are persuaded, is a very bad practice, for the reason assigned in ROPE-BLANKING. See this article, N^o 32.

Fig. 1.

PIECES of the HULL.

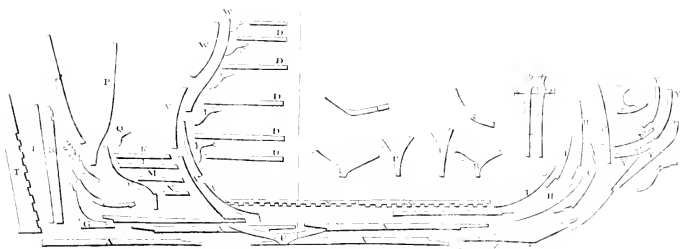
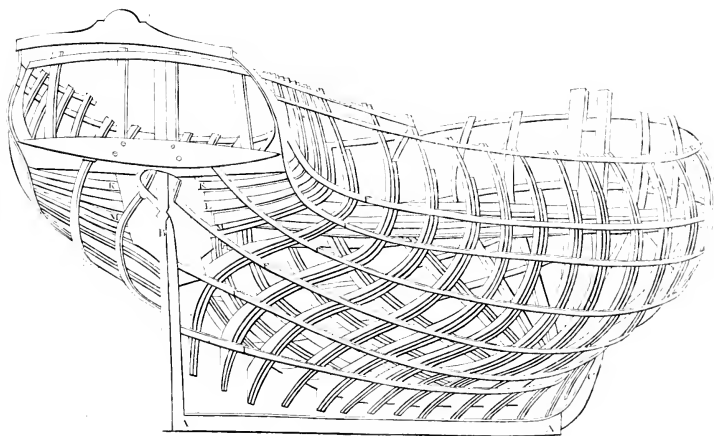

Fig. 2.

FRAME of a SHIP.



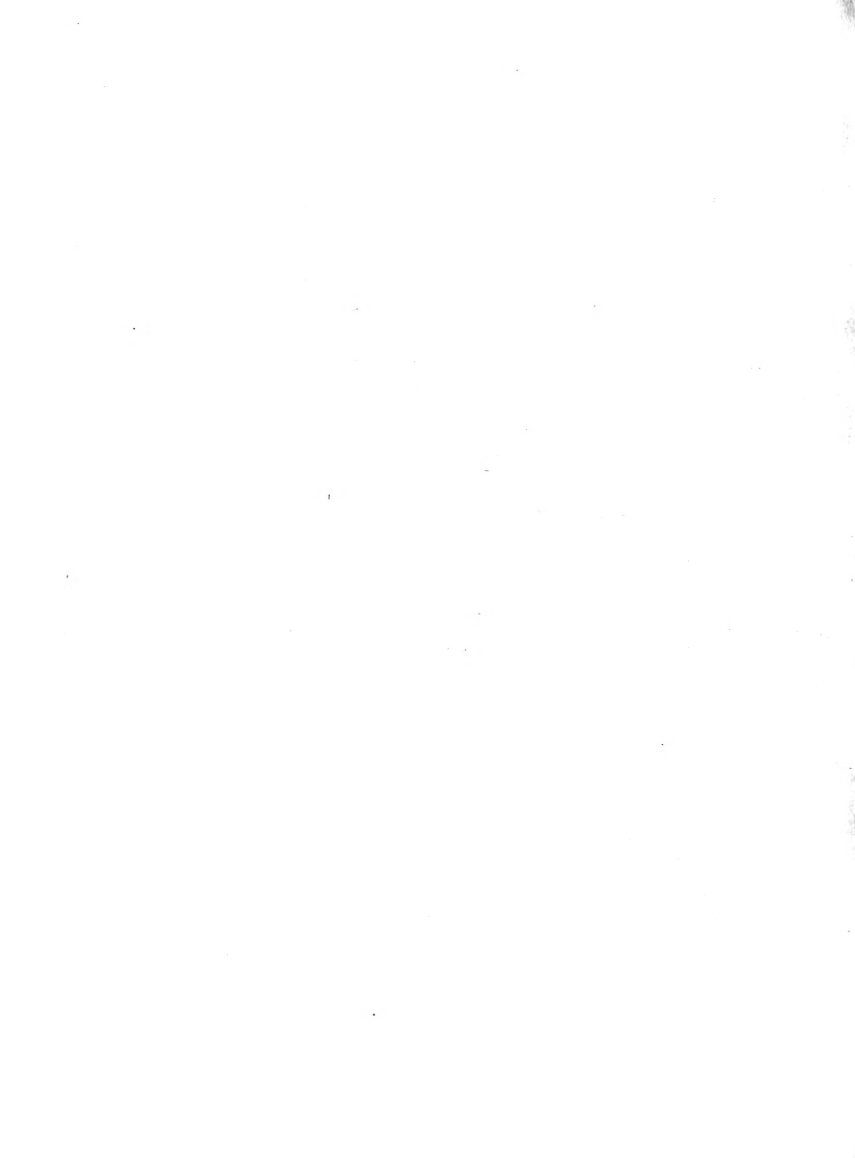

Fig. 3.

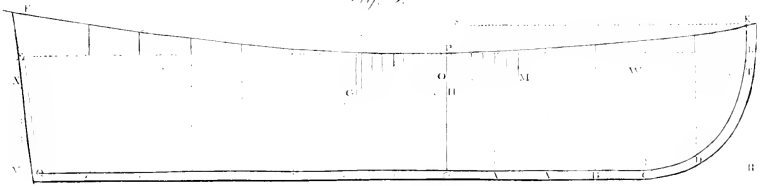

Fig. 4.

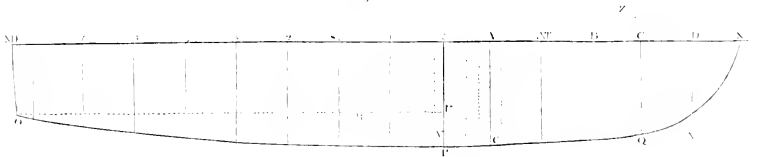

Fig. 5.

Fig. 6.

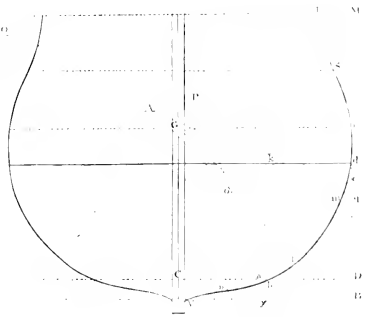
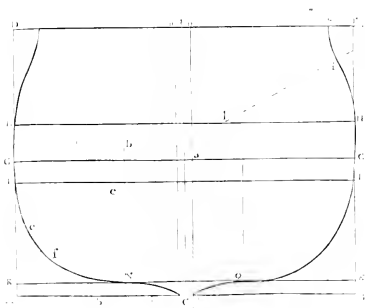



Fig. 9.

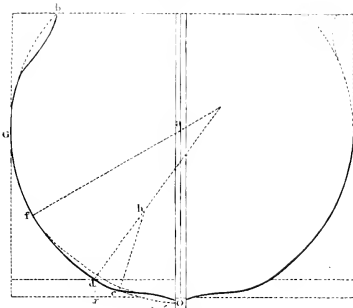

Fig. 9.

Fig. 10.

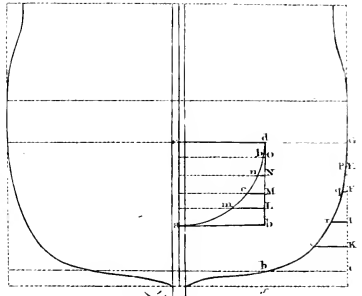

Fig. 10.

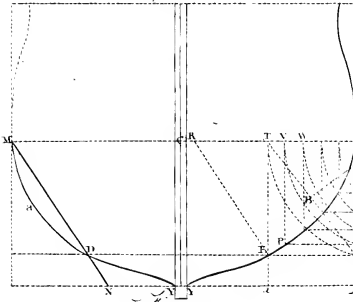

Fig. 11.

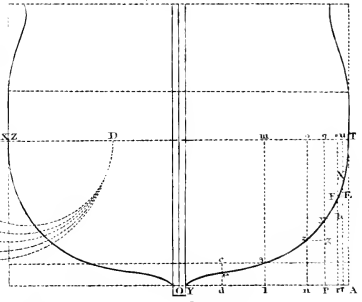

Fig. 12.

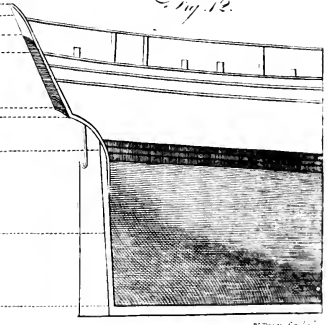
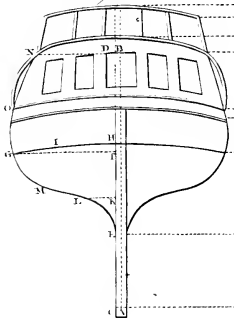



Fig. 17.

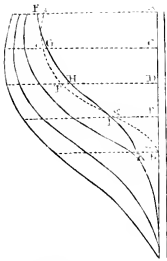

Fig. 18.

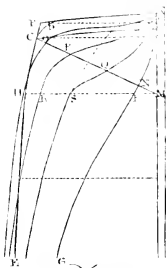

Fig. 19.

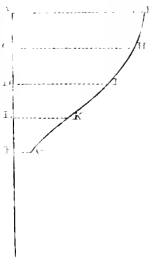

Fig. 20.

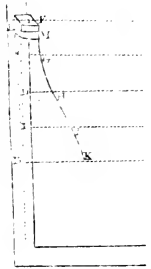

Fig. 21.

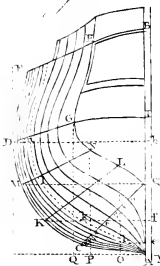

Fig. 22.

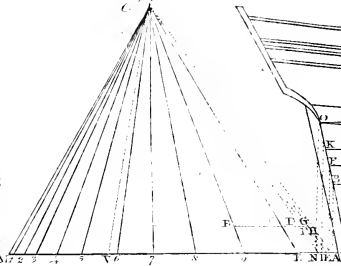

Fig. 23.

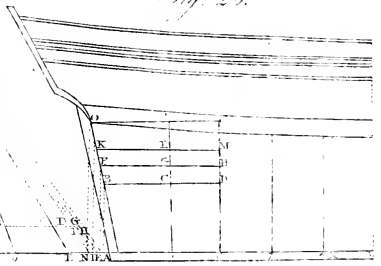

Fig. 24.

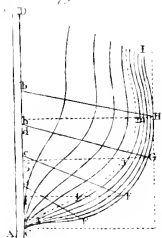

Fig. 25.

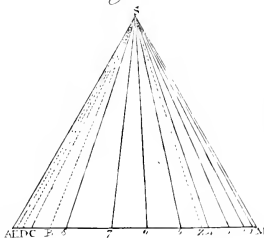

Fig. 26.

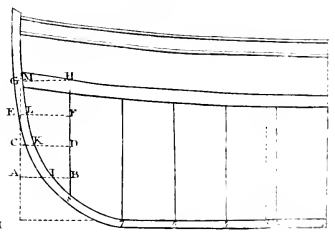





Fig. 35

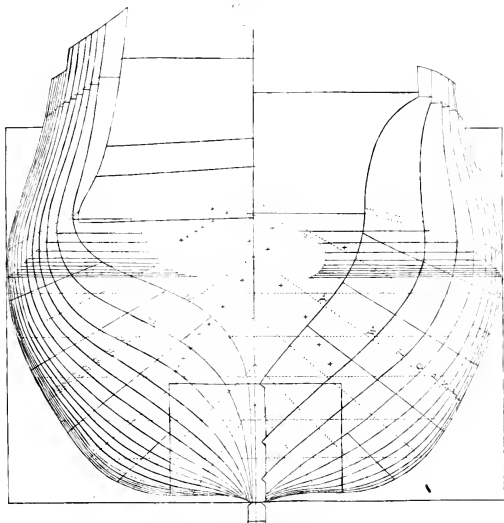
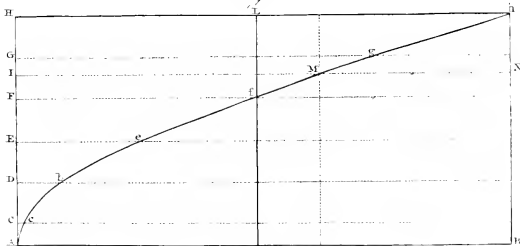

Fig. 36



K
Tons.

Feet.



Fig. 37.

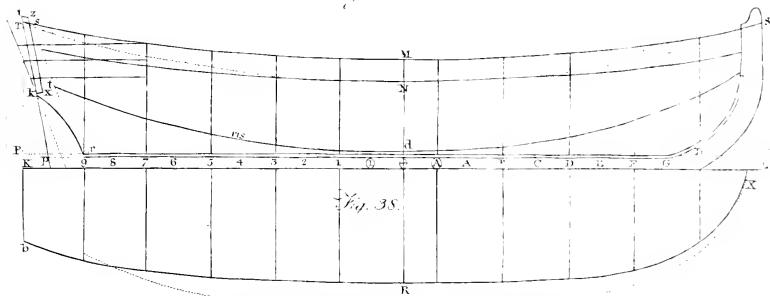

Fig. 38.

Fig. 39.

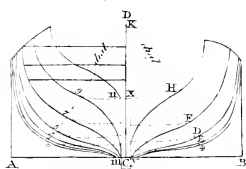

Fig. 40.

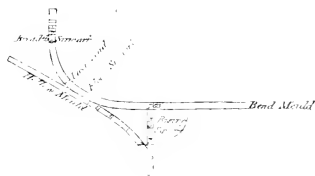

Fig. 41.

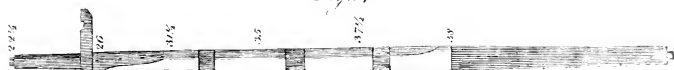

Fig. 42.



Fig. 43.





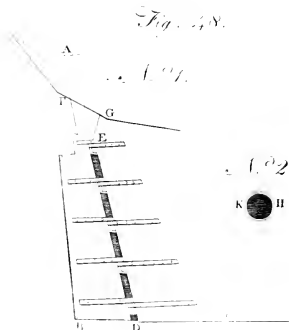
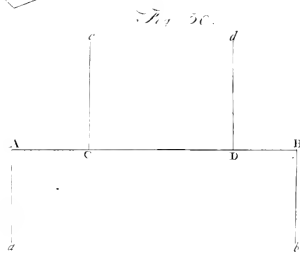
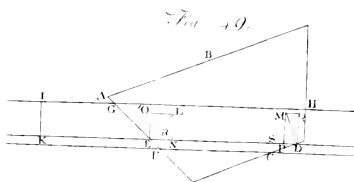
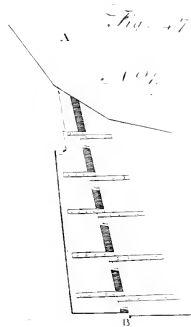
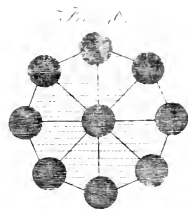
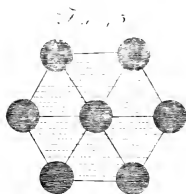
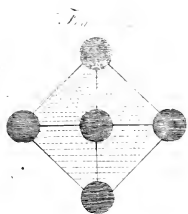

BOSWELL'S improved CAPSTAN.

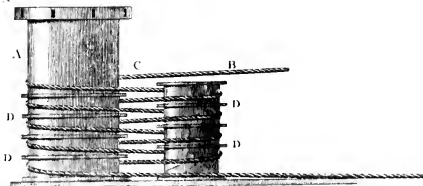

Fig. 31.

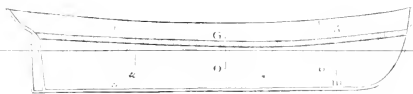

Fig. 32.

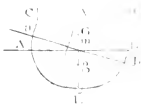

Fig. 33.

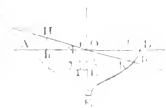

Fig. 34.

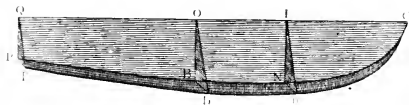

Fig. 35.

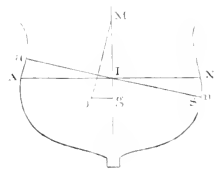

Fig. 36.

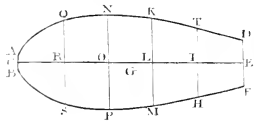

Fig. 37.

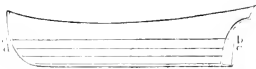

Fig. 38.



Fig. 39.





Appendix. Falls, fore top and main top stayfalls, and flying jibs, have clue-pieces two yards long. Square tick stayfalls have half a breadth of cloth at the fore part, with a clue-piece containing two yards, and a peck-piece, containing one yard.

"Sails have two holes in each cloth, at the heads and reefs of courses, topfalls, and other square sails; one hole in every yard in the stay of flying jibs, and one in every three quarters of a yard in the stays of square tack and other stayfalls. These are made by an instrument called a *pegging awl*, or a *stabber*, and are fenced round by stitching the edge to a small grommet, made with log or other line; when finished, they should be well stretched or rounded up by a prickler or a marine spike. Reef and head holes of large sails have grommets of twelve-thread line, worked round with 18 to 21 stitches; smaller sails have grommets of nine-thread line, with 16 to 18 stitches, or as many as shall cover the line, and smaller holes in proportion. The holes for marling the clues of sails and the top brims of topfalls have grommets of log-line, and should have from 9 to 11 stitches; twelve holes are worked in each cloth. Main courses have marling holes from the clue to the lower bow line cringle up the leech, and from the clue to the first buntline cringle on the foot. Fore courses have marling holes one eighth of the depth of the sail up the leech, and from the clue to the first buntline cringle at the foot. Main and fore topfalls have marling holes three feet each way from the clue and at the top-brims. Spritfalls, mizen topfalls, lower stayfalls, main and fore top stayfalls, and jibs, have marling holes two feet each way from the clues. All other falls are fewed home to the clues. Marling holes of courses are at three fourths of the depth of the tablings at the clues from the rope, and those of topfalls are at half the depth of the tablings at the clues and top brim from the rope."

The rope, which is fewed on the edges of sails to prevent their rending, and which is called *bolt-rope*, should be well made of fine yarn, spun from the best Riga rhine hemp well topt, and fewed on with good English made twine of three threads, spun 200 fathom to the pound; the twine in the royal navy is dipped in

a composition made with bees-wax, 4 lbs. logs lard 5 lbs. and clear turpentine one pound; and in the merchant service, is tar softened with oil. They should be flosed in a stove by the heat of a flue, and not in a baker's oven or a stove tub; and tarred in the best Stockholm tar. The flexibility of them should be always considered, in taking in the slack, which must rest on the judgment of the sailmaker.

"Bolt ropes of courses, topfalls, and all other falls, should be neatly fewed on through every buntline of the rope; and, to avoid stretching, the rope must be kept tightly twisted while fewing on, and care taken that neither too much nor too little slack is taken in; they are to be cross stitched at the leeches every twelve inches in length; at every seam, and in the middle of every cloth at the foot, with three cross-stitches: four cross-stitches should be taken at all beginnings and fastenings off; the first stitch given twice, and the last three times. Small sails have two cross stitches at every seam, and three at every fastening off.

"On main and fore courses two inches slack cloth should be allowed in the head and foot, and one inch and a half in the leeches, in every yard in length. Topfalls are allowed 3 inches slack in every cloth in the foot, one inch and a half in every yard in the leech, and two inches in every cloth left open in the top brim. Mizen courses have two inches slack in every yard in the foremoft leech, but none in the after leech or foot. Spritfall courses have no slack cloth. Jibs have four inches slack in every yard in the stay, one inch in every cloth in the foot, and none in the leech. Stayfalls have three inches slack in every yard in the stay, one inch in every cloth in the foot, but none in the leech. Topgallant sails have two inches slack in every cloth in the foot, and one inch in every yard in the leech. Studding galls have an inch and a half slack in every yard in going leeches, but no slack in square leeches, and one inch in every cloth in the head and foot."

These directions for sailmaking, we trust may be useful. They are indeed very general, but the sailmaker will find every instruction that he can want in the *Elements of Rigging and Seamanship*, a work which we therefore recommend to his attention.

S H I P

S H I P

Ship. *SHIP'S Form Gauge*, an instrument recommended by Mr Hutchinson as fit to ascertain any alteration in the bottom of a ship, by its hogging or sagging; and also to regulate the stowage of a ship.

"All ships (says he) of any consequence are built with staunchions fixed from the keelson to the middle of all the lower-deck beams fore and aft, in order to support them in their exact, regular height, as well as the whole frame of the ship in the regular form in which she was built upon the stocks; yet notwithstanding these staunchions, it is proved from experience that our ships bottoms, hitherto, by the pressure of water, and improper stowage, have generally been hogged upwards, or sagged downwards, and most about the midship frame or main body of the ship, which is commonly about the fore part of the main hatchway; which naturally makes

it the best place at which to fix the ship's form gauge, where either the hogging or sagging of her bottom may be observed and seen soonest and best, to regulate the stowage of heavy materials to the greatest advantage, so as to keep her bottom nearly in the same form in which she was built.

"The gauge I recommend is nothing more than a narrow plate of iron divided into inches and quarters like the slide of a carpenter's rule. Let this be fixed to the after side of the staunchion now mentioned, with its upper end projecting two or three inches above the staunchion; a groove being cut out for it in the after side of the lower-deck beam, and a mark being made (when the ship is on the stocks) at the part of the beam which corresponds to the 0 on the gauge. When the ship sits in her shape, the gauge will slide up and

Ship. down in this groove, and the quantity of hogging or sagging will be pointed out on the gauge by the mark on the beam. The stowage may then be so managed as to bring this mark to coincide again with the 0, or to approach it as near as we see necessary."

SHIP-Money, was an imposition charged upon the ports, towns, cities, boroughs, and counties of this realm, in the reign of King Charles I. by writs, commonly called *ship-writs*, under the great seal of England, in the years 1635 and 1636, for the providing and furnishing of certain ships for the king's service, &c. which was declared to be contrary to the laws and statutes of this realm, the *petition of right* and liberty of the subject, by stat. 17 Car. I. c. 14. See *Blackstone's Commentaries*, vol. iv. p. 30.

SHIP-Shape, according to the fashion of a ship, or in the manner of an expert sailor; as, The masts are not rigged ship-shape; Trim your sails ship-shape.

Stowing and Trimming of SHIPS, the method of disposing of the cargo in a proper and judicious manner in the hold of a ship.

A ship's sailing, steering, staying, and wearing, and being lively and comparatively easy at sea in a storm, depends greatly on the cargo, ballast, or other materials, being properly stowed, according to their weight and bulk, and the proportional dimensions of the built of the ship, which may be made too crank or too stiff to pass on the ocean with safety. These things render this branch of knowledge of such consequence, that rules for it ought to be endeavoured after, if but to prevent, as much as possible, the danger of a ship oversteering at sea, or being so laboursome as to roll away her masts, &c. by being improperly stowed, which is often the case.

When a ship is new, it is prudent to consult the builder, who may be supposed best acquainted with a ship of his own planning, and most likely to judge what her properties will be, to advise how the cargo or materials, according to the nature of them, ought to be disposed of to advantage, so as to put her in the best sailing trim; and at every favourable opportunity afterwards it will be proper to endeavour to find out her best trim by experiment.

Ships must differ in their form and proportional dimensions; and to make them answer their different purposes, they will require different management in the stowage, which ought not to be left to mere chance, or done at random, as goods or materials happen to come to hand, which is too often the cause that such improper stowage makes ships unfit for sea: therefore the stowage should be considered, planned, and contrived, according to the built and properties of the ship, which if they are not known should be inquired after. If she is narrow and high built in proportion, so that she will not float herself without a great weight in the hold, it is a certain sign such a ship will require a great part of heavy goods, ballast, or materials, laid low in the hold, to make her stiff enough to bear sufficient soil without being in danger of oversteering. But if a ship be built broad and low in proportion, so that she is stiff and will support herself without any weight in the hold, such a ship will require heavy goods, ballast, or materials, stowed higher up, to prevent her from being too stiff and laboursome at sea, so as to endanger her masts being

rolled away, and the hull worked loose and made leaky. *Ship.*

In order to help a ship's sailing, that she should be lively and easy in her pitching and ascending motions, it should be contrived by the stowage, that the principal and weightiest part of the cargo or materials should lie as near the main body of the ship, and as far from the extreme ends, fore and aft, as things will admit of. For it should be considered, that the roomy part of our ships lengthwise forms a sweep or curve near four times as long as they are broad; therefore those roomy parts at and above the water's edge, which are made by a full harping and a broad transom to support the ship steady and keep her from plunging into the sea, and also by the entrance and run of the ship having little or no bearing body under for the pressure of the water to support them, of course should not be stowed with heavy goods or materials, but all the necessary vacancies, broken stowage, or light goods, should be at these extreme ends fore and aft; and in proportion as they are kept lighter by the stowage, the ship will be more lively to fall and rise easy in great seas; and this will contribute greatly to her working and sailing, and to prevent her from straining and hogging; for which reason it is a wrong practice to leave such a large vacancy in the main hatchway, as is usual, to coil and work the cables, which ought to be in the fore or after hatchway, that the principal weight may be more easily stowed in the main body of the ship, above the flattest and lowest floorings, where the pressure of the water acts the more to support it.

Improved Capstan of SHIPS.—A capstan has been contrived by Mr Botwell, which works without requiring the messenger or cable coiled around it, to be ever furged; an operation which is necessary with common capstans, and is always attended with delay, and frequently with danger. This capstan has been approved by some gentlemen connected with the British navy. A model of this machine was presented to the Society for the Encouragement of Arts, and Mr Botwell received the gold medal of the society for his invention.

For the information of those unacquainted with maritime affairs, Mr Botwell gives an account of the manner in which cables are hauled on board of large ships. For the purpose of shewing the advantage of his improved capstan, cables, he observes, above a certain diameter are too inflexible to admit of being coiled round a capstan: in ships where cables of such large dimensions are necessary, a smaller cable is employed for this purpose, which is called the *messenger*, the two ends of which are made fast together so as to form an endless rope, which, as the capstan is turned about, rolls round it in unceasing succession, passing on its course to the head of the ship, and again returning to the capstan. To this returning part of the messenger, the great cable is made fast by a number of small ropes called nippers, placed at regular intervals; these nippers are applied, as the cable enters the hawse hole, and are again removed as it approaches the capstan, after which it is lowered into the cable tier.

The messenger, or any other rope coiled round the capstan, must describe a space at every revolution equal to the diameter of the rope or cable used; this circum-

* *Transf. for*
1807. *Phil.*
Mag. xxxii.
267.

stance brings the coils in a few turns to the bottom of the capitan, when it can no longer be turned round, till the coils are loosened and raised up to its other extremity, after which the motion proceeds as before. This operation of shifting the place of the coils of the messenger on the capitan is called *furling the messenger*. It always causes considerable delay; and when the messenger chances to slip in changing its position, which sometimes happens, no small danger is incurred by those who are employed about the capitan.

One method of preventing the necessity of furling, by placing a horizontal roller beneath the messenger when it first enters on the capitan, adds considerably to the labour in turning the capitan, and the great friction which the messenger must suffer, must occasion a very great wear and injury to the messenger.

Another method to prevent furling was, that for which Mr Plucknet obtained a patent. In this way a number of upright lifters, placed round the capitan, were made to rise in succession as the capitan turned round by a circular inclined plane placed beneath them; a method Mr Boswell thinks superior to the former; but still the wear of the messenger from the lateral friction in rising against the whelps of the capitan remains undiminished.

A third method proposed by Captain Hamilton, left the lateral friction, and wear of the messenger against the whelps of the capitan, as great as in the others, having also the inconvenience of causing the coils to become loose as they ascend, the upper part of the barrel being nearly one third less in the diameter than the lower part.

In Mr Boswell's method of preventing the necessity of furling, none of the lateral friction of the messenger or cable against the whelps of the capitan, can possibly take place, and of course the wear of the messenger occasioned thereby will be entirely avoided, while it performs its purpose with a less moving power than any of them.

His method consists in the simple addition of a second smaller barrel or capitan of less dimensions to the large one; beside which it is to be placed in a similar manner, and which need not in general exceed the size of a half barrel cask. The coils of the messenger are to be passed alternately round the large capitan and this small barrel, but with their direction reversed in the different barrels, so that they may cross each other in the intervals between the barrels, in order to have the more extensive contact with, and better gripe on each barrel. To keep the coils distinct, and prevent their touching each other in passing from one barrel to the other, projecting rings are fastened round each barrel at a distance from each other equal to about two diameters of the messenger, and the thickness of the ring. Those rings should be so fixed on the two barrels that those on one barrel should be exactly opposite the middle of the intervals between those on the other barrel; the only circumstance which requires particular attention in the construction of this capitan. The rings should project about as much as the messenger from the barrels, which may be formed with whelps, and in every other respect, not before mentioned, in the usual manner for capitan barrels. The small barrel should be furnished with falling palls as well as the large one; a fixed iron spindle ascending from the deck will be the best for it, as it

will take up less room. The spindle may be secured below the deck, so as to bear any strain, as the small barrel need not be much above half the height of the large barrel; the capitan bars can easily pass over it in heaving round, when it is thought fit to use capitan bars on the same deck with the small barrel. As two turns of the messenger round both barrels will be at least equivalent to three turns round the common capitan, it will scarcely ever be necessary to use more than four turns round the two barrels.

That which prevents the lateral friction of the messenger in Mr Boswell's double capitan is, that in it each coil is kept distinct from the rest, and must pass on to the second barrel before it can gain the next elevation on the first, by which no one coil can have any influence in raising or depressing another; and what each separate coil defends in a single revolution it regains as much as is necessary in its passage between the barrels when in the air, and free from all contact with any part of the apparatus, it attains a higher elevation without a possibility of friction or wear.

It is equally applicable in large and in smaller vessels, in the former of which messengers are necessary, from the size of the cables; but in the latter also, where cables can be managed with the same ease as messengers. The same principle may be also easily applied to windlasses by having a small horizontal barrel placed parallel to the body of the windlass, and having both fitted with rings in the same way as is proposed for the capitan. The place for the small horizontal barrel is forward, just before the windlass, and it should also be furnished with catch palls.

Besides the advantages now stated, the improved capitan is simple in its construction can be fitted up at small expence, is easily repaired, and requires but little room.

A represents the common capitan; B, another of smaller dimensions; C the coils of the messenger passing alternately round the large and small capitans, but with the direction reversed on the different barrels, so that they may cross each other in the interval between them; DDDD, are projecting rings round each barrel, fixed on the two barrels, that those on one barrel should be exactly opposite the middle of the intervals between those on the other barrel.

Machine for measuring a SHIP'S Way.—We have already described a variety of machines or instruments which have been proposed for this purpose under the article LOG. In this place, therefore, we shall confine ourselves to the machine invented by Francis Hopkinson, Esq. Judge of the Admiralty in Pennsylvania. After having shown the fallacies to which the common log, and also that particular kind of instrument invented by M. Saumarez, are liable, he proceeds to describe his own machine as follows:

This machine, in its most simple form, is represented by fig. 5. wherein AB is a strong rod of iron moveable on the fulcrum C. D is a thin circular palate of brass rivetted to the lower extremity of the rod. E a horizontal arm connected at one end with the top of the rod AB by a moveable joint F, and at the other end with the bottom of the index H, by a like moveable joint G. H is the index turning on its centre I, and travelling over the graduated arch K; and L is a strong spring, bearing against the rod AB, and constantly counteracting the pressure upon the palate D.

Ship.

Plate
CCCXXXII.Transac-
tions of the
American
Philosophical
Society,
vol. 4. p.
160.Plate
CCCXXXII.
Fig. 5.

Ship

The rod AB should be applied close to the cut-water or stem, and should be of such a length that the palate D may be no higher above the keel than is necessary to secure it from injury when the vessel is aground, or fails in shoal water. As the bow of the ship curves inward towards the keel M, the palate D will be thrown to a distance from the bottom of the vessel, although the perpendicular rod to which it is annexed lies close to the bow above; and therefore the palate will be more fairly met upon. The arm E should enter the bow somewhere near the hawse hole, and lead to any convenient place in the forecable, where a smooth board or plate may be fixed, having the index H, and graduated arch K, upon it.

It is evident from the figure, that as the ship is urged forward by the wind, the palate D will be pressed upon by the resisting medium, with a greater or less force, according to the progressive motion of the ship; and this will operate upon the levers so as to immediately affect the index, making the less increase or diminution of the ship's way visible on the graduated arch; the spring L always counteracting the pressure upon the palate, and bringing back the index, on any relaxation of the force impressed.

This machine is advantageously placed at the bow of the ship, where the current first begins, and acts fairly upon the palate, in preference to the stern, where the tumultuous closing of the water causes a wake, visible to a great distance. The palate D is sunk nearly as low as the keel, that it may not be influenced by the heaping up of the water and the dashing of the waves at and near the water line. The arch K is to ascertain how many knots or miles the would run in one hour at her then rate of sailing. But the graduations on this arch must be unequal; because the resistance of the spring L will increase as it becomes more bent, so that the index will travel over a greater space from one to five miles than from five to twelve. Lastly, The palate, rod, spring, and all the metallic parts of the instrument, should be covered with a strong varnish, to prevent rust from the corrosive quality of the salt water and sea air.

This machine may be considerably improved as follows: Let the rod or spear AB (fig. 5.) be a round rod of iron or steel, and instead of moving on the fulcrum or joint, as at C, let it pass through and turn freely in a socket, to which socket the moveable joint must be annexed, as represented in fig. 6. The rod must have a shoulder to bear on the upper edge of the socket, to prevent its slipping quite down. The rod must also pass through a like socket at F, fig. 5. The joint of the lower socket must be fixed to the bow of the ship, and the upper joint or socket must be connected with the horizontal arm E. On the top of the uppermost socket let there be a small circular plate, bearing the 32 points of the mariner's compass; and let the top of the rod AB come through the centre of this plate, so as to carry a small index upon it, as is represented in fig. 7. This small index must be fixed to the top of the rod on a square, so that by turning the index round the plate, the rod may also turn in the sockets, and of course carry the palate D round with it; the little index always pointing in a direction with the face of the palate. The small compass plate should not be fastened to the top of the socket, but only fitted tightly on, that it may be moveable at pleasure. Sup-

pose then the intended port to bear S. W. from the place of departure, the plate must be turned on the socket till the fourth-west point thereon looks directly to the ship's bow; so that the fourth-west and north-east line on the compass plate may be precisely parallel with the ship's keel, and in this position the plate must remain during the whole voyage. Suppose, then, the ship to be sailing in the direct course of her intended voyage, with her bowprit pointing fourth-west. Let the little index be brought to the fourth-west point on the compass plate, and the palate D will necessarily present its broad face toward the port of destination; and this it must always be made to do, be the ship's course what it may. If, on account of unfavourable winds, the ship is obliged to deviate from her intended course, the little index must be moved so many points from the fourth-west line of the compass plate as the compass in the binnacle shall show that she deviates from her true course; so that in whatever direction the ship shall sail, the palate D will always look full to the fourth-west point of the horizon, or towards the port of destination, and consequently will present only an oblique surface to the resisting medium, more or less oblique as the ship deviates more or less from the true course of her voyage. As, therefore, the resistance of the water will operate less upon the palate in an oblique than in a direct position, in exact proportion to its obliquity, the index H will not show how many knots the vessel runs in her then course, but will indicate how many the gains in the direct line of her intended voyage.

Thus, in fig. 9. if the ship's course lies in the direction of the line AB, but the can fail by the wind no nearer than AC; suppose, then, her progressive-motion such as to perform AC equal to five knots or miles in an hour, yet the index H will only point to four knots on the graduated arch, because she gains no more than at that rate on the true line of her voyage, viz. from A to B. Thus will the difference between her real motion and that pointed out by the index be always in proportion to her deviation from her intended port, until she fails in a line at right angles therewith, as AD; in which case the palate would present only a thin sharp edge to the resisting medium, the pressure of which should not be sufficient to overcome the friction of the machine and the bearing of the spring L. So that at whatever rate the ship may fail on that line, yet the index will not be affected, showing that she gains nothing on her true course. In this case, and also when the vessel is not under way, the action of the spring L should cause the index to point at O, as represented by the dotted lines in fig. 5, and 8.

As the truth of this instrument must depend on the equal pressure of the resisting medium upon the palate D, according to the ship's velocity, and the proportionable action of the spring L, there should be a pin or screw at the joints C and F, so that the rod may be readily unshipped and taken in, in order to clean the palate from any foulness it may contract, which would greatly increase its operation on the index H, and thereby render the graduated arch false and uncertain.

Further, the spring L may be exposed too much to injury from the salt water, if fixed on the outside of the ship's bow. To remedy this, it may be brought under cover, by constructing the machine as represented by fig. 8. where AB is the rod, C the fulcrum or centre

Ship

Ship of its motion, D the palate, E the horizontal arm leading through a small hole into the forecable; M is a strong chain fastened at one end to the arm E, and at the other to a rim or barrel on the wheel G, which by means of its teeth gives motion to the femicircle I and index H. The spring L is spiral, and enclosed in a box or barrel, like the main-spring of a watch. A small chain is fixed to, and passing round the barrel, is fastened by the other end to the fuzee W. This fuzee is connected by its teeth with the wheel G, and counteracts the motion of the palate D. N, N, are the two sockets through which the rod AB passes, and in which it is turned round by means of the little index R. S is the small compass plate, moveable on the top of the upper socket N. The plate S hath an upright rim round its edge, cut into teeth or notches, so that when the index R is a little raised up, in order to bring it round to any intended point, it may fall into one of these notches, and be detained there; otherwise the pressure of the water will force the palate D from its oblique position, and turn the rod and index round to the direction in which the ship shall be then sailing.—Should it be apprehended that the palate D, being placed so far forward, may affect the ship's steerage, or obstruct her rate of sailing, it should be considered that a very small plate will be sufficient to work the machine, as one of three or four inches in diameter would probably be sufficient, and yet not large enough to have any sensible effect on the helm or ship's way.

The greatest difficulty, perhaps, will be in graduating the arch K, (if the machine is constructed as in fig. 5.); the unequal divisions of which can only be ascertained by actual experiment on board of each ship respectively, inasmuch as the accuracy of these graduations will depend on three circumstances, viz. the position of the fulcrum C with respect to the length of the rod, the size of the palate D, and the strength or bearing of the spring L. When these graduations, however, are once ascertained for the machine on board of any one vessel, they will not want any future alterations, provided the palate D be kept clean, and the spring L retains its elasticity.

But the unequal divisions of the graduated arch will be unnecessary, if the machine is constructed as in fig. 8; for as the chain goes round the barrel L, and then winds through the spiral channel of the fuzee W, the force of the main spring must operate equally, or nearly so, in all positions of the index, and consequently the divisions of the arch K may in such case be equal.

After all, it is not expected that a ship's longitude can be determined to a mathematical certainty by this instrument. The irregular motions and impulses to which a ship is continually exposed, make such an accuracy unattainable perhaps by any machinery: But if it should be found, as we flatter ourselves it will on fair experiment, that it answers the purpose much better than the common log, it may be considered as an acquisition to the art of navigation.

It should be observed, that in ascertaining a ship's longitude by a time-piece, this great inconvenience occurs, that a small and trifling mistake in the time makes a very great and dangerous error in the distance run: Whereas the errors of this machine will operate no farther than their real amount; which can never be great

or dangerous, if corrected by the usual observations made by mariners for correcting the common log.

A like machine, made in its simple form (as at fig. 5.), so constructed as to ship and unship, might occasionally be applied alongside about midships, in order to ascertain the leeway; which, if rightly shown, will give the ship's precise longitude. As to sea currents, this and all other machines hitherto invented must be subject to their influence; and proper allowances must be made according to the skill and knowledge of the navigator.

Lastly, Some discretion will be necessary in taking observations from the machine to be entered on the log-book: that is, the most favourable and equitable moment should be chosen for the observation; not whilst the ship is rapidly descending the declivity of a wave, or is suddenly checked by a stroke of the sea, or is in the very act of plunging. In all cases, periods may be found in which a ship proceeds with a true average velocity; to discover which, a little experience and attention will lead the skilful mariner.

It has been observed of the machine now described, that an ingenious mechanic would probably construct it to better advantage in many respects. The author only meant to suggest the principle; experiment alone can point out the best method of applying it. He is sensible of at least one deficiency, viz. that the little index R, fig. 4. will not be strong enough to retain the palate D in an oblique position when the ship is sailing by the wind; more especially as the compass plate S, in whose notched rim the index R is to fall, is not fixed to, but only fitted tight on the socket N. Many means, however, might be contrived to remedy this inconvenience.

SHIPWRECK. A French author has lately proposed some methods of saving the lives of persons shipwrecked near the coast. He observes, that the most proper means for saving the crews of shipwrecked vessels is, to establish a rope of communication from them to the shore. To a bomb or cannon ball should be fastened the end of a rope, extended afterwards in a zig-zag direction before the mortar or cannon, or suspended on a piece of wood raised several feet. But as it was necessary to know if the cord would not break by the force of the explosion and the velocity of the motion, the author thought it proper to consult professional men. He accordingly wrote to some officers of the artillery in garrison at La Ferre in France, and they almost all replied that the rope would infallibly break.

Not deeming this answer satisfactory, he happily conceived the idea of making the experiment on a small scale. He caused a piece of the barrel of a musket to be filed into the form of a small mortar of 15 lines in length internally; and having tied a packthread to a common ball of lead, he made an experiment which perfectly succeeded, as did many others which he afterwards repeated, even with the strongest charges of powder. This success he communicated to the officers of artillery, who replied, that there was a great difference between a quarter of an ounce of powder and four or five pounds employed for a bomb; and were still of opinion that the rope would break.

Having already made experiments, he was still disposed to doubt the truth of this assertion, and therefore tried a four-inch mortar with a ball of the same calibre, and 18 ounces of powder, with a rope only three or

Ship
||
Shire

four lines in diameter, and his success was equally flattering as before. These experiments were repeated by order of government at La Fere, four times with an eight-inch mortar, and three times with one of twelve inches, all of which happily succeeded. The same author goes on to observe;

"It ought to be remembered, that a vessel is never cast away, or perishes on the coast, but because it is driven thither against the will of the captain, and by the violence of the waves and the wind, which almost always blows from the sea towards the shore, without which there would be no danger to be apprehended: consequently in these circumstances, the wind comes always from the sea, either directly or obliquely, and blows towards the shore.

"1st, A common paper kite, therefore, launched from the vessel and driven by the wind to the shore, would be sufficient to save a crew of 1500 seamen, if such were the number of a ship of war. This kite would convey to the shore a strong packthread, to the end of which might be affixed a cord, to be drawn on board by means of the string of the kite; and with this cord a rope, or as many as should be necessary, might be conveyed to the ship.

"2d, A small balloon, of six or seven feet in diameter, and raised by rarefied air, would be also an excellent means for the like purpose. Being driven by the wind from the vessel to the shore, it would carry thither a string capable of drawing a cord with which several ropes might be afterwards conveyed to the vessel. Had not the discovery of Montgolfier produced any other benefit, it would be entitled on this account to be considered as of great importance.

"3dly, A sky rocket, of a large diameter, would be of equal service. It would also carry, from the vessel to the shore, a string capable of drawing a rope after it.

"4thly, A fourth plan for saving the crew of a shipwrecked vessel, is that of throwing from the vessel into the sea an empty cask with a cord attached to it. The wind and the waves would drive the cask to the shore, and afford the means of establishing that rope of communication already mentioned."

The author just quoted says, that he announced his discovery in a French journal in January 1794. It is, however, to be observed, that the method he proposes of conveying a rope to the shore, by fastening it to a bullet or bomb, to be afterwards fired from a cannon or mortar, was proposed some years ago by a serjeant or officer of artillery at Woolwich, and it is said, similar experiments were made at Portsmouth, and succeeded *.

SHURAUZ. See SCHIRAS.

SHIRE is a Saxon word signifying a division; but a county, *comitatus*, of the same import, is plainly derived from *come*, "the count of the Franks;" that is, the earl or alderman (as the Saxons called him) of the shire, to whom the government of it was entrusted. This he usually exercised by his deputy, still called in Latin *vices-comes*, and in English the *sheriff*, *shireve*, or *shire-reeve*, signifying the "officer of the shire;" upon whom, in process of time, the civil administration of it totally devolved. In some counties there is an intermediate division between the shire and the hundred; as lathes in Kent and ropes in Suffex, each of them containing about three or four hundred a-piece. These had formerly their lath-reeves and rope-reeves, acting in subordina-

Shire
||
Shoat.

tion to the shire-reeve. Where a county is divided into three of these intermediate jurisdictions, they are called *trithings*, which were anciently governed by a trithing reeve. These trithings still subsist in the large county of York, where, by an easy corruption, they are denominated *ridings*; the north, the east, and the west ridings. SHILL, SHORL, or COCKLE, a species of mineral. See MINERALOGY Index.

SHIRT, a loose garment, commonly of linen, worn next the body.—Some doubt the propriety of changing the linen when a person is sick. Clean linen promotes perspiration; and it may be renewed as often as the patient pleases, whether the disorder be of the acute or the chronic kind. Except during a crisis in fevers, whilst the patient is in a sweat, a change of linen, if well dried and warmed, may be daily used.

Shirts were not worn by the Jews, Greeks, or Romans, but their place was supplied by thin *tunicæ* of wool. The want of linen among the ancients made frequent washings and abutions necessary.

SHIVER, a name given by miners to some of the strata which accompany coal. See SCHISTUS, MINERALOGY Index.

SHIVERS, in the sea language, names given to the little rollers, or round wheels of pulleys.

SHOAD, among miners, denotes a train of metal-line stones, serving to direct them in the discovery of mines.

SHOAD-Stones, a term used by the miners of Cornwall and other parts of this kingdom, to express such loose masses of stone as are usually found about the entrances into mines, sometimes running in a straight course from the load or vein of ore to the surface of the earth.

These are stones of the common kinds, appearing to have been pieces broken from the strata or larger masses; but they usually contain mundic, or marcasitic matter, and more or less of the ore to be found in the mine. They appear to have been at some time rolled about in water, their corners being broken off, and their surface smoothed and rounded.

The antimony mines in Cornwall are always easily discovered by the shoad-stones, these usually lying up to the surface, or very nearly so; and the matter of the stone being a white spar, or debased crystal, in which the native colour of the ore, which is a shining bluish black, easily discovers itself in streaks and threads.

Shoad-stones are of so many kinds, and of such various appearances, that it is not easy to describe or know them; but the miners, to whom they are of the greatest use in the tracing or searching after new mines, distinguish them from other stones by their weight; for if very ponderous, though they look ever so much like common stones, there is great reason to suspect that they contain some metal. Another mark of them is their being spongy and porous; this is a sign of especial use in the tin countries; for the tin shoad-stones are often so porous and spongy, that they resemble large bodies thoroughly calcined. There are many other appearances of tin shoads, the very hardest and firmest upon often containing this metal.

When the miners, in tracing a shoad up hill, meet with such odd stones and carths that they know not well what to make of them, they have recourse to washing, that is, they calcine and powder the stone, clay, or whatever else is supposed to contain the metal; and then

^{Shoemak}
broad triangular piece of plank, whose area or superficies is much larger than that of the flukes. It is intended to give the shoemaker a stronger and surer hold of the bottom in very hot and oozy ground.

SHOEMAKERS MACHINE for working at in a standing posture. A machine for this purpose was invented by Mr Thomas Parker, who, on the 22d of November, 1804, attended a committee appointed by the Society of Arts, and informed them that he had made use of this apparatus for twelve months, and found it very useful. He observed that all the work of shoe-making may be done with it standing; but that in some parts thereof he found an advantage in using along with it a high stool; and that prior to the use of this machine, he never saw or heard of a similar invention; and that he found it of great service to his health.

He estimated the cost of such a machine at two guineas.

^{Plate}
^{CCCXCVI}
^{Fig. 1.} Plate CCCXCVI. fig. 1. T, a bench standing on four legs, about four feet from the ground.

V, A circular cushion affixed to the bench, in the centre of which cushion is an open space quite through the bench, through which hole a leather strap U is brought up from below. This strap holds the work and last firm upon the cushion in any position required, by means of the workman's foot placed upon the treadle W.

X, Shows the last upon the cushion, with the strap holding it firm.

Y, An implement used in closing boots.

Z, A small flat leather cushion, useful in adjusting the last and strap.

L, The shoe-last shown separate from the cushion. The round cushion is formed of a circular piece of wood, covered with leather or stuffed with wool or hair to give it some elasticity.

Another machine for the same purpose has been invented by Mr Holden of Fettesworth in Suffex, and the following account of it was presented to the Society of Arts. He observes that the sitting posture had so greatly injured his health, as to render it necessary to give up his business, and in this difficulty he invented the machine which he found to answer the purpose fully, as it enabled him to resume his work with the recovery of his health. He recommends it as the quickest way of closing all the thread work, and he adds, that he has made 1800 or 2000 pairs of shoes with the machine, and still continues to employ it. The following is a description of the machine.

^{Fig. 2.} Fig. 2. A, The bed for the closing block, and to lay the shoe in, whilst flogging.

B, The closing block.

C, A loose bed to lay the shoe in whilst stitching; the lower part of which is here exhibited reversed, to show how it is placed in the other bed A.

D, The hollow or upper part of the loose bed C, in which the shoe is laid while stitching.

E, A table on which the tools wanted are to be laid.

F, An iron semi-circle, fixed to each end of the bed A, to allow the bed to be raised or depressed. This half circle moves in the block G.

H, Another iron semi-circle, with notches, which catch upon a tooth in the centre of the block, to hold the bed in any angle required. This semi-circle moves sidewise on two hooks in flukes at each end of the bed.

I, The tail or stem of the bed A, moving in a cylin-

dricul hole in the pillar, enabling the bed to be turned in any required direction, and which, with the movement F, enables the operator to place the shoe in any position necessary.

K, The pillar, formed like the pillar of a clawtable, excepting the two side legs being in a direct line, and the other leg at a right angle with them.

L, The semi-circle H, shewn separately, to explain how it is connected with the flukes, and how the notches are formed.

M, The tail or stem of the bed A, and the lower part of the bed N, shewn separately, to explain how the upper part of the bed is raised or depressed occasionally.

^{Horse-SHOE.} See FARRIERY, N^o 131.

SHOOTING, in the military art. See ARTILLERY, GUNNERY, and PROJECTILES.

SHOOTING, in Sportmanship, the killing of game by the gun, with or without the help of dogs.

Under this article we shall lay down all the rules which are necessary to be observed in order to render one accomplished and successful in the art of shooting.

The first thing which the sportsman ought to attend to is the choice of his fowling-piece. Convenience requires that the barrel be as light as possible, at the same time it ought to possess that degree of strength which will make it not liable to burst. Experience has proved, that a thin and light barrel, which is of equal thickness in every part of its circumference, is much less liable to burst than one which is considerably thicker and heavier, but which, from being badly filed or bored, is of unequal strength in different places.

It is also of importance to determine of what length the barrel ought to be, in order to acquire that range which the sportsman has occasion for. On this subject we have received the following information from an experienced sportsman. We have, at different times, compared barrels of all the intermediate lengths between 28 and 40 inches, and of nearly the same caliber, that is to say, from 22 to 26; and these trials were made both by firing the pieces from the shoulder, and from a firm block, at an equal distance, and with equal weights of the same powder and of the same shot.

To avoid every possibility of error, the quires of paper at which we fired were fixed against planks instead of being placed against the wall. From these trials frequently repeated, we found that the shot pierced an equal number of sheets, whether it was fired from a barrel of 28, 30, 32, 34, 36, 38, or 40, inches in length. Nay more, we have compared two barrels of the same caliber, but one of them 33, and the other 66 inches long, by repeatedly firing them in the same manner as the others, at different distances, from 45 to 100 paces, and the results have always been the same, i. e. the barrel of 33 inches drove its shot through as many sheets of paper as that of 66 did. The conclusion from all this is, that the difference of 10 inches in the length of the barrel, which seems to be more than is ever insisted upon among sportsmen, produces no sensible difference in the range of the piece; and therefore, that every one may please himself in the length of his barrel, without either detriment or advantage to the range.

It may appear as an objection to this, that a duck-gun which is five or six feet long kills at a greater distance

than

Fig. 1.

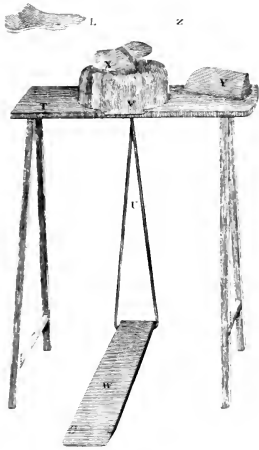
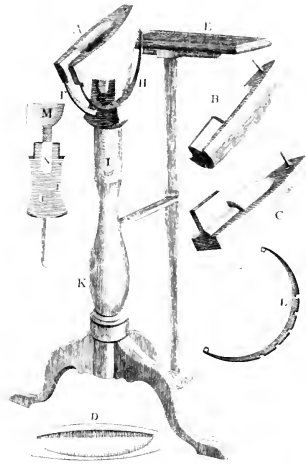
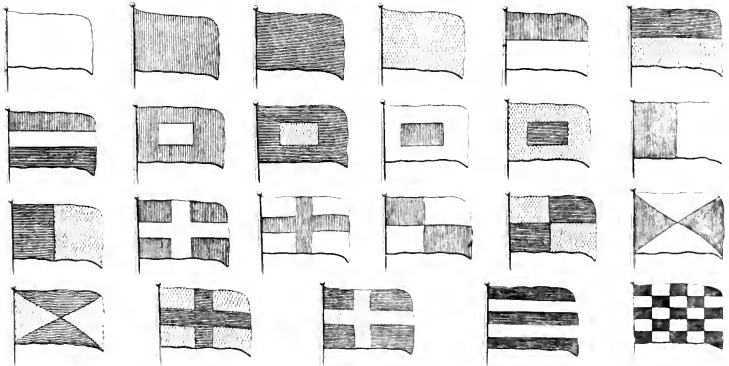
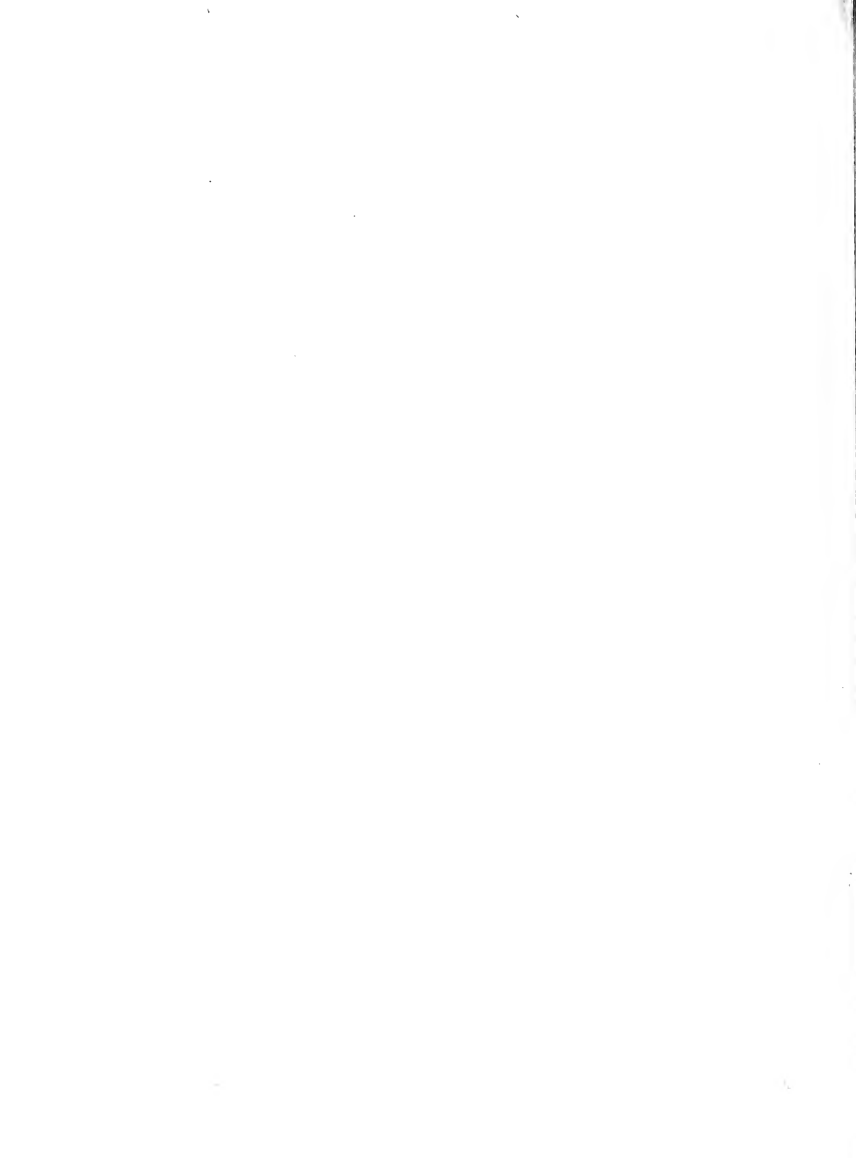

Fig. 2.



Naval SIGNALS.





3
Proper
length of
the barrel

4
Caliber.

5
Length and
form of the
stock.

than a fowling-piece; but this is not owing to its length, but to its greater weight and thickness, which give it such additional strength, that the shot may be increased, and the charge of powder doubled, trebled, and even quadrupled. But a barrel of five or six feet length would be very inconvenient for fowling. Those who consult the appearance of the piece, lightness, and the ease with which it is managed, will find that a barrel from 32 to 38 inches will answer best.

The next thing to be considered is, of what dimensions the caliber or bore of a fowling-piece ought to be. This matter has been subjected to experiment, and it has been found, that a barrel of 22 or 24, which is the largest caliber usually employed in fowling-pieces, throws its shot: s closely as one of the smallest caliber, viz. of 30 or 32 (A).

As to the length and form of the stock, it may be laid down as a principle, that a long stock is preferable to a short one, and at the same time rather more bent than usual; for a long stock fits firmer to the shoulder than a short one, and particularly so when the shooter is accustomed to place his left hand, which principally supports the piece, near to the entrance of the ramrod into the stock.

It is certain, however, that the stock may be so formed as to be better suited to one man than another. For a tall, long-armed man, the stock of a gun should be longer than for one of a less stature and shorter arm. That a straight stock is proper for him who has high shoulders and a short neck; for, if it be much bent, it would be very difficult for him, especially in the quick motion required in shooting at a flying or running object, to place the butt of the gun-stock firmly to the shoulder, the upper part alone would in general be fixed; which would not only raise the muzzle, and consequently shoot high, but make the recoil much more sensibly felt, than if the whole end of the stock were firmly placed on his shoulder. Besides, supposing the shooter to bring the butt home to his shoulder, he would scarcely be able to level his piece at the object. On the contrary, a man with low shoulders, and a long neck, requires a stock much bent; for if it is straight, he will, in the act of lowering his head to that place of the stock at which his cheek should rest in taking aim, feel a constraint which he never experiences, when by the effect of the proper degree of bent, the stock lends him some assistance, and, as it were, meets his aim half way.

Having now described the fowling-piece which has been found to answer best, it will next be proper to give some instructions for the choice of gunpowder, shot, and wadding.

6
Best gun-
powder.

The various kinds of gunpowder are well known; but, in the opinion of some experienced sportsmen, Hervey's battle-powder is the best. Those who wish to examine the strength of powder, may determine it by drying some of it very well, and then trying how many sheets of paper it will drive the shot through, at the distance of 10 or 12 yards. In this trial we should be

careful to employ the same sized shot in each experiment, the quantity both of the shot and the powder being regulated by exact weight; otherwise we cannot, even in this experiment, arrive at any certainty in comparing the strength of different powders, or of the same powder at different times.

7
To be kept
dry.

Powder ought to be kept very dry, for every degree of moisture injures it; and if considerable, the saltpetre is dissolved, and the intimate combination of the several ingredients is entirely destroyed. It is observed, that after firing with damp powder the piece becomes very cool, which seems to arise from the diminution of the activity of the fire in the explosion. Halls of copper or tin are much better for keeping powder in than those made of leather, or than small casks. Their necks ought to be small and well stopped with cork.

8
the of
that.

The patent milled shot is now very generally used, and is reckoned superior to any other. The size of the shot must vary according to the particular species of game which is the object of the sportsman's pursuit, as well as be adapted to the season. In the first month of partridge shooting, N^o 1. is most proper; for since at this time the birds spring near at hand, and we seldom fire at more than the distance of 40 paces, if the shooter takes his aim but tolerably well, it is almost impossible for a bird at this distance to escape in the circle which the shot forms.

As hares sit closer, and are thinly covered with fur at this season, they may easily be killed with this shot at 30 or 35 paces. N^o 1. is equally proper for shooting hares or quails. About the beginning of October, when the partridges are stronger, N^o 3. is the most proper that to be used. Many sportsmen use no other during the whole season. The directions which have now been given refer only to the patent shot.

We shall now subjoin a table, which will shew at one view the number of pellets composing an ounce weight of each sort of shot, the patent and the common, beginning with the smallest size.

		PATENT SHOT.	
N ^o 8.	1 ounce	-	620
7	id.	-	490
× (8)	id.	-	300
1	ib	-	220
2	id.	-	160
3	id.	-	157
4	id.	-	125
5	id.	-	83

		COMMON SHOT.	
N ^o 7.	1 ounce	-	370
6	id.	-	260
5	id.	-	235
4	id.	-	190
3	id.	-	140
2	id.	-	110
1	id.	-	95

9
Proportion
of powder,
and the
quantity, the charge.

For a fowling-piece of a common caliber, which is Preparation of powder, and the quantity, the charge.

(A) In speaking of the size of the caliber, we mean by 22 or 24, that so many balls exactly fitting it weigh just one pound; and every caliber is marked in the same way.

(B) The reader will observe that the patent shot has no N^o 6, the × being substituted in its place, and that the numbers do not follow each other in the order of progression: The reason of this we cannot assign.

quarter, or at most a dram and a half, of good powder; and an ounce, or an ounce and a quarter of that, is sufficient. But when shot of a larger size is used, such as N^o 5, the charge of shot may be increased one-fourth, for the purpose of counterbalancing in some degree what the size of the shot loses in the number of pellets, and also to enable it to penetrate the more. For this purpose the sportsman will find a measure marked with the proper gauges very convenient to him. An instrument of this nature has been made by an ingenious artist of London, Egg, of the Haymarket.

A consequence of overloading with shot, is the powder has not sufficient strength to throw it to its proper distance; for if the object fired at be distant, one-half of the pellets composing the charge, by their too great quantity and weight, will strike against each other, and fall by the way; and those which reach the mark will have small force, and will produce but little or no effect.

10
Wadding.

The use of the *wadding* is to carry the shot in a body to a certain distance from the muzzle of the piece. It ought to be of soft and pliable materials. The best kind of wadding, in the opinion of an experienced fowler, is a piece of an old hat; but this cannot be obtained in sufficient quantity. Next to it nothing is better than soft brown paper, which combines suppleness with consistence, moulds itself to the barrel, and never falls to the ground within 12 or 15 paces from the muzzle of the piece. Tow answers very well, and cork has been extolled for possessing the peculiar virtue of increasing the range and closeness of the shot.

The wadding ought to be quite close in the barrel, but not rammed too hard; for if it be rammed too close, or be of a rigid substance, the piece will recoil, and the shot will spread too much. On the other hand, if the wadding be very loose, or is composed of too soft materials, such as wool or cotton, the discharge will not possess proper force.

11
Powder
and shot
to be first
rammed
down.

In loading a piece, the powder ought to be slightly rammed down by only pressing the ramrod two or three times on the wadding, and not by drawing up the ramrod and then returning it into the barrel with a jerk of the arm several times. For when the powder is violently compressed, some of the grains must be bruised, which will prevent the explosion from being quick, and will spread the shot too wide. In pouring the powder into the barrel, the measure ought to be held so as that the powder may fall most readily to the bottom. That no grains may adhere to the sides of the barrel, the butt-end of the piece may be struck against the ground. The shot ought never to be rammed down with force: it is sufficient to strike the butt-end of the gun against the ground as before. Then the wadding is to be put down gently. A sportsman ought never to carry his gun under his arm with the muzzle inclined downwards, for this practice loosens the wadding and charge too much.

12
Directions
for loading
and firing.

Immediately after the piece is fired it ought to be reloaded; for while the barrel is still warm, there is no danger of any moisture lodging in it to hinder the powder from falling to the bottom. As it is found that the coldness of the barrel, and perhaps the moisture condensed in it, diminishes the force of the powder in the next shot; it is proper to fire off a little powder before the piece is loaded. Some prime before loading, but

this is not proper unless the touch-hole be very large. After every discharge the touch-hole ought to be pricked, or a small feather may be inserted to clear away any humidity or foulness that has been contracted.

Shot, &c.

The sportsman having loaded his piece, must next prepare to fire. For this purpose he ought to place his hand near the entrance of the ramrod, and at the same time grasp the barrel firmly. The muzzle should be a little elevated, for it is more usual to shoot low than high. This direction ought particularly to be attended to when the object is a little distant; because shot as well as ball only moves a certain distance point blank, when it begins to describe the curve of the parabola.

Practice soon teaches the sportsman the proper distance at which he should shoot. The distance at which he ought infallibly to kill any kind of game with patent shot, N^o 3, provided the aim be well taken, is from 25 to 35 paces for the footed, and from 40 to 45 paces for the winged, game. Beyond this distance even to 50 or 55 paces, both partridges and hares are sometimes killed; but in general the hares are only slightly wounded, and carry away the shot; and the partridges at that distance present so small a surface, that they frequently escape untouched between the spaces of the circle. Yet it does not follow that a partridge may not be killed with N^o 3, patent shot at 60 and even 70 paces distance, but then these shots are very rare.

13
Distance
at which
the
sportsman
ought to
shoot.

In shooting at a bird flying, or a hare running across, it is necessary to take aim before the object in proportion to its distance at the time of firing. If a partridge flies across at the distance of 30 or 35 paces, it will be sufficient to aim at the head, or at most but a small space before it. If it be 50, 60, or 70 paces distant, it is then requisite to aim at least half a foot before the head. The same practice ought to be observed in shooting at a hare, rabbit, or fox, when running in a cross direction; at the same time making due allowance for the distance and swiftness of the pace. Another thing to be attended to is, that the shooter ought not involuntarily to stop the motion of the arms at the moment of pulling the trigger; for the instant the hand stops in order to fire, however inconsiderable the time be, the bird gets beyond the line of aim, and the shot will miss it. A sportsman ought therefore to accustom his hand while he is taking aim to follow the object. When a hare runs in a straight line from the shooter, he should take his aim between the ears, otherwise he will run the hazard either of missing, or at least not of killing dead, or as it is sometimes called *clean*.

14
How the
aim is to be
taken.

A fowling-piece should not be fired more than 20 or 25 times without being washed; a barrel when fouled neither shoots so ready, nor carries the shot so far as when clean. The flint, pan, and hammer, should be well wiped after each shot; this contributes greatly to make the piece go off quick, but then it should be done with such expedition, that the barrel may be reloaded whilst warm, for the reasons we have before advanced. The flint should be frequently changed, without waiting until it misses fire, before a new one is put in. Fifteen or eighteen shots, therefore, should only be fired with the same flint; the expense is too trifling to be regarded, and by changing it thus often much vexation will be prevented.

15
Every part
of the piece
to be kept
clean and
dry.

Shooting.

Shooting.

A gun also should never be fired with the prime of the preceding day; it may happen that an old priming will sometimes go off well, but it will more frequently contract moisture and fuzer in the firing; then the object will most probably be missed, and that because the piece was not fresh primed.

15
When and
how game
is to be
fought for.

For the information of the young sportsman we shall add a few more general directions. In warm weather he ought to seek for game in plains and open grounds, and in cold weather he may search little hills exposed to the sun, along hedges, among heath, in stubbles, and in pastures where there is much fuzer and fern. The morning is the best time of the day, before the dew is exhaled, and before the game has been disturbed. The colour of the shooters dress ought to be the same with that of the fields and trees; in summer it ought to be green, in winter a dark gray. He ought to hunt as much as possible with the wind, not only to prevent the game from perceiving the approach of him and his dog, but also to enable the dog to scent the game at a greater distance.

He should never be discouraged from hunting and ranging the same ground over and over again, especially in places covered with heath, brambles, high grass, or young coppice wood. A hare or rabbit will frequently suffer him to pass several times within a few yards of its form without getting up. He should be still more patient when he has marked partridges into such places, for it often happens, that after the birds have been sprung many times, they lie so dead that they will suffer him almost to tread upon them before they will rise. Pheasants, quails, and woodcocks do the same.

He ought to look carefully about him, never passing a bush or tuft of grass without examination; but he ought never to strike them with the muzzle of his gun for it will loosen his wadding. He who patiently beats and ranges his ground over again, without being discouraged, will always kill the greatest quantity of game; and if he is shooting in company, he will find game where others have passed without discovering any.

When he has fired he should call in his dog, that he may not have the mortification to see game rise which he cannot shoot. When he has killed a bird, instead of being anxious about picking it up, he ought to follow the rest of the covey with his eye till he see them settle.

Three species of dogs are capable of receiving the proper instruction, and of being trained. These are the smooth pointer, the spaniel, and the rough pointer. The last is a dog with long curled hair, and seems to be a mixed breed of the water-dog and the spaniel. The smooth pointer is active and lively enough in his range, but in general is proper only for an open country.

The greatest part of these dogs are afraid of water, brambles, and thickets; but the spaniel and the rough pointer are easily taught to take the water, even in cold weather, and to range the woods and rough places as well as the plain. Greater dependance may therefore be had on these two last species of dogs than on the smooth pointer.

The education of a pointer may commence when he is only five or six months old. The only lessons which he can be taught at this time are to *fetch* and *carry* any

thing when desired; to come in when he runs far off, and to go behind when he returns; using, in the one case, the words *here*, *come in*, and in the other *back* or *behind*. It is also necessary at this period to accustom him to be tied up in the kennel or stable; but he ought not at first to be tied too long. He should be let *loose* in the morning, and fastened again in the evening. When a dog is not early accustomed to be chained, he disturbs every person in the neighbourhood by howling. It is also of importance that the person who is to train him should give him his food.

When the dog has attained the age of 10 or 12 months, he may be carried into the field to be regularly trained. At first he may be allowed to follow his own inclination, and to run after every animal he sees. His indiscriminating eagerness will soon abate, and he will pursue only partridges and hares. He will soon become tired of following partridges in vain, and will content himself after having hunted them to follow them with his eyes. It will be more difficult to prevent him from following hares.

All young dogs are apt to *take*; that is, to hunt with their noses close to the ground, to follow birds rather by the track than by the wind. But partridges lie much better to dogs that *wind* them, than to those that follow them by the track. The dog that winds the scent approaches the birds by degrees and without disturbing them; but they are immediately alarmed when they see a dog tracing their footprints. When you perceive that your dog is committing this fault, call to him in an angry tone *hold up*: he will then grow uneasy and agitated, going first to the one side and then to the other, until the wind brings him the scent of the birds. After finding the game four or five times in this way, he will take the wind of himself, and hunt with his nose high. If it be difficult to correct this fault, it will be necessary to put the *purple peg* upon him. This is of very simple construction, consisting only of a piece of oak or deal inch broad, one foot in length, and an inch and a half in breadth, tapering a little to one end; at the broader end are two holes running longitudinally, through which the collar of the dog is put, and the whole is buckled round his neck; the piece of wood being projected beyond his nose, is then fastened with a piece of leather it long to his under jaw. By this means the pet advancing seven or eight inches beyond his *snout*, the dog is prevented from putting his nose to the ground and taking.

As soon as the young dog knows his game, you must bring him under complete subjection. If he is tractable, this will be easy; but if he is stubborn, it will be necessary to use the *trough cord*, which is a rope or cord of 20 or 25 fathoms in length fastened to his collar. If he refuse to come back when called upon, you must check him finally with the cord, which will often bring him upon his haunches. But be sure you never call to him except when you are within reach of the cord. After repeating this several times he will not fail to come back when called; he ought then to be caressed, and a bit of bread should be given him. He ought now constantly to be tied up, and never unchained, except when you give him his food, and even then only when he has done something to deserve it.

The next step will be to throw down a piece of bread on the ground, at the same moment taking hold

17
Dogs fit
for sport.

18
Directions
for training
a pointer.

of the dog by the collar, calling out to him, "take heed,—*folly*." After having held him in this manner for some space of time, say to him, "take heed—*lay hold*." If he is impatient to lay hold of the piece of bread before the signal is given, correct him gently with a small whip. Repeat this lesson until he "takes heed" well, and no longer requires to be held fast to prevent him from laying hold of the bread. When he is well accustomed to this manœvre, turn the bread with a stick, holding it in the manner you do a fowling-piece, and having done so, cry *seize*. Never suffer the dog to eat either in the house or field without having first made him take heed in this manner.

Then, in order to apply this lesson to the game, fry small pieces of bread in hogs lard, with the dang of partridge; take these in a linen bag into the fields, stubbles, ploughed grounds, and pastures, and there put the pieces in several different places, marking the spots with little cleft pickets of wood, which will be rendered more distinguishable by putting pieces of card in the wicks. This being done, call off the dog and conduct him to these places, always hunting in the wind. After he has caught the scent of the bread, if he approaches too near, and seems eager to fall upon it, cry to him in a menacing tone, "take heed;" and if he does not stop immediately, correct him with the whip. He will soon comprehend what is required of him, and will stand.

At the next lesson, take your gun charged only with powder, walk gently round the piece of bread once or twice, and fire instead of crying *seize*. The next time of practising this lesson, walk round the bread four or five times, but in a greater circle than before, and continue to do this, until the dog is conquered of his impatience, and will stand without moving until the signal is given him. When he keeps his point well, and stands steady in this lesson, you may carry him to the birds; if he run in upon them, or bark when they spring up, you must correct him; and if he continue to do so, you must return to the fried bread; but this is seldom necessary.

When the dog has learned by this use of the bread to take heed, he may be carried to the fields with the trash-cord dragging on the ground. When he springs birds for the first time, if he runs after them or barks, check him by calling out to him, *take heed*. If he point properly, catch him; but you ought never to hunt without the cord until he point staunch.

If the dog runs after sheep, and it be difficult to cure him, couple him with a ram, and then whip the dog as long as you can follow him. His cries will at first alarm the ram; he will run with all his speed, and drag the dog along with him; but he will at length take courage, turn upon the dog, and butt him severely with his horns. When you think the dog is sufficiently chastised, untie him: he will never run at sheep again.

Having now given a few general instructions concerning the best method of training pointers, we shall subjoin a few observations respecting the most common species of game, the partridge, pheasant, grouse, woodcock, snipe, and wild duck.

Partridges pair in the spring, and lay their eggs generally from 15 to 22) during May and part of June. The young begin to fly about the end of June, and their plumage is complete in the beginning of October. The male has a conspicuous horse shoe upon his breast,

an obtuse spur on the hinder part of the leg, which distinguishes him from the female. He is also rather larger.

When a sportsman is shooting in a country where the birds are thin, and he no longer chooses to range the field for the bare chance of meeting with them, the following method will show him where to find them on another day. In the evening, from sunset to night-fall, he should post himself in a field, at the foot of a tree or a bush, and there wait until the partridges begin to call or juck, which they always do at that time; not only for the purpose of drawing together when separated, but also when the birds composing the covey are not dispersed. After calling in this manner for some little space of time, the partridges will take to flight; then, if he mark the place where they alight, he may be assured they will lie there the whole night, unless disturbed. Let him return to the same post the next morning by break of day, and there watch a while; being careful to keep his dog in a string, if he is not under perfect command.

As soon as the dawn begins to peep, the partridges will begin to call, and soon afterwards will perform the same manœuvre as on the preceding evening; that is, after having called a while, they will take their flight, and will most commonly settle at a little distance. There in a few minutes they will call again, and sometimes take a second flight, but that will be to no great distance. Then as soon as the sun is risen, and the sportsman can see to shoot, he may call off his dog and pursue them.

The *pheasant* is of the size of a common durgill ²¹ Pheasant. cock, and lays its eggs generally in the woods, the number of which is 15 or 12.

Pheasants are accounted stupid birds; for when they are surprised they will frequently squat down like a rabbit, supposing themselves to be in safety as soon as their heads are concealed; and in this way they will sometimes suffer themselves to be killed with a tick. They love low and moist places, and haunt the edges of those pools which are in found in woods, as well as the high grafs of marshes that are near at hand; and above all, places where there are clumps of alders.

Grouse, or moor-game, are found in Wales, in the ²² Grouse. northern counties of England, and in great abundance in Scotland. They chiefly inhabit those mountains and moors which are covered with heath, and seldom descend to the low grounds. They fly in companies of four or five braces, and love to frequent mossy places, particularly in the middle of the day or when the weather is warm. In pursuing this game, when the pointer sets, and the sportsman perceives the birds running with their heads erect, he must run after them as fast as he can, in the hope that he may get near enough to shoot when they rise upon the wing; for he may be pretty certain they will not lie well that day. As these birds are apt to grow soon putrid, they ought to be drawn carefully the instant they are shot and stuffed with any heath, and if the feathers happen to be wetted they must be wiped dry.

The *woodcock* is a bird of passage; it commonly ar- ²³ Woodcock. rives about the end of October, and remains until the middle of March. Woodcocks are fatter in December and January, but from the end of February they are lean. At their arrival they drop anywhere, but afterwards

3

19
and pre-
venting his
running af-
ter sheep.

20
Observa-
tions con-
cerning the
partridge.

Shooting.

21

22

23

Shooting wards take up their residence in copes of nine or ten years growth. They seldom, however, stay in one place longer than 12 or 15 days. During the day, they remain in these parts of the woods where there are void spaces or glades, picking up earth-worms and grubs from the fallen leaves. In the evening they go to drink and wash their bills at pools and springs, after which they repair to the open fields and meadows for the night. It is remarkable, that when a woodcock springs from a wood to go into the open country, he always endeavours to find some glade or opening, which he follows to the boundaries of the wood. At his return he pursues the same path a good way, and then turns to the right or left opposite to some glade, in order to drop into a thick part of the wood, where he may be sheltered from the wind. He may therefore be watched with advantage in these narrow passes and little alleys on the edges of woods which lead to a pool or spring, or he may be watched in the dulk of the evening near the pools which he frequents.

24
Snipe. The *snipe* is a bird of passage as well as the woodcock. This bird is scarcely worth shooting till the froil commences. In the month of November they begin to grow fat. Snipes, like woodcocks, frequent springs, bogs, and marshy places, and generally fly against the wind. The flant and cross shots are rather difficult, as the birds are small and fly very quickly. The sportsman ought to look for them in the direction of the wind; because then they will fly towards him, and present a fairer mark.

25
Wild duck. The *wild duck* is also a bird of passage, and arrives here in great flocks from the northern countries in the beginning of winter. Still, however, a great many remain in our marshes and fens during the whole year, and breed.

The wild duck differs little in plumage from the tame duck, but is easily distinguished by its size, which is less; by the neck, which is more slender; by the foot, which is smaller; by the nails, which are more black; and above all, by the web of the foot, which is much finer and softer to the touch.

In the summer season, when it is known that a team of young ducks are in a particular piece of water, and just beginning to fly, the sportsman is sure to find them early in the morning dabbling at the edges of the pool, and amongst the long grass, and then he may get very near to them: it is usual also to find them in those places at noon.

In the beginning of autumn almost every pool is frequented by teams of wild ducks, which remain there during the day, concealed in the rushes. If these pools are of small extent, two shooters, by going one on each side, making a noise and throwing stones into the rushes, will make them fly up; and they will in this way frequently get shots, especially if the pool is not broad, and contracts at one end. But the surest and most successful way, is to launch a small boat or trow on the pool, and to travel the rushes by the openings which are found; at the same time making as little noise as possible. In this manner the ducks will suffer the sportsman to come sufficiently near them to shoot flying; and it often happens that the ducks, after having flown up, only make a circuit, return in a little time, and again alight upon the pool. Then the sportsman endeavour a second time to come near them. If several shooters

are in company, they should divide; two should go in the boat, whilst the others spread themselves about the edge of the pool, in order to shoot the ducks in their flight. In pools which will not admit a trow, water-spaniels are absolutely necessary for this sport.

In winter they may be found on the margins of little pools; and when pools and rivers are frozen up, they must be watched for in places where there are springs and waters which do not freeze. The sport is then much more certain, because the ducks are confined to these places in order to procure aquatic herbs, which are almost their only food at this period.

SHOP-LIFTERS, are those that steal goods privately out of shops; which, being to the value of 5s. though no person be in the shop, is felony without the benefit of clergy by the 10 and 11 W. III. c. 23.

SHORE, a place washed by the sea, or by some large river.

Count Marigli divides the sea-shore into three portions: the first of which is that tract of land which the sea just reaches in storms and high tides, but which it never covers; the second part of the shore is that which is covered in high tides and storms, but is dry at other times; and the third is the descent from this, which is always covered with water.

The first part is only a continuation of the continent, and suffers no alteration from the neighbourhood of the sea, except that it is rendered fit for the growth of some plants, and wholly unfit for that of others, by the saline steams and impregnations: and it is scarce to be conceived by any, but those who have observed it, how far on land the effects of the sea reach, so as to make the earth proper for plants which will not grow without this influence; there being several plants frequently found on high hills and dry places, at three, four, and more miles from the sea, which yet would not grow unless in the neighbourhood of it, nor will ever be found elsewhere.

The second part or portion of the shore is much more affected by the sea than the former, being frequently washed and beaten by it. Its productions are rendered salt by the water, and it is covered with sand, or with the fragments of shells in form of sand, and in some places with a tartarous matter deposited from the water; the colour of this whole extent of ground is usually dusky and dull, especially where there are rocks and stones, and these covered with a slimy matter.

The third part of the shore is more affected by the sea than either of the others; and is covered with an uniform crust of the true nature of the bottom of the sea, except that plants and animals have their residence in it, and the decayed parts of these alter it a little.

SHORE, Jane, the celebrated concubine of the licentious King Edward IV. was the wife of Mr Matthew Shore, a goldsmith in Lombard-street, London. Kings are seldom unsuccessfull in their amorous pursuits; therefore there was nothing wonderful in Mrs Shore's removing from Lombard-street to shine at court as the royal favourite. Historians represent her as extremely beautiful, remarkably cheerful, and of most uncommon generosity. The king, it is said, was no less captivated with her temper than with her person: the never made use of her influence over him to the prejudice of any person; and if ever the importuned him, it was in favour of the unfortunate. After the death of Edward,

Shore
Short.

she attached herself to the lord Hastings; and when Richard III. cut off that nobleman as an obstacle to his ambitious schemes, Jane Shore was arrested as an accomplice, on the ridiculous accusation of witchcraft. This, however, terminated only in a public penance; excepting that Richard seized her of all her little property: but whatever severity might have been exercised towards her, it appears that she was alive, though sufficiently wretched, under the reign of Henry VIII. when Sir Thomas More saw her poor, old, and shrivelled, without the least trace of her former beauty. Mr Rowe, in his tragedy of Jane Shore, has adopted the popular story related in the old historical ballad, of her perishing by hunger in a ditch where Shoreditch now stands. But Stow assures us that fire was so named before her time.

SHORL. See **SCHORL**, MINERALOGY *Index*.

SHORLING and **MORLING**, are words to distinguish fells of sheep; *shorling* being the fells after the fleeces are shorn off the sheep's back; and *morling*, the fells dead off after they die or are killed. In some parts of England they are denominated by a *shorling*, a sheep whose face is shorn off; and by a *morling*, a sheep that dies.

SHORT, JAMES, an eminent optician, was born in Edinburgh on the 10th of June, O. S. in the year 1710. At ten years of age, having lost his father and mother, and being left in a state of indigence, he was received into Heriot's Hospital, (see **EDINBURGH**, *Public Buildings*, N^o 16.), where he soon displayed his mechanical genius in constructing, for himself, little chests, book-cases, and other conveniences, with such tools as fell in his way. At the age of twelve he was removed from the Hospital to the High School, where he showed a considerable taste for classical literature, and generally kept at the head of his forms. In the year 1726 he was entered into the university, where he passed through the usual course of education, and took his master's degree with great applause.

By his friends he was intended for the church; but after attending a course of theological lectures, his mind revolted from a profession which he thought little suited to his talents; and he devoted his whole time to mathematical and mechanical pursuits. He had been fortunate enough to have the celebrated M. Launier for his preceptor; who having soon discovered the bent of his genius, and made a proper estimate of the extent of his capacity, encouraged him to prosecute those studies in which nature had qualified him to make the greatest figure. Under the eye of that eminent master, he began in 1732 to construct Gregorian telescopes; and, as the professor observed in a letter to Dr Jurin, "by taking care of the figure of his specula, he was enabled to give them larger apertures, and to carry them to greater perfection, than had ever been done before him." (See **OPTICS**, N^o 89.)

In the year 1736 Mr Short was called to London, at the desire of Queen Caroline, to give instructions in mathematics to William duke of Cumberland; and immediately on his appointment to this very honourable office he was elected a fellow of the royal society, and patronized by the earls of Morton and Macclesfield. In the year 1739 he accompanied the former of those noble lords to the Okeby estates, where he was employed in adjusting the geography of that part of Scotland; and

happy it was for him that he was so employed, as he would otherwise have been involved in a scuffle which took place between the retainers of Sir James Stewart of Barra and the attendants of the earl, in which some of the latter were dangerously wounded.

Mr Short having returned to London, and finally established himself there in the line of his profession, was in 1742 employed by Lord Thomas Spencer to make for him a reflector of twelve feet focus, for which he received 600 guineas. He made several other telescopes of the same total distance with greater improvements and higher magnifiers; and in 1752 finished one for the king of Spain, for which, with its whole apparatus, he received 1200*l*. This was the noblest instrument of the kind that had then been constructed, and perhaps it has never yet been surpassed except by the astonishing reflectors of Herschel. See **TELESCOPE**.

Mr Short used to visit the place of his nativity once every two or three years during his residence in London, and in 1766 he visited it for the last time. On the 15th of June 1768 he died, after a very short illness, at Newington Butts, near London, of a mortification in his bowels, and was buried on the 22d of the same month, having completed, within a few days, his fifty-eighth year. He left a fortune of about 20,000*l*. of which 15,000*l*. was bequeathed to two nephews, and the rest in legacies to his friends. In gratitude for the steady patronage of the earl of Morton, he left to his daughter the lady Mary Douglas, afterwards countess of Aboyne, 1200*l*. and the reversion of his fortune, should his nephews die without issue; but this reversionary legacy the lady, at the desire of her father, generously relinquished by a deed in favour of Mr Short's brother Mr Thomas Short and his children. Mr Short's eminence as an artist is universally known, and we have often heard him spoken of by those who were acquainted with him from his youth, as a man of virtue and of very amiable manners.

SHORT-Hand Writing. See **SYNOGRAPHY**.

SHORT-Jointed, in the *Manege*. A horse is said to be short-jointed that has a short pattern; when this joint, or the pattern is too short, the horse is subject to have his fore legs from the knee to the cornea all in a straight line. Commonly your short-jointed horses do not manège so well as the long-jointed; but out of the manège the short-jointed are the best for travel or fatigue.

SHORT-Sightedness, a certain defect in vision, by which objects cannot be distinctly seen unless they are very near the eye. See **OPTICS**, N^o 142.

SHORTFORD, *q. d. fore-cloze*, an ancient custom in the city of Exeter, when the lord of the fee cannot be answered rent due to him out of his tenement, and no distress can be levied for the same. The lord is then to come to the tenement, and there take a stone, or some other dead thing off the tenement, and bring it before the mayor and bailiff, and thus he must do seven quarter days successively; and if on the seventh quarter-day the lord is not satisfied of his rent and arrears, then the tenement shall be adjudged to the lord to hold the same a year and a day; and forthwith proclamation is to be made in the court, that if any man claims any title to the said tenement, he must appear within the year and day next following, and satisfy the lord of the said rent and arrears; but if no appearance be made, and the rent not paid, the lord comes again to the court,

Short
Short-Hand.

Shot, court, and prays that, according to the custom, the said tenement be adjudged to him in his demesne as of fee, which is done accordingly, so that the lord hath from thenceforth the said tenement, with the appurtenances to him and his heirs.

SHOT, a denomination given to all sorts of balls for fire-arms: those for cannon being of iron, and those for guns, pistols, &c. of lead. See **SHOOTING**.

Cafe SHOT formerly consisted of all kinds of old iron, nails, musket-balls, stones, &c. used as above.

SHOT of a Cable, on ship-board, is the splicing of two cables together, that a ship may ride safe in deep waters and in great roads; for a dip will ride easier by one thot of a cable, than by three short cables out ahead.

Grape-SHOT. See **GRAPE-SHOT**.

Patent-milled SHOT is thus made: Sheets of lead, whose thickness corresponds with the size of the shot required, are cut into small pieces, or cubes, of the form of a die. A great quantity of these little cubes are put into a large hollow iron cylinder, which is mounted horizontally and turned by a winch; when by their friction against one another and against the sides of the cylinder, they are rendered perfectly round and very smooth. The other patent shot is cast in moulds, in the same way as bullets are.

SHOT Flagon, a sort of flaggon somewhat bigger than ordinary, which in some counties, particularly Derbyshire, it is the custom for the host to serve his guests in, after they have drank above a shilling.

Small SHOT, or that used for fowling, should be well sized, and of a moderate bigness: for should it be too great, then it flies thin, and scatters too much; or if too small, then it hath not weight and strength to penetrate far, and the bird is apt to fly away with it. In order, therefore, to have it suitable to the occasion, it not being always to be had in every place fit for the purpose, we shall set down the true method of making all sorts and sizes under the name of *mould shot*. Its principal good properties are to be round and solid.

Take any quantity of lead you think fit, and melt it down in an iron vessel; and as it melts keep it stirring with an iron ladle, skimming off all impurities whatsoever that may arise at the top: when it begins to look of a greenish colour, blow on it as much as aughtmentum or yellow orpiment, finely powdered, as will lie on a shilling, to every 12 or 14 pound of lead; then stirring them together, the orpiment will flame.

The ladle should have a notch on one side of the brim, for more easily pouring out the lead; the ladle must remain in the melted lead, that its heat may be the same with that of the lead, to prevent inconveniences which otherwise might happen by its being either too hot or too cold: then, to try your lead, drop a little of it into water, and if the drops prove round, then the lead is of a proper heat; if otherwise, and the shot have tails, then add more orpiment to increase the heat, till it be found sufficient.

Then take a plate of copper, about the bigness of a trencher, which must be made with a hollowness in the middle, about three inches compass, within which must be bored about 40 holes according to the size of the shot which you intend to cast: the hollow bottom should be thin; but the thicker the brim, the better it will retain the heat. Place this plate on a frame of iron, over a tub or vessel of water, about four inches from the wa-

ter, and spread burning coals on the plate, to keep the lead melted upon it: then take some lead and pour it gently on the coals on the plate, and it will make its way through the holes into the water, and form itself into thot; do this till all your lead be run through the holes of the plate, taking care, by keeping your coals alive, that the lead do not cool, and so stop up the holes.

While you are casting in this manner, another person with another ladle may catch some of the shot, placing the ladle four or five inches underneath the plate in the water, by which means you will see if they are defective, and rectify them.

Your chief care is to keep the lead in a just degree of heat, that it be not so cold as to stop up the holes in your plate, nor so hot as to cause the shot to crack: to remedy the heat, you must refrain working till it is of a proper coolness; and to remedy the coolness of your lead and plate, you must blow your fire; observing, that the cooler your lead is, the larger will be your shot; as the hotter it is, the smaller they will be.

After you have done casting, take them out of the water, and dry them over the fire with a gentle heat, stirring them continually that they do not melt; when dry, you are to separate the great shot from the small, by the help of a sieve made for that purpose, according to their several sizes. But those who would have very large shot, make the lead trickle with a flick out of the ladle into the water, without the plate.

If it stop on the plate, and yet the plate be not too cool, give but the plate a little knock, and it will run again; care must be had that none of your implements be greasy, oily, or the like; and when the shot, being separated, are found too large or too small for your purpose, or otherwise imperfect, they will serve again at the next operation.

The sizes of common shot for fowling are from N^o 1 to 6, and smaller, which is called musket lead, or dust shot; but N^o 5 is small enough for any shooting whatsoever. The N^o 1 may be used for wild geese; the N^o 2 for ducks, widgeons, and other water-fowl; the N^o 3 for pheasants, partridges after the first month, and all the few-fowl; the N^o 4 for partridges, woodcocks, &c.; and the N^o 5 for snipes and all the smaller birds.

Tin-Cafe SHOT, in artillery, is formed by putting a great quantity of small iron shot into a cylindrical tin-box called a cannister, that just fits the bore of the gun. Lead bullets are sometimes used in the same manner; and it must be observed, that whatever number or sizes of the shots are used, they must weigh with their cases nearly as much as the shot of the piece.

SHOVEL, SIR CLOUDESLEY, was born about the year 1630 of parents rather in the lower rank of life. He was put apprentice to a shoemaker; but diliking this profession, he abandoned it a few years after, and went to sea. He was at first a cabin boy with Sir Christopher Mynns, but applying to the study of navigation with indefatigable industry, his skill as a seaman soon raised him above that station.

The corsairs of Tripoli having committed great outrages on the English in the Mediterranean, Sir John Narborough was sent in 1671 to reduce them to reason. As he had received orders to try the effects of negotiation before he proceeded to hostilities, he sent Mr

Shout
Shout.

Shovel, who was at that time a lieutenant in his fleet, to demand satisfaction. The Dey treated him with a great deal of disrespect, and sent him back without an answer. Sir John dispatched him a second time, with orders to remark particularly the situation of things on shore. The behaviour of the Dey was worse than ever. Upon Mr Shovel's return, he informed Sir John that it would be possible, notwithstanding their fortifications, to burn all the ships in the harbour. The boats were accordingly manned, and the command of them given to Lieut. Shovel, who seized the guardship, and burnt four others, without losing a man. This action so terrified the Tripolites, that they fled for peace.—Sir John Narborough gave for favourable an account of this exploit, that Mr Shovel was soon after made captain of the *Sapphire*, a fifth rate ship.

In the battle of Bantry-Bay, after the revolution, he commended the Edgar, and, for his gallant behaviour in that action, was soon after knighted by King William. Next year he was employed in transporting an army into Ireland; a service which he performed with so much diligence and dexterity, that the king raised him to the rank of rear-admiral of the blue, and delivered his commission with his own hands. Soon after he was made rear-admiral of the red, and shared the glory of the victory at La Hogue. In 1694, he bombarded Dunkirk. In 1703, he commanded the grand fleet in the Mediterranean, and did every thing in his power to assist the Protestants who were in arms in the Cevennes.

Soon after the battle of Malaga, he was presented by Prince George to Queen Anne, who received him graciously, and next year employed him as commander in chief.

In 1705, he commanded the fleet, together with the earls of Peterborough and Monmouth, which was sent into the Mediterranean; and it was owing to him chiefly that Barcelona was taken. After an unsuccessful attempt upon Toulon, he sailed for Gibraltar, and from thence homeward with a part of the fleet. On the 22d of October, at night, his ship, with three others, was cut away on the rocks of Scilly. All on board perished. His body was found by some fishermen on the island of Scilly, who stripped it of a valuable ring, and afterwards buried it. Mr Paxton, the purser of the *Armdak*, hearing of this, found out the fellows, and obliged them to discover where they had buried the body. He carried it on board his own ship to Portsmouth, from whence it was conveyed to London, and interred with great solemnity in Westminster Abbey. A monument was afterwards erected to his memory by the direction of the queen. He married the widow of his patron, Sir John Narborough, by whom he left two daughters, co-heiresses.

SHOVELER, a species of ANAS. See ANAS, ORNITHOLOGY Index.

SHOULDER BLADE, a bone of the shoulder, of a triangular figure, covering the hind part of the ribs, called by anatomists the *scapula* and *omoplatea*. See ANATOMY.

SHOUT, CLAMOUR, in antiquity, was frequently used on ecclesiastical, civil, and military occasions, as a sign of approbation, and sometimes of indignation.—Thus as Cicero, in an assembly of the people, was exposing the arrogance of L. Antony, who had had the

impudence to cause himself to be inscribed the patron of the Romans, the people on hearing this raised a shout to show their indignation. In the ancient military discipline, shouts were used, 1. Upon occasion of the general's making a speech or harangue to the army from his tribunal. This they did in token of their approving what had been proposed. 2. Before an engagement, in order to encourage and spirit their own men, and fill the enemy with dread. This is a practice of great antiquity; besides which, it wants not the authority of reason to support it; for as mankind are endowed with two senses, hearing and seeing, by which fear is raised in the mind, it may be proper to make use of the ear as well as the eye for that purpose. Shouts were also raised in the ancient theatre, when what was acted pleased the spectators. It was usual for those present at the burning of the dead to raise a great shout, and call the dead person by his name before they set fire to the pile.

SHOWER, in *Meteorology*, a cloud condensed into RAIN.

SHREWMOUSE. See SOREX, MAMMALIA Index.

SHREWSBURY, the capital of Shropshire in England. This town, the metropolis of the county, grew up out of the ruins of Uricinion, anciently a city, now a village called *Wroxeter*, about four miles from it. The Saxons called it *Scrabbes Berrig*, from the shrubs that grew about it; and from thence the present name of *Shrewsbury* is supposed to have been formed. It is pleasantly situated upon a hill near the Severn, over which there are two handsome bridges. It was a place of note in the Saxon times; after which it was granted by William the Conqueror, together with the title of earl and most of the county, to Roger de Montgomery, who built a castle upon the north side of it, where the Severn, that encompasses it on all other sides, leaves an opening. His son Robert built also a wall across this neck of land, when he revolted from Henry I. We learn from doomsday-book, that at that time, when a widow of this town married, she paid 20 shillings to the king, and a virgin 10. The above-mentioned Roger founded also, and endowed here, a Benedictine monastery and a collegiate church. When old age came upon him, he quitted the world, and spent the rest of his days as a monk in the abbey, and when he died was interred in its church. From the history of this church and monastery, it appears that ecclesiastical benefices about that time were hereditary. The abbey became so rich afterwards, that the abbot was mitred, and sat in parliament. Besides this abbey, in after times there were three others, viz. a Franciscan, Dominican, and Augustinian; and likewise two collegiate churches, one dedicated to St Chad and the other to St Mary. In the contest between the empress Maud and Stephen, this town and its governor William Fitz-Allan sided with the empress. In Henry III.'s time, a part of it was burnt down by the Welch; and in Richard II.'s reign a parliament was held in it. At a place called *Battlefield*, near this town, Henry Percy the younger, surnamed *Hotspur*, was killed in an engagement with Henry IV. against whom he had rebelled. The king afterwards built a chapel upon the spot, and endowed it for the support of two priests to pray for the souls of the slain. Two of Edward IV.'s sons were born here; namely,

Shrewsbury
 II
 Shropshire.

namely, Richard, Duke of York, whom Percin Warbeck afterwards persecuted, and who was murdered in the Tower; and George Plantagenet, who died before his brothers. Here first broke out the sweating sickness, which carried off great numbers suddenly, that those who were seized with it either died or recovered in the space of 24 hours. In the beginning of the civil wars, King Charles I. came hither, and formed an army, with which he marched towards London; but was met by the parliament's forces at Edgehill. He continued here from the 22th of September to the 12th of October, during which time he was joined by Prince Rupert, and many of the gentry and nobility of these parts. This town anciently gave title of earl to the Montgomeries, and afterwards to the Talbots, by whom it is still retained. Here is a free grammar-school, with three masters, and several others, well endowed by Edward VI. and Queen Elizabeth, and not inferior to many colleges in the universities. It has a good library and chapel, and there are several scholarships appropriated to it in the university of Cambridge. Here are also several hospitals, almshouses, and charity-schools. This town is one of the most flourishing in England, having two great weekly markets for corn, cattle, and provisions; and another for Welch cottons and flannels, of which great quantities are sold. A great trade is carried on with the Welch, who bring their commodities hither, as to the common mart of both nations. The town is large and well-built, and the situation extremely pleasant. There is a very beautiful walk called the *quarry*, between the town walls and the Severn, delightfully shaded with rows of lime-trees, so that it is not inferior to the Mall in St James's Park. The town is also noted for its gallantry and politeness, being full of gentry, for whom there are always balls and assemblies once a-week all the year round.—Here is a fine house and gardens, which belonged to the earl of Bradford; and in the neighbourhood, at Wroxeter, the Roman highway, called Watling-street, may be seen for several miles, where Roman coins are frequently found. In Shrewsbury are 12 incorporated trading companies; and the corporation has a power to try even capital causes of itself, except high treason. It is said that thigh-bones of dead men have been found here a yard long, and teeth three inches round and three long.

SHRIKE. See LANTUS, ORNITHOLOGY *Index*.

SHRIMP. See CANCELS, ENTOMOLOGY *Index*.

SHRINE, in *Ecclesiastical History*, a cave or box to hold the relics of some saint.

SHROPSHIRE, a county of England, bounded on the south by Worcesterhire, Herefordhire, and Radnorshire; on the north, by Cheshire; on the east, by Staffordhire; on the west, by Montgomeryhire and Denbighhire, in Wales. Its length is between 49 and 50 miles, its breadth about 38, and its circumference about 210. It is an inland county, containing 890,000 acres, 167,639 inhabitants, and 15 hundreds, in which are 170 parishes, and 15 market towns. It makes a part of three bishoprics, viz. Hereford, Coventry and Litchfield, and St Asaph. Some part of it lies on the north, and some on the south side of the Severn. Besides the Severn, it is also watered by the *Tand* or *Telford*, as it is called in Welch, which flows from the mountains of Radnorshire; and by the *Tern*, which has its rise and name from one of those pools called *tearnes*,

in Staffordshire. All these abound with fish, especially trouts, pikes, lampreys, graylings, carp, and eels. The air, especially upon the hills, with which the county abounds, is very wholesome. There is as great a diversity of soil as in most other counties. On the hills, where it is poor, is very good pasture for sheep; and in the low grounds, where it is very rich, along the Severn in particular, there is plenty of grass for hay and black cattle, with all sorts of corn. This county is abundantly provided with fuel, having in it many extensive mines of coal; it has also mines of lead and iron. Over most of the coal pits in this county lies a stratum or layer of blackish porous rock, of which, by grinding and boiling, they make pitch and tar, which are rather better than the common sort for caulking ships, as they do not crack, but always continue close and smooth. Quarries of lime-stone and iron-stone are common in the county, and the soil in many places is a reddish clay. The abundance of coal and iron-stone in this county has given rise to numerous manufactories.

As it lies upon the borders of Wales, it was anciently full of castles and walled towns. On the side next that country there was an almost continued line of castles, to guard the county against the incursions and depredations of the Welch. The borders here, as those between England and Scotland, were called *marches*, and there were certain noblemen entitled *barones marchie*, *marchiones de marchia Wallie*, "lords of the marches, or marquises of the marches of Wales," who were veiled with a sort of palatine jurisdiction, held courts of justice to determine controversies, and enjoyed many privileges and immunities, the better to enable and encourage them to protect the county against the incursions of the Welch, and to maintain order amongst the borderers; but they often abused their power, and were the greatest of tyrants.

As to the ecclesiastical government of the county, the far greater part, namely, all that belongs to the bishoprics of Hereford, and of Litchfield and Coventry, is under the jurisdiction and visitation of the archdeacon of Shrewsbury or Salop, and is divided into several deanries.

The Oxford circuit includes in it this county, which sends 12 members to parliament, viz. two for the shire, and two for each of the following towns, Shrewsbury, Ludlow, Wenlock, and Bishop's Castle.

SHROVE-TUESDAY, is the Tuesday after Quinquagesima Sunday, or the day immediately preceding the first of Lent; being so called from the Saxon word *shrive*, which signifies "to confess." Hence Shrove-Tuesday signifies Confession-Tuesday; on which day all the people in every parish throughout England (during the Romish times) were obliged to confess their sins, one by one, to their own parish-priests, in their own parish-churches; and, that this might be done the more regularly, the great bell in every parish was rung at ten o'clock (or perhaps sooner), that it might be heard by all, and that they might attend, according to the custom then in use. And though the Romish religion has now given way to the Protestant religion, the custom of ringing the great bell in our ancient parish-churches, at least in some of them, still remains, and obtains in and about London the name of *Pancake bell*; perhaps, because after the confession it was customary for the several persons to dine on pancakes or fritters. Most churches,

Shrewsbury
 II
 Shrove.

Shrouds,
Shrub.

churches, indeed, have rejected that custom of ringing the bell on Shrove-Tuesday; but the usage of dining on pancakes or fritters, and such like provision, still continues.

SHROUDS (*Scud Sax.*), a range of large ropes extending from the main heads to the right and left side of the ship, to support the masts, and enable them to carry fail, &c.

The shrouds as well as the fails are denominated from the masts to which they belong. Thus they are the main, fore, and mizen shrouds; the main-top-mast, fore-top-mast, or mizen-top mast shrouds; and the main-top-gallant, fore-top-gallant, or mizen-top-gallant shrouds. The number of shrouds by which a mast is sustained, as well as the size of rope of which they are formed, is always in proportion to the size of the mast and the weight of the fail it is intended to carry.

Bowprit shrouds are those which support the bowprit. Bumkin shrouds are those which support the bumkins. Futtock shrouds are shrouds which connect the efforts of the topmast shrouds to the lower shrouds. Bentinck shrouds are additional shrouds to support the masts in heavy gales. Preventer shrouds are similar to bentinck shrouds, and are used in bad weather to ease the lower rigging. See **MAST** and **SAIL**.

SHRUB, *frutex*, a little, low, dwarf tree, or a woody vegetable, of a size less than a tree; and which, instead of one single stem, frequently from the same root puts forth several sets or stems. See **PLANT** and **TREE**. Such are privet, phillyrea, holly, box, honey-suckle, &c. Shrubs and trees put forth in autumn a kind of buttons, or gems, in the axis of the leaves; these buttons are as so many little ova, which, coming to expand by the warmth of the following spring, open into leaves and flowers. By this, together with the height, some distinguish shrubs from *saproticeae*, or under shrubs, which are low bushes, that do not put forth any of these buttons, as fage, thyme, &c.

The two hardest shrubs we are possessed of are the ivy and box; these stand the severity of our sharpest winters unhurt, while other shrubs perish, and trees have their solid bodies split and torn to pieces. In the hard winter of the year 1683, these two shrubs suffered no injury any where; though the yews and hollies, which are generally supposed very hardy, were that winter in some places killed, and in others stripped of their leaves, and damaged in their bark. Furze-bushes were found to be somewhat harder than these, but they sometimes perished, at least down to the root. The broom seemed to creep the next step of hardiness beyond these. This lived where the others died, and where even these died, the juniper shrubs were sometimes found unhurt. This last is the only shrub that approaches to the hardiness of the box and ivy, but even it does not quite come up to them; for while they suffer nothing in whatever manner they are exposed, the juniper, though it bears cold well under the shelter of other trees, yet cannot bear the vicissitudes of heat and cold; inasmuch that some juniper shrubs were found half dead and half vigorous; that side which faced the mid-day sun having perished by the successive thawings and freezings of its sap; while that which was not exposed to the vicissitudes of heat had born the cold perfectly well. Such shrubs as are not hardy enough to de-

fy the winter, but appear half dead in the spring, may often be recovered by Mr Evelyn's method of beating their branches with a slender hazel-wand, to strike off the withered leaves and buds, and give a free passage to the air to the internal parts. Where this fails, the method is to cut them down to the quick, and if no part of the trunk appears in a growing condition, they must be taken off down to the level of the ground. Philosophical Transactions, N^o 165.

SHUTTLE, in the manufactures, an instrument used by the weavers, which guides the thread it contains, either of woollen, silk, flax, or other matter, so as to make it form the woofs of stuffs, cloths, linens, ribbands, &c. by throwing the shuttle alternately from left to right, and from right to left, across between the threads of the warp, which are stretched out lengthwise on the loom.

In the middle of the shuttle is a kind of cavity, called the *eye* or *chamber* of the shuttle; wherein is inclosed the spool, which is a part of the thread destined for the woof; and this is wound on a little tube of paper, rush, or other matter.

The ribband-weaver's shuttle is very different from that of most other weavers, though it serves for the same purpose: it is of box, six or seven inches long, one broad, and as much deep; shod with iron at both ends, which terminate in points, and are a little crooked, the one towards the right, and the other towards the left, representing the figure of an *o* horizontally placed. See **WEAVING**.

SIALOGOGUES, medicines which promote the urinary discharge.

SIAM PROPER, by some called *Upper*, (to distinguish it from the *Lower* Siam, under which are often included Laos, Cambodia, and Malacca), is bounded on the north by the kingdoms of Pegu and Laos; on the east by Cambodia and Cochinchina; on the south by Malacca and the bay of Siam; and on the west by the ocean. But as the opinions of geographers are extremely various concerning the situation and extent of most of the inland countries of Asia and Africa, neither the extent nor boundaries of Siam are yet accurately known. By some it is supposed to extend 550 miles in length, and 250 miles in breadth; in some places it is not above 50 miles broad.

The winds blow here from the south upon the coast of Siam, in March, April, and May; in April the rains begin, in May and June they fall almost without ceasing. In July, August, and September, the winds blow from the west, and the rains continuing, the rivers overflow their banks nine or ten miles on each side, and for more than 150 miles up the stream. At this time, and more particularly in July, the tides are so strong as to come up the river Menan as far as the city of Siam, which is situated 60 miles from its mouth; and sometimes as far as Louvo, which is 50 miles higher. The winds blow from the west and north in October, when the rain ceases. In November and December the winds blow dry from the north, and the waters being in a few days reduced to their ancient channels, the tides become so insensible, that the water is fresh at the mouth of the river. At Siam there is never more than one flood and one ebb in the space of 24 hours. In January the wind blows from the east, and in February from the east and south. When the wind is at east,

Shrub
R
Siam.Boundaries
and extent.

Weather.

Siam. the current sets to the west; and, on the contrary, when the wind is at west, the currents run to the eastward.

As this country is situated near the tropic, it must necessarily be very hot; but yet, as in other places nearly of the same latitude, when the sun is vertical and shines with a most intense heat, the inhabitants are so screened by the clouds, and the air is so restrained by a deluge of rain that overflows the plains which the people chiefly inhabit, that the heat is very supportable. The coolest wind blows in December and January.

3
Vegetable
productions.

The vegetable produce of this country is chiefly rice and wheat, besides tropical and a few European fruits. The Siamese prepare the land for tillage as soon as the earth is sufficiently moistened by the floods. They plant their rice before the waters rise to any considerable height, and, as they rise slowly, the rice keeps pace with them, and the ear is always above the water. They reap their corn when the water retires, and sometimes go in boats to cut it while the waters are upon the ground. They also sow rice in several parts of the kingdom that are not overflowed, and this is thought better tasted, and will keep longer than the other; but they are forced to supply these fields constantly with water, while the rice is growing, from basins and ponds that lie about them.

They have no European fruits except oranges, lemons, citrons, and pomegranates. They have bananas, Indian figs, jacks, durions, mangoes, mangodans, tamarinds, ananas, and cocoa nuts; they have also abundance of pepper and sugar-canes. The mountains are covered with trees which make good malls. The vegetable of greatest use in the country is the bamboo, which grows chiefly in marshy soils, and is often found of a prodigious size. Cotton trees are found in great numbers; and others that yield *casse*, a very fine cotton wool, but so short as to be unfit for spinning, though it answers very well for stuffing mattresses and pillows.

4
Animals.

There is no country where elephants abound more than in Siam, or where they are held in greater veneration. They have a few horses, sheep, and goats, besides oxen and buffaloes; but they have no good animal food except the flesh of hogs, their beef and mutton being of a very indifferent quality.

5
Description
of the inhabi-
tants.

The Siamese are of small stature, but well proportioned; their complexions are swarthy: the faces of both the men and women are broad, and their foreheads, suddenly contracting, terminate in a point, as well as their chins. They have small black eyes, hollow jaws, large mouths, and thick pale lips. Their teeth are dyed black, their noses are short and round at the end, and they have large ears, which they think very beautiful. Their hair is thick and lank, and both sexes cut it so short that it reaches no lower than their ears; the women make it stand up on their foreheads; and the men shave their beards.

6
Dress.

People of distinction wear a piece of calico tied about their loins, that reaches down to their knees. — The men bring up this cloth between their legs, and tuck it into their girdles, which gives it the appearance of a pair of breeches. They have also a muslin shirt without a collar, with wide sleeves, no wristsbands, and the bosom open. In winter they wear a piece of stuff or painted

linen over their shoulders, like a mantle, and wind it about their arms.

Siam.

The king of Siam is distinguished by wearing a vest of broadened satin, with straight sleeves that reach down to the wrist, under such a shirt as we have just described, and it is unlawful for any subject to wear this dress unless he receives it from the king. They wear slippers with piked toes turned up, but no stockings. The king sometimes presents a military vest to the generals; this is buttoned before, and reaches to the knees; but the sleeves are wide, and come no lower than the elbows. All the retinue of the king, either in war or in hunting, are clothed in red. The king wears a cap in the form of a sugar-loaf, encompassed by a coronet or circle of precious stones, and those of his officers have a circle of gold, silver, or of vermilion gilt, to distinguish their quality; and these caps are fastened with a stay under the chin; they are only worn when they are in the king's presence, or when they preside in courts of justice, and on other extraordinary occasions. They have also hats for travelling; but, in general, few people cover their heads notwithstanding the scorching heat of the sun.

The women also wrap a cloth about their middle, which hangs down to the calf of their legs. They cover their breasts with another cloth, the ends of which hang over their shoulders. But they have no garment corresponding to a skirt, nor any covering for their heads but their hair. The common people are almost naked, and wear neither shoes nor slippers. The women wear as many rings on the three last fingers of each hand as they can keep on, and bracelets upon their wrists and ancles, with pendants in their ears shaped like a pear.

For an inferior to stand before a superior is deemed ⁷in-
sultent; and therefore slaves and people of inferior <sup>and un-
honourable.</sup> rank sit upon their heels, with their heads a little inclined, and their joined hands lifted up to their foreheads. In passing by a superior they bend their bodies, joining their hands, and lifting them toward their heads in proportion to the respect they would show. When an inferior pays a visit, he enters the room flooping, prostrates himself, and then remains upon his knees, sitting upon his heels without speaking a word till he is addressed by the person whom he visits; for he that is of the highest quality must always speak first. If a person of rank visits an inferior, he walks upright, and the master of the house receives him at the door, and waits on him so far when he goes away, but never farther.

The highest part of the house is esteemed the most honourable, and no person cares to lodge under another's feet. The Siamese indeed have but one story, but the rooms rise gradually, and the innermost, which are the highest, are always the most honourable. When the Siamese ambassador came to the French court, some of his retinue were lodged in a floor over the ambassador's head; but they no sooner knew it, than they were struck with the greatest consternation, and ran down tearing their hair at the thoughts of being guilty of what they considered as no unpardonable a crime.

The Siamese never permit such familiarities as are practised by gentlemen in Europe. ⁸Etiquette of acce-
and

and affability to inferiors, is in that part of the world thought a sign of weakness, and yet they take no notice of some things which would be looked upon as ill breeding among us; such as belching in company, which no man endeavours to prevent, or so much as holds his hand before his mouth. They have an extraordinary respect for the head, and it is the greatest affront to stroke or touch that of another person; nay, their cap must not be used with too much familiarity; for when a servant carries it, it is put on a stick and held above his head; and when the master stands fill the stick is set down, it having a foot to stand upon. They also show their respect by lifting their hands to the head; and therefore, when they receive a letter from any one for whom they have a great respect, they immediately hold it up to their heads, and sometimes lay it upon their heads.

They are esteemed an ingenious people, and though rather indolent than active in disposition, they are not addicted to the voluptuous vices which often accompany a state of ease, being remarkably chaste and temperate, and even holding drunkenness in abhorrence.— They are, however, accounted insolent towards their inferiors, and equally obsequious to those above them; the latter of which quality appears to be particularly inculcated from their earliest youth. In general, their behaviour is extremely modest, and they are averse to loquacity. Like the Chinese, they avoid speaking in the first person: and when they address a lady, it is always with some respectful epithet, insinuating personal accomplishments.

No man in this country learns any particular trade, but has a general knowledge of all that are commonly practised, and every one works six months for the king by rotation; at which time, if he should be found perfectly ignorant of the business he is set about, he is doomed to suffer the bastinado. The consequence of this burdensome service is, that no man endeavours to excel in his business, lest he should be obliged to practise it as long as he lives for the benefit of the crown.

The government of this country is extremely oppressive, the king being not only sovereign but proprietor of all the lands, and chief merchant likewise; by which means he monopolizes almost the whole traffic, to the great prejudice of his subjects. The crown is said to be hereditary, but it is often transferred by revolutions, on account of the exorbitant abuse of power in those who exercise the royal office. In his palace, the king is attended by women, who not only prepare his food, and wait on him at table, but even perform the part of valets, and put on all his clothes, except his cap, which is considered as too sacred to be touched by any hand but his own. He thows himself to the people only twice a-year, when he distributes his alms to the talapots or priests: and on those occasions he always appears in an elevated situation, or mounted on the back of an elephant. When he takes the diversion of hunting, he is as usual attended by his women on foot, preceded by a guard of 200 men, who drive all the people from the roads through which they are to pass; and when the king stops, all his attendants fall upon their faces on the ground.

All their proceedings in law are committed to writing, and none is suffered to exhibit a charge against

another, without giving security to prosecute it, and answer the damages if he does not prove the fact against the person accused. When a person intends to prosecute another, he draws up a petition, in which he sets forth his complaint, and presents it to the *nai*, or head of the band to which he belongs, who transmits it to the governor; and if the complaint appears frivolous, the prosecutor, according to the laws of the country, should be punished; but the magistrates generally encourage prosecutions on account of the perquisites they bring to their office.

Every thing being prepared for hearing, the parties are several days called into court, and persuaded to agree; but this appears to be only a matter of form. At length the governor appoints a day for all parties to attend; and being come into court, the clerk reads the process and opinion of his associates, and then the governor examines upon what reasons their opinions are founded; which being explained to him, he proceeds to pass judgement.

When sufficient proofs are wanting, they have recourse to an ordeal trial, like that of our Saxon ancestors: both the plaintiff and the defendant walk upon burning coals, and he that escapes unhurt is adjudged to be in the right: sometimes the proof is made by putting their hands in boiling oil; and in both these trials, by some peculiar management, one or the other is said to remain unhurt. They have also a proof by water, in which he who remains longest under it is esteemed innocent. They have another proof, by swallowing pills, which their priests administer with severe imprecations; and the party who keeps them in his stomach without vomiting is thought to be innocent.

All these trials are made in the presence of the magistrates and people; and the king himself frequently directs them to be performed, when crime comes before him by way of appeal. Sometimes he orders both the informer and prisoner to be thrown to the tigers: and the person that escapes by his not being seized upon by those beasts, is sufficiently justified.

They maintain the doctrine of transmigration, believing in a pre-existent state, and that they shall pass into other bodies till they are sufficiently purified to be received into paradise. They believe likewise that the soul is material, but not subject to the touch; that it retains the human figure after quitting a body of that species; and that when it appears to persons with whom it was acquainted, which they suppose it to do, the wounds of one that has been murdered will then be visible. They are of opinion that no man will be eternally punished; that the good, after several transmigrations, will enjoy perpetual happiness; but that those who are not reformed will be doomed to transmigration to all eternity. They believe in the existence of a Supreme Being; but the objects of their adoration are departed saints, whom they consider as mediators or intercessors for them; and to the honour of this numerous tribe both temples and images are erected.

The men of this country are allowed a plurality of women; but excepting one, who is a wife by contract, the others are only concubines, and their children deemed incapable of any legal inheritance. Previous to every nuptial contract, an astrologer must be consulted, who calculates the nativity of the parties, and determines whether their union is likely to prove fortunate

Siam
||
Siberico.

or otherwise. When his prognostication is favourable, the lover is permitted to visit his mistress three times, at the last of which interviews the relations being present, the marriage portion is paid, when, without any religious ceremony performed, the nuptials are reckoned complete, and soon after consummated. A few days after the talapoin visits the married couple, sprinkles them with water, and repeats a prayer for their prosperity.

14
Funerals.

The practice in Siam respecting funerals, is both to burn and bury the dead. The corpse being laid upon the pile, it is suffered to burn till a considerable part is consumed, when the remainder is interred in a burying-place contiguous to some temple. The reason which they give for not burning it entirely to ashes is, that they suppose the deceased to be happy when part of his remains escapes the fire. Instead of a tombstone, they erect a pyramid over the grave. It was formerly the custom to bury treasure with the corpse; but longer experience evincing, that the sacrilegious light in which robbing the graves was considered did not prevent the crime, they now discontinue the ancient practice, and instead of treasure bury only painted papers and other trifles.

15
Rivers.

The two principal rivers are the Menan and the Mecon, which rise in the mountains of Factory, and run to the south; the former passing by the city of Siam, falls into the bay of the same name, in the 13th degree of north latitude; and the latter running through Laos and Cambodia, discharges itself into the Indian ocean in the 9th degree of north latitude.

6
Description
of the
capital.

The capital of the country is Siam, called by the natives *Sijp-hoya*, situated in the 12th degree of east longitude, and in the 15th degree of north latitude, being almost encompassed by the branches of the river Menan. It is about 10 miles in circumference within the walls, but not a sixth part of the ground is occupied by buildings. In the vacant spaces there are near 300 pagodas or temples, round which are scattered the convents of the priests and their burying-places. The streets of the city are spacious, and some have canals running through them, over which is a great number of bridges. The houses stand on pillars of the bamboo cane, and are built of the same materials; the communication between different families, during the winter season, being carried on as in other tropical countries by means of boats. The grounds belonging to the several temples are separated by a pallisado, within which the cattle are housed in barns, erected likewise upon pillars, to preserve them from the annual inundations.

SIBRALDIA, a genus of plants belonging to the class of pentandria, and to the order of pentogonia; and in the natural system arranged under the 25th order. *Sentiche*. See BOTANY Index.

SIBENICO, or SIMUNICO, the name of a city and province of Dalmatia. The province of Sibenico runs along the sea for more than 50 miles; reaches in some places above 20 miles within land, and comprehends above 70 islands. The city of Sibenico is situated near the mouth of the river Civera, in the gulf of Venice, 25 miles north of Sebenico, and 25 south-east of Zara. E. Long. 16° 46'. N. Lat. 44° 17'. It belongs to the Venetians. It is defended on one side by a castle, which held out against repeated attacks of the Turks, and towards the sea by a fort.

VOL. XIX. Part I.

SIBERIA, a large country, comprehending the most northerly parts of the Russian empire in Asia. It is bounded on the east by the eastern ocean; on the south by Great Tartary; on the west by Russia; and on the north by the Frozen ocean. It is about 2000 miles in length from east to west, and 750 miles in breadth from north to south.

Siberia
||
Pre. Part
||
Ind. Cass. 1.

At what time this country was first inhabited, or by whom it was peopled, we are entirely ignorant; but writings have been found in it when it was discovered, which shows that it must have been early known to a civilized people. The Russians, from whom we received our knowledge, knew nothing of it before the middle of the 16th century. In the reign of John Basilowitz I. indeed, an incursion had been made into Siberia, and some Tartar tribes subdued; but these conquests were not permanent; and we hear of no further communication between Russia and Siberia till the time of John Basilowitz II. It was opened again at that time by means of one Anika Strogoff, a Russian merchant, who had established some last-works at a town in the government of Archangel. This man carried on a trade with the inhabitants of the north-west parts of Siberia, who brought every year to the town above-mentioned large quantities of the finest furs. Thus he acquired a very considerable fortune in a short time; when at last the czar, perceiving the advantages which would accrue to his subjects from having a regular intercourse with Siberia, determined to enlarge the communication which was already opened. With this view he sent into Siberia a body of troops, which crossed the Yngorum mountains, that form a part of the north-eastern boundary of Europe. They seem, however, not to have passed the Irtich, or to have penetrated farther than the western branch of the river Obi. Some Tartar tribes were laid under contribution, and a chief named *Tengiz* consented to pay an annual tribute of 1000 fables. But this produced no lasting advantage to Russia; for, soon after, *Yuliger* was defeated and taken prisoner by *Kutchum Khan*, a descendant of the great *Jochiz Khan*; and thus the allegiance of this country to Russia was dissolved.

For some time we hear of no further attempts made by the Russians on Siberia; but in 1577 the foundation of a permanent conquest was laid by one *Yermak Temowich*, a Cossack of the Don. This man was at first the head of a party of hardihood who incited the Russians in the province of *Cafan*; but being defeated by the troops of the czar, he retired with 6000 of his followers into the interior parts of that province. Continuing his course till eastward, he came to *Orel*, the most easterly of all the Russian settlements. Here he took up his winter-quarters; but his restless genius did not suffer him to continue for any length of time in a state of inactivity; and from the intelligence he procured concerning the situation of the neighbouring Tartars of Siberia, he turned his arms towards that quarter.

Siberia was at that time partly divided among a number of separate princes, and partly inhabited by various tribes of independent Tartars. Of the former *Kutchum Khan* was the most powerful sovereign. His dominions consisted of that tract of country which now comprehends the south-western part of the province of *Tebolsk*; and stretched from the banks of the *Irtich* and *Obi* to those

T t those

these of the Tobol and Tora. His principal residence was at Sibir, a small fortress upon the river Irtysh, not far from the present town of Tobolsk, and of which some ruins are still to be seen. After a course of unremitted fatigue, and a series of victories which almost exceed belief, but of which we have not room to give the detail, our intrepid adventurer dispossessed this prince of his dominions, and seated himself on the throne of Sibir. The number of his followers, however, being greatly reduced, and perceiving he could not depend on the affection of his new subjects, he had recourse to the czar of Muscovy, and made a tender of his new acquisitions to that monarch, upon condition of receiving immediate and effectual support. This proposal was received with the greatest satisfaction by the czar, who granted him a pardon for all former offences, and sent him the required succours. Yermac, however, being soon after drowned

in an unsuccessful excursion, the Russians began to lose their footing in the country. But fresh reinforcements being seasonably sent, they not only recovered their ground, but pushed their conquests far and wide; wherever they appeared, the Tartars were either reduced or exterminated. New towns were built, and colonies were planted on all sides. Before a century had well elapsed, all that vast tract of country now called *Siberia*, which stretches from the confines of Europe to the Eastern ocean, and from the Frozen sea to the present frontiers of China, was annexed to the Russian dominions.

The air of Siberia is, in general, extremely piercing, ⁴Climate. the cold there being more severe than in any other part of the Russian dominions. The Siberian rivers are frozen very early, and it is late in the spring before the ice is thawed (A). If the corn does not ripen in August, there is little hope of a harvest in this country; and in the

(A) M. Gmelin, M. Muller, and two other philosophers, set out in the year 1733 to explore the dreary regions of Siberia, by desire of the empress Anne of Russia. After spending nine years and a half in observing every thing that was remarkable, they returned to Petersburg; and an account of this journey was published by M. Gmelin. In order to examine how far the frost had penetrated into the ground, M. Gmelin, on the 18th of June, at a place called Jacutia, ordered the earth to be dug in high ground; they found mould to the depth of 11 inches, under which they met with loose sand to two feet and a half further, after which it grew harder, and at half a foot deeper so hard as scarcely to give way to the tools; so that the ground still remained unthawed at not less than the depth of four feet. He made the same experiment in a lower situation; the soil was 15 inches deep, after that a loose sand for two feet and ten inches, below which all was frozen and hard. At Jacutia the inhabitants preserve in cellars several sorts of berries, which they reckon among their dainties, perfectly good and fresh the whole year, though these cellars are scarcely a fathom deep. At the fortress of Argun, in little more than 30 degrees of latitude, the inhabitants relate that the earth in many places is never thawed above a yard and a half, and that the internal cold of the earth will scarcely permit a well to be dug, of which they bring an instance that happened not long before the author's arrival at that place. They designed to sink a well near a house at some distance from the river Argun, for which purpose they thawed the earth by degrees, and dug some fathoms till they had penetrated a fathom and half below the level of the river, but found no spring. Hence perhaps we may venture to infer, that besides the great elevation of the earth in these countries, there is another cause, perhaps latent in the earth itself, of this extraordinary cold, naturally suggested to us by considering the cavity of an old silver mine at Argun, which being exhausted of its ore, now serves the inhabitants in summer time for a cellar to keep their provisions; this place is so extremely cold as to preserve fresh meats from putrefaction in the hottest summers, and to sink the mercury in De Lisle's thermometer to 126 and 147. The author travelling from Nerchinsk towards Argun, to visit the works of the silver mines in that place, August 1735, came to the river Orkha, near Solonichinsk, on July the 18, from whence he arrived a little before dark at the village of Serentua, distant from the river 27 leagues. In this journey he and his fellow travellers for more than four leagues felt it vailly cold; soon after they came into a warm air, which continued some leagues; after which the cold returned; and days and travellers subjected to perpetual vicissitudes of warmth and cold. But it is observed in general, that the eastern parts are colder than the western, though situated in the same latitude; for as in those eastern regions some tracts of land are much colder than the rest, their effects must be felt by the neighbouring parts. And this conjecture is supported by the thermometer observations made with M. de Lisle's instrument in all parts of Siberia, in which the mercury was depressed to the 226th degree, even in those parts that lie very much towards the south, as in the tract of Solonga, which said degree answers in Fahrenheit's thermometer to about 55.5 below 0, but the same thermometer sometimes indicated a much greater cold. At the fort of Kiringa, on Feb. 10, 1738, at 8 in the morning, the mercury stood at 240, which answers nearly to 72 below 0 in Fahrenheit's. On the 23d of the same month it was a degree lower. At the same place, December 31, at three in the afternoon, it stood at 254 in De Lisle's thermometer, and very near 90 in Fahrenheit's; on December 29, at four in the afternoon, at 263; on November 27, at noon, at 250; January 9, at 275, which several depressions answer in Fahrenheit's to 69.44, 117.75, and 113.63; on January 4, at five in the morning, at 262; an hour after at 251, but at eight o'clock it returned to 240, and there remained till six in the afternoon, and then rose 15 degrees till an hour before midnight, when it stood at 222. So that the greatest depression of the mercury answers in Fahrenheit's thermometer to 122.76 degrees below 0, which is indeed very surprising, and what nobody ever imagined before. While this cold lasted at Jeniska, the sparrows and magpies fell to the ground, froze dead, as it were, with the frost, but revived if they were soon brought into a warm room. The reader will also take notice that numbers of wild birds were found in the woods dead and stiff with the frost, and several travellers had their blood and juices quite frozen in their vessels. The air itself at that time was so solid, that you would think it charged to ice, as it was a thick fog, which was not dissipated by any exhalations, as in the spring and summer, and the author could scarcely stand three minutes in the porch of his house for the cold.

the province of Irkutsk. It is sometimes covered with snow before the peasants can reap it. To defend the inhabitants against this excessive severity of the climate, Providence has more liberally to give assistance to them, and for that purpose has obliged. As the winters in the north parts of Siberia last but a few hours, and the storms and dews of those parts are the air so much, that the inhabitants, even in those countries to do any thing without artificial lights, they sleep away the greater part of that season.

These severe winters are rapidly succeeded by Summers, in which the heat is so intense that the Tartars, who live in the province of Jakutsk, go almost naked. Here is scarcely any night during that season; and towards the Frozen ocean the sun appears only slightly above the horizon. The vegetables and fruits of the earth are here extremely quick in their growth.

The whole tract of land beyond the 60th degree of north latitude is a barren waste; for the north part of Siberia yields not her corn nor fruits; though barley is known frequently to come to perfection in Jakutsk. For this reason, the inhabitants of the southern parts are obliged to live on fish and fish, but the Russians are supplied with corn from the southern parts of Siberia, where the soil is surprisingly fertile. The countries beyond the Lake of Biala, especially towards the east, as far as the river Argun, are remarkably fruitful and pleasant; but such is the indolence of the inhabitants, that several fine tracts of land, which would make ample returns to the peasant for cultivating them, lie neglected. The pastures are excellent in this country, which abounds in fine horned cattle, horses, goats, &c. on which the Tartars chiefly depend for subsistence. However, there are several sheeps, or barren woles, and unimpeachable tracks in these parts; and not a single fruit tree is to be seen. There is great variety of vegetables, and in several places, particularly near Kraïnoi Sloboda, the ground is in a manner overran with asparagus of an extraordinary height and delicious flavour. The bulbs of the Turkish brodia, and other sorts of lilies, are much used by the Tartars instead of bread. This want of fruit and corn is richly compensated by the great quantities of wild and tame birds, and fowls, and the infinite variety of fine fish which the country affords (p).

In that part of Siberia which lies near the Icy sea, as well as in several other places, are woods of pine, larch, and other trees; besides which, a considerable quantity of wood is thrown ashore by the waves of the Icy sea; but whence it comes is not yet ascertained.

Besides the wild fowl with which Siberia abounds, there is a prodigious number of quail, ducks, some of

which are eatable, and others valuable for their skins or feathers.

The most valued for their skins are the black fox, the white, the byson, the ermine, the squirrel, the beaver, and the musk. The skin of a real black fox is more valued than even that of a table. In the country near the Frozen ocean are also blue and white furs. The black fables come from Nertchinsk, and Jakutsk, the inhabitants of which places catch them in the mountains of Stannowod Khabut. The tributary nations were formerly obliged to pay their taxes in the skins of foxes and fables only. But now the skins of squirrels, bears, reindeer, &c. and sometimes money, are received by way of tribute; and this not only from those who live near the Lena, but also in the governments of Irkutsk, Irkutsk, Selenginsk, and Nertchinsk. When the Tartars first became tributary to Russia, they brought their furs indiscriminately as they caught them, and among them were often fables of extraordinary value; and formerly, if any trader brought with him an iron kettle, they gave him in exchange for it as many fables as it would hold. But they are now better acquainted with their value. They sell their fables to smugglers at a very high price, and pay only a rouble instead of a skin to the revenue officers, who now receive more ready in any than fables, by way of tribute. The fables seldom the scarcity of furs, and indeed not without some appearance of trade.

Siberia has still other and more valuable treasures than those we have yet mentioned. The river mines of Argun are extremely rich; the silver they produce yields some gold, and both of these are found among the copper ore or Kollum. This country is also particularly rich in copper and iron ore. The former lies even upon the surface of the earth; and considerable mines of it are found in the mountains of Kollum, Kollum, Fiofkan, Wulkereienk, Kizwi, Alepauk, and several others, and in the government of Krotchinsk (q). It is still more plentiful in all these places, and very good; but that of Kamensk is reckoned the best. Several hundred thousand puds of these metals are annually exported from the smelting houses, which belong partly to the crown, and partly to private persons. Most of them are in the government of Catharinenburg. The Tartars also extract a great quantity of iron from the ore.

Two topazes of Siberia have a fine lustre, and in open sandy places, near the river Argun, as well as on the banks of other rivers and lakes, are found single small pieces of agate. Here are also emeralds and green jasper with red veins. The latter is chiefly met with in the deserts of Oymyak.

The famous amethysts, or lapis speciosus, great quantities of

(p) The oak, though frequent in Russia, it is said, is not to be found through this vast region nearer than the banks of the Argun and Amur, in the dominions of China. The white wood, the ash, the black poplar, the common alder, and several species of the willow, are very common. The Norway and silver fir form great forests; but the former does not grow beyond the sixth degree of north latitude, and the latter not beyond 48 degrees. To this dry region of Siberia, Europe is indebted for the excellent species of oats called *avena sibirica*; and our gardens are enriched with the gay and brilliant flowers brought from the same country.

(q) The copper mines of Kollum, from which gold and silver are extracted, employ above 20,000 people. The silver mines of Nertchinsk, beyond Lake Biala, employ above 10,000 more. The whole amount of silver from the mines, according to Mr. Coxe, is not less than 600,000 lb. (1781).

quantities of which are dug up in Siberia, is by some called *McCoy* or *Ruffian glass*. It is a particular species of transparent stone, lying in Brita like so many sheets of paper. The matrix, or stone in which it is found, is partly a light yellow quartz, or marcella, and partly a brown indurated shaly, and this stone contains in it all the species of the marignolite. To render the marignolite fit for use, it is split with a thin two-edged knife; but care is taken that the laminae be not too thin. It is used for windows and lanterns all over Siberia, and indeed in every part of the Russian empire, and looks very beautiful; its lustre and clearness surpassing that of the finest glass, to which it is particularly preferable for windows and lanterns of ships, as it will stand the explosion of cannon. It is found in the greatest plenty near the river *Witim*.

Siberia affords magnets of an extraordinary size, and even whole mountains of loadstone. Pit-coal is also dug up in the northern parts of this country. The *kaunnoe* marble, a yellowish kind of alaba, unctuous and smooth to the touch, like topaz, is found in the mountains of *Krasnoiarisk*, *Ural*, *Altaihu*, *Jeniska*, *Baikal*, *Barguk*, *Lena*, and several others in Siberia.

In this country are not only a great number of fresh water lakes, but likewise several whose waters are salt; and these reciprocally change their nature, the salt sometimes becoming fresh, and the fresh changing into saline. Some lakes also dry up, and others appear where none were ever seen before. The salt lake of *Yamula*, in the province of *Tobolsk*, is the most remarkable of all, for it contains a salt as white as snow, consisting entirely of cubic crystals. One finds also in Siberia saline springs, salt water brooks, and a hill of salt.

Siberia affords many other things which deserve notice. That useful root called *rubarb* grows in vast quantities near the city of *Selgidisk*. The curious *mammuth's* bones and horns, as they are called, which are found along the banks of the *Oby*, *Jeniska*, *Lena*, and *Irtsch*, are unquestionably the teeth and bones of elephants. But whether these elephants teeth and bones were conveyed to these northern regions by the general deluge, or by any other inundation, and were by degrees covered with earth, is a point which might lead us into long and very fruitless disquisitions; we shall therefore only observe, that such bones have likewise been found in Russia, and even in several parts of Germany. A kind of bones of a still larger size than these have also been dug up in Siberia, and seem to have belonged to an animal of the ox kind. The horn of the whale called *narwhal* has been found in the earth near the rivers *Indigiska* and *Anadir*; and the teeth of another species of whales, called *walrofs*, about *Anadiriskoi*. The latter are larger than the common sort, which are brought from *Greenland*, *Archangel*, and *Kola*.

The chain of Siberian mountains reaches from that of *Werchoturie* towards the south as far as the neighbourhood of the city of *Oienburg*, in a continued ridge, under the name of the *Uralian* mountains; but from thence it alters its direction westward. These mountains are a kind of boundary between *Russia* Proper and *Siberia*. Another chain of hills divides *Siberia* from the country of the *Cabaucks* and *Mongolians*.—These mountains, between the rivers *Irtsch* and *Oby*, are called the *Altaic* or *Golden* Mountains, which name they afterwards lose, particularly between the river *Jeniska* and

the *Baikal* lake, where they are called the *Sayanian* mountains.

The inhabitants of Siberia consist of the *Aborigines* or ancient inhabitants, the *Tatars*, and *Russians*, computed at 3,500,000.

Some of these nations have no other religion but that of nature; others are *Pagans* or *Mahometans*, and some of them have been converted to *Christianity*, or rather only baptized by the *Russian* missionaries.

SIBTHORPIA, a genus of plants belonging to the class of *didynamia*, and to the order of *angiosperma*; and in the natural system classed with those the order of which is doubtful. See *Botany Index*.

SIBYLS, in pagan antiquity, certain women said to have been endowed with a prophetic spirit, and to have delivered oracles, showing the fates and revolutions of kingdoms. Their number is unknown. *Plato* speaks of *seven*, others of two, *Pliny* of three, *Aelian* of four, and *Varro* of ten; an opinion which is universally adopted by the learned. These ten Sibyls generally resided in the following places, *Perisa*, *Lilya*, *Delphi*, *Cume* in *Italy*, *Erythrae*, *Samos*, *Cume* in *Æolia*, *Marseffa* on the *Hellepont*, *Anycra* in *Phrygia*, and *Tiburis*. The most celebrated of the Sibyls is that of *Cume* in *Italy*, whom some have called by the different names of *Amalthæa*, *Demiphile*, *Herophile*, *Daphne*, *Manto*, *Phemonoe*, and *Deiphobe*. It is said, that *Apollo* became enamoured of her, and that to make her sensible of his passion he offered to give her whatever she should ask. The Sibyl demanded to live as many years as she had grains of sand in her hand, but unfortunately forgot to ask for the enjoyment of the health, vigour, and bloom, of which she was then in possession. The god granted her request, but she refused to gratify the passion of her lover though he offered her perpetual youth and beauty. Some time after she became old and decrepit, her form decayed, melancholy paleness and haggard looks succeeded to bloom and cheerfulness. She had already lived about 700 years when *Æneas* came to *Italy*, and, as some have imagined, she had three centuries more to live before her years were as numerous as the grains of sand which she had in her hand. She gave *Æneas* instructions how to find his father in the infernal regions, and even conducted him to the entrance of hell. It was usual for the Sibyl to write her prophecies on leaves, which she placed at the entrance of her cave; and it required particular care in such as consulted her to take up these leaves before they were dispersed by the wind, as their meaning then became incomprehensible. According to the most authentic historians of the *Roman* republic, one of the Sibyls came to the palace of *Tarquín* the Second, with nine volumes, which she offered to sell for a very high price. The monarch disregarded her, and she immediately disappeared, and soon after returned, when she had burned three of the volumes. She asked the same price for the remaining six books; and when *Tarquín* refused to buy them, she burned three more, and still persisted in demanding the same sum of money for the three that were left.—This extraordinary behaviour astonished *Tarquín*; he bought the books, and the Sibyl instantly vanished, and never after appeared to the world. These books were preserved with great care by the monarch, and called the *Sibylline* verses. A college of priests was appointed to have the care of them; and such reverence did the

Siberia
Sibyls
14
Inhabitants.

10
Magnets.

11
Salt lake
and spring.

12
Corn of S.

13
Mountains.

Sibyls
||
Sicily.

Romans entertain for these prophetic books, that they were consulted with the greatest solemnity, and only when the state seemed to be in danger. When the Capitol was burnt in the troubles of Sylla, the Sibylline verses which were deposited there perished in the conflagration; and to repair the loss which the republic found it to have sustained, commissioners were immediately sent to different parts of Greece to collect whatever verses could be found of the inspired writings of the Sibyls. The fate of these Sibylline verses which were collected after the conflagration of the Capitol is unknown. There are now many Sibylline verses extant, but they are reckoned universally spurious; and it is evident that they were composed in the second century by some of the followers of Christianity, who wished to convince the heathens of their error, by adding the cause of truth with the arms of pious artifice.

SICERA, a name given to any including liquor by the Hellenic Jews. St Chrysostom, Theodoret, and Theophilus of Antioch, who were Syrians, and who therefore ought to know the signification and nature of "sicers," assure us, that it properly signifies palm-wine. Pliny acknowledges, that the wine of the palm tree was very well known through all the east, and that it was made by taking a bath of the dots of the palm-tree, and throwing them into three gallons of water; then squeezing out the juice, it would intoxicate like wine. The wine of the palm tree is white; when it is drunk new, it has the taste of the cocoa, and is sweet as honey. When it is kept longer, it grows stronger, and intoxicates. After long keeping, it becomes vinegar.

SICILIAN, in *Music*, denotes a kind of gay sprightly air, or dance, probably invented in Sicily, some what of the nature of an English jig; usually marked with the characters $\frac{6}{8}$, or $\frac{12}{8}$. It consists of two strains; the first of four, and the second of eight, bars or measures.

SICILY, is a large island in the Mediterranean sea, adjoining to the southern extremity of Italy, and extends from latitude $36^{\circ} 23'$ to latitude $38^{\circ} 23'$, and from longitude $12^{\circ} 51'$ to longitude $16^{\circ} 5'$ east from London. Its greatest length 240 miles, breadth 124, circumference 622; its form triangular, the three angles being the promontories of Pelorus, Pachynum, and Lilibeum, or as they are now called the Faro, Capo Passaro, and Capo Boeo. It is divided from Italy by the straits of Messina, running from the Tower of Faro, which is the most northerly part of the island, to the *Capo dell' Orto*, or the Cape of Orto, the most southern part of Calabria. These straits, by the Latins called *Fretum Siculum*, by the Italians *I. Faro di Messina*, and by us the *Faro di Messina*, are between 12 and 15 miles over in the broadest place, and in the narrowest about a mile and an half; so north that when Messina was taken by the Christians, many of the inhabitants are said to have fled themselves by swimming to the opposite coast of Italy. Hence has arisen an opinion that the island of Sicily was originally joined to the continent, but afterwards, raised by an earthquake or some other natural cause. This tradition, however, is rejected by the most judicious among the ancients to be fabulous; and they conceive the straits with speaking of as a natural effect to have been so.

Antiently this island was called *Sicania*, *Sicilia*, and *Trinacria* or *Triglyssa*; the two former it had from the

Sicani and Siculi, who peopled a considerable part of the country; the two latter from its triangular figure. Its first inhabitants, according to the most respectable ancient authors, were the Cyclopes and Leucigones, who are said to have dwelt in the country adjoining to Messina; but of their origin we know nothing, except what is related by the poets. After them came the Sicani, who called themselves the original inhabitants of the country; but several ancient historians inform us that they came from a country in Spain watered by the river Siconus. Diakorus, however, is of opinion, that the Sicani were the most ancient inhabitants of this island. He tells us that they were in possession of the whole, and applied themselves to cultivate and improve the ground in the neighbourhood of Etna, which was the most fruitful part of the island; they built several small towns and villages on the hills to secure themselves against thieves and robbers; and were governed, not by one prince, but each city and district by its own king. Thus they lived till Etna began to throw out flames, and forced them to retire to the western parts of the island, which they continued to inhabit in the time of Theucydides. Some Trojans, after the destruction of their city, landed in the island, settled among the Sicani, and built the cities of Iryx and Egesta, uniting themselves with them, and taking the general name of Elymi or Elymaei. They were afterwards joined by Iome Phocæens, who settled here on their return from the siege of Troy.

After the Sicani had for many ages enjoyed an undisturbed possession of the whole of Sicily, or such parts of it as they chose to inhabit, they were visited by the Siculi, who were the ancient inhabitants of Antonia properly so called; but being driven out from thence by the Orici, they took refuge in the island of Sicily. Not being contented with the narrow bounds allowed them by the Sicani, they began to encroach upon their neighbours; upon which a war ensuing, the Sicani were utterly defeated, and confined to a corner of the island, the name of which was now changed from *Sicania* into that of *Sicilia*.

About 320 years after the arrival of the Siculi, the island first began to be known to the Greeks, who established various colonies, and built many cities in different parts of the island; and it is only from the time of their arrival that we have any history of the island. The first of the Greeks that came into Sicily were the Cæcidians of Eubœa, under the conduct of Thucles, who built Naxos, and a famous altar of Apollo, which, as Theucydides tells us, was still standing in his time without the city. The year after, which was, according to Dionysius Halicarnassensis, the third of the 17th Olympiad, Archias the Corinthian, one of the Heraclides, laid the foundations of Syracuse. Seven years after, a new colony of Chalcidians founded Leontini and Catania, after having driven out the Siculi, who inhabited that tract. About the same time Lamis, with a colony from Megara, a place of Achæa, settled on the river Pantalun, at a place called *Trinacria*, where his ventures lived some time in common with the Chalcidians of Leontini; but, being driven from thence by the Lemnians, he built the city of Thapsus, where he died. Upon his death, the colony left Thapsus; and under the conduct of Hylton king of the Siculi, founded Megara Hyblæa, where they resided 245 years. G^o
the

Sicily.

I
Bour-bories
and extent.3
H.aly da-
ring the 12-
bious
862.

they were driven out by Gelon tyrant of Syracuse. During their abode at Megara, they sent one Parvilius, who was come from Megara in Sicilia, their original city, to build Salinus. This city was founded about 125 years after the foundation of Megara. Antiphanes and Estianus, the former a Megarian, the other a Cretan, led each a colony of their countrymen, and jointly built the city of Gela on a river of the same name, establishing in their new settlement the Doric customs, about 45 years after the founding of Syracuse. The inhabitants of Gela founded Agrigentum 128 years after their arrival in Sicily, and introduced the same customs there. A few years after, Zanclus was built by the pirates of Cumæ in Italy; but chiefly peopled by the Chalcidians, Samians, and Ionians, who chose rather to seek new settlements than live under the Persian yoke. Some time after, Anaxales, tyrant of Rhegium, drove out the ancient proprietors; and, dividing his lands amongst his followers, called the city *Messana* or *Messina*, which was the name of his native city in Peloponnesus. The city of Himera was founded by the Zanclusians under the direction of Euclides, Sinus, and Sacon; but peopled by the Chalcidians and some Syracusean exiles, who had been driven out by the contrary faction.

The Syracuseus built Acrae, Chœnœne, and Cumarina; the first 72 years, the second 97, and the third 125, after the foundation of their own city. This is the account which Thucydides, a most judicious and exact writer, gives us of the various nations, whether Greeks or Barbarians, who settled in Sicily. Strabo counts among the ancient inhabitants of Sicily the Morgetes, who being driven out of Italy by the Oenotrians, settled in that part of the island where the ancient city of Morgantium stood. The Camæsi, who assumed the name of *Hamertini*, that is, *invidious warriors*, and the Carthaginians, who settled very early in Sicily, ought likewise to be counted among the ancient inhabitants of the island.

Before this period the history of Sicily is blended with fables like the early history of almost every other country. After the settlement of the Greeks in the island, its various revolutions have been traced from their several sources by many writers; but by none with greater accuracy than Mr Swinburne. From his account of his Travels in the Two Sicilies, we have therefore taken the following concise history of this kingdom, which will at once gratify each of our readers as interested themselves in the fate of a generous people who long struggled in vain for freedom; and at the same time afford them a foretaste of the entertainment they may receive from the very elegant work of the author.

Antiquity prevailed at first in the Greek settlements, but soon made way for tyranny; which in its turn was smothered by democracy. One of the earliest protectors of common liberty was Phalaris of Agrigentum, who reigned 620 years before Christ: his example was contagious; a legion of tyrants sprung up, and not a common wish in the island escaped the lash of an usurper. Syracuse was most oppressed and torn to shreds by a despot; as its wealth and preponderance in the general scale held out a greater temptation than other cities to the ambition of wicked men. It requires the combined testimony of historians to enforce our be-

lief of its wonderful prosperity, and the no less extraordinary tyranny of some of its sovereigns. These Grecian colonies attributed to such excellence in arts and sciences as emboldened them frequently to vie with the learned and ingenious in the mother country; nay, often enabled them to bear away the palm of victory: there needs no stronger proof of their literary merits than a bare recital of the names of Archimæus, Theocritus, Gorgias, and Chæronas.

But the Sicilian Greeks were not declined to enjoy the sweets of their situation without molestation. Very soon after their arrival, the inhabitants of the neighbouring coast of Africa began to aspire to a share of Sicily. Carthage sent large bodies of forces at different times to establish their power in the island, and about 520 years before the Christian era had made themselves masters of all the western parts of it. The Siculi retained possession of the midland country, and the southern and eust coast were inhabited by the Greeks.

About that time Gelo was chosen prince of Syracuse on account of his virtues, which grew still more conspicuous after his exaltation; had the example he set been followed by his successors, the advantages of freedom would never have been known or wished for by the Syracuseans. The Carthaginians found in him a vigorous opponent to their project of conquering Sicily, a project in vainly pursued but never accomplished.

Hiero succeeded his brother Gelo, and, contrary to the usual progression, began his reign by a display of bad qualities. Sensible of his error, and improved by experience, he afterwards adopted more equitable measures. At his death the Syracuseus threw off the yoke, and for sixty years revelled in all the joys of freedom. Their peace was, however, disturbed by the Athenians and the Carthaginians. The latter plundered Agrigentum, and threatened ruin to the rest of the Grecian states; but a treaty of peace averted that storm.

The Athenians, under pretence of supporting their allies the people of Segesta, but in reality from a thirst of dominion, invested Syracuse with a formidable land and naval armament under the command of Nicias; in consequence of a rash indirect plan, ill conducted attacks, and inadequate supplies, their whole host was cut to pieces or led away into captivity.

Syracuse had scarcely time to breathe after her victory ere intestine wars broke out, and raised Dionysius the elder to supreme command. Avarice, despotism, and cruelty, marked every day of his reign; but his military enterprises were crowned with constant success. He died in peace, and bequeathed a powerful sovereignty to a son of his name tainted with the same and worse vices, but not endowed with equal capacity and martial ability: in such hands the rod of tyranny could be formidable, and the tyrant was driven out of Sicily by the patriotic party; but matters were not sufficiently settled for popular government, and Dionysius resumed the sceptre for a while, till Timoleon forced him into perpetual exile.

Lisibry's power rose to be established on a permanent basis; but in Syracuse such prospects always proved ill-lucky. Antiochus, a tyrant more inhuman than any preceding usurper, seized the throne, and deluged the country with blood. He was involved in a perilous contest with the Carthaginians, who obtained many advantages

vantages over him, drove his troops from post to post, and at last blocked up his capital. In this desperate situation, when all foreign helps were precluded, and hardly a reinforce remained at home, the genius of Agathocles compelled his deliverance by a plan that was imitated among the ancients by Hannibal, and among the moderns by the famous Cortes. He embarked with the flower of his army; forced his way through insurmountable obstacles; landed in Africa; and, having burnt his fleet, routed the Carthaginians in a pitched battle, and laid their territory waste. Carthage seemed to be on the brink of ruin, and that hour might have marked her downfall had the Sicilian had been composed of patriotic soldiers, and not of ungovernable Africans; discord pervaded the victorious camp, murder and riot ensued; and the tyrant, after beholding his children and friends butchered before his face, escaped to Sicily, to meet a death as tragical as his crimes deserved.

Anarchy now reigned throughout the island, and every faction was reduced to the necessity of calling in the assistance of foreign powers; among whom Pyrrhus king of Epirus took the lead, and reduced all parties to some degree of order and obedience. But ambition soon prompted him to invade those rights which he came to defend; he called off the mask, and made Sicily feel under his sway as heavy a hand as that of its former oppressors; but the Sicilians soon assumed courage and strength enough to drive him out of the island.

About this period the Mamertini, whom Mr Spinnbarn indignantly styles a crew of mercenaries, furnished Messina, and, after a general massacre of the citizens, established a republican form of government. Their commonwealth became troublesome to the Greeks, that Hiero II. who had been raised to the chief command at Syracuse in consequence of his superior wisdom and warlike talents, found himself necessitated to form a league with Carthage, in order to drive this nest of villains. In their distress the Mamertini implored the assistance of Rome, though the Senate had recently punished with exemplary severity one of their own legions for a similar outrage committed at Rhegium. The virtue of the Romans gave way to the temptation, and the desire of extending their empire beyond the limits of Italy, called a veil over every other consideration attending this alliance. A Roman army crossed the Tiber, routed Messina, defeated the Carthaginians, and humbled Hiero into an ally of the republic.

Thus began the first Punic war, which was carried on for many years in Sicily with various success. The genius of Hamilcar Barca supported the African cause under numerous disadvantages, and the repeated offers of his colleagues at last, finding his exertions ineffectual, he advised the Carthagenians to purchase peace at the price of Sicily. Such a treaty was not likely to be observed longer than it might do the office of the stability of the empire; but when their vigour was relaxed, Hannibal, one of Hamilcar's family persuaded them to resume the contest, and for 16 years we witnessed the heat of the Roman territories. Meanwhile Hiero conducted himself with much moderation, that he retained the stability of both parties, and preserved the reputation of being the most illustrious of his country's monarches, beloved and respected at home and abroad.

Hiero's son Hieronymus, forsaking this happy line of politics, and contracting an alliance with Carthage, fell an early victim to the troubles which his own folly had excited. Once more, and for the last time, the Syracuseans found themselves in possession of their independence; but the times were no longer suited to such a system; dissensions gained head, and distracted the public councils. Carthage could not support them, or prevent Marcellus from undertaking the siege of Syracuse, and the immensity of the plunder. See SYRACUSE.

The Sicilians after this relinquished all martial ideas, and during a long series of generations turned their attention solely to the arts of peace and the labours of agriculture. Their position in the centre of the Roman empire preserved them both from civil and foreign distress, except in two instances of a feivle war. The incapacity of their governors was a more constant and insupportable evil. In this state of apathy and ignorance Sicily remained down to the 7th century of our era, when the Saracens began to disturb its tranquillity. The barbarous nations of the north had before invaded and ravaged its coasts, but had not long kept possession. The Saracens were more fortunate. In 827 they availed themselves of quarrels among the Sicilians to subdue the country. Palermo was chosen for their capital, and the island of Sicily was triumphed about 220 years.

In 1285 George of Monaco was sent by the Great emperor with a great army to attack Sicily. He made good his landing, and put his conquests with vigour; his troops were first the flower of some Norman troops, which were at that time employed and ready to sell their services to a lawful ruler. Monarchs repaid them with ingratitude, and by his art and conduct gave the Sicilians time to breathe, and the Normans a pretext and opportunity of invading the Imperial dominions in Italy. Robert and Roger of Hauteville afterwards conquered Sicily on their own account, but as mercenaries, for having unjustly settled their power on the continent, they turned their arms against this island in obedience to the dictates of zeal and ambition. After ten years struggle, the Saracens yielded up the rich prize and Robert raised it to his brother Roger, who assumed the title of Great King of Sicily, ruled the state with wisdom, and made desolately among the greatest characters in history. He raised himself from the humble station of a poor younger son of a private gentleman, to the exalted dignity of a powerful monarch; by the assistance of his own genius and courage, he possessed a nation of strangers with vigour and justice, and transmitted his possessions enriched to his posterity. Such an assemblage of great qualities is well entitled to our admiration.

He was succeeded by his son Simon, whose reign was short, and made way for a second king called Rog. In 1127 this prince joined to his Sicilian possessions the whole inheritance of Robert Guiscard. In 1130 he died, and assumed the regal style. The secret price of his reign was taken up in quelling rebellions in Italy, but Sicily enjoyed profound peace. In 1154 his son William I. ended the throne, and passed his life in war and conquest. William II. succeeded his father, and led a turbulent life. He reigned though a child, and was murdered by his uncle, and his brother William III. succeeded his uncle, and his brother Henry of Swabia, who was

Pyrrhus king of Epirus deposes the Sicilians.

The Mamertini, a crew of mercenaries, and are assisted by the Romans;

the great part of the Sicilian population.

The Punic wars.

the troubles that agitated the reign of his son the emperor Frederic, peace appears to have been the lot of Sicily. A short-lived sedition, and a revolt of the Saracens, are the only commotions of which we read. For greater security, the Saracens were removed to Puglia 400 years after the conquest of Sicily by their ancestors. Under Conrad and Manfred Sicily remained quiet; and from that time the history of Sicily is related under the article NAPLES, N° 27, &c.

At the death of Charles II. of Spain, his spoils became an object of furious contention; and at the peace of Utrecht, Sicily was ceded to Victor duke of Savoy, who, not many years after, was forced by the emperor Charles VI. to relinquish that fine island, and take Sardinia as an equivalent. But as the Spaniards had no concern in these bargains, they made a sudden attempt to recover Sicily, in which they failed through the vigilance of the English admiral Byng. He destroyed their fleet in 1718, and compelled them to drop their scheme for a time. In 1734 the Spanish court renewed their design with success. The infant Don Carlos drove the Germans out, and was crowned king of the two Sicilies at Palermo. When he passed into Spain to take possession of that crown, he transferred the Sicilian diadem to his son Ferdinand III. of Sicily, and IV. of Naples, and it has ever since remained in the possession of the same family.

Sicily is separated, as we have already observed, from Italy by a narrow strait called the *Faro of Messina*. This strait is still remarkable for the rapidity of its currents and the irregular ebbing and flowing of the sea, which sometimes ruffles in with such violence as to endanger ships riding at anchor. Anciently it was much more remarkable for Scylla and Charybdis, the one a rock, and the other a whirlpool, between which it was very dangerous to steer, and concerning which so many fables have been related by the ancients. Scylla is a rock on the Italian side, opposite to Cape Pylotes, which runs out into the sea on the Sicilian side. Mr Byrdne informs us, that the navigation of the straits is not even yet performed without danger. He also informs us, that the noise of the current which sets through the straits may be heard for several miles, like the roaring of some large impetuous river confined between narrow banks. In many places the water rose into whirlpools and eddies, which are dangerous to shipping. The current set exactly for the rock of Scylla, and would certainly have carried any thing thrown into it against that point. Our author, however, is by no means of opinion that the strait is so dangerous as the ancients have represented it; though he thinks that the strait is now probably much wider than formerly, which may have diminished the danger. There are many small rocks, which show their heads near the base of the large ones. These are probably the dogs described by the ancient poets as howling round Scylla. The rock is near 200 feet high, and has a kind of castle or fort built on its summit with a town called *Scylla* or *Sciglio*, containing 300 or 400 inhabitants on its south side, which gives the title of prince to a Calabrese family.

The following account of these rocks and whirlpools is given by the celebrated naturalist Spallanzani. He informs us, that Scylla is a lofty rock, 12 miles from Messina, rising almost perpendicular from the sea on the

shore of Calabria, beyond which is the small city of the same name. Though there was scarcely any wind, Spallanzani heard, about two miles distant from the rock, a noise like a confused barking of dogs, and on a nearer approach he discovered the cause. This rock contains a number of caverns, one of the largest of which is called by the people *Dragara*. The waves, when in the least agitated, rushing into these caverns, break, dash, throw up frothy bubbles, and thus occasion these various and multiplied sounds. He then perceived with how much truth and resemblance of nature Homer and Virgil, in their personifications of Scylla, had portrayed this scene, by describing the monster they drew as lurking in the darkness of a vast cavern, surrounded by ravenous barking mastiffs, together with wolves, to increase the horror.

Though the tide is almost imperceptible in the open parts of the Mediterranean, it is very strong in the strait of Messina, owing to the narrowness of the channel, and regulated by the periodical elevations and depressions of the water. Where the current is accompanied by a wind blowing the same way, vessels have nothing to fear, since they either do not enter the strait, both the wind and stream opposing them; or, if both are favourable, enter on full sail, and pass with such rapidity that they seem to fly over the water. When the current runs from south to north, and the north wind blows hard at the same time, the ship is resisted by the opposite current, and impelled by two forces in contrary directions, is dashed on the rock of Scylla, or driven on the neighbouring sands. The current, where it is strongest, does not extend over the whole strait, but winds through it in intricate meanders, with the course of which the sailors directed to give strangers assistance are well acquainted, and thus able to guide the ship in such a manner as to avoid it. Should the pilot, however, confiding in his own skill, neglect such assistance, he would run the most imminent risk of being shipwrecked. In this conflict of the waters, it is useless to throw the line to discover the depth of the bottom, the violence of the current frequently carrying the lead aloft on the surface of the water. The strongest cables, though some feet in circumference, break like small cords. Every expedient afforded by the art of navigation, is useless here. The only means of avoiding being dashed against the rocks, or driven upon the sands in the midst of this perilous contest of the winds and waves, is to have recourse to the skill and courage of the Messinese fishermen.

Charybdis is distant from the shore of Messina about 700 feet, and is called by the people of the country *Calafaro*, not from the agitation of the waves, but from *καλας* and *φαγος*, *beautiful tower*, from the lighthouse erected near it for the guidance of vessels. When the current sets in from the north, the pilots call it the *descending vena*, or current; and when it runs from the south, the *ascending vena*. The current ascends or descends at the rising or setting of the moon, and continues for six hours. In the interval between each ascent or descent, there is a calm which lasts at least 15 minutes, but not longer than an hour. Afterwards, at the rising or setting of the moon, the current enters from the north, making various angles of incidence with the shore, and at last reaches the Calafaro. This delay sometimes

continues

continues two hours; sometimes it immediately falls into the Calofaro; and then experience regards it as a certain indication of bad weather.

When Spallanzani observed Charybdis from the shore, it appeared like a group of tumultuous waters, which group as he approached, became more extensive and more agitated. He was carried to the edge, where he stopped some time to make the requisite observations; and was then convinced beyond the shadow of a doubt, that what he saw was by no means a vortex or whirlpool.

Though he was convinced that there was no gulf under the Calofaro, as otherwise there would have been a whirlpool, which would have carried down into it the floating substances; he determined to found the bottom with a plummet, and found its greatest depth did not exceed 500 feet. He was also informed, to his great surprize, that beyond the Calofaro, towards the middle of the strait, the depth was double.

When the wind and current are contrary to each other, and both in their greatest violence, the swelling and dashing of the waves within the Calofaro is much stronger, more impetuous, and more extensive. It then contains three or four small whirlpools, or even more, according to the greatness of its extent and violence. If at this time small vessels are driven into the Calofaro by the current or the wind, they are seen to whirl round, rock, and plunge, but are never drawn down into the vortex. They only sink when filled with water, by the waves beating over them. When vessels of a larger size are forced into it, whatever wind they have they cannot extricate themselves; their sails are useless; and after having been for some time tossed about by the waves, if they are not assisted by the pilots of the country, who know how to bring them out of the course of the current, they are furiously driven upon the neighbouring shore of the Lanterna, where they are wrecked, and the greater part of their crews perish in the waves.

If a ship be extricated from the fury of Charybdis, and carried by a strong southerly wind along the strait towards the northern entrance, it will indeed pass out safely; but should it meet with a wind in a nearly opposite direction, it would become the sport of both these winds, and, unable to advance or recede, be driven in a middle course between their two directions, that is to say, full upon the rock of Scylla, if it be not immediately assisted by the pilots. It is likewise observed, that in these hurricanes a land wind frequently rises, which descends from a narrow pass in Calabria, and increases the force with which the ship is impelled towards the rock. Thus, the saying which became proverbial among the ancients;—that “he who endeavours to avoid Charybdis, dashes upon Scylla,” is, in a great measure, true.

In the straits, Mr Brydone informs us, a most surprising phenomenon is to be observed. In the heat of summer, after the sea and air have been much agitated, there appears in the heavens over the straits a great variety of singular forms, some at rest and others moving with great velocity. These forms, in proportion as the light increases, seem to become more aerial, till at last, some time before sunrise, they totally disappear. The Sicilians represent this as the most beautiful sight in nature. Leonti, one of the best Sicilian writers, says, that the heavens appear crowded with a variety of objects, such as palaces, woods, gardens, &c. besides the figures of men and other animals that are seen in motion

among them. Some treatises have been written concerning this phenomenon; but nothing satisfactory has been delivered concerning its cause.

Though Sicily lies in a warm climate, the air is healthful, being refreshed with sea-breezes on every tide. It has at all times been remarkably fertile; but the era of its greatest prosperity was from the siege of Syracuse by the Athenians to the Carthaginian conquests. Then and long after it supplied with grain, in years of scarcity, all the countries upon the Mediterranean except Egypt and the coasts of Asia, and Rome and Carthage continually. Even now, under all the impediments of superstition and bad government, its productions are, in quantity and quality, the best in Europe. Of the vegetable are grain, wines, oil, fruits, tobacco, mulberry trees for the silkworm, cotton, medicinal roots, and sugar canes. The last of these flourish near Avola and Merilli. They are of an inferior quality to those of the West Indies, but their sugar is sweeter than any other. The animal production is similar to that of Italy, but the horned cattle are a smaller breed. The coasts abound with fish, particularly with tunney and anchovies; the export of which forms a very lucrative branch of commerce. There are mines of silver, copper, and lead, but none are worked. Near Palma are beds of the best sulphur; at the mouth of the river Giaretta is found a yellow amber, preferable to that of the Baltic: and in every part of the island quarries of marbles, that have furnished materials for all the noble edifices of Sicily. The most beautiful are in the neighbourhood of Palermo, particularly the yellow, and those that resemble the verde antique, porphyry, and lapis lazuli. The population of the island amounts to 1,320,000 souls; not as much again as the single city of Syracuse formerly contained.

Here are several rivers and good springs; but few of the rivers are navigable, having but a short course, and descending precipitately from the mountains. The chief are the Bantera, the Jaretta, and the Salfo; of which, the two former run from west to east, and the third from north to south.

Of the mountains in this island the most noted is Mount Etna, now called *Monte Gibello*, or *Mangibello*, a volcano whose eruptions have often proved fatal to the neighbouring country. See *ETNA*.

Were the Sicilians a cultivated people, among whom those arts were encouraged which not only promote the wealth and comfort of a nation, but also exercise the nobler faculties and extend the views of mankind, the circumstances of their government are such, that it might gradually be improved into a free constitution; but to this, the ignorance, superstition, and poverty, of the people seem to be invincible obstacles. The monarchical power in Sicily is far from being absolute; and the parliament claims a share of public authority independently of the will of the king, deduced from a compact made between Roger and the Norman barons after the expulsion of the Saracens. This claim is denied by the king, who wishes the nobles to consider their privileges as derived solely from his favour. Hence the government is in a situation which greatly resembles that of our own and the other kingdoms of Europe in the feudal times; there are continual jealousies and oppositions between the king and the barons, of which an enlightened people might easily take advantage, and obtain that share in the constitution which might secure

S. I. v.

them from future oppression. In these disputes, the king has the advantage at least of power if not of right; and several works, in which the claims of the Sicilian Laons have been asserted, were publicly burned not many years ago.

As the sovereign holds his court at Naples, Sicily is governed by a viceroy, who is appointed only for three years, though at the end of that term his commission is sometimes renewed. He lives in great state, and as the representative of the king, his power is very considerable. He presides in all the courts and departments of government, and is commander in chief of all the forces: he calls or dissolves the parliament when he pleases; and by him all orders, laws, and sentences, must be signed: but his office is far from being desirable, as it generally renders him the object either of the jealousy of the court of Naples, or of the hatred of the Sicilians.

The parliament consists of the nobles, the bishops, and abbots, and the representatives of 43 cities, which are immediately subject to the crown. Those cities which are subject to any of the nobles send no members to the parliament; in these the king has not much authority, and derives little advantage from them. According to the laws, the parliament ought to be assembled at the end of every three years: but the government pays little attention to this rule. The common people are in general very much attached to the nobles, and are inclined to take their part in all their differences with the court; but the magistrates and principal inhabitants of the cities which belong to these feudal lords, wish to get rid of their authority, and imagine that they and be less oppressed, if immediately subject to the king: these inclinations are not disagreeable to the court, and are encouraged by most of the lawyers, who are of great service to government in contesting the privileges of the nobles. Many of these privileges are now abridged; and the power of the barons, with respect to the administration of justice in their domains, was very properly limited by the viceroy Caraccioli, in the year 1785. The government of this nobleman was very beneficial to Sicily, as he, in a great measure, cleared the island of the banditti that used to infest it, and made several excellent regulations for the establishment of social order and personal security. He deserves the thanks of every well-wisher to mankind for having abolished the court of inquisition, which had been established in this country by Ferdinand the Catholic, and made dependent on the authority of the grand inquisitor of Sp in. His last *auto da fe* was held in the year 1724, when two persons were burned. At length Charles III. rendered it independent of the Spanish inquisitor, and abridged its power, by forbidding it to make use of the torture, and to inflict public punishments. The Marchese Squillace, and his successor the Marchese Taurici, were both enemies to the hierarchy; and, during their vicerealties, took care to appoint sensible and liberal men to the office of inquisitor: the last of whom was Ventimiglia, a man of a most humane and amiable character, who heartily wished for the abolition of this diabolical court, and readily contributed toward it. While he held the office of inquisitor, he always endeavoured to procure the acquittal of the accused; and when he could succeed no other way, would pretend some informality in the trial. The total annihilation of this instrument of the worst of tyranny was reserved for

Inquisition.

Caraccioli. A priest being accused to the inquisition, was dragged out of his house and thrown into the dungeon. He was condemned; but, on account of informality, and a violation of justice in the trial, he appealed to the viceroy, who appointed a committee of jurists to examine the process. The inquisitor refused to acknowledge the authority of this commission; pretending that to expose the secrets of the holy office, and to submit its decisions to the examination of lay judges, would be so inconsistent with his duty, that he would fee the inquisition abolished rather than consent to it. Caraccioli took him at his word, and procured a royal mandate by which the holy office was at once annihilated. He assembled all the nobility, judges, and bishops, on the 27th of March 1782, in the palace of the inquisition, and commanded the king's order to be read; after which he took possession of the archives, and caused all the prisons to be set open: in these were at that time only two prisoners, who had been condemned to perpetual confinement for witchcraft. The papers relating to the finances were preserved; but all the rest were publicly burned. The possessions of the holy office were assigned to the use of churches and charitable institutions: but the offices then belonging to it retained their salaries during their lives. The palace itself is converted into a customhouse, and the place where heretics were formerly roasted alive for the honour of the Catholic faith, is now changed into a public garden. The cognizance of offences against orthodoxy is committed to the bishops: but they cannot cite any one to appear before them without permission from the viceroy; neither can they confine any person to a solitary prison, nor deny him the privilege of writing to his friends, and conversing freely with his advocate. The nobility are so numerous in this island, that Labat says it is paved with noblemen. The general assembly of parliament is composed of 66 archbishops, bishops, abbots, and priors, which form the *Braccio ecclesiastico*, fifty-eight princes, 27 dukes, 37 marquises, 27 counts, one viscount, and 79 barons, form the military; and the demeritate consists of 43 representatives of free towns. Out of each *braccio* four deputies are chosen to conduct public business. But the viceroy, the prince of Butea, and the praetor of Palermo, are always three full. Such was the government of Sicily while the Neapolitan monarchy remained entire; but since the latter was usurped by the French, Sicily is all that is left to its former possessor.

SICINIUS DENTATUS, a tribune of the people, lived a little after the expulsion of the kings from Rome. He was in 122 battles and skirmishes, besides single combats, in all of which he came off conqueror. He served under nine generals, all of whom triumphed by his means. In these battles he received 45 wounds in the forehead of his body, and not one in his back. The fortunate made him great presents, and he was honoured with the name of the Roman Achilles.

SICYOS, a genus of plants belonging to the class of mercuria, and to the order of hyemifera; and in the natural system arranged under the 34th order, *Cucurbitaceae*. See BOTANY INDEX.

SIDA, *Yellow or Indian MALLOU*; a genus of plants belonging to the class of monadelphia, and to the order of polyandria; and in the natural system ranging under the 37th order, *Columniferae*. See BOTANY INDEX.

SIDDEF,

S. I. v.
h
Sicily22
the field
by Carac-
Sicily

SIDDER, or **SEDLER**, an Arabic title, by which the Abyssinians or Haabshas are always distinguished in the courts of Hindoan; where, being in great repute for firmness and fidelity, they are generally employed as commanders of forts or in posts of great trust.

SIDEREAL YEAR. See *ASTRONOMY Ind. v.*

SIDERITE, in *Natural History*, the old name of a genus of crystals, used to express those altered in their figure by particles of iron. These are of a rhomboidal figure, and composed only of six planes. Of this genus there are four known species. 1. A colourless, pellucid, and thin one; found in considerable quantities among the iron ores of the forest of Dean in Gloucestershire, and in several other places. 2. A dull, thick, and brown one; not uncommon in the same places with the former. And, 3. A black and very glossy kind, a fossil of great beauty; found in the same place with the others, as also in Leicestershire and Suffex.

SIDERITE, a substance supposed by Meyer to be a new metal; but according to Bergman and Kirwan it is nothing else than a natural combination of phosphoric acid with iron.

SIDERITIS, **IRONWORT**; a genus of plants belonging to the class of didymnia, and to the order of gymnospermia; and in the natural system ranging under the 42d order *Verticillata*. See *BOTANY Index*.

SIDEROXYLON, **IRON-WOOD**; a genus of plants belonging to the class of pentandria, and to the order of monogynia; and in the natural system ranging under the 53d order, *Dumosa*. See *BOTANY Index*.

SIDNEY, **SIR PHILIP**, was born, as is supposed, at Penthuill in Kent in the year 1554: His father was Sir Henry Sidney, an Irish gentleman, and his mother Mary the eldest daughter of John Dudley duke of Northumberland. He was sent when very young to Christchurch college at Oxford, but left the university at 17 to set out on his travels. After visiting France, Germany, Hungary, and Italy, he returned to England in 1575, and was next year sent by Queen Elizabeth as her ambassador to Ransolph emperor of Germany. On his return he visited Don John of Austria, governor of the Netherlands, by whom he was received with great respect. In 1576, when Queen Elizabeth seemed on the point of concluding her long projected marriage with the duke of Anjou, Sir Philip wrote her a letter, in which he dissuaded her from the match with unusual elegance of expression, as well as force of reasoning. About this time a quarrel with the earl of Oxford occasioned his withdrawing from court; during which retirement he is supposed to have written his celebrated romance called *Arcadia*.

In 1585, after the queen's treaty with the United States, he was made governor of Flushing and master of the horse. Here he distinguished himself so much both by his courage and conduct, that his reputation rose to the highest pitch. He was named, it is pretended, by the republic of Poland as one of the competitors for that crown, and might even have been elected had it not been for the interference of the queen. But his illustrious career was soon terminated; for in 1586 he was wounded at the battle of Zutphen, and carried to Arnheim, where he soon after died. His body was brought to London, and buried in St Paul's cathedral. He is described by the writers of that age as the most perfect model of an accomplished gentleman that could be form-

ed even by the wanton imagination of poetry or fiction. Virtuous conduct, polite conversation, heroic valour, and elegant erudition, all concurred to render him the ornament and delight of the English court; and as the credit which he enjoyed with the queen, and the earl of Leicester was wholly employed in the encouragement of genius and literature, his praises have been transmitted with advantage to posterity. No person was so low as not to become an object of his humanity. After the battle of Zutphen, while he was lying on the field mangled with wounds, a bottle of water was brought him to relieve his thirst; but observing a soldier near him in a like miserable condition, he said, *This man's necessity is still greater than mine;* and refused to him the bottle of water. Besides his *Arcadia*, he wrote several smaller pieces both in prose and verse, which have been published.

SIDNEY, *Algernon*, was the second son of Robert earl of Leicester, and of Dorothy eldest daughter of the earl of Northumberland. He was born about the year 1617. During the civil war he took part against the king, and distinguished himself as a colonel in the army of the parliament. He was afterwards appointed one of King Charles's judges, but declined appearing in that court. During the usurpation of Cromwel, Sidney, who was a violent republican, retired to the country, and spent his time in writing those discourses on government which have been so deservedly celebrated. After the death of the Protector, he again took part in the public transactions of his country, and was abroad on an embassy to Denmark when King Charles was restored. Upon this he retired to Hanburgh, and afterwards to Francfort, where he resided till 1677, when he returned to England and obtained from the king a pardon. It has been affirmed, but the story deserves no credit, that during his residence abroad King Charles hired ruffians to assassinate him. After his return he made repeated attempts to procure a seat in parliament, but all of them proved unsuccessful. After the intention of the commons to seclude the duke of York from the throne had been defeated by the sudden dissolution of parliament, Sidney joined with eagerness the councils of Russell, Essex, and Monmouth, who had resolved to oppose the duke's succession by force of arms. Frequent meetings were held at London; while, at the same time, a set of subordinate conspirators, who were not, however, admitted into their confidence, met and embraced the most desperate resolutions. Keiling, one of these men, discovered the whole conspiracy; and Algernon Sidney, together with his noble associates, was immediately thrown into prison, and no art was left unattempted in order to involve them in the guilt of the meaner conspirators.

Howard, an abandoned nobleman, without a single spark of virtue or honour, was the only witness against Sidney; but as the law required two, his discourses on government, found unpublished in his closet, were construed into treason, and declared equivalent to another witness. It was in vain for Sidney to plead that papers were no legal evidence; that it could not be proved they were written by him; and that if they were, they contained nothing treasonable. The defence was overruled; he was declared guilty, condemned, and executed! His attainder was reversed in the first year of King William.

He was a man of extraordinary courage; steady even to obstinacy; of a sincere but rough and boisterous temper. Though he professed his belief in the Christian religion, he was an enemy to an established church, and even, according to Burnet, to every kind of public worship. In his principles he was a zealous republican; government was always his favourite study; and his essays on that subject are a proof of the progress which he made.

SIDON, in *Ancient Geography*, a city of Phœnicia in Asia, famous in Scripture for its riches, arising from the extensive commerce carried on by its inhabitants. Heavy judgements were denounced against the Sidonians on account of their wickedness, which were accomplished in the time of Ochoziah king of Persia: for that monarch having come against them with an army on account of their rebellion, the city was betrayed by its king: upon which the wretched inhabitants were seized with despair; they set fire to their houses, and 40,000, with their wives and children, perished in the flames.

This city is now called *Saïde*, and, according to Mr Bruce's account, not only its harbour is filled up with sand, but the pavement of the ancient city stood $7\frac{1}{2}$ feet lower than the ground on which the present city stands. Volney describes it as an ill-built dirty city. Its length along the sea-shore is about 600 paces, and its breadth 150. At the north-west side of the town is the castle, which is built in the sea itself, 80 paces from the main land, to which it is joined by arches. To the west of this castle is a shoal 15 feet high above the sea, and about 200 paces long. The space between this shoal and the castle forms the road, but vessels are not safe there in bad weather. The shoal, which extends along the town, has a basin inclosed by a decayed pier. This was the ancient port; but it is so choked up by sand, that boats alone can enter its mouth near the castle. Fakr-el-din, emir of the Druses, destroyed all these little ports from Baitout to Acre, by sinking boats and stones to prevent the Turkish ships from entering them. The basin of Saïde, if it were emptied, might contain 20 or 25 small vessels. On the side of the sea, the town is absolutely without any wall; and that which encloses it on the land side is no better than a prison-wall. The whole artillery does not exceed six cannons, and these are without carriages and gunners. The garrison scarcely amounts to 100 men. The water comes from the river Aoula, through open canals, from which it is fetched by the women. These canals serve also to water the orchards of mulberry and lemon trees.

Saïde is a considerable trading town, and is the chief emporium of Damascus and the interior country. The French, who are the only Europeans to be found there, have a consular, and five or six commercial houses. Their exports consist in silks, and particularly in raw and spun cottons. The manufacture of this cotton is the principal art of the inhabitants, the number of whom may be estimated at about 5000. It is 45 miles west from Damascus. E. Long. 36. 5. N. Lat. 37.

SIDUS GEORGIUM, in *Astronomy*, a new primary planet, discovered by Dr Herschell in the year 1781. It is most foreign, and even by some British philosophers, it is known by the name of *Herschell*, in honour of the discoverer. As the other planets are distinguished by marks or characters, the planet Herschell is distinguish-

ed by an II, the initial letter of the discoverer's name, and a cross to show that it is a Christian planet. See *ASTRONOMY Index*.

SIÈGE, in the art of war, is to surround a fortified place with an army, and approach it by passages made in the ground, so as to be covered against the fire of the place.

SIÈGEN, a town of Germany in Wetteravia, with a castle and the title of a principality, which it gives to a branch of the house of Nassau. It is seated on a river of the same name, in E. Long. 8. 5. N. Lat. 50. 53.

SIENNA, a large, ancient, and celebrated city of Tuscany in Italy; capital of the Siennese, with an archbishop's see, a famous university, and a citadel. It is about four miles in circumference, and surrounded with an old wall. The metropolitan church is much esteemed by travellers; and though it is a Gothic structure, the architecture is admirable. It is built with black and white marble, and the pavement is of mosaic work. The town is adorned with a great number of palaces, fountains, and superb churches, as also a magnificent hospital. The great area is round, and the houses about it are of the same height, supported by piazzas, under which people may walk in hot or rainy weather; in the middle is a basin, which can be filled with water at any time, to represent a sea-fight with small vessels. The Italian language is taught here with such purity, that a great many foreigners frequent it on that account. It is seated on three eminences, in a fertile soil, in E. Long. 11. 11. N. Lat. 43. 10.

SIENNESE, a duchy in Italy; bounded on the north by the Florentino, on the south by the Mediterranean sea and the duchy of Castro, on the east by the Perugino and Orvietano, and on the west by the Florentino and the Tufcan sea; being about 55 miles in length, and as much in breadth. The soil is pretty fertile, especially in mulberry trees, which feed a great number of silk-worms; and there are several mineral springs. Sienna is the capital town.

SIERRA LEONA, a large country on the west coast of Africa, which some extend from the Grain Coast on the south-east to Cape Verga or Vega on the north-west, i. e. between 7° and 10° N. Lat. Others, however, confine the country between Cape Verga and Cape Tagrin. There runs through it a great river of the same name, of which the source is unknown, but the mouth is in longitude $12. 50$. west, lat. $8. 5$. north, and is nine miles wide. The climate and soil of this tract of country appear to be, on both sides of the river, among the best in Africa, or at least the most favourable to European constitutions. The heat is much the same as that of the West Indies; but on the higher grounds there is a cool sea breeze, and in the mountainous parts the air is very temperate. According to Lieutenant Matthew, "Sierra Leona, if properly cleared and cultivated, would be equal in salubrity and superior in produce to any of the islands in the West Indies;" and others have affirmed, that "the air is better for a man's health than in many places of Europe." These advantages of climate induced the English to establish a factory at Sierra Leona; but they chose not the most healthful situation. For the benefit of a spring of good water they fixed their residence in a low valley, which is often overflooded with mists and noisome vapours, while the

See

Sierra.

Sierra air is clear and serene on the summits of the hills, to which water from the well might be easily carried.

Within the district occupied by this colony are the Foulahs, who are in general of a tawny complexion, though many of them are entirely black. They lead a wandering life, and roam about the country with large droves of cows, sheep, goats, and horses. They are much praised by travellers for their hospitality; nor is their humanity in other respects, less commendable; for, if one of their countrymen have the misfortune to fall into slavery, the rest join flock to redeem him. Elephants are so numerous in the country of the Foulahs, that they are frequently seen in droves of 200 together. The people are very dexterous at hunting them, and other wild beasts; from which they derive their principal articles of trade.

The animal productions of Sierra Leona are lions, from which it has its name; leopards, hyenas, mink cats, and many kinds of weasels; the japanzee or chimpanzee, a species of simia, which has a still more striking resemblance to the human figure than even the orang outang; porcupines, wild hogs, squirrels, and antelopes. Besides these, which are natives of the country, oxen thrive in it, and even grow fat; asses too are employed in labour, and do not suffer by the climate; but they suffer much from the heat, change their wool into hair, grow lean and increase very little; while the hardy goat is here as prolific and large as in any other country. Of the birds which frequent the woods of Sierra Leona we can give no perfect account. A species of crane is mentioned as easily tamed; common poultry multiply fast; ducks thrive well, but geese and turkeys seem not to agree with the climate. Turkeys of all kinds are very common, and sometimes of a large size. Crocodiles or alligators of a non-descript species have been found ten or twelve feet in length, and lizards of six different species. Snakes, which are almost innumerable, haunt the houses in the night in search of poultry; and one was observed which measured 18 feet, but was happily found not to be venomous. Fishes are in great variety both in the sea and in the rivers. B-fishes, the whale, the shark, stingray, and porpoise, there are eels, horse-mackerel, tarpoons, cavilios, mullets, snappers, yellow-tails, old-waids, ten-pounders, and some other fishes; all of which, except the eels and ten-pounders, are esteemed fine eating. Oysters are found in great abundance, and another shell-fish, which the natives eat. Among the zoophytes, none is more worthy of notice than the common sponge, which covers all the sandy beaches of the river, particularly on the Bullom shore, and would fetch a high price in Great Britain.

Of the numerous vegetable productions of Sierra Leona, our limits will permit us only to mention the following. Rice, which is the plant chiefly cultivated, as the natives subsist almost entirely upon it, grows both in the high and low grounds. It prospers indeed best in swamps, though the grain is better in a drier soil. Next to rice the cassada constitutes the chief food of the inhabitants, and is cultivated with great care. The country likewise produces yams, various kinds of potatoes, eddoes, or the *arum esculentum*. Oil-palm, plantains, and bananas; papaw, guava, orange; and limes; pumpions, melons, and cucumbers; pine-apples, pigeons, peas, which dressed like English peas are a good pulse;

maize or Indian corn; millet, cocoa-nut trees; ockra; the tallow-tree; a great variety of tamarinds; different kinds of fig-trees and plums; a kind of fruit resembling grapes, but more acid and acrid; cherries resembling a fine nectarine in taste; a species of the bread-fruit-tree; the cream fruit, so called because when wounded it yields a fine white juice resembling sugar or the best milk, of which the natives are very fond; the malaguetta pepper, or grains of paradise; a new species of nutmeg, but whether so good as the common sort has not yet been ascertained; a new species of the Peruvian bark, which it is hoped will prove as useful as the other, and cola, a fruit highly esteemed by the natives for the same virtues with that bark; the ricinus, castia, dyeballs, and gums, of great value; cotton, tobacco, and sugar-canes, which, it is thought, would thrive exceedingly well under proper cultivation.

Considering the ardour of the maritime nations of Europe for settling colonies in distant regions of the globe, it is somewhat surprising that a climate so temperate and a soil so productive as that of Sierra Leona did not long ago attract their notice. But it was left to be colonized for a better purpose than that which first drew the natives of Europe to the West Indies and the American continent. Being thinly inhabited, Sierra Leona appeared to some benevolent gentlemen in England a place where, without incommoding the natives, a sufficient quantity of ground might be bought on which to settle a great number of free negroes, who in 1786 swarmed in London in idleness and want. About 400 of these wretches, together with 60 whites, mostly women of bad character and in ill health, were accordingly sent out, at the charge of government, to Sierra Leona. Necessity, it was hoped, would make them industrious and orderly; and Captain Thomson of the navy, who conducted them, obtained, for their use, a grant of land to his majesty from King Tom, the neighbouring chief, and afterwards from Naimbanna, the king of the country. The colony, however, soon went to ruin; but the land which they occupied, being about 20 miles square, his majesty was enabled to grant by act of parliament to another colony founded on better principles and for a still nobler purpose.

The most intelligent members of that society, which laboured so strenuously to procure an abolition of the slave-trade, justly concluding that the natives of Guinea would reap very little benefit from the attainment of their object, unless they should be taught the principles of religion and the arts of civil life, which alone can render them really free, conceived the plan of a colony at Sierra Leona to be settled for the truly generous purpose of civilizing the Africans by maintaining with them a friendly intercourse, and a commerce in every thing but men. This plan could not be carried into effect but at a very great expence. Subscriptions were therefore opened upon rational and equitable terms, and a sum deemed sufficient was speedily raised. An act of parliament was passed in favour of the subscribers, by which they were incorporated by the denomination of the *Sierra Leona Company*; and in pursuance of that act they held their first meeting at London in October 1791.

The directors having stated the natural advantages of Sierra Leona, and its present miserable condition, observed, that they had not merely to establish a com-

mercial

mercantile factory, but that, to introduce civilization, cultivation, and a safe trade, the company must provide for the security of the persons and property of the colonists. The directors therefore resolved, that three or four vessels should sail at once, with such a number of people as would be able to protect and assist each other; with goods both for trade and for the supply of the colony. Accordingly several vessels sailed, having on board a council for the government of the colony and the management of the company's affairs; a number of artificers and other servants of the company; some soldiers, and a very few English settlers. The directors were laudably cautious in the choice of colonists. They admitted into the society no white man of bad character, or who was not a declared enemy to the slave-trade; and as the chief object of their enterprise was the civilization of the natives, it was with great propriety that they chose more than three-fourths of their settlers from the free negroes in Nova Scotia, who had borne arms for the British government during the American war. The superintendent and council were particularly instructed to secure to all blacks and people of colour, at Sierra Leona, equal rights and equal treatment, in all respects, with whites. They were to be tried by jury, as well as others; and the council was desired to allot to the blacks employments suited to their present abilities, and to afford them every opportunity of cultivating their talents. All practicable means of maintaining subordination were directed to be used; and the council was especially instructed to promote religion and morals, by supporting public worship and the due observance of the Sabbath, and by the instruction of the people, and the education of children. But no person was to be prevented from performing or attending religious worship in whatever place, time, or manner, he might think fit, or from peaceably inculcating his own religious opinions. Orders were given in choosing the site of a town, to consider health as the first object; and the first town was directed to be called *Free-Town*. Articles for building and cultivation were sent out, besides the cargoes for prosecuting the company's commerce; and schools for reading, writing, and accounts were ordered to be set up for the purpose of instructing the children of such natives as should be willing to put them under the company's care.

The leading object of the company was to substitute, for that disgraceful traffic which has too long subsisted, a fair commerce with Africa, and all the blessings which might be expected to attend it. Considerable advantages appeared hereby likely to result to Great Britain, not only from our obtaining several commodities cheaper, but also for opening a market for British manufactures, to the increasing demands of which it is difficult to assign a limit. From this connection, Africa was likely to derive the still more important benefits of religion, morality, and civilization. To accomplish these purposes, it was necessary for the company to possess a tract of land, as a repository for their goods, and which the Africans might cultivate in peace, secure from the ravages of the slave-trade. It had been ascertained, beyond a doubt, that the climate and soil of Africa were admirably suited to the growth of sugar, spices, coffee, cotton, indigo, &c. and every other species of tropical produce. The company proposed to instruct the natives to raise these articles, and to set them

the example, by a spirited cultivation, on its own account. Directions were given to the company's commercial agent to push forward a trade, in a mode preferred, in the present produce of Africa. Measures were taken for cultivating, on the company's account, the most profitable tropical produce; and in particular, a person of long experience in the West Indies was ordered to begin a sugar plantation. A mineralogist and botanist were likewise engaged to go out and explore the country for new articles of commerce.

Every thing being thus settled upon the most equitable and benevolent principles, the ships sailed with the British colonists, to whom, in March 1792, were added 1131 blacks from Nova Scotia. The native chiefs being reconciled to the plan, and made to understand its benevolent tendency towards their people, the colony proceeded to build *Free-Town*, on a dry and rather elevated spot on the south side of the river. It occupied between 70 and 80 acres, its length being about one-third of a mile, and its breadth nearly the same; and it contained near 400 houses, each having one-twelfth of an acre annexed, on which a few vegetables were raised. There were nine streets running from north-west to south-east, and three cross streets, all 80 feet wide, except one of 160 feet, in the middle of which were all the public buildings. These consisted of a governor's house and offices; a large store-house; a large hospital; six or eight other houses, offices, and shops, occupied by the company's servants; and a church capable of containing 800 people. The colonists at first suffered much from the rainy season, against which it was not in their power to provide sufficient protection; but at the end of it they recovered in a great measure their health and spirits, and proceeded with alacrity to execute the various purposes of their settlement. To excite emulation in culture, the government gave premiums to those colonists who raised the greatest quantities of rice, yams, eddoes, cabbages, Indian corn, and cotton, respectively. To limit the excesses of the slave-trade, and gain the favour of the neighbouring chiefs, the directors instructed the governor and council to redeem any native from the neighbourhood, who should be unjustly sold either to or by a British subject. The servants of the company conducted themselves with the utmost propriety, being sober, moral, and exemplary; and from the labours of the clergymen were derived services highly important in every point of view. Before the end of two years from the institution of the colony, order and industry had begun to show their effects in an increasing profperity. The woods had been cut down to the distance of about three English miles all round the town. By these means the climate had become healthier, and sickness had diminished. The fame of the colony spread not only along the whole western coast of Africa, but also to ports far distant from the coast; embassies had been received of the most friendly nature from kings and princes several hundred miles distant; and the native chiefs had begun to send their children to the colony, with full confidence, to be taught reading, writing, and accounts, and to be brought up in the Christian religion. In a word, it was not without grounds that the directors looked forward to that joyful period when, by the influence of the company's measures, the continent of Africa should be rescued from her present state of darkness and misery, and exhibit a delightful scene of light and

Sierra.

and knowledge of civilization and a desire of peaceful industry and domestic comfort. On their frequent exertions they looked with confidence for the blessing of Providence; they were countenanced and supported by the British government; and upon the breaking out of the present war, the French Convention authorized one of their agents to write to the directors, requesting a full account of the design of the institution, and the names of the things employed in the service, and offering them of the good wishes of the French government to make an undertaking. How completely that government fulfilled its promise is very generally known. Having violated the rights of man in Europe by the violation of every principle of truth and justice, they determined by the same means to give light and liberty to the Africans; and that they have fully carried their determination into effect will be seen by the following extract of a letter from Mr A. Zebus, the company's botanist, dated Sierra Leona, 15th November 1794. "The French have been here and have ruined us. They arrived on the 28th of September last, early in the morning, with a fleet consisting of one large ship, two frigates, two armed brigs, and one cutter, together with two large armed merchant ships, taken by them at the Isles de Loës, an English slave factory to the north of our colony, and which they have now destroyed and burnt. So well had they concealed their nation, that we took them at first for English. They had English-built vessels, which were rigged in the English way. They showed the English flag, and had their sailors, at least those we saw on deck, dressed like English. In short, we did not perceive our mistake till we observed them pointing their guns. We had not strength sufficient to resist, and therefore our governor gave orders, that as soon as they should begin to fire, the British flag should be struck, and a flag of truce hoisted. Accordingly this was done, but still they continued firing, and did much damage, both within and without the town. They killed two people and wounded three or four. But as we did not understand the meaning of this proceeding, we asked them for an explanation; and they answered us, that we should display the flag of liberty, as a proof of our submission. We assured them that it should already have been done, if we had had any, which terminated the hostilities from the ships. In the mean time, most of the inhabitants had fled from the town, having taken with them as much of their property as they conveniently could in such a hurry. I was with the governor, together with a number of others; but as soon as I was certain they were enemies, I went towards my own house with a view to save as much as possible of my property and natural collections; but was received in such a manner, that I could not venture to proceed. My house was situated near the shore, and unfortunately just opposite the frigate which fired. I saw the balls passing through the house, and heard them whizzing about my ears. I saw that I should lose all my property; but life was dearer to me, and I hastened to the woods.

"In the afternoon the enemy landed, finding the town almost destitute of people, but rich in provisions, clothing and other stores. They began immediately to break open the houses and to plunder. What they did not want, they destroyed, burnt, or threw into the river.

They killed all the cattle and animals they found in the fields or farms, yards or elsewhere, not sparing even asses, dogs, and cats. Their proceedings they continued the whole succeeding week, till they had entirely ruined our beautiful and peaceful colony; and when they found nothing more worth plundering, they set fire to the public buildings and all the houses belonging to the Europeans and burnt as they did, by mistake four or ten hours of the colony. In the mean time, they were not less active on the water. They first fired at their vessels at Bone Island, an English slave factory lying up the river, which was plundered and burnt, together with four slave ships lying there. They took besides about 15 or 12 prizes, including the company's vessels. Most of these they plundered and burnt. They took along with them also two of our armed vessels, one of which was a large ship, laden with provisions, and which had been long expected; but the unfortunately arrived a few days too soon, and was taken with her whole cargo. We expected at least to receive our private letters, but even this was refused, and they were thrown aboard. At last, after reflecting on us every hardship we could suffer, only fearing our lives and the souls of the colonists, they sailed on the 13th of October last, at noon, proceeding downwards to the Gold Coast, and left us in the most dreadful situation, without provisions, medicines, clothes, houses, or furniture, &c. &c. and I fear much, that most of us should have perished, had not our friends in the neighbourhood, both natives and Europeans, who were so happy as to escape the enemy, been so kind as to send us what they could spare. In the mean time, most of us have either been, or still are, very sick, and many have died for want of proper food and medicine. The worst, however, is now past. At least we are not in any want of provision, although of the coarsest kind, but are destitute of the most necessary articles and utensils for the house, the table, and the kitchen."

It was thus that the Convention executed their purpose of spreading light and liberty through the world. The Sierra Leona colony was established for no other end than to abolish the slave-trade, to enlighten the Africans, and to render them virtuous, rational, free, and happy; and those powerful patrons of the rights of man destroyed that colony with many circumstances of the most wanton cruelty. Though Mr Azevedo is a Swede, and ought therefore to have been protected by the laws of neutrality, they burnt his house with the rest; deprived him of his trunk, his clothes, and his bed; destroyed the natural curiosities which he had collected at the hazard of his life; and carried away the instruments by means of which only he could collect more.

In 1798, Free-Town, consisted of about 300 houses, and a number of public buildings, together with three wharfs. The government house, so situated as to command the town and harbour, was protected by a garrison, and six pieces of cannon. The inhabitants of this colony were then computed at 1220, of whom 15 were black keepers, 25 fishermen, 12 trading shipmasters, 2000 of small vessels, 15 farmers, 20 boatmen employed by the company, 4 schoolmasters; of our one half of the whole population petty farmers, and the rest mechanics. The number of Europeans resident at that time in the colony

Sierra was about 30, and nearly 400 free natives wrought as labourers for wages, on the farms in the colony.

A charter of justice was obtained in 1800, to controul the turbulence of the blacks from Nova Scotia, and a small military force from Goree was stationed at Sierra Leona. Parliament allowed the company 7000*l.* for the purpose of erecting a fort, with a promise of 8000*l.* more for the same undertaking. The company also received 10,000*l.* for their expence in settling the blacks from Nova Scotia, and a vote of parliament agreed to pay 4000*l.* for supporting the civil government of the colony.

The Maroons arrived in Sierra Leona in the month of October 1800, and greatly assisted in suppressing an insurrection of the Nova Scotia blacks, who had attempted to seize on the government of the colony. A body of natives of the Timmaney, headed by two of the fugitive blacks, made an attack on the unfinished fort on the 18th of November, about day-break, but they were repulsed with loss. A truce was concluded; but it was supposed that the Timmanee chiefs would make use of this interval to form alliances with the natives against the British, in order to exterminate them from this part of Africa. Soldiers to the amount of 65 were brought from Goree, and a ship of war was stationed in the river, to defend the settlement.

In 1802, parliament again voted 10,000*l.* to the company, for the annual expence of the settlement; and in February 1803, the directors were informed by Lord Hobart, that it would be for the interest of the colony to transfer the civil and military power from the company to the British government.

When Captain Hollowell arrived at Sierra Leona on the 12th of January 1803, he found the colony in a wretched condition, reporting to government on his return, that the Maroons were not satisfied with their condition, regarding it as one in which they could not find subsistence; that provisions of every description were both scarce and dear; that its inhabitants lived in hourly danger from the natives; and that the whole colonists lived in a state of dependency. Government, however, was afterwards satisfied, from the explanations of the directors and their servants, that the account of Captain Hollowell was by much too unfavourable. Expectations are indulged that, since the entire abolition of the slave-trade, the colony will soon obtain a flourishing trade with the natives, in the exchange of British manufactures for the raw produce of the interior parts of Africa.

A committee of the house of commons has had a most satisfactory proof of the progressive improvement of the internal administration of the colony, arising from the additional powers conferred on the company by the charter of justice, and the increased vigilance and exertion of the Company's servants. The Maroons have, in a great measure, abandoned some pernicious habits they had long indulged, and by their attachment to the colony, and peaceable demeanour, have merited the approbation of government. The progress made in the erection of works has been considerable, and the colony may be regarded in a state of sufficient security against the attack of any native power. A body of volunteers has been raised within the colony, whose fidelity and attachment have been tried by experience. The sickness and mortality which for some time existed, have in a great

degree subsided; and there is reason to believe, that it rather originated with the troops when they entered the colony, and their habits of intemperance, than from any disorder connected with their residence in that situation. The number of births, which has for some time exceeded that of the deaths in the colony, is a satisfactory proof that it is not unfriendly to population.

Sierra Leona is already rendered secure against the only enemies whose hostilities it has immediately to apprehend; its resources are increased; its cultivation reviving; and it is in the possession of every advantage that can arise from the enjoyment of internal tranquility and order. It is sufficiently manifest, from the inconveniences already experienced in the colony, that during its continuance, it will be essentially necessary to support a local government capable of maintaining order among its inhabitants, and affording them protection. The expence of the civil establishment for some years to come cannot be estimated at less than 10,000*l.* per annum*; that of completing the proposed works has been estimated at 8000*l.* It also appears that the defence of the colony will require the present volunteer force to be permanently kept up, the expence of which has been estimated at 4000*l.* per annum; or if that establishment should be discontinued, a regular garrison must be maintained at the constant establishment of 100 effective men, exclusive of about 20 artillery men, which, considering the numerous casualties in that climate, and great expence of supporting them, would exceed the sum already mentioned.

SIERRA MORENA, a considerable ridge of mountains of Andalusia in Spain. See SPAIN.

SIEUR, a title of respect among the French, like that of *maître* among us. It is much used by lawyers, as also by superiors in their letters to inferiors.

SIFANTO, or SIPHANTO, an island of the Archipelago, to the west of Paros, to the north-east of Milo, and to the south-west of Serphanto. The air is so good here, that many of the inhabitants live to the age of 120; and their water, fruits, wild fowl, and poultry, are excellent, but more especially the grapes. It abounds with marble and granite, and is one of the most fertile and best cultivated of these islands. The inhabitants employ themselves in cultivating olive-trees and capers; and they have very good silk. They trade in figs, onions, wax, honey, and straw-hats; and may be about 8000 in all. E. Long. 25. 15. N. Lat. 37. 9.

SI-FANS, or TOU-FANS, a people inhabiting the country on the west of China. Their country is only a continued ridge of mountains, inclosed by the rivers Hoang-ho on the north, Ya-long on the west, and Yang-tse-kiang on the east, between the 30th and 33th degrees of north latitude. Græber's General Description of China, vol. i. p. 203.

The Si-fans are divided into two kinds of people; the one are called by the Chinese *Black Si-fans*, the other *Yellow*; names which are given them from the different colours of their tents. The black are the most clownish and wretched; they live in small bodies, and are governed by petty chiefs, who all depend upon a greater.

The yellow Si-fans are subject to families, the oldest of which becomes a lama, and assumes the yellow dress. These lama princes, who command in their respective districts, have the power of trying causes, and punishing

Sig-ans
||
Sight.

ing criminals; but their government is by no means burdensome; provided certain honours are paid them, and they receive punctually the dues of the god Fo, which amount to very little, they molest none of their subjects. The greater part of the Sig-ans live in tents; but some of them have houses built of earth, and even brick. Their habitations are not contiguous; they form at most but some small hamlets, consisting of five or six families. They feed a great number of flocks, and are in no want of any of the necessaries of life. The principal article of their trade is rhubarb, which their country produces in great abundance. Their horses are small; but they are well shaped, lively and robust.

These people are of a proud and independent spirit, and acknowledge with reluctance the superiority of the Chinese government, to which they have been subjected: when they are summoned by the mandarins, they rarely appear; but the government, for political reasons, winks at this contempt, and endeavours to keep their intractable subjects under by mildness and moderation: it would, besides, be difficult to employ rigorous means in order to reduce them to perfect obedience; their wild and frightful mountains (the tops of which are always covered with snow, even in the month of July) would afford them places of shelter, from which they could never be driven by force.

The customs of these mountaineers are totally different from those of the Chinese. It is, for example, an act of great politeness among them to present a white handkerchief of taffety or linen, when they accost any person whom they are desirous of honouring. All their religion consists in their adoration of the god Fo, to whom they have a singular attachment; their superstitious veneration extends even to his ministers, on whom they have considered it as their duty to confer supreme power and the government of the nation.

SIGAUILLIAN OPERATION, a method of delivery in cases of difficult labour, first practised by M. Sigault. It consists in enlarging the dimensions of the pelvis, in order to procure a safe passage to the child without injuring the mother.

SIGESBECKIA, a genus of plants belonging to the class of slygenesia, and to the order of polygonia superflua; and in the natural system ranging under the 49th order, *Compositæ*. See **BOTANY Index**.

SIGETHI, a town of Lower Hungary, and capital of a county of the same name. It is seated in a morass, and has a triple wall, with ditches full of water; and is defended by a citadel, being one of the strongest places in Hungary. It now belongs to the house of Austria, and was retaken from the Turks in 1669, after it had been blocked up two years. In some maps it is called *Zigar*. E. Long. 18. 53. N. Lat. 46. 17.

SIGHING, an effort of nature, by which the lungs are put into greater motion, and more dilated, so that the blood passes more freely, and in greater quantity, to the left auricle, and thence to the ventricle. Hence we learn, says Dr Hides, how sighing increases the force of the blood, and consequently proportionably cheers and relieves nature, when oppressed by its too slow motion, which is the case of those who are dejected and sad.

SIGHT, or VISION. See **ANATOMY**, N^o 142. and *Index* subjoined to **OPTICS**.

VOL. XIX. PART II.

Imperfection of Sight with regard to Colours. Under the article **COLOURS**, is given an instance of a strange deficiency of sight in some people, who could not distinguish between the different colours. In the Phil. Trans. vol. Ixxvii. p. 614. we have an account of a gentleman who could not distinguish a claret colour from black. These imperfections are totally unaccountable from any thing we yet know concerning the nature of the Eye.

Second Sight. See **SECOND Sight**.

SIGN, in general, the mark or character of something absent or invisible. See **CHARACTER**.

Among physicians, the term *sign* denotes some appearance in the human body which serves to indicate or point out the condition of the patient with regard to health or disease.

SIGN, in *Mythra*. See **ALLEGRIA**.

SIGN, in *Astronomy*, a constellation containing a 12th part of the zodiac. See **ASTRONOMY Ind. v.**

NAVAL SIGNALS. When we read at our fire-side the account of an engagement, or other interesting operation of an army, our attention is generally so much engaged by the reality, that we give but little to the movements which led to them, and produced them; and we seldom form to ourselves any distinct notion of the conduct of the day. But a professional man, or one accustomed to reflection, and who is not satisfied with the mere indulgence of eager curiosity, follows every regiment in its movements, endeavours to see their connection, and the influence which they have had on the fate of the day, and even to form to himself a general notion of the whole scene of action, at its different interesting periods. He looks with the eye of the general, and sees his orders succeed or fail.

But few trouble themselves farther about the narration. The movement is ordered; it is performed; and the fortune of the day is determined. Few think how all this is brought about; and when they are told that during the whole of the battle of Cullin, Frederic the Great was in the upper room of a country inn, from whence he could view the whole field, while his aids de camp, on horseback, waited his orders in the yard below, they are struck with wonder, and can hardly conceive how it can be done: but, on reflection, they see the possibility of the thing. Their imagination accompanies the messenger from the inn yard to the scene of action; they hear the general's orders delivered, and they expect its execution.

But when we think for a moment on the situation of the commander of a fleet, confined on board one ship, and this ship as much, or more closely, engaged, than any other of the fleet; and when we reflect that here are no messengers ready to carry his orders to ships of the Squadron at the distance of miles from him, and to deliver them with precision and distinctness, and that even if this were possible by sending small ships or boats, the vicissitudes of wind and weather may render the communication so tedious that the favourable moment may be irretrievably lost before the order can be conveyed.—When we think of all these circumstances, our thoughts are bewildered, and we are ready to imagine that a sea-battle is nothing but the unconnected struggle of individual ships; and that when the admiral has once cried *havoc*, and let slip the dogs of war,

X x

he

Sight
||
Naval
Signals

Naval
Signals
as well as
in modern;

he has done all that his situation empowers him to do, and he must leave the fate of the day to the bravery and skill of his captains and sailors.

Yet it is in this situation, apparently the most unfavourable, that the orders of the commander can be conveyed, with a dispatch that is not attainable in the operations of a land army. The scene of action is unincumbered, so that the eye of the general can behold the whole without interruption. The movements which it is possible to execute are few, and they are precise. A few words are sufficient to order them, and then the mere fighting the ships must always be left to their respective commanders. This simplicity in the duty to be performed has enabled us to frame a language fully adequate to the business in hand, by which a correspondence can be kept up as far as the eye can see. This is the language of SIGNALS, a language by writing, addressed to the eye, and which he that sunneth may read. As in common writing certain arbitrary marks are agreed on to express certain sounds used in speech, or rather, as in hieroglyphics certain arbitrary marks are agreed on to express certain thoughts, or the subjects of these thoughts; so here certain exhibitions are made, which are agreed on to express certain movements to be executed by the commander to whom they are addressed, and all are enjoined to keep their eyes fixed on the ship of the conductor of the fleet, that they may learn his will.

Used in
the most
times.

It is scarcely possible for any number of ships to act in concert, without some such mode of communication between the general and the commanders of private ships. We have no direct information of this circumstance in the naval tactics of the ancient nations, the Greeks and Romans; yet the necessity of the thing is so apparent, that we cannot suppose it to have been omitted by the most ingenious and the most cultivated people who have appeared on the great theatre of the world: and we are persuaded that Themistocles, Conon, and other renowned sea commanders of Athens, had signals by which they directed the movements of their fleets. We read, that when Ægeus sent his son Theseus to Crete, it was agreed on, that if the ship should bring the young prince back in safety, a white flag should be displayed. But those on board, in their joy for revisiting their country after their perilous voyage, forgot to hoist the concerted signal. The anxious father was every day expecting the ship which should bring back his darling son, and had gone to the shore to look out for her. He saw her, but without the signal agreed on. On which the old man threw himself into the sea. We find, too, in the history of the Punic wars by Polybius, frequent allusions to such a mode of communication; and Ammianus Marcellinus speaks of the *speculatores* and *veicularii*, who were on board the ships in the Adriatic. The coins both of Greece and Rome exhibit both flags and streamers. In short, we cannot doubt of the ancients having practised this hieroglyphical language. It is somewhat surprising that Lord Dudley, in his *Arcano del Mare*, in which he makes an ostentatious display of his knowledge of every thing connected with the sea service, makes no express mention of this very essential piece of knowledge, although he must, by his long residence in Italy, have known the marine discipline of the Venetians and Genoese, the greatest maritime powers then in Europe.

In the naval occurrences of modern Europe, mention is frequently made of signals. Indeed, as we have already observed, it seems impossible for a number of ships to act in any kind of concert, without some method of communication. Numberless situations must occur, when it would be impossible to convey orders or information by messengers from one ship to another, and coal and alarm signals had long been practised by every nation. The idea, therefore, was familiar. We find, in particular, that Queen Elizabeth, on occasion of the expedition to Cadiz, ordered her secretaries to draw up instructions, which were to be communicated to the admiral, the general, and the five counsellors of war, and by them to be copied and transmitted to the several ships of the navy, not to be opened till they should arrive in a certain latitude. It was on this occasion (says our historian Guthrie,) "that we meet with the first regular sets of signals and orders to the commanders of the English fleet." But, till the movements of a fleet have attained some sort of uniformity, regulated and connected by some principles of propriety, and agreed on by persons in the habit of directing a number of ships, we may with confidence affirm that signals would be nothing but a parcel of arbitrary marks, appropriated to particular pieces of naval service, such as attacking the enemy, landing the soldiers, &c.; and that they would be considered merely as referring to the final result, but by no means pointing out the mode of execution, or directing the movements which were necessary for performing it.

It was James II. when duke of York, who first considered this practice as capable of being reduced into a system, and who saw the importance of such a composition. He, as well as the king his brother, had always showed a great predilection for the sea service; and, when appointed admiral of England, he turned his whole attention to its improvement. He had studied the art of war under Turenne, not as a pastime, but as a science, and was a favourite pupil of that most accomplished general. Turenne one day pointed him out, saying, "Behold one who will be one of the first princes and greatest generals of Europe." When admiral of England, he endeavoured to introduce into the maritime service all those principles of concert and arrangement which made a number of individual regiments and squadrons compose a great army. When he commanded in the Dutch war, he found a fleet to be little better than a collection of ships, on board of each of which the commander and his ship's company did their best to annoy the enemy, but with very little dependence on each other, or on the orders of the general: and in the different actions which the English fleet had with the Dutch, every thing was confusion as soon as the battle began. It is remarkable that the famous pensionary De Witt, who from a statesman became a navigator and a great sea commander in a few weeks, made the same representation to the States General on his return from his first campaign.

In the memoirs of James II. written by himself, we have the following passage: "1665. On the 15th of March, the duke of York went to Gunfleet, the general rendezvous of the fleet, and hastened their equipment. He ordered all the flag officers on board with him every morning, to agree on the order of battle and rank. In former battles, no order was kept, and this

under

Naval
Signals

under the duke of York, was the first in which fighting in a line and regular form of battle was observed."

This must be considered as full authority for giving the duke of York the honour of the invention. For whatever faults may be laid to the charge of this unfortunate prince, his word and honour stand unimpeached. And we are anxious to vindicate his claim to it, because our neighbours the French, as usual, would take the merit of this invention, and of the whole of naval tactics, to themselves. True it is, that Colbert, the great and justly celebrated minister of Louis XIV. created a navy for his ambitious and vain-glorious master, and gave it a constitution which may be a model for other nations to copy. By his encouragement, men of the greatest scientific eminence were engaged to contribute to its improvement; and they gave us the first treatises of naval evolutions. But it must ever be remembered, that our accomplished, though misguided sovereign, was then residing at the court of Louis; that he had formerly acted in concert with the French as a commander and flag officer, and was at this very time aiding them with his knowledge of sea affairs. In the memorable day at La Hogue, the gallant Ruffel, observing one of Tourville's movements, exclaimed, "There! they have got Peyp's * among them." This anecdote we give on the authority of a friend, who heard an old and respectable officer (Admiral Clifton) say, that he had it from a gentleman who was in the action, and heard the words spoken; and we trust that our readers will not be displeas'd at having this matter of general opinion established on some good grounds.

* Peyp's
was secretary
to the
duke of
York.5
Wanderful
simplicity
of his sy-
stem;

It was on this occasion, then, that the duke of York made the movements and evolutions of a fleet the object of his particular study, reduced them to a system, and composed that "System of Sailing and Fighting Instructions," which has ever since been considered as the code of discipline for the British navy, and which has been adopted by our rivals and neighbours as the foundation of their naval tactics. It does great honour to its author, although its merit will not appear very eminent to a careless surveyor, on account of that very simplicity which constitutes its chief excellence. It is unquestionably the result of much sagacious reflection and painful combination of innumerable circumstances, all of which have their influence; and it is remarkable, that although succeeding commanders have improved the subject by several subordinate additions, no change has to this day been made in its general principles or maxims of evolution.

Till some such code be established, it is evident that signals can be nothing but arbitrary and unconnected hieroglyphics, to be learned by rote, and retained by memory, without any exercise of the judgement; and the acquisition of this branch of nautical skill must be a more laborious task than that of learning the Chinese writing. But such a code being once settled, the character in which it may be expressed becomes a matter of rational discussion.

Accordingly, the sailing and fighting instructions of the duke of York were accompanied by a set of signals for directing the chief or most frequent movements of the fleet. These also were contrived with so much judgement, and such attention to distinctness, simplicity, and propriety, that there has hardly been any change found necessary; and they are still retained in the Bri-

tish navy as the usual signals in all cases when we are not anxious to conceal our movements from an enemy.

Notwithstanding this acknowledged merit of the duke of York's signals, it must be admitted that great improvements have been made on this subject, considered as an art. The art military has, in the course of a few centuries past, become almost an appropriate calling, and has therefore been made the peculiar study of its professors. Our rivals the French were first, and more formally placed in this situation; and the ministers of Louis XIV. took infinite and most judicious pains to make their military men superior to all others by their academical education. A more liberal turn was given to their education, and the assistance of scientific men was liberally given them; and all the nations of Europe must acknowledge some obligation to them for information on every thing connected with the art of war. They have attended very much to this subject, have greatly improved it, and have even introduced a new principle into the art; and by this means have reduced it to the most simple form of reference to the code of sailing and fighting instructions, by making the signals immediately expressive, not of ends, but of simple numbers. These numbers being related to the various articles of the code of instructions, the officer who sees a flag thrown out by the admiral reads the number, and reports it to his captain, perhaps without knowing to what it relates. Thus simplicity and feceracy, with an unlimited power of variation, are combined. We believe that M. de la Bourdonnais, a brave and intelligent officer, during the war 1755, was the author of this ingenious thought.

We do not propose to give a system of British signals. This would evidently be improper. But we shall show our readers the practicability of this curious language, the extent to which it may be carried, and the methods which may be practised in accomplishing this purpose. This may make it an object of attention to scientific men, who can improve it; and the young officer will not only be able to read the orders of the commander in chief, but will not be at a loss, should circumstances place him in a situation where he must issue orders to others.

Signals may be divided into,

I. DAY SIGNALS.

II. NIGHT SIGNALS; and,

III. SIGNALS in a Fog.

They must also be distinguished into, 1. Signals of EVOLUTION, addressed to the whole FLEET, or to SQUADRONS of the fleet, or to DIVISIONS of these squadrons. 2. Signals of MOVEMENTS to be made by particular ships; and, 3. Signals of SERVICE, which may be either general or particular.

The great extent of a large fleet, the smoke in time of battle, and the situation of the commander in chief, who is commonly in the middle of the greatest confusion, and hottest fire, frequently makes it very difficult for the officers of distant ships to perceive his signals with distinctness. Frigates, therefore, are stationed out of the line, to windward or to leeward, whose sole office it is to observe the admiral's signals, and instantly to repeat them. The eyes of all the signal officers in the private ships of war are directed to the repeating frigates, as well as to the admiral; and the officers of the repeating frigate, having no other duty, observe the admiral incessantly,

Small
Signal
Every evolution signal is unambiguously defined, can display the signal with illustration, so that it may be very distinctly seen. Being minutely acquainted with the different evolutions which must be made on board the admiral when his masts and rigging are in disorder, his (perhaps imperfect) signal is assisted by the repeating figure in its proper form, so as to be easily understood. And to facilitate this communication, the commanders of the different squadrons repeat the signals of the commander in chief, and the commanders of division repeat the signals of the commanders of their squadron.

Every evolution signal is preceded by a signal of **ADVERTISEMENT AND PREPARATION**, which is general, and frequently by a gun, to call attention; and when all the signals have been made which direct the different parts of that evolution, another signal is made, which marks the close of the complex signal, and divides it from others which may immediately follow it; and as the orders of the commander in chief may relate either to the movements of the whole fleet, those of a single division, or those of certain private ships, the **EXECUTIVE SIGNAL**, which dictates the particular movement, is accompanied by a **DIRECTIVE SIGNAL**, by which these ships are pointed out, to which the order is addressed.

The commander of the ship to which any signal is addressed, is generally required to signify by a signal (which is general) that he has observed it. And if he does not thoroughly understand its meaning, he intimates this by another general signal. And here it is to be observed, that as soon as the signal is answered by the ships to which it is addressed, it is usual to haul it down, to avoid the confusion which might arise from others being hoisted in the same place. The order remains till executed, notwithstanding that the signal is hauled down.

It may happen that the commander who throws out the signal for any piece of service, sees reasons for altering his plan. He intimates this by a general **ANNULLING** signal, accompanying the signal already given. This will frequently be more simple than to make the signals for the movements which would be required for re-establishing the ships in their former situation.

All these things are of very easy comprehension, and require little thought for their contrivance. But when we come to the particular evolutions and movements, and to combine these with the circumstances of situation in which the fleet may be at the time, it is evident, that much reflection is necessary for framing a body of signals which may be easily exhibited, distinctly perceived, and well understood, with little risk of being mistaken one for another. We shall take notice of the circumstances which chiefly contribute to give them these qualities as we proceed in describing their different classes.

I. OF DAY SIGNALS.

THESE are made by means of the ship's sails, or by colours of various kinds.

Those made with sails are but few in number, and are almost necessarily limited to the situation of a fleet at anchor. Thus,

The former of Signals	usually signify
Main topgallant stayfall hoisted	Officers and men belonging to the ship to come on board.
Tore topfall loose	To prepare for sailing.
Main topfall loose	To unmoor.
Main topfall sheets hauled home	To weigh.
Main topfall sheets clewed up, and the yard hoisted	Annul the former signal, and the ship to come to an anchor.
Topgallant sails loose, and the sheets flying	Discovering strange sails.
Main-topgallant tail loose and hoisted. Toplayard down	Recall ships in chase.
Mizen topfall hoisted, and the sheets clewed up	Moor.

Before we proceed to the description of the signals by means of colours, such as **FLAGS**, **BANNERS** (or triangular flags), **PENDANTS** or **VANES**, we must take notice of the observable distinctions of the various divisions and subdivisions of a fleet, so that we may understand how the same signal may be addressed to a squadron, division, or single ship or ships. We suppose it known that a fleet of ships of war is distributed into three grand divisions (which we shall term *squadrons*), called the *van*, *centre*, and *rear*. These denominations have not always a relation to the one being more advanced than the other, either towards the enemy, or in the direction of their course.

In a land army, the position of every part is conceived from its reference to the enemy; and the reader, conceiving himself as facing the enemy, easily understands the terms *van*, *centre*, and *rear*, the *right* and *left*, *wing*, &c. But the movements of a sea army having a necessary dependence on the wind, they cannot be comprehended unless expressed in a language which keeps this circumstance continually in view. The simplest and most easily conceived disposition of a fleet, is that in which it is almost indispensably obliged to form in order to engage an enemy. This is a straight line, each ship directly ahead of its neighbour, and close hauled. This is therefore called the *line of battle*. In this position, the two extremities of the fleet correspond to the right and left wings of an army. Suppose this line to be in the direction east and west, the wind blowing from the north-north-west, and therefore the fleet on the starboard tack; the ships heads are to the west, and the weathermost division is undoubtedly the van of the fleet, and the easternmost division is the rear. And it is in conformity to this arrangement and situation that the **LIST OF THE FLEET** is drawn up. But the ships may be on the same east and west line, close hauled, with their heads to the west, but the wind blowing from the south-south-west. They must therefore be on the larboard tack. The same ships, and the same division, are still, in fact, the van of the fleet. But suppose the ships heads to be to the eastward, and that they are close hauled,

Naval
Signals

hailed, having the wind from the south-south-east or the north-north-east, the ships which were the rear van on both tacks in the former situation are now, in fact, the rear on both tacks; yet they retain the denomination of the *van Squadron* of this fleet, and are under the immediate direction of the officer of the second rank, while the other extremity is under the direction of the third officer. This subordination therefore is rather an arrangement of rank and precedence than of evolution. It is, however, considered as the natural order to which the general signals must be accommodated. For this reason, the division which is denominated *van* in the list of this fleet, is generally made to lead the fleet when in the line of battle on the starboard tack, and to form the *van* column in the order of sailing in *ex-lucis*; and, in general, it occupies that station from which it can most easily pass into the place of the leading division on the starboard line of battle ahead. Although this is a technical object of language, and may frequently puzzle a landman in reading an account of naval operations, the reflecting and intelligent reader will see the propriety of retaining this mode of conceiving the subordinate arrangement of a fleet, and will comprehend the employment of the signals which are necessary for re-establishing this arrangement, or directing the movements while another arrangement is retained.

13
How signals are addressed to each of these divisions.

This being understood, it is easy to contrive various methods of distinguishing every ship by the place which she occupies in the fleet, both with respect to the whole line, with respect to the particular squadron, the particular division of that squadron, and the particular place in that division. This may be done by a combination of the position and colour of the pendants and vanes of each ship. Thus the colour of the pendants may indicate the squadron, their position or suit on which they are hoisted may mark the division of that squadron, and a distinguishing vane may mark the place of the private ship in her own division. The advantages attending this method are many. In a large fleet it would hardly be possible for the commander in chief to find a sufficient variety of single signals to mark the ship to which an order is addressed, by hoisting it along with the signal appropriated to the intended movement. But by this contrivance one-third part of these signals of address is sufficient. It also enables the commander in chief to order a general change of position by a single signal, which otherwise would require several. Thus, suppose that the fore, main, and mizen masts, are appropriated (with the proper modifications) for exhibiting the signals addressed to the van, the centre, and the rear squadrons of the fleet, and that a red, a white, and a blue flag, are chosen for the distinguishing flags of the officers commanding these squadrons; then, if the commander in chief shall hoist a red flag at his mizen top-gallant mast head, it must direct the van squadron to take the position then occupied by the rear squadron, the evolution necessary for accomplishing this end being supposed known by the commander of the squadron, who will immediately make the necessary signals to the squadron under his particular direction. In the same manner, the distinguishing signal for the leading ship of a squadron being hoisted along with the signal of address to the whole fleet, and the signal for any particular ser-

vice, will cause the three or the nine leading ships to execute that order, &c. &c.

Naval
Signals.

All that has been said hitherto may be considered as so many preparations for the real issuing of orders by the commander in chief. The most difficult part of the language remains, viz. to invent a number of signals which shall correspond to that almost infinite variety of movements and services which must be performed.

Distinctness, simplicity, and propriety, are the three essential qualities of all signals. A signal must be formed so as to be easily seen, strongly marked, so that it may be readily understood, with little risk of its being mistaken for another. When made by flags, banners, or pendants, they must be of the fittest colour, and strongest contrasts. The ships are frequently at a very great distance, so that the intervening air occasions a great degradation of colour. They are seen between the eye and a very variable sky; and in this situation, especially in the morning or evening, or a dark day, it is not easy to distinguish one full colour from another, all of them approaching to the appearance of a black. At the distance of a very few miles hardly any full colours can be distinguished but a scarlet and a blue. Red, blue, yellow, and white, are the colours which can be distinguished at greater distances than any others, and are therefore the only colours admitted as signals. Even these are sometimes distinguished with difficulty. A yellow is often confounded with a dirty white, and a blue with a red. All other dark colours are found totally unfit. But as these afford but a small variety, we must combine them in one flag, by making it striped, spotted, or chequered, taking care that the opposition of colour may be as great as possible, and that the pieces of which the flags are made up may not be too minute. Red must never be striped nor spotted with blue; and the stripes, spots, or chequers, should never be less than one-third of the breadth of the flag. Plate CCCCXCVI is a selection by an officer of experience as a fit very easily recognized, and little liable to be confounded. Their colours are represented by latching, in the same manner as in heraldry (see HERALDRY).

Difference of shape, as flags, banners, or pendants, is another distinction by which the expression may be varied. And in doing this, we must recollect, that in light winds it may be difficult to distinguish a flag from a banner, as neither are fully displayed for want of wind to detach the fly from the staff.

And, lastly, signals may be varied by their position, which may be on any lofty and well detached part of the masts, yards, or rigging.

Simplicity is an eminent property in all signals. They are addressed to persons not much accustomed to combinations, and who are probably much occupied by other pressing duties. It were to be wished that every piece of service could be indicated by a single flag. This is peculiarly desirable with respect to the signals used in time of battle. The rapid succession of events on this occasion call for a multitude of orders from the commander in chief, and his ship is frequently clad over with flags and pendants, so that it is exceedingly difficult for the signal officer of a private ship to distinguish the different groups, each of which make a particular signal.

Ther

Naval
Signals
15
and private

These considerations are the foundation of a certain propriety in signals, which directs us to a choice among marks which appear altogether arbitrary. Signals which run any risk of being confounded, on account of some resemblance, or because their position hinders us from immediately perceiving their difference, should be appropriated to pieces of service which are hardly possible to be executed, or can hardly be wanted, in the same situation. No bad consequence could easily result though the signal for coming to close action should resemble that for unmooring, because the present situation of the ships makes the last operation impossible or absurd. Such considerations direct us to select for battle signals, those which are of easiest exhibition, are the most simple, and have the least dependence on the circumstance of position; so that their signification may not be affected by the damages sustained in the masts or rigging of the flag ship. Such signals as are less easily seen at a distance, should be appropriated to orders which can occur only in the middle of the fleet, &c. &c. Signals which are made to the admiral by private ships may be the same with signals of command from the flag ship, which will considerably diminish the number of signals perfectly different from each other.

16
By what
means sig-
nals are
distinctly
conveyed,

With all these attentions and precautions a system of signals is at last made up, fitted to the code of sailing and fighting instructions. It is accompanied by another small list for the duty of convoys. It must be engrossed in two books; one for the officer of the flag ship, who is to make the signals, and the other is delivered to every private ship. In the first, the evolutions, movements, and other operations of service, are set down in one column, and their corresponding signals in another. The first column is arranged, either alphabetically, by the distinguishing phrase, or systematically, according to the arrangement of the sailing and fighting instructions. The officer whose duty it is to make the signals, turns to this column for the order which he is to communicate, and in the other column he finds the appropriated signal.

17
and under-
stood.

In the other book, which is consulted for the interpretation of the signals, they are arranged in the leading column, either by the flags, or by the places of their exhibition. The first is the best method, because the derangement of the flag ship's masts and rigging in time of action may occasion a change in the place of the signal.

18
The art of
signals
much im-
proved
since the
publication
of the *Tac-
tique Na-
vale*.

The *Tacique Navale* of the Chevalier de Morogues contains a very full and elaborate treatise on signals. We recommend this work to every sea-officer, as full of instruction. The art of signals has been greatly simplified since the publication of this work, but we cannot but ascribe much of the improvements to it. We believe that the author is the inventor of that systematic manner of addressing the order or *effective signal* to the different squadrons and divisions of the fleet, by which the art of signals is made more concise, the execution of orders is rendered more systematic, and the commanders of private ships are accustomed to consider themselves as parts of an army, with a mutual dependence and connection. We are ready enough to acknowledge the superiority of the French in manœuvring, but we affect to consider this as an imputation on their courage. Nothing can be more unjust; and dear-bought experience should long ere now have taught us the value of this superiority.

Naval
Signals.

What avails that courage which we would willingly arrogate to ourselves, if we cannot come to action with our enemy, or must do it in a situation in which it is almost impossible to succeed, and which needlessly throws away the lives of our gallant crews? Yet this must happen, if our admirals do not make evolutions their careful study, and our captains do not habituate themselves, from their first hoisting a pendant, to consider their own ship as connected with the most remote ship in the line. We cannot think that this view of their situation would in the least lessen the character which they have so justly acquired, of fighting their ship with a courage and firmness unequalled by those of any other nation. And we may add, that it is only by such a rational study of their profession, that the gentleman can be distinguished from the mercenary commander of a privateer.

II. NIGHT SIGNALS.

It is evident, that the communication of orders by night must be more difficult and more imperfect than by day. We must, in general, content ourselves with such orders as are necessary for keeping the fleet together, by directing the more general movements and evolutions which any change of circumstances may render necessary. And here the division and subordinate arrangement of the fleet is of indispensable necessity, it being hardly possible to particularise every ship by a signal of address, or to see her situation. The orders are therefore addressed to the commanders of the different divisions, each of whom is distinguished by his poop and top-lights, and is in the middle of, and not very remote from, the ships under his more particular charge. Yet even in this unfavourable situation, it is frequently necessary to order the movements of particular ships. Actions during the night are not uncommon. Pursuits and rallies are still oftener carried on at this time. The common dangers of the sea are as frequent and more disastrous. The system of signals therefore is very incomplete till this part be accomplished.

Night signals must be made by guns, or by lights, or by both combined.

Gun-signals are susceptible of variety both in number and in disposition. The only distinct variation which can be made in this disposition, is by means of the time elapsed between the discharges. This will easily admit of three varieties, slow, moderate, and quick.—Half-minute guns are as slow as can easily be lifted to as appertaining to one signal. Quarter-minute guns are much better, and admit of two very distinct subdivisions. When the gunners, therefore, are well trained to this service (especially since the employment of firelocks for cannon), intervals of 15 or 12 seconds may be taken for slow firing, 8 or 10 seconds for moderate, and 4 or 5 seconds for quick firing. If these could be reduced one half, and made with certainty and precision, the expression would be incomparably more distinct. A very small number of firings varied in this way will give a considerable number of signals. Thus five guns, with the variety of only quick and moderate, will give 20 very distinguishable signals. The same principle must be attended to here as in the flag signals. The most simple must be appropriated to the most important orders, such as occur in the worst weather, or such as are

19
How gun-
signals may
be varied.

Naval
Signals

is liable to be mistaken. Quick firing should not make part of a signal to a very distant ship, because the noise of a gun at a great distance is a lengthened sound, and two of them, with a very short interval, are apt to coalesce into one long-continued sound. This mode of varying gun-signals by the time must therefore be employed with great caution, and we must be very certain of the steady performance of the gunners.

Note, that a preparatory signal or advertisement that an effective signal is to be made, is a very necessary circumstance. It is usual (at least in hard weather) to make this by a double discharge, with an interval of half a second, or at most a second.

Gun-signals are seldom made alone, except in ordinary situations and moderate weather; because accident may derange them, and inattention may cause them to escape notice, and, once made, they are over, and their repetition would change their meaning. They are also improper on an enemy's coast, or where an enemy's cruisers or fleets may be expected.

Signals by lights are either made with LIGHTS simply or called, i. e. lanterns shown in different parts of the ship, or by rockets. Lights may differ by number, and by position, and also by figure. For the flag ship always carries four or top-lights, or both, presents an object in the darkest night, so that we can tell whether the additional lights are exhibited about the mainmast, the foremast, the mizzenmast, &c. And if the lights shown from any of these situations are arranged in certain distinguishable situations in respect to each other, the number of signals may be greatly increased. Thus three lights may be in a vertical line, or in a horizontal line, or in a triangle; and the point of this triangle may be up, or down, or forward, or aft, and thus may have many significations.

Lights are also exhibited by false fires or rockets: These can be varied by number, and by such differences of appearance as to make them very distinguishable. Rockets may be with stars, with rain fire, or simple squibs.

By varying and combining these, a very great number of signals may be produced, fully sufficient to direct every general movement or evolution, or any ordinary and important service. The Chevalier de Morogues has given a specimen of such a system of night signals, into which he has even introduced signals of address or direction to every ship of a large fleet; and has also given signals of number, by which depths of soundings, points of the compass, and other things of this kind, may be expressed both easily and distinctly. He has made the signals by rockets perfectly similar in point of number to those by lanterns, so that the commander can take either; a choice which may have its use, because the signals by rockets may cause the presence of a fleet to be more extensively known than may be convenient.

The commander in chief will inform the fleet by signal, that guns, or pistols or rockets, are not to be used that night. This signal, at the same time, directs the fleet to close the line or column, that the light signals may be better observed.

It is indeed a general rule to show as few lights as possible; and the commander frequently permits his own poop and top-lights, or allowing them from time to time, that his ships may keep around him.

The signal lanterns on board the flag ship, and a lantern kept in readiness on board of every private ship, to answer or acknowledge signals from the commander in chief, are all kept in bags, to conceal their lights till the moment they are fixed in their places, and the preparatory or advertising signal has been made.

The commander in chief sometimes orders by signal every ship to show a light for a minute or two, that he may judge of the position of the fleet; and the admiral's signal must always be acknowledged by those to whom it is addressed.

It is of particular importance that the fleet be kept together. Therefore the leading ships of the fleet, on either tack, are obliged to acknowledge the signals of the commander in chief by a signal peculiar to their station. Thus the commander in chief learns the position of the extremities of his fleet.

In firing a set of night signals, great attention must be given to their position, that they be not obscured by the sails. The nature of the order to be given will frequently determine this. Thus, an order for the rear ships to make more sail, will naturally direct us to exhibit the signal at the tizen peck; and so of other pieces of service. Lanterns expel in groups, such as triangles, lozenges, &c. are commonly suspended at the corners of large frames of laths, at the distance of a fathom at least from each other. Attempts have been made to show light of different colours; but the risk of mistake or failure in the composition at the laboratory, makes this rather hazardous. Coloured lanterns are more certain; but when the glasses are made of a colour full of intensity, the vivacity of the light (which at no time is very great) is too much diminished. Besides, the very distance changes the colour exceedingly and unaccountably.

III. Of SIGNALS in a Fog.

These can be made only by nois, such as the firing of cannon and muskets, the beating of drums and ringing of bells, &c. Fog signals are the most difficult to contrive of any, and are the most difficult of the least variety. The commander in chief is principally concerned to keep his fleet together; and unless something very urgent requires it, he will make no change in his course or rate of sailing. But a shift of wind or other cause may make this necessary. The changes which he will order, it will be prudent to regulate by some fixed rule, which is in general convenient. Thus, when a fleet is in the order of sailing upon a wind, and a fog comes on, the fleet will hold on the same course. If the wind should come a little more on the beam, the fleet will still keep close to the wind. Certain general rules of this kind being agreed on, no signals are necessary for keeping the fleet together; and the ships can separate or return to each other only by difference in their rate of sailing, or by inaccurate cleavage. To prevent this, the commander in chief fires a gun from time to time, and the ships of the fleet judge of his situation and distance by the sound. The commanders of divisions fire guns, with some direction from those of the commander in chief. This both informs the commander in chief of the position of his squadron, and enables the private ships of each division to keep in the middle of their own division. On board of every ship, a bell to draw in boats, or the bell is struck every

Naval
Signals20
Signals by
lights.21
These two
species of
signals may
be com-
bined.22
General ob-
servations
concerning
night sig-
nals.page 352
of the
signals
of the
fleet
of the
fleet
of the
fleet

quarter of an hour, according as the ship is on the star-board or larboard tack. By such contrivances, it is never difficult to keep a fleet in very good order when sailing on a wind. The wind is almost always moderate, and the ships keep under a very easy sail. It is much more difficult when going large, and separation can be prevented only by the most unwearied attention. The greatest risk is the falling in with strange ships steering another course.

But evolutions and other movements are frequently indispensable. The course must be changed by tacking or wearing, and other services must be performed. None, however, are admitted but the most probable, the most simple, and the most necessary.

The commander in chief will inform the fleet by the preparatory signal, that he is about to order an evolutio, and that he is to direct it by flag signals. This precaution is indispensable to prevent mistakes. Along with this advertising signal he makes the signal of the movement intended. This not only calls the attention of the fleet, but makes the ships prepare for the precise execution of that movement. The commanders of divisions repeat the advertising signal, which informs their ships of their situation, and the private ships beat their drums or chime their bells. Thus the whole fleet of the fleet close a little, and become a little better acquainted with their mutual position. It is now understood that a movement is to be made precisely a quarter of an hour after the advertisement. At the expiration of this time, the effective signal for this movement is made by the commander in chief, and must be instantly repeated by the commanders of divisions, and then the movement must be made by each ship, according to the sailing and fighting instructions. This must be done with the utmost attention and precision, because it produces a prodigious change in the relative position of the ships; and even although the good sense of the commander in chief will select such movements for accomplishing his purpose as produce the smallest alterations, and the least risk of separation or running foul of each other; it is still extremely difficult to avoid these misfortunes. To prevent this as much as possible, each ship which has executed the movement, or which has come on a course thwarting that of the fleet, intimates this by a signal properly adapted, often adding the signal of the tack on which it is now standing, and even its particular signal of recognizance. This is particularly incumbent on the flag ships and the leading ships of each division.

After a reasonable interval, the commander in chief will make proper signals for bringing the fleet to a knowledge of their reunion in this new position.

This must serve for a general account of the circumstances which must be attended to in framing a code of signals. The arbitrary characters in which the language is written must be left to the sagacity of the gentlemen of the profession. It must be observed, that the stratagems of war make secrecy very necessary. It may be of immense hazard if the enemy should understand our signals. In time of battle it might frequently frustrate our attempts to destroy them, and at all times would enable them to escape, or to throw us into disorder. Every commander of a squadron, therefore, issues private signals, suited to his particular destination; and therefore it is necessary that our code of signals be

suceptible of endless variations. This is exceedingly easy without any increase of their number. The commander needs only intimate that such and such a signal is to and to changed in its meaning during his command.

We cannot leave this article without returning to an observation which we made almost in the beginning, viz. that the system of signals, or, to speak more properly, the manner of framing this system, has received much improvement from the gentlemen of the French navy, and particularly from the most ingenious thought of M. de la Boudonnais, of making the signals the immediate expressions of numbers only, which numbers may be afterwards used to indicate any order whatever. We shall present our readers with a scheme or two of the manner in which this may be done for all signals, both day, night, and fog. This alone may be considered as a system of signals, and is equally applicable to every kind of information at a distance. Without detracting in the smallest degree from the praise due to M. de la Boudonnais, we must observe, that this principle of notation is of much older date. Bishop Wilkins, in his Secret and Swift Messenger, expressly recommends it, and gives specimens of the manner of execution; so does Dr Hooke in some of his proposals to the Royal Society. Gaspar Schottus also mentions it in his *Technica Curiosa*; and Kircher, among others of his Curious Projects.

M. de la Boudonnais's method is as follows:

He chooses pendants for his effective signals, because they are the most easily displayed in the proper order. Several pendants, making part of one signal, may be hoisted by one hallyard, being stopped on it at the distance of four or six feet from each other. If it be found proper to throw out another signal at the same time and place, they are separated by a red pendant without a point. His colours are chosen with judgement, being very distinctly recognized, and not liable to be confounded with the addressing signals appropriated to the different ships of the fleet. They are,

- | | |
|----------------------------|--|
| For N ^o 1. Red. | For N ^o 6. Red, with blue tail. |
| 2. White. | 7. White, with blue tail. |
| 3. Blue. | 8. White, with red tail. |
| 4. Yellow. | 9. Blue, with yellow tail. |
| 5. Red, with white tail. | 10. Yellow, with blue tail. |

Three sets of such pendants will express every number under a thousand, by hoisting one above the other, and reckoning the uppermost hundreds, the next below it tens, and the lowest units. Thus the number 643 will be expressed by a pendant red with blue tail, a yellow pendant below it, and a blue one below the tail.

This method has great advantages. The signals may be hoisted in any place where best seen, and therefore the signification is not affected by the derangement of the flag ship's masts and rigging. And by appropriating the smaller numbers to the battle signals, they are more simple, requiring fewer pendants.

As this method requires a particular set of colours, it has its inconveniences. An admiral is often obliged to shift his flag, even in time of action. He cannot easily take the colours along with him. It is therefore better to make use of such colours as every private ship is provided with. One set of 11 will do, with the addition

Naval
Signals.

dition of three, at most of four pendants, of singular make, to mark 100, 200, 300, 400. Two of these flags, one above the other, will express any number under 100, by using the 11th as a substitute for any flag that should be repeated. Thus the 11th flag, along with the flag for eight or for six, will express the number 88 or 66, &c. Thus we are able to express every number below 500, and this is sufficient for a very large code of signals.

And in order to diminish as much as possible the number of these compound signals, it will be proper that a number of single flag signals be preserved, and even varied by circumstances of position, for orders which are of very frequent occurrence, and which can hardly occur in situations where any obstructions are occasioned by loss of masts, &c. And farther, to avoid all chance of mistake, a particular signal can be added, intimating that the signals now exhibited are numerary signals; or, which is still better, all signals may be considered as numerary signals; and those which we have just now called *single flag signals* may be set down opposite to, or as expressing, the largest numbers of the code.

This method requires the signal of advertisement, the annulling signal, the signal of address to the particular ship or division, the signal of acknowledgement, the signal of indistinctness, of distress, of danger, and one or two more which, in every method, must be employed.

Another method of expressing numbers with fewer colours is as follows: Let the flags be A, B, C, D, E, F, and arrange them as follows:

	A	B	C	D	E	F
A	1	2	3	4	5	6
B	7	8	9	10	11	12
C	13	14	15	16	17	18
D	19	20	21	22	23	24
E	25	26	27	28	29	30
F	31	32	33	34	35	36
	37	38	39	40	41	42

The number expressed by any pair of flags is found in the intersection of the horizontal and perpendicular columns. Thus the flag D, hoisted along with and above the flag F, expresses the number 40, &c. In order to express a greater number (but not exceeding 84) suppose 75, hoist the flags $\overset{C}{E}$, which expresses 33, or 75 wanting 42, and above them a flag or signal G, which alone expresses 42.

This method may be still farther improved by arranging the flags thus:

	A	B	C	D	E	F
A	1	2	3	4	5	6
B	7	8	9	10	11	12
C	—	13	14	15	16	17
D	—	—	18	19	20	21
E	—	—	—	22	23	24
F	—	—	—	—	25	26
	—	—	—	—	—	27

In this last method the signification of the signal is totally independent of the position of the flags. In whatever parts of the ship the flags D and E are seen,

Vol. XIX. Part I.

they express the number 23. This would suit battle signals.

Another method still may be taken. Flags hoisted anywhere on the foremast may be accounted units, those on the mainmast tens, and those on the mizenmast hundreds. Thus numeral signals may be made by a ship dimasted, or having only poles in their place.

Many other ways may be contrived for expressing numbers by colours, and there is great room for exercising the judgement of the contriver. For it must always be remembered, that these signals must be accompanied with a signal by which it is addressed to some particular ship or division of the fleet, and it may be difficult to connect the one with the other, which is perhaps shown in another place, and along with other executive signals.

One great advantage of these numeral signals is, that they may be changed in their signification at pleasure. Thus, in the first method, it can be settled, that on Sundays the colours A, B, C, D, &c. express the cyphers 1, 2, 3, 4, &c. but that on Mondays they express the cyphers 0, 1, 2, 3, &c. and on Tuesdays the cyphers 9, 0, 1, 2, &c.; and so on through all the days of the week. This mean of secrecy is mentioned by Dr Hooke for the coast and alarm signals, where, by the by, he shews a method for conveying intelligence over land very similar to what is now practised by the French with their telegraph.

It is equally easy to express numbers by night signals. Thus M. de la Bourdonnais proposes, that one discharge of a great gun shall express 7, and that 1, 2, 3, 4, 5, 6 shall be expressed by lights. Therefore, to express 24, we must fire three guns, and show three lights. This is the most perfect of all forms of night and fog signals. For both the manner of firing guns and of exhibiting lights may be varied to a sufficient extent with very few guns or lights, and with great distinctness.

Thus, for guns. Let F mark the firing of a single gun at moderate intervals, and *ff* a double gun, that is, two discharged at the interval of a second. We may express numbers thus:

1	F.
2	F, F.
3	F, F, F.
4	F, F, F, F.
5	F, ff.
6	F, F, ff.
7	F, ff, F.
8	F, ff, F, F.
9	F, ff, F, ff.
10	ff.
100, &c.	ff, ff, ff, or fff.

It might be done with fewer guns if the *ff* were admitted as the first firing. But it seems better to begin always with the single gun, and thus the double gun beginning a signal distinguishes the tens &c.

In like manner, a small number of lights will admit of a great variety of very distinct positions, which may serve for all signals to ships not very remote from the commander in chief. For orders to be understood at a very great distance, it will be proper to appropriate the numbers which are indicated by signals made with

Y y

rocket.

29
Another
method of
expressing
numbers by
fewer col-
ours.

30
which may
be also im-
proved.

Naval
Signals.

31
the 1

32
Advantage
of numeral
signals.

33
Numbers
may be also
expressed
by night
signals.

Naval
Signature

rockets. These can be varied in number and kind to a sufficient extent, so as to be very easily distinguished and understood. It is sufficient to have shown how the whole, or nearly the whole, notation of signals may be limited to the expression of numbers.

We have taken little notice of the signals made by private ships to the commander in chief. This is a very early business, because there is little risk of confounding them with other signals. Nor have we spoken of signals from the flag ships whose ultimate interpretation is number, as when ships are directed to change their course to many points. These also are easily contrived in any of the methods already described: also when a private ship wishes to inform the commander in chief that soundings are found at so many fathoms. In like manner, by numbering the points of the compass, the admiral can direct to chase to any one of them, or may be informed of strange ships being seen in any quarter, and what is their number.

SIGNALS by the Drum, made use of, in the exercise of the army, instead of the word of command, viz.

SIGNALS.	Operations.
<i>A short roll,</i>	To caution.
<i>A flam,</i>	To perform any distinct thing.
<i>To arm,</i>	To form the line or battalion.
<i>The march,</i>	To advance, except when intended for a salute.
<i>The quick march,</i>	To advance quick.
<i>The point of war,</i>	To march and charge.
<i>The retreat,</i>	To retreat.
<i>Drum ceasing,</i>	To halt.
<i>Two short rolls,</i>	To perform the flank firing.
<i>The dragon march,</i>	To open the battalion.
<i>The grenadier march,</i>	To form the column.
<i>The troop,</i>	To double divisions.
<i>The long roll,</i>	To form the square.
<i>The grenadier march,</i>	To reduce the square to the column.
<i>The preparative,</i>	To make ready and fire.
<i>The general,</i>	To cease firing.
<i>Two long rolls,</i>	To bring or lodge the colours.

SIGNATURE, a sign or mark impressed upon any thing, whether by nature or art. Such is the general signification of the word; but in the plural number it has been used, in a particular sense, to denote those external marks by which physiognomists and other dabbles in the occult sciences pretend to discover the nature and internal qualities of every thing on which they are found. According to Lavater, every corporeal object is characterized by signatures peculiar to itself.

The doctrine of signatures, like alchemy and astrology, was very prevalent during the 15th and 16th centuries; and was considered as one of the occult sciences which conferred no small degree of honour on their respective professors. Some of these philosophers, as they thought fit to style themselves, maintained that plants, minerals, and animals, but particularly plants, had signatures impressed on them by the hand of nature, indicating to the adept the *therapeutic* uses to which they might be applied. Others, such as the mystic theosophists and chemists of that day, proceeded much farther in absurdity, maintaining that every substance in nature had either *external* signatures immediately discernible, or *internal* signatures, which, when brought into view

by fire or menstruum, denoted its connection with some siderical or celestial archetype. Of the doctrine of signatures, as it relates merely to the therapeutic uses of plants and minerals, traces are to be found in the works of some of the greatest authors of antiquity; but the celestial signatures, we believe, were discovered only by the moonlight of the monkish ages. Pliny informs us, that the marble called *aphites*, from its being spotted like a serpent, was discovered by those spots to be a sovereign remedy for the bite of that animal; and that the colour of the *hematites* or blood-stone intimated that it was fit to be employed to stop an hemorrhagy; but we do not recollect his attributing the virtues of these minerals to a siderical or celestial influence.

SIGNATURE, a signing of a person's name at the bottom of an act or deed written by his own hand.

SIGNATURE, in *Printing*, is a letter put at the bottom of the first page at least, in each sheet, as a direction to the binder in folding, gathering, and collating them. The signatures consist of the capital letters of the alphabet, which change in every sheet; if there be more sheets than letters in the alphabet, to the capital letter is added a small one of the same sort, as A, a, B, b; which are repeated as often as necessary. In large volumes it is easy to distinguish the number of alphabets, after the first three or four, by placing a figure before the signature, as 5 B, 6 B, &c.

SIGNET, one of the king's seals, made use of in sealing his private letters, and all grants that pass by bill signed under his majesty's hand: it is always in the custody of the secretaries of state.

SIGNET, in *Scots Law*. See *LAW*, Part III. § 17.

SILENE, *CATCHFLY*, or *Silene Campion*, a genus of plants belonging to the class *decandria*, and order *trigynia*; and in the natural system arranged under the 22d order, *caryophylleæ*. See *ROTARY INDEX*.

SILESIA, a duchy of Germany, bounded on the east by Poland; on the west, by Bohemia and Lower Lusatia; on the south, by a chain of mountains, and a thicket of considerable extent which separates it from Hungary; and to the north, by the marquisate of Brandenburg and Poland. From north-west to south-east it is about 274 miles, and about 100 where broadest: but it is much contracted at both ends. Upon the frontiers of this country, to the west and south, are very high mountains, and some likewise in other parts of it. One of the ridges upon the frontiers is styled the *Riphan Mountains*, another the *Moravian*, another the *Bohemian*, and another the *Hungarian Crapack*, or *Cerpathian*. A branch of the Bohemian is called the *Giant Mountains*. The winter on these hilly tracts is more severe, sets in sooner, and lasts longer, than in the low lands. The inhabitants use a kind of skates when the snow is deep, as they do in Cariola. Little or no grain is raised in the mountains and some sandy tracts; but the rest of the country is abundantly fruitful, not only in grain, but fruits, roots, pasture, flax, hops, madder, tobacco, and hemp, yielding also some wine, with considerable quantities of silk and honey. In many places are great woods of pines, fir, beech, larch, and other trees, affording tar, pitch, rosin, turpentine, lamp-black, and timber for all uses. In this country also is found marble of several sorts, some precious stones, limestone, millstone, pitcoal, turf, vitriol, some silver ore, copper, lead, iron, and mineral springs. Great numbers

Signature
Silecia

Hist. Nat.
lib. 34.

Silesia. bers of black cattle and horses are brought hither from Poland and Hungary for sale, those bred in the country not being sufficient; but of sheep, goats, game, and venison, they have great plenty. As for wild beasts, here are lynxes, foxes, weasels, otters, and beavers. The rivers, lakes, and ponds, yield fish of several sorts, particularly sturgeons several eels in length, and salmon. Besides a number of smaller streams to water this country, there is the Oder, which traverses it almost from one end to the other; and the Vistula, which after a pretty long course through it enters Poland. The number of the cities and market-towns is said to be about 220, the county of Glatz included, and that of the villages 5000. The inhabitants, who are computed to be about 1,821,065 are a mixture of Germans, Poles, and Moravians. The language generally spoken is German; but in some places the vulgar tongue is a dialect of the Slavonic. The states consist of the princes and dukes, and those called *free-holds*, with the nobility, who are immediately subject to the sovereign, and the representatives of the chief cities; but since the country fell under the dominion of the king of Prussia, no diets have been held. The king, however, when he took possession of the country, confirmed all the other privileges of the inhabitants. With respect to religion, not only Protestants, but Papists, Jews, and Greeks, enjoy full liberty of conscience. The greatest part of Silesia lies in the diocese of Breslaw, but some part of it in the Polish dioceses of Posen and Cracow. The bishop of Breslaw stands immediately under the pope with regard to spirituals; but all ecclesiastical benefices, not excepting the see of Breslaw, is in the king's gift. Besides Latin schools, colleges, and seminaries, at Breslaw is an university, and at Lignitz an academy for martial exercises. The principal manufactures here are woollens, linens, and cottons of several sorts, with hats, glass-ware, gunpowder, and iron manufactures. Of these there is a considerable exportation. Accounts are generally kept in six-dollars, silver groshens, and ducats. With respect to its revolutions and present government, it was long a part of the kingdom of Poland; afterwards it had several dukes and petty princes for its sovereigns, who by degrees became subject to the kings of Bohemia, until at last King Charles IV. incorporated the whole duchy with Bohemia; and thus it continued in the possession of the house of Austria, until the king of Prussia in 1742, taking advantage of the troubles that ensued upon the death of the emperor Charles VI. and pretending a kind of claim, wrested a great part of it, together with the county of Glatz, from his daughter and heiress Maria Theresa, the late empress dowager; so that now only a small part of it is possessed by the house of Austria, and connected with the empire, the rest being governed by the king of Prussia, without acknowledging any sort of dependence on the crown of Bohemia or the empire. For the administration of justice in all civil, criminal, and feudal cases, and such as relate to the revenue, the king of Prussia has established three supreme judicatories, to which an appeal lies from all the inferior ones, and from which, when the sum exceeds 500 six-dollars, causes may be moved to Berlin. The Lutheran churches and schools are under the inspection of the upper consistories, and those of the Papists under that of the bishop's court at Breslaw; but from both an appeal lies to the tribunal at Berlin.

As to the revenue, the eccle here is taxed only in the walled towns, being on the same footing as in the marquisate of Brandenburg; but in the rest of the country the contributions are fixed, and the same both in peace and war. The several branches of the revenue are under the management of the war and domain offices of Breslaw and Glogau. The whole revenue arising to the king of Prussia from Silesia and the county of Glatz amounts to about four millions of six-dollars per annum.

Silesia is divided into Upper and Lower, and each of these again into principalities and lordships; of some of which both the property and jurisdiction belong immediately to the sovereign, but of others to his subjects and vassals. In regard to the character of the people, the boors are accounted very dull and stupid; but of those of a higher rank, many have distinguished themselves by their wit and learning, as well as by their military and political talents.

SILESIAN EARTH, in the *Materia Medica*, a fine astringent bole. It is very heavy, of a firm compact texture, and in colour of a brownish yellow. It breaks easily between the fingers, and does not stain the hands; is naturally of a smooth surface, is readily diffusible in water, and melts freely into a butter-like substance in the mouth. It leaves no grittiness between the teeth, and does not ferment with acids. It is found in the perpendicular fissures of rocks near the gold mines in Hungary.

SILICERNIUM, among the Romans, was a feast of a private nature, provided for the dead some time after the funeral. It consisted of beans, lettuces, bread, eggs, &c. These were laid upon the tomb, and they foolishly believed that the dead would come out for the repast. What was left was generally burnt on the stone. The word *silicernium* is derived from *siles* and *cena*, i. e. "a supper upon a stone." Eating what had thus been provided for the dead, was esteemed a mark of the most miserable poverty. A similar entertainment was made by the Greeks at the tombs of the deceased; but it was usual among them to treat the ghosts with the fragments from the feast of the living. See **FUNERAL** and **INFERIE**.

SILEX. See **FLINT**.

SILICEOUS EARTH. See **SILICA**, **CHEMISTRY** and **Indes**.

SILIUS ITALICUS, CAIUS, an ancient Roman poet, and author of an epic poem in 17 books, which contains an history of the second Punic war, so famous for having decided the empire of the world in favour of the Romans. He was born in the reign of Tiberius, and is supposed to have derived the name of *Italicus* from the place of his birth; but whether he was born at Italia in Sardinia, or at Curtinum in Italy, which, according to Strabo, had the name of *Italia* given it during the Social war, is a point which cannot be known; though, if his birth had happened at either of these places, the grammarians would tell us, that he should have been called *Italensis*, and not *Italicus*. When he came to Rome, he applied himself to the bar; and, by a close imitation of Cicero, succeeded so well, that he became a celebrated advocate and most accomplished orator. His merit and character recommended him to the highest offices in the republic, even to the consulship, of which he was possessed when Nero died. He is said to

have been aiding and assisting in accusing persons of high rank and fortune, whom that wicked emperor had devoted to destruction: but he retrieved his character afterwards by a long and uniform course of virtuous behaviour. Vespasian sent him as provincial into Asia, where he behaved with clean hands and unblemished reputation. After having thus spent the best part of his life in the service of his country, he bade adieu to public affairs, resolving to consecrate the remainder to polite retirement and the muses. He had several fine villas in the country: one at Tusculum, celebrated for having been Cicero's; and a farm near Naples, said to have been Virgil's, at which was his tomb, which Silius often visited. Thus Martial compliments him on both these accounts:

*Silius hæc magni celebrat monumenta Maronis,
Jugera sacundi qui Ciceronis habet.
Hæredem Dominumque sui tandemque larisque
Non alium mallet nec Maro nec Cicero.*

Æpigr. 49. lib. xi.

Of Tully's seat my Silius is possessor,
And his the tomb where Virgil's ashes rest.
Could those great shades return to choose their heir,
The present owner they would both prefer.

In these retirements he applied himself to poetry: led not so much by any great force of genius, which would certainly not have suffered him to stay till life was in the wane and his imagination growing cold, as by his exceeding great love of Virgil, to whose memory he paid the highest veneration. He has imitated him in his poem; and though he falls infinitely short of him, yet he has discovered a great and universal genius, which would have enabled him to succeed in some degree in whatever he undertook.

Having been for some time afflicted with an imposthume, which was deemed incurable, he grew weary of life, to which, in the language of Pliny, he put an end with determined courage.

There have been many editions of Silius Italicus. A neat and correct one was published at Leipzig in 1696, in 8vo, with short and useful notes by Cellarius: but the best is that *cum notis integris variorum et Arnoldi Drakenborch.* Traject. ad Rhen. 1717, in 4to.

SILK, a very soft, fine, bright thread, the work of an insect called *bombyx*, or the silk worm.

As the silk worm is a native of China, the culture of silk in ancient times was entirely confined to that country. We are told that the empress, surrounded by their women, spent their leisure hours in hatching and rearing silk worms, and in weaving tissues and silk veils. That this example was soon imitated by persons of all ranks, we have reason to conclude; for we are informed that the Chinese, who were formerly clothed in skins, in a short time after were dressed in vestments of silk. Till the reign of Justinian, the silk worm was unknown beyond the territories of China, but silk was introduced into Persia long before that period. After the conquest of the Persian empire by Alexander the Great, this valuable commodity was brought into Greece, and thence conveyed to Rome. The first of the Roman writers extant by whom silk is mentioned, are Virgil and Horace; but it is probable that neither of them knew from what country it was obtained, nor how it was

produced. By some of the ancients it was supposed to be a fine down adhering to the leaves of certain trees or flowers. Others imagined it to be a delicate species of wool or cotton; and even those who had learned that it was the work of an insect, show by their descriptions that they had no distinct idea of the manner in which it was formed. Among the Romans, silk was deemed a dress too expensive and too delicate for men, and was appropriated wholly to women of eminent rank and opulence. Elagabalus is said to have been the first man among the Romans who wore a garment of fine silk: Aurelian complained that a pound of silk was sold at Rome for 12 ounces of gold; and it is said he refused to give his wife permission to wear it on account of its exorbitant price.

For several centuries the Persians supplied the Roman empire with the silks of China. Caravans traversed the whole latitude of Asia, in 243 days, from the Chinese to the sea-coast of Syria, carrying this commodity. Sometimes it was conveyed to the ports of Guzerat and Malabar, and thence transported by sea to the Persian gulf. The Persians, with the usual rapacity of monopolists, raised the price of silk to such an exorbitant height, that Justinian, eager not only to obtain a full and certain supply of a commodity which was become of indispensable use, but solicitous to deliver the commerce of his subjects from the exactions of his enemies, endeavoured, by means of his ally, the Christian monarch of Abyssinia, to wrest some portion of the silk trade from the Persians. In this attempt he failed; but when he least expected it, he, by an unforeseen event, attained, in some measure, the object which he had in view. Two Persian monks having been employed as missionaries in some of the Christian churches, which were established (as we are informed by Cosmas) in different parts of India, had penetrated into the country of the Seres, or China. There they observed the labours of the silk worm, and became acquainted with all the arts of man in working up its productions into such a variety of elegant fabrics. The prospect of gain, or perhaps an indignant zeal, excited by seeing this lucrative branch of commerce engrossed by unbelieving nations, prompted them to repair to Constantinople. There they explained to the emperor the origin of silk, as well as the various modes of preparing and manufacturing it, mysteries hitherto unknown, or very imperfectly understood in Europe; and encouraged by his liberal promises, they undertook to bring to the capital a sufficient number of those wonderful insects, to whose labours man is so much indebted. This they accomplished, by conveying the eggs of the silk worm in a hollow cane. They were hatched by the heat of a dunghill, fed with the leaves of a wild mulberry tree, and they multiplied and worked in the same manner as in those climates where they first became objects of human attention and care. Vast numbers of these insects were soon reared in different parts of Greece, particularly in the Peloponnese. Sicily afterwards undertook to breed silk worms with equal success, and was imitated, from time to time, in several towns of Italy. In all these places extensive manufactures were established and carried on with silk of domestic production. The demand for silk from the east diminished of course, the subjects of the Greek emperors were no longer obliged to have recourse to the Persians for a supply of it, and a considerable change took place

Silk.

² Brought from China by the Persian fleet till the time of Justinian.

³ Robertson's *Dissertation concerning India*, p. 58.

³ Silk worms introduced into Europe by two monks.

in the nature of the commercial intercourse between Europe and India.

As silk is the production of a worm, it will be first necessary to give a description of its nature and mode of manufacturing. But before we give any account of the most approved methods of managing silk worms in Europe, it will be proper to present a short description of the methods practised in China, the original country of the silk worm. There are two; they either permit them to remain at liberty on mulberry trees, or keep them in rooms. As the finest silk is produced by worms confined in rooms, and as the first method is very simple, it will suffice to describe the second.

4
Method of
rearing silk
worms in
China.

To begin with the eggs, which are laid on large sheets of paper, to which they firmly adhere. The sheets are hung up on a beam of the room, with the eggs inward, and the windows are opened in the front to admit the wind; but no hempen ropes must ever come near the worms or their eggs. After some days the sheets are taken down, rolled up loosely with the eggs inward, and then hung up again, during the summer and autumn. At the end of December, or the beginning of January, the eggs are put into cold water, with a little salt dissolved in it. Two days after they take them out, hang them up again, and when dry roll them a little tighter, and enclose each separately, standing on one end in an earthen vessel. Some put them into a lye made of mulberry tree ashes, and then lay them some moments in snow-water, or else hang them up three nights on a mulberry tree to receive the snow or rain, if not too violent. The time of hatching them is when the leaves of the mulberry trees begin to open, for they are hastened or impeded according to the different degrees of heat or cold to which they are exposed. When they are ready to come forth, the eggs swell, and become a little pointed.

The third day before they are hatched, the rolls of paper are taken out of the vessel, stretched out, and hung up with their backs toward the sun, till they receive a kindly warmth; and then being rolled up close, they are set upright in a vessel in a warm place. This is repeated the next day, and the eggs change to an ash-gray. They then put two sheets together, and rolling them close tie the ends.

The third day, towards night, the sheets are unrolled and stretched on a fine mat, when the eggs appear blackish. They then roll three sheets together, and carry them into a pretty warm place, sheltered from the south wind. The next day the people taking out the rolls, and opening them, find them full of worms like small black ants.

The apartment chosen for silk worms is on a dry ground, in a pure air, and free from noise. The rooms are square, and very close, for the sake of warmth; the door faces the south, and is covered with a double mat, to keep out the cold; yet there should be a window on every side, that when it is thought necessary the air may have a free passage. In opening a window to let in a refreshing breeze, care must be taken to keep out the gnats and flies. The room must be furnished with nine or ten rows of frames, about nine inches one above the other. On these they place rush hurdles, upon which the worms are fed till they are ready to spin; and, to preserve a regular heat, stove fires are placed at the corners of the room, or else a warming pan is carried

up and down it; but it must not have the least flame or smoke. Cow-dung dried in the sun is esteemed the most proper fuel.

Silk.

The worms eat equally day and night. The Chinese give them on the first day forty-eight meals, that is, one every half hour; the next thirty; the third day they have still less. As cloudy and rainy weather takes away their stomach, just before they reap a wisp of very dry straw, the flame of which must be all alike, is held over the worms to free them from the cold and moisture that benumbs them, or else the blinds are taken from the windows to let in the full day-light.

Eating too often hastens their growth, on which the chief profit of the silk worm depends. If they come to maturity in 23 or 25 days, a large sheet of paper covered with worms, which at their first coming from the eggs weigh little more than a drachm, will produce 25 ounces of silk; but if not till 28 days, they then yield only 20 ounces; and if they are a month or 40 days in growing, they then produce but ten.

They are kept extremely clean, and are often removed; and when they are pretty well grown, the worms belonging to one hurdle are divided into three, afterwards they are placed on six, and so on to the number of 20 or more; for being full of humours, they must be kept at a due distance from each other. The critical moment for removing them is when they are of a bright yellow and ready to spin; they must be surrounded with mats at a small distance, which must cover the top of the place to keep off the outward air; and because they love to work in the dark. However, after the third day's labour, the mats are taken away from one o'clock till three, but the rays of the sun must not shine upon them. They are at this time covered with the sheets of paper that were used on the hurdles.

The cocoons are completed in seven days, after which the worm is metamorphosed into a chrysalis; the cocoons are then gathered, and laid in heaps, having first set apart those designed for propagation upon a hurdle, in a cool airy place. The next care is to kill the moths in those cones which are not to be bored. The best way of doing this is to fill large earthen vessels with cones in layers of ten pounds each, throwing in four ounces of salt with every layer, and covering it with large dry leaves like those of the water-lily, and closely stopping the mouth of the vessels. But in laying the cones into the vessels, they separate the long, white, and glittering ones, which yield a very fine silk, from those that are thick, dark, and of the colour of the skin of an onion, which produce a coarser silk.

The silk worm is a species of caterpillar, which, like all others of the same class, undergoes a variety of changes, that, to persons who are not acquainted with objects of this kind, will appear to be not a little surprising.

5
Description
and history
of the silk
worm.

It is produced from a yellowish-coloured egg, about the size of a small pin-head, which has been laid by a kind of grayish-coloured moth, which the vulgar commonly found with the butterfly.

These eggs, in the temperature of this climate, if kept beyond the reach of the fire and sun-line, may be preserved during the whole of the winter and spring months without danger of hatching; and even in summer they may easily be prevented from hatching if they be kept in a cool place; but in warmer climates it is

secretly

scarcely possible to preserve them from hatching, even for a few days, or from drying so much as to destroy them. Hence it is easy for a native of Britain to keep the eggs till the food on which the worm is to feed be ready for that purpose. When this food is in perfection, the eggs need only be exposed to the sun for a day or two, when they will be hatched with great facility.

When the animal is first protruded from the egg, it is a small black worm, which is active, and naturally ascends to the top of the heap in search of food. At this stage of his growth the silk worm requires to be fed with the youngest and most tender leaves. On these leaves, if good, he will feed very freely for about eight days, during which period he increases in size to about a quarter of an inch in length. He is then attacked with his first sickness, which consists in a kind of lethargic sleep for about three days continuance; during which time he refuses to eat, and changes his skin, preserving the same bulk. This sleep being over, he begins to eat again, during five days, at which term he is grown to the size of half an inch in length; after which follows a second sickness in every respect like the former.

He then feeds for other five days; during which time he will have increased to about three quarters of an inch in length, when he is attacked with his third sickness. This being over, he begins to eat again, and continues to do so for five days more, when he is attacked by his fourth sickness, at which time he is arrived at his full growth. When he recovers this sickness, he feeds once more during five days with a most voracious appetite; after which he distains his food, becomes transparent, a little on the yellowish cast, and leaves his silky traces on the leaves where he passes. These signs denote that he is ready to begin his cocoon, and will eat no more.

Thus it appears that the whole duration of the life of the worm, in this state of its existence, in our climate, is usually about 46 days; 28 of which days he takes food, and remains in his sick or torpid state 18; but it is to be observed, that during warm weather the periods of sickness are shortened, and in cold weather lengthened, above the terms here specified. In very hot climates it may be said to live faster, and sooner to attain maturity, than in those that are colder. Dr Anderson informs us, that at Madras the worm undergoes its whole evolutions in the space of 22 days. It appears, however, that it feeds fully as many days in India as in Europe, the difference being entirely occasioned by shortening the period of sickness. The longest sickness he had seen them experience there did not exceed two days; and during summer it only lasts a few hours.

When the worm has attained its full growth, it searches about for a convenient place for forming its cocoon, and mounts upon any branches or twigs that are put in its way for that purpose. After about two days spent in this manner, it settles in its place, and forms

the cocoon, by winding the silk which it draws from its bowels round itself into an oblong roundish ball.

During this operation it gradually loses the appearance of a worm; its length is much contracted, and its thickness augmented. By the time the web is finished, it is found to be transformed into an oblong roundish ball, covered with a smooth shelly skin, and appears to be perfectly dead. In this state of existence it is called an *aurelia*. Many animals in this state may be often seen sticking on the walls of out-houses, somewhat resembling a small bean.

In this state it remains for several days entirely motionless in the heart of the cocoon, after which it bursts like an egg hatching, and from that comes forth a heavy dull-looking moth with wings; but these wings it never uses for flying; it only crawls slowly about in the place it has been hatched. This creature forces its way through the silk covering which the worm had woven, goes immediately in quest of its mate, after which the female lays her eggs; and both male and female, without taling food in this stage of their existence, die in a very short time.

The silk worm, when at its full size, is from an inch and a quarter to an inch and a half in length, and about half an inch in circumference. He is either of a milk or pearl colour, or blackish; these last are esteemed the best. His body is divided into seven rings, to each of which are joined two very short feet. He has a small point like a thorn exactly above the anus. The substance which forms the silk is in his stomach, which is very long, wound up, as it were, upon two spindles, as some say, and surrounded with a gum, commonly yellowish, sometimes white, but seldom greenish. When the worm spins his cocoon, he winds off a thread from each of his spindles, and joins them afterwards by means of two hooks which are placed in his mouth, so that the cocoon is formed of a double thread. Having opened a silk worm, you may take out the spindles, which are folded up in three plaits, and, on stretching them out, and drawing each extremity, you may extend them to near two ell's in length. If you then scrape the thread so stretched out with your nail, you scrape off the gum, which is very like bees wax, and performs the same office to the silk it covers as gold leaf does to the ingot of silver it surrounds, when drawn out by the wire drawer. This thread, which is extremely strong and even, is about the thickness of a middling pin.

Of silk worms, as of most other animals, there is a particular considerable variety of breeds, some of which are much more hardy, and possess qualities considerably different from others. This is a particular of much importance to be adverted to at the time of beginning to breed these creatures in any place; for it will make a great difference in the profit on the whole to the undertaker if he rears a good or a bad sort. This is a department in respect to the economy of animals that has been in every

(A) As the success of the silk manufacture must depend on the breed of worms, it is of great consequence to bring them from those countries where they are reckoned best.

Mr Andrew Wright, an ingenious silk manufacturer of Paisley, has given the following directions for conveying the eggs of the silk worm from distant countries by sea: As soon as the moth has laid her eggs, dry them immediately, and put them into glass phials; seal them so close that damp air or water will not penetrate into them. Put these phials that contain the eggs into earthen pots filled with cold water; and as often as the water becomes

Silk.

every case much less advised to than it deserves; and in particular with regard to the silk worm it has been almost entirely overlooked. A few species of the silk worm can be easily transported by post in a letter from every part of Europe to another, especially during the winter season. It would therefore be an early matter for any patriotic society, such as the Society of Arts in London, to obtain a specimen of the eggs from every country in which silk is now reared, to put them under the care of a person who could be depended on, and who understood the management of them, with orders to keep each kind distinct from another, and advert to every particular that occurred in their management, so as to make a fair estimate of their respective merits. By these means the best might be selected, and those of inferior value rejected. Fifty or fifty of each sort might be enough for the experiment; but it ought to be repeated several times before conclusions could be drawn from it that might be altogether relied upon; for it is well known that a variation of circumstances will make a change in the result; and it is by no means certain that the same particular would affect those of one breed exactly in the same manner as it would do those of a different breed. One may be more hardy with regard to cold, another more delicate in respect to food, and so on. It is experience alone that can ascertain the circumstances here inquired for.

From the above mentioned particulars, it is evident, that the management of silk worms must be very different in hot climates from what is required in those that are colder. At Madras, it appears from Dr Anderson's experiments that it is very difficult to prevent the eggs from hatching for a very few days, so that many generations of them must be propagated in one year. "In this hottest season," says he, in a letter to Sir Joseph Banks, dated July 6, 1797, "the shortest time I have been able to remark for the whole evolution of the silk worm is 40 days; that is to say, six days an egg, 22 a worm, 11 a grub in the cocoon, and one a moth or butterfly." Fortunately, where the climate forces forward their production so rapidly, nature hath been equally provident of food for their subsistence; for in these regions the mulberry continues to grow and push out leaves throughout the whole year.

Though the silk worm be a native of China, there is no doubt but it might easily be propagated perhaps in most parts of the temperate zones. The eggs of this insect, indeed, require a considerable degree of warmth to hatch them, but they can also endure a severe frost. No less than 3400 lbs of silk were raised in 1789 in the cold, sandy territories of Prussia. In the province of Pekin, in China, where great quantities of silk are fabricated, the winter is much colder than even in Scotland. From the information of some Russians who were sent thither to learn the Chinese language, we find that Reaumur's thermometer was observed from 10 to 15, and even 20 degrees below the freezing point. Nor is it difficult to rear the food of the silk worm in a temperate climate. The mulberry-tree is a hardy veg-

table, which bears, without injury, the winters of Sweden, and even of Siberia. Of the seven species of the mulberry (see *Arbus*) enumerated by Linnæus, four of these (viz. the white, red, black, and Tartarian), there is every reason to believe could be reared both in Britain and Ireland. The *white* grows in Sweden; the *red* is a Landau round Quebec; the *black* delights in black situations, exposed to wind on the sea shore; and the *Tartarian* mulberry is represented as growing in the chilly regions of Siberia.

As to the superior qualities of the different species, probably there is very little to be pointed out amongst the four just mentioned with regard to nourishment, except what may be drawn from the following fact: that if the silk three are laid down together, the silk worms will first eat the white, then the red, and next the black, in the order of the tenderness of the leaves. The Tartarian seems to hold as high a place in its esteem as either the red or black; but all must yield to the white, which seems to be its natural food.

In Calabria the red mulberry is used; in Valencia the white; and in Granada, where excellent silk is produced, the mulberries are all black. The white seems to prosper very well in a moist soil: the black agrees well with a dry, sandy, or gravelly soil; and the white is most luxuriant in a moist rich loam.

It may justly be asserted, that Britain possesses some advantages in the raising of raw silk which are not enjoyed by warmer countries. Even in the south of France, Mr Arthur Young informs us, the mulberry leaves are often nipped by frost in the bud; but this scarcely ever the case with us. It is well known that thunder and lightning are hurtful to the silk worm. Now our climate can boast that it is almost wholly exempted from those dreadful storms of thunder and lightning which prevail so much in hot climates. Nature has then furnished us with every thing requisite for the silk manufacture; it remains only for us to improve the advantages which we possess. Let mulberry trees be planted by proprietors of lands, and let a few persons of skill and attention devote their time to the raising of silk worms. This is an employment that will not interfere with any manufacture already established; on the contrary, it would afford a respectable, a lucrative, and agreeable employment to ladies, or to females in general, who here at present too few professions to which they can apply. The society instituted at London for the encouragement of arts, manufactures, and commerce, much to their honour, have offered premiums to those who shall plant a certain number of mulberry trees.

The following method of raising mulberry trees from seed is practised in the south of France, and has been repeated with success in the East Indies by Dr Anderson of Madras. "Take the ripe berries of the mulberry when it is full of juice and of seeds. Next take a rough horse-hair line or rope, such as we dry linen on, and with a good handful of ripe mulberries run your hand along the line bruising the berries and making them

warm renew it. Place the earthen vessels in the colder place of the ship, and let them remain until the end of the voyage. It must be observed, that the ship chosen for this purpose ought to be one that would arrive in Britain in the months of June or July.

7
The management of silk worms must be different in different climates;

8
but may be easily reared in temperate climates.

See No 156.

Silk.

9
What probably there is very little to be pointed out amongst the four just mentioned with regard to nourishment, except what may be drawn from the following fact: that if the silk three are laid down together, the silk worms will first eat the white, then the red, and next the black, in the order of the tenderness of the leaves. The Tartarian seems to hold as high a place in its esteem as either the red or black; but all must yield to the white, which seems to be its natural food.

10
It may justly be asserted, that Britain possesses some advantages in the raising of raw silk which are not enjoyed by warmer countries. Even in the south of France, Mr Arthur Young informs us, the mulberry leaves are often nipped by frost in the bud; but this scarcely ever the case with us. It is well known that thunder and lightning are hurtful to the silk worm.

11
Method of raising mulberry trees from seed is practised in the south of France, and has been repeated with success in the East Indies by Dr Anderson of Madras. "Take the ripe berries of the mulberry when it is full of juice and of seeds. Next take a rough horse-hair line or rope, such as we dry linen on, and with a good handful of ripe mulberries run your hand along the line bruising the berries and making them

Silk.

them as much as possible as your hand runs along, so that the pulp and seeds of the berries may adhere in great abundance to the rope or hair line. Next dig a trench in the ground where you wish to plant them, much like what is practised in kitchen gardens in England for crops of various kinds. Next cut the rope or hair line into lengths according to the length of the trench you think fit to make, and plunge the line full of matted berries into the trench, and then cover it over well with earth, always remembering afterwards to water it well, which is essential to the success. The seeds of the berries thus sown will grow, and soon shoot out young suckers, which will bear young leaves, which are the best food for the silk worm.

"The facility and rapidity with which young leaves may by this means be produced is evident, for as many rows of trenches may thus be filled as can be withed; and it can never be necessary to have mulberry trees higher than our raspberries, currants, or gooseberry bushes. Whenever they get beyond that, they lose their value; and if these trenches succeed, you may have a supply coming fresh up day after day, or any quantity you please." Thus abundance of these trees might be reared. But as mulberry trees are not yet found in abundance in this country, it were to be wished that some other food could be substituted in their place: attempts have accordingly been made by those who have reared silk worms, and it has been found possible to support the silk worm upon lettuce (B).

Bee, N^o 7-

12
Miss
Rhodes fed
silk worms
on lettuce
or some
time.

Miss Henrietta Rhodes, a lady who has made some successful experiments on raising silk worms in England, had found that the silk worm could with safety be kept on lettuce for some time. This is pretty generally known by ladies who have turned their attention to this subject; but she found that in general they could not with safety be kept upon that food above three weeks. If longer fed upon that plant, the worms for the most part die without spinning a web at all. She found, however, that they did not always die, but that in some cases they produced very good cocoons, even when fed entirely on lettuce. She therefore with reason suspected that the death of the animal must be occasioned by some extraneous circumstance, and not from the poisonous quality of the food itself; the circumstance she suspected, from some incidental observations, was the coldness of that food; and therefore she thought it was not impossible, but if they were kept in a very warm place, while fed on lettuce, they might attain, in all cases, a due perfection.

13
General
Mordaunt
kill more
successful.

General Mordaunt having been informed of this conjecture, resolved to try the experiment. He got some silk worms eggs, had them hatched in his hot-house, and caused them to be all fed upon lettuce and nothing else. They prospered as well as any worms could do, few or none of them died; and they afforded as fine cocoons as if they had been fed upon mulberry leaves. As far as one experiment can go, this affords a very exhilarating prospect in many points of view. If one kind of

food has been noxious, merely on account of an improper temperature, others may be found which have been harmful only from a similar cause; so that it is not impossible but we may at last find that this delicate creature may be supported by a variety of kinds of food. Few, however, could be more easily obtained than lettuce; and this plant, when cabbaged (the cobs, or ice lettuce especially), would possess one quality that the mulberry leaf never can possess, from the want of which many millions of worms die in those countries where silk is now reared; for it is observed, that when the leaves are gathered wet, it is scarcely possible to preserve the worms alive for any length of time; so that during a continuance of rainy weather many of them are unavoidably cut off; but a lettuce, when cabbaged, resists moisture. If gathered, even during rain, the heart of it is dry; so that if the outer leaves be thrown aside at that time, the worms would be continued in perfect health. The expense, too, of cultivating and gathering lettuce, would be so much less than that of gathering mulberry leaves, as to occasion a saving that would be much more than sufficient to counterbalance the expense of heating the conservatory, as a little reflection will show.

But the great point to be now ascertained is, whether it is a fact that worms fed on lettuce, if kept in a due temperature, will continue in good health, in general, till they shall have perfected their cocoon? One experiment is too little to establish this fact with perfect certainty. It would therefore be necessary that more experiments should be made on this subject.

It is said that Dr Lodovico Bellardi, a learned and ingenious botanist of Turin, has, after a number of experiments, discovered a new method of feeding silk worms, when they are hatched before the mulberry trees have produced leaves, or when it happens that the frost destroys the tender branches. This new method consists in giving the worms dried leaves of the mulberry-tree. One would think that this dry nourishment would not be much relished by these insects; but repeated experiments made by our author, prove that they prefer it to any other, and eat it with the greatest avidity. The mulberry leaves must be gathered about the end of autumn, before the frosts commence, in dry weather, and at times when the heat is greatest. They must be dried afterwards in the sun, by spreading them upon large cloths, and laid up in a dry place after they have been reduced to powder. When it is necessary to give this powder to the worms, it should be gently moistened with a little water, and a thin coat of it must be placed around the young worms, which will immediately begin to feed upon it.

14
Silk worms
said to be
fed on dried
mulberry
leaves.

We have mentioned all the different kinds of food, which, as far as we have heard, have been tried with any success to nourish the silk worm; not, however, with great confidence, but as experiments which it might be worth while carefully to consider and perform. We must not omit to mention that one person, who has had much

15
Proper ex-
periments
ought to be
made on
various ve-
getables.

(B) It is not improbable, says Dr Anderson, to whose valuable work entitled the *Bee*, we have been much indebted in the drawing up of this article, that other kinds of food may be found which will answer the same purpose. The *chicorium intybus* and common endive might be tried, as they have the same lactescent quality with the lettuce.

SILK.

much experience in the managing of silk worms, assures us, that the silk produced from any other food than mulberry leaves is of an inferior quality, and that the worms are sickly. We think, however, that there is reason to suspect that the experiment has not been skillfully performed; and therefore, before every other food except mulberry leaves is discarded, the experiment ought to be performed with more attention and care. We know that many animals in a domestic state can live upon food very different from that which supported them when running wild in the fields. Certain it is, however, that every animal, in its state of nature, partakes of a food peculiar to itself, which is rejected by other animals as if it were of a poisonous quality; and it may be mentioned as a curious fact, as well as an admirable instance of the care of that Being who feeds the fowls of heaven, that notwithstanding the numerous insects that prey upon animals and vegetables, the mulberry tree is left untouched by them all, as the exclusive property of the silk worm, to exhibit of the insect tribe, which soils and is for the use of man.

16
What situation and apartment proper for these insects.

Having now considered the food proper for the silk worm, we shall next consider what situation is most favourable to them. In the opinion of some persons in this country who have been in the practice of rearing silk worms, they ought always to be kept in a dry place, well sheltered, and possessing a considerable degree of warmth, and which is not exposed to sudden transitions from heat to cold. If the weather be too cold, a small fire must be made: this is of small importance when the worms are ready for spinning. A southern exposure is therefore preferable. Some think light is of great utility to silk worms, others think that they thrive better in the dark. As to what apartments are best accommodated for promoting the health of silk worms, and most convenient for those who have the care of them, they may be various according to the extent of the manufacture or the wealth of the proprietors. Silk worms may be kept in boxes or in shelves. When shelves are to be used, they may be contrived in the following manner: The shelves may be of wicker, ranged at the distance of a foot and a half, and fixed in the middle of the room; their breadth ought to be such, that any person can easily reach to the middle from either side. This is perhaps the simplest and cheapest apparatus for rearing silk worms; but there is another apparatus which may be recommended to those who are anxious to unite some degree of elegance with convenience. This apparatus is the invention of the Rev. George Swayne of Picklechurch, a gentleman who has studied this subject much, in order to find out the way for promoting the culture of silk among the poor. This apparatus, with the description of it, may be found in the Transactions of the Society for encouraging Arts, Manufactures, and Commerce, vol. vi. p. 148. The apparatus consists of a wooden frame four feet two inches high, each side 16 inches and a half wide, divided into eight partitions by small pieces of wood which form grooves, into which the silks run, and are thus either thrust into or drawn out of the frame. The upper shelf in the model sent to the society by Mr Swayne is of paper only, and designed to receive the worms as soon as hatched; the two next are of canvas, the threads about one-tenth of an inch distant from each other: these are for the insects when a little advanced in size: the five lower

ones are of wicker work; but, as Mr Swayne afterwards found, netting may be substituted with advantage instead of wicker bottoms. Under each of these, as well as under those of canvas, are sliders made of paper, to prevent the dang of the worms from falling on those feeding below them.

The management of silk worms is next to be attended to. The proper time for hatching them is when the leaves of the mulberry are full grown, or nearly so; that as soon as these insects are capable of receiving food they may obtain it in abundance. To attempt to hatch them sooner would be hurtful, as the weather would not be sufficiently warm. Besides, as leaves are necessary to the life of a vegetable, if the young leaves of the mulberry tree are cropped as soon as they are unfolded, the tree will be much weakened, and as to be incapable of producing so many leaves as it would otherwise have done; and if this practice be frequently repeated, it will inevitably be destroyed.

When the proper season is arrived, the eggs may be hatched either by the heat of the sun, when it happens to be to be strong enough, or by placing them in a small room moderately heated by a stove or fire, and after being exposed for six or seven days to a gentle heat, the silk worm issues from the egg in the form of a small black hairy caterpillar. When Mr Swayne's apparatus is used, the worms are to be kept on the drawers with paper bottoms till they are grown so large as not readily to creep through the gauze-bottomed drawers: they are then to be placed on those drawers, where they are to remain till their excrements are so large as not readily to fall through; when this is the case, they must be removed to the drawers with the wicker or netting bottoms, and fed thereon, till they show symptoms of being about to spin. It is scarcely necessary to mention, that the paper slides beneath the gauze and wicker drawers are intended to receive the dang, which should be emptied as often as the worms are fed, at least once a day; or to direct, that when the worms are fed, the slides are to be first drawn out a considerable way, and the drawers to rest upon them.

It has been already mentioned, that wet or damp weather is exceedingly prejudicial to these insects. It produces contagious and fatal diseases. To prevent the necessity of giving them wet or damp food, attention ought to be paid to the weather, so that when there is an immediate prospect of rain, a sufficient quantity of leaves may be gathered to last the worms two or three days. In this country, the leaves of the black or red mulberry tree may be preserved good for food, although kept four or five days, by the following method: When new gathered, lay them loosely in glazed earthen vessels, place these in a cold place, well aired, not exposed to draught.

The utmost attention must be paid to preserve the place where silk worms are kept as clean as possible; the house or room must be well ventilated, that no noxious vapours be accumulated. By some experiments of M. Pajus de St Fond, which are recorded in his history of Longueval, it appears that the silk worm is much injured by foul air. All decayed leaves must be removed from them, as it is now well known that they emit bad air in great abundance.

One of the most difficult branches of the management of silk worms has hitherto been the cleaning without

SILK.

15
Prop. time of hatching silk worms.

16
What situation and apartment proper for these insects.

17
Mr Swayne's apparatus described.

18
Ought to be kept as clean as possible.

19
without

Silk
Ber. N^o 5

Silk

How they
may be
kept
without
breeding
them.

breeding them. To avoid this inconvenience, the peasants in France and Italy frequently allow the whole litter to remain without ever cleaning them, which is the cause of that unwholesome stench that has been so often remarked by those who visit the places for rearing silk worms in these countries. This difficulty may be effectually removed by providing a net, or, what would be still better, a wire-bottomed frame, wrought into large meshes like a riddle. Have that made of a size exactly sufficient to cover the wooden box in which the worms are kept. When you mean to shift them, spread fresh leaves into the wire basket; and let it down gently over the worms till it comes within their reach. They no sooner perceive the fresh food than they abandon the rubbish below, and creep through the meshes, so as to fix themselves upon the leaves; then by gently raising the fish basket, and drawing out the board below (which ought to be made to slip out like the slip-bottom of a bird's cage), you get off all the excrements and decayed leaves, without incommoding the worms in the smallest degree; and along with the litter you will draw off an inch or two in depth of the foulest mephitic vapours. To get entirely rid of these, the board, when thus taken out, should be carried without doors, and there cleaned; and the slip-board immediately replaced to receive all the excrements and offals. After it is replaced, the wire frame that had been elevated a little, may be allowed to descend to a convenient distance above the board without touching it. Thus will there be left a vacant space for the mephitic air to fall below the worms, so as to allow them to inhabit a wholesome region of the atmosphere.

When a fresh supply of food is to be given before cleaning, the wire frame ought to be let down as close to the board as can be safely done, and another wire-bottomed frame put over it, with fresh leaves, as before described. When the worms have abandoned that in their turn, let the slip-board, together with the lower wire frame, be drawn out and removed, and so on as often as necessary. To admit of this alternate change, every table, consisting of one slip-board, ought to have two sets of wire-bottomed frames of the same size; the slip-board to be always put into its place immediately after it is cleaned, and the wire frames referred to be afterwards placed over the other. By this mode of management, it is probable that the worms would be saved

from the diseases engendered by the mephitic air, and the numerous deaths that are the consequence of it avoided.

Dr Anderson, to whom we have already acknowledged our obligations, and to whom this country has been much indebted for valuable works on agriculture, the fisheries, &c. advises those who have the management of silk worms to strew a thin stratum of fresh flaked quicklime upon the slip-board each time it is cleaned, then immediately before it is put into its place. This would absorb the mephitic gas, for as soon as it is generated it would descend upon the surface of the quicklime. Thus would the worms be kept continually in an atmosphere of pure air (c). Were the walls of the apartments to be frequently washed with quicklime and water, it would tend much to promote cleanliness at a small expence, and augment the healthiness of the worms as well as that of the persons who attend them.

When the silk worm refuses its food, and leaves silky Mr traces on the leaves over which it passes, it is a proof that it is ready to begin its cocoon. It is now necessary to form a new receptacle, which is commonly done by pinning together papers in the shape of inverted cones with broad bases. "This method (says Mr Swayne) where there are many worms, is exceedingly tedious, wastes much paper, and uses a large number of pins; besides, as the silk worm always weaves an outer covering or defensive web before it begins the cocoon or oval ball, I apprehended that it caused a needless waste of silk in forming the broad web at the top. The method I make use of is, to roll a small piece of paper (an uncut octavo leaf, such as that of an old magazine, is sufficient for three), round my fore-finger, and to give it a twist at the bottom; which is done with the utmost expedition, and gives no occasion for the use of pins. These rolled paper-cases being likewise of a form more nearly resembling that of a cocoon, with a much narrower opening on the top than the others, takes away the necessity of wadding much silk in the outer web, and consequently leaves more to be employed in forming the ball. The silk is readily taken out of these cases by untwisting the bottom; and if this be done with moderate care, and the papers are preserved, they will serve several times for the like purpose."

Others advise, that when the silk worms are preparing to spin, little bulrushes of heath, broom, or twigs, should be used for the purpose.

(c) To put this question beyond a doubt, Mr Blancard made the following comparative experiments, which were several times repeated. "I procured (says he) four glass jars nine inches high and five in diameter, closing the mouth with cork stoppers. After which I placed in each of them, in their second life (so *me* may be translated, which means the stage between the different sicknesses), twelve silk worms, which were fed four times a day; and which I confined in this kind of prison all their life, without taking away either their dead companions or their ordure or litter. I sprinkled with chalk the worms of only two of these jars, and kept the two others to compare with them.

"In those without lime, I never obtained either more or less than three small and imperfect cocoons (*Chrysois au bouffard*), and in the two that were sprinkled with lime, I had very often twelve, and never less than nine fine full-sized firm cocoons."

This experiment affords the most satisfactory proof of the utility of this process. From a number of trials he found, that even when the worms were covered with a large proportion of lime, they never were in any way incommoded by it.

26 **Silk.** be stuck upright near the shelf or box in which they are inclosed: the worms mount thence, and attach their web to them.

How silk worms may be revived when affected by thunders.

Translations of the American Philosophical Society, vol. II.
When the worms are ready to mount, in order to spin, if the weather be hot, attended with thunder, you will see them in a languishing condition; your care must then be to revive them, which is effected thus: Take a few eggs and onions, and fry them in a pan with some stale hog's lard, the rarer the better, and make pancake; which done, carry it smoking hot into the room where they are kept, and go round the chamber with it. You will be surpris'd to see how the smell revives them, excites those to eat who have not done feeding, and makes the others that are ready to spin climb up the twigs.

27 **Different kinds of cocoons.** In about ten or twelve days, according to the accounts which we have received from Mr Andrew Wright of Paisley, it may be safely concluded, that if the worms have finished their work, the cocoons may be collected.

We shall now distinguish the cocoons from one another according to their value or their use, and consider the method of managing each. They may be distinguished into the good and bad. The good cocoons may be known by their marks: they are little, strong, and firm; have a fine grain, both ends are round, and they are free from spots. Among the good cocoons also may be arranged those which are called *calcined cocoons*, in which the worm, in consequence of sickness, is petrified or reduced to a fine powder. These cocoons produce more silk than others, and are sold in Piedmont at half as much again. They may be distinguished by the noise which the worm makes when the cocoon is shaken. Of the bad cocoons there are six species: 1. The *pointed cocoons*, one extremity of which ends in a point; the silk which covers the point is weak, and soon breaks or tears. 2. The *escalons*, which are bigger, but the texture is weak. 3. The *dupions*, or double cocoons, which have been formed by the joint labour of two and sometimes of three worms. 4. The *fluffons*, which have a loose texture, sometimes so loose that they are transparent. 5. The *perforated cocoons*, which have a hole at one end. 6. The *bad cloquette*, which is composed of defective cocoons, spotted or rotten. Besides these there is the *good cloquette*, which does not properly belong to either of these two classes: it is formed of those cocoons in which the worm dies before the silk is brought to perfection. The worms adhere to one side of the cocoon, and therefore when the cocoon is shaken will not rattle: the silk is as fine, but is not of so bright a colour, nor is so strong and nervous, as that which is obtained from good cocoons.

28 **Mr Wright's method of breeding the royal cocoons.** The cocoons which are kept for breeding are called *royal cocoons*. For selecting and preserving these, we have been favoured with some valuable instructions by Mr Wright of Paisley, which we had present to our readers.—The largest and best cocoons ought to be kept for breed, about an equal number of males and females; the cocoons that curl in the former are sharper pointed at the ends than those that contain the latter. Although it should happen that there are more females than males, little inconvenience or ill consequences can arise from it, as one male will serve two or three females, if the time of their coming out of the cocoons answer. About 12 or 15 days after they begin to spin, the cocoons for breed may be laid on sheets

of white paper; about this time the moth opens for itself a passage through the end of its cocoon, and issues out. When the female has laid her eggs, which on an average may amount to 250, they are spread upon sheets of paper and hung up to dry in some place where they may not be exposed to the heat of the sun: after being dried they must be kept in a cool well-aired place, where neither vapours nor moisture can reach them. That they may be preserved from external accidents, as insects of different kinds will destroy them, and mice is their enemy in all the stages of their existence, they should be kept in stone pots or glass bottles with their mouths stopp'd, and these remain until brought out next season to be hatched.

The cocoons from which the silk is to be immediately wound must be exposed to the heat of an oven, in order to kill the chrysalis or aurelia, which would otherwise eat its way through the cocoon, and render it useless. The following directions are given for managing this process by one of the first silk manufacturers in Italy.

Put your cocoons in long shallow baskets, and fill them within an inch of the top. You then cover them up with paper, and put a wrapper over that. These baskets are to be disposed in an oven, whose heat is as near as can be that of an oven from which the bread is just drawn after being baked. When your cocoons have remained therein near an hour, you must draw them out: and see whether all the worms are dead, draw out a dupion from the middle of your basket and open it: if the worm be dead, you may conclude all the rest are so; because the texture of the dupion being stronger than that of the other cocoons, it is consequently less easy to be penetrated by the heat. You must observe to take it from the middle of the basket, because in that part the heat is least perceptible. After you have drawn your baskets from the oven, you must first cover each of them with a woollen blanket or rug, leaving the wrapper besides, and then you pile them above one another. If your baking has succeeded, your woollen cover will be all over wet with a kind of dew, the thickness of your little finger. If there be less, it is a sign your cocoons have been too much or too little baked. If too much baked, the worm, being over-dried, cannot transpire a humour he no longer contains, and your cocoon is then burnt: if not enough baked, the worm has not been sufficiently penetrated by the heat to distill the liquor he contains, and in that case is not dead.

You must let your baskets stand thus covered five or six hours if possible, in order to keep in the heat, as this makes an end of killing those worms which might have avoided the first impression of the fire. You are likewise to take great care to let your cocoons stand in the oven the time that is necessary; for if they do not stand long enough, your worms are only stunned for a time and will afterwards be revived. If, on the other hand, you leave them too long in the oven, you burn them: many instances of these two cases are frequently to be met with. It is a sign of fire when you see some of the bottles rising out from the cocoons which have been baked, because you may be certain they are not burnt. For if you would kill them all to the last worm, you would burn many cocoons, which might be more exposed to the heat than that which kills the worm.

The next operation is the winding of the silk. Be-

fore you begin to wind, you must prepare your cocoons as follows:

1. In stripping them of that waste silk that surrounds them, and which served to fasten them to the twigs. This burr is proper to flax quilts, or other such uses; you may likewise spin it to make stockings, but they will be coarse and ordinary.

2. You must sort your cocoons, separating them into different classes in order to wind them apart. These classes are, the good white cocoons; the good cocoons of all the other colours; the dupions; the coccons, among which are included the weak cocoons; the good choquette; and, lastly, the bad choquette. In sorting the cocoons, you will always find some perforated cocoons among them, whose worm is already born; those you must set apart for flaxet. You will likewise find some foulbers, but very few; for which reason you may put them among the bad choquette, and they run up into waste.

The good cocoons, as well white as yellow, are the easiest to wind; those which require the greatest care and pains are the coccons; you must wind them in cooler water than the others, and if you take care to give them to a good winder, you will have as good silk from them as the rest. You must likewise have careful winders for the dupions and choquettes. These two species require hotter water than the common cocoons.

The good cocoons are to be wound in the following manner: First, choose an open convenient place for your stature, the longer the better, if you intend to have many furnaces and coppers. The building should be high and open on one side, and walled on the other, as well to screen you from the cold winds and receive the sun, as to give a free passage to the steam of your basons or coppers.

These coppers or basons are to be disposed (when the building will admit of it) in a row on each side of the stature, as being the most convenient method of placing them, for by that means in walking up and down you see what every one is about. And these basons should be two and two together, with a chimney between every couple.

Having prepared your reals (which are turned by hands, and require a quick eye), and your fire being a light one under every bason, your winder must stay till the water is as hot as it can be without boiling. When every thing is ready, you throw into your basons two or three handfuls of cocoons, which you gently brush over with a wisk about six inches long, cut stumpy like a broom worn out: by these means the threads of the cocoons silk to the wisk. You must disengage these threads from the wisk, and purge them by drawing these ends with your fingers till they come off entirely clean. This operation is called *la Batue*.

When the threads are quite clear, you must pass four of them (if you will wind fine silk) through each of the holes in a thin iron bar that is placed horizontally at the edge of your bason; afterwards you twist the two ends (which consist of four cocoons each) twenty or twenty-five times, that the four ends in each thread may be better joined together in crossing each other, and that your silk may be plump, which otherwise would be flat.

Your winder must always have a bowl of cold water by her, to dip her fingers in, and to sprinkle very often the said bar, that the heat may not burn the thread.

Your threads, when thus twisted, go upon two iron hooks called rampins, which are placed higher, and from thence they go upon the reel. At one end of the axis of the reel is a cog-wheel, which catching in the teeth of the post-rampin, moves it from the right to the left, and consequently the thread that is upon it; so that your silk is wound on the reel crossways, and your threads form two banks of about four fingers broad.

As often as the cocoons you wind are done, or break or diminish only, you must join fresh ones to keep up the number requisite, or the proportion; because, as the cocoons wind off, the thread being finer, you must join two cocoons half wound to replace a new one: Thus you may wind three new ones and two half wound, and your silk is from four to five cocoons.

When you would join a fresh thread, you must lay one end on your finger, which you throw lightly on the other threads that are winding, and it joins them immediately, and continues to go up with the rest. You must not wind off your cocoons too bare or to the last, because when they are near at an end, the *barre*, that is, the husk, joins in with the other threads, and makes the silk foul and gousy.

When you have finished your first parcel, you must clean your basons, taking out all the striped worms, as well as the cocoons, on which there is a little silk, which you first open and take out the worm, and then throw them into a basket by you, into which you likewise cast the loose silk that comes off in making the battue.

You then proceed as before with other two or three handfuls of cocoons; you make a new battue; you purge them, and continue to wind the same number of cocoons or their equivalent, and so to the end.

As was already mentioned, the winder must always have a bowl of cold water by her, to sprinkle the bar, to cool her fingers every time she dips them in the hot water, and to pour into her bason when necessary, that is, when her water begins to boil. You must be very careful to twist your threads a sufficient number of times, about 25, otherwise your silk remains flat, instead of being round and full; besides, when the silk is not well crossed, it never can be clean, because a gout or nub that comes from a cocoon will pass through a small number of these twists, though a greater will stop it. Your thread then breaks, and you pass what foulness there may be in the middle of your reel between the two banks, which serves for a lead-band and purge the them.

You must observe that your water be just in a proper degree of heat. When it is too hot, the thread is dead, and has no body; when it is too cold, the ends which form the thread do not join well, and form a harsh ill-qualified silk.

You must change the water in your bason four times a day for your dupions and choquette, and twice only for good cocoons when you wind fine silk; but if you wind coarse silk, it is necessary to change it three or four times. For if you were not to change the water, the silk would not be so bright and glossy, because the worm

contained

SILK
Silks

contained in the cocoons foul it very considerably. You must endeavour to wind as much as possible with clear water, for if there are too many worms in it, your silk is covered with a kind of dust which attracts the moth, and destroys your silk.

You may wind your silk of what size you please, from one cocoon to 1200; but it is difficult to wind more than 30 in a thread. The nicety, and that in which consists the greatest difficulty, is to wind even; because as the cocoon winds of the end is finer, and you must then join other cocoons to keep up the same size. This difficulty of keeping the silk always even is so great, that (excepting a thread of two cocoons, which we call *luch*) we do not say a silk of three, of four, or six cocoons; but a silk of three to four, of four to five, of six to seven cocoons. If you proceed to a coarser silk, you cannot calculate so nicely as to one cocoon more or less. We say, for example, from 12 to 15, from 15 to 20, and so on.

31
What number of worms produce a certain quantity of silk.

What number of worms are necessary to produce a certain quantity of silk has not been ascertained. And as different persons who wished to determine this point have had different results, the truth seems to be, that from various circumstances the same number of worms may produce more silk at one time than at another. It is related in the second volume of the Transactions of the Society for encouraging Arts, &c. that Mrs. Williams obtained nearly an ounce and a half of silk from 244 cocoons. Mr. S. Evyne from 50 cocoons produced 100 grains. M. S. Rhodes obtained, from 250 of the largest cocoons, three quarters of an ounce and a dram. From a paper in the second volume of the American Transactions, which we have before referred to in the course of this article, we are informed that 150 ounces of good cocoons yield about 11 ounces of silk from five to six cocoons; if you wind coarser, something more. But what appears astonishing, Mr. Salvatore Bertezan, an Italian, to whom the Society for encouraging Arts, &c. adjudged their gold medal, raised five pounds of excellent silk from 12,000 worms.

32
Length of the threads.

The cocoons produce a thread of very unequal length; you may meet with some that yield 1200 ells, while others will scarcely afford 200 ells. In general, you may calculate the production of a cocoon from 50 to 600 ells in length.

SILK-Loom. See WEAVING.

SILK-Worm. See SILK.

SILLA, a large town on the Niger, by which the travels of Mr. Park were bounded towards the south. He gives no particular description of the place, which his health and spirits permitted him not to survey, but affirms the reason by which he was induced to proceed no farther. On his arrival, he was allowed to remain under a tree, till it was quite dark, farrowed by hundreds of people. But their language was extremely different from the *oolo* or *port* of Bambara, and he was given to understand, that in his travels backward, the Bambara tongue was very little understood; and that, on his reaching Jenné, he would find the greater part of the inhabitants accustomed to speak a different language. He had now become the prey of sickness, exhausted with hunger and fatigue, his baggage, and with an army of slaves, to procure for himself provisions, clothes, or lodging, to which account he resolved to return, finding that to prosecute his journey further in that direc-

tion was wholly impracticable. Silla, according to the latest map of Africa, is in 1° 48' N. Lat. and 1° 23' W. Long.

Silpha
II
Simansas.

SILPHA, CARRION-BEETLE, a genus of insects belonging to the order *coleoptera*. See ENTOMOLOGY Index.

SILPHIUM, a genus of plants belonging to the class of *gynergia*, and to the order of *polygama necessaria*; and in the natural system arranged under the 49th order, *comp. her.* See BOTANY Index.

SILVER, a well-known metallic substance. For an account of its properties, see CHEMISTRY Index.

SILVER, Ores of. See MINERALOGY Index.

Silver-SILVER, is prepared of the lumps of silver leaf, or of the leaves themselves, for the use of painters, after the same manner as shell gold. See Shell GOLD.

SILVERING, the covering of any thing with silver. It is usual to silver metals, wood, paper, &c. which is performed either with fire, oil, or fat. Metal-gilders silver by the fire; painters gilders all the other ways. See GILDING.

To silver copper or brass. 1. Cleanse the metal with aquafortis, by washing it lightly, and immediately throwing it into pure water; or by heating it red-hot, and cooling it with salt and tartar, and pure water, and a small wire brush. 2. Dissolve some silver in aquafortis, in a broad-bottomed glass vessel, or of glazed earth; then evaporate away the aquafortis over a chafin dish of coals. 3. Put five or six times its quantity of water, or as much as will be necessary to dissolve it perfectly, on the remaining dry salt; evaporate this water with the like heat; then put more fresh water, and evaporate again; and, if need be, the third time, making the fire towards the latter end so strong as to leave the salt perfectly dry, which, if your silver is good, will be of a pure white. 4. Take of this salt, commonly, crystals of tartar, or such a like quantity of lark, and mixing with the whole composition, put the metal into pure water, and take of the said powder with you, if wet it goes, and rub it well on, till you find every little cavity of the metal sufficiently silvered over. 5. If you would have it neatly done, you must rub on more of the powder; and, in the last place, wash the silvered metal in pure water, and rub it hard with a dry cloth.

SILVERING of *crystals*. See FALSIFYING of *L. Kings-ships*.

SILURUS, a genus of fishes belonging to the order abdominalis. See ICHTHYOLOGY Index.

SIMANCAS, a village on the eastern boundary of the kingdom of Leon in Spain, five miles below Valladolid, on the river Guarnica. Dr. Barcton, in the introduction to his History of America, makes mention of it, and it is remarkable for the greatness of the kingdoms of Leon and Castile, kept in the castle. This collection was begun when the kings often resided at Valladolid, in which city is still the civil and military tribunal for about the whole of Spain to the north of the Tagus. It was thought proper to have those papers kept in the vicinity of that court, for which purpose this castle was peculiarly fitted, being entirely erected of stone. At one period there were two large halls in this office filled with papers respecting the first settlement of the Spaniards in South America. There was likewise in the room called the *causa real patronage*, a box containing

containing
II
Summ.

containing treaties with England, in which are many letters and treaties between the kings of England and Spain, from the year 1400 to 1620. There was also a strong box in the same archives, with five locks, which, we are told, has not been opened since the time of Philip II. and it is supposed that it contains the process against Philip's son Prince Charles. But it appears that some of the state papers have been removed to Madrid.

SIMEON of DURHAM, the contemporary of William of Malmshury, took great pains in collecting the monuments of our history, especially in the north of England, after they had been scattered by the Danes. From these he composed a history of the kings of England, from A. D. 616 to 1130; with some smaller historical pieces. Simeon both studied and taught the sciences, and particularly the mathematics at Oxford; and became preacher of the church at Durham, where he died, probably soon after the conclusion of his history, which was continued by John, prior of Hexham, to A. D. 1136.

SIMIA, the **MONKEY**, a genus of quadrupeds belonging to the class of mammalia, and order of primates, in the Linnæan system, but by Mr Pennant arranged under the digitated quadrupeds. See **MAMMALIA Indica**.

SIMILE, or **SIMILITUDE**, in *Rhetoric*, a comparison of two things, which though different in other respects, yet agree in some one. The difference between a simile and comparison is said to consist in this, that the simile properly belongs to whatever we call the quality of a thing, and the comparison to the quality. See **COMPARISON**; and **ORATORY**, N° 118.

SIMILOR, a name given to an alloy of red copper and zinc, made in the best proportions, to imitate silver and gold.

SIMON MAGGACHEUS, a celebrated leader and high-priest of the Jews, who, after rendering the most important services to his country, was at last treacherously slain by his son-in-law. See the *History of the JEWS*, N° 125.

SIMON Magus, or the Sorcerer, was a native of Giton, a village of Samaria. According to the usual practice of the Asiatics of that age, he visited Egypt, and there probably became acquainted with the sublime mysteries taught in the Alexandrian school, and learned those theurgic or magical operations, by means of which it was believed that men might be delivered from the power of evil demons. Upon his return into his own country, the author of the Clementine Recognitions relates, that he imposed upon his countrymen by high pretensions to supernatural powers. And St Luke attests, that this artful fanatic, using sorcery, had bewitched the people of Samaria, giving out that he was *some great one*; and that he obtained such general attention and reverence in Samaria, that the people all gave heed to him from the least to the greatest, saying, "This man is the great power of God."

By the preaching of Philip the Deacon, he was with other Samaritans converted to the Christian faith, and admitted into the infant church by the ordinance of baptism. His conversion, however, seems not to have been real; for, upon seeing the miraculous effects of the laying on of the apostle's hands, he offered them money, saying, "Give me also this power, that on whomsoever I lay hands he may receive the Holy Ghost."

He probably thought Peter and John magicians like himself, but better skilled in the art of deceiving the multitudes.

Being sharply reproved for this impiety, he seems by his answer to have been made sensible of his sin; but his repentance, if sincere, was of short duration. Returning to his former practices of imposture, he travelled through various provinces of the empire, opposing the progress of the gospel; and arriving at Rome, he led astray vast numbers of people by his pretended miracles. How long he lived in that metropolis of the world, or in what manner he died, we have no accounts that can be fully depended on. The Christian writers tell us, that being raised in the air by two demons, he was deprived of their support by the prayers of St Peter and St Paul, and falling, broke his legs. By some he is thought to have been the person mentioned by Suetonius, who, undertaking to fly in the presence of Nero, fell to the ground with such violence, that his blood spouted up to the gallery where the emperor was sitting.

The sum of this impostor's doctrine, divested of allegory, was, that from the Divine Being, as a fountain of light, flow various orders of æons, or eternal natures, subsisting within the plenitude of the divine essence; that beyond these, in the order of emanation, are different classes of intelligences, among the lowest of which are human souls; that matter is the most remote production of the emanative power, which, on account of its infinite distance from the Fountain of Light, possesses sluggish and malignant qualities, which oppose the divine operations, and are the cause of evil; that it is the great design of philosophy to deliver the soul from its imprisonment in matter, and restore it to that divine light from which it was derived; and that for this purpose God had sent him one of the first æons among men. To his wife Helena he also ascribed a similar kind of divine nature, pretending that a female æon inhabited the body of this woman, to whom he gave the name of *Evous, Wisdom*; whence some Christian fathers have said, that he called her the *Holy Spirit*. He also taught the transmigration of souls, and denied the resurrection of the body.

SIMON, Richard, was born at Dieppe the 15th May 1638. He began his studies among the priests of the Oratory in that city, but quitted their society in a short time. From Dieppe he went to Paris, where he made great progress in the study of the oriental languages. Some time afterwards he joined the society of the Oratory again, and became a priest of it in 1660. In 1670 he published some pieces of a smaller kind. In 1678 his Critical History of the Old Testament appeared, but was immediately suppressed by the intrigues of Mefmeus du Port Royal. It was reprinted the year after, and its excellence soon drew the attention of foreigners; an edition of it was accordingly published at Amsterdam in Latin, and at London in English.

He died at Dieppe in 1712, at the age of 74.

He certainly possessed a vast deal of learning: His criticism is exact, but not always moderate; and there reigns in his writings a spirit of novelty and singularity which raised him a great many adversaries. The most celebrated of these were Le Clerc, Vossius, Juicau, Du Pin, and Bossuet. SIMON wrote an answer to most of

Simon.

English
History of
Philosophy
vol. II. p.
161.

Simon
II.
Simonides.

the books that were published against him, and displays a pride and obtuseness in his controversial writings which do him little honour.

He was the author of a great many books. The following are the principal: 1. The Ceremonies of the Jews, translated from the Italian of Leo of Modena, with a supplement concerning the sects of the Carraites and Samaritans. 2. *L'Histoire Critique du Vieux Testament*, "The Critical History of the Old Testament." This is a very important work, and deserves the attention of every clergyman. He sometimes, however, deviates from the road of integrity, to serve the cause of the church of Rome, particularly in his endeavours to prove the uncertainty of the Hebrew language. These passages have been very justly exposed and confuted by Dr Campbell, in his ingenious Preliminary Dissertations to his new Translation of the Gospels. 3. Critical History of the Text of the New Testament. 4. Critical History of the Versions of the New Testament. 5. Critical History of the principal Commentators on the New Testament. 6. Inspiration of the Sacred Books. 7. A translation of the New Testament. This book was censured by Cardinal Noailles and Boileau. 8. The History of the rise and progress of Ecclesiastical Revenues, which is commended by Voltaire, as is his Critical History of the Old Testament. It resulted from a quarrel with a community of Benedictines. 9. A new select Library, which points out the good books in various kinds of literature, and the use to be made of them. 10. Critical History of the Belief and Customs of the Nations on the Levant. 11. Critical Letters, &c.

SIMONICAL, is applied to any person guilty of *imony*. See SIMONY.

SIMONIDES, the name of several poets celebrated in antiquity; but by the Marbles it appears that the eldest and most illustrious of them was born in the 53th Olympiad, 538 years B. C. and that he died in his 92th year; which nearly agrees with the chronology of Eusebius. He was a native of Ceos, one of the Cyclades, in the neighbourhood of Attica, and the preceptor of Pindar. Both Plato and Cicero give him the character not only of a good poet and musician, but speak of him as a person of great virtue and wisdom. Such longevity gave him an opportunity of knowing a great number of the first characters in antiquity with whom he was in some measure connected. It appears in Fabricius, from ancient authority, that Simonides was contemporary and in friendship with Ptolemy King of Mitylene, Hipparchus tyrant of Athens, Pausanias King of Sparta, Hiero tyrant of Syracuse, with Themistocles, and with Alcibiades king of Thessaly. He is mentioned by Herodotus; and Xenophon, in his Dialogue upon Tyranny, makes him one of the interlocutors with Hiero king of Syracuse. Cicero alludes, what has often been quoted in proof of the modesty and wisdom of Simonides, that when Hiero asked him for a definition of God, the poet remained a whole day to meditate on so important a question; at the end of which, upon the prince putting the same question to him a second time, he asked two days respite; and in this manner always doubled the day by each time he was required to answer it; till at length, to avoid offending his patron by more dissipated questions, he frankly confessed that he found the question so difficult, that he

more he meditated upon it, the less was his hope of being able to solve it.

In his old age, perhaps from seeing the respect which money procured to such as had lost the charms of youth and the power of attaching mankind by other means, he became somewhat mercenary and avaricious. He was frequently employed by the victors at the games to write panegyrics and odes in their praise, before his pupil Pindar had exercised his talents in their behalf; but Simonides would never gratify their vanity in this particular, till he had first tied them down to a stipulated sum for his trouble; and upon being upbraided for his meanness, he said, that he had two coffers, in one of which he had for many years put his pecuniary rewards; the other was for honours, verbal thanks, and promises; that the first was pretty well filled, but the last remained always empty. And he made no scruple to confess, in his old age, that of all the enjoyments of life, the love of money was the only one of which time had not deprived him.

He was frequently reproached for this vice; however, he always defended himself with good humour. Upon being asked by Hiero's queen, Whether it was most desirable to be learned or rich? he answered, that it was far better to be rich; for the learned were always dependent on the rich, and waiting at their doors; whereas, he never saw rich men at the doors of the learned. When he was accused of being so fond as to sell part of the provisions with which his table was furnished by Hiero, he said he had done it in order "to display to the world the magnificence of that prince and his own frugality." To others he said, that his reason for accumulating wealth was, that "he would rather leave a penny to his enemies after death, than be troublesome to his friends while living."

He obtained the prize in poetry at the public games when he was fourscore years of age. According to Suidas, he added four letters to the Greek alphabet; and Pliny assigns to him the eighth string of the lyre; but these claims are disputed by the learned.

His poetry was so tender and plaintive, that he acquired the cognomen of *Melicertes*, "sweet as honey;" and the tearful eye of his muse was proverbial. Dionysius places him among those polished writers who excel in a smooth volubility, and flow on like plentiful and perennial rivers, in a course of even and uninterrupted harmony.

It is to Dionysius that we are indebted for the preservation of the following fragment of this poet. Danae being by her merciful father inclosed in a chest, and thrown into the sea with her child, when night comes on, and a storm arises which threatens to overset the chest, she, weeping and embracing the young Perseus, cries out:

Sweet child! what anguish does thy mother know,
 Ere cruel grief has taught thy tears to flow!
 Amidst the roaring wind's tremendous sound,
 Which threatens destruction as it howls around;
 In balmy sleep thou liest, as at the breast,
 Without one bitter thought to break thy rest.—
 The glimmering moon in pity hides her light,
 And thinks with horror at the ghastly sight,
 Didst thou but know, sweet innocent! our woes,
 Not spiteful power thy eyelids now could close.

See;

Simple
 ||
 Simplicity

Sleep on, sweet babe! ye waves in silence roll;
 And lull, O lull, to rest my tormented soul!

Simon
 ||
 Simplicity

There is a second great poet of the name of Simonides recorded on the Marble, supposed to have been his grandson, and who gained, in 478 B. C. the prize in the games at Athens.

SIMONY, is the corrupt presentation of any one to an ecclesiastical benefice for money, gift, or reward. It is so called from the resemblance it is said to bear to the sin of Simon Magus, though the purchasing of holy orders seems to approach nearer to his offence. It was by the canon law a very grievous crime; and is so much the more odious, because, as Sir Edward Coke observes, it is ever accompanied with perjury; for the presentee is sworn to have committed no simony. However, it was not an offence punishable in a criminal way at the common law; it being thought sufficient to leave the clerk to ecclesiastical censures. But as these did not affect the simoniacal patron, nor were efficacious enough to repress the notorious practice of the thing, divers acts of parliament have been made to restrain it by means of civil forfeitures; which the modern prevailing usage, with regard to spiritual preferments, calls aloud to be put in execution. The statute 31 Eliz. c. 6. enacts, that if any patron, for money or any other corrupt consideration or promise, directly or indirectly given, shall present, admit, institute, induct, install, or collate any person to an ecclesiastical benefice or dignity, both the giver and taker shall forfeit two years value of the benefice or dignity; one moiety to the king, and the other to any one who will sue for the same. If persons also corruptly resign or exchange their benefices, both the giver and taker shall in like manner forfeit double the value of the money or other corrupt consideration. And persons who shall corruptly ordain or license any minister, or procure him to be ordained or licensed (which is the true idea of simony), shall incur a like forfeiture of forty pounds; and the minister himself of ten pounds, besides an incapacity to hold any ecclesiastical preferment for seven years at rewards. Corrupt elections and resignations in colleges, hospitals, and other eleemosynary corporations, are also punished, by the same statute, with forfeiture of the double value, vacating the place or office, and a devolution of the right of election, for that term, to the crown.

SIMOOM, a hot wind which blows occasionally in the deserts of Africa, and probably in other widely extended countries parched in the same manner by a vertical sun. Its effects on the human body are dreadful. If inhaled in any quantity, it produces instant suffocation, or at least leaves the unhappy sufferer oppressed with asthma and hoarseness of voice. The approach of this awful scourge of God is indicated by a redness in the air, well understood by those who are accustomed to journey through the desert; and the only refuge which they have from it, is to fall down with their faces close to the ground, and to continue as long as possible without drawing in their breath.

Mr Bruce, who, in his journey through the desert, suffered from the simoom, gives of it the following graphical description: "At eleven o'clock, while we contemplated with great pleasure the rugged top of Cligge, to which we were fast approaching, and where we were to solace ourselves with plenty of good water,

Idris our guide cried out, with a loud voice, Fall upon your faces, for here is the simoom. I saw from the south east a haze come, in colour like the purple part of the rainbow, but not so compressed or thick. It did not occupy twenty yards in breadth, and was about twelve feet high from the ground. It was a kind of bluish upon the air, and it moved very rapidly; for I scarce could turn to fall upon the ground with my head to the northward, when I felt the heat of its current plainly upon my face. We all lay flat on the ground as if dead, till Idris told us it was blown over. The meteor or purple haze which I saw was indeed passed, but the light air that still blew was of heat to threaten suffocation. For my part, I found distinctly in my breast that I had imbibed a part of it, nor was I free of an asthmaic sensation till I had been some months in Italy, at the baths of Poretta, near two years afterwards." Though the severity of this blait seems to have passed over them almost instantaneously, it continued to blow so as to exhaust them till twenty minutes before five in the afternoon, lasting through all its stages very near six hours, and leaving them in a state of the utmost dependency.

SIMPLE, something not mixed or compounded; in which sense it stands opposed to *compound*.

SIMPLE, in the *Materia Medica*, a general name for all herbs or plants, as having each its particular virtue, whereby it becomes a simple remedy.

SIMPLICITY IN WRITING. If we examine the writers whose compositions have stood the test of ages, and obtained that highest honour, "the concurrent approbation of distant times and nations," we shall find that the character of simplicity is the unvarying circumstance which alone hath been able to gain this universal homage from mankind. Among the Greeks, whose writers in general are of the simple kind, the divinely poet, the most commanding orator, the finest historian, and deepest philosopher, are, above the rest, conspicuously eminent in this great quality. The Roman writers rise towards perfection according to that measure of simplicity which they mingle in their works; indeed they are all inferior to the Greek models. But who will deny that Lucretius, Horace, Virgil, Livy, Terence, Tully, are at once the simplest and best of Roman writers? unless we add the noble annalist who appeared in after-times; who, notwithstanding the political turn of his genius, which sometimes interferes, is admirable in this great quality, and by it far superior to his contemporaries. It is this one circumstance that hath raised the venerable Dante, the father of modern poetry, above the succeeding poets of his country, who could never long maintain the local and temporary honours bestowed upon them; but have fallen under that just neglect which time will ever decree to those who desert a just simplicity for the florid colourings of style, contrived phrases, affected conceits, the mere trappings of composition and Gothic miswrite. It is this which is given to Boileau the most lasting wreath in France, and to Shakespeare and Milton in England; especially to the former, whose writings contain specimens of perhaps the purest and simplest English that is anywhere to be found, except in the Bible or Book of Common Prayer. As it appears from these instances, that simplicity is the only universal characteristic of just writing, so the superior eminence of the sacred Scriptures

Mr Bruce
 Travels,
 vol. 16.
 p. 229.

Simplicity in this quality hath been generally acknowledged. One of the greatest critics in antiquity, himself conspicuous in the sublime and simple manner, hath borne this testimony to the writings of Moses and St Paul; and by parity of reason we must conclude, that had he been conversant with the other sacred writers, his taste and candour would have allowed them the same encomium.

It hath been often observed, even by writers of no mean rank, that the "Scriptures suffer in their credit by the disadvantage of a literal version, while other ancient writings enjoy the advantage of a free and embellished translation." But in reality these gentlemen's concern is ill placed and groundless: for the truth is, "that most other writings are impaired by a literal translation; whereas giving only a due regard to the idiom of different languages, the sacred writings, when literally translated, are then in their full perfection."

Now this is an internal proof, that in all other writings there is a mixture of local, relative, exterior ornament, which is often lost in the transference from one language to another. But the internal beauties, which depend not on the particular construction of tongues, no change of tongue can destroy. Hence the Bible preserves its native beauty and strength alike in every language, by the sole energy of unadorned phrase, natural images, weight of sentiment, and great simplicity.

It is in this respect like a rich vein of gold, which, under the severest trials of heat, cold, and moisture, retains its original weight and splendour, without either loss or alloy; while baser metals are corrupted by earth, air, water, fire, and assimilated to the various elements through which they pass.

This circumstance, then, may be justly regarded as sufficient to vindicate the composition of the sacred Scriptures, as it is at once their chief excellence and greatest security. It is their excellence, as it renders them intelligible and useful to all; it is their security, as it prevents their being disguised by the false and capricious ornaments of vain or weak translators. We may safely appeal to experience and fact for the confirmation of these remarks on the superior simplicity, utility, and excellence, of the style of the Holy Scripture. Is there any book in the world so perfectly adapted to all capacities? that contains such sublime and exalted precepts, conveyed in such an artless and intelligible strain, that can be read with such pleasure and advantage by the lettered sage and the unlettered peasant?

SIMPLOCE. See ORATORY, N^o 72.

SIMPSON, THOMAS, professor of mathematics at the royal academy at Woolwich, fellow of the Royal Society, and member of the Royal Academy at Stockholm, was born at Market Bosworth in Leicestershire in 1712. His father, a fluff-weaver, taught him only to read English, and brought him up to his own business; but meeting with a scientific pedlar, who likewise practised fortune-telling, young Simpson by his assistance and advice left off weaving, and professed astrology. As he improved in knowledge, however, he grew disgusted with his pretended art; and renouncing it, was driven to such difficulties for the subsistence of his family, that he came up to London, where he worked as a weaver, and taught mathematics at his spare hours.

As his scholars increased, his abilities became better known, and he published his Treatise on Fluxions, by subscription, in 1737: in 1740, he published his Treatise on the Nature and Laws of Chance; and Essays in Speculative and Mixed Mathematics. After these appeared his Doctrine of Annuities and Reversions, Mathematical Disquisitions; Treatise on Algebra; Elements of Geometry; Trigonometry, Plane and Spherical; Select Exercises; and his Doctrine and Application of Fluxions, which he professes to be rather a new work, than a second edition of his former publication on fluxions. In 1743, he obtained the mathematical professorship at Woolwich academy; and soon after was chosen a member of the Royal Society, when the president and council, in consideration of his moderate circumstances, were pleased to excuse his dismission, and his giving bonds for the settled future payments. At the academy he exerted all his abilities in instructing the pupils who were the immediate object of his duty, as well as others whom the superior officers of the ordnance permitted to be boarded and lodged in his house. In his manner of teaching he had a peculiar and happy address, a certain dignity and perspicuity, tempered with such a degree of mildness, as engaged the attention, esteem, and friendship, of his scholars. He therefore acquired great applause from his superiors in the discharge of his duty. His application and close confinement, however, injured his health. Exercise and a proper regimen were prescribed to him, but to little purpose: for his spirits sunk gradually, till he became incapable of performing his duty, or even of reading the letters of his friends. The effects of this decay of nature were greatly increased by vexation of mind, owing to the haughty and insulting behaviour of his successor the first professor of mathematics. This person, greatly his inferior in mathematical accomplishments, did what he could to make his situation uneasy, and even to depreciate him in the public opinion: but it was a vain endeavour, and only served to depress himself. At length his physicians advised his native air for his recovery, and he set out in February 1761; but was so fatigued by his journey, that upon his arrival at Bosworth, he betook himself to his chamber, and grew continually worse till the day of his death, which happened on the 14th of May, in the 51st year of his age.

SIMPSON, DR ROBERT, professor of mathematics in the university of Glasgow, was born in the year 1687 of a respectable family, which had held a small estate in the county of Lanark for some generations. He was, we think, the second son of the family. A younger brother was professor of medicine in the university of St Andrew's, and is known by some works of reputation, particularly a Dissertation on the Nervous System, occasioned by the Dissection of a Brain completely Ossified.

Dr Simpson was educated in the university of Glasgow under the eye of some of his relations who were professors. Eager after knowledge, he made great progress in all his studies; and, as his mind did not, at the very first openings of science, strike into that path which afterwards so strongly attracted him, and in which he proceeded so far almost without a companion, he acquired in every walk of science a Book of information, which, though it had never been much augmented afterwards, would have done credit to a professional man.

Simon. in any of his studies. He became, at a very early period, an adept in the philosophy and theology of the schools, was able to supply the place of a sick relation in the class of oriental languages, was noted for historical knowledge, and one of the most knowing botanists of his time.

It was during his logical studies, as preparatory for his entering into orders, that mathematics took hold of his fancy. He used to tell in his convivial moments how he amused himself when preparing his exercises for the divinity hall. When tired with vague speculation, in which he did not meet with certainty to reward his labours, he turned up a book of oriental philology, in which he found something which he could discover to be true or to be false, without going out of the line of study which was to be of ultimate use to him. Sometimes even this could not relieve his fatigue. He then had recourse to mathematics, which never failed to refresh and refresh him. For a long while he restricted himself to a very moderate use of the cord, fearing that he would soon exhaust the small stock which is limited and abstract a science could yield; till at last he found, that the more he learned, a wider field opened to his view, and topics that were inexhaustible. Becoming acquainted with subjects far beyond the elements of the science, and with numbers of names celebrated during that period of orient research all over Europe, he found it to be a manly and important study, by which he was as likely to acquire reputation as by any other. About this time, too, a project he an to open of making mathematics his profession for life. He then gave himself up to it without reserve.

His original inclination to this study as a treat, as something to please and refresh his mind in the midst of severer tasks, gave a particular turn to his mathematical studies, from which he never could afterwards deviate. Purity and elegance are more attainable, and more discernible, in pure geometry, than in any other parts of the science of measure. To this therefore he chiefly devoted himself. For the same reason he preferred the ancient method of studying pure geometry, and even felt a dislike to the Cartesian method of substituting symbols for operations of the mind, and still more was he displeas'd with the substitution of symbols for the very objects of attention, for lines, surfaces, solids, and their affections. He was rather disposed in the solution of an algebraical problem, where quantity alone was considered, to substitute figure and its affections for the rigid algebraic symbols, and to convert the algebraic formula into an analogous geometrical theorem. And he came at last to consider algebraic analysis as little better than a kind of mechanical knack, in which we proceed without ideas of any kind, and obtain a result without meaning, and without being conscious of any process of reasoning, and therefore without any conviction

of its truth. And there is no denying, that if genuine undisciplin'd taste alone is to be consulted, Dr Simon was in the right; for though it must also be acknowledged, that the reasoning in algebra is as strict as in the pure geometry of Euclid or Apollonius, the exact analyst has little perception of it as he goes on, and his final equation is not felt by himself as the result of real creation, any more than if he had obtained it by Pascal's mathematical mill. This does not in the least diminish our admiration of the algebraic analysis; for its almost boundless grasp, its rapid and certain procedure, and the delicate metaphysics and great additions which may be displayed in conducting it. Such, however, was the ground of the strong bias of Dr Simon's mind to the analysis of the ancient geometers. It increased as he went forward; and his veneration (we may call it his *love or affection*) for the ancient geometry was carried to a degree of idolatry. His chief labours were exerted in efforts to restore the works of the ancient geometers; and he has nowhere bestowed much pains in advancing the modern discoveries in mathematics. The noble inventions, for example, of fluxions and of logarithms, by which our progress in mathematical knowledge, and in the useful application of this knowledge, is so much promoted, attracted the notice of Dr Simon; but he has contented himself with demonstrating their truth on the genuine principles of the ancient geometry. Yet was he very thoroughly acquainted with all the modern discoveries; and there are to be seen among his papers, excellent and investigations in the Cartesian method, which show him thoroughly acquainted with all the principles, and even exposed in the *Leçons de Mécanique*, of the most refined symbolical analysis (A).

About the age of 25 Dr Simon was chosen professor of mathematics in the university of Gating. He went to London immediately after his appointment, and there formed an acquaintance with the most eminent men of that bright era of British science. Among these he always mentioned Captain Halley (the celebrated Dr Edmund Halley) with particular respect; saying, that he had the most acute penetration, and the most just taste in that science, of any man he had ever known. And, indeed, Dr Halley has strongly exemplified both of these in his civilization of the work of *Apollonius de Sectione Spatii*, and the 8th book of his *Conics*, and in some of the most beautiful theorems in Sir Isaac Newton's *Principia*. Dr Simon also admired the wide and masterly steps which Newton was accustomed to take in his investigations, and his manner of substituting geometrical figures for the quantities which are observed in the phenomena of nature. It was from Dr Simon that the writer of this article had the remark which has been often and once repeated in the course of this work, "That the 39th proposition of the first book of the *Principia* was the most important proposition

(A) In 1752 the writer of this article being then his scholar, requested him to examine an account which he gave him of what he thought a new curve (a conchoid having a circle for its base). Dr Simon returned it next day with a regular list of its leading properties, and the investigation of such as he thought his scholar would not so easily trace. In this I may know the lines related to the circle were familiarly considered as arithmetical fractions of the radius considered as unity. This was before Euler published his *Arithmetica* of the Sines and Tangents, now in universal use.

position that had ever been exhibited to the physical-mathematical philosopher; and he used always to illustrate to his more advanced scholars the superiority of the geometrical over the algebraic analysis, by comparing the solution given by Newton of the inverse problem of centripetal forces, in the 42d proposition of that book, with the one given by John Bernoulli in the *Mémoires* of the Academy of Sciences at Paris for 1713. We have heard him say, that to his own knowledge Newton frequently investigated his propositions in the feebled way, and that it was owing chiefly to Dr Halley that they did not finally appear in that dress. But if Dr Simson was well informed, we think it a great argument in favour of the symbolic analysis, when this most successful *practical artist*? (for so we must call Newton when engaged in a task of discovery) found it conducive either to dispatch or perhaps to his very progress.

Returning to his academic chair, Dr Simson discharged the duties of a professor for more than 50 years with great honour to the university and to himself.

It is almost needless to say, that in his lectures he followed strictly the Euclidian method in elementary geometry. He made use of Theodorus as an introduction to spherical trigonometry. In the higher geometry he preferred from his own Conics; and he gave a small specimen of the *linear problems* of the ancients, by explaining the properties, sometimes of the conchoid, sometimes of the cissoid, with their application to the solution of such problems. In the more advanced class he was accustomed to give Napier's mode of conceiving logarithms, i. e. quantities as generated by motion; and Mr Cotes's view of them, as the sums of ratioculæ; and to demonstrate Newton's Lemmas concerning the limits of ratios; and then to give the elements of the fluxionary calculus; and to finish his course with a select set of propositions in optics, gnomonics, and central forces. His method of teaching was simple and perspicuous, his elocution clear, and his manner easy and impressive. He had the respect, and still more the affection, of his scholars.

With respect to his studies, we have already informed the reader that they got an early bias to pure geometry, and to the elegant but scrupulous methods of the ancients.

We have heard Dr Simson say, that it was in a great measure owing to Dr Halley that he so early directed his efforts to the re-edition of the ancient geometries. He had recommended this to him, as the most certain way for him, then a very young man, both to acquire reputation, and to improve his own knowledge and taste, and he received him with a copy of Pappus's *Mathematical Questions*, enriched with some of his own notes. The perusal of the ancient geometrical analysis, and a certain elegance in the nature of the solutions which it affords, especially by means of the local theorems, soon took firm hold of his fancy, and made him, with the sanguine expectation of a young man, direct his very first efforts to the recovery of this *treasure*, and the restoration of Euclid's *Porisms* was the first task which he set himself. The accomplished geometer knows what a desperate task this was, from the scanty and mutilated account which we have of this work in a single passage of Pappus. It was an ambition which nothing but success could justify in so young an adventurer. He suc-

ceeded; and so early as 1713 he had been in complete possession of this method of investigation, which was considered by the eminent geometers of antiquity as their sacred guide through theabyrinth of the higher geometry. Dr Simson gave a specimen of his discovery in 1723 in the *Philosophical Transactions*. And after this time he ceased not from his endeavours to recover that choice collection of *Porisms* which Euclid had collected, as of the most general use in the solution of difficult questions. What sort of success must have been pointed out to Dr Simson by the very nature of the general proposition of Pappus, which he has retained. Others were pointed out by the lemmas which Pappus has given as helps to the young mathematician towards their demonstration. And being thus in possession of a considerable number, their mutual relations pointed out a sort of system, of which these made a part, and of which the blanks now remained to be filled up.

Dr Simson, having thus gained his favourite point, had leisure to turn his attention to the other works of the ancient geometers; and the *porisms* of Euclid now had only an occasional share. The *loci plani* of Apollonius was another task which he very early engaged in, and completed about the year 1735. But, after it was printed, he imagined that he had not given the *most concise propoitions* of Apollonius, and in the preface printed and order of that author. The impediment lay him for some years; and it was with great reluctance that he yielded to the importunities of his mathematical friends, and published the work, in 1746, with some emendations, where he thought he had deviated farthest from his author. He quickly repented of this too hasty concession, and recalled what he could of the final number of copies which he had given to the booksellers, and the impediment again lay him for years. He afterwards recorrected the work, and still with some reluctance allowed it to come abroad as the *Restitutio* of Apollonius. The public, however, had not been so fastidious as Dr Simson, and the work had acquired great celebrity, and he was now considered as one of the first and the most elegant geometers of the age; for, in the mean time, he had published his *Conic Sections*, a work of uncommon merit, whether we consider it as equivalent to a complete restoration of the celebrated work of Apollonius Pergeus, or as an excellent specimen of this important part of mathematics. It is marked with the same features as the *loci plani*, the most anxious solicitude to exhibit the very text of Apollonius, even in the propositions belonging to the books which had been completely lost. These could be recovered in no other way but by a thorough knowledge of the precise plan proposed by the author, and by taking it for granted that the author had accurately accomplished this plan. In this manner did Viviani proceed in the first attempt which was made to restore the copies of Apollonius; and he has given us a detail of the process of his conjectures, by which we may form an opinion of his industry, and of the probability how far he has attained the desired object. Dr Simson's view in his performance was something different, depending a little in this respect from his general track. He was not altogether pleased with the work of Viviani, even as augmented by the eighth book, added by Halley, and his wish was to restore the ancient original. But, in the mean time, an

of a mathematical text book for conic sections was much wanted. He was much dissatisfied with those in common use; and he was not infensible of the advantage resulting from the consideration of these sections, independent of the cone first introduced by Dr Wallis. He therefore composed this excellent treatise as an elementary book, not to supersede, but to prepare for the study of Apollonius; and accordingly accommodates it to this purpose, and gives several important propositions in their proper places, expressly as *restitutions of Apollonius*, whom he keeps constantly in view through the whole work.

Much about this time Dr Simson seriously began to prepare a perfect edition of Euclid's Elements. The intimate acquaintance which he had by this time acquired with all the original works of the ancient geometers, and their ancient commentators and critics, encouraged him to hope that he could restore to his original lustre this leader in mathematical science; and the errors which had crept into this celebrated work, and which still remained in it, appeared of magnitude sufficient to merit the most careful efforts for their removal. The DATA also, which were in like manner the introduction to the whole art of geometrical investigation, seemed to call more loudly for his amending hand. For it appears that the Saracens, who have preserved to us the writings of the ancients, have contented themselves with admiring these celebrated works, and have availed themselves of the knowledge which they contain; but they have shown no inclination to add to the stock, or to promote the sciences which they had received. They could not do any thing without the fyncrhetical books of the geometers; but, not meaning to go beyond the discoveries which they had made, they neglected all the books which related to the analytic art alone, and the greatest part of them (about 25 out of 92) have irrevocably perished. The data of Euclid have fortunately been preserved, but the book was neglected, and the only ancient copies, which are but three or four, are miserably erroneous and mutilated. Fortunately, it is no very arduous matter to reinstate this work in its original perfection. The plan is precise, both in its extent and its method. It had been restored, therefore, with success by more than one author. But Dr Simson's comprehensive view of the whole analytical system pointed out to him many occasions for amendment. He therefore made its institution a joint talk with that of the elements. All the lovers of true geometry will acknowledge their obligations to him for the edition of the Elements and data which he published about 1738. The text is corrected with the most judicious and scrupulous care, and the notes are inestimable, both for their information, and for the tendency which they must have to form the mind of the student to a true judgement and taste in mathematical subjects. The more accomplished reader will perhaps be sometimes disposed to smile at the axiom which seems to pervade the notes, "that a work of Euclid must be surpassed without error or defect." If this was not the case, Euclid had been obliged to his editor in more instances than one. Nor should his greatest admirers think it impossible that in the progress of human improvement, a geometrical truth should occur to one of these latter days, which escaped the notice of even the Lineal Euclid. Such merit, however, Dr Simson nowhere claims, but lays every blame of error,

or obscurity, to the charge of Proclus, Theon, and other editors and commentators of the renowned Grecian.

There is another work of Apollonius on which Dr Simson has bestowed great pains, and has restored, as we imagine, *omnibus numeris perfectum*, viz. the SECTIO DETERMINATA; one of those performances which are of indispensable use in the application of the ancient analysis. This also seems to have been an early task, though we do not know the date of his labours on it. It did not appear till after his death, being then published along with the great work, the Poims of Euclid, at the expense of the late Earl Stanhope, a nobleman intimately conversant with the ancient geometry, and zealous for its reception among the mathematicians of the present age. He had kept up a constant correspondence with Dr Simson on mathematical subjects; and at his death in 1768, engaged Mr Clow professor of logic in the university of Glasgow, to whose care the Doctor had left all his valuable papers, to make a selection of such as would serve to support and increase his well-earned reputation as THE RESTORER OF ANCIENT GEOMETRY.

We have been thus particular in our account of Dr Simson's labours in these works, because his manner of execution, while it does honour to his inventive powers, and shows his just taste in mathematical composition, also confirms our former assertion, that he carried his respect for the ancient geometers to a degree of superstitious idolatry, and that his fancy, unchecked, viewed them as incapable of error or imperfection. This is distinctly to be seen in the emendations which he has given of the texts, particularly in his editions of Euclid. Not only every imperfection of the reading is ascribed to the ignorance of copyists, and every indistinctness in the conception, inconclusiveness in the reasoning, and defect in the method, is ascribed to the ignorance or mistake of the commentators; but it is all along assumed that the work was perfect in its kind; and that by exhibiting a perfect work, we restore the genuine original. This is surely gratuitous; and it is very possible that it has, in some instances, made Dr Simson fail of his anxious purpose, and give us even a better than the original. It has undoubtedly made him fail in what *should have been* his great purpose, viz. to give the world a connected system of the ancient geometrical analysis; such as would, in the first place, exhibit it in its most engaging form, elegant, perspicuous, and comprehensive; and, in the next place, such as should engage the mathematicians of the present age to adopt it as the most certain and successful conductor in those laborious and difficult researches in which the demands of modern science continually engage them. And this might have been expected, in the province of speculative geometry at least, from a person of such extensive knowledge of the properties of figure, and who had so eminently succeeded in the many trials which he had made of its powers. We might have expected that he would at least have exhibited in one systematic point of view, what the ancients had done in several detached branches of the science, and how far they had proceeded in the solution or the several successive classes of problems; and we might have hoped, that he would have instructed us in what manner we should apply that method to the solution of problems of a more elevated kind, daily pre-
sented

Simon.

fented to us in the questions of physico-mathematical science. By this he would have acquired distinguished honour, and science would have received the most valuable improvement. But Dr Simon has done little of all this; and we cannot say that great help has been derived from his labours by the eminent mathematicians of this age, who are successfully occupied in advancing our knowledge of nature, or in improving the arts of life. He has indeed contributed greatly to the entertainment of the speculative mathematician, who is more delighted with the conscious exercise of his own reasoning powers, than with the final result of his reasonings. Yet we are not even certain that Dr Simon has done this to the extent he wished and hoped. He has not engaged the liking of mathematicians to this analysis, by presenting it in the most agreeable form. His own extreme anxiety to tread in the very footsteps of the original authors, has, in a thousand instances, precluded him from using his own extensive knowledge, that he might not employ principles which were not of a class inferior to that of the question in hand. Thus, of necessity, did the method appear tramelled. We are deterred from employing a process which appears to restrain us in the application of the knowledge which we have already acquired; and, disgusted with the tedious, and perhaps indirect path, by which we must arrive at an object which we see clearly over the hedge, and which we could reach by a few steps, of the security of which we are otherwise perfectly assured. These prepossessions are indeed founded on mistake; but the mistake is such, that all fall into it, till experience has enlarged their views. This circumstance alone has hitherto prevented mathematicians from acquiring that knowledge of the ancient analysis which would enable them to proceed in their researches with certainty, dispatch, and delight. It is therefore deeply to be regretted, that this eminent genius has occupied, in this superstitious paleology, a long and busy life, which might have been employed in original works of infinite advantage to the world, and honour to himself.

Our readers will, it is hoped, consider these observations as of general scientific importance, and as intimately connected with the history of mathematics; and therefore as not improperly introduced in the biographical account of one of the most eminent writers on this science. Dr Simon claimed our notice as a mathematician; and his affectionate admiration of the ancient analysis is the prominent feature of his literary character. By this he is known all over Europe; and his name is never mentioned by any foreign author without some very honourable allusion to his distinguished geometrical elegance and skill. Dr James Meor, professor of Greek in the university of Glasgow, no less eminent for his knowledge in ancient geometry than for his professional talents, put the following apposite inscription below a portrait of Dr Simon:

GEOMETRIAM, SUB TYRANNO BARBARO STVA
SERVITUTE DIDI, SOLI QUANTUM IN LIBERTATEM
ET LEGIS ANTIQVÆ VINDICAVIT
VIVIS.

Yet it must not be understood that Dr Simon's predilection for the geometrical analysis of the ancients did so far mislead him as to make him neglect the symbolical analysis of the present times; on the contrary, he

was completely master of it, as has been already observed, and frequently employed it. In his academical lectures to the students of his upper classes, he used to point out its proper province (which he by no means limited by a scanty boundary), and in what cases it might be applied with safety and advantage even to questions of pure geometry. He once honoured the writer of this article with the sight of a very short dissertation on this subject (perhaps the one referred to in the preface to his *Conic Sections*). In this piece he was perhaps more liberal than the most zealous partisans of the symbolical analysis could desire, admitting as a sufficient equation of the Conic

Sections $L = \frac{p^2 e}{c}$, where L is the *latus rectum*, e is

the distance of any point of the curve from the focus, f is the perpendicular drawn from the focus to the tangent in the given point, and c is the chord of the equicurve circle drawn through the focus. Unfortunately this dissertation was not found among his papers. He spoke in high terms of the Analytical Works of Mr Cotes, and of the two Bernoullis. He was consulted by Mr Maclaurin during the progress of his inestimable *Treatise of Fluxions*, and contributed not a little to the reputation of that work. The spirit of that most ingenious algebraic demonstration of the fluxions of a rectangle, and the very process of the argument, is the same with Dr Simon's in his dissertation on the limits of quantities. It was therefore from a thorough acquaintance with the subject, and by a just taste, that he was induced to prefer his favourite analysis, or, to speak more properly, to exhort mathematicians to employ it in its own sphere, and not to become ignorant of geometry, while he successfully employed the symbolical analysis in cases which did not require it, and which suffered by its admission. It must be acknowledged, however, that in his later years, the disgust which he felt at the artificial and slovenly employment on subjects of pure geometry, sometimes hindered him from even looking at the most refined and ingenious improvements of the algebraic analysis which occur in the writings of Euler, D'Alembert, and other eminent masters. But, when properly informed of them, he never failed to give them their due praise; and we remember him speaking, in terms of great satisfaction, of an improvement of the infinitesimal calculus, by D'Alembert and De la Grange, in their researches concerning the propagation of sound, and the vibrations of musical cords.

And that Dr Simon not only was master of this calculus and the symbolical calculus in general, but held them in proper esteem, appears from two valuable dissertations to be found in his posthumous works; the one on logarithms, and the other on the limits of ratios. The first, in particular, shows how completely he was satisfied with respect to the solid foundation of the method of fluxions; and it contains an elegant and strict demonstration of all the applications which have been made of the method by its illustrious author to the objects of pure geometry.

We hoped to have given a much more complete and instructive account of this eminent geometer and his works, by the aid of a person fully acquainted with both, and able to appreciate their value; but an accident has deprived us of this assistance, when it was too late to procure an equivalent; and we must in quietness read as to accept of this very imperfect account, though we cannot do justice to Dr Simon's merit, unless should

Simon.

equally conversant in all the geometry of the ancient Greeks.

The life of a literary man rarely teems with anecdote; and a mathematician, devoted to his studies, is perhaps more abstracted than any other person from the ordinary occurrences of life, and even the ordinary topics of conversation. Dr Simson was of this class; and, having never married, lived entirely a college life. Having no occasion for the commodious house to which his place in the university entitl'd him, he contented himself with chambers, good indeed, and spacious enough for his sober accommodation, and for receiving his choice collection of mathematical writers, but without any decoration or commodious furniture. His official services sufficed for valet, footman, and chambermaid. As his retirement was entirely devoted to study, he entertained no company in his chambers, but in a neighbouring house, where his apartment was forced to him and his guests.

Having in early life devoted himself to the restoration of the works of the ancient geometers, he studied them with unremitting attention; and, retiring from the promiscuous intercourse of the world, he contented himself with a small society of intimate friends, with whom he could lay aside every restraint of ceremony or reserve, and indulge in all the innocent frivolities of life. Every Friday evening was spent in a party at whist, in which he excelled, and took delight in instructing others, till increasing years made him less patient with the dulness of a scholar. The card-party was followed by an hour or two dedicated solely to playful conversation. In like manner, every Saturday he had a less select party to dinner at a house about a mile from town. The Doctor's long life gave him occasion to see the *dramatis personæ* of his little theatre several times completely changed, while he continued to give it a personal identity; so that, without any design or wish of his own, it became, as it were, his own house and his own family, and went by his name. In this state did the present writer first see it, with Dr Simson as its father and head, respected and beloved by every branch; for, as it was for relaxation, and not for the enjoyment of his acknowledged superiority, that he continued this habit of his early youth; and as his notions "of a fine talk" did not consist in the pleasure of having "told and gored a good many to-day," his companions were as much at their ease as he wished to be himself; and it was no small part of their entertainment (and of his too), to smile at those innocent deviations from common forms, and those mistakes with respect to life and manners, which an almost total retirement from the world, and incessant occupation in an abstract science, caused this venerable merchant frequently to exhibit. These are remembered with a more affecting regret, that they are now "with the days that are past," than the most pithy apothegms, uttered in with an emphatical, "Wha, Sir!" or "No, Sir!" which precludes all reply. Dr Simson never exerted his prudential authority, unless it were to check some infringement of good breeding, or any thing that appeared officiously to religion or purity of manners; for there he had the highest reverence. We have twice heard him sing (he had a fine voice and most accurate ear) some lines of a Latin hymn to the Divine Geometer, and each time the rapturous tear stood in his eye.

But we ask the reader's pardon for this digression; it is not his water of life, since it paints the man as much as any record of his studies; and to his acquaintances we are certain that it will be an acceptable memorandum. To them it was often matter of regret, that a person of his eminent talents, which would have made him shine equally in any line of life, should have allowed himself to be so completely devoted to a study which abstracted him from the ordinary pursuits of men, unfitted him for the active enjoyment of life, and kept him out of those walks which they frequented, and where they would have required to meet him.

Dr Simson was of an advantageous stature, with a fine countenance; and even in his old age had a graceful carriage and manner, and always, except when in mourning, dressed in white cloth. He was of a cheerful disposition; and though he did not make the first advances to acquaintance, had the most affable manner, and strangers were at perfect ease in his company. He enjoyed a long course of uninterrupted health; but towards the close of life suffered from an acute disease, and was obliged to employ an assistant in his professional labours for a few years preceding his death, which happened in 1768, at the age of 81. He left to the university his valuable library, which is now arranged apart from the rest of the books, and the public use of it is limited by particular rules. It is considered as the most choice collection of mathematical books and manuscripts in the Kingdom, and many of them are rendered doubly valuable by Dr Simson's notes.

SIN, a breach or transgression of some divine law or command.

SINAI, or SINA, a famous mountain of Arabia Petraea, upon which God gave the law to Moses. It stands in a kind of peninsula, formed by the two arms of the Red sea, one of which stretches out towards the north, and is called the *gulf of Koffan*; the other extends towards the east, and is called the *gulf of Elan*, or the *Elanish sea*. At this day the Arabians call Mount Sinai by the name of *Tor*; that is, the "mountain," by way of excellence; or *Gabal or Jibal Moysa*, "the mountain of Moses." It is 262 miles from Cairo, and generally it requires a journey of ten days to travel thither. The wilderness of Sinai, where the Israelites continued encamped for almost a year, and where Moses erected the tabernacle of the covenant, is considerably elevated above the rest of the country; and the ascent to it is by a very easy way, the greatest part of which is out of the rock; then one comes to a large piece of ground, which is a plain surrounded on all sides by rocks and eminences, whose height is nearly 12 miles. Towards the extremity of this plain, on the north side, two high mountains show themselves, the highest of which is called *Sinai* and the other *Horeb*. The tops of Horeb and Sinai have a very steep ascent, and do not stand upon high ground, in comparison to their extraordinary height; that of Sinai is at least one-third part higher than the other, and its ascent is more upright and difficult.

Two German miles and a half up the mountain stands the convent of St Catharine. The body of this monastery is a building 120 feet in length and almost as many in breadth. Before it stands another small building, in which is the only gate of the convent, which remains always shut, except when the Bishop is here.

Sini
||
Sini.

here. At other times, whatever is accumulated within the cavern, whether men or provisions, is drawn up by the crozier as a float, and with a lead and a pulley. The whole building is not above twenty feet high, and a defect, must arise from a porous and porous mass. Near the chapel there is a fountain of very good fresh water; it is to be had, as we might say by the way, also, on the consecutive how water can flow from the bottom of a well and have a fountain. For six paces from the well flow a done, the height of which is above the level of breadths out three, which they call the water, none where the water is called the water to be found. The fountain is of a spotted grey, and it is as if it were in a kind of earth, where no other rock appears. There are his 12 holes or channels, which are about a fath wide, whence it is thought the water came forth for the benefit to drink.

Much has been said of the windings to be met at Sini and in the plain about it; and had were the bones of different species the various animals of the forest as from these windings, that Dr Clayton, Bishop of Clougher, offered great desiring to derive the existence of journey to any man of letters who would undertake to copy them. No man, we believe, undertook this task; and the accurate Danish traveller Niebuhr found no windings there, but the names of persons who had visited the place from curiosity, and of Egyptians who had chosen to be buried in that region.

SINAPIS, *Mossambic*, a genus of plants belonging to the class *triacanthata*, and to the order *leguminosae*; and in the natural system ranged under the 39th order, *Sisymbrium*. See *BORASSA Indica*.

SINAPISM, in *Pharmacology*, an external medicine, in form of a cataplast, composed chiefly of mustard-seed pulverized, and other ingredients mentioned in the preceding article.

SINCERITY, honesty of intention, freedom from hypocrisy. See *MORAL PHILOSOPHY*, N^o 137.

SINCIPUT, in *Anatomy*, the forepart of the head, reaching from the forehead to the coronal suture.

SINDY, a province of Hinduan Proper, bounded on the west by Makran, a province of Persia; on the north by the territories of the King of Candahar; on the north-east by those of the Sikhs; on the east by a sandy desert; and on the south-east by Cathay. It extends along the course of the river Sindh or Indus from its mouth to Belcher or Bhakar, on the frontiers of Malabar. Reckoned that way, it is 520 miles long; and its breadth, in its widest part, is about 160. In many particulars of soil and climate, and in the general appearance of the surface, Sindy resembles Egypt; the lower part of it being composed of rich vegetable mould, and extended into a wide dell; while the upper part of it is a narrow strip of country, confined on one side by a ridge of mountains, and on the other by a sandy desert, the river Indus, equal at least to the Nile, winding through the midst of this level valley, and annually overflowing it. During great part of the fourth-west monsoon, or at least in the months of July, August, and part of September, which is the rainy season in most other parts of India, the atmosphere is here generally clouded; but no rain falls, except very near the sea. Indeed, very few showers fall during the whole year; owing to which, and the neighbourhood of the sandy deserts, which bound it on the east and on the north-

west, the heats are so violent, and the winds from those quarters so pernicious, that the houses are confined for us to be occasionally ventilated by means of apertures on the tops of them, resembling the funnel of a mill chimney. When the hot winds prevail, the windows are closely shut; and the lower part of the current of air, which is always the lower, being thus excluded, a cooler breeze, more elevated, part descending into the lower, through the funnel. By this contrivance also, winds of dust are excluded; the entrance of which would be sufficient to render the land uninhabitable. The roofs are composed of thick layers of earth instead of terraces. The countries are very unproductive to European cultivators, particularly the lower part of the Delta. The palace of this province is a Hinduan, tributary to the King of Candahar. The chief of this land, although Tatta is the capital. The Hindoos, who were the original inhabitants of this country, their Mahrattan governors treated with great rigour, and dejected the public exercise of their religion; and this severity drove vast numbers of them into other countries. The inland parts of Sindy produce all sorts of muscovado, brown sugar, black sugar, and raw silk. They have also various kinds of cotton and silk of various kinds; and they make fine cabinets, inlaid with ivory, and finely decorated. They also export great quantities of butter, clarified and wrapped up in daggas, made of the hides of cattle. The Indians wear hoops of ivory on both their arms and legs, which when they die are burnt with them. They have large black cattle, excellent mutton, and small hardy horses. Their wild game are deer, hares, antelopes, and foxes, which they hunt with dogs, leopards, and a small fierce creature called a Bhahguli.

SINE, or *Right SINE* of an Arch, in *Trigonometry*, is a right line drawn from one end of that arch, perpendicular to the radius drawn to the other end of the arch; being always equal to half the cord of twice the arc. See *TRIGONOMETRY* and *GEOMETRY*.

SINECURE, a nominal office, which has a revenue without any employment.

SINEW, a tendon, that which unites the muscles to the bones.

SINGING, the action of making divers inflections of the voice, agreeable to the ear, and correspondent to the notes of a song or piece of melody. See *MUSIC* and *LOVE*.

The first thing to be done in learning to sing, is to raise a scale of notes by ten and a half notes in an octave, and descend by the same notes; and then to ride and fall by greater intervals, as a third, fourth, fifth, &c. and to do all this by notes of different pitch. Then on these notes are represented by lines and spaces, in which the syllables *fa, sol, la, mi*, are applied, and the pupil taught to name each line and space thereby; whence this practice is called *sol-fa-ing*, the nature, reason, effects, &c. whereof, see in the article *SOLFING*.

SINGING of Birds. It is worthy of a cavitation, that the female of no species of birds ever sings; still it is the reverse of what occurs in human kind. Among the fourth red tribe, and the crows of the red tribe, it is the male sex that is the follower of a comb; and the principal share in making the help of birds, is to alleviate these fugitives, and to support her under the same name hath given to the male the song, with all the

Sindy
||
Singing.

Singing
if
Sinking.

little blandishments and soothing arts; these he fondly exerts (even after courtship) on some spry contiguous to the nest, during the time his mate is performing her parental duties. But that he should be silent is also another wise provision of nature, for her song would discover her nest; as would a gaudiness of plumage, which, for the same reason, seems to have been denied her.

On the song of birds several curious experiments and observations have been made by the Hon. Daines Barrington. See *Phil. Trans.* vol. lxiii.

SINGULAR NUMBER, in *Grammar*, that number of nouns and verbs which stands opposed to plural. See *GRAMMAR*, N^o 14.

SINISTER, something on or towards the left hand. Hence some derive the word *sinister à sinendo*; because the gods, by such auguries, permit us to proceed in our designs.

SINISTER, is ordinarily used among us for unlucky; though, in the sacred rites of divination, the Romans used it in an opposite sense. Thus *avis sinistra*, or a bird on the left hand, was esteemed a happy omen: whence, in the law of the 12 tables, *Ave sinistra populi magister esto*.

SINISTER, in *Heraldry*. The sinister side of an escutcheon is the left-hand side; the sinister chief, the left angle of the chief; the sinister base, the left-hand part of the base.

SINISTER Aspect, among astrologers, is an appearance of two planets happening according to the succession of the signs; as Saturn in Aries, and Mars in the same degree of Gemini.

SINISTRI, a set of ancient heretics, thus called because they held the left hand in abhorrence, and made it a point of religion not to receive any thing therewith.

SINKING FUND, a provision made by parliament, consisting of the surplage of other funds, intended to be appropriated to the payment of the national debt; on the credit of which very large sums have been borrowed for public uses.

As the funding system had been adopted in other countries long before it was resorted to in Great Britain, a provision of this kind had appeared necessary at a much earlier period, and had been established in Holland in 1655, and in the ecclesiastical states in 1685. These funds were both formed by the reduction of the interest on the public debts, and by appropriating the annual sum thus saved to the gradual discharge of the principal.

In the reign of King William, when the mode of providing for extraordinary expences was first adopted in this country, the particular tax on which money was borrowed, generally produced much more than was sufficient to pay the annual interest, and the surplus was applied in sinking the principal, which was generally effected in a few years. Had this plan been pursued, there never could have been any great accumulation of public debts; but, as the expenditure increased, and the necessity of loans of still greater amount became more frequent, it was found difficult to provide for the annual interest of the sums thus borrowed; and the repayment of the principal was either put off to a distant period, or left without any provision to the chance of more flourishing times.

Sinking.

Some of the effects of an accumulating public debt soon became evident in the discount at which all government securities sold, and in the difficulties experienced in providing for the annual expenditure; the propriety of reducing, and even of wholly discharging, the debt, was generally acknowledged; and the plan of a sinking fund was recommended in a pamphlet published in 1701. In 1713 Mr Archibald Hutcheon presented to George I. a plan for payment of the public debts. In 1715 different projects for this purpose were published by Edward Leigh, Mr Algill, and others. And in 1717 a plan for the gradual discharge of the debt was actually adopted, which was afterwards generally known by the name of the sinking fund.

For a few years the fund was strictly applied to the purposes for which it was established; and so well were its nature and importance then understood, that money was at the same time borrowed for extraordinary expences. In 1724, the sum of 15,144,195. was taken from the fund, to make good the loss to the treasury from the reduction of the value of gold coin; and within 12 years from its establishment it was charged with the interest of new loans. In 1733, the gross sum of half a million was taken from it towards the supplies, at which time the medium annual produce of the fund for five years had been 1,212,000*l*. This amount would have fully discharged the debt which then existed, but the alienation of it was continued.

This was succeeded by the consolidated fund, one object of which was, to lay the foundation of a new sinking fund, and consisting, like the old one, in the application of the principle of compound interest. On this occasion Mr Pitt consulted the late Dr Price, who communicated three plans, one of which was afterwards adopted, but with such alterations as greatly affected its efficacy, and which it has been since found necessary to correct. By the act passed for carrying this scheme into execution, the annual sum of 1,000,000*l*. was placed in the hands of commissioners, to be issued in four equal quarterly payments, and to be applied either in paying off such redeemable annuities as were at or above par, or in the purchase of annuities below par, at the market-price.

On the 17th of February, 1792, Mr Pitt proposed that the sum of 400,000*l*. should be issued in addition to the million, for the purpose of accelerating the operation of the fund: and stated that it might be expected that 25 millions of 3 per cents would be paid off by the year 1800; and that in the year 1808, the fund would amount to 4,000,000*l*. per annum, the sum to which it was then restricted. The injudicious restriction of the fund to 4,000,000*l*. per annum, was done away by an act passed in 1802, which directed that the produce of the two funds should continue to accumulate, without any limitation as to its amount, and be from time to time applied, according to the former provisions, in the redemption or purchase of stock, until the whole of the perpetual redeemable annuities, existing at the time of passing the act, shall have been completely paid off. At the same time, the annual grant of 200,000*l*. in aid of the fund, was made a permanent charge, to be issued in quarterly payments from the consolidated fund, in the same manner as the original million per annum. In consequence of these improvements, the increase of the fund has been much greater than it was originally

Sinking
II
Sinus

originally estimated; and on the 1st of February, 1806, was as follows:

Annual charge by act of 26 Geo. III.			
Ditto 42 Geo. III.	L. 1,000,000	0	0
Annuities for 99 and 96 years, expired 1792	54,880	14	6
Short annuities, expired 1787	25,000	0	0
Life annuities, unclaimed and expired	50,358	5	7
Dividend on 98,386,402l. at 3 per cent.	2,951,592	1	2
Ditto on 2,617,402l. at 4 per cent.	104,695	0	0
Ditto on 142,000l. at 5 per cent.	7,100	0	0
One per cent. on capitals erected since 1723	3,222,672	1	10
Total,	L. 7,596,249	3	1

This sum is exclusive of the fund for the reduction of the public debt of Ireland, which at the above period amounted to 479,537l. 8s. and of the fund for reduction of the imperial debt, which amounted to 56,902l. 9s. 4d.

The progress of the fund from the commencement of its operation on 1st August 1786, to the 1st February 1806, will appear from the following statement of the total amount of the stock redeemed by the commissioners up to the latter period.

Consolidated 3 per cent. annuities	L. 39,922,421
Reduced 3 per cent. annuities	51,493,981
Old South sea annuities	3,492,500
New South sea annuities	2,783,500
Three per cents 1751	695,000
Consolidated 4 per cent. annuities	2,617,400
Navy 5 per cent. annuities	142,000
Total,	L. 101,145,802

The total sum which had been paid for this amount of stock was, 62,842,782l. 7s. 10d. the consolidated 3 per cents having been bought up on an average at 61. per cent. and the reduced at somewhat less.

The progress already made by the fund, and the important effect it has had in supporting the value of the government securities at a time when it has been necessary to borrow unprecedented sums in almost every year, sufficiently demonstrate the great utility of this measure. As its increase will be continually augmenting, it will, if steadily persevered in, and faithfully applied, become ultimately capable of discharging a debt of any amount with which it is possible to suppose the country will ever be encumbered.

SINOPLIE, in *Herakley*, denotes vert, or green colour in armies.—Sinopie is used to signify love, youth, beauty, rejoicing, and liberty; whence it is that letters of grace, ambition, legitimation, &c. are always sealed with green wax.

SINUOSITY, a series of bends and turns in arches or other irregular figures, sometimes jutting out and sometimes falling in.

SINUS, in *Anatomy*, denotes a cavity in certain bones

and other parts, the entrance whereof is very narrow, and the bottom wider and more spacious.

SINUS, in *Surgery*, a little cavity or faculus, frequently formed by a wound or ulcer, wherein pus is collected.

SIPHON. See **HYDRODYNAMICS**.

SIPHONANTHUS, a genus of plants belonging to the class of tetrandria and order of monogynia. See **BOTANY Index**.

SIPONTIUM, **SEPONTUM**, or **SIPUS**, in *Ancient Geography*, a town of Apulia, so denominated (according to Strabo) from the great quantity of *sepice* or cuttlefish that are thrown upon the coast. *Donedè* is supposed by the same author to have been the founder of this place; which appears from *Livy* to have become a colony of Roman citizens. In the early ages of Christian hierarchy, a bishop was fixed in this church; but, under the Lombards, his see was united to that of Beneventum. Being again separated, Sipontium became an archiepiscopal diocese in 1294, about which time it was so ill treated by the Barberians, that it never recovered its splendour, but sunk into such misery, that in 1265 it was a mere desert, from the want of inhabitants, the decay of commerce, and the indolence of the air. Manfred having taken these circumstances into consideration, began in 1261 to build a new city on the sea-shore, to which he removed the few remaining Sipontines. (See the article **MANFREDONIA**.) Sipontium was situated at the distance of a mile from the shore. Excepting a part of its Gothic cathedral, scarce one stone of the ancient city now remains upon another.

SIPUNCULUS, in *Natural History*, a genus of the class of vermes, and order intellina. See **HELMINTHOLOGY Index**.

SIR, the title of a knight or baronet, which, for distinction's sake, as it is now given indiscriminately to all men, is always prefixed to the knight's Christian name, either in speaking or writing to them.

SIRCAR, any office under the government in Hindostan. It is sometimes used for the state of government itself. Likewise a province, or any number of pergunnahs placed under one head in the government books, for conveniency in keeping accounts. In common usage in Bengal, the under banyans of European gentlemen are called *sircars*.

SIRE, a title of honour formerly given to the king of France as a mark of sovereignty.

SIRE, was likewise anciently used in the same sense with *seur* and *signeur*, and applied to barons, gentlemen, and citizens.

SIRENS, in fabulous history, certain celebrated songstress who were ranked among the demigods of antiquity. *Hyginus* places their birth among the consequences of the rape of Proserpine. Others make them daughters of the river Acheloides and one of the muses. The number of the Sirens was three, and their name were *Parthenope*, *Lygia*, and *Leucopha*. Some make them half women and half fish; others, half women and half birds. There are antique representations of them still subsisting under both these forms. *Pausanias* tells us, that the Sirens, by the refusal of Juno, challenged the Muses to a trial of skill in singing 3; and these having vanquished them, plucked the golden feathers from the wings of the Sirens, and forced them into

Siphon
II
Sinus

crowns, with which they adorned their own heads. The Argonauts are said to have been diverted from the enchantment of their songs by the superior strains of Orpheus: Ulysses, however, had great difficulty in securing himself from seduction. See *Odys.* lib. xii.

Pope, in his notes to the twelfth book of the *Odyssey*, observes, the critics have greatly laboured to explain what was the foundation of this fiction of the Sirens. We are told by some, that the Sirens were queens of certain small islands named *Sirenice*, that lie near Caprea in Italy, and chiefly inhabited the promontory of Minerva, upon the top of which that goddess had a temple, as some affirm, built by Ulysses. Here there was a renowned academy, in the reign of the Sirens, famous for eloquence and the liberal sciences, which gave occasion to the invention of this fable of the sweetness of the voice and attracting songs of the Sirens. But why then are they fabled to be destroyers, and painted in such dreadful colours? We are told, that at last the students abused their knowledge, to the colouring of wrong, the corruption of manners, and the subversion of government: that is, in the language of poetry, they were seized to be transformed into monsters, and with their music to have enticed passengers to their ruin, who there consumed their patrimonies, and poisoned their virtues with riot and effeminacy. The place is now called *Maffia*. Some writers tell us of a certain bay, contracted within winding straits and broken cliffs, which, by the singing of the winds and beating of the waters, returns a delightful harmony, that allures the passenger to approach, who is immediately thrown against the rocks, and swallowed up the violent eddies. Thus Horace, moralising, calls idleness a *Siren*.

— *Vicenda est inpraesens Siren*
Dysilia.—

But the fable may be applied to all pleasures in general, which, if too eagerly pursued, betray the incursions into ruin; while wise men, like Ulysses, making use of their reason, stop their ears against their insinuations.

The learned Mr Bryant says, that the Sirens were Cuthic and Canaanitish priests, who had founded temples in Sicily, which were rendered famous on account of the women who officiated. They were much addicted to cruel rites, so that the shores upon which they resided are described as covered with the bones of men destroyed by their artifice. *Virg. Aeneid.* lib. v. ver. 864.

All ancient authors agree in telling us, that Sirens inhabited the coast of Sicily. The name, according to Bachart, who derives it from the Phœnician language, implies a songstress. Hence it is probable, says Dr Burney, that in ancient times there may have been excellent singers, but of corrupt morals, on the coast of Sicily, who, by seducing voyagers, gave rise to this fable. And if this conjecture be well founded, he observes, the Sirens are not the only pagan divinities who preserved their influence over mankind in modern times; for every age has its Sirens, and every Siren her votaries; when beauty and talents, both powerful in themselves, are united, they become still more attractive.

SIREN, in *Zoology*, a genus of animals belonging to the class of *amphibia* and the order of *meantes*. It is a biped, naked, and furnished with a tail; the feet are

brachiated with claws. This animal was discovered by Dr Garden in Carolina; it is found in swampy and muddy places, by the sides of pools, under the trunks of old trees that hang over the water. The natives call it by the name of *mud-inquana*. Linnaeus first apprehended, that it was the larva of a kind of lizard; but as its fingers are furnished with claws, and it makes a croaking noise, he concluded from these properties, as well as from the situation of the anus, that it could not be the larva of the lizard, and therefore formed of it a new genus under the name of *Siren*. He was also obliged to establish for this uncommon animal a new order called *meantes* or *gliders*; the animals of which are amphibious, breathing by means of gills and lungs, and furnished with arms and claws.

SIREX, a genus of insects belonging to the order of *hymenopterae*. See *ENTOMOLOGY Index*.

SIRIUM, a genus of plants belonging to the class of tetrandria and order of monogynia. See *BOTANY Index*.

SIRIUS, in *Astronomy*, a bright star in the constellation *Canis*. See *ASTRONOMY*, N^o 423, &c.

SIRLET, FLAVIUS, an eminent Roman engraver on precious stones: his Laocœon, and representations in miniature of antique statues at Rome, are very valuable and scarce. He died in 1737.

SIROCCO, a periodical wind which generally blows in Italy and Dalmania every year about Easter. It blows from the south-east by south: it is attended with heat, but not rain; its ordinary period is twenty days, and it usually ceases at sunset. When the sirocco does not blow in this manner, the summer is almost free from westerly winds, whirlwinds, and storms. This wind is prejudicial to plants, drying and burning up the buds; though it hurts not men any otherwise than by causing an extraordinary weakness and lassitude; inconveniences that are fully compensated by a plentiful sowing, and a good crop of corn on the mountains. In the summer time, when the westerly wind ceases for a day, it is a sign that the sirocco will blow the day following, which usually begins with a sort of whirlwind.

SISKIN. See *FRINGILLA*, *ORNITHOLOGY Index*.

SISCIN, BASTARD STONE PARSLEY, a genus of plants belonging to the class of pentandria, and to the order of digynia; and in the natural system arranged under the 45th order, *umbellatae*. See *BOTANY Index*.

SISTRUM, or CISTRUM, a kind of ancient musical instrument used by the priests of Isis and Osiris. It is described by Spon as of an oval form, in manner of a racket, with three sticks traversing it breadthwise; which playing freely by the agitation of the whole instrument, yielded a kind of sound which to them seemed melodious. Mr Malecm takes the sistrum to be no better than a kind of rattle. Oseius observes, that the sistrum is found represented on several medals, and on talismans.

SISYMBRIUM, WATER-CRESE, a genus of plants belonging to the class of *tetradynamia*, and to the order of *silicifera*; and in the natural system ranged under the 39th order, *Siliciferae*. See *BOTANY Index*.

SISYPHUS, in fabulous history, one of the descendants of Elys, married Merope, one of the Peïdes, who bore him Glaucon. He resided at Epyra in Peloponnesus, and was a very crafty man. Others say, that he was a Trojan secretary, who was punished for discover-

ing

Siwa
Siwa
Siwa

vering secrets of fate; and others again, that he was a notorious robber, killed by Thelus. However, all the poets agree that he was punished in Tartarus for his crimes, by rolling a great stone to the top of a hill, which constantly rolled, and, rolling down incessantly, renewed his labour.

SISYRINCHIUM, a genus of plants belonging to the class of *gynandria*, and order of *triandria*; and in the natural system ranged under the 5th order, *Epilætes*. See *Botany Indes*.

SITE, denotes the situation of an house, &c. and sometimes the ground-plot or spot of earth on which it stands.

SITTA, **NUTHATCH**, a genus of birds belonging to the order of *picæ*. See *Ornithology Indes*.

SITOPHYLAN, Σιτοφυλάξ, formed from σίτος "corn," and φυλάξ, "keeper," in antiquity, an Athenian magistrate, who had the superintendance of the corn, and was to take care that nobody bought more than was necessary for the provision of his family. By the Attic laws, particular persons were prohibited from buying more than fifty measures of wheat a man; and that such persons might not purchase more, the sitophylax was appointed to see the laws properly executed. It was a capital crime to violate in it. There were 15 of these *σιτοφυλάξαι*, ten for the city, and five for the Ports.

SITUS, in *Algebra* and *Geometry*, denote the situation of lines, surfaces, &c. **WORMS** delivers some things in geometry, which are not deduced from common analysis, particularly matters depending on the *flux* of lines and figures. Leibnitz has even founded a particular kind of analysis upon it, called *calculus fluxus*.

SIVA, a name given by the Hindoos to the Supreme Being, when considered as the avenger or destroyer. Sir William Jones has shown that in several respects the character of Jupiter and Siva are the same. As Jupiter overthrew the Titans and giants, so did Siva overthrow the Daityas, or children of Diti, who frequently rebelled against Heaven; and as during the contest the god of Olympus was furnished with lightning and thunderbolts by an eagle, so Brahma, who is sometimes represented riding on the Garuda, or eagle, presented the god of destruction with fiery shafts. Siva also corresponds with the Stygian Jove, or Pluto; for, if we can rely on a Persian translation of the Bâghavat, the fore-reign of Pitâra, or the infernal regions, is the kingdom of serpents, named *Sesbanaga*, who is exhibited in painting and sculpture, with a diadem and sceptre, in the same manner as Pluto. There is yet another attribute of Siva, or Mahâdeva, by which he is visibly distinguished in the drawings and temples of Bengal. To destroy, according to the Vedants of Ind, the Sâsis of Persia, and many philosophy of our European schools, is only to generate and reproduce in another form. Hence the god of destruction is hidden in this country to preserve over generation, as a symbol of which he rises on a white bull. Can we doubt that the horns and teats of Jupiter Genitor (not forgetting the white bull of Europe), and his extraordinary title of *Lupa*, for which no satisfactory reason is commonly given, have a connection with the Indian deity of destruction?

SIVUM, **WATER**, Πισίτιον, a genus of plants belonging to the class of *pentandria*, and order of *diosida*, and in the natural system ranged under the 4th order, *Umbellales*. See *Botany Indes*.

SIWA, or **SIWAN**, a town in Egypt to the westward of Alexandria, built on a small fertile spot, surrounded on all sides by desert land. A considerable portion of this tract is filled with date trees, but there are also plantains, pomegranates, figs, apricots, and olives; and the gardens are in a very flourishing condition. The people cultivate rice, which is of a reddish colour, and different from that of the delta. The soil of the land furnishes abundance of wheat for the consumption of the inhabitants.

The greatest curiosity about Siwa is a ruin of undoubted antiquity, measuring 32 feet in length, 18 in height, and 15 in breadth, which does not appear to have been much larger. Mr Horrieman estimates the dimensions of it at 26 feet long, 24 feet wide, and 27 high, which agrees with no other traveller whatever; and indeed Mr Horrieman himself allows that the jealousy of the natives prevented him from making any plan of accurate examination or admeasurement. The people of Siwa have no tradition respecting this edifice, nor attribute any quality to it, but that of concealing treasures, and as the haunt of demons. It has, however, been supposed, that Siwa is the *Sivæum* of Pliny, and that this building was coeval with the temple of Jupiter Ammon, and a dependency on it; yet neither the natives of Siwa, nor the various tribes of Arabs who frequent that place, knew any thing of the ruins of that temple, about which Mr Browne made every possible enquiry.

The complexion of the people of Siwa is generally darker than that of the Egyptians, and their dialect is also different. They do not habitually make use of snuff or tobacco. Their diet is that of Milk. The dress of the lower class is very simple, as they are almost naked; among those whose costume was discernible, it approaches nearer to that of the Arabs of the desert than the Egyptians or Moors. Their clothing consists of a shirt of white cotton, with large sleeves reaching to the feet, a red cap without a turban, and shoes of the same colour. Some carmen were made by themselves, and a few mats, form the chief part of their household furniture, more but the higher ranks being possessed of copper utensils. They sometimes purchase a few slaves from the Mourzouk caravan. The red of their warts are supplied from Cairo or Alexandria, whither their dates are transported, both in a dry state, and steeped into milk, which, when good, greatly resembles a live meat. They do not eat large quantities of animal food, and bread known to us is scarce in it. They drink plentifully of the liquor extracted from the date tree, which they call *Wassir* newar, though it has frequently the power of intoxicating in the dose in which they drink it. Their animals are the hairy mares and steers of Egypt, the ox, and a very small number of sheep and camels. The women wear veils as in Egypt. After the day, the ground in the vicinity of Siwa is covered with fat for many miles.

Some travellers have compared it with a King, which is very much to be desired, whether in regard to the general appearance of the country covered with date trees, or to that of the people crowded together in a confined space, or horns of a man in a narrow space, and direct, and which to each other in a narrow distance. Northward of the temple is a system of salt extending a great distance, and it is the tradition

Siwa
Siwa
Siwa

the surface. There are numerous springs, and frequently a spring of water perfectly fresh is found within a few paces of one that is salt. The people, according to Harleman, are obtrusive and thievish. Siwa is situated in 29° 12' N. Lat. and 49° 54' E. Long.

SIX-CLERKS, officers in chancery of great account, next in degree below the twelve masters, whose business it is to enrol commissions, pardons, patents, warrants, &c. which pass the great seal, and to transact and file all proceedings by bill, answer, &c. They were anciently clerici, and forfeited their places, if they married; but when the constitution of the court began to alter, a law was made to permit them to marry, Stat. 14. and 15. Hen. VIII. cap. 8. They are also solicitors for parties in suits depending in the court of chancery. Under them are six deputies and 60 clerks, who, with the under clerks, do the business of the office.

SIX NATIONS. See NIAGARA.

SIXTH, in *Music*, one of the simple original concords, or harmonical intervals. See INTERVAL.

SIXTUS V. POPE, was born the 13th December, 1521, in La Marca, a village in the feignory of Montalto. His father, Francis Peretti, was a gardener, and his mother a servant maid. He was their eldest child, and was called Felix. At the age of nine he was hired out to an inhabitant of the village to keep sheep; but disobliging his master, he was soon after degraded to be keeper of the hogs. He was engaged in this employment when Father Michael Angelo Salleri, a Franciscan friar, asked the road to Azzoli, where he was going to preach. Young Felix conducted him thither, and struck the father to much with his conversation and eagerness for knowledge, that he recommended him to the fraternity to which he had come. Accordingly he was received among them, invested with the habit of a lay brother, and placed under the sacristan, to assist in sweeping the church, lighting the candles, and other offices of that nature; for which he was to be taught the responses, and the rudiments of grammar. His progress in learning was so surprising, that at the age of 14 he was thought qualified to begin his novitiate, and was admitted the year following to make his profession.

He pursued his studies with such unwearied assiduity, that he was soon reckoned equal to the best disputants. He was ordained priest in 1545, when he assumed the name of Father Montalto; soon after he took his doctor's degree, and was appointed professor of theology at Sienna. It was then that he so effectually recommended himself to Cardinal de Carpi, and his secretary Binius, that they ever remained his steady friends. Meanwhile the severity and obtuseness of his temper incessantly engaged him in disputes with his monastic brethren. His reputation for eloquence, which was now spread over Italy, about this time gained him some new friends. Among these were the Colonna family, and Father Ghislieri, by whose recommendation he was appointed inquisitor-general at Venice: but he exercised that office with so much severity, that he was obliged to flee precipitately from that city. Upon this he went to Rome, where he was made procurator-general of his order, and soon after accompanied Cardinal Buon Compagnon into Spain, as a chaplain and confessor to the inquisition. There he

was treated with great respect, and liberal offers were made him to induce him to continue in Spain, which, however, he could not be prevailed on to accept.

In the mean time, news were brought to Madrid that Pius IV. was dead, and that Father Ghislieri, who had been made Cardinal Alexander by Paul IV. had succeeded him under the name of Pius V. These tidings filled Montalto with joy, and not without reason, for he was immediately invested by the pontiff with new dignities. He was made general of his order, bishop of St Agatha, was soon after raised to the dignity of cardinal, and received a pension. About this time he was employed by the pope to draw up the bill of excommunication against Queen Elizabeth.

He began now to cast his eyes upon the papacy; and, in order to obtain it, formed and executed a plan of hypocrisy with unparalleled constancy and success. He became humble, patient, and affable. He changed his dress, his air, his words, and his actions, to completely, that his most intimate friends declared him a new man. Never was there such an absolute victory gained over the passions; never was a seditious character so long maintained, nor the foibles of human nature so artfully concealed. He courted the ambassadors of every foreign power, but attached himself to the interests of none; nor did he accept a single favour that would have laid him under any peculiar obligation. He had formerly treated his relations with the greatest tenderness, but he now changed his behaviour altogether. When his brother Anthony came to visit him, he lodged him in an inn, and sent him home next day, charging him to inform his family that he was now dead to his relations and the world.

When Pius V. died in 1572, he entered the conclave with the other cardinals, but seemed altogether indifferent about the election, and never left his apartment except to his devotion. When solicited to join any party, he declined it, declaring that he was of no consequence, and that he would leave the choice of a pope entirely to persons of greater knowledge and experience. When Cardinal Buon Compagnon, who assumed the name of Gregory XIII. was elected, Montalto assured him that he never wished for any thing so much in his life, and that he would always remember his goodness, and the favours he had conferred on him in Spain. But the new pope treated him with the greatest contempt, and deprived him of his pension. The cardinals also, deceived by his artifices, paid him no greater respect, and used to call him, by way of ridicule, the Roman beast; the ass of La Marca.

He now assumed all the infirmities of old age; his head hung down upon his shoulders; he tottered as he walked, and supported himself on a staff. His voice became feeble, and was often interrupted by a cough so exceedingly severe, that it seemed every moment to threaten his dissolution. He interfered in no public transactions, but spent his whole time in acts of devotion and benevolence. Mean time he constantly employed the ablest spies, who brought him intelligence of every particular.

When Gregory XIII. died in 1585, he entered the conclave with the greatest reluctance, and immediately shut himself up in his chamber, and was no more thought of than if he had not existed. When he went

SIXUS to mass, for which purpose alone he left his apartment, he appeared perfectly indifferent about the event of the election. He joined no party, yet flattered all.

He knew early that there would be great divisions in the conclave, and he was aware that when the leaders of the different parties were disappointed in their own views, they all frequently agreed in the election of some old and infirm cardinal, the length of whose life would merely enable them to prepare themselves sufficiently for the next vacancy. These views directed his conduct, nor was he mistaken in his hopes of success.

Three cardinals, the leaders of opposite factions, being unable to procure the election which each of them wished, unanimously agreed to make choice of Montalto. When they came to acquaint him with their intention, he fell into such a violent fit of coughing that every person thought he would expire on the spot. He told them that his reign would last but a few days; that, besides a continual difficulty of breathing, he wanted strength to support such a weight, and that his small experience rendered him very unfit for so important a charge. He conjured them all three not to abandon him, but to take the whole weight of affairs upon their own shoulders; and declared that he would never accept the mitre upon any other terms: "If you are resolved," added he, "to make me pope, it will only be placing yourselves on the throne. For my part, I shall be satisfied with the bare title. Let the world call me pop, and I make you heartily welcome to the power and authority. The cardinals swallowed the bait, and exerted themselves so effectually that Montalto was elected. He now pulled off the mask which he had worn for 14 years. No sooner was his election secured, than he started from his seat, flung down his staff in the middle of the hall, and appeared almost a foot taller than he had done for several years.

When he was asked, according to custom, if he would accept of the papacy, he replied, "It is trifling to ask whether I will accept what I have already accepted.—

However, to satisfy any scruple that may arise, I tell you that I accept it with great pleasure, and would accept another if I could get it; for I find myself able, by the Divine assistance, to manage two papacies." His former complaisance and humility disappeared, together with his infirmities, and he now treated all around him with reserve and haughtiness. The first care of Sixtus V. the name which Montalto assumed, was to correct the abuses, and put a stop to the enormities, which were daily committed in every part of the ecclesiastical state. The lenity of Gregory's government had introduced a general licentiousness of manners, which burst forth with great violence, after that pontiff's death. It had been usual with former popes to release delinquents on the day of their coronation, who were therefore accustomed to surrender themselves voluntary prisoners immediately after the election of the pope. At present, however, they were fatally disappointed.—When the governor of Rome and the keeper of St Angelo waited on his Holiness, to know his intention in this particular, he replied, "What have you to do with pardons, and releasing of prisoners? Is it not sufficient that our predecessor has suffered the judges to remain unemployed these 13 years? Shall we also stain our pontificate with the same neglect of justice? We have too long seen, with inexpressible concern, the prodigious

degree of wickedness that reigns in the state, to think of granting pardons. Let the prisoners be brought to a speedy trial, and punished as they deserve, to show the world that Divine Providence has called us to the chair of St. Peter, to reward the good, and chastise the wicked: that we bear not the sword in vain, but are the ministers of God, and a revenger to execute wrath on them that do evil."

He appointed commissioners to inspect the conduct of the judges, displaced those who were inclined to lenity, and put others of severe dispositions in their room. He offered rewards to any person who could convict them of corruption or partiality. He ordered the syndics of all the towns and signories to make out a complete list of the disorderly persons within their districts, and threatened the strapado for the smallest omission. In consequence of this edict, the syndic of Albino was scourged in the market place, because he had left his nephew, an incorrigible libertine, out of his list.

He made very severe laws against robbers and assassins. Adulterers, when discovered, suffered death; and they who willingly submitted to the prostitution of their wives, a custom then common in Rome, received the same punishment. He was particularly careful of the purity of the female sex, and never forgave those who attempted to dishonour them.

His execution of justice was as prompt as his edicts were rigorous. A Swiss happening to give a Spanish gentleman a blow with his halberd, was struck by him furiously with a pilgrim's staff that he expired on the spot. Sixtus informed the governor of Rome that he was to dine early, and that justice must be executed on the criminal before he sat down to table. The Spanish ambassador and four cardinals treated him not to disgrace the gentleman by suffering him to die on a gibbet, but to order him to be beheaded. "He shall be hanged (replied Sixtus), but I will alleviate his disgrace by doing him the honour to visit personally at his death." He ordered a gibbet to be erected before his own windows, where he continued sitting during the whole execution. He then called to his servants to bring in dinner, declaring that the act of justice which he had just seen had increased his appetite. When he rose from table, he exclaimed, "God be praised for the good appetite with which I have dined!"

When Sixtus ascended the throne, the whole ecclesiastical state was infested with bands of robbers, who from their numbers and outrages, were exceedingly formidable; by his prudent and vigorous conduct, however, he in a short time extirpated the whole of these banditti.

Nor was the vigour of his conduct less conspicuous in his transactions with foreign nations. Before he had been pope two months he quarrelled with Philip II. of Spain, Henry III. of France, and Henry king of Navarre. His intrigues indeed in some measure influenced all the councils of Europe.

After his accession to the pontificate he sent for his family to Rome, with express orders that they should appear in a decent and modest manner. Accordingly, his sister Camilla came thither, accompanied by her daughter and two grandchildren. Some cardinals, in order to pay court to the pope, went out to meet her, and introduced her in a very magnificent dress. Sixtus pretended not to know her, and asked two or three

times who she was : Upon this one of the cardinals said, " It is your filer, holy father." " I have but one filer (replied Sixtus with a frown), and she is a poor woman at Le Grotte; if you have introduced her in this disguise, I declare I do not know her; yet I think I would know her again, if I saw her in the clothes she used to wear."

Her conductors at last found it necessary to carry her to an inn, and strip her of her livery. When Camilla was introduced a second time, Sixtus embraced her tenderly, and said, " Now we know indeed that it is our filer: nobody shall make a princess of you but ourselves." He stipulated with his filer, that she should neither ask any favour in matters of government, nor intercede for criminals, nor interfere in the administration of justice; declaring that every request of that kind would meet with a certain refusal. These terms being agreed to, and punctually observed, he made the most ample provision not only for Camilla but for his whole relations.

This great man was also an encourager of learning. He caused an Italian translation of the Bible to be published, which raised a good deal of discontent among the Catholics. When some cardinals reproached him for his conduct in this respect, he replied, " It was published for the benefit of you cardinals who cannot read Latin."

Sixtus died in 1592, after having reigned little more than five years. His death was ascribed to poison, said to have been administered by the Spaniards; but the story seems rather improbable.

It was to the indulgence of a disposition naturally formed for severity, that all the defects of this wonderful man are to be ascribed. Clemency was a stranger to his bosom; his punishments were often too cruel, and seemed sometimes to border on revenge. Pasquin was dressed one morning in a very nasty shirt, and being asked by Matorio why he wore such dirty linen? replied, that he could get no other, for the pope had made his washerwoman a princess, alluding to Camilla, who had formerly been a laundress. The pope ordered strict search to be made for the author of this lampoon, and offered him his life and a thousand piloles if he would discover himself. The author was simple enough to make his appearance and claim the reward. " It is true (said the pope) we made such a promise, and we shall keep it: your life shall be spared, and you shall receive the money presently; but we have reserved to ourselves the power of cutting off your hands and boring your tongue through, to prevent your being so witty for the future." It is needless to add, that the sentence was immediately executed. This, however, is the only instance of his resenting the many severe satires that were published against him.

But though the conduct of Sixtus seldom excites love, it generally commands our esteem, and sometimes our admiration. He bravely defended the cause of the poor, the widow, and the orphan; he never refused audience to the injured, however wretched or forlorn their appearance was. He never forgave those magistrates who were capable of partiality or corruption; nor suffered crimes to pass unpunished, whether committed by the rich or the poor. He was frugal, temperate, sober, and never neglected to reward the smallest

favour which had been conferred on him before his exaltation.

When he mounted the throne, the treasury was not only exhausted, but in debt: at his death it contained five millions of gold.

Rome was indebted to him for several of her greatest embellishments, particularly the Vatican library: it was by him, too, that trade was first introduced into the Ecclesiastical State.

STY-A-GHUST, the caracol of Buffon, an animal of the cat kind. See FELIS, MAMMALIA Index.

SIZAR, or SIZER, in Latin *Sizarus*, an appellation by which the lowest order of students in the universities of Cambridge and Dublin are distinguished, is derived from the word *size*, which in Cambridge, and probably in Dublin likewise, has a peculiar meaning. To *size*, in the language of the university, is to get any sort of victuals from the kitchens, which the students may want in their own rooms, or in addition to their commons in the hall, and for which they pay the cooks or butchers at the end of each quarter. A *size* of any thing is the smallest quantity of that thing which can be thus bought: two *sizes*, or a part of beef, being nearly equal to what a young person will eat of that dish to his dinner; and a *size* of ale or beer being equal to half an English pint.

The *sizars* are divided into two classes, viz. *subfizatores* or *sizars*, and *fizatores* or proper *sizars*. The former of these are supplied with commons from the table of the fellows and fellow commoners; and in former times, when there were more fealty than they are now, they were obliged to supply the deficiency by *sizing*, as is sometimes the case still. The proper *sizars* had formerly no commons at all, and were therefore obliged to *size* the whole. In St John's college they have now some commons allowed them for dinner, from a benefaction, but they are still obliged to *size* their suppers: in the other colleges they are allowed a part of the fellow-commons, but must *size* the rest; and from being thus obliged to *size* the whole or part of their victuals, the whole order derived the name of *sizars*.

In Oxford, the order similar to that of *sizar* is denominated *servitor*, a name evidently derived from the menial duties which they perform. In both universities these orders were formerly distinguished by round caps and gowns of different materials from those of the pensioners or commoners, the order immediately above them. But about 30 years ago the round cap was entirely abolished in both seminaries. There is still, however, in Oxford, we believe, a distinction in the gowns, and there is also a trifling difference in some of the small colleges in Cambridge; but in the largest colleges the dress of the pensioners and *sizars* is entirely the same.

In Oxford, the *servitors* are still obliged to wait at table on the fellows and gentlemen-commoners; but much to the credit of the university of Cambridge; this most degrading and disgraceful custom was entirely abolished about 10 or 12 years ago, and of course the *sizars* of Cambridge are now on a much more respectable footing than the *servitors* of Oxford.

The *sizars* are not upon the foundation, and therefore while they continue *sizars* are not capable of being elected

Size,
Size.

ected fellows; but they may at any time, if they choose, become professors; and they generally fit for scholarships immediately before they take their final degree. If successful, they are then on the foundation, and are entitled to become candidates for fellowships when they have got that degree. In the mean time, while they continue sizars, besides free commons they enjoy many benefactions, which have been made at different times, under the name of *Keble's pension, cathedral-stipend, &c.* and the rate of tuition, the rent of rooms, and other things of that sort within their respective colleges, is less than to the other orders. But though their education is thus obtained at a less expence, they are not now considered as a menial order; for sizars, pensioner-scholars, and even sometimes fellow-commoners, mix together with the utmost cordiality. It is worthy of remark, that at every period this order has supplied the university with its most distinguished officers; and that many of the most illustrious members of the church, many of the most distinguished men in the other liberal professions, have, when undergraduates, been sizars, when that order was on a less respectable footing than it is now.

SIZE, the name of an instrument used for finding the bigness of fine round pearls. It consists of thin pieces or leaves, about two inches long, and half an inch broad, fastened together at one end by a rivet. In each of these are round holes drilled of different diameters. Those in the first leaf serve for measuring pearls from half a grain to seven grains; those of the second, for pearls from eight grains or two carats to five carat; &c.; and those of the third, for pearls from six carats and a half to eight carats and a half.

SIZE, is also a sort of paint, varnish, or glue, used by painters, &c.

The threads and parings of leather, parchment, or vellum, being boiled in water and strained, make *size*. This substance is much used in many trades.—The manner of using *size* is to melt some of it over a gentle fire; and serping as much whiting into it as will just colour it, let them be well incorporated together; after which you may whiten frames, &c. with it. After it dries, melt the *size* again, and put more whiting, and whiten the frames, &c. seven or eight times, leaving it dry between each time; but before it is quite dry, wet each with some walking with *size*, you must find it and wet it over with a clean brush-pencil in fair water.

To make *gold-size*. Take gum-arabic and isinglass, of each one ounce; mastic, litharge of gold, and amber, of each half an ounce; reduce all into a very fine powder, and add to them four ounces of linseed oil, and eight ounces of drying oil; digest them over a gentle fire that does not flame, so that the mixture may only simmer, but not boil; let it should run over and let the bulk on fire, stir it continually with a stick till all the ingredients are dissolved and incorporated, and do not leave off stirring till it comes black and smoky after being sufficiently boiled, then add a little more of oil, and then stir it through a coarse strainer, and keep it for use.—This is a receipt for a *size*, but what quantity you please is sufficient to do the business, as much oil of turpentine will do the business, and as little oil as turpentine will do the business, and as little oil as turpentine will do the business, and as little oil as turpentine will do the business; add to this as much vermilion as will make

it of a darkish red. If it is too thick for dipping, you may mix it with some oil of turpentine. The chief use of this *size* is for laying on metals.

Size,
Size.

The best *gold-size* for burnishing is made as follows: Take fine lute, what quantity you please; grind it finely on a piece of marble, then scrape into it a little beef tallow; grind all well together; after which mix in a small proportion of pearl-must-size with a double proportion of water, and it is done.

To make *silver-size*. Take tobacco-pipe clay in fine powder, into which scrape some black-lead and a little Gema soap, and grind them all together with pearl-must-size as already directed.

SKATING, an exercise on ice, both graceful and healthy. Although the ancients were remarkable for their dexterity in most of the athletic sports, yet skating seems to have been unknown to them. It may therefore be considered as a modern invention; and probably derived its origin in Holland, where it was practised, not only as a graceful and elegant amusement, but as an expeditious mode of travelling when the lakes and canals were frozen up during winter. In Holland long journeys are made upon the ice with ease and expedition; but in general less attention is there paid to graceful and elegant movements, than to the expedition and celerity of what is called *skating*. It is especially in those countries where it is considered as an amusement, that its graceful and noble movements can be studied; and there is no exercise whatever better calculated to set off the human figure to advantage. The acquirement of it, if exercised as an advanced point of life; but to become an expert skater, it is necessary to be in the practice of the art at a very early age. It is difficult to require the art of skating to a perfection. It is principally by the imitation of a good skater that a young practitioner can form his own practice. The English, though often remarkable for feats of agility upon skates, are very deficient in gracefulness, which is partly owing to the construction of the skates. They are too much curved in the forepart which embraces the ice, consequently they involuntarily bring the heels of them on and on the outside upon a quick and small circle, whereas the skater, by using skates of a different construction, is so curved, has the command of his heels, and can enlarge or diminish the circle according to his pleasure, will and desire. The metropolitan of Scotland has produced more instances of elegant skaters than perhaps any other country whatever; and the institution of a skating club about 52 years ago, has contributed not a little to the improvement of this elegant amusement. We are indebted for this article to a gentleman of that club, who has made the practice and improvement of skating his particular study; and as the nature of our work will not permit the insertion of a full treatise on skating, we shall present our readers with a few instructions.

Those who wish to be proficient should begin at an early period of life, and should first endeavour to throw out the feet which always attends the commencement of an unacquainted hazardous amusement. They will soon acquire the art of making on the heels, when they have done this, they must endeavour to acquire the manner of moving on the outside of the heels, which will give more than throwing, the skater will be the better of the skates, and making the nature of them be so that

Skating.
Skeleton.

towards that side, which will necessarily enable them to form a semicircle. In this, much assistance may be derived from placing a bag of lead-shot in the pocket next to the foot employed in making the outside stroke, which will produce an artificial poise of the body, which afterwards will become natural by practice. At the commencement of the outside stroke, the knee of the employed limb should be a little bended, and gradually brought to a reclined position when the stroke is completed. When the practitioner becomes expert in forming the semicircle with both feet, he is then to join them together, and proceed progressively and alternately with both feet, which will carry him forward with a graceful movement. Care should be taken to use very little muscular exertion, for the impelling motion should proceed from the mechanical impulse of the body thrown into such a position as to regulate the stroke. At taking the outside stroke, the body ought to be thrown forward easily, the unemployed limb kept in a direct line with the body, and the face and eyes directly looking forward: the unemployed foot ought to be stretched towards the ice, with the toes in a direct line with the leg. In the time of making the curve, the body must be gradually, and almost imperceptibly, raised, and the unemployed limb brought in the same manner forward; so that, at finishing the curve, the body will bend a small degree backward, and the unemployed foot will be about two inches before the other, ready to embrace the ice and form a correspondent curve. The muscular movement of the whole body must correspond with the movement of the skate, and should be regulated so as to be almost imperceptible to the spectators. Particular attention should be paid in carrying round the head and eyes with a regular and imperceptible motion; for nothing so much diminishes the grace and elegance of skating as sudden jerks and exertions, which are too frequently used by the generality of skaters. The management of the arms likewise deserves attention. There is no mode of disposing of them more gracefully in skating outside, than folding the hands into each other, or using a muff.

There are various feats of activity and manoeuvres used upon skates; but they are so various that we cannot pretend to detail them. Moving on the outside is the primary object for a skater to attain; and when he becomes an adept in that, he will easily acquire a facility in executing other branches of the art. There are few exercises but will afford him hints of elegant and graceful attitudes. For example, nothing can be more beautiful than the attitude of drawing the bow and arrow whilst the skater is making a large circle on the outside: the manual exercise and military salutes have likewise a pretty effect when used by an expert skater.

SKELETON, in *Anatomy*, the dried bones of any animal joined together by wires, or by the natural ligament dried, in such a manner as to show their position when the creature was alive.

We have, in the *Philosophical Transactions*, an account of a human skeleton, all the bones of which were so united, as to make but one articulation from the back to the os sacrum, and downwards a little way. On sawing some of them, where they were unnaturally joined, they were found not to cohere throughout their whole substance, but only about a sixth of an inch deep all

round. The figure of the trunk was crooked, the spine making the convex, and the inflex of the vertebrae the concave part of the segment. The whole had been found in a charnel-house, and was of the size of a full grown person.

SKIDS, or **SKEEDS**, in sea-language, are long compassing pieces of timber, notched below so as to fit closely upon the wales, extending from the main-wale to the top of the side, and retained in this position by bolts or spike-nails. They are intended for preferring the planks of the side, when any heavy body is hoisted or lowered.

SKIE, ISLE OF. See **SRYE**.

SKIFF, a small boat resembling a yawl, usually employed for passing rivers.

SKIMMER, **BLACK**. See **RHYNCHOPS**, **ORNITHOLOGY Index**.

SKIMMIA, a genus of plants belonging to the tetrandria class; and in the natural method ranking under the 40th order, *Perforate*. See **BOTANY Index**.

SKIN, in *Anatomy*, the general covering of the body of any animal. See **ANATOMY**, N^o 74.

SKIN, in *Commerce*, is particularly used for the membrane stripped off the animal to be prepared by the tanner, skimmer, parchment-maker, &c. and converted into leather, &c. See **TANNING**.

SKINNER, **STEPHEN**, an English antiquarian, was born in 1622. He travelled, and studied in several foreign universities during the civil wars; and in 1654, returned and settled at Lincoln, where he practised physic with success until the year 1667, when he died of a malignant fever. His works were collected in folio in 1671, by Mr Henflow, under the title of *Etymologicon Lingue Anglicaee*, &c.

SKIPPER, or **SAURY**, a species of fish. See **ESOX**, **ICHTHYOLOGY Index**.

SKIRMISH, in *War*, a slight engagement between small parties, without any regular order; and is therefore easily distinguished from a *Battle*, which is a general engagement between two armies continued for some time.

SKIRMISH Bay, the name given by Lieutenant Broughton to a bay in an island which was discovered by him in latitude 43° 48' south, and in longitude 183° east. The Chatham armed tender worked up into the bay, and came to anchor about a mile from the shore. When the captain and some of the people landed, they found the natives so extremely inhospitable, that self preservation made it necessary to fire upon them. The land is of considerable magnitude, whether island or continent, and what they saw of it extended nearly 40 miles from east to west, and the appearance of the country they regarded as very promising. The natives resemble those of New Zealand, from which they are distant about 100 leagues, but their skins were destitute of any marks, and they seemed to be cleanly in their persons. Their dresses were of seal skin, while some had fine mats fastened round the waist. Mr Broughton says, "on our first landing, they surmised and exclamations can hardly be imagined; they pointed to the sun, and then to us, as if to ask whether we had come from thence?" The arms they made use of were clubs, spears, and a small weapon resembling the patoon of New Zealand.

SKULL, in *Anatomy*, the bony case in which the brain is enclosed. See **ANATOMY**, N^o 11, &c.

Skids
ll
Skull.

SKULL-Cap. See SCUTELLARIA, BOTAN. Index.
 SKY, the blue expanse of air or atmosphere. For the reason of its blue colour and concave figure, see OPTICS, N^o 227.

SKYE, one of the greatest of the Western islands of Scotland, is called from *Skennoch*, which in the Erse dialect signifies *winged*, because the two promontories of Valeroels and Toternith, by which it is bounded on the north-west and north-east, are supposed to resemble wings. The island lies between the mire of Rofs and the western part of Lewis. According to the computation of Mr Pennant, Dr Johnson, and Dr Campbell, it is 65 miles in length, and nearly the same in width were breadth; according to others it is 50 miles in length, and in some places 30 broad. The island of Skye was formerly divided between two proprietors; the southern part belonged to the island of M'Cleod, and to be lineally descended fromLeod son to the black prince of Man, but part of this division has fallen into other hands: the northern district is the property of Lord Macdonald, whose ancestor was Donald, king or lord of the isles, and chief of the numerous clan of Macdonalds, who are counted the most warlike of all the Highlanders. Skye is part of the diocese of Inverness, and formerly belonged to the diocese of the Isles: on the south it is parted from the main land by a channel three leagues in breadth; though, at the ferry of Glenelg, it is so narrow that a man may be heard calling from the boat from one side to the other. Skye is well provided with a variety of excellent bays and harbours.

The face of the country is toughened with mountains, some of which are so high as to be covered with snow on the top at midsummer; in general, their sides are clothed with heath and grass, which afford good pasture for sheep and black cattle. Between the mountains there are some fertile valleys, and the greater part of the land towards the sea-coast is plain and arable. The island is well watered with a great number of rivers, above 50 of which afford salmon; and some of them produce black mussels in which pearls are bred, particularly the rivers Kilmartin and Ord: Martin was assured by the proprietor of the former, that a pearl hath been found in it valued at 25l. Sterling. Here is also a considerable number of fresh-water lakes well stored with trout and eels. The largest of these lakes takes its denomination from St Columba, to whom is dedicated a chapel that stands upon a small isle in the middle of the lake. Skye likewise affords several cataracts, that roar down the rocks with great impetuosity. That the island has been formerly covered with woods, appears from the large trunks of fir and other trees daily dug out of the bogs and peat-marshes in every part of the country.

From the height of the hills, and proximity of the sea, the air seldom continues long of the same temperature; sometimes it is dry, oftener moist, and in the latter end of winter and beginning of spring cold and piercing; at an average, three days in twelve throughout the year scarcely free from rain, far less from clouds. These, attracted by the hills, sometimes break in useful and refreshing showers; at other times furiously hurrying, pour down their contents with tremendous noise, in impetuous torrents that deluge the plains below, and render the smallest rivulet impassable; which, together with the stormy winds so common in this country in

the month of August and September, frequently fill the lungs, and disturb the exhalations, of the husbandman. Snow has been often known to lie on the ground from three to seven weeks; and on the highest hills, even in the middle of June, some spots of it are to be seen. To this various temperature of the air, and uncertainty of weather, the fevers and agues, rheumatisms, colds, and dysenteries, which are the prevailing distempers, may be ascribed. That it is so, however, from being unwholesome, is sufficiently evinced by experience; for the inhabitants are, in general, as thin and leanly, and arrive at an advanced age, as those who live in milder climates, and under a freer sky. The goat is scarcely known in this island.

The soil is generally black, though it likewise affords clay of different colours; such as white, red, and blue, and in some places fallow's earth. It is, however, much less adapted for agriculture than for pasture, and seldom, unless in very good years, supplies itself with a sufficiency of provisions. Yet, though the soil is not very fertile or rich, it might with proper management be made to produce more plentiful crops. But the generosity of the farmers are so prejudiced in favour of old customs, and indeed so little inclined to industry, that they will not easily be prevailed on to change them for better; especially if the alteration or amendment proposed be attended with expence. Therefore, with respect to improvements in agriculture, they are still much in the same state as they were 20 or 30 years ago. Ploughs, on a new and improved model, that in comparison to the advantages derived from them might be had at a moderate expence, have lately been introduced into several districts around, where their good effects are manifest in improving the crops and diminishing the labour of man and beast; but the laird of Ransay and one other gentleman are the only persons in Portree that have used them. The *cairns*, a crooked kind of spade, is almost the only instrument for labouring the ground used among the ordinary class of tenants. The average crops of corn are 8000 bolls.

When Mr Knox visited this island in 1786, the number of inhabitants amounted to 17,000; but between 1790-98, according to the Statistical History of Scotland, the population is only 14,470.

Various minerals are found in Skye, but none have been wrought to any advantage. Near the village of Sattle, the natives find black and white marbles, and variegated pebbles. The Appleglen, in the neighbourhood of Lochallart, produces beautiful agates of different colours: stones of a purple hue are, after great rains, found in the rivulets: crystal, of different colours and forms, abounds in several parts of the island, as well as black and white marble, fire-stone, lime stone, and talc: small red and white coral is found on the southern and western coasts in great abundance. The fuel consists chiefly of peat and turf, which are impregnated with iron ore; and coal has been discovered in several districts; but it does not appear to be worth working.

The wild birds of all sorts most common in the country, are, solan geese, gulls, cormorants, cranes, wild geese, and wild ducks; eagles, crows, ravens, rooks, cuckoos, rails, woodcocks, moor-fowl, partridges, plover, wild pigeons, and blackbirds, owls, hawks, jays, and

Skye.

a variety of small birds. In mild seasons, the cuckoo and rail appear in the latter end of April; the former disappears always before the end of June; the latter sometimes not till September. The woodcock comes in October, and frequently remains till March. The tame sorts of fowl are geese, ducks, turkeys, cocks, pullets, and tame pigeons.

The black cattle are here exposed to all the rigours of the severe winter, without any other provender than the tops of the heath and the alga marina; so that they appear like mere skeletons in the spring; though, as the grass grows up, they soon become plump and juicy, the best being sweet, tender, and finely interlard.—The amphibious animals are seals and otters. Among the reptiles may be reckoned vipers, apes, frogs, toads, and three different kinds of serpents; the first spotted black and white, and very poisonous; the second yellow, with brown spots; and the third of a brown colour, the smallest and least poisonous.

Whales, and caribous or fun-fish, come in sometimes to the sounds after their prey, but are rarely pursued with any success. The fishes commonly caught on the coast are herrings, ling, cod, skate, haddock, mackerel, lythe, fye, and dog-fish. The average price of ling at home is 13l. 13s. per ton; when sold, one by one, if fresh, the price is from 3d. to 5d.; if cured, from 5d. to 7d. The barrel of herrings seldom sells under 19s. which is owing to the great difficulty of procuring salt, even sometimes at any price; and the same cause prevents many from taking more than are sufficient for their own use.

The kyle of Scalpe teems with oysters, in such a manner, that after some spring-tides, 25 horse-loads of them are left upon the sands. Near the village of Bernhill, the beach yields muscels sufficient to maintain 60 persons per day; this providential supply helps to support many poor families in times of scarcity.

The people are strong, robust, healthy, and prolific. They generally profess the Protestant religion; are honest, brave, innocent, and hospitable. They speak the language, wear the habit, and observe the customs that are common to all the Hebrides. The meconium in new-born infants is purged away with fresh lutter: the children are bathed every morning and evening in water, and grow up so strong, that a child of 10 months is able to walk alone: they never wear shoes or stockings before the age of eight or ten, and night-caps are hardly known; they keep their feet always wet; they lie on beds of straw or heath, which last is an excellent restorative: they are quick of apprehension, ingenious, and very much addicted to music and poetry. They eat heartily of fish; but seldom regale themselves with flesh-meat: their ordinary food consists of butter, cheese, milk, potatoes, colewort, brochan, and a dish called *son*, which indeed is no other than the froth of boiled milk or whey raised with a stick like that used in making chocolate.

A sort of coarse woollen cloth called *eloa*, or *caol-dhor*, the manufacture of their wives, made into short jackets and trousers, is the common dress of the men. The plaid is rarely worn, except in summer and on Sundays; on which days, and some other occasions, those in better circumstances appear in tartans, a bonnet, and short hose, and some in a hat, short coat, waistcoat, and breeches, of Scotch or English manufacture. The wo-

Skye

Slavery.

men are in general very cleanly, and so excessively fond of dress, that many maid-servants are often known to lay out their whole wages that way.

There are two fairs held annually at Portree, to which almost every part of Skye sends cattle. The first is held in the end of May, and the second in the end of July. The fair commonly continues from Wednesday till the Saturday following. The commodities which are sold in these are horses, cows, sheep, goats, hides, butter, cheese, fish, and wool. The cattle sold in these fairs swim over to the main land through a mile or half a mile of sea. Thousands of these are yearly exported, at from 2l. to 3l. each. Many of them are driven to England, where they are fattened for the market, and counted delicious eating.

In Skye appear many ruins of Danish forts, watch-towers, beacons, temples, and sepulchral monuments. All the forts are known by the term *Dun*; such as Dun-Skudborg, Dun-Derig, Dun-Skerines, Dun-David, &c.

SKY-COLOUR. To give this colour to glass, set in the furnace a pot of pure metal of frit from rochetta or barilla, but the rochetta frit does best; as soon as the metal is well purified, take for a pot of twenty pounds of metal six ounces of brass calcined by itself; put it by degrees at two or three times into the metal, stirring and mixing it well every time, and diligently skimming the metal with a ladle: at the end of two hours the whole will be well mixed, and a proof may be taken; if the colour be found right, let the whole stand 24 hours longer in the furnace, and it will then be fit to work, and will prove of a most beautiful fye colour.

SLAB, an outside sappy plank or board sawed off from the sides of a timber-tree. The word is also used for a flat piece of marble.

SLAB-LINE, in sea-language, a small cord passing up behind a ship's main-sail, or fore sail, and being reeved through a block attached to the lower part of the yard, is thence transmitted in two branches to the foot of the sail, to which it is fastened. It is used to truss up the sail as occasion requires, and more particularly for the convenience of the pilot or steerman, that they may look forward beneath it as the ship advances.

SLACK-WATER, in sea-language, denotes the interval between the flux and reflux of the tide, or between the last of the ebb and the first of the flood, during which the current is interrupted, and the water apparently remains in a state of rest.

SLACKEN, in *Metalurgy*, a term used by miners to express a spongy and semivitrified substance which is mixed with the ores of metals, to prevent their fusion. It is the scoria or scum separated from the surface of the former fusions of metals. To this is frequently added limestone, and sometimes a kind of coarse iron-ore, in the running of the poorer gold ores.

SLATE, a stone of a compact texture and laminated fracture, splitting into fine plates, some varieties of which are employed for covering houses. See *Clay-Slate*, under *MINERALOGY*, p. 185. See also *GEOLOGY*.

SLAVE. See *SLAVERY*.

SLAVERY is a word, of which though generally understood, it is not easy to give a proper definition. An excellent moral writer has defined it to be "an obligation to labour for the benefit of the master, without the contract or consent of the servant." But may not he

be

Slavery. be properly called a slave who has given up his freedom to discharge a debt which he could not otherwise pay, or who has thrown it away at a game of hazard? In many nations, debts have been legally discharged in this manner; and in some savage tribes, such is the universal ardour for gaming, that it is no uncommon thing for a man, after having lost at play all his other property, to stake, on a single throw of dice, himself, his wife, and his children (A). That persons who have thus lost their liberty are slaves, will hardly be denied; and surely the insatuated gambler is a slave by his own contract. The debtor, too, if he was aware of the law, and contracted debts larger than he could reasonably expect to be able to pay, may justly be considered as having come under an obligation to labour for the benefit of a master *with his own consent*; for every man is answerable for all the known consequences of his voluntary actions.

This definition of slavery seems to be defective as well as inaccurate. A man may be under an obligation to labour through life for the benefit of a master, and yet that master have no right to dispose of him by sale, or in any other way to make him the property of a third person; but the word *slave*, as used among us, always denotes a person who may be bought and sold like a beast in the market (B). In its original sense, indeed, it was of the same import with *noble*, *illustrious*; but vast numbers of the people among whom it had that signification being, in the decline of the Roman empire, sold by their countrymen to the Venetians, and by them dispersed over all Europe, the word *slave* came to denote a person in the lowest state of servitude, who was considered as the absolute property of his master. See PHILOLOGY, N^o 220.

³ Inequalities of rank in-
eritable. As nothing can be more evident than that all men have, by the law of nature, an equal right to life, liberty, and the produce of their own labour (see RIGHT, N^o 5), it is not easy to conceive what can have first led one part of them to imagine that they had a right to enslave another. Inequalities of rank are indeed inevitable in civil society; and from them results that servitude which is founded in contract, and is of temporary duration. (See MORAL PHILOSOPHY, N^o 141.) He who has much property has many things to attend to, and must be disposed to hire persons to assist and serve him; while those who have little or no property must be equally willing to be hired for that purpose. And if the master be kind, and the servant faithful, they will both be happier in this connection than they could have been out of it. But from a state of servitude, where the slave is at the absolute disposal of his master in all things, and may be transferred without his own consent from

one proprietor to another, like an ox or an ass, happiness must be for ever banished. How then came a traffic so unnatural and unjust as that of slaves to be originally introduced into the world?

The common answer to this question is, that it took its rise among savages, who, in their frequent wars with each other, either massacred their captives in cold blood, or condemned them to perpetual slavery. In support of this opinion we have heard it observed, that the Latin word *servus*, which signifies not a hired servant, but a *slave*, is derived from *servare*, “to preserve;” and that such men were called *servi*, because they were captives, whose lives were preserved on the condition of their becoming the property of the victor.

That slavery had its origin from war, we think extremely probable (C), nor are we inclined to controvert this etymology of the word *servus*; but the traffic in men prevailed almost universally long before the Latin language or Roman name was heard of; and there is no good evidence that it began among savages. The word *עַבְד*, in the Old Testament, which in our version is rendered *servant*, signifies literally a *slave*, either born in the family or bought with money, in contradistinction to *עַבְד*, which denotes a hired servant: and as Noah makes use of the word *עַבְד* in the curse which he pronounced upon Ham and Canaan immediately after the deluge, it would appear that slavery had its origin before that event. If so, there can be little doubt but that it began among those violent persons whom our translators have called *giants**, though the original word *גִּימְטִים* literally signifies *assaulters of others*. Those wretches seem first to have leized upon women, who they forcibly compelled to minister to their pleasures; and from this kind of violence the progress was natural to that by which they enslaved their weaker brethren among the men, obliging them to labour for their benefit, without allowing them fee or reward.

After the deluge the first dealer in slaves seems to have been Nimrod. “He began,” we are told, “to be a mighty one in the earth, and was a mighty hunter before the Lord.” He could not, however, be the first hunter of wild beasts; for that species of hunting must have been practised from the beginning; nor is it probable that his dexterity in the chase, which was then the universal employment, could have been so far superior to that of all his contemporaries, as to entitle him to the appellation of the “mighty hunter before the Lord.” Hence most commentators have concluded, that he was a hunter of men; an opinion which they think receives some countenance from the import of his name, the word *Nimrod* signifying a rebel. Whatever

(A) Aleam (quod mirere) subrii inter feris exercent, tanta lucrandi perdendive temeritate, ut cum omnia desererent, extremo ac novissimo jactu de libertate et corpore contendunt. Vitius voluntariam servitutem adit; quamvis junior, quamvis robustior, alligari se ac venire patitur.—*Tacitus de Mor. Germ.*

The savages of North America are equally addicted to gaming with the ancient Germans, and the negroes on the Slave Coast of Guinea perhaps still more.

(B) The Roman orator’s definition of *slavery*, Parad. V. is as accurate as any that we have seen. “Servitus est obedientia fracti animi et abjecti et arbitrio carentis suo;” whether the unhappy person fell into that state with or without his own contract or consent.

(C) In the article SOCIETY, the reader will find another account of the origin of slavery, which we think likewise probable, though we have not transferred it to this place; as it would, in our opinion, be wrong to give to one writer what we know to belong to another. It may be proper, however, to observe here, that between the two articles there is no contradiction, as barbarous wars were certainly one source of slavery.

Slavery.

be in this, there can be little doubt but that he became a mighty one by violence; for being the sixth son of his father, and apparently much younger than the other five, it is not likely that his inheritance exceeded theirs either in extent or in population. He enlarged it, however, by conquest; for it appears from Scripture, that he invaded the territories of Athar the son of Shem, who had settled in Shinar; and obliging him to remove into Assyria, he seized upon Babylon, and made it the capital of the first kingdom in the world. As he had great projects in view, it seems to be in a high degree probable that he made bond-servants of the captives whom he took in his wars, and employed them in building or repairing the metropolis of his kingdom; and hence we think is to be dated the origin of postdiluvian slavery.

6
Slavery in
the days of
Abraham.

That it began thus early can hardly be questioned; for we know that it prevailed universally in the age of Abraham, who was born within seventy years after the death of Nimrod. That patriarch had three hundred and eighteen servants or slaves, born in his own house, and trained to arms, with whom he pursued and conquered the four kings who had taken captive his brother's son \ddagger . And it appears from the conversation which took place between him and the king of Sodom after the battle, that both believed the conqueror had a right to consider his prisoners as part of his spoil. "Give me (says the king) the *persons*, and take the *goods* to thyself." It is indeed evident from numberless passages of scripture, that the domestics whom our translators call *servants* were in those days universally considered as the most valuable part of their master's property, and classed with his flocks and herds. Thus when the sacred historian describes the wealth of Abraham, he says, that "he had sheep and oxen, and he asses, and men-servants, and maid-servants, and she-asses, and camels." And when Abimelech wished to make some reparation to the patriarch for the unintended injury that he had done him, "he took sheep and oxen, and men-servants, and women-servants, and gave them unto Abraham, and restored to him Sarah his wife." The riches and power of Isaac and Jacob are estimated in the very same manner. Of the former it is said, that "the man waxed great, and went forward and grew, until he became very great: for he had possession of flocks, and possession of herds, and great store of servants, עַבְדֵי of slaves; and the Philistines envied him." The latter, we are told, "increased exceedingly, and had much cattle, and maid-servants, and men servants, and camels, and asses I ."

1 Gen. xii.
16. xv. 14.
ANU. 35.
xvi. 13-14.
xxx. 43.

That the practice of buying and selling servants thus early began among the patriarchs descended to their posterity, is known to every attentive reader of the Bi-

ble. It was expressly authorized by the Jewish Law, in which are many directions how such servants were to be treated. They were to be bought only of the heathen; for if an Israelite grew poor and sold himself either to discharge a debt, or to procure the means of subsistence, he was to be treated not as a slave קָנָה , but as a hired servant שָׂכָר , and restored to freedom at the year of jubilee. "Both thy bond-men and thy bond maids (says Moses) shall be of the heathen that are round about you: of them shall ye buy bond-men and bond maids. And ye shall take them as an inheritance for your children after you, to inherit them for a possession; they shall be your bond-men for ever II ." Unlimited as the power thus given to the Hebrews over their bond-servants of heathen extraction appears to have been, they were strictly prohibited from acquiring such property by any other means than fair purchase: "he that *stealeth* a man and selleth him," said their great lawgiver, "shall surely be put to death § ."

S' vers.
7
if d
y the Mo
the law.

Lev. xxv.
39. 4-6

Lev. xxi.
16

§
stated over
the whole
world.

While slavery, in a mild form, was permitted among the people of God, a much worse kind of it prevailed among the heathen nations of antiquity. With other abominable customs, the traffic in men quickly spread from Chaldea into Egypt, Arabia, and over all the east, and by degrees found its way into every known region under heaven (D).

Of this hateful commerce we shall not attempt to trace the progress through every age and country, but shall content ourselves with taking a transient view of it among the Greeks and Romans, and a few other nations, in whose customs and manners our readers must be interested.

One can hardly read a book of the *Iliad* or *Odyssey*, without perceiving that, in the age of Homer, all prisoners of war were liable to be treated as slaves, and compelled, without regard to their rank, sex, or years, to labour for their masters in offices of the vilest drudgery. So universally was this cruel treatment of captives admitted to be the right of the victor, that the poet introduces Hector in the very act of taking a tender and perhaps sad farewell of his wife, when it was surely his business to afford her every consolation in his power, telling her, as a thing of course which could not be concealed, that, on the conquest of Troy, she would be compelled

To bear the victor's hard commands, or bring
The weight of water from Hyperia's spring (E).

POND.

At that early period, the Persians, and probably the Greeks themselves, had such an established commerce in slaves, that, not satisfied with reducing to bondage their prisoners of war, they scrupled not to kidnap in cold blood

(D) If credit be due to a late account of China, the people of that vast empire have never made merchandise of men or women. The exception, however, is so singular, that we should be glad to see it better authenticated; for it is apparent from works of the most undoubted credit, that over all the other eastern countries with which we are acquainted slavery has prevailed from time immemorial, and that some of the Indian nations make long journeys into Africa for the sole purpose of buying slaves.

(E) In those early times drawing water was the office of the meanest slaves. This appears from Joshua's curse upon the Gibeonites who had deceived him — "Now therefore ye are cursed, and there shall none of you be freed from being bond-men, and hewers of wood, and drawers of water, for the house of my God." To this state of bondage Homer makes Hector say, that Andromache would necessarily be brought upon the destruction of Troy; $\text{καταβηθ' ὁ σταλάζειν ὕδατιν. — Iliad. lib. vi.}$

Slav. blood persons who had never kindled their resentment, in order to supply their foreign markets. In the 14th book of the *Quæst.*, Ulysses represents himself as having narrowly escaped a fate of this kind had for him by a fish-Pæonian, who had doomed the hero to Libya thereby; and as the whole narrative, in which this circumstance is told, is an artful fiction, intended to have the appearance of truth to an human passion, the practice of kidnapping, slaves could not then have appeared incredible to any inhabitant of that island.

Such were the manners of the Greeks in the heroic age; nor were they much improved in this respect at periods of greater refinement. Philip of Macedon having conquered the Thebans, not only sold his captives, but even took money for permitting the dead to be buried; and Alexander, who had more generosity than Philip, afterwards razed the city of Thebes, and sold the inhabitants, men, women, and children, for slaves. This cruel treatment of a brave people may indeed be supposed to have proceeded, in the first instance, from the avarice of the conqueror; and in the second, from the momentary resentment of a man who was savage and generous by turns, and who had no command of his passions. We shall not positively assign it to other causes; but from the manner in which the Spartans behaved to their slaves, there is little reason to imagine that had they received from the Thebans the same provocation with Alexander, they would have treated their captives with greater lenity. "At Sparta (says a humane and elegant writer) slaves were treated with a degree of rigour that is hardly conceivable; although to them, as their husbandmen and artificers, their proud and idle masters were indebted for all the necessaries of life. The Lacedæmonian youth, trained up in the practice of deceiving and butchered those poor men, were from time to time let loose upon them, in order to show their proficiency in stratagem and massacre. And once, without any provocation, and merely for their own amusement, we are told that they murdered three thousand in one night; not only with the connivance of law, but by its avowed permission. Such, in promoting the happiness of one part of society and the virtue of another, are the effects of slavery."

It has been said, that in Athens and Rome slaves were better treated than in Sparta; but in the former city their treatment cannot have been good, or their lives comfortable, when the Athenians relished that tragedy of Euripides in which Hecuba, the wife of Priam, is introduced as lame—*and* that she was chained like a dog at Agamemnon's gate? Of the estimation in which slaves were held in Rome, we may form a tolerable notion from the well-known fact, that one of those unhap-

py dogs was often chained at the gate of a great man's house, to give admittance to the guests invited to a feast. In the early periods of the Roman wealth it was customary, in certain rare occasions, to send on solemn occasions, to drag through the streets a slave, who had been sentenced to death during the last hour of the day in the form of a specter. But we need not multiply proofs of the cruelty of the Romans to their slaves. It is the *Infamia* consists of the *placitator* (see *GRÆCÆ*, 7088) admit of any apology on account of the martial spirit with which they were thought to inspire the spectators, the conduct of *Vellius Pitolianus* have proceeded from the most wanton and brutal cruelty. This man, who flourished not in the earliest periods of the republic, when the Romans were little better than a savage banditti, but in the polished age of Augustus, frequently threw such slaves as gave him the least offence into his filiponds to fatten his lampreys; and yet he was suffered to die in prison! The emperor, indeed, upon coming to the knowledge of his cruelty, ordered his lampreys to be destroyed, and his ponds to be filled up; but we do not recollect that any other punishment was inflicted on the savage master. Till the reign of the same emperor the depositions of slaves were never admitted in the courts of judicature; and then they were received only when persons were accused of treasonable practices.

The origin of slavery in Rome was the same as in every other country. Prisoners of war were of course reduced to that state, as if they had been criminals. The dictator *Camillus*, one of the most accomplished generals of the republic, sold his *Hetrurian* captives to pay the Roman ladies for the jewels which they had pretended to Apollo. *Fabius*, whose cautious conduct saved his country when Hannibal was victorious in Italy, having subdued Tarentum, reduced 30,000 of the citizens to slavery, and sold them to the highest bidder. *Coriolanus*, when driven from Rome, and fighting for the Volsci, scrupled not to make slaves of his own countrymen; and *Julius Cæsar*, among whose faults we may cruelly has never been reckoned, sold at one time fifty-three thousand captives for slaves. Nor did the slaves in Rome consist only of foreigners taken in war. By one of the laws of the twelve tables, creditors were empowered to seize their insolvent debtors, and keep them in their houses till, by their services or labour, they had discharged the sum they owed; and in the beginning of the commonwealth they were authorized to sell such debtors, and even to put them to death (F). The children of slaves were the property not of the commonwealth, or of their own parents, but of their masters; and thus was slavery perpetuated in the families of such unhappy

(F) After a certain number of citations, the law granted to the debtor thirty days of grace to raise the sum for which he was accountable. The words of the law are: "Aeris confessi, relinque jure judicatis, triginti dies jussu finto. Post dein manum endocipito.—Vincito aut nervo, aut compediis." When the debt is confessed, and the trial passed, let there be thirty days of forbearance; afterwards lay hands on him; bind him either with a cord or fetters." After the thirty days were expired, if the debtor had not discharged the debt, he was led to the praetor, who delivered him over to the mercy of his creditors; these bound him and kept him in chains for the space of sixty days. Afterwards, for three market-days successively, the debtor was brought to the tribunal of the praetor; and then a public edict proclaimed in the forum the debt for which the prisoner was detained. It often happened, that rich persons redeemed the prisoner by paying his debt; but if nobly appeared in behalf of the debtor after the third market-day, the creditor had a right to inflict the punishments appointed by the law. "Tertius mundinis

Slavery.

unhappy men as fell into that state, whether through the chance of war or the cruelty of a sordid creditor (G). The consequence was, that the number of slaves belonging to the rich patricians was almost incredible. Caius Cæcilius Iddorus, who died about seven years before the Chrillian era, left to his heirs 4116 slaves; and if any one of those wretched creatures made an unsuccessful attempt to regain his liberty, or was even suspected of such a design, he was marked on the forehead with a red-hot iron (H). In Sicily, during the most flourishing periods of the commonwealth, it seems to have been customary for masters to mark their slaves in this manner; at least we know that such was the practice of Damophilus, who, not satisfied with this security, shut up his slaves every night in close prisons, and led them out like beasts in the morning to their daily labour in the field. Hence arose the servile war in Sicily.

12
Its duration.

Though many laws were enacted by Augustus and other patriotic emperors to diminish the power of creditors over their insolvent debtors; though the influence of the mild spirit of Christianity tended much to meliorate the condition of slaves, even under Pagan masters; and though the emperor Adrian made it capital to kill a slave without a just reason; yet this infamous commerce prevailed universally in the empire for many ages after the conversion of Constantine to the religion of Christ. It was not indeed completely abolished even in the reign of Justinian; and in many countries which had once been provinces of the empire it continued long after the empire itself had fallen to pieces.

13
Slavery among the ancient Germans.

It has already been observed, that among the ancient Germans it was not uncommon for an ardent gamester to lose his personal liberty by a throw of the dice. This was indeed a strong proof of savage manners; but the general condition of slaves among those savages seems to have been much better than among the polished Greeks and Romans. In Germany the slaves were generally attached to the soil, and only employed in tending cattle, and carrying on the business of agriculture; for the menial offices of every great man's house were performed by his wife and children. Such slaves were seldom beaten, or chained, or imprisoned. Sometimes indeed they were killed by their masters in a fit of sudden passion; but none were considered as materials of commerce, except those who had originally been freemen, and lost their freedom by play. These, indeed,

the successful gamester was very ready to sell, both because he felt them an useless burden, and because their presence continually put him in mind of that state to which a throw of the dice might one day reduce himself.

Slavery.

Such is the account which Tacitus gives * of slavery among the ancient Germans. The Anglo-Saxons, however, after they were settled in this island seem not to have carried on that traffic so honourably. By a statute of Alfred the Great †, the purchase of a man, a horse, or an ox, without a voucher to warrant the sale was strictly forbidden. That law was, doubtless, enacted to prevent the stealing of men and cattle; but it shows us that so late as the ninth or tenth century a man, when fairly purchased, was, in England, as much the property of the buyer as the horse on which he rode, or the ox which dragged his plough. In the same country, now so nobly tenacious of freedom and the rights of man, a species of slavery similar to that which prevailed among the ancient Germans subsisted even to the end of the sixteenth century. This appears from a commission issued by Queen Elizabeth in 1574, for inquiring into the lands and goods of all her bond-men and bond-women in the counties of Cornwall, Devon, Somerset, and Gloucester, in order to compound with them for their manumission, that they might enjoy their lands and goods as freemen ‡. In Scotland there certainly existed an order of slaves or bond-men, who tilled the ground, were attached to the soil, and with it were transferable from one proprietor to another, at a period so late as the thirteenth century; but when or how those villains, as they were called, obtained their freedom, seems to be unknown to every lawyer and antiquary of the present day. Coaliers and salters were, in the same country, slaves till little more than 30 years ago, that they were manumitted by an act of the British legislature, and restored to the rights of freemen and citizens. Before that period the sons of coaliers could follow no business but that of their fathers; nor were they at liberty to seek employment in any other mines than those to which they were attached by birth, without the consent of the lord of the manor, who, if he had no use for their services himself, transferred them by a written deed to some neighbouring proprietor.

That the savage nations of Africa were at any period

16
Slavery among the Carthaginians,

capite pœnas dato aut trans Tiberim peregre venundito;" that is, "Let him on the third market-day be punished with death, or sold beyond the Tiber as a slave." If there were several creditors, they were allowed, in consequence of this severe law, to divide the body of the prisoner into several parts, and share it among them in proportion to the sum which they demanded.

(G) This is evident from the story of Appius and Virginia. See ROME, N^o 113.

(H) How capriciously and unjustly this infamous mark was impressed, we learn from the story of Restio. This man being proscribed, and a reward offered for his head by the triumvirs Octavianus, Antony, and Lepidus, concealed himself from the fury of the tyrants in the best way that he could. A slave whom he had marked with the hot iron having found out the place of his retreat, conducted him to a cave, and there supported him for some time with what he earned by his daily labour. At length a company of soldiers coming that way, and approaching the cave, the faithful slave, alarmed at the danger his master was in, followed them close, and falling upon a poor peasant, killed him in their presence, and cut off his head, crying out, "I am now revenged on my master for the marks with which he has branded me." The soldiers, seeing the infamous marks on his forehead, and not doubting but he had killed Restio, fractured the head out of his hand, and returned with it in all haste to the triumvirs. They were no sooner gone, than the slave conveyed his master to the sea-side, where they had the good luck to find one of Sextius Pompeius's vessels, which transported them safe into Sicily.

Slavery.

of history exempted from this opprobrium of our nature which spread over all the rest of the world, the enlightened reader will not suppose. It is indeed in that vast country that slavery has in every age appeared in its ugliest form. We have already observed, that about the era of the Trojan war, a commerce in slaves was carried on between Phœnicia and Libya; and the Carthaginians, who were a colony of Phœnicians, and revered the customs, manners, and religion of their parent state, undoubtedly continued the Tyrian traffic in human flesh with the interior tribes of Africa. Of this we might rest assured, although we had no other evidence of the fact than what results from the practice of human sacrifices to prevalent in the republic of Carthage. The genuine instincts of nature are often subdued by dire superstition, but they cannot be wholly eradicated; and the rich Carthaginian, when a human victim was demanded from him to the gods, would be ready to supply the place of his own child by the son of a poor stranger, perfidiously purchased at whatever price. That this was, indeed, a very common practice among them, we learn from the testimony of various historians*, who assure us, that when Agathocles the tyrant of Syracuse had overthrown their generals Hanno and Bomilcar, and threatened Carthage itself with a siege, the people attributed their misfortunes to the just anger of Saturn for having been worshipped, for some years, by the sacrifices of children meanly born and secretly bought, instead of those of noble extraction. These substitutions of one offering for another were considered as a profane deviation from the religion of their forefathers; and therefore to expiate the guilt of so horrid an impiety, a sacrifice of 200 children of the first rank was on that occasion made to the bloody god. As the Carthaginians were a commercial people, we cannot suppose that they purchased slaves only for sacrifices. They undoubtedly condemned many of their prisoners of war to the state of servitude, and either sold them to foreigners, or distributed them among their senators and the leaders of their armies. Hanno, who endeavoured to usurp the supreme power in Carthage whilst that republic was engaged in war with Timoleon in Sicily †, armed 20,000 of his slaves in order to carry his nefarious purpose into execution; and Hannibal, after his decisive victory at Cannæ, sold to the Greeks many of his prisoners whom the Roman senate refused to redeem †. That illustrious commander was indeed more humane, as well as more politic, than the generality of his countrymen. Before his days it was customary with the Carthaginians either to massacre their captives in cold blood, that they might never again bear arms against them, or to offer them in sacrifice as a grateful acknowledgement to the gods by whose assistance they believed that they were vanquished; but this was not always done even by their most superstitious or most unprincipled leaders. Among other rich spoils which Agathocles, after his victory already mentioned, found in the camp of Hanno and Bomilcar, were twenty thousand pair of fetters and manacles, which those generals had provided for such of the Sicilian prisoners as they intended to preserve alive and reduce to a state of slavery.

With the ancient state of the other African nations we are but very little acquainted. The Numidians, Mauritians, Getulians, and Garamantes, are indeed mentioned by the Roman historians, who give us ample

details of the battles which they fought in attempting to preserve their national independence; but we have no particular account of their different manners and customs in that age when Rome was disputing with Carthage the sovereignty of the world. All the African states of which we know any thing, were in alliance with one or other of those rival republics; and as the people of those states appear to have been less enlightened than either the Romans or the Carthaginians, we cannot suppose that they had purer morals, or a greater regard for the sacred rights of man, than the powerful nations by whom they were either protected or oppressed. They would, indeed, insensibly adopt their customs; and the ready market which Marius found for the prisoners taken in the town Capſa, although Sallust acknowledges † that the sale was contrary to the laws † *Bell. Jug.* of war, shows that slavery was then no strange thing to the Numidians. It seems indeed to have prevailed through all Africa from the very first peopling of that unexplored country; and we doubt if in any age of the world the unhappy negro was absolutely secure of his personal freedom, or even of not being sold to a foreign trader.

It is the common opinion that the practice of man-stealing slaves of the negroes is of a very modern date; that with it owes its origin to the incursions of the Portuguese on the western coast of Africa; and that but for the cunning or cruelty of Europeans, it would not now exist, and would never have existed. But all this is a complication of mistakes. A learned writer has lately proved, with a force of evidence which admits of no reply * that from the coast of Guinea a great trade in slaves was carried on by the Arabs some hundreds of years before the Portuguese embarked in that traffic, or had even seen a woolly-headed negro. Even the wandering Arabs of the desert, who never had any friendly correspondence with the Christians of Europe, have from time immemorial been served by negro slaves. "The Arab must be poor indeed (says M. Saugnier) not to have at least one negro slave. His sole occupation is the care of the herd. They are never employed in war, but they have it in their power to marry. Their wives, who are captive negroes, do all the domestic work, and are roughly treated by the Arabian women, and by the Arabs themselves. Their children are slaves like them, and put to all kinds of drudgery." Surely no man whose judgment is not completely warped by prejudice, will pretend that those roving tribes of savages, so remarkable for their independent spirit and attachment to ancient customs, learned to enslave the negroes from the Europeans. In all probability they have, without interruption, continued the practice of slavery from the days of their great ancestor Ishmael; and it seems evident, that none of the European nations had ever seen a woolly-headed negro till the year 1100, when the crusaders fell in with a small party of them near the town of Hebron in Judea, and were so struck with the novelty of their appearance, that the army burst into a general fit of laughter †. Long before the crusades, however, we know with certainty that the natives of Guinea had been exposed to sale in foreign countries. In 651 the Mahometan Arabs of Egypt so harassed the king of Nubia or Ethiopia, who was a Christian, that he agreed to send them annually, by way of tribute, a *good number of Nubians or Ethi-*

Slavery.

* *Polib.*
 † *Curt.*
 † *Diod. Sic.*
 See also
Unicursal
History,
 vol. xv.

† *Jokin.*
 lib. xv.
 cap. 6. and
Unicursal
History.
 † *Tr. Liv.*
Appian and
Zonaras.

† *And. Numb.*
 dians.

† *Bell.*

† *Jug.*

† *40. 91.*

15

man-stealing
 trade
 on coast of
 Guinea began not by
 the Portuguese, the Portu-
 guese, the Portu-
 guese.

* *Whitaker's Review of Gibbon's Roman History.*

19
 But by the
 Arabs at an
 early period.

Saugnier
 in his
Journal de Voyages.

101.

† *Martin's Travels.*
 p. 23.

26. 7

Slavery. *Slavery.*
 pian slaves into Egypt. Such a tribute as this at that time, we are told, was more agreeable to the Khalif than any other, as the Arabs then made no small account of those slaves*.

* Modern Universal History, vol. vi. p. 222.

The very proposal of such a tribute, and the estimation in which black slaves were held in Egypt, shows that a commerce in bond-servants could not then be a new branch of trade either to the Arabs or the Ethiopians; but the vast number which the Ethiopian monarch was now compelled to furnish every year, induced him to feed this great drain upon his subjects from the natives of the neighbouring countries. "He ranged accordingly into all that vast blank of geography upon the map of the world, the spreading bolom of the African continent; and even pushed through it to its farthest extremities in the west. He thus brought the blacks of Guinea, for the first time, into the service and families of the east; and the slaves which he paid in tribute to the Arabs, whether derived from the nearer neighbourhood of Ethiopia, fetched from the mediterranean regions of Africa, or brought from the distant shores of the Atlantic, were all denominated *Ethiopianni*, from the country by which they were conveyed into Egypt †. "At this time, therefore, according to Mr Whitaker, began that kind of traffic in human flesh

† Whitaker's Review.

"Which spoils unhappy Guinea of its sons."

There are not many authors from whom, in questions of antiquity, we differ with greater hesitation; but, as we meet with a female Ethiopian slave in the Eunuch of Terence, we cannot help suspecting that Guinea was occasionally "spoiled of its sons" at a much earlier period. At any rate, from the observations made by the European travellers who first penetrated into that continent, it appears undeniable that slavery must have prevailed from time immemorial among such of the tribes as had never carried on any commerce with foreign nations. When Battel first visited the Giagas*, those people had never before seen a white man; yet they welcomed him and the English, with whom he had come, to their country, invited them to bring their goods on shore, and without hesitation loaded the ships with slaves. The Giagas were indeed waging war with the kingdom of Benguela; and being cannibals, who prefer human flesh to all others, the slaves whom they had sold to the English were probably prisoners whom they would have killed and eaten if they had not found an opportunity of otherwise disposing of them to greater advantage. But as they had not been incited by the Europeans to eat their prisoners, there can be no reason to suppose that by the Europeans they had been first induced to sell them; for we have seen that this kind of commerce prevailed in Africa among people much more polished than the Giagas so early as in the reign of Jugurtha.

20
 The negroes have envied one another from time immemorial. See Modern Universal History, chap. 47.

That it was not introduced among the negroes either by the Arabs or by the Portuguese, appears still more evident from the behaviour of the Dahomans at the conquest of Whidah, and from the manner in which the

people of Angola at the earliest stage of their foreign trade procured a supply of slaves for the Portuguese market. The greater part of the slaves whom the Angolans exported from St Paulo de Louanda were brought from interior countries, some hundreds of leagues distant, where they could not have been regularly purchased had that commerce been till then unknown in those countries. The Dahomans, in the beginning of the year 1727, had never seen a white man; and when their victorious prince and his army, in their rout through Whidah, first met with some Europeans in the town of Saba, they were so shocked at their complexion and their dress, that they were afraid to approach them, and could not be persuaded that they were men till they heard them speak, and were assured by the Whidanese that these were the merchants who purchased all the slaves that were sold in Guinea †. Slavery, therefore, if it prevailed among the Dahomans before that period, could not have been introduced among them by European or Arabian intrigues; but we are assured by Snelgrave, who was then in the army, that those people treated their captives with such horrid cruelty as was shocking to the natives of the sea coast, and leaves no room for doubt but that slavery had been practised among them from the earliest ages. A great part of their prisoners were sacrificed to their gods or eaten by the soldiers; and when our author expressed to a colonel of the guard some surprisè that a prince so enlightened as the sovereign of Dahomy should sacrifice so many men whom he might have sold to great advantage, he was gravely told, that it had been the custom of their nation, from time immemorial, to offer, after victory, a certain number of prisoners to the gods; and that they selected the old men for victims, because they were of less value at market, and more dangerous from their experience and cunning, than the young men. To those persons who fancy that the wars between the African princes are carried on for the sole purpose of supplying the European ships with slaves, it may be proper to remark, that one of the kings of Dahomy slaughtered at once not only all the captives taken in war, but also 127 prisoners of different kinds, that he might have a sufficiency of skulls to adorn the walls of his palace; though at the very time of that massacre he knew that there were six slave-ships in the road of Whidah, from which he could have got for every prime slave a price little short of thirty pounds sterling †.

Slavery.

† Modern Universal History, vol. xiii.

These facts, and numberless others which the reader will find detailed in the 13th volume of the Modern Universal History, by writers who were at the greatest pains to procure authentic information; and who were neither biased by interest nor blinded by enthusiasm; and who appear to have held the infamous traffic in utter abhorrence—prove beyond the possibility of doubt, that slavery of the worst kind must have prevailed among all the negro nations before they were visited either by the Portuguese or by the Arabs (1). These two nations may

† Dabnel's History of the Kingdom of Dahomy.

(1) The same thing appears from the voyages of M. Saugnier, who had an opportunity of conversing with many tribes of negroes, and who always speaks of slavery as an established practice among them; adding, that such as are sold for crimes are put to death by their own countrymen if they fly from their master. It appears likewise in a still more striking light from Dabnel's History of Dahomy, where we are told that all the Dahomans,

Slavery. may indeed have been the first who dragged the unhappy negro from his native continent, and made his slavery doubly severe, by compelling him to labour, without his own consent, for masters whom he hardly considered as human beings.

On the beginning of this commerce, or the dreadful cruelty with which it has been carried on to the present day, it is impossible to reflect without horror: but there is some consolation, however small, in knowing that its original authors were not Europeans. The purchase of Guinea blacks for slaves by foreign nations commenced ages before the Portuguese had laid that country open to the intercourse of Europe. Even after they had made many incursions into it, the inhabitants were as regularly purchased for slaves by some of the adjoining states as they are now by the maritime Europeans.

“The Arabs of Egypt having reduced all the north of Africa, and carrying with them their love of black servants, would be sure to open a ready communication for themselves to their country. They certainly had one so early as 1512, and before the Europeans had any for that purpose (K). They went from Barbary by a route that was so much practised, as to be denominated expressly ‘the way of the camels.’ Meeting together at the town of Cape Cantin, or that of Valadie near it, the commercial caravan traversed the vast deserts, those of Sirra, which run like the tropic of Cancer over them in a long line across the country; to a place of great population called Huden, the *Haden* or *Hiden* of our maps, and a little to the south-west of Cape Blanco. From Huden they turned to the left, and pushed directly into the interior of the continent, to reach Tegazza, the *Tagesel* or *Tageza* of our maps, and lying nearly east of Huden. Here assuredly they did, as the caravan does certainly at this day; and added to the other wares upon their camels a quantity of salt from those mines of rock-salt, which are extraordinary enough to be noticed as rocks in our maps. This they carried, as they still carry it, to Tanbut, the *Tumbat* of the maps, and a town in the heart of the African continent. And from this town they turned on the right for the sea coast again, and reached it in the great kingdom of Mele, the *Melli* of our maps, to the south of the Gambia, and just at the springing as it were of that grand arch

VOL. XIX. Part I.

of sea which curves so deeply into the body of the land, and constitutes the extensive gulf of Guinea. At Melli and at Tumbut they received a measure of gold for a measure of salt. The caravan collects gold at Tumbut to the present time; but at Melli they purchased gold, and also silver, in pieces as large as pebbles. And at Huden they had a great mart for slaves; the blacks being brought thither from the countries adjoining, and bartered away to the traders. Such was the Slave Coast and the Gold Coast of former days. The staple commodity of Huden is only transferred now to Whidah; and diverted from the Arabs of Barbary to the Christians of Europe,” by whom the negroes are carried to the continent of America or to the Sugar Islands in the West Indies. In these countries they are all sold like beasts in a market; but they experience very different degrees of servitude from the different masters who hold them as property. Such of them as are reconciled to the appearance of white men, or have been born in the European colonies, feel themselves as happy under a humane master as they could be in their native continent (L); and we believe that few of them in such circumstances have expressed a desire to return.”

In the French West India islands, before the late revolution in the mother country, which has produced in all its dependencies anarchy and massacre, the condition of the negro slaves was better than that of the bondmen among the ancient Germans. “Those of them who cultivated the plantations were attached to the soil, and could not be drawn off to pay debts, or be sold separately from the estate on which they lived. This gave them a lasting property in their huts and little plots of ground, which they might safely cultivate without dread of being turned out of possession, or transferred contrary to their interest and feelings from one proprietor to another. They were under the protection of law as soon as they arrived in the colony. Proper missionaries were appointed for the purpose of training them up to a certain degree of religious knowledge, and ample funds were allotted for the maintenance of those ecclesiastics. On ill treatment received from his master, or on being deprived of his allowance of food and raiment, the slave was directed to apply to the king’s at-

3 D

torney,

mans, from the lowest to the highest, acknowledge the right of the sovereign to dispose of their persons and properties at pleasure; and where we learn, that the sovereign himself assured Mr Abson the English governor at Whidah, that all his ancestors had from time immemorial put to death every prisoner of war whom they could not sell as a slave.

(K) In the year 1442, Anthony Gonfalez, a Portuguese adventurer, restored to their native country some Moorish prisoners whom he had two years before forcibly carried off from the coast of Africa. He landed them at *Ris del-Ora*, and received from the Moors in exchange ten blacks and a quantity of gold dust. This transaction proves, that a commerce in black servants was then regularly carried on by the Moors and not by the Portuguese. So early as the year 1502, the Spaniards began to employ a few negroes in the mines of Hispaniola; but in the year following, Ovando, the governor of that island, forbade the further importation of them, alleging that they taught the Indians all manner of wickedness, and rendered them less tractable than formerly; and it was not till the year 1517 that the supply of negroes to the Spanish American plantations became an established and regular branch of commerce. *Edward’s History of the West Indies*, Book IV. chap. ii.

(L) “I have observed many of my slaves go on board the vessel with joy, on my assurance that they would be well treated and happy on the plantation where I was going to send them. When the Barbarians find that they are trusted by the whites, they never think of making their escape, choosing to be the slaves of Europeans rather than of a black man who would treat them with the greatest cruelty. *Voyages to the Coast of Africa by Messrs Saugnier and Brisson*, p. 332. 335. English Translation.

toney, who was obliged to prosecute the master forthwith. That officer was also bound to prosecute, if by any other means he heard of the abuse; the law adding as the reason, *This we will to be observed, to check the* ^{Slavery.} *arbitrary use of power in the master.* ^{Romney's Essays, p. 16. and 191.}

We wish it were in our power to say, that in the British West India colonies slaves are equally protected by law as they were in the French islands under the old government, and that the same care is taken of their moral and religious improvement. This, however, we are afraid, cannot be said with truth. In the island of Jamaica, before the passing of the consolidated slave act, not many years ago, a white man, whether proprietor or not, who had killed a negro, or by an act of severity been the cause of his death, was, for the first offence, intitled to benefit of clergy, and not liable to capital punishment till a repetition of the crime. By the present law, it is enacted, "That if any person, whether owner or superintendent of slaves, shall be convicted of having, by any act of passion or cruelty, occasioned the death of any negro, it shall be capital for the first offence; and for the greater security of the property, and as a check on those who may have the punishment of slaves in their power, it is particularly required, that every surgeon or doctor belonging to each estate shall swear to the cause of the death of each negro, to the best of his knowledge and belief; and if any negro dies, and is interred by the owner or overseer, without the doctor's having seen or been sent for to such negro, in this case the owner or overseer causing the negro to be interred is liable to a prosecution for such conduct."

This law must doubtless be productive of good effects, but being a colonial act, it cannot have the vigour of the *Code Noir*; nor do we know of any attorney in the island who is obliged to defend the rights of the negroes, or prosecute the master whose cruelty has by any means come to his knowledge. The justices and vestry of each parish are indeed constituted a council of protection, for the express purpose of making full enquiry into the barbarities exercised on slaves, and bringing the authors to punishment at the public expence; and by a new slave-act of Grenada, the justices are required annually to nominate three freeholders to be *guardians of the slaves*, who are to take an oath to see the law duly executed. These are benevolent regulations; but we doubt if protection can be so promptly afforded by a council of guardians as by an individual attorney who has no other employment. In some of the other British islands, we have been confidently told that the unfortunate sons of Africa have no protection whatever against the tyranny of a fond owner, or the caprice of a boyish overseer (M); though it is added, that the humanity of many masters more than supplies the want of laws in every respect but that of improvement, and that the attachment of others has in them a like effect. In some cases good sense, a regard for their reputation, and a well-informed conviction of their interest, induce men to treat their

slaves with discretion and humanity. The slaves of a planter possess advantages beyond what the labourer even of Britain enjoys; yet these advantages all depend upon the good will of his master; and in no part of the British colonies are the slaves attached to the soil. This single circumstance, together with the total neglect of their moral and religious culture, makes their situation much less eligible than was that of the French slaves under the old government; and affords a striking proof of what the humane author whom we have just quoted well observes, that "those men and nations whom liberty hath exalted, and who therefore ought to regard it tenderly in others, are constantly for retraining their blessings within their own little circle, and delight more in augmenting the train of their dependants than in adding to the rank of fellow-citizens, or in diffusing the benefits of freedom among their neighbours."

Having given this ample detail of the rise and progress of slavery in the world, and shown that it has prevailed in every age, and under all religions, we shall now proceed to enquire whether a practice so general be in any instance lawful; and if it be, how it must be modified, in order to be rendered consistent with the rights of man and the immutable laws of virtue. ^{The lawfulness of slavery inquired into.}

That in a state of nature one man has a right to seize upon another, and to compel him by force to labour for his subsistence, is a position which we believe has never been seriously maintained. But independent communities stand to each other in the very same relation that individuals do in a state of nature; and therefore if in such a state the man of greater bodily strength or mental sagacity would have no right to convert his weaker neighbour into personal property, neither can the more powerful and enlightened nation have a right to carry off by force, or entice by fraud, the subjects of a weaker and more barbarous community for the purpose of reducing them to a state of servitude. This is a truth so obvious as to admit neither of proof nor of denial.

In thus stating the case between two independent nations, we have in our eye that traffic in slaves which is carried on between the civilized Europeans and the barbarous Africans; and the utmost length which we think an apology for that trade can go is to contend, that we may lawfully purchase slaves in those countries where from time immemorial they have been a common branch of commerce. But the European right to purchase cannot be better than the African right to sell; and we have never yet been informed what gives one African a right to sell another. Such a right cannot be natural, for the reason which we have elsewhere assigned (see RIGHT): neither can it be adventitious; for adventitious rights are immediately derived from the municipal law, which is the public will of the state. But the state has no authority to deprive an innocent man of his personal freedom, or of the produce of his own labour; for it is only to secure these, by protecting the ^{weak}

(M) In Barbadoes there is said to be a law for the protection of slaves, which is the most insolent trilling with justice and humanity that the writer of this article has ever seen. It is enacted, forsooth, "That if any man shall, of wantonness, or only of bloody-mindedness, or cruel intention, wilfully kill a negro or other slave, if his own, he shall pay into the public treasury *£500* pounds sterling!" See *Dickson's Letters on Slavery*, p. 4.

Slavery. weak from the violence of the strong, that states are formed, and individuals united under civil government.

It may perhaps be said, that by patiently submitting to governments which authorize the trade in human flesh, men virtually give up their personal liberty, and vest their governors with a right to kill them as slaves: but no man can vest another with a right which he possesses not himself; and we shall not hesitate to affirm, that in a state of nature where all have equal rights, no individual can submit himself to the absolute disposal of another without being guilty of the greatest crime. The reason is obvious. From the relation in which men stand to one another as fellow creatures, and to God as their common Creator, there are duties incumbent upon each peculiar to himself: in the performance of which he can be guided only by his own reason, which was given him for that very purpose. But he who renounces his personal freedom, and submits unconditionally to the caprice of a master, implicitly attempts to set himself free from the obligation of that law which is interwoven with his very being, and chooses a director of his conduct different from that which God has assigned him. A man therefore cannot put himself in a state of unconditional servitude: and what he cannot do for himself, he surely cannot authorize others to do for him either by a tacit or by an open consent.

These considerations have often made us regret that writers, for whose talents and integrity we have the highest respect, should, without accurately defining what they mean by slavery, have presumptuously affirmed, that, consistently with the law of nature men may be reduced to that state as a punishment for crimes, or to discharge debts which they cannot otherwise pay. That a criminal, who has forfeited his life to the laws of his country, may have his punishment commuted for hard labour, till death in the course of nature shall put a period to his terrestrial existence, is a truth which we apprehend cannot be controverted: but to make such a commutation of punishments consistent with the laws of nature and of nature's God, it appears to us that the kind and degree of labour must be precisely ascertained, and the conduct of the criminal not left to the capricious direction of any individual.

Punishments can be justly inflicted only for one or other of two ends, or for both. They may be calculated either to reform the criminal or to be a warning to the innocent; and those which most effectually answer both these purposes are surely to be preferred to such as answer but one of them. For this reason we consider hard labour as a much sorer punishment for most crimes than death: but to entitle it to preference, the kind and degree of the labour must be determined by the law: for if the circumstances be not defined, and the offender delivered over to a slave to the absolute disposal and caprice of a single master, the labour to which he is condemned, instead of a penalty to his reformation, may be converted into the means of rendering him to the commission of new crimes. A man who, even in the state of liberty, we should be glad to see his private virtue against the attacks of a man who would promise her liberty on a condition of still remaining subject to his desires, and the fulfilment of which she has accustomed to a life of perpetual and filthy slavery, would

not strenuously object to the perpetration of any wickedness to obtain his freedom, or even a diminution of his daily task. Indeed such temptations might be thrown in his way, as human nature could not resist; but by means of much better principles than felons can be supposed to possess. He might be scourged into compliance, or his labour might be so increased as to make him for a little respite eagerly embrace the most nefarious proposal which his master could make: for being absolute property, there is no earthly tribunal to which he could appeal for justice; and felons do not commonly support themselves under trials by pious meditations on a future state.

By reasoning in this way, we are far from meaning to impute that itive-holders in general torture their faces into the commission of crimes. God forbid! Many of them we know to be religious, humane, and benevolent: but they are not infallible; and some of them may be intigated, some of them unduly have been intigated, by avarice and other world principles, to compel creatures, who are so absolutely their dependents, to execute deeds of darkness too hazardous for themselves. But the morality or immorality of any action, and the moral fitness of any state, are to be judged of by their natural tendency; if the one were universally practised and the other universally prevalent (see MORAL PHILOSOPHY, N^o 136. 3.) and as the natural tendency of absolute domestic slavery among such creatures as men is to throw the most powerful temptations to vice in the way both of master and of slave, it must be in every instance, even when employed as a punishment, inconsistent with the fundamental principles of moral virtue.

Some writers indeed have maintained, and the civil law seems to suppose, that children are the property of their parents, and may by them be sold as slaves in cases of urgent necessity: but if we duly consider how property is acquired (see PROPERTY), and attend to the natural consequences of slavery, we shall soon be convinced that this opinion is very ill founded. The rights of parents result from their duties: and it is certainly the duty of that man who has been the instrument of bringing into the world an intellectual and moral being, to do every thing in his power to render the existence of that being happy both in the present life and in that which is to come. If this duty be conscientiously discharged, the parent has a manifest right to the gratitude, love, and reasonable obedience, of his child; but he cannot, in consequence of any duty performed, claim a right to transfer that child as property to the uncontradicted disposal of any private master: for this plain reason, that the man who is considered as the private property of another cannot reasonably be supposed to enjoy happiness in this world, and is under many temptations to do what must necessarily render him miserable in the next. (See MORAL PHILOSOPHY, N^o 138.)

It is only in cases that lawfully reduce us to a state of absolute slavery, that slavery, much less surely can it be justified, rendered tolerable, and purchasers of war to man slaves. A man who is in one, who has contracted himself to sell himself of paying then, has been a slave to the law of his nature, his duty, or the necessities of others; of whom he was never separated, and he is not to be sold. Such a man is not a slave, and he is not to be sold. He is not to be sold, and he is not to be sold. He is not to be sold, and he is not to be sold.

No man has a right to give himself up to the absolute disposal of another.

What kind of slavery may be employed as a punishment.

Slavery. well as shockingly cruel, to add to his misfortune by reducing him to a state to which we have just seen that the vilest felon cannot be reduced without a violation of the laws of morality. Fraudulent bankrupts indeed, of whom we daily see many, might with great propriety and the strictest justice be compelled to extenuate their debts by labouring for the benefit of those whom they have injured; and criminals of other descriptions might be made to work for the benefit of the public: but in both cases the task to be performed should be ascertained by the law, and the persons of the labourers be protected by the state. If such can be called slaves, their slavery is undoubtedly consistent with every principle of virtue and religion; for they suffer nothing but the due reward of their deeds. Prisoners of war, however, can upon no honest principle be reduced even to this state of mitigated bondage; for they are so far from incurring guilt by fighting for their country, that even to their enemies their courage and conduct in such a cause must appear worthy of reward. A victorious general has certainly a right to prevent the prisoners taken in battle from again drawing their swords against him during the continuance of the war; but there are many ways by which this may be done effectually without chaining the unfortunate captives to the oar, or selling them like cattle to private purchasers, by whom they may be treated with capricious cruelty, and driven to the perpetration of the greatest crimes.

To these conclusions, and the reasoning on which they are built, we are aware it may be objected, that if private slavery were in every instance unlawful and inconsistent with the fundamental principles of morality, it would not have prevailed among the ancient patriarchs, and far less have been authorized by the Jewish law.

In reply to this objection, it may be observed, that Abraham, Isaac, and Jacob, though excellent men, were not characters absolutely perfect; that as their practice does not authorize polygamy or incest among us, it will not authorize the reducing of our fellow-creatures to a state of hopeless servitude; and that from the circumstances of the age in which they lived, many things were permitted to them, and were indeed harmless, which are forbidden to us, and would now be pernicious. The character of Abraham appears to have been much more perfect than that of his son or grandson; and was certainly equal, if not superior, to that of any other mere man of whom we read either in profane or even in sacred history. We are to remember, however, that he was born amidst idolaters, and was probably an idolater himself till enlightened by the inspiration of Jehovah, and called from his kindred and from his father's house. Before his conversion, he must have had much cattle and many slaves, which constituted the riches of that early period; and his case would indeed have been peculiarly hard, had he been commanded to divest himself of his servants, and to depart into a strange country very thinly inhabited, without people to protect his flocks and herds from beasts of prey. Nor would his loss have contributed in any degree to the benefit of his slaves, who, as the ranks of men were then adjusted, could not long have preserved their liberty. Had they not been forcibly reduced to their former state by their idolatrous countrymen, which in all probability they would have been, they must have soon submitted to it, or perished

by hunger. Let it be remembered, too, that the bond-servants of Abraham, though constituting the most valuable part of his property, were not considered as a species of inferior beings, but were treated rather as children than as slaves. This is evident from his speaking of the steward of his house as his heir, when complaining to God of the want of seed. Indeed the manner in which this circumstance is mentioned, shows that it was then the general practice to consider domestic slaves as members of the family; for the patriarch does not say, "I will leave my substance to this Eliezer of Damascus;" but his words are, "Behold to me thou hast given no seed; and lo, one born in my house is my heir."* Gen. xv. From this mode of expression we are strongly inclined to think that captives taken in war were in that age of simplicity incorporated into the family or tribe of the conqueror, as they are said to be at present among the North American Indians, to supply the place of those who had fallen in battle. If so, slavery was then a very mild thing, unattended with the evils which are now in its train, and must often have been highly beneficial to the captive.

The other part of the objection appears at first sight more formidable: but perhaps a little attention to the design of the Mosaic economy may enable us to remove it even more completely than this. We need not inform our theological readers, that one great purpose for which the posterity of Abraham were separated from the heathen nations around them, was to preserve the knowledge of the true God in a world run headlong into idolatry. As idolatry appears to have had something in its forms of worship extremely captivating to rude minds, and as the minds of the Israelites at the era of their departure from Egypt were exceedingly rude, every method was taken to keep their separation from their idolatrous neighbours as complete as possible. With this view they were commanded to sacrifice the animals which their Egyptian masters had worshipped as gods, and were taught to consider hogs and such other creatures as the heathen offered in sacrifice, when celebrating their mystical and magic rites, as too unclean to be eaten or even to be touched. Of this distinction between clean and unclean beasts, God himself assigns the reason: "I am the Lord thy God (says he), who have separated you from other people; ye shall therefore put difference between clean and unclean beasts, and between unclean fowls and clean."† Lev. x. For the same reason they were prohibited from inter-marrying with the heathen, or having any transaction whatever with them as neighbours; and the seven idolatrous nations of Canaan they were strictly commanded to exterminate. "When the Lord thy God (says Moses) shall deliver them before thee, thou shalt smite them, and utterly destroy them: thou shalt make no covenant with them, nor show mercy unto them: neither shalt thou make marriages with them: thy daughter thou shalt not give unto his son, nor his daughter shalt thou take to thy son; for they will turn away thy son from following me, that they may serve other gods."‡ Deut. vii.

Under these laws, it is plain that no intercourse whatever could have place between an Israelite and a man of any other nation, unless the latter was reduced to such a state that he could neither tempt the former, nor practise himself the rites of his idolatrous worship.

Slavery.
Slave-trade.

But the Israelites were not separated from the rest of the world for their own sakes only: They were intended to be the repositories of the lively oracles of God, and gradually spread the light of divine truth through other nations, till the fulness of time should come, when in Christ all things were to be gathered together in one. To answer this end, it was necessary that there should be some intercourse between them and their Gentile neighbours; but we have seen that such an intercourse could only be that which subsists between masters and their slaves.

Should this apology for the slavery which was authorized by the Jewish law be deemed fanciful, we beg leave to submit to the consideration of our readers the following account of that matter, to which the same objection will hardly be made. It was morally impossible that between nations differing so widely in religion, customs, and manners, as the Jews and Gentiles, peace should ever reign without interruption; but when wars broke out, battles would be fought, and prisoners would be taken. How were these prisoners to be disposed of? Carrels for exchange were not then known: it was the duty of the Israelites to prevent their captives from taking up arms a second time against them; they could not establish them among themselves either as artificers or as husbandmen; for their law enjoined them to have no communication with the heathen. There was therefore no other alternative but either to massacre them in cold blood, or to reduce them to the condition of slaves. It would appear, however, that those slaves were raised to the rank of citizens, or at least that their burdens were much lightened, as soon as they were convinced of the truth of the Mosaic revelation, and received into covenant with God by the rite of circumcision. They were then admitted to the celebration of the passover; concerning which one law was decreed to the stranger, and to him that was home-born. Indeed, when we consider who was the legislator of the Jews; when we reflect upon the number of laws enacted to mitigate slavery among them, and call to mind the means by which the due execution of all their laws was enforced, (see THEOLOGY), we cannot help being of opinion that the heathen, who was reduced to slavery in Judea, might be happier, if he pleased, than when living as a freeman in his own country. But whether this be so or not, is a matter with which we have no concern. On account of the hardness of their hearts, and the peculiarity of their circumstances, many things, of which slavery may have been one, were permitted to the Jews, which, if practised by Christians, would render them highly guilty.

After treating thus largely of slavery in general, we need not occupy much of the reader's time with the

the government as a source of national and colonial wealth, was from its commencement considered by the thinking part of the nation as a traffic inconsistent with the rights of man, and suspected to be carried on by acts of violence. These suspicions were gradually spread through the people at large, and confirmed, in many instances, by evidence incontrovertible. Laws were in consequence enacted to make the negroes more comfortable on what is called the middle passage, and to protect them against the wanton cruelty of their masters in the West Indies: but the humanity of the nation was roused; and not many years ago a number of gentlemen of the most respectable characters, finding that no adequate protection could be afforded to persons in a state of hopeless servitude, formed themselves into a society at London, for the purpose of procuring a total abolition of the slave-trade. That the motives which influenced the leading men of this society were of the purest kind, cannot, we think, be questioned; for their object was to deliver those who had none to help them, and from whom they could expect no other reward for their labours of love than the blessings of them who were ready to perish. To a cause truly Christian, who did not pray for success? or who but must have felt the most pungent regret, if that success had been rendered doubtful, or even delayed, by the imprudence of some of the agents employed by the society? This we apprehend was really the case. Language calculated only to exasperate the planters could not serve the negroes; and the legislature of Great Britain would never suffer itself to be forced into any measure by the menaces of individuals.

In the year 1793, petitions were presented to parliament for the abolition of this inhuman traffic, which gave a pleasing picture of the philanthropy of the nation; but, unfortunately for the cause of freedom, it was discovered that many of the names subscribed to those petitions had been collected by means not the most honourable. The discovery, perhaps, would never have been made, had not the insulting epithets indiscriminately heaped upon the slave holders provoked those men to watch with circumspection over the conduct of their opponents. The consequence was, that suspicions of unfair dealing on the part of the petitioners were excited in the breasts of many who, though they ardently wished well to the cause, chose not to add their names to those of school-boys under age, and of peasants who knew not what they were subscribing. Let the rights of the Africans be maintained with ardour and firmness; but never let their advocates suppose that the cause of humanity requires the support of artifice. Absolute slavery, in which the actions of one man are regulated by the caprice of another, is a state demonstrably inconsistent with the obvious plan of the moral government of the world. It degrades the mental faculties of the slave, and throws, both in his way and in his master's, temptations to vice almost insurmountable. Let these truths be set in a proper light by those who have doubtless seen them exemplified; and they will surely have their full effect on the minds of a generous, and, we trust, not an impious people (N). The trade will be generally abolished; pains will be taken

Slave-trade.

25
Petitioners
for the abolition
of the slave-trade.

24
Slave-trade.

SLAVE-TRADE carried on by the merchants of Europe with the natives of Africa. It is well known that the Portuguese were the first Europeans who embarked in this trade, and that their example was soon followed by the Dutch and the English. Of the rise and progress of the English commerce in slaves, the reader will find a sufficient account in other articles of this work †. That commerce, though long cherished by

ken

† See Company, and
Commerce.

(N) We have not insisted upon the impolicy of the slave trade, or endeavoured to prove that its abolition would

ken to cultivate the minds of the West Indian negroes; and the era may be at no great distance when slavery shall cease through all the British dominions.

But what benefit, it will be asked, will the negroes of Africa reap from an abolition of the slave trade? Should any thing so wildly incredible happen, as that all the nations of Christendom, in one common paroxysm of philanthropy, should abandon this commerce in servants, which has been prosecuted in all ages, and under all religions; they would only abandon it to those who were originally possessed of it, who still penetrate into the country, and who even push up to Gago at the very head of the Slave coast; and leave the wool-headed natives of it to Mahometan masters, in preference to Christian. Under such masters they were in Judea at the time of the crusades. Under such, as we learn from Messrs Sanguier, Bifson, and others, they still are in the deserts of Africa, as well as in the islands of Johanna and Madagascar; and it is universally known that they enslave one another as a punishment for the most whimsical crimes. Among them, indeed, slavery seems to be reduced to a system, and to descend, as it has done in more polished nations, from father to son; for both Sanguier and Wadstrom speak of particular families of negroes who are exempted from that degrading state by the laws of the country.

All this we admit to be true. Most certainly the negroes would not be exempted from the miseries of servitude, though Europe and the West Indies were swallowed up in the ocean. The *customs* of the country, as the king of Dahomy assured Mr Abson †, will be made as long as black men shall continue to possess their own territories, in their present state of depravity and ignorance; and these customs appear to involve slavery of the cruellest kind. But if slavery be in itself unlawful, is it a sufficient excuse for our continuing the traffic that it is carried on by the rude negroes and the savage Arabs? Are people, whom we sometimes affect to consider as an inferior order of beings, to furnish examples of conduct to those who boast of their advancements in science, in literature, and in refinement? Or will the benevolent Lord of all things pardon us for oppressing our helpless brethren, merely because they are cruelly oppressed by others? It is indeed true that the natives of Guinea cannot be made really free but by introducing among them the blessings of religion and the arts of civil life; but surely they would have fewer

temptations than at present to kidnap one another, or to commence unprovoked wars for the purpose of making captives, were the nations of Europe to abandon the commerce in slaves (¶). That commerce, we grant, would be continued by the Arabs, and perhaps by others of the eastern nations; but the same number of people could not be carried off by them alone that is now carried off both by them and by the Europeans.

Were it indeed possible to put the slave-trade under proper regulations, so as to prevent all kidnapping and unjust wars among the Africans, to supply the markets; and were it likewise possible to ensure to the negroes in the West Indies mild treatment and religious instruction; we are far from being sure that while the natives of Guinea continue so rude, and their neighbours the Arabs so selfishly savage, it would be proper to abandon at once to hordes of barbarians the whole of this commerce in bond servants. "The trade, which in its present form is a reproach to Britain, might be made to take a new shape, and become ultimately a blessing to thousands of wretches who, left in their native country, would have dragged out a life of miserable ignorance, unknowing the hand that framed them, unconscious of the reason of which they were made capable, and heedless of the happiness laid up for them in store †."

Slavery is, indeed, in every form an evil; but it seems to be one of those many evils which, having long prevailed in the world, can be advantageously removed only by degrees, and as the moral cultivation of the slaves may enable them to support the rank and discharge the duties of free men. This is doubtless the reason why it was not expressly prohibited by the divine Author of our religion, but suffered to vanish gradually before the mild influence of his Heavenly doctrines. It has vanished before these doctrines in most countries of Europe; and it affords us no small gratification to have it in our power to record, what indeed must be fresh in the memory of our readers, that the abolition of the slave-trade was finally accomplished by the steady perseverance and generous exertions of some of the most enlightened and respectable characters in the kingdom, who, after a long and arduous struggle, obtained a decree of the legislature, prohibiting, after a limited period, the trade in slaves to be continued by subjects of Britain. The bill originated in the house of lords, and having undergone considerable discussion in the house of commons, finally passed on the 16th of March, and received his majesty's assent

would be *advantageous* to the sugar planters; for the planters surely understand their own interest better than those can do, who, having never been in the West Indies, are obliged to content themselves with what information they can glean on the subject from a number of violent and contradictory publications. To countenance slavery under any form is undoubtedly immoral. This we know; and therefore upon this ground have we opposed the slave-trade, which cannot be countenanced without preferring interest to virtue.

(¶) In a speech which Mr Dalzel says the king of Dahomy made to Mr Abson, when he was informed of what had passed in England on the subject of the slave-trade, are these remarkable words: "In the name of my ancestors and myself, I aver that no Dahoman ever embarked in war merely for the sake of procuring wherewithal to purchase our commodities." We must take the liberty to question the truth of this solemn avowment. That the slave-trade is not the *sole* cause of the Dahoman was every man will admit, who does not fancy that those people have neither passions nor appetites, but for the commodities of Europe; but the bare affirmation of this bloody despot, who boasted of having killed many thousands at the *costume*, will not convince those who have read either Wadstrom's Essay on Colonization, or the evidence respecting the slave-trade given at the bar of the House of Commons, "that no Dahoman ever embarked in war merely to procure slaves to barter for European commodities."

Slave-trade.

36
Objection to the abolition.

37
Mistake
Reference to
Vol. II.

38
Reference to
Vol. II.

39
Reference to
History.

40
Reference to
History.

Slave-trade.

38
Reference to
History, &c.

38
Reference to
History, &c.

Slave-trade
||
Sleep-walker.

affent on the 23th March 1807. The time fixed by the bill, for the total abolition of the trade, we believe, was the beginning of the following year, viz. January 1808.

We cannot conclude without expressing a hope, that the period is not very distant when the slaves in the West Indies shall be so much improved in moral and religious knowledge, as that they may be safely trusted with their own freedom. To let them free in their present state of ignorance and depravity, is one of the wildest proposals that the ardour of innovation has ever made. Such freedom would be equally ruinous to themselves and to their masters; and we may say of it what Cicero said of some unseasonable indulgences proposed to be granted to the slaves in Sicily: *Quæ cum accidit, nemo est, qui intelligat errore illam rempublicam; hæc ubi veniunt, nemo est, qui illam spem salutis reliquam esse arbitretur.*

Those of our readers who wish to enter into a detail of this subject, may consult, with much advantage, The History of the Rise, Progress, and Accomplishment of the Abolition of the African Slave-Trade, by Mr Clarkson, 2 vols 8vo.

S LAUGHTER. See MANS LAUGHTER, HOMICIDE, MURDER, &c.

SLEDGE, a kind of carriage, without wheels, for the conveyance of very weighty things, as huge stones, bells, &c. The sledge for carrying criminals, condemned for high treason, to execution, is called **HURDLE.** The Dutch have a kind of sledge on which they can carry a vessel of any burden by land. It consists of a plank of the length of the keel of a moderate ship, raised a little behind, and hollow in the middle: so that the sides go a little alope, and are furnished with holes to receive pins, &c. The rest is quite even.

SLEDGE is a large smith's hammer, to be used with both hands: of this there are two sorts, the up-hand sledge, which is used by under workmen, when the work is not of the largest sort; it is used with both the hands before, and they seldom raise it higher than their head. But the other, which is called the about-sledge, and which is used for battering or drawing out the largest work, is held by the handle with both hands, and swung round over their heads, at their arm's end, to strike as hard a blow as they can.

SLEEP, that state of the body in which, though the vital functions continue, the senses are not affected by the ordinary impressions of external objects. See DREAMS and PHYSIOLOGY.

SLEEP-Walker, one who walks in his sleep. Many instances might be related of persons who were addicted to this practice; but it will be sufficient to select one remarkable instance from a report made to the Physical Society of Louanne, by a committee of gentlemen appointed to examine a young man who was accustomed to walk in his sleep.

"The disposition to sleep-walking seems, in the opinion of this committee, to depend on a smart, or affection of the nerves, which both seizes and lets go the patient during sleep. Under the influence of this affection, the imagination represents to him the objects that struck him while awake, with as much force as if they really affected his senses; but does not make him receive any of those that are actually presented to his senses, except in so far as they are connected with the

dreams which engross him at the time. If, during this state, the imagination has no determined purpose, he receives the impression of objects as if he were awake; only, however, when the imagination is excited to bend its attention towards them. The perceptions obtained in this state are very accurate, and, when once received, the imagination renews them occasionally with as much force as if they were again acquired by means of the senses. Lastly, these academicians suppose, that the impressions received during this state of the senses disappear entirely when the person awakes, and do not return till the return of the same disposition in the nervous system.

"Their remarks were made on the Sieur Devaud, a lad thirteen years and a half old, who lives in the town of Vevey, and who is subject to that singular affection or disease called *Somnambulism* or sleep-walking. This lad possesses a strong and robust constitution, but his nervous system appears to be organized with peculiar delicacy, and to discover marks of the greatest sensibility and irritability. His senses of smell, taste, and touch, are exquisite; he is subject to fits of immoderate and involuntary laughter, and he sometimes likewise weeps without any apparent cause.

"This young man does not walk in his sleep every night; several weeks sometimes pass without any appearance of a fit. He is subject to the disease generally two nights successively, one fit lasting for several hours. The longest are from three to four hours, and they commonly begin about three or four o'clock in the morning.

"The fit may be prolonged, by gently passing the finger or a feather over his upper lip, and this slight irritation likewise accelerates it. Having once fallen asleep upon a chair, his upper lip was thus irritated with a feather, when he immediately ran down the steps with great precipitation, and resumed all his accustomed activity. This experiment was repeated several times.

"The young Devaud thinks he has observed, that, on the evenings previous to a fit, he is sensible of a certain heaviness in his head, but especially of a great weight in his eyelids.

"His sleep is at all times unquiet, but particularly when the fits are about to seize him. During his sleep, motions are observable in every part of his body, with fluttering and palpitations; he utters broken words, sometimes sits up in his bed, and afterwards lies down again. He then begins to pronounce words more distinctly, he rises abruptly, and acts as he is impelled by the dream that then possesses him. He is sometimes in sleep subject to continued and involuntary motions.

"The departure of the fit is always preceded by two or three minutes of calm sleep, during which he moans. He then awakes rubbing his eyes like a person who has slept quietly.

"It is dangerous to awaken him during the fit, especially if it is done suddenly; for then he sometimes falls into convulsions. Having risen one night with the intention of going to cut grapes, he left the house, passed through the town, and went to a vineyard where he expected to find them. He was followed by several persons, who kept at some distance from him, one of whom fired a pistol, the noise of which instantly awakened him, and he fell down without sense. He was carried home and brought to himself, when he recollected very well the

Sleep-walker.

having been awakened in the vineyard; but nothing more, except the fright at being found there alone, which had made him swoon.

"After the fits he generally feels a degree of lassitude; sometimes, though rarely, of indispotion. At the end of one of those fits, of which the gentlemen of the committee were witnesses, he was affected with vomitings; but he is always soon restored.

"When he is awakened, he never for the most part recollects any of the actions he has been doing during the fit.

"The subject of his dreams is circumscribed in a small circle of objects, that relate to the few ideas with which at his age his mind is furnished; such as his lessons, the church, the bells, and especially tales of ghosts. It is sufficient to strike his imagination the evening before a fit with some tale, to direct his somnambulism towards the object of it. There was read to him while in this situation the story of a robber; he imagined the very next moment that he saw robbers in the room. However, as he is much disposed to dream that he is surrounded with them, it cannot be affirmed that this was an effect of the reading. It is observed, that when his supper has been more plentiful than usual, his dreams are more dismal.

"In their report, the gentlemen of the committee dwell much on the state of this young man's senses, on the impression made upon them by strange objects, and on the use they are of to him.

"A bit of strong smelling wood produced in him a degree of rattlefolds; the fingers had the same effect, whether from their smell or their transpiration. He knew wine in which there was wormwood by the smell, and said that it was not wine for his table. Metals make no impression on him.

"Having been presented with a little common wine while he was in a state of apathy, and all his motions were performed with languor, he drank of it willingly; but the irritation which it occasioned produced a deal of vivacity in all his words, motions, and actions, and caused him to make involuntary grimaces.

"Once he was observed dressing himself in perfect darkness. His clothes were on a large table, mixed with those of some other persons; he immediately perceived this, and complained of it much; at last a small light was brought, and then he dressed himself with sufficient precision. If he is teased or gently pinched, he is always sensible of it, except he is at the time strongly engrossed with some other thing, and wishes to strike the offender; however, he never attacks the person who has done the ill, but an ideal being whom his imagination presents to him, and whom he pursues through the chamber without running against the furniture, nor can the persons whom he meets in his way divert him from his pursuit.

"While his imagination was employed on various subjects, he heard a clock strike, which repeated at every stroke the note of the cuckoo. There are cuckoos here, said he; and, upon being desired, he imitated the song of that bird immediately.

"When he wishes to see an object, he makes an effort to lift his eyelids; but they are so little under his command, that he can hardly raise them a line or two, while he draws up his eyebrows; the iris at that time appears fixed, and his eye dim. When any thing is

presented to him, and he is told of it, he always half opens his eyes with a degree of difficulty, and then shuts them after he has taken what was offered to him.

Sleep-walker.

"The report inferences from these facts, and from many others relative to the different senses, that their functions are not suspended as to what the sleep-walker wishes to see, that is, as to all those perceptions which accord with the objects about which his imagination is occupied; that he may also be disposed to receive those impressions, when his imagination has no other object at the time; that in order to see, he is obliged to open his eyes as much as he can, but when the impression is once made, it remains; that objects may strike his sight without striking his imagination, if it is not interred in them; and that he is sometimes informed of the presence of objects without either seeing or touching them.

"Having engaged him to write a theme, say the committee, we saw him light a candle, take pen, ink, and paper, from the drawer of his table, and begin to write, while his master dictated. As he was writing, we put a thick paper before his eyes, notwithstanding which he continued to write and to form his letters very distinctly; showing signs, however, that something was incommoding him, which apparently proceeded from the obstruction which the paper, being laid too near his nose, gave to his respiration.

"Upon another occasion, the young somnambulist arose at five o'clock in the morning, and took the necessary materials for writing, with his copy-book. He meant to have begun at the top of a page; but finding it already written on, he came to the blank part of the leaf, and wrote some time from the following words, *Fiant ignari pigritia—His deviant ignonans par la parole*; and, what is remarkable, after several lines he perceived he had forgot the *s* in the word *ignonans*, and had put erroneously a double *r* in *parole*; he then gave over writing, to add the *s* he had forgotten, and to erase the superfluous *r*.

"Another time he had made, of his own accord, a piece of writing, in order, as he said, to please his master. It consisted of three kinds of writing, text, half text, and small writ; each of them performed with the proper pen. He drew, in the corner of the same paper, the figure of a hat; he then asked for a penknife to take out a blot of ink which he had made between two letters, and he erased it without injuring them. Lastly, he made some arithmetical calculations with great accuracy.

"In order to explain some of the facts observed by the academicians which we have here mentioned, they establish two general observations, which result from what they have said with respect to the senses and the dreams of this sleep-walker.

"1. That he is obliged to open his eyes, in order to recognise objects which he wishes to see; but the impression once made, although rapidly, is vivid enough to supersede the necessity of his opening them again, to view the same objects anew; that is, the same objects are afterwards presented to his imagination with as much force and precision as if he actually saw them.

"2. That his imagination, thus warmed, represents to him objects, and such as he figures to himself, with a much vivacity as if he really saw them; and, lastly, that all his senses, being subordinate to his imagination,

feet.

Sleep-walker.

seem concentrated in the object with which it is occupied, and have at that time no perception of any thing but what relates to that object.

These two causes united seem to them sufficient for explaining one of the most singular facts that occurred to their observation, to wit, how the young Devaud can write, although he has his eyes shut, and an obstacle before them. His paper is imprinted on his imagination, and every letter which he means to write is also pointed there, at the place in which it ought to stand on the paper, and without being confounded with the other letters; now it is clear that his hand, which is obedient to the will of his imagination, will trace them on the real paper, in the same order in which they are represented on that which is pictured in his head. It is thus that he is able to write several letters, several sentences, and entire pieces of writing; and what seems to confirm the idea, that the young Devaud writes according to the paper painted on his imagination is, that a certain sleep-walker, who is described in the French *Encyclopædie* (article *Sonnambulisme*), having written something on a paper, another piece of paper of the same size was substituted in its stead, which he took for his own, and made upon this blank paper the corrections he meant to have made on the other which had been taken away, precisely in the places where they would have been.

It appears from the recital of another fact, that Devaud, intending to write at the top of the first leaf of a white paper book, *Vevey*, *le*—stopped a moment as if to recollect the day of the month, left a blank space, and then proceeded to *December 1787*; after which he asked for an almanac; a little book, such as is given to children for a new year's gift, was offered to him; he took it, opened it, brought it near his eyes, then threw it down on the table. An almanac which he knew was then presented to him; this was in German, and of a form similar to the almanac of *Vevey*: he took it, and then said, 'What is this they have given me; here, there is your German almanac.' At last they gave him the almanac of *Berne*; he took this likewise, and went to examine it at the bottom of an alcove that was perfectly dark. He was heard turning over the leaves, and saying 24, then a moment afterwards 23. Returning to his place, with the almanac open at the month of *December*, he laid it on the table and wrote in the space which he had left blank the 24th. This scene happened on the 23d; but as he imagined it to be the 24th, he did not mistake. The following is the explanation given of this fact by the authors of the report.

'The dates 23d, 24th, and 25th, of the month of *December*, had long occupied the mind of the young Devaud. The 23d and 25th were holidays, which he expected with the impatience natural to persons of his age, for the arrival of those moments when their little daily labours are to be suspended. The 24th especially was the object of his hopes: there was to be an illumination in the church, which had been deferred to him in a manner that quite transported him. The 24th was a day of labour, which came very disagreeably between the two happy days. It may easily be conceived, how an imagination so irritable as that of the young Devaud would be struck with those pleasing prospects. Accordingly, from the beginning of the month

Sleep-walker.

he had been perpetually turning over the almanac of *Vevey*. He calculated the days and the hours that were to elapse before the arrival of his wished-for holidays; he showed to his friends and acquaintance the dates of those days which he expected with so much impatience; every time he took up the almanac, it was only to consult the month of *December*. We now see why that date presented itself to his mind. He was performing a task, because he imagined the day to be the *Monday* which had so long crossed him. It is not surprising, that it should have occurred to his imagination, and that on opening the almanac in the dark he might have thought he saw this date which he was seeking, and that his imagination might have represented it to him in as lively a manner as if he had actually seen it. Neither is it surprising that he should have opened the almanac at the month of *December*; the custom of perusing this month must have made him find it in the dark by a mere mechanical operation. Man never seems to be a machine so much as in the state of *sonnambulisme*; it is then that habit comes to supply those of the senses that cannot be serviceable, and that it makes the person act with as much precision as if all his senses were in the utmost activity. These circumstances destroy the idea of there being any thing miraculous in the behaviour of young Devaud with respect to the date and the month that he was in quest of; and the reader, who has entered into our explanations, will not be surprised at his knowing the German almanac; the touch alone was sufficient to point it out to him; and the proof of this is the shortness of the time that it remained in his hands.

An experiment was made by changing the place of the ink-stand during the time that Devaud was writing. He had a light beside him, and had certified himself of the place where his ink-holder was standing by means of sight. From that time he continued to take ink with precision, without being obliged to open his eyes again; but the ink-stand being removed, he returned as usual to the place where he thought it was: It must be observed, that the motion of his hand was rapid till it reached the height of the standish, and then he moved it slowly, till the pen gently touched the table as he was seeking for the ink: he then perceived that a trick had been put on him, and complained of it; he went in search of his ink-standish and put it in its place. This experiment was several times repeated, and always attended with the same circumstances. Does not what we have here related prove, that the standish, the paper, the table, &c. are printed on his imagination in as lively a manner as if he really saw them, as he sought the real standish in the place where his imagination told him it ought to have been? Does it not prove that the same lively imagination is the cause of the most singular actions of this sleep-walker? And lastly, does it not prove, that a mere glance of his eye is sufficient to make his impressions as lively as durable?

The committee, upon the whole, recommend to such as wish to repeat the same experiments, 1. To make their observations on different sleep-walkers. 2. To examine often whether they can read books that are unknown to them in perfect darkness. 3. To observe whether they can tell the hours on a watch in the dark. 4. To remove when they write the ink-standish from its place, to see whether they will return to the same place

Sleep-walker
Sleswick

in order to take ink. 5. And, lastly, to take notice whether they walk with the same confidence in a dark and unknown place, as in one with which they are acquainted.

"They likewise recommend to such as would confirm or invalidate the above observations, to make all their experiments in the dark; because it has been hitherto supposed that the eyes of sleep-walkers are of no use to them."

SLEEPERS, in *Natural History*, a name given to those animals which sleep all winter; such as bears, marmots, dormice, bats, hedgehogs, swallows, &c. These do not feed in winter, have no sensible evacuations, breathe little or none at all, and most of the viscera cease from their functions. Some of these animals seem to be dead, and others return to a state like that of the fetus before birth: in this state they continue, till by an increase of heat the animal is restored to its former functions.

SLEEPERS, in a ship, timbers lying before and aft in the bottom of the ship, as the ruygheads do: the lowermost of them is bolted to the ruygheads, and the uppermost to the futtocks and ruygs.

SLEIDAN, JOHN, an excellent German historian, born of obscure parents, in 1506, at Sleidan, a small town on the confines of the duchy of Juliers. After studying some time in his own country, together with his townsman the learned John Sturmius, he went to France, and in 1525 entered into the service of the cardinal and archbishop John du Bellay. He retired to Strauburg in 1542, where he acquired the esteem and friendship of the most considerable persons, particularly of James Sturmius; by whose advice and assistance he was enabled to write the history of his own time. He was employed in some public negotiations; but the death of his wife, in 1555, plunged him into so deep a melancholy, that he lost his memory entirely, and died the year following. In 1555 came out, in folio, *De statu Religionis et Republice sub Carolo Quinto*, &c. in 15 books; from the year 1517, when Luther began to preach, to the year of its publication; which history was presently translated into most of the languages of Europe. Besides this great work, he wrote, *De quatuor summis Imperiis, libri tres*; with some other historical and political pieces.

SLEIGHT OF HAND. See **LEGERDEMAIN**.

SLESWICK, an ancient and considerable town of Denmark, the metropolis of a duchy of the same name, in the province of Gottorp, the see of a bishop, which was secularized in the year 1586. The old palace of Gottorp is close to it, which was formerly the ducal residence, but afterwards inhabited by the governor. This town at one period was much more extensive than it is now, having suffered greatly by the German wars. It is seated on the gulf of Sley, where there is a commodious harbour, 60 miles north-west of Lubeck, and 125 south-west of Copenhagen. The people boast that the German language is here spoken with as much accuracy as at Vienna, of which, however, a good German scholar can alone be judge. Sleswick has but little trade, as none but small boats can have access to it, the passage of the Sley having been long since choked up with sand and mud; before which period it was both flourishing and populous. It is now chiefly inhabited by the officers of the castle, and the poorer classes, or the

attendants on the court and on them. The present population is said not to exceed 5000. E. Long. 10. 0. N. Lat. 54. 40.

Sleswick
Sliding

SLESWICK, the duchy of, or *South Jutland*, is about 100 miles in length and 60 in breadth. It is bounded on the north by North Jutland, on the east by the Baltic sea, on the south by Holstein, and on the west by the ocean. It contains 14 cities, 17 towns, 13 castles, 278 parishes, 1480 villages, 162 farms, 116 water-mills, and 106 gentlemen's seats. It is a pleasant, fertile, populous country, and a sovereign duchy. Formerly the king of Denmark had half of it, and the other belonged to the house of Holstein-Gottorp; but the former having conquered this duchy, had the possession of it confirmed to him by the treaty of the north in 1720. In 1731, a prince of Bareith-Culmbach was made governor of this duchy, who resides at Gottorp.

SLEUT-HOUNDE, the ancient Scots name of the blood-hound. The word is from the Saxon *slot*, "the impression that a deer leaves of its foot in the mire," and *hound*, "a dog"; so they derive their name from following the track. See the article **BLOOD-HOUND**.

SLICH, in *Metallurgy*, the ore of any metal, particularly of gold, when it has been pounded, and prepared for farther working.

The manner of preparing the slich at Chrennitz in Hungary is this; they lay a foundation of wood three yards deep, upon this they place the ore, and over this there are 24 beams, armed at their bottoms with iron; these, by a continual motion, beat and grind the ore, till it is reduced to powder: during this operation, the ore is covered with water. There are four wheels used to move these beams, each wheel moving six; and the water, as it runs off, carrying some of the metalline particles with it, is received into several basons, one placed behind another; and finally, after having passed through them all, and deposited some sediment in each, it is let off into a very large pit, almost half an acre in extent; in which it is suffered to stand so long, as to deposit all its sediment, of whatever kind, and after this it is let out. This work is carried on day and night, and the ore taken away and replaced by more as often as occasion requires. That ore which lies next the beams, by which it was pounded, is always the cleanest or richest.

When the slich is washed as much as they can, a hundred weight of it usually contains about an ounce, or perhaps but half an ounce of metal, which is not all gold; for there is always a mixture of gold and silver, but the gold is in the largest quantity, and usually is two-thirds of the mixture: they then put the slich into a furnace with some limestone, and slacken, or the scoria of former meltings, and run them together. The first melting produces a substance called *lech*; this lech they burn with charcoal, to make it lighter, to open its body, and render it porous, after which it is called *ross*; to this *ross* they add sand in such quantity as they find necessary, and then melt it over again.

At Chrennitz many other ways are practised of reducing gold out of its ore, but particularly one, in which they employ no lead during the whole operation; whereas, in general, lead is always necessary, after the before-mentioned processes. See **ORES**, *Reduction of*.

SLIDING RULE, a mathematical instrument, serving to work questions in gauging, measuring, &c. without

out the use of compasses; merely by the sliding of the parts of the instrument one by another, the lines and divisions whereof give the answer by inspection.

This instrument is variously contrived, and applied by various authors, particularly Everard, Coggehall, Gunter, Hunt, and Partridge; but the most common and useful are those of Everard and Coggehall.

SLIGO, a county in the province of Connaught, Ireland, 25 miles in length, and as much in breadth; bounded on the east by that of Leitrim, on the west by the county of Mayo, on the north and north-west by the western ocean, and on the south and south-west by Roscommon and Mayo. It contains 5975 houses, 41 parishes, 6 baronies, 1 borough, and sends 4 members to parliament, two for the county, and two for the borough of the same name, which is the only market-town in the county, and is seated on a bay of the same name, 32 miles west of Killalla, and 110 north-east of Dublin. W. Long. 8. 26. N. Lat. 54. 13.

SLING, an instrument serving for casting stones with great violence. The inhabitants of the Balearic islands were famous in antiquity for the dexterous management of the sling; it is said they used three kinds of slings, some longer, others shorter, which they used according as their enemies were either nearer or more remote. It is added, that the first served them for a head-band, the second for a girdle, and that the third they constantly carried in their hand.

SLINGING is used variously at sea; but chiefly for hoisting up casks or other heavy things with slings, *i. e.* contrivances of ropes spliced into themselves at either end, with one eye big enough to receive the cask or whatever is to be slung. There are other slings, which are made longer, and with a small eye at each end; one of which is put over the breech of a piece of ordnance, and the other eye comes over the end of an iron crow, which is put into the mouth of the piece, to weigh and hoist the gun as they please. There are also slings by which the yards are bound fast to the cross-tree aloft, and to the head of the mast, with a strong rope or chain, that if the tie should happen to break, or to be shot to pieces in fight, the yard, nevertheless, may not fall upon the hatches.

SLINGING a Man overboard, in order to stop a leak in a ship, is done thus: the man is trussed up about the middle in a piece of canvas, and a rope to keep him from sinking, with his arms at liberty, a mallet in one hand and a plug, wrapped in osium and well tarred in a tarpawling clout, in the other, which he is to beat with all dispatch into the hole or leak.

SLOANE, SIR HANS, Baronet, eminently distinguished as a physician and a naturalist, was of Scotch extraction, his father Alexander Sloane being at the head of that colony of Scots which King James I. settled in the north of Ireland, where our author was born, at Killbeg, on the 19th of April 1660. At a very early period, he displayed a strong inclination for natural history; and this propensity being encouraged by a suitable education, he employed those hours which young people generally lose by pursuing low and trifling amusements, in the study of nature, and contemplating her works. When about sixteen, he was attacked by a spitting of blood, which threatened to be attended with considerable danger, and which interrupted the regular course of his application for three years: he had, however, already learn-

ed enough of physic to know that a malady of this kind was not to be removed suddenly, and he prudently abstained from wine and other liquors that were likely to increase it.

By strictly observing this severe regimen, which in some measure he continued ever after, he was enabled to prolong his life beyond the ordinary bounds; being an example of the truth of his own favourite maxim, that sobriety, temperance, and moderation, are the best and most powerful preservatives that nature has granted to mankind.

As soon as he recovered from this infirmity, he resolved to perfect himself in the different branches of physic, which was the profession he had made choice of; and with this view he repaired to London, where he hoped to receive that assistance which he could not find in his own country.

On his arrival in the metropolis, he entered himself as a pupil to the great Stofforth, an excellent chemist, bred under the illustrious Stahl; and by his instructions he gained a perfect knowledge of the composition and preparation of the different kinds of medicines then in use. At the same time, he studied botany at the celebrated garden at Chelsea, assiduously attended the public lectures of anatomy and physic, and in short neglected nothing that he thought likely to prove serviceable to him in his future practice. His principal merit, however, was his knowledge of natural history; and it was this part of his character which introduced him early to the acquaintance of Mr Boyle and Mr Ray, two of the most eminent naturalists of that age. His intimacy with these distinguished characters continued as long as they lived; and as he was careful to communicate to them every object of curiosity that attracted his attention, the observations which he occasionally made often excited their admiration and obtained their applause.

After studying four years at London with unremitting feverity, Mr Sloane determined to visit foreign countries for farther improvement. In this view he set out for France in the company of two other students, and having crossed to Dieppe, proceeded to Paris. In the way thither they were elegantly entertained by the famous Mr. Lemery the elder; and in return Mr Sloane presented that eminent chemist with a specimen of four different kinds of phosphorus, of which, upon the credit of other writers, M. Lemery had treated in his book of chemistry, though he had never seen any of them.

At Paris Mr Sloane lived as he had done in London. He attended the hospitals, heard the lectures of Tournefort, De Verney, and other eminent maillers; visited all the literati, who received him with particular marks of esteem, and employed himself wholly in study.

From Paris Mr Sloane went to Montpellier; and, being furnished with letters of recommendation from M. Tournefort to M. Chirac, then chancellor of that university, he found easy access, through his means, to all the learned men of the province, particularly to M. Magnol, whom he always accompanied in his botanical excursions in the environs of that city, where he beheld with pleasure and admiration the spontaneous productions of nature, and learned under his instructions to class them in a proper manner.

Having here found an ample field for contemplation, which was entirely suited to his taste, he took leave of his two companions, whom a curiosity of a different kind led into Italy.

After spending a whole year in collecting plants, he travelled through Languedoc with the same design; and passing through Thoulouze and Bourdeaux, returned to Paris, where he made a short stay. About the end of the year 1684 he set out for England, with an intention of settling there as a physician. On his arrival in London, he made it his first business to visit his two illustrious friends Mr Ray and Mr Boyle, in order to communicate to them the discoveries he had made in his travels. The latter he found at home, but the former had retired to Essex; to which place Mr Sloane transmitted a great variety of plants and seeds, which Mr Ray has described in his History of Plants, and for which he makes a proper acknowledgement.

About the year 1726 our author became acquainted with the celebrated Sydenham; who soon contracted a warm affection for him that he took him into his house, and recommended him in the strongest manner to his patients. He had not been long in London before he was proposed by Dr Martin Lister as a candidate to be admitted a member of the Royal Society, on the 26th of November 1681; and being approved, he was elected on the 21st of January following.

In 1683 he communicated some curiosities to the Society; and in July the same year he was a candidate for the office of their assistant secretary, but without success, as he was obliged to give way to the superior interest of his competitor Dr Halley. On the 12th of April 1687, he was chosen a fellow of the college of physicians in London; and the same year his friend and fellow traveller Dr Tancred Robinson, having mentioned to the Society the plant called *the star of the earth*, as a remedy newly discovered for the bite of a mad dog, Dr Sloane acquainted them that this virtue of the plant was to be found in a book called *De Grey's Farnery*; and that he knew a man who had cured with it twenty couple of dogs. This observation he made on the 13th of July, and on the 12th of September following he embarked at Portsmouth for Jamaica with the duke of Albemarle, who had been appointed governor of that island. The doctor attended his grace in quality of physician, and arrived at Jamaica on the 19th of December following.

Here a new field was opened for fresh discoveries in natural productions; but the world would have been deprived of the fruits of them, had not our author, by incredible application, converted, as we may say, his minutes into hours. The duke of Albemarle died soon after he landed, and the duchess determined to return to England whenever an answer should be received to the letter she had sent to court on that melancholy occasion. As Dr Sloane could not think of leaving her grace in her distress, whilst the rest of her retinue were preparing for their departure he improved it in making collections of natural curiosities; so that though his whole stay at Jamaica was not above fifteen months, he brought together such a prodigious number of plants, that on his return to England Mr Ray was astonished that one man could procure in one island, and in so short a space, so vast a variety.

On his arrival in London he applied himself to the

practice of his profession; and soon became so eminent, that he was chosen physician to Christ's Hospital on the 17th October 1694: and this office he held till the year 1733, when, on account of his great age and infirmities, he found it necessary to resign. It is somewhat singular, and redounds much to the Doctor's honour, that though he received the emoluments of his office punctually, because he would not lay down a precedent which might hurt his successors, yet he constantly applied the money to the relief of those who were the greatest objects of compassion in the hospital, that it might never be said he enriched himself by giving health to the poor. He had been elected secretary to the Royal Society on the 30th of November 1693; and upon this occasion he received the publication of the Philosophical Transactions, which had been omitted for some time. He continued to be the editor of this work till the year 1712; and the volumes which appeared during that period are monuments of his industry and ingenuity, many of the pieces contained in them being written by himself.

In the mean time he published *Catalogus Plantarum quæ in Insula Jamaica sponte proveniunt, &c.*; *seu Prodromi Historiæ Naturalis pars prima*; which he dedicated to the Royal Society and College of Physicians. About the same time he formed the plan of a dispensary, where the poor might be furnished at prime cost with such medicines as their several maladies might require; which he afterwards carried into execution, with the assistance of the president and other members of the college of physicians.

Our author's thirst for natural knowledge seems to have been born with him, so that his cabinet of curiosities may be said to have commenced with his being. He was continually enquiring and enlarging it; and the same which, in the course of a few years, it had acquired, brought every thing that was curious in art or nature to be first offered to him for purchase. These acquisitions, however, increased it but very slowly in comparison of the augmentation it received in 1701 by the death of William Cousten, Esq. a gentleman who had employed all his time, and the greater part of his fortune, in collecting rarities, and who bequeathed the whole to Dr Sloane, on condition of his paying certain debts and legacies with which he had charged it. These terms our author accepted, and he executed the will of the donor with the most scrupulous exactness; on which account some people have said, that he purchased Mr Cousten's curiosities at a dear rate.

In 1707 the first volume of Dr Sloane's Natural History of Jamaica appeared in folio, though the publication of the second was delayed till 1725. By this very useful as well as magnificent work, the materia medica was enriched with a great number of excellent drugs not before known. In 1708 the Doctor was elected a foreign member of the Royal Academy of Sciences at Paris, in the room of Mr Tichmaus; an honour so much the greater, as we were then at war with France, and the queen's express consent was necessary before he could accept it. In proportion as his credit rose among the learned, his practice increased among the people of rank: Queen Anne herself frequently consulted him, and in her last illness was bled by him.

On the advancement of George I. to the throne, that prince, on the 3d of April 1716, created the Doctor a baronet, an hereditary title of honour to which

no English physician had before attained; and at the same time made him physician general to the army, in which station he continued till 1727, when he was appointed physician in ordinary to George II. He attended the royal family till his death; and was particularly favoured by Queen Caroline, who placed the greatest confidence in his prescriptions. In the mean time he had been unanimously chosen one of the elects of the college of physicians June 1. 1716, and he was elected president of the same body on September 30. 1719, an office which he held for sixteen years. During that period he not only gave the highest proofs of his zeal and assiduity in the discharge of his duty, but in 1721 made a present to that society of 1000; and so for remitted a very considerable debt, which the corporation owed him, as to accept it in such small sums as were least inconvenient to the state of their affairs. Sir Hans was no less liberal to other learned bodies. He had no sooner purchased the manor of Chelsea, than he gave the company of apothecaries the entire household of their botanical garden there, upon condition only that they should present yearly to the Royal Society fifty new plants, till the number should amount to 2000 (A). He gave besides several other considerable donations for the improvement of this garden; the situation of which, on the banks of the Thames, and in the neighbourhood of the capital, was such as to render it useful in two respects: First, by producing the most rare medicinal plants; and, secondly, by serving as an excellent school for young botanists; an advantage which he himself had derived from it in the early part of his life.

The death of Sir Isaac Newton, which happened in 1727, made way for the advancement of Sir Hans to the presidency of the Royal Society. He had been vice-president, and frequently sat in the chair for that great man; and by his long connection with this learned body he had contracted so strong an affection for it, that he made them a present of an hundred guineas, caused a curious hall of King Charles II. its founder, to be erected in the great hall where it met, and, as is said, was very instrumental in procuring Sir Godfrey Copley's benefaction of a medal of the value of five guineas, to be annually given as an honorary mark of distinction to the person who communicates the best experiments to the Society.

On his being raised to the chair, Sir Hans laid aside all thoughts of further promotion, and applied himself wholly to the faithful discharge of the duties of the offices which he enjoyed. In this laudable occupation he employed his time from 1727 to 1740, when, at the age of fourscore, he formed a resolution of quitting the

service of the public, and of living for himself. With this view he resigned the presidency of the Royal Society much against the inclination of that respectable body, who chose Martin Folkes, Esq. to succeed him, and in a public assembly thanked him for the great and eminent services he had rendered them. In the month of January 1741, he began to remove his library, and his cabinet of rarities, from his house in Bloomsbury to that at Chelsea; and on the 12th of March following, having settled all his affairs, he retired thither himself, to enjoy in peaceful tranquillity the remains of a well-spent life. He did not, however, bury himself in that solitude which excludes men from society. He received at Chelsea, as he had done in London, the visits of people of distinction, of all learned foreigners, and of the royal family, who sometimes did him the honour to wait on him; but, what was still more to his praise, he never refused admittance or advice to rich or poor who came to consult him concerning their health. Not contented with this contracted method of doing good, he now, during his retreat, presented to the public such useful remedies as success had warranted, during the course of a long continued practice. Among these is the efficacious receipt for dilempters in the eyes, and his remedy for the bite of a mad dog.

During the whole course of his life, Sir Hans had lived with so much temperance, as had preserved him from feeling the infirmities of old age; but in his 90th year he began to complain of pains, and to be sensible of an universal decay. He was often heard to say, that the approach of death brought no terrors along with it; that he had long expected the stroke; and that he was prepared to receive it whenever the great Author of his being should think fit. After a short illness of three days, he died on the 11th of January 1752, and was interred on the 18th at Chelsea, in the same vault with his lady, the solemnity being attended with the greatest concourse of people, of all ranks and conditions, that had ever been seen before on the like occasion.

Sir Hans being extremely solicitous lest his cabinet of curiosities, which he had taken so much pains to collect, should be again dissipated at his death, and being at the same time unwilling that so large a portion of his fortune should be lost to his children, he bequeathed it to the public, on condition that 20,000l. should be made good by parliament to his family. This sum, though large in appearance, was scarcely more than the intrinsic value of the gold and silver medals, the ores and precious stones that were found in it; for in his last will he declares, that the first cost of the whole amounted at least to 50,000l. Besides his library, consisting

(A) This garden was first established by the company in 1673; and having after that period been stocked by them with a great variety of plants, for the improvement of botany, Sir Hans, in order to encourage so serviceable an undertaking, granted to the company the inheritance of it, being part of his estate and manor of Chelsea, on condition that it should be for ever preserved as a physic garden. As a proof of its being so maintained, he obliged the company, in consideration of the said grant, to present yearly to the Royal Society, in one of their weekly meetings, fifty specimens of plants that had grown in the garden the preceding year, and which were all to be specifically distinct from each other, until the number of two thousand should be completed. This number was completed in the year 1761. In 1733 the company erected a marble statue of Sir Hans, executed by Rybrae, which is placed upon a pedestal in the centre of the garden, with a Latin inscription, expressing his donation, and the design and advantages of it.

Flouze
||
Shrove.

filing of more than 50,000 volumes, 347 of which were illustrated with cuts finely engraven and coloured from nature, there were 3565 manuscripts, and an infinite number of rare and curious works of every kind. The parliament accepted the legacy, and fulfilled the conditions.

SLOANEA, a genus of plants belonging to the class of polyandria, and order of monogynia; and in the natural system ranging under the 50th order, *Amentaceae*. See **BOTANY INDEX**.

SLOE. See **PRUNUS**, **BOTANY INDEX**.

SLOOP, a small vessel furnished with one mast, the mainmast of which is attached to a gaff above, or to the mast on its foremast edge, and to a long boom below, by which it is occasionally shifted to either quarter. See **SHIP**.

SLOOP of War, a name given to the smallest vessels of war except cutters. They are either rigged as ships or sloops.

SLOT, in the sportsman's language, a term used to express the mark of the foot of a stag or other animal proper for the chace in the clay or earth, by which they are able to guess when the animal passed, and which way he went. The slot, or treading of the stag, is very nicely studied on this occasion; if the slot be large, deep printed in the ground, and with an open cleft, and added to these marks, there is a large space between mark and mark, it is certain that the stag is an old one. If there be observed the slots or treadings of two, the one long and the other round, and both of one size, the long slot is always that of the larger animal. There is also another way of knowing the old ones from the young ones by the treading; which is, that the hinder feet of the old ones never reach to their fore feet, whereas those of the young ones do.

SLOTH. See **BRADYPUS**, **MAMMALIA INDEX**.

SLOUGH, a deep muddy place. The cast skin of a snake, the damp of a coal pit, and the scar of a wound, are also called by the same appellation. The slough of a wild boar is the bed, soil, or mire, wherein he wallows, or in which he lies in the day-time.

SLUCZK, a large and populous town in Poland, in Lithuania, and capital of a duchy of the same name; famous for three battles gained here by Constantine duke of Ostrog over the Tartars, in the reign of Sigismund I. It is seated on the river Sluczka, 72 miles south-east of Minski, and 70 south of Novogrodeck. E. Long. 27. 44. N. Lat. 53. 2.

SLUG. See **LIMAX**, **HELMINTHOLOGY INDEX**.

SLUCE, a frame of timber, stone, or other matter, serving to retain and raise the water of a river, &c. and on occasion to let it pass.

Such is the sluice of a mill, which stops and collects the water of a rivelet, &c. to let it fall at length in the greater plenty upon the mill-wheel; such also are those used as vents or drains to discharge water off land. And such are the sluices of Flanders, &c. which serve to prevent the waters of the sea from overflowing the lower lands.

Sometimes there is a kind of canal inclosed between two gates or sluices, in artificial navigations, to save the water, and render the passage of boats equally easy and safe, upwards and downwards; as in the sluices of Briare in France, which are a kind of massive walls built parallel to each other, at the distance of 20 or 24 feet,

inclosed with strong gates at each end, between which is a kind of canal or chamber, considerably longer than broad; wherein a vessel being inclosed, the water is let out at the first gate, by which the vessel is raised 15 or 16 feet, and passed out of this canal into another much higher. By such means a boat is conveyed out of the Loire into the Seine, though the ground between them rises above 150 feet higher than either of those rivers.

Sluices are made different ways, according to the use for which they are intended: when they serve for navigation, they are shut with two gates, presenting an angle towards the stream; when they are made near the sea, two pair of gates are made, the one to keep the water out and the other in, as occasion requires: in this case, the gates towards the sea present an angle that way, and the others the contrary way; and the space inclosed by those gates is called the *chamber*. When sluices are made in the ditches of a fortress, to keep up the water in some parts, instead of gates, shutters are made so as to slide up and down in grooves; and when they are made to raise an inundation, they are then shut by means of square timbers let down in culises, so as to lie close and firm.

The word *sluice* is formed of the French *eschuse*, which Menage derives from the Latin *exclusa*, found in the Salic law in the same sense. But this is to be restrained to the sluices of mills, &c. for as to those serving to raise vessels, they were wholly unknown to the ancients.

SLUR, in *Music*, a mark like the arch of a circle, drawn from one note to another, comprehending two or more notes in the same or different degrees. If the notes are in different degrees, it signifies that they are all to be sung to one syllable; for wind instruments, that they are to be made in one continued breath; and for stringed instruments that are struck with a bow, as a violin, &c. that they are made with one stroke. If the notes are in the same degree, it signifies that it is all one note, to be made as long as the whole notes so connected; and this happens most frequently betwixt the last note of one line and the first of the next; which is particularly called *syncope*.

SLUYS, a town of Dutch Flanders, opposite the island of Cadfand, with a good harbour, 10 miles north of Bruges, containing 14,000 inhabitants. E. Long. 3. 25. N. Lat. 51. 19.

SMACK, a small vessel, commonly rigged as a sloop or hoy, used in the coasting or fishing trade, or as a tender in the king's service.

SMALAND, or **EAST GOTHLAND**, a province of Sweden, which makes part of Gothland; and is bounded on the north by Ostrogothia or East Gothland, on the east by the Baltic sea, on the south by Schonen and Bleckingia, and on the west by Westrogothia or West Gothland. It is about 112 miles in length, and 62 in breadth. Calmar is the capital town.

SMALKALD, a town of Germany, in Franconia, and in the county of Henneberg; famous for the confederacy entered into by the German Protestants against the emperor, commonly called the *league of Smalkald*. The design of it was to defend their religion and liberties. It is seated on the river Werra, 25 miles south-west of Erford, and 50 north-west of Bamberg. E. Long. 10. 53. N. Lat. 50. 49. It is subject to the prince of Hesse-Cassel.

SMALLAGE. See **APIUM**, **BOTANY INDEX**.

SMALT,

Sluice
||
Smalage.

See Co.
nat.

Sma't
H
Smeat-on.

SMALT, a kind of glass of a dark blue colour, which when levigated appears of a most beautiful colour; and if it could be made sufficiently fine, would be an excellent succedaneum for ultramarine, as not only retarding all kinds of weather, but even the most violent fires. It is prepared by melting one part of calcined cobalt with two of flint powder, and one of potash. At the bottoms of the crucibles in which the smalt is manufactured we generally find a regulus of a whitish colour inclined to red, and extremely brittle. This is melted afresh, and when cold separates into two parts; that at the bottom is the cobaltic regulus, which is employed to make more of the smalt; the other is bismuth.

SMARAGDITE, a species of mineral belonging to the magnesian genus. See MINERALOGY, p. 197.

SMARAGDUS, an old name for the emerald. See EMERALD, MINERALOGY, p. 159.

SMEATON, JOHN, an eminent civil engineer, was born the 25th of May 1724, O. S. at Aulthorpe, near Leeds, in a house built by his grandfather, and where his family have resided ever since.

The strength of his understanding and the originality of his genius appeared at an early age; his playthings were not the playthings of children, but the tools which men employ; and he appeared to have greater entertainment in seeing the men in the neighbourhood work, and asking them questions, than in any thing else. One day he was seen (to the distress of his family) on the top of his father's barn, fixing up something like a windmill; another time, he attended some men fixing a pump at a neighbouring village, and observing them cut off a piece of bored pipe, he was so lucky as to procure it, and he actually made with it a working pump that raised water. These anecdotes refer to circumstances that happened while he was in petticoats, and most likely before he attained his sixth year.

About his 14th and 15th year, he made for himself an engine for turning, and made several presents to his friends of boxes in ivory or wood very neatly turned. He forged his iron and steel, and melted his metal; he had tools of every sort for working in wood, ivory, and metals. He made a lathe, by which he cut a perpetual screw in brass, a thing little known at that day, which was the invention of Mr Henry Hindley of York; with whom Mr Smeaton soon became acquainted, and they spent many a night at Mr Hindley's house till day-light, conversing on those subjects.

Thus had Mr Smeaton, by the strength of his genius and indefatigable industry, acquired, at the age of 18, an extensive set of tools, and the art of working in most of the mechanical trades, without the assistance of any master. A part of every day was generally occupied in forming some ingenious piece of mechanism.

Mr Smeaton's father was an attorney, and desirous of bringing him up to the same profession; Mr Smeaton therefore came up to London in 1742, and attended the courts in Westminster hall; but finding (as his common expression was) that the law did not suit the bent of his genius, he wrote a strong memorial to his father on that subject; whose good sense from that moment left Mr Smeaton to pursue the bent of his genius in his own way.

Smeaton.

In 1751 he began a course of experiments to try a machine of his invention to measure a ship's way at sea, and also made two voyages in company with Dr Knight to try it, and a compass of his own invention and making, which was made magnetic by Dr Knight's artificial magnets; the second voyage was made in the Fortune loop of war, commanded at that time by Captain Alexander Campbell.

In 1753 he was elected member of the Royal Society; the number of papers published in their Transactions will show the universality of his genius and knowledge. In 1759 he was honoured by an unanimous vote with their gold medal for his paper intitled "An Experimental Inquiry concerning the Natural Powers of Water and Wind to turn Mills, and other Machines depending on a Circular Motion."

This paper, he says, was the result of experiments made on working models in the years 1752 and 1753, but not communicated to the Society till 1759; before which time he had an opportunity of putting the effect of these experiments into real practice, in a variety of cases, and for various purposes, so as to assure the Society he had found them to answer.

In December 1755, the Eddystone lighthouse was burnt down: Mr Weiton, the chief proprietor, and the others, being desirous of rebuilding it in the most substantial manner, inquired of the earl of Macclesfield (then president of the Royal Society) whom he thought the most proper to rebuild it; his Lordship recommended Mr Smeaton.

Mr Smeaton undertook the work, and completed it in the summer of 1759. Of this Mr Smeaton gives an ample description in the volume he published in 1791: that edition has been sold some time ago, and a second is now in the press, under the revival of his much esteemed friend Mr Aubert, F. R. S. and governor of the London assurance corporation.

Though Mr Smeaton completed the building of the Eddystone lighthouse in 1759 (a work that does him so much credit) yet it appears he did not soon get into full business as a civil engineer; but in 1764, while in Yorkshire, he offered himself a candidate for one of the receivers of the Derwentwater estate, and on the 31st of December in that year, he was appointed at a full board of Greenwich hospital, in a manner highly flattering to himself; when two other persons strongly recommended and powerfully supported were candidates for the employment. In this appointment he was very happy, by the assistance and abilities of his partner Mr Walton one of the receivers, who taking upon himself the management and accounts, left Mr Smeaton leisure and opportunity to exert his abilities on public works, as well as to make many improvements in the mills and in the estates of Greenwich hospital. By the year 1775 he had so much business as a civil engineer, that he wished to resign this appointment; and would have done it then, had not his friend the late Mr Stuart the hospital surveyor, and Mr Ibbetson their secretary, prevailed upon him to continue in the office about two years longer.

Mr Smeaton having now got into full business as a civil engineer, performed many works of general utility. He made the river Calder navigable: a work that required great skill and judgement, owing to the very impetuous floods in that river: He planned and at-

Smeaton.

tended the execution of the great canal in Scotland for conveying the trade of the country either to the Atlantic or German ocean; and having brought it to the place originally intended, he declined a handsome yearly salary, in order that he might attend to the multiplicity of his other business.

On the opening of the great arch at London bridge, the excavation around and under the ferlings was so considerable, that the bridge was thought to be in great danger of falling. He was then in Yorkshire, and was sent for by express, and arrived with the utmost dispatch: "I think (says Mr Holmes, the author of his life) it was on a Saturday morning, when the apprehension of the bridge was so general that few would pass over or under it. He applied himself immediately to examine it, and to found about the ferlings as minutely as he could; and the committee being called together, adopted his advice, which was to repurchase the stones that had been taken from the middle pier, then lying in Moorfields, and to throw them into the river to guard the ferlings." Nothing shows the apprehensions concerning the falling of the bridge more than the alacrity with which this advice was pursued; the stones were repurchased that day, horses, carts, and barges were got ready, and they began the work on Sunday morning. Thus Mr Smeaton, in all human probability, saved London bridge from falling, and secured it till more effectual methods could be taken.

The vast variety of mills which Mr Smeaton constructed, so greatly to the satisfaction and advantage of the owners, will show the great use which he made of his experiments in 1752 and 1753; for he never trusted to theory in any case where he could have an opportunity to investigate it by experiment. He built a steam engine at Authorne, and made experiments thereon, purposely to ascertain the power of Newcomen's steam-engine, which he improved and brought to a greater degree of perfection, both in its construction and powers, than it was before.

Mr Smeaton during many years of his life was a frequent attendant on parliament, his opinion being continually called for; and here his strength of judgement and perspicuity of expression had its full display: it was his constant custom, when applied to, to plan or support any measure, to make himself fully acquainted with it, to see its merits before he would engage in it: by this caution, added to the clearness of his description and the integrity of his heart, he seldom failed to obtain for the bill which he supported an act of parliament. No one was heard with more attention, nor had any one ever more confidence placed in his testimony. In the courts of law he had several compliments paid him from the bench by Lord Mansfield and others, for the new light which he threw on difficult subjects.

About the year 1783 Mr Smeaton's health began to decline; and he then took the resolution to endeavour to avoid all the business he could, so that he might have leisure to publish an account of his inventions and works, which was certainly the first wish of his heart; for he has often been heard to say, that "he thought he could not render so much service to his country as by doing that." He got only his account of the Eddystone lighthouse completed, and some preparations to his intended Treatise on Mills; for he could not resist the solicitations of his friends in various works: and

Mr Aubert, whom he greatly loved and respected, being chosen chairman of Romigate harbour, prevailed upon him to accept the place of engineer to that harbour; and to their joint efforts the public is chiefly indebted for the improvements that have been made there within these few years, which fully appears in a report that Mr Smeaton gave in to the board of trustees in 1791, which they immediately published.

Mr Smeaton being at Authorne, walking in his garden on the 16th of September 1792, was struck with the palsy, and died the 28th of October. "In his illness (says Mr Holmes) I had several letters from him, signed with his name, but written and signed by another's pen; the diction of them showed that the strength of his mind had not left him. In one written the 26th of September, after minutely describing his health and feelings, he says, "in consequence of the foregoing, I conclude myself nine-tenths dead; and the greatest favour the Almighty can do me (as I think), will be to complete the other part; but as it is likely to be a lingering illness, it is only in His power to say when that is likely to happen."

Mr Smeaton had a warmth of expression that might appear to those who did not know him well to border on harshness; but those more intimately acquainted with him, knew it arose from the intense application of his mind, which was always in the pursuit of truth, or engaged in investigating difficult subjects. He would sometimes break out hastily, when any thing was said that did not tally with his ideas; and he would not give up any thing he argued for, till his mind was convinced by sound reasoning.

In all the social duties of life he was exemplary; he was a most affectionate husband, a good father, a warm, zealous, and sincere friend, always ready to assist those he respected, and often before it was pointed out to him in what way he could serve them. He was a lover and encourager of merit whatever he found it; and many men are in a great measure indebted to his assistance and advice for their present situation. As a companion, he was always entertaining and instructive; and none could spend any time in his company without improvement.

SMELL; this word has in most languages two meanings, signifying either that sensation of mind of which we are conscious, in consequence of certain impressions made on the nostrils, and conveyed to the brain by the olfactory nerves; or that unknown virtue, or quality; in bodies, which is the cause of our sensations of smell.

SMELLING is the act by which we perceive smells, or become sensible of the presence of odorous bodies. The sensations of smell are excited by certain effluvia, which, in the open air, are always rising from the surfaces of moist bodies, and striking on the extremities of the olfactory nerves, give them a peculiar sort of impression, which is communicated to the brain. The particles which issue thus from bodies are extremely volatile, and produce sensation by a degree of contact, which, though insensible, is still more efficient than if it were more gross and palpable. It is by a similar species of insensible contact that the eyes and ears are affected by external objects; whilst, in the excitation of the sensations of touch and of taste, an actual and sensible contact of the object with the organ is necessary.

Smeaton
II
Smeating.

Smelling. fary. The organs of smelling are the nutrit- and olfactory nerves; the minute ramifications of the latter being distributed throughout the whole concavity of the former. For a description of these, see ANATOMY.

The effluvia from odorous bodies are constantly floating about in the atmosphere, and must of course be drawn into the nostrils along with the air in inspiration; "so that there is," as Dr Reid observes, "a manifest appearance of design in placing the organ of smell in the inside of that canal, through which the air is continually passing in inspiration and expiration." It has been affirmed by Boerhaave, that the matter in animals, vegetables, fossils, &c. which chiefly affects the sense of smelling, is that attenuated substance, inherent in their oily parts, called *spirius*; because, when this is taken away from the most fragrant bodies, what remains has scarcely any smell at all; but this, he says, if poured on the most inodorous bodies, gives them a fragrance*. We cannot, however, enter at present upon this inquiry.

The sense of smell has a close alliance with that of taste: and it seems probable from the proximity in the situation of their organs in all animals, that both are principally intended to guide them in the choice of their food; so that from this close connection, they are better enabled to choose what is good for them, and to reject what would be injurious. This is the opinion of Dr Reid, as it was, in a very early period of the history of philosophy, that of Socrates and of Cicero (A). Dr Reid also remarks, that the sense of smell probably serves the same purpose in the natural state of man; but it is not always a sure guide for this purpose. The organs of smell differ, like those of the other senses, according to the destination of the animals to which they belong; and we know, that this sense in man much less acute, than it is in many other animals. We see, that in the choice of their food, they are guided by the senses of smell and of taste, except when man has brought them into a sort of unnatural state by domestication. And this circumstance renders it probable, that both these senses were intended to serve the same purpose in the natural state of our species, although less calculated for this end than they are in the brutes, on account of the great superiority of their smelling organs. Besides, since it is probable that man, in the natural state, acts more by instinct than when civilized in society, so also it is reasonable to think, that he may possess some of the senses, (his of smell for instance), in greater acuteness than we do. This indeed, we are assured to be a fact; for we

VOL. XIX. Part II.

are told, in the *Histoire des Antilles*, that there are negroes who, by the smell alone, can distinguish the footsteps of a Frenchman from those of a negro.

The sense of smell is much more obtuse in man than in some of the lower animals. Dogs we know possess a power of smelling, of which we can scarcely form a conception; and which, it is happy for us we do not possess; and birds of prey are said to possess this sense in still greater acuteness. But although this be more perfect, still the sense of smelling in man, who has other means of judging of his food, &c. is such as to fit him for deriving enjoyment from a diversity of scents, particularly those of flowers and perfumes, to which dogs and other animals seem perfectly insensible. It has been said, we are aware, that some animals, the elephant for instance, are capable of this enjoyment (c); but of this fact we cannot help being very doubtful.

There is a very great sympathy between the organs of smell and of taste; for any defect or disease of one is generally attended with some corresponding defect or disease of the other. There is also a greater similarity between the sensations of both these, than between those of any other two senses; and hence it is, that we can sometimes tell the taste of an object from its smell, and *vice versa*. Hence also the reason why we apply the same epithets to the names of both these classes of sensations; as a sweet smell or taste, &c.

It deserves also to be remarked, that both these senses seem subservient to the preservation of the animal existence, rather than to any other purpose. They accordingly constitute an object of the natural history of man, rather than of intellectual or of moral philosophy. The other three senses, on the contrary, seem rather intended for (as they certainly are essential to) our intellectual improvement, and become, of course, a proper object of investigation in the sciences of moral philosophy, or metaphysics.

The advantages derived by man and the other animals from the sense of smelling are not confined to the assistance which it affords them in the choice of their food. Moist bodies in nature, when exposed to the open air, are constantly sending forth emanations or effluvia of such extreme minuteness as to be perfectly invisible. These diffuse themselves through the air, and however noxious or salutary, would not be perceived without the sense of smelling, which if not vitiated by unnatural habits, is not only a faithful monitor when danger is at hand, but conveys to us likewise the most exquisite

3 F

pleasures

(A) "Ut gustus (says a learned *physiologi*) cibi itineri, sic olfactus officio viarum, quas air subire debet, custos praeponitur, moniturus ne qui d'noxii, via quae semper patet, in corpus admittatur. Porro, ut gustus, sic quoque olfactus ad salutarem cibum invitatur, à noxio aut corrupto, putrido insipidum vel rancido, deterret."

"When thou smell the mouth, through which animals take in whatever they desire, always placed near the nose and eyes, thinkest thou not, says Socrates to Aristodimus, that this is the work of a providence." Xenophon's *Memorables*, book i. chap. 4.

(B) "The excellent eversion which dogs express on smelling their game, seems to be but little connected with the appetite for food, and wholly independent of any preconceived ideas of the objects of their pursuit being fit for it. Hence several kinds of them will not eat the game which they pursue with such wild impetuosity; and of which the scent seems to animate them to a degree of ecstacy far beyond what the desire of food can produce." Knight on Taste.

(C) There is an animal to which, naturalists say, perfume is so agreeable and so necessary, that nature has provided it with a little bag thred with an exquisite odour. "On pretend, (says Buffon,) que la mangouste ouvre cette poche, pour se rafraichir lorsqu'elle est trop chaude."

pleasures. The fragrance of a rose, and of many other flowers, is not only pleasant, but gives a refreshing and delightful stimulus to the whole system, whilst the odours proceeding from hemlock, or any noxious vegetable, or other substance, are highly offensive to our nostrils. Hence we are naturally led to seek the one class of sensations, and to avoid the other.

In some species of animals the sense of smell seems to be connected with certain mental sympathies, as those of hearing and sight are in all that possess them in any high degree: for not only their sexual desires appear to be excited by means of it, but other instinctive passions, which, according to the usual system of nature, should be still more remote from its influence. Dogs, although wholly unacquainted with lions, will shudder at their roar; and an elephant that has never seen a tiger, will in the same manner show the strongest symptoms of horror and affright at the smell of it. "The late Lord Clive (says an ingenious writer), exhibited a combat between two of these animals at Calcutta; but the scent of the tiger had such an effect upon the elephant, that nothing could either force or induce him to go along the road, where the cage in which the tiger was inclosed, had passed, until a gallon of arack was given him. Upon this, his horror suddenly turning into fury, he broke down the paling to get at his enemy, and killed him without difficulty."

If riding along a road, near which a dead horse, or part of its carcass, happens to be lying, we know, that our horse, although he sees it not, cannot be made to quit the place but with difficulty. Where blood has been shed, particularly that of their own species, oxen will tremble, and upon smelling it, roar and bellow, and show the most manifest signs of horror and distress. And yet these symptoms could not arise from any associated notions of danger or death, since they appear in such as never had any opportunities of acquiring them. They must therefore be instinctive, like other instinctive antipathies and propensities. But although in the irrational intercourse, animals make much use of the sense of smell, still it does not seem to be further concerned in exciting their sexual desires, than in indicating their object.

Some of those epistolary philosophers, who are ready upon all occasions to quarrel with the constitution of nature, have taken the liberty of condemning their Maker, because it has pleased his unsearchable wisdom to bestow in some instances upon the brutes senses and instincts more perfect than he has given to man, without reflecting that he has given to man an ample equivalent; for it may be asked with the poet,

- "Is not his reason all these powers in one?"
- "Is Heaven a mind to man and man a bone?"
- "Shall he abuse, when rais'd we call,
- "Be pleas'd with nothing? not pleas'd with all?"

With respect to that unknown peculiarity of bodies, which is the cause of our sensations of smell, the opinions of philosophers have been very various. Until late, the doctrine of Descartes and Locke on this subject was pretty generally received; but, since the publication of DuRoi's works, the opinion, which we deem the most correct and satisfactory, has become very popular. We will endeavour to state the substance of this matter. For this purpose, let us suppose a particle to be large con-

up without the sense of smell, to be immediately endowed with the use of this organ, and placed near some flowers of an exquisite favour. When he examines what he feels in such a situation, he can find no resemblance between this new sensation and any thing with which he is already acquainted. He finds himself unable to explain its nature, and cannot ascribe to it figure, extension, or any known property of matter. It is a simple affection, or feeling, of mind, and, considered abstractedly, can have no necessary connection with the nerves, the nullrils, or cillaria, or with any thing material whatever. By the nature of his constitution he is, however, led to refer this peculiar sensation to the nostrils, as its organ; and when, from experience, and by means of touch, he learns that external objects have the power of exciting this sensation, he concludes, that there must exist in bodies some unknown cause by which it is excited. In the first part of this process he considers the feeling, or sensation, abstractedly. As such it exists in the mind only; and cannot exist there but when the mind is conscious of it. His consciousness soon enables him to distinguish different sorts of smells, all of them very distinct from one another; but, conformably to the nature of all sensation, extremely simple. He concludes, that each of these must have a distinct cause; and finding, by experience, that this cause is an unknown something in bodies, he concludes, that it must be a property of matter, and, for want of another, gives it the name of smell. When he removes an odorous body from the organ, the sensation vanishes: when the body is again applied, the sensation is excited: and hence it is, that he is led naturally to connect the sensation with this unknown peculiarity of bodies by which it is produced. But since we see, that the sensation is, in a great degree, related to other objects besides its unknown cause, to the mind in which it exists, for instance, and to the organ which is its instrument, it may be asked why it becomes associated in the mind with its cause only? The reason seems pretty obvious. No single sensation or class of sensations, is more connected with the mind, than any others of which it is susceptible. Nor is the connection subsisting between the organ and any of the sensations peculiar to it greater than that which subsists between it and every other sensation of which it is the inlet. Hence the connection between the smell of an orange and the mind, or between it and the nostrils, is very general, and cannot, in the former instance, distinguish it from any other sensation of whatever kind, nor, in the latter from any other particular smell. But the connexion between this sensation and the orange is peculiar and permanent; and we accordingly find them always associated in the mind, just as we associate the notion of fire with the sensation of burning. The relation which a sensation of smell, or any sensation, bears to the mind, to an organ, or to the memory and conception of itself, is common to all sensations. The relation which any sensation bears to its own cause, suppose the sensation of smell to a particular virtue or quality of bodies, is common to it with every other sensation, when considered with respect to its peculiar cause. And finally, a sensation of any kind bears the same sort of relation to the memory and conception of itself, that any other feeling or operation of mind bears to the conception and memory of that particular feeling or operation.

Whatever then be the nature of the minute particles

of bodies by which our sensations of smell are excited, we cannot help conjecturing their unknown cause as a virtue or quality of matter. Like all other modifications of material substance, it may be confided, that this can never be a substance to a function of mind. But we are not, therefore, to conclude with the followers of Dr. Carter and Locke, that this necessary quality is a mere faculty, especially as we can readily conceive it existing where it is not inclined, or even after supposing the annihilation of every faculty being throughout the universe. The existence of the sensation we know to be momentary and fugitive; but in the existence of its cause we can, without difficulty, or incertainty, conceive a permanency independent of mind and of its faculties.

The doctrine we have been illustrating has, it has been called in question by a sceptical writer, who it appears to us, has upon this occasion been entirely deficient in his accustomed acuteness. Dr Reid's account of this affair seems to fall, so clear and convincing, that we are at a loss to conceive how his meaning can be misunderstood; and yet the arguments and objections of the writer to whom we allude, derive all their plausibility from a misinterpretation of Dr Reid's meaning, and from a deviation from the established use of language. "An eminent metaphysician" (says this author, who has declared that he has not the least difficulty in conceiving the air perfumed with aromatic odours in the deserts of Arabia; and he has decided, that the man who maintains smell to exist only in the mind, must be mad, or must abuse language and disgrace philosophy. There are some authors, nevertheless, who dissent widely on this subject from the learned metaphysician. Is it possible for a sensation to exist where there is no function? The authors to whom I allude think it impossible." And so, we may tell this learned author, does Dr Reid, if he will take his word for it. On the definition of smell he remarks: "It is indeed impossible, that it can be in any body: it is a function; and a sensation can be in a sentient thing only." Again, "I can think of the smell of a rose when I do not smell it; and it is possible that when I think of it there is no rose any where existing; but, when I smell it, I am necessarily determined to believe that the sensation really exists. This is common to all sensations, that, as they come to us, but in being perceived, do they cannot be perceived but they not exist." But, continues this acute metaphysician, "a smell is nothing else than a sensation. It is a quality, which may be agreeable or disagreeable, which may, as some think, be excited by various combinations of elements; but which, fine it is a feeling, cannot be independent, which are all to excite it, and excite it, where there is no creature to excite it. What is to be understood, in philosophical terms, by the perfume of the rose? We can expect to see, at noon, the flowers refuse us, or even were it to perfume the desert. But the air vibrating in our nostrils, as that better than would be from the roses of a man, each of a nature where there is no sensation." And is it then true that a smell is nothing else than a sensation? A sensation is never in the mind; it is a function, it is a modification of the self, which the mind itself can never produce. It must therefore, have some cause which is external to the mind. Now, if this be true, and if we are to consider, that the mere *esse* is not its possible cause,

in all languages; and it is this cause which Dr Reid, in speaking of existing in the deserts of Arabia, where there is no sentient being to perceive it. But let us here hint: "We have considered it as existing in a fountain, in a thair, or impulsion, in the mind; and in this sense it may only be in a mind or sentient being; but it is evident that mankind give the name of *smell* much more frequently to function; which they conceive to be external, and to be a quality of body; they understand it to be something which does not act in the mind, and have not the least difficulty in conceiving the air perfumed with aromatic odours in the deserts of Arabia, or in some antediluvian island where the sun's foot never tread." "The faculty of smelling is something very different from the actual function of smelling; for the faculty may remain when we have no sensation. And the mind is no less different from the faculty, for it continues the same individual being, when that faculty is lost. What is smell in the rose? It is a quality or virtue of the rose, or of something proceeding from it, which we perceive by the sense of smelling; and this is all we know of the matter. But what is smelling? It is an act of the mind, but is never imagined to be a quality of the mind. Again, the sensation of smelling is conceived to infer necessarily a mind or sentient being; but smell in the rose infers no such thing. We say, this body smells sweet and that stinks; but we do not say, this animal smells sweet and that stinks; therefore, smell in the rose, and the stink in which it excites, are not conceived, even by the vulgar, to be things of the same kind, although they have the same name." "There are some other remarks on Dr Reid's objection, in the work upon which we have been commenting, which we shall pass by; we may, however, since the author's concluding argument, after mentioning some examples, he observes, "Now in these instances we see men and animals that must have perception of smell, I may be permitted to say so, altogether different from each other. Is not each sensation when the smell finds itself in the field for his snaker; when the shark pursues through the ocean its expected victim; and when the eagle conducts the thimble wanderer to a mountain of such water across the burning sands of the Arabian desert? If no animal had the function of smell, there would be no odour; for *aroma* and oil may be thought to be essential combinations, but are neither agreeable nor disagreeable feeling." If men and animals differ in their perceptions of smell, could we doubt, difference of organization will enable them to do so; the conclusion would not be, we think, that smell is merely sensation, and that it is merely something external which is the cause of these sensations, and about which it differs. A rose put to the nostrils of a man and then to that of a dog, may excite very different sensations; but we cannot think that the necessity of the rose, will excite in us different ideas, may vary by thus changing the nature of the rose. Do not take one person's smell, man or dog, and another thinks that it is a quality, the same man may be able to distinguish a smell necessary to him, which his dog could not; that they know one another, that, "it is not true to say, when the smell finds itself in his snaker to the field." There is, however, a difference in the way we may be permitted to say, that all the functions of the mind's function of smelling are not the same.

Dr Reid, in his account of this affair, seems to fall, so clear and convincing, that we are at a loss to conceive how his meaning can be misunderstood; and yet the arguments and objections of the writer to whom we allude, derive all their plausibility from a misinterpretation of Dr Reid's meaning, and from a deviation from the established use of language. "An eminent metaphysician" (says this author, who has declared that he has not the least difficulty in conceiving the air perfumed with aromatic odours in the deserts of Arabia; and he has decided, that the man who maintains smell to exist only in the mind, must be mad, or must abuse language and disgrace philosophy. There are some authors, nevertheless, who dissent widely on this subject from the learned metaphysician. Is it possible for a sensation to exist where there is no function? The authors to whom I allude think it impossible." And so, we may tell this learned author, does Dr Reid, if he will take his word for it. On the definition of smell he remarks: "It is indeed impossible, that it can be in any body: it is a function; and a sensation can be in a sentient thing only." Again, "I can think of the smell of a rose when I do not smell it; and it is possible that when I think of it there is no rose any where existing; but, when I smell it, I am necessarily determined to believe that the sensation really exists. This is common to all sensations, that, as they come to us, but in being perceived, do they cannot be perceived but they not exist." But, continues this acute metaphysician, "a smell is nothing else than a sensation. It is a quality, which may be agreeable or disagreeable, which may, as some think, be excited by various combinations of elements; but which, fine it is a feeling, cannot be independent, which are all to excite it, and excite it, where there is no creature to excite it. What is to be understood, in philosophical terms, by the perfume of the rose? We can expect to see, at noon, the flowers refuse us, or even were it to perfume the desert. But the air vibrating in our nostrils, as that better than would be from the roses of a man, each of a nature where there is no sensation." And is it then true that a smell is nothing else than a sensation? A sensation is never in the mind; it is a function, it is a modification of the self, which the mind itself can never produce. It must therefore, have some cause which is external to the mind. Now, if this be true, and if we are to consider, that the mere *esse* is not its possible cause,

↑ Reid's *Logic*, p. 106.
in 7. ch. 2.

↑ Reid's *Logic*, p. 106.

↑ Reid's *Logic*, p. 106.

↑ Reid's *Logic*, p. 106.

Smelling.

the field? What of the shark's sensation of smell and pain; were there no victim in the ocean? and what of the camel and the thirsty wanderer, were there no fountain of fresh water in the Arabian deserts? "The *juice of a rose* signifies two things, says Dr Reid; *First*, A sensation which can have no existence but when it is perceived, and can only be in a sentient being or mind. *Secondly*, It signifies some power, quality, or virtue in the rose, or in effluvia proceeding from it, which hath a permanent existence independent of the mind; and which, by the constitution of nature, produces the sensation in us. By the original constitution of our nature we are both led to believe that there is a permanent cause of the sensation, and prompted to seek after it; and experience determines us to place it in the rose. The names of all smells, tastes, sounds, as well as heat and cold, have a like ambiguity in all languages; but it deserves our attention, that these names are but rarely, in common language, used to signify the sensations; for the most part, they signify the external qualities which are indicated by the sensations.* We have been induced thus to discuss this topic at some length, because we regretted to see Dr Reid's opinion and reasoning misrepresented; and we shall now conclude, not as this modern Berkleian does, "that, if no animal had the sensation of smell, there would be no odour;" but, that if there were no odour or external cause of smell, no animal would have this sensation.

The sense of smell becomes sometimes too acute, either in consequence of some defect or disease of the organ, or from too great a sensibility of the whole nervous system, such as we sometimes observe in fevers, in phrenitis, and in hysterical diseases. It is however more frequently blunted in consequence of affections of the brain and nerves, arising from blows on the head, or from internal causes; or this may happen on account of too great a dryness of the organ, owing to a suppression of the accustomed humours, or to their being conveyed off by some other channel: or it may arise from too great a quantity of tears and of mucus choking up the nostrils. We have instances of both in cases of common cold, in which, at the beginning of the disease, the nostrils are dry, but as it advances, begin to discharge a great deal of humour, or become obstructed by a thick mucus. Whatever hinders the free entrance of the air into the nostrils or its passage through them, must also injure the sense of smell. It is also sometimes so depraved as to perceive smells when there is no odorous body present, or to perceive smells different from those that are really present. Some of the particles of the odorous effluvia, after having remained for some time in the caverns of the nostrils, issuing forth again and affecting the organ, will sometimes cause this species of false perception, even in the most healthy persons.

The sense of smelling may be diminished or destroyed by diseases; as by the moisture, dryness, inflammation, or supuration of the olfactory membrane, the compression of the nerves which supply it, or some fault in the brain itself at their origin. A defect, or too great a degree of solidity of the small spongy bones of the upper jaw, the caverns of the forehead, &c. may likewise impair this sense: and it may be also injured by a collection of fetid matter in these caverns, which is continually exhaling from them, and also by immoderate use of snuff. When the nose abounds with moisture, after

gentle evacuations, such things as tend to take off irritation and coagulate the thin sharp serum may be applied; as the oil of anise mixed with fine flour, camphor dissolved in oil of almonds, &c. the vapours of amber, frankincense, gum-mastic, and benzoin, may likewise be received into the nose and mouth. For moistening the mucus when it is too dry, some recommend snuff made of the leaves of marjoram, mixed with oil of amber, marjoram, and anised; or a lernutatory of calcined white vitriol, twelve grains of which may be mixed with two ounces of marjoram water and filtrated. The steam of vinegar upon hot iron, and received up the nostrils, is also of use for softening the mucus, removing obstructions, &c. If there be an ulcer in the nose, it ought to be dressed with some emollient ointment, to which, if the pain be very great, a little laudanum may be added. If it be a venereal ulcer, 12 grains of corrosive sublimate may be dissolved in a pint and a half of brandy, a table spoonful of which may be taken twice a day. The ulcer ought likewise to be washed with it, and the fumes of cinabar may be received up the nostrils.

If there be reason to suspect that the nerves which supply the organs of smelling are inert, or want stimulating, volatile salts, or strong snuffs, and other things which occasion sneezing, may be applied to the nose; the forehead may likewise be anointed with balsam of Peru, to which may be added a little oil of amber.

SMELT. See SALMO, ICHTHOLOGY Index.

SMELTING, in Metallurgy, the fusion or melting of the ores of metals, in order to separate the metalline part from the earthy, stony, and other parts. See ORES, Reduction of.

SMEW. See MERGUS, ORNITHOLOGY Index.

SMILAX, ROUGH BINDWEED, a genus of plants belonging to the class of *dioecia* and order of *hexandria*; and in the natural system ranging under the 11th order, *Sarmentaceae*. See BOTANY, and MATERIA MEDICA Index.

SMITH, SIR THOMAS, was born at Walden in Essex in 1512. At 14 he was sent to Queen's college Cambridge, where he distinguished himself so much, that he was made Henry VIII.'s scholar together with John Cheke. He was chosen a fellow of his college in 1531, and appointed two years after to read the public Greek lecture. The common mode of reading Greek at that time was very faulty; the *an* sound being given to the letters and diphthongs, *α, η, ε, ει, ο, ω*. Mr Smith and Mr Cheke had been for some time sensible that this pronunciation was wrong; and after a good deal of consultation and research, they agreed to introduce that mode of reading which prevails at present. Mr Smith was lecturing on *Aristotle de Republica* in Greek. At first he dropped a word or two at intervals in the new pronunciation, and sometimes he would stop as if he had committed a mistake and correct himself. No notice was taken of this for two or three days; but as he repeated more frequently, his audience began to wonder at the unusual sounds, and at last some of his friends mentioned to him what they had remarked. He owned that something was in agitation, but that it was not yet sufficiently digested to be made public. They entreated him earnestly to discover his project: he did so; and in a short time great numbers resorted to him for information. The new pronunciation

Smelling
Smith.

Smith was adopted with enthusiasm, and soon became universal at Cambridge. It was afterwards epoked by Bishop Gardiner the chancellor; but its superiority to the old mode was so visible, that in a few years it spread over all England.

In 1559 he travelled into foreign countries, and studied for some time in the universities of France and Italy. On his return he was made regius professor of civil law at Cambridge. About this time he published a treatise on the mode of pronouncing English. He was useful likewise in promoting the reformation. Having gone into the family of the duke of Somerset, the protector during the minority of Edward VI. he was employed by that nobleman in public affairs; and in 1548 was made secretary of state, and received the honour of knighthood. While that nobleman continued in office, he was sent ambassador, first to Brussels and afterwards to France.

Upon Mary's accession he lost all his places, but was fortunate enough to preserve the friendship of Gardiner and Bucer. He was exempted from persecution, and was allowed, probably by their influence, a pension of 100*l.* During Elizabeth's reign he was employed in public affairs, and was sent three times by that princess as her ambassador to France. He died in 1577. His abilities were excellent, and his attainments uncommonly great: He was a philosopher, a physician, a chemist, mathematician, linguist, historian, and architect. He wrote, 1. A treatise called the *English Commonwealth*. 2. A letter *De Recta et Emendata Lingua Græcæ Præfatione*. 3. *De Moribus Turcarum*. 4. *De Davidum Moribus*.

SMITH, Edmund, an English poet, the only son of Mr Nute an eminent merchant, by a daughter of Burton Lechmere, was born in 1693. By his father's death he was left young to the care of Mr Smith, who had married his father's sister, and who treated him with so much tenderness, that at the death of his generous guardian he assumed his name. His writings are not many, and those are scattered about in miscellanies and collections: his celebrated tragedy of *Phœdra* and *Hippolitus* was acted in 1707; and being introduced at a time when the Italian opera so much engrossed the polite world, gave Mr Addison, who wrote the prologue, an opportunity to rally the vitiated taste of the public. However, notwithstanding the esteem it has always been held in, it is perhaps rather to be considered as a fine poem than as a good play. This tragedy, with a Poem to the memory of Mr John Phillips, three or four Odes, with a Latin oration spoken at Oxford in *Laudem Thomæ Bodlei*, were published as his works by his friend Mr Oldisworth. Mr Smith died in 1710, sunk into indolence and intemperance by poverty and disappointments; the hard fate of many a man of genius.

SMITH, John, an excellent mezzotinter, flourished about 1700; but neither the time of his birth nor death is accurately known. He united softness with strength, and finished with freedom. He served his time with one Tillet a painter in Moorfields; and as soon as he became his own master, learned from Becket the secret of mezzotinto, and being farther instructed by Van der Vaart, was taken to work in Sir Godfrey Kneller's house; and as he was to be the publisher of that master's works, doubtless received considerable hints

from him, which he amply repaid. "To posterity perhaps his prints (says Mr Walpole) will carry an idea of something burlesque; perukes of an enormous length flowing over bits of armour, compose wonderful habits. It is equally strange that fashion could introduce the one, and establish the practice of representing the other when it was out of fashion. Smith excelled in exhibiting both, as he found them in the portraits of Kneller, who was less happy in what he substituted to armour. In the Kit-cat club he has poured full buttons chiefly over night gowns. If those streams of hair were *incorporate* in a battle, I know nothing (he adds) they were adapted to that can be done in a night-gown. Smith composed two large volumes, with proofs of his own plates, for which he asked 5*0*l.** His final works are Duke Schomberg on horseback; that duke's son and successor Myrnhard; the earls of Pembroke, Dorset, and Albemarle; three plates with two figures in each, of young persons or children, in which he shone; William Cowper; Gibbons and his wife; Queen Anne; the duke of Gloucester, a whole length, with a flower-pot; a very curious one of Queen Mary, in a high head, fan, and gloves; the earl of Godolphin; the duchess of Ormond, a waist length, with a black; Sir George Rooke, &c. There is a print by him of James II. with an anchor, but no inscription; which not being finished when the king went away, is so scarce that it is sometimes sold for above a guinea. Smith also performed many historic pieces; as the loves of the gods, from Titian, at Blenheim, in ten plates; Venus standing in a shell, from a picture by Corregio, and many more, of which perhaps the most delicate is the holy family with angels, after Carlo Maratti."

SMITH, Dr Adam, the celebrated author of the *Enquiry into the Nature and Causes of the Wealth of Nations*, was the only son of Adam Smith comptroller of the customs at Kirkcaldy, and of Margaret Douglas, daughter of Mr Douglas of Stratherry. He was born at Kirkcaldy on the 5th June 1723, a few months after the death of his father. His constitution during his infancy was infirm and feeble, and required all the care of his surviving parent. When only three years old he was carried by his mother to Stratherry on a visit to his uncle Mr Douglas; and happening one day to be amusing himself alone at the door of the house, he was stolen by a party of those vagrants who in Scotland are called *strollers*. Luckily he was missed immediately, and the vagrants pursued and overtaken in Leslie wood; and thus Dr Smith was preserved to extend the bounds of science, and reform the commercial policy of Europe.

He received the rudiments of his education in the school of Kirkcaldy under David Miller, a teacher of considerable eminence, and whose name deserves to be recorded on account of the great number of eminent men which that seminary produced while under his direction. Dr Smith, even while at school, attracted notice by his passionate attachment to books, and by the extraordinary powers of his memory; while his friendly and generous disposition gained and secured the affection of his schoolfellows. Even then he was remarkable for those habits which remained with him through life, of speaking to himself when alone and of absence in company. He was sent in 1737 to the university of Glasgow, where he remained till 1742, when he went

Smith.
The Duke's
Collection
of
Engraving

the
Royal
Society
of
Glasgow

at Balliol college Oxford, as an excellent writer on Smith's foundation. His favourite pursuits while at the university were mathematics and natural philosophy. After his removal to England he frequently employed himself in translating, particularly from the French, with a view to the improvement of his own style; a practice which he often recommended to all who wished to cultivate the art of composition. It was probably this art to that he applied himself with the greatest care to the study of languages, of which, both ancient and modern, his knowledge was uncommonly extensive and accurate.

After seven years residence at Oxford he returned to Kirkcaldy, and lived two years with his mother without any fixed plan for his future life. He had been designed for the church of England; but unwilling the ecclesiastical profession, he resolved to abandon it altogether, and to limit his ambition to the prospect of obtaining some of those preferments to which literary attainments lead in Scotland. In 1743 he fixed his residence in Edinburgh, and for three years read a course of lectures on rhetoric and belles lettres under the patronage of Lord Kames. In 1751 he was elected professor of logic in the university of Glasgow, and the year following was removed to the professorship of moral philosophy, vacant by the death of Mr Francis Craigie, the immediate predecessor of Dr Hume. In this situation he continued 13 years; a period by which frequently he looks back to as the most useful; that of his life. His lectures on moral philosophy were divided into four parts: The first contained natural theology; in which he considered the proofs of the being and attributes of God, and those truths on which religion is founded; the second comprehended ethics, this is so called, and consists chiefly of those duties which he afterwards published in his theory of moral sentiments; in the third part he treated more at length of that part of morality called politics; and which, being susceptible of precise and concrete rules, is for that reason capable of a full and accurate explanation; in the last part of his lectures he examined those political regulations which are founded, not upon the principle of justice, but of expediency and which are calculated to increase the riches, the power, and the prosperity of a state. Considerations were considered the political institutions relating to commerce, to finance, to ecclesiastical and military governments. This contained the substance of the *Theory of Morals*. In delivering his lectures he seldom aimed entirely to exhortatory eloquence; his style was plain and unadorned, and he never failed to be instructive. His reputation soon rose very high, and many students resorted to the university merely upon his account.

When his acquaintance with Mr Hume first commenced is uncertain, but it had ripened into friendship before the year 1752.

In 1759 he published his *Theory of Moral Sentiments*, a work which derives, by extended his reputation. For, though several of his essays had been published, it must be allowed by all to be a singular effort of invention, ingenuity, and ability. Besides, it contains a great variety of interesting truths, and, though the author has sometimes been accused, he has had the merit of directing the attention of philosophers to a class of human nature which had formerly in a great

measure neglected their notice. It abounds everywhere with the pure and most elevated maxims concerning the proper conduct of life; and when the subject of his work leads him to address the imagination and the heart, the variety and facility of his illustrations, the richness and diversity of his eloquence, and the skill with which he wins the attention and commands the passions of his readers, have him among our British moralists without a rival.

Towards the end of 1763 Dr Smith received an invitation from Mr Charles Townsend to accompany the duke of Buccleugh on his travels; and the liberal terms in which this proposal was made induced him to resign his office at Glasgow. He joined the duke of Buccleugh at London early in the year 1764, and set out with him for the continent in the month of March following. After a stay of about ten days at Paris, they proceeded to Toulon, where they fixed their residence for about 18 months; thence they went by a pretty extensive route through the south of France to Geneva, where they passed two months. About Christmas 1765 they returned to Paris, and remained there till October following. The society in which Dr Smith passed these ten months may be conceived in consequence of the recommendation of Mr Hume, Turgot, Quatrefeuille, Necker, d'Alembert, Helvetius, Marmontel, Madame Riccoboni, were among the number of his acquaintances; and some of them he continued ever after to reckon among the number of his friends. In October 1766 the duke of Buccleugh returned to England.

Dr Smith spent the next ten years of his life with his mother at Kirkcaldy, occupied habitually in intense study, but unbinding his mind at times in the company of some of his old schoolfellows, who still continued to reside near the place of their birth. In 1776 he published his *Inquiry into the Nature and Causes of the Wealth of Nations*; a work to universally known, that any passage on it would be useless. The variety, importance, and (may we not add) novelty, of the information which it contains; the skill and comprehensiveness of mind displayed in the arrangement; the admirable illustrations with which it abounds; together with a plainness and perspicuity which makes it intelligible to all—render it unquestionably the most perfect work which has yet appeared on the general principles of any branch of legislation.

He spent the next two years of his life in London, where he enjoyed the society of some of the most eminent men of the age; but he removed to Edinburgh in 1778, in consequence of having been appointed, at the request of the duke of Buccleugh, one of the commissioners of the customs in Scotland. Here he spent the last twelve years of his life in an ailance which was more than equal to all his wants. But his studies seem to have entirely languished till the infirmities of old age rendered him, when it was too late, of what he yet owed to the public and to his own name. The principal materials of the works which he had announced had long ago been collected, and little probably was wanting but a few years of health and retirement to complete them. The death of his mother, who had accompanied him to Edinburgh in 1781, together with that of his cousin Mr S. Dalrymple in 1788, constituted to facilitate these projects. They had been the objects of his attention

Smith
Smith

for more than 60 years, and in that society he had enjoyed from his infancy all that he ever knew of the endowments of a family. He was now more and better; and though he bore his loss with equanimity, and regained apparently his former cheerfulness, yet his health and strength gradually declined till the period of his death, which happened in July 1795. Some days before his death he ordered all his papers to be burnt except a few essays, which have since been published.

Of the originality and comprehensiveness of his views; the extent, the variety, and the correctness of his information; the inexhaustible fertility of his invention—he has left behind him lasting monuments. To his private worth, the most certain of all testimonies may be found in that confidence, respect, and attachment, which followed him through all the various relations of life. He was habitually absent in conversation, and was not when he spoke to deliver his ideas in the form of a lecture. He was rarely known to start a new topic himself, or to appear unprepared upon those topics that were introduced by others. In his external form and appearance there was nothing uncommon. When perfectly at ease, and when warmed with conversation, his gestures were animated and not ungraceful; and in the society of those he loved, his features were often brightened by a smile of inexpressible benignity. In the company of strangers, his tendency to absence, and perhaps still more his consciousness of that tendency, rendered his manners somewhat embarrassed; an effect which was probably not a little begettered by those speculative ideas of propriety which his recluse habits tended at once to perfect in his conception, and to diminish his power of realizing.

SMITHIA, a genus of plants belonging to the *Asclepiadales* class; and in the natural method ranking under the 32d order, *Papilionaceae*. See *BOTANY INDICA*.

SMITHERY, a smith's shop; also the art of smithing, by which iron is wrought into any shape by means of fire, hammering, filing, &c.

SMITHING-TORSE, in a ship, is a small rope fastened to the mizen-yard arm, below the cork, and is always furled up with the mizen-hill, even to the upper end of the yard, and thence it comes down to the prop. Its use is to hoist the mizen-hill without striking down the yard, which is easily done, because the mizen-hill is hoisted up only with a few turns; and therefore when this torse is pulled hard, it breaks all the ropes, and, and to the fall roll down of itself. The fall's parallel is, *inside the mizen*; whence this torse takes its name, that is, *inside* by this torse that the fall may fall down.

SMOKE, a dense elastic vapour, arising from burning bodies. As this vapour is extremely disagreeable to the senses, and often prejudicial to the health, mankind have often on several occasions endeavoured to enjoy the benefit of fire, without being annoyed by smoke. The most universal of these contrivances is a smoke-pipe rising from the chamber in which the fire is kindled to the top of the building, through which it travels upwards, and is dispersed into the atmosphere. These tubes are called *chimneys*; which, when constructed in a proper manner, carry off the smoke with great ease, when imperfectly conducted, they convey it to the neighbouring streets, to the great annoyance of the inhabitants. As our nations are generally supposed to have a very imperfect

knowledge of the manner in which chimneys ought to be built, we can hardly perform a more acceptable service to the public than to point out the manner in which they ought to be constructed, so as to carry off the smoke entirely; as well as to explain the causes from which the defects so often complained of generally proceed, and the method of removing them.

Those who would be acquainted with this subject, should begin by considering on what principle smoke rises in any chimney. At first many are apt to think that smoke is in its nature, and of itself, specifically lighter than air, and rises in it for the reason that cork rises in water. There is no cause why smoke should not rise in the chimney though the room be ever so cold. Others think there is a power in chimneys to draw up the smoke, and that there are different forms of chimneys which afford more or less of this power. These amuse themselves with searching for the best form. The equal dimensions of a funnel in its whole length, is not thought sufficient, and it is made, for fancied reasons, sometimes tapering and narrowing from below upwards, and sometimes the contrary, &c. &c. A simple experiment or two may serve to give more correct ideas. Having lighted a pipe of tobacco, place the stem to the bottom of a decanter half filled with cold water; then putting a rag over the bowl, blow through it, and make the rag descend in the bend of the pipe, from the end of which it will rise in bubbles through the water; and being thus cold, will not ascend, and the vapour that in the neck of the decanter, but remains depending from the end resting on the surface of the water. This shows that smoke is really heavier than air, and that it is carried upwards only when attached to or acted upon by air that is heated, and thereby rendered and rendered specifically lighter than the air in its neighbourhood.

Smoke being rarely seen but in company with heated air, and its upward motion being visible, though that of the heated air that drives it is not so, has naturally given rise to the error. It is now well known that air is a fluid which has weight as well as others, though it gets so very lighter than water; that heat makes the particles of air recede from each other, and take up more space, so that the same weight of air heated will have more bulk than equal weight of cold air which may fall and be in that case made rise, being forced up by a less fresh colder and heavier air, which forces to get under it and take its place. That air is so raised or expanded by heat, may be proved to rise in a small bladder, or a black blown bladder, which laid before a fire, will in a few seconds grow tight, and burst.

Another experiment may be to take a glass tube about an inch in diameter, and 12 inches long, open at both ends, and fixed upright on legs so that it need not be handled for the hands might warm it. At the end of a quill fallen five or six inches of the finest light filament of silk, so that it may be held either above the upper end of the tube or under the lower end, your warm hand being at a distance by the length of the quill. If there were any motion of air through the tube, it would maintain itself by its effect on the silk; but if the tube and the air in it were of the same temperature with the surrounding air, there will not be such a motion, whatever may be the form of the tube, whether conical, cylindrical, narrow below and widening up-

wards, or the contrary, the air in it will be quiescent. Warm the tube, and you will find as long as it continues warm, a constant current of air entering below and passing up through it till discharged at the top; because the warmth of the tube being communicated to the air it contains, rarefies that air, and makes it lighter than the air without; which therefore presses in below, forces it upwards, follows and takes its place, and is rarefied in its turn. And, without warming the tube, if you hold under it a knob of hot iron, the air thereby heated will rise and fill the tube, going out at its top; and this motion in the tube will continue as long as the knob remains hot, because the air entering the tube below, is heated and rarefied by passing near and over that knob.

That this motion is produced merely by the difference of specific gravity between the fluid within and that without the tube, and not by any fancied form of the tube itself, may appear by plunging it into water contained in a glass jar a foot deep, through which such motion might be seen. The water within and without the tube being of the same specific gravity, balance each other, and both remain at rest. But take out the tube, stop its bottom with a finger, and fill it with olive oil, which is lighter than water; then stopping the top, place it as before, its lower end under water, its top a very little above. As long as you keep the bottom stopped the fluids remain at rest; but the moment it is unstoped, the heavier enters below, forces up the lighter, and takes its place: and the motion then ceases, merely because the new fluid cannot be successfully made lighter, as air may be by a warm tube.

In fact, no form of the funnel of a chimney has any share in its operation or effect respecting smoke except its height. The longer the funnel, if erect, the greater its force when filled with heated and rarefied air to draw in below and drive up the smoke, if one may, in compliance with custom, use the expression *draw*, when in fact it is the superior weight of the surrounding atmosphere that presses to enter the funnel below, and so drives up before it the smoke and warm air it meets with in its passage.

What is it then which makes a smoky chimney, that is, a chimney which, instead of conveying up all the smoke, discharges a part of it into the room, offending the eyes and damaging the furniture?

The causes of this effect may be reduced to *nine*, differing from each other, and therefore requiring different remedies.

1. *Smoky chimneys in a new house are such frequently from mere want of air.* The workmanship of the rooms being all good, and just out of the workman's hands, the joints of the boards of the flooring, and of the panels of wainscoting, are all true and tight; the more so as the walls, perhaps not yet thoroughly dry, preserve a dampness in the air of the room which keeps the wood-work swelled and close. The doors and the shutters too, being worked with truth, shut with exactness, so that the room is as tight as a snuff-box, no passage being left open for air to enter except the key-hole, and even that is sometimes covered by a little dropping shutter. Now if smoke cannot rise but as connected with rarefied air, and a column of such air, suppose it filling the funnel, cannot rise unless other air be admitted to supply its place: and if therefore no current of air enter

the opening of the chimney—there is nothing to prevent the smoke from coming out into the room. If the motion upwards of the air in a chimney that is freely supplied be observed by the rising of the smoke or a feather in it, and it be considered that in the time such feather takes in rising from the fire to the top of the chimney, a column of air equal to the content of the funnel must be discharged, and an equal quantity supplied from the room below, it will appear absolutely impossible that this operation should go on if the tight room is kept shut; for were there any force capable of drawing constantly so much air out of it, it must soon be exhausted like the receiver of an air-pump, and no animal could live in it. Those therefore who stop every crevice in a room to prevent the admission of fresh air, and yet would have their chimney carry up the smoke, require inconsistencies, and expect impossibilities. Yet under this situation it is not uncommon to see the owner of a new house in despair, and ready to sell it for much less than it cost; conceiving it uninhabitable because not a chimney in any one of its rooms will carry off the smoke unless a door or window be left open. Much experience has also been made to alter and amend new chimneys which had really no fault: in one house particularly which Dr Franklin knew that belonged to a nobleman in Westminster, that expence amounted to no less than 300*l.* after his house had been, as he thought, finished at all charges paid. And after all, several of the alterations were ineffectual, for want of understanding the true principles.

Remedies. When you find on trial that opening the door or a window enables the chimney to carry up all the smoke, you may be sure that want of air from without was the cause of its smoking. "I say from without" (adds Dr Franklin), to guard you against a common mistake of those who may tell you the room is large, contains abundance of air sufficient to supply any chimney, and therefore it cannot be that the chimney wants air. These reasoners are ignorant that the largeness of a room, if tight, is in this case of small importance, since it cannot part with a chimneyfull of its air without occasioning so much vacuum; which it requires a great force to effect, and could not be borne if effected."

It appearing plainly then, that some of the outward air must be admitted, the question will be, how much is absolutely necessary? for you would avoid admitting more, as being contrary to one of your intentions in having a fire, viz. that of warming your room. To discover this quantity, that the door gradually while a middling fire is burning, till you find that before it is quite shut the smoke begins to come out into the room; then open it a little till you perceive the smoke comes out no longer. There hold the door, and observe the width of the open crevice between the edge of the door and the rabbet it should shut into. Suppose the distance to be half an inch, and the door eight feet high; you find thence that your room requires an entrance for air equal in area to 96 half inches, or 48 square inches, or a passage of 6 inches by 8. This, however, is a large supposition; there being few chimneys that, having a moderate opening and a tolerable height of funnel, will not be satisfied with such a crevice of a quarter of an inch: Dr Franklin found a square of 6 by 6, or 36 square inches, to be pretty good medium that

Smoke. that will serve for most chimneys. High funnels with small and low openings may indeed be supplied through a less space; because, for reasons that will appear hereafter, the force of levity, if one may so speak, being greater in such funnels, the cool air enters the room with greater velocity, and consequently more enters in the same time. This, however, has its limits; for experience shows, that no increased velocity is occasioned has made the admission of air through the key-hole equal in quantity to that through an open door, though through the door the current moves slowly, and through the key-hole with great rapidity.

It remains then to be considered, how and where this necessary quantity of air from without is to be admitted, so as to be least inconvenient: for if at the door, left so much open, the air thence proceeds directly to the chimney, and in its way comes cold to your back and head as you sit before your fire. If you keep the door shut, and raise a little the sash of your window, you feel the same inconvenience. Various have been the contrivances to avoid this; such as bringing in fresh air through pipes in the joints of the chimney, which pointing upwards should blow the smoke up the funnel; opening passages into the funnel above, to let in air for the same purpose. But these produce an effect contrary to that intended: for as it is the constant current of air passing from the room through the opening of the chimney into the funnel which prevents the smoke from coming out into the room, if you supply the funnel by other means or in other ways with the air which it wants, and especially if that air be cold, you diminish the force of that current, and the smoke in its efforts to enter the room finds less resistance.

The wanted air must then indispensably be admitted into the room, to supply what goes off through the opening of the chimney. M. Gauger, a very ingenious and intelligent French writer on the subject, proposes with judgement to admit it above the opening of the chimney; and to prevent inconvenience from its coldness, he directs that it may be so made, that it shall pass in its entrance through winding cavities made behind the iron back and sides of the fire-place, and under the iron hearth-plate; in which cavities it will be warmed, and even heated, so as to contribute much, instead of cooling, to the warming of the room. This invention is excellent in itself, and may be used with advantage in building new houses; because the chimneys may then be so disposed as to admit conveniently the cold air to enter such passages: but in houses built without such views, the chimneys are often so situated as not to afford that convenience without great and expensive alterations. Easy and cheap methods, though not quite so perfect in themselves, are of more general utility; and such are the following.

In all rooms where there is a fire, the body of air warmed and rarefied before the chimney is continually changing place, and making room for other air that is to be warmed in its turn. Part of it enters and goes up the chimney, and the rest rises and takes place near the ceiling. If the room be lofty, that warm air remains above our heads as long as it continues warm, and we are little benefited by it, because it does not descend till it is cooler. Few can imagine the difference of climate between the upper and lower parts of such a room, who have not tried it by the thermometer, or by

going up a ladder till their heads are near the ceiling. It is then among this warm air that the wanted quantity of outward air is best admitted, with which being mixed, its coldness is abated, and its resistance diminished so as to become insensible. This may be easily done by drawing down about an inch the upper sash of a window; or, if not moveable, by cutting such a crevice through its frame; in both which cases it will be well to place a thin shelf of the length to conceal the opening, and sloping upwards, to direct the entering air horizontally along and under the ceiling. In some houses the air may be admitted by such a crevice made in the wainscot, cornice, or plastering, near the ceiling and over the opening of the chimney. This, if practicable, is to be chosen, because the entering cold air will there meet with the warmest rising air from before the fire, and be soon tempered by the mixture. The same kind of shelf should also be placed here. Another way, and not a very difficult one, is to take out an upper pane of glass in one of your sashes, set it in a tin frame, giving it two springing angular sides, and then replacing it, with hinges below on which it may be turned to open more or less above. It will then have the appearance of an internal sky-light. By drawing this pane in, more or less, you may admit what air you find necessary. Its position will naturally throw that air up and along the ceiling. This is what is called in France a *Wassel das*? As this is a German question, the invention is probably of that nation, and takes its name from the frequent asking of that question when it first appeared. In England some have of late years cut a round hole about five inches diameter in a pane of the sash and placed against it a circular plate of tin hung on an axis, and cut into vanes; which, being separately bent a little obliquely, are acted upon by the entering air, so as to force the plate continually round like the vanes of a windmill. This admits the outward air, and by the continual whirling of the vanes, does in some degree disperse it. The noise only is a little inconvenient.

2. A second cause of the smoking of chimneys is, their openings in the room being too large; that is, too wide, too high, or both. Architects in general have no other ideas of proportion in the opening of a chimney than what relate to symmetry and beauty respecting the dimensions of the room; while its true proportion respecting its function and utility depends on quite other principles; and they might as properly proportion the step in a staircase to the height of the story, instead of the natural elevation of men's legs in mounting. The proportion then to be regarded, is what relates to the height of the funnel. For as the funnels in the different stories of a house are necessarily of different heights or lengths, that from the lowest floor being the highest or longest, and those of the other floors shorter and shorter, till we come to those in the garrets, which are of course the shortest; and the force of drift being, as already said, in proportion to the height of funnel filled with rarefied air, and a current of air from the room into the chimney, sufficient to fill the opening, being necessary to oppose and prevent the smoke from coming out into the room; it follows, that the openings of the longest funnels may be larger, and that those of the shorter funnels should be smaller. For if there be a large opening to a chimney that does not draw strongly, the funnel

Smoke.

may happen to be furnished with the air which it demands by a partial current entering on one side of the opening, and leaving the other side free of any opposing current, may permit the smoke to issue there into the room. Much too of the force of draft in a funnel depends on the degree of rarefaction in the air it contains, and that depends on the nearness to the fire of its passage in entering the funnel. If it can enter far from the fire on each side, or far above the fire, in a wide or high opening, it receives little heat in passing by the fire, and the contents of the funnel are by those means less different in levity from the surrounding atmosphere, and its force in drawing consequently weaker. Hence it too large an opening be given to chimneys in upper rooms, those rooms will be smoky: On the other hand, if too small openings be given to chimneys in the lower rooms, the entering air operating too directly and violently on the fire, and afterwards strengthening the draft as it ascends the funnel, will consume the fuel too rapidly.

Remedy. As different circumstances frequently mix themselves in these matters, it is difficult to give precise dimensions for the openings of all chimneys. Our fathers made them generally much too large: we have lessened them; but they are often still of greater dimensions than they should be, the human eye not being easily reconciled to sudden and great changes. If you suspect that your chimney smokes from the too great diameter of its opening, contract it by placing moveable boards so as to lower and narrow it gradually till you find the smoke no longer issues into the room. The proportion so found will be that which is proper for that chimney, and you may employ the bricklayer or mason to reduce it accordingly. However, as in building new houses something must be sometimes hazarded, Dr Franklin proposes to make the openings in the lower rooms about 30 inches square and 18 deep, and those in the upper only 18 inches square and not quite so deep; the intermediate ones diminishing in proportion as the height of the funnel is diminished. In the larger openings, billets of two feet long, or half the common length of cordwood, may be burnt conveniently; and for the smaller, such wood may be sawed into thirds. Where coals are the fuel, the grates will be proportioned to the openings. The same depth is nearly necessary to all, the funnels being all made of a size proper to admit a chimney-sweeper. If in large and elegant rooms custom or fancy should require the appearance of a larger chimney, it may be furnished of expensive marginal decorations, in marble, &c. But in time perhaps, that which is fitted in the nature of things may come to be thought handsome.

3. Another cause of smoky chimneys is *too short a funnel*. This happens necessarily in some cases, as where a chimney is required in a low building; for, if the funnel be raised high above the roof, in order to strengthen its draft, it is then in danger of being blown down, and crushing the roof in its fall.

Remedies. Contract the opening of the chimney, so as to oblige all the entering air to pass through or very near the fire; whereby it will be more heated and rarefied, the funnel itself be more warmed, and its contents have more of what may be called the force of levity, so as to rise strongly and maintain a good draft at the opening.

Or you may in some cases, to advantage, build additional stories over the low building, which will support a high funnel.

If the low building be used as a kitchen, and a contraction of the opening therefore inconvenient, a large one being necessary, at least when there are great diners, for the free management of so many cooking utensils; in such case the best expedient perhaps would be to build two more funnels joining to the first, and having three moderate openings, one to each funnel, instead of one large one. When there is occasion to use but one, the other two may be kept shut by sliding plates, hereafter to be described; and two or all of them may be used together when wanted. This will indeed be an expence, but not an useless one, since your cooks will work with more comfort, see better than in a smoky kitchen what they are about, your victuals will be cleaner dressed and not taste of smoke, as is often the case; and to render the effect more certain, a stack of three funnels may be safely built higher above the roof than a single funnel.

The case of too short a funnel is more general than would be imagined, and often found where one would not expect it. For it is not uncommon, in ill-contrived buildings, instead of having a funnel for each room or fire-place, to bend and turn the funnel of an upper room so as to make it enter the side of another funnel that comes from below. By these means the upper room funnel is made short of course, since its length can only be reckoned from the place where it enters the lower room funnel; and that funnel is also shortened by all the distance between the entrance of the second funnel and the top of the stack: for all that part being readily supplied with air through the second funnel, adds no strength to the draft, especially as that air is cold when there is no fire in the second chimney. The only easy remedy here is, to keep the opening of that funnel shut in which there is no fire.

4. Another very common cause of the smoking of chimneys is, *their overpowering one another*. For instance, if there be two chimneys in one large room, and you make fires in both of them, the doors and windows close shut, you will find that the greater and stronger fire shall overpower the weaker, from the funnel of which it will draw air down to supply its own demand; which air descending in the weaker funnel, will drive down its smoke, and force it into the room. If, instead of being in one room, the two chimneys are in two different rooms, communicating by a door, the case is the same whenever that door is open. In a very tight house, a kitchen chimney on the lowest floor, when it had a great fire in it, has been known to overpower any other chimney in the house, and draw air and smoke into its room as often as the door communicating with the staircase was opened.

Remedy. Take care that every room have the means of supplying itself from without with the air which its chimney may require, so that no one of them may be obliged to borrow from another, nor under the necessity of lending. A variety of these means have been already described.

5. Another cause of smoking is, *when the tops of chimneys are commanded by higher buildings, or by a hill*, so that the wind blowing over such eminences falls like water over a dam, sometimes almost perpendicularly on

Smoke.

Smoke. the tops of the chimneys that lie in its way, and beats down the smoke contained in them.

Fig. 3. To illustrate this, let A (fig. 3.) represent a small building at the side of a great rock B, and the wind coming in the direction CD; when the current of air comes to the point D, being hurried forward with great velocity, it goes a little forward, but soon descends downward, and gradually is reflected more and more inward, as represented by the dotted lines EE, &c. so that, descending downwards upon the top of the chimney A, the smoke is beat back again into the apartments.

It is evident that houses situated near high hills or thick woods will be in some measure exposed to the same inconvenience; but it is likewise plain, that if a house be situated upon the slope of a hill (as at F, fig. 3.), it will not be in any danger of smoke when the wind blows towards that side of the hill upon which it is situated; for the current of air coming over the housetop in the direction GH, is immediately changed by the slope of the hill to the direction HC, which powerfully draws the smoke upward from the top of the chimney. But it is also evident, that a house in this situation will be liable to smoke when the wind blows from the hill; for the current of air coming downward in the direction CH, will beat downward on the chimney F, and prevent the smoke from ascending with freedom. The effect will be much heightened if the doors and windows are chiefly in the lowermost side of the house.

Remedy. That commonly applied to this case is a turncap made of tin or plate iron, covering the chimney above and on three sides, open on one side, turning on a spindle; and which being guided or governed by a vane always presents its back to the current. This may be generally effectual, though not certain, as there may be cases in which it will not succeed. Raising your funnels if practicable, so as their tops may be higher, or at least equal, with the commanding eminence, is more to be depended on. But the turning cap, being easier and cheaper, should first be tried. "If obliged to build in such a situation, I would choose (says Dr Franklin) to place my doors on the side next the hill, and the backs of my chimneys on the farthest side; for then the column of air falling over the eminence, and of course pressing on that below, and forcing it to enter the doors or *was-iff-dates* on that side, would tend to balance the pressure down the chimneys, and leave the funnels more free in the exercise of their functions."

6. There is another case which is the reverse of that last mentioned. It is where the commanding eminence is farther from the wind than the chimney commanded. To explain this a figure may be necessary. Suppose then a building whose side AB happens to be exposed to the wind, and forms a kind of dam against its progress. Suppose the wind blowing in the direction FE. The air obstructed by this dam or building AB will like water press and search for passages through it; but finding none, it is beat back with violence, and spreads itself on every side, as is represented by the curved lines e, e, e, e, e, e. It will therefore force itself down the small chimney C, in order to get through by some door or window open on the other side of the building. And if there be a fire in such chimney, its smoke is of course beat down, and fill the room.

Remedy. There is but one remedy, which is to raise such a funnel higher than the roof, supporting it if necessary by iron bars. For a turncap in this case has no effect, the dammed-up air pressing down through it in whatever position the wind may have placed its opening.

Dr Franklin mentions a city in which many houses are rendered smoky by this operation. For their kitchens being built behind, and connected by a passage with the houses, and the tops of the kitchen-chimneys lower than the tops of the houses, the whole side of a street when the wind blows against its back forms such a dam as above described; and the wind lo obstructed forces down those kitchen-chimneys (especially when they have but weak fires in them) to pass through the passage and pour into the street. Kitchen-chimneys so formed and situated have another inconvenience. In summer, if you open your upper room windows for air, a light breeze blowing over your kitchen-chimney towards the house, though not strong enough to force down its smoke as aforesaid, is sufficient to waft it into your windows, and fill the rooms with it; which, besides the disagreeableness, damages your furniture.

7. Chimneys, otherwise drawing well, are sometimes made to smoke by the improper and inconvenient situation of a door. When the door and chimney are on the same side of the room, if the door being in the corner is made to open against the wall, which is common, as being there, when open, more out of the way, it follows, that when the door is only opened in part, a current of air rushing in passes along the wall into and across the opening of the chimney, and stirs some of the smoke out into the room. This happens more certainly when the door is shutting, for then the force of the current is augmented, and becomes very inconvenient to those who, warming themselves by the fire, happen to sit in its way.

The remedies are obvious and easy. Either put an intervening screen from the wall round great part of the fireplace; or, which is perhaps preferable, shift the hinges of your door, so as it may open the other way, and when open throw the air along the other wall.

8. A room that has no fire in its chimney is sometimes filled with smoke which is received at the top of its funnel, and descends into the room. Funnels without fires have an effect according to their degree of coldness or warmth on the air that happens to be contained in them. The surrounding atmosphere is frequently changing its temperature; but stacks of funnels covered from winds and sun by the house that contains them, retain a more equal temperature. If, after a warm season, the outward air suddenly grows cold, the empty warm funnels begin to draw strongly upward; that is, they rarely the air contained in them, which of course rises, cooler air enters below to supply its place, is rarefied in its turn, and rises; and this operation continues till the funnel grows cooler, or the outward air warmer, or both, when the motion ceases. On the other hand, if after a cold season the outward air suddenly grows warm and of course lighter, the air contained in the cool funnels being heavier descends into the room; and the warmer air which enters their tops being cold in its turn, and made heavier, continues to descend; and this operation goes on till the funnels are warmed by the passing of warm air through them, or the air itself grows cooler.

When the temperature of the air and of the funnels is nearly equal, the difference of warmth in the air between day and night is sufficient to produce these currents: the air will begin to ascend the funnels as the cool of the evening comes on, and this current will continue till perhaps nine or ten o'clock the next morning, when it begins to hesitate; and as the heat of the day approaches, it falls downwards, and continues so till towards evening, when it again hesitates for some time, and then goes upwards constantly during the night, as before mentioned. Now when smoke issuing from the tops of neighbouring funnels passes over the tops of funnels which are at the time drawing downwards, as they often are in the middle part of the day, such smoke is of necessity drawn into these funnels, and descends with the air into the chamber.

The remedy is to have a sliding plate that will fit perfectly the offending funnel. Dr Franklin has thus described it: "The opening of the chimney is contracted by brick-work faced with marble slabs to about two feet between the jams, and the breast brought down to within about three feet of the hearth. An iron frame is placed just under the breast, and extending quite to the back of the chimney, so that a plate of the same metal may slide horizontally backwards and forwards in the grooves on each side of the frame. This plate is just so large as to fill the whole space, and that the chimney entirely when thrust quite in, which is convenient when there is no fire. Draw it out, so as to leave between its further edge and the back a space of about two inches; this space is sufficient for the smoke to pass; and so large a part of the funnel being flopped by the rest of the plate, the passage of warm air out of the room, up the chimney, is obstructed and retarded; and by those means much cold air is prevented from coming in through crevices, to supply its place. This effect is made manifest three ways. 1. When the fire burns briskly in cold weather, the howling or whistling noise made by the wind, as it enters the room through the crevices, when the chimney is open as usual, ceases as soon as the plate is slid in to its proper distance. 2. Opening the door of the room about half an inch, and holding your hand against the opening, near the top of the door, you feel the cold air coming in against your hand, but weakly, if the plate be in. Let another person suddenly draw it out, so as to let the air of the room go up the chimney, with its usual freedom where chimneys are open, and you immediately feel the cold air rushing in strongly. 3. If something be set against the door, just sufficient, when the plate is in, to keep the door nearly shut, by resisting the pressure of the air that would force it open: then, when the plate is drawn out, the door will be forced open by the increased pressure of the outward cold air endeavouring to get in to supply the place of the warm air that now passes out of the room to go up the chimney. In our common open chimneys, half the fuel is wasted, and its effect lost; the air it has warmed being immediately drawn off."

Chimneys which generally draw well, do nevertheless sometimes give smoke into the rooms, *it being driven down by strong winds passing over the tops of their funnels*, though not descending from any commanding eminence. This case is most frequent where the funnel is short and the opening turned from the wind. It is the more grievous, when it happens to be a cold wind that produ-

ces the effect, because when you most want your fire you are sometimes obliged to extinguish it. To understand this, it may be considered that the rising light air, to obtain a free issue from the funnel, must push out of its way or oblige the air that is over it to rise. In a blue of calm or of little wind this is done visibly; for we see the smoke that is brought up by that air rise in a column above the chimney: but when a violent current of air, that is, a strong wind, passes over the top of a chimney, its particles have received so much force, which keeps them in a horizontal direction and follow each other so rapidly, that the rising light air has not strength sufficient to oblige them to quit that direction and move upwards to permit its issue.

Remedies. In Venice, the custom is to open or widen the top of the flue, rounding it in the true form of a funnel. In other places the contrary is practiced; the tops of the flues being narrowed inwards, so as to form a slit for the issue of the smoke, long as the breadth of the funnel, and only four inches wide. This seems to have been contrived on a supposition that the entry of the wind would thereby be obstructed and perhaps it might have been imagined, that the whole force of the rising warm air being condensed, as it were, in the narrow opening, would thereby be strengthened, so as to overcome the resistance of wind. This, however, did not always succeed; for when the wind was at north-east and blew fast, the smoke was forced down by fits into the room where Dr Franklin commonly sat, so as to oblige him to shift the fire into another. The position of the slit of this funnel was indeed north-east and south-west. Perhaps if it had lain across the wind, the effect might have been different. But on this we can give no certainty. It seems a matter proper to be referred to experiment. Possibly a turncap might have been serviceable, but it was not tried.

With all the science, however, that a man shall suppose himself possessed of in this article, he may sometimes meet with cases that shall puzzle him. "I once lodged (says Dr Franklin) in a house at London, which in a little room had a single chimney and funnel. The opening was very small, yet it did not keep in the smoke, and all attempts to have a fire in this room were fruitless. I could not imagine the reason, till at length observing that the chamber over it, which had no fireplace in it, was always filled with smoke when a fire was kindled below, and that the smoke came through the cracks and crevices of the window; I had the window taken down, and discovered that the funnel which went up behind it had a crack many feet in length, and wide enough to admit my arm; a breach very dangerous with regard to fire, and occasioned probably by an apparent irregular settling of one side of the house. The air entering this breach freely, destroyed the drawing force of the funnel. The remedy would have been, filling up the breach, or rather rebuilding the funnel: but the landlord rather chose to stop up the chimney."

"Another puzzling case I met with at a friend's country house near London. His bed room had a chimney in which, he told me, he never could have a fire, for all the smoke came out into the room. I determined myself I could easily find the cause and prescribe the cure. I opened the door, and perceived it was not want of air. I made a temporary contraction of the opening of the chimney, and found that it was not its being

being too large that caused the smoke to flow. I went out and looked up at the top of the chimney: its funnel was joined in the same track with others: some of them shorter, that drew very well, and I saw nothing to prevent its doing the same. In fine, after every other examination I could think of, I was obliged to own the insufficiency of my skill. But my friend, who made no pretension to such kind of knowledge, afterwards discovered the cause himself. He got to the top of the funnel by a ladder, and looking down found it filled with twigs and straw cemented by earth and lined with feathers. It seems the house after being built, had it not empty some years before he occupied it; and he concluded that some large birds had taken the advantage of its retired situation to make their nest there. The rubbish, considerable in quantity, being removed, and the funnel cleared, the chimney drew well, and gave satisfaction.¹⁷

Chimneys whose funnels go up in the north wall of a house, and are exposed to the north winds, are not so apt to draw well as those in a south wall: because when rendered cold by those winds, they draw downwards.

Chimneys enclosed in the body of a house are better than those whose funnels are exposed in cold walls.

Chimneys in stacks are apt to draw better than separate funnels, because the funnels that have constant fires in them warm the others in some degree that have none.

SMOKE JACK. This ingenious machine is of German origin, and Mellinger, in his *Collection of Mechanical Performances*, says it is very ancient, being represented in a painting at Nuremberg, which is known to be older than the year 1250.

Its construction is abundantly simple. An upright iron spindle G A (fig. 5), placed in the narrow part of the kitchen chimney, turns round on two points H and I. The upper one H passes through an iron bar, which is built in across the chimney; and the lower pivot I is of tempered steel, and is conical or pointed, resting in a conical bed-metal socket fixed on another cross bar. On the upper end of the spindle is a circular fly G, consisting of 4, 6, 8, or more thin iron plates, set obliquely on the spindle like the sails of a windmill, as we shall describe more particularly by and by. Near the lower end of the spindle is a pinion A, which works in the teeth of a horizontal or face wheel B, turning on a horizontal axis BC. One pivot of this axis turns in a cock fixed on the cross bar, which supports the lower end of the upright spindle H, and the other pivot turns in a cock fixed on the side wall of the chimney; so that this axis is parallel to the front of the chimney. On the remote end of this horizontal axle there is a small pulley C, having a deep angular groove. Over this pulley there passes a chain CDE, in the lower hitch of which hangs the large pulley E of the spit. This end of the spit turns loosely between the branches of the fork of the rack or raxer F, but without resting on it. This is on the top of a moveable stand, which can be shifted nearer to or farther from the fire. The other end turns in one of the notches of another rack. The number of teeth in the pinion A and wheel B, and the diameters of the pulleys C and E, are so proportioned that the fly G makes from 12 to 20 turns for one turn of the spit.

The manner of operation of this machine is simple and easy, and should be so. The air which contains the burning of the fuel, and passes through the funnel, is greatly heated, and expanding in volume, it becomes lighter than the neighbouring air, and is therefore pushed by it up the chimney. In like manner all the air which comes over the fire is heated, expanded, becomes lighter, and is driven up the chimney. This is called the *draught* or *current*, but is called with greater propriety be termed the *ascent* of the chimney. As the chimney gradually coverts in its construction, and as the same quantity of heated air passes through every section of it, it is plain that the rapidity of its ascent must be greatest in the narrowest place. There the fly G should be placed, because it will there be exposed to the strongest current. The air, striking the fly vanes obliquely, passes them aside, and thus turns them round with a considerable force. If the joint of meat is exactly balanced on the spit, it is plain that the only resistance to the motion of the fly is what arises from the friction of the plates on the pinion, the friction of the pinion and wheel, the friction of the pivots of the horizontal axis, the friction of the small end of the spit, and the friction of the chain in the top pulley. The whole of this is but a mere trifle. But there is frequently a considerable inequality in the weight of the meat on different sides of the spit, there must therefore be a sufficient overplus of force in the impulse of the ascending air on the vanes of the fly, to overcome this want of equilibrium occasioned by the want of firmness or negligence of the cook. There is, however, commonly enough of power when the machine is properly constructed. The utility of this machine will, we hope, procure us the indulgence of some of our readers, while we point out the circumstances on which its performance depends, and the maxims which should be followed in its construction.

The upward current of air is the moving power, and should be increased as much as possible, and applied in the most advantageous manner. Every thing will increase the current which improves the draught of the chimney, and secures it from smoking. A lucky chimney must always have a weak current. For this particular, therefore, we refer to what has been delivered in the article PNEUMATICS, N^o 359; and the article SMOKE.

With respect to the manner of applying this force, it is evident that the best construction of a windmill sails will be nearly the best construction for the fly. According to the usual theory of the impulse of fluids, the greatest effective impulse (that is, in the direction of the fly's motion) will be produced if the plane of the vane be inclined to the axis in an angle of 54 degrees 46 minutes. But, since we have pronounced this theory to be very defective, we had better take a determination founded on the experiments on the impulse of fluids made by the academy of Paris. These authorities us to say, that 40° or 50 degrees will be the best angle to give the vane: but this must be understood only of that part of it which is close adjoining to the axis. The vane itself must be twisted, or *twisted* on the mill-wheels turn it, and must be much more oblique at its outer extremity. The exact position cannot be determined with any precision, because this depends on the

See the
Sails of
Ja. k.

Plate
cccxcvii.
Fig. 5.

page 415

Smoke-
Jack.

proportion of the velocity of the vane to that of the current of heated air. This is subject to no rule, being changed according to the load of the jack. We imagine that an obliquity of 65 degrees for the outer ends of the vanes will be a good position for the generality of cases. Messinger describes an ingenious contrivance for changing this angle at pleasure, in order to vary the velocity of the motion. Each vane is made to turn round a midrib, which stands out like a radius from the spindle, and the vane is moved by a stiff wire attached to one of the corners adjoining to the axle. These wires are attached to a ring which slides on the spindle like the spreader of an umbrella; and it is stopped on any part of the spindle by a pin thrust through a hole in the spindle and ring. We mention this briefly, it being easily understood by any mechanic, and but of little consequence, because the machine is not susceptible of much precision.

It is easy to see that an increase of the surface of the vanes will increase the power: therefore they should occupy the whole space of the circle, and not consist of four narrow arms like the sails of a windmill. It is better to make many narrow vanes than a few broad ones; as will appear plain to one well acquainted with the mode of impulse of fluids acting obliquely. We recommend eight or twelve at least; and each vane should be so broad, that when the whole is held perpendicular between the eye and the light, no light shall come through the fly, the vanes overlapping each other a *very small matter*. We also recommend the making them of stiff plate. Their weight contributes to the steady motion, and enables the fly, which has acquired a considerable velocity during a favourable position of things, to retain a momentum sufficient to pull round the spit while the heavy side of the meat is rising from its lowest position. In such a situation a light fly soon loses its momentum, and the jack staggers under its load.

It is plain, from what has been said, that the fly should occupy the whole of that section of the vent where it is placed. The vent must therefore be brought to a round form in that place, that none of the current may pass uselessly by it.

It is an important question where the fly should be placed. If in a wide part of the vent, it will have a great surface, and act by a long lever; but the current in that place is slow, and its impulse weak. This is a fit subject of calculation. Suppose that we have it in our choice to place it either as it is drawn in the figure, or farther up at g , where its diameter must be one half of what it is at G . Since the same quantity of heated air passes through both sections, and the section g has only one-fourth of the area of the section G , it is plain that the air must be moving four times faster, and that its impulse is 16 times greater. But the surface on which it is acting is the fourth part of that of the fly G ; the actual impulse therefore is only four times greater, supposing both flies to be moving with the same relative velocity in respect of the current; that is, the rim of each moving with the same portion of the velocity of the current. This will be the case when the small fly turns eight times as often in a minute as the large fly: for the air is moving four times as quick at g , and the diameter of g is one-half of that of G . Therefore, when the small fly is turning eight times as quick as the great

one, there is a quadruple impulse acting at half the distance from the axis. The momentum or energy therefore of the current is double. Therefore, supposing the pinion, wheel, and pulleys of both jacks to be the same, the jack with the small fly, placed in the narrow part of the vent, will be 16 times more powerful.

By this example, more easily understood than a general process, it appears that it is of particular importance to place the fly in an elevated part of the vent, where the area may be much contracted. In order still farther to increase the power of the machine, it would be very proper to lengthen the spindle still more, and to put another fly on it at a considerable distance above the first, and a third above this, &c.

As the velocity of the current changes by every change of the fire, the motion of this jack must be very unsteady. To render it as adjustable as may be to the particular purpose of the cook, the pulley E has several grooves of different diameters, and the spit turns more or less slowly, by the same motion of the fly, according as it hangs in the chain by a larger or smaller pulley or groove.

Such is the construction of the smoke-jack in its most simple form. Some are more artificial and complicated, having, in place of the pulleys and connecting chain, a spindle coming down from the horizontal axis BC . On the upper end of this spindle is a horizontal contrate wheel, driven by a pinion in place of the pulley C . On the lower end is a pinion, driving a contrate wheel in place of the pulley E . This construction is represented in fig. 6. Others are constructed more simply, in Fig. 6. The manner represented in fig. 7. But our first construction has great advantage in point of simplicity, and allows a more easy adjustment of the spit, which may be brought nearer to the fire or removed farther from it without any trouble; whereas, in the others, with a train of wheels and pinions, this cannot be done without several changes of pins and screws. The only imperfection of the pulley is, that by long use the grooves become slippery, and an ill-balanced joint is apt to hold back the spit, while the chain slides in the grooves. This may be completely prevented by making the grooves flat instead of angular (which greatly diminishes the friction), and furnishing them with short studs or pins which take into every third or fourth link of the chain. If the chain be made of the simplest form, with flat links, and each link be made of an exact length (making them all on a mould), the motion will be as easy as with any wheelwork, and without the least chance of slipping.

It is always of importance to avoid this slipping of the chain by balancing the loaded spit. For this purpose it will be extremely convenient to have what is called a *balance-screw*. Let a part of the spit, immediately adjoining to the pulley, be made round, and let an arm be made to turn on it stiffly, so that it may be made fast in any position by a screw. Let a leaden ball be made to slide along this arm, with a screw to fasten it at any distance from the spit. When the meat is spitted, lay it on the racks, and the heaviest side will immediately place itself undermost. Now turn round the balance-screw, so that it may point straight upwards, and make it fast in that position by the screw. Put the leaden ball on it, and slide it inwards or outwards.

Smoke-
Jack.

Fig. 1.

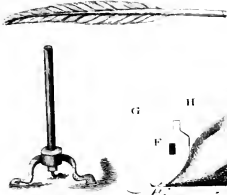

Fig. 3.



Fig. 2.



Fig. 4.

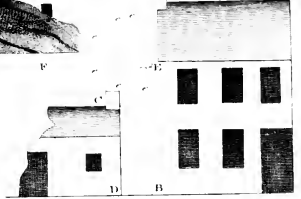
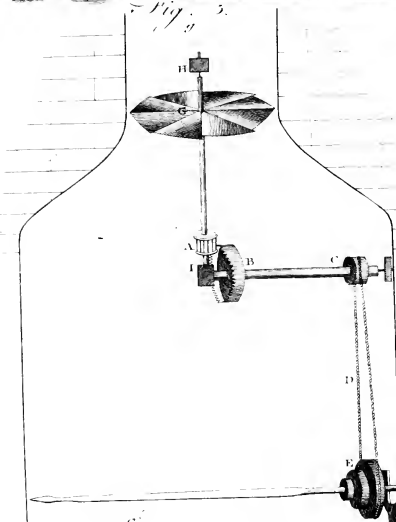

Fig. 5.



SOUNDING Machine.

Fig. 6.

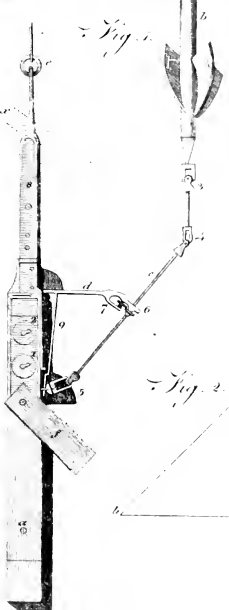

Fig. 7.

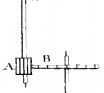

Fig. 8.

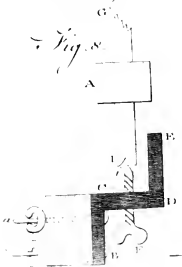

Fig. 9.

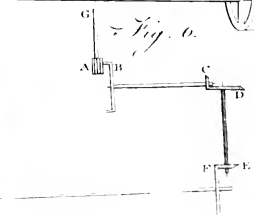

Fig. 10.





Smoke-
Jack.

wards till it exactly balances the heavy side, which will appear by the spit's remaining in any position in which it is put.

The greatest difficulty is to keep the machine in repair. The essential part of it, the first mover, the fly, and the pinion and wheel, by which its motion is transmitted to the rest of the machine, are situated in a place of difficult access, and where they are exposed to violent heat and to the smoke and soot. The whole weight of the fly, resting on the lower pivot I, must exert a great pressure there, and occasion great friction, even when this pinion is reduced to the smallest size that is compatible with the necessary strength. The pivot must be of hardened steel, tapered like an obtuse cone, and must turn in a conical socket, also of hardened steel or of bell-metal; and this seat of pressure and friction must be continually supplied with oil, which it consumes very quickly. It is not sufficient that it be from time to time smeared with an oiled leather; there must be an iron cup formed round the socket, and kept filled with oil. It is surprising how quickly it disappears; it soon becomes clammy by evaporation, and by the soot which gathers about it. The continued rubbing of the pivot and socket wears them both very fast; and this is increased by hard powders, such as sandy dust, that are hurried up by the rapid current every time that the cook stirs the fire. These, getting between the rubbing parts, cause them to grind and wear each other prodigiously. It is a great improvement to invert these rubbing parts. Let the lower end of the spindle be of a considerable thickness, and have a conical hollow nicely drilled in its extremity. Let a blunt-pointed conical pin *l* fit up in the middle of the oil cup, on which the conical hollow of the spindle may rest. Here will be the same steady support, and the same friction as in the other way; but no grinding dust can now lodge between the pivot and its socket: and if this upright pin be screwed up through the bottom of the cup, it may be screwed farther up in proportion as it wears; and thus the upper pivot *g* will never desert its hole, a thing which soon happens in the common way. We can say from experience, that a jack constructed in this way will not require the fifth part of the repairs of one done in the other way.

It is of importance that the whole be so put together as to be easily taken down, in order to sweep the vent, or to be repaired, &c. For this purpose, let the cross bar which carries the lower end of the upright spindle be placed a little on one side of the perpendicular line from the upper pivot hole. Let the cock which carries the oil-cup and the pivot of the horizontal axis BC be screwed to one side of this cross bar, so that the centre of the cup may be exactly under the upper pivot hole. By this construction we have only to unscrew this cock, and then both axles come out of their places at once, and may be replaced without any trouble. We have sketched in fig. 8. the manner in which this may be done, where M represents a section of the lower cross bar. BCDE is the cock, fixed to the bar by the pins which go through both, with finger nuts *a* and *b* on the opposite side. F is the hard steel pin with the conical top, on which the lower end I of the upright spindle AG rests, in the manner recommended as the best and most durable. The pivot of the horizontal axis turns in a hole at E the top of the cock.

After all, we must acknowledge that the smoke-jack is inferior to the common jack that is moved by a weight. It is more expensive at first, and requires more frequent repairs; its motion is not so much under command; it occasions soot to be thrown about the fire, to the great annoyance of the cook; and it is a great encumbrance where we would clean the vent.

SMOKE-Farthings. The pentecostals or customary oblations offered by the dispersed inhabitants within a diocese when they made their procession to the mother or cathedral church, came by degrees into a standing annual rent called *smoke-farthings*.

SMOKE-Silver. Lands were held in some places by the payment of the sum of 6*d.* yearly to the sheriff, called *smoke-silver* (Par. 4. F*iv.* VI.). Smoke-silver and smoke-penny are to be paid to the ministers of divers parishes as a *modus* in lieu of tithes-wood: and in some manors formerly belonging to religious houses, there is still paid, as appendant to the said manors, the ancient Peter-pence, by the name of *smoke-money* (T*reatise*. H*ist.* V*indict.* 77.).—The bishop of London anno 1444 filled out his commission, *Ad levandum se smoke-farthings*, &c.

SMOLENSKO, a large and strong city of Russia, and capital of a palatinate of the same name, with a castle seated on a mountain, and a bishop's see. It is strong by its situation, being in the middle of a wood, and surrounded by almost inaccessible mountains. It has been taken and retaken several times by the Poles and Russians; but these last have had possession of it ever since the year 1687. It is seated on the river Nieper, near the frontiers of Lithuania, 188 miles south-west of Moscow. E. Long. 31. 22. N. Lat. 54. 52.

SMOLENSKO, a duchy and palatinate of Russia, bounded on the north by Biela, on the east by the duchy of Moscow, on the south by that of Severia and the palatinate of Meislaw, and on the west by the same palatinate and by that of Witepsk. It is full of forests and mountains: and the capital is of the same name.

SMOLET, DR TOBIAS, an author whose writings will transmit his name with honour to posterity, was born in the year 1720 at a small village within two miles of Cameron, on the banks of the river Leven. He appears to have received a classical education, and was bred to the practice of physic and surgery; and in the early part of his life served as a surgeon's mate in the navy.

The incidents that befel him during his continuance in this capacity served as a foundation for Roderic Random, one of the most entertaining novels in the English tongue. He was present at the siege of Cartagena; and in the before mentioned novel he has given a faithful, though not very pleasing, account of the management of that ill-conducted expedition, which he censures in the warmest terms, and from circumstances which fell under his own particular observation.

His connection with the sea seems not to have been of long continuance; and it is probable that he wrote several pieces before he became known to the public by his capital productions. The first piece we know of with certainty is a Satire in two parts, printed first in the years 1746 and 1747, and reprinted in a Collection of his Plays and Poems in 1777. About this period, or some time before, he wrote for Mr Rich an opera intitled *Alceste*, which has never been performed nor printed.

Smoke-
Jack.
||
Smolt.

At the age of 18 he wrote a tragedy intitled *The Regicide*, founded on the story of the assassination of James I. of Scotland. In the preface to this piece, published by subscription in the year 1740, he bitterly exclaimed against false patrons, and the duplicity of theatrical managers. The warmth and impetuosity of his temper hurried him, on this occasion, into unjust reflections against the late George Lord Lyttleton and Mr Garrick: the character of the former he characterised in the novel of *Peregrine Pickle*, and he added a burlesque of the *Monody* written by that nobleman on the death of his lady. Against Mr Garrick he made illiberal ill-founded criticisms; and in his novel of *Roderic Random* gave a very unfair representation of his treatment of him respecting this tragedy. Of this conduct he afterwards repented, and acknowledged his errors; though in the subsequent editions of the novel the passages which were the happy effusions of disappointment were not omitted.

However, in giving a sketch of the liberal arts in his *History of England*, he afterwards remarked, "the exhibitions of the stage were improved to the most exquisite entertainment by the talents and management of Garrick, who greatly surpassed all his predecessors of this and perhaps every other nation, in his genius for acting, in the sweetness and variety of his tones, the irresistible magic of his eye, the fire and vivacity of his action, the eloquence of attitude, and the whole pathos of expression.

Not satisfied with this public declaration, he wrote an apology to Mr Garrick in still stronger terms. With these ample concessions, Mr Garrick was completely satisfied: so that in 1757, when Dr Smollet's comedy of the *Repirals*, an after-piece of two acts, was performed at Drury Lane theatre, the latter acknowledged himself highly obliged for the friendly care of Mr Garrick exerted in preparing it for the stage; and still more for his acting the part of Luiffian in *Zara* for his benefit, on the sixth instead of the ninth night, to which he was only intitled by the custom of the theatre.

The *Adventures of Roderic Random*, published in 1748, 2 vols 12mo, a book which still continues to have a most extensive sale, first established the Doctor's reputation. All the first volume and the beginning of the second appear to consist of real incident and character, though certainly a good deal lightened and disguised. The judge, his grandfather, Crab and Pottion the two apothecaries, and Squire Gawky, were characters well known in that part of the kingdom where the scene was laid. Captains Oakham and Whiffle, Doctors Mackflame and Morgan, were also said to be real personages; but their names we have either never learned or have now forgotten. A bookseller and barber long eagerly contended for being shadowed under the name of *Strep*. The Doctor seems to have enjoyed a peculiar felicity in describing his characters, particularly the officers and sailors of the navy. His *Truncheon*, *Hatchway*, and *Pipes*, are highly finished originals; but what exceeds them all, and perhaps equals any character that has yet been painted by the happiest genius of ancient or modern times, is Sir Lieutenant Bowling. This is indeed nature itself; original, *unique*, and *sui generis*.

By the publication of this work the Doctor had acquired so great a reputation, that henceforth a certain

degree of success was insured to every thing known or suspected to proceed from his hand. In the course of a few years, the *Adventures of Peregrine Pickle* appeared; a work of great ingenuity and contrivance in the composition, and in which an uncommon degree of erudition is displayed, particularly in the description of the entertainment given by the Republican Doctor, after the manner of the ancients. Under this personage the late Dr Akenfide, author of *The Pleasures of Imagination*, is supposed to be typified; and it would be difficult to determine whether profound learning or genuine humour predominate most in this episode. Another episode of *The Adventures of a Lady of Quality*, likewise inserted in this work, contributed greatly to its success, and is indeed admirably executed; the materials, it is said, the lady herself (the celebrated *Lady Lane*) furnished.

These were not the only original compositions of this stamp with which the Doctor has favoured the public. Ferdinand Count Fathom, and Sir Launcelot Greaves, are still in the list of what may be called *reading novels*, and have gone through several editions; but there is no injustice in placing them in a rank far below the former. No doubt invention, character, composition, and contrivance, are to be found in both; but then situations are described which are hardly possible, and characters are painted which, if not altogether unexampled, are at least incompatible with modern manners; and which ought not to be, as the scenes are laid in modern times.

The last work which we believe the Doctor published was of much the same species, but cast into a different form—*The Expedition of Humphrey Clinker*. It consists of a series of letters, written by different persons to their respective correspondents. He has here carefully avoided the faults which may be justly charged to his two former productions. Here are no extravagant characters nor unnatural situations. On the contrary, an admirable knowledge of life and manners is displayed; and most useful lessons are given applicable to interesting but to very common situations.

We know not whether the remark has been made, but there is certainly a very obvious similitude between the characters of the three heroes of the Doctor's chief productions. *Roderic Random*, *Peregrine Pickle*, and *Matthew Bramble*, are all brothers of the same family. The same satirical, cynical disposition, the same generosity and benevolence, are the distinguishing and characteristic features of all three; but they are far from being servile copies or imitations of each other. They differ as much as the *Ajax*, *Diomed*, and *Acilles* of Homer. This was undoubtedly a great effort of genius; and the Doctor seems to have described his own character at the different stages and situations of his life.

Before he took a house at Chelsea, he attempted to settle as practitioner of physic at Bath; and with that view wrote a treatise on the waters; but was unsuccessful, chiefly because he could not render himself agreeable to the women, whose favour is certainly of great consequence to all candidates for eminence, whether in medicine or divinity. This, however, was a little extraordinary; for those who remembered Dr Smollet at that time, cannot but acknowledge that he was as graceful and handsome a man as any of the age he lived in; besides,

besides, there was a certain dignity in his air and manner which could not but inspire respect wherever he appeared. Perhaps he was too soon discouraged; in all probability, had he persevered, a man of his great learning, profound sagacity, and intense application, besides being endued with every other external as well as internal accomplishment, must have at last succeeded, and had he attained to common old age, been at the head of his profession.

Abandoning physic altogether as a profession, he fixed his residence at Chelsea, and turned his thoughts entirely to writing. Yet, as an author, he was not near so successful as his happy genius and acknowledged merit certainly deserved. He never acquired a patron among the great, who by his favour or beneficence relieved him from the necessity of writing for a subsistence. The truth is, Dr Smollet possessed a loftiness and elevation of sentiment and character which appear to have disqualified him for paying court to those who were capable of conferring favours. It would be wrong to call this disposition pride or haughtiness; for to his equals and inferiors he was ever polite, friendly, and generous. Bookfellers may therefore be said to have been his only patrons; and from them he had constant employment in translating, compiling, and reviewing. He translated *Gil Blas* and *Don Quixote*, both so happily, that all the former translations of these excellent productions of genius have been almost superseded by his. His name likewise appears to a translation of *Voltaire's Prose Works*; but little of it was done by his own hand; he only revised it, and added a few notes. He was concerned in a great variety of compilations. His *History of England* was the principal work of that kind. It had a most extensive sale; and the Doctor is said to have received 2000*l.* for writing it and the continuation.

In 1755 he set on foot the *Critical Review*, and continued the principal manager of it till he went abroad for the first time in the year 1763. He was perhaps too acrimonious sometimes in the conduct of that work; and at the same time displayed too much feribility when any of the unfortunate authors attempted to retaliate whose works he had perhaps justly censured.

Among other controversies in which his engagements in this publication involved him, the most material in its consequences was that occasioned by his remarks on a pamphlet published by *Admiral Knowles*. That gentleman, in defence of his conduct on the expedition to Rochfort, published a vindication of himself; which falling under the Doctor's examination, produced some very severe strictures both on the performance and on the character of the writer. The admiral immediately commenced a prosecution against the printer; declaring at the same time that he desired only to be informed who the writer was, that if he proved to be a gentleman he might obtain the satisfaction of one from him. In this affair the Doctor behaved both with prudence and with spirit. Distant of compromising the dispute with the admiral in an amicable manner, he applied to his friend *Mr Wilkes* to interpose his good offices with his opponent. The admiral, however, was inflexible; and just as sentence was going to be pronounced against the printer, the Doctor came into court, avowed himself the author of the strictures, and declared himself ready to give *Mr Knowles* any satisfaction he chose.

The admiral immediately commenced a fresh action against the Doctor, who was found guilty, fined 100*l.*, and condemned to three months imprisonment in the King's Bench. It is there he is said to have written the *Adventures of Sir Launcelot Greaves*, in which he has described some remarkable characters, then his fellow-prisoners.

When Lord Bate was called to the chief administration of affairs, he was prevailed upon to write in defence of that nobleman's measures; which he did in a weekly paper called the *Briton*. This gave rise to the famous *North Briton*; wherein, according to the opinion of the public, he was rather bold. The truth is, the Doctor did not seem to possess the talents necessary for political altercation. He wanted temper and coolness; and his friends accused his patron of having denied him the necessary information, and even neglected the fulfilling of some of his other engagements with him. Be that as it will, the Doctor is said not to have forgotten him in his subsequent performances.

Besides the *Briton*, Dr Smollet is supposed to have written other pieces in support of the cause he espoused. The *Adventures of an Atom*, in two volumes, are known to be his production.

His constitution being at last greatly impaired by a sedentary life and assiduous application to study, he went abroad for his health in June 1763, and continued in France and Italy two years. He wrote an account of his travels in a series of letters to some friends, which were afterwards published in two volumes octavo, 1766. During all that time he appears to have laboured under a constant fit of chagrin. A very slight perusal of these letters will sufficiently evince that this observation is founded in fact, and is indeed a melancholy instance of the influence of bodily discontent over the best disposition.

His relation of his travels is actually cynical; for which *Sterne*, in his *Sentimental Journey*, has animadverted on him under the character of *Smellogus*. The Doctor lived to return to his native country; but his health continuing to decline, and meeting with fresh mortifications and disappointments, he went back to Italy, where he died in October 21, 1771. He was employed, during the last years of his life, in abridging the *Modern Universal History*, great part of which he had originally written himself, particularly the histories of France, Italy, and Germany.

He certainly met with many mortifications and disappointments; which, in a letter to *Mr Garrick*, he thus feelingly expresses: "I am old enough to have seen and observed, that we are all playthings of Fortune; and that it depends upon something as insignificant and precarious as the tossing up of a halfpenny, whether a man rises to affluence and honours, or continues to his dying day struggling with the difficulties and disgraces of life."

It would be needless to expatiate on the character of a man so well known as Dr Smollet, who has, besides, given so many strictures of his own character and manner of living in his writings, particularly in *Humphrey Clinker*; where he appears under the appellation of *Mr Scribe*, and has an interview with *Mr Bramble*; and his manner of living is described in another letter, where young Melford is supposed to dine with him at his house in Chelsea. No doubt he made money by his connec-

tions with the bookfellers; and had he been a rigid economist, or ended with the gift of retention (an expression of his own), he might have lived and died very independent. However, to do justice to his memory, his difficulties, whatever they were, proceeded not from extravagance or want of economy. He was hospitable, but not ostentatiously so; and his table was plentiful, but not extravagant. No doubt he had his failings; but still it would be difficult to name a man who was so respectable for the qualities of his head, or more amiable for the virtues of his heart.

Since his death a monument has been erected to his memory near Leghorn, on which is inscribed an epitaph written in Latin by his friend Dr Armstrong, author of *The Art of Preserving Health*, and many other excellent pieces. An inscription written in Latin was likewise inscribed on a pillar erected to his memory on the banks of the Leven, by one of his relations.

To these memoirs we are extremely sorry to add, that so late as 1758; the widow of Dr Smollet was residing in indigent circumstances at Leghorn. On this account the tragedy of *Venice Preserved* was acted for her benefit at Edinburgh on the 5th of March, and an excellent prologue spoken on that occasion.

The pieces inserted in the posthumous collection of Dr Smollet's plays and poems are, *The Regicide*, a tragedy; *The Reprital*, a comedy; *Advice and Reproof*, two satires; *The Tears of Scotland*; *Verles on a Young Lady*; a *Love Elegy*, in imitation of Tibullus; two *Songs*; a *Burlesque Ode*; *Odes to Minth*, to *Sleep*, to *Leven Water*, to *Blue-eyed Ann*, and to *Indecence*.

SMUGGLERS, persons who import or export prohibited goods without paying the duties appointed by the law.

The duties of customs, it is said, were originally instituted, in order to enable the king to afford protection to trade against pirates: they have since been continued as a branch of the public revenue. As duties imposed upon the importation of goods necessarily raise their price above what they might otherwise have been sold for, a temptation is presented to import the commodity clandestinely and to evade the duty. Many persons, prompted by the hopes of gain, and considering the violation of a positive law of this nature as in no respect criminal (an idea in which they have been encouraged by a great part of the community, who make no scruple to purchase smuggled goods), have engaged in this illicit trade. It was impossible that government could permit this practice, which is highly injurious to the fair trader, as the smuggler is enabled to undersell him, while at the same time he impairs the national revenue, and thus wholly destroys the end for which these duties were appointed. Such penalties are therefore inflicted as it was thought would prevent smuggling.

Many laws have been made with this view. If any goods be shipped or landed without warrant and presence of an officer, the vessel shall be forfeited, and the wharfinger shall forfeit 100*l*. and the master or mariner of any ship inward bound shall forfeit the value of the goods: and any carman, porter, or other assisting, shall be committed to goal, till he find surety of his good behaviour, or until he shall be discharged by the court of exchequer. (13 & 14 C. II. c. 11.) If goods

be reloaded after drawback, the vessel and goods shall be forfeited; and every person concerned therein shall forfeit double the value of the drawback (8 An. c. 13.) Goods taken in at sea shall be forfeited, and also the vessel into which they are taken; and every person concerned therein shall forfeit treble value (9 G. II. c. 35.) A vessel hovering near the coast shall be forfeited, if under 50 tons burden; and the goods shall also be forfeited, or the value thereof (5 G. III. c. 43.) Persons receiving or buying run goods shall forfeit 20*l*. (8 G. c. 18.) A concealer of run goods shall forfeit treble value (8 G. c. 18.) Offering run goods to sale, the same shall be forfeited, and the person to whom they are offered may seize them; and the person offering them to sale shall forfeit treble value (11 G. c. 32.) A porter or other person carrying run goods shall forfeit treble value (9 G. II. c. 35.) Persons armed or disguised carrying run goods shall be guilty of felony, and transported for seven years (8 G. c. 18. 9 G. II. c. 35.)

But the last statute, 19 G. II. c. 34. is for this purpose *inflar omnium*; for it makes all forcible acts of smuggling, carried on in defiance of the laws, or even in disguise to evade them, felony without benefit of clergy: enacting, that if three or more persons shall assemble, with fire-arms or other offensive weapons, to assist in the illegal exportation or importation of goods, or in rescuing the same after seizure, or in rescuing offenders in custody for such offences: or shall pass with such goods in disguise; or shall wound, shoot at, or assault, any officers of the revenue when in the execution of their duty; such persons shall be felons, without the benefit of clergy.

When we consider the nature, and still more the history of mankind, we must allow that the enacting of severe penal laws is not the way to prevent crimes. It were indeed much to be wished that there were no such thing as a political crime; for the generality of men, but especially the lower orders, not discerning the propriety or utility of such laws, consider them as oppressive and tyrannical, and never hesitate to violate them when they can do it with impunity. Instead therefore of punishing smugglers, it would be much better to remove the temptation. But the high duties which have been imposed upon the importation of many different sorts of foreign goods, in order to discourage their consumption in Great Britain, have in many cases served only to encourage smuggling; and in all cases have reduced the revenue of the customs below what more moderate duties would have afforded. The saying of Dr Swift, that in the arithmetic of the customs two and two, instead of making four, make sometimes only one, holds perfectly true with regard to such heavy duties, which never could have been imposed, had not the mercantile system taught us, in many cases, to employ taxation as an instrument, not of revenue, but of monopoly.

The bounties which are sometimes given upon the exportation of home produce and manufactures, and the drawbacks which are paid upon the re-exportation of the greater part of foreign goods, have given occasion to many frauds, and to a species of smuggling more destructive of the public revenue than any other. In order to obtain the bounty or drawback, the goods, it is well known, are sometimes shipped and sent to sea, but

Smugglers.

Smith's
History of
Nations,
vol. iii.

soon

Smugglers from afterwards clandestinely reloaded in some other part of the country.

Heavy duties being imposed upon almost all goods imported, our merchant importers smuggle as much, and make entry of as little as they can. Our merchant exporters, on the contrary, make entry of more than they export; sometimes out of vanity, and to pay for great dealers in goods which pay no duty; and sometimes to gain a bounty or a drawback. Our exports, in consequence of these different frauds, appear upon the custom-house books greatly to overbalance our imports; to the unparadoxical comfort of those politicians who measure the national prosperity by what they call the balance of trade.

SMUT, in *Hybandry*, a disease in corn, when the grains, instead of being filled with flour, are full of a flinking black powder. See WHEAT.

SMYRNA, or ISMIR, at present the largest and richest city of Asia Minor, is situated in north latitude 38° 25', and in E. Long. 27° 25' from Greenwich, and about 153 miles west by south of Constantinople. The town extends along the shore about half a mile on a gentle declivity. The houses of the English, French, and Dutch consuls are handsome structures; these, with most of those occupied by the Christian merchants, are washed on one side by the sea, forming a street named *Frank Street*, from its being solely inhabited by European Christians. In the year 1763 the whole of this quarter was consumed by fire: the loss sustained by this calamity in merchantile was estimated at a million and a half of Turkish dollars, or near 200,000 sterling. The port is one of the finest of the Levant, and there are able to contain the largest fleets; and indeed there are seldom in it fewer than 100 ships of different nations.

A castle stands at its entrance, and commands all the shipping which sail in or out. There is likewise an old ruinous castle, near a mile in circumference, which stands in the upper part of the city, and, according to tradition, was built by the empress Helena; and near it is an ancient structure, said to be the remains of a palace where the Greek council was held when Smyrna was the metropolis of Asia Minor. They also show the ruins of an amphitheatre, where it is said St. Polycarp, the first bishop, fought with lions.

This city is about four miles in circumference, and nearly of a triangular form; but the side next the mountain is much longer than the other sides. The houses are low, and mostly built with clay walls, on account of the earthquakes to which the country is subject; but the caravanserais and some other of the public buildings have an air of magnificence. The streets are wide, and almost a continued bazaar, in which a great part of the merchantile of Europe and Asia is exposed to sale, with plenty of provisions; though these are not so cheap as in many other parts of Turkey, on account of the populousness of the place, and the great resort of foreigners. It is said to contain 15,000 Turks, 10,000 Greeks, 1600 Jews, 200 Armenians, and 200 Franks; but the whole population is computed at 125,000. The Turks have 19 mosques; two churches belong to the Greeks; one to the Armenians; and the Jews have eight synagogues. The Romani have three convents. There is also one of the fathers of the Terra Santa. Here resides an archbishop of the Greek

church; a Latin bishop who has a salary from Rome, with the title of bishop of Smyrna, *in partibus infidelium*; and the English and Dutch factories have each their chaplain.

The walks about the town are extremely pleasant, particularly on the west side of Frank Street, where there are several little groves of orange and lemon trees, which being always clothed with leaves, blossoms, and fruit, regale several of the ladies at the same time. The vines which cover the little hills about Smyrna afford both a delightful prospect and plenty of grapes, of which good wine is made. These hills are agreeably interspersed with fertile plains, little towns of olives and other fruit-trees, and many pleasure-houses, to which the Franks usually retire during the summer. In the neighbourhood of Smyrna is great plenty of game and wild-fowl, and particularly deer and wild-hogs. The sea also abounds with a variety of good fish. The European Christians are here allowed all imaginable liberties, and usually clothe themselves after the European manner.

The chief commerce of this city consists in raw silk, silk-stuffs, programs, and cotton yarn.

However, the unhealthfulness of the situation, and more especially the frequent earthquakes, from which it is said, they are scarcely ever free for two years together, and which have been felt 40 days successively, are an abatement of the pleasure that might otherwise be enjoyed here. A very dreadful one happened in June 1688, which overthrew a great number of the houses; and the rock opening where the cable stood, swallowed it up, and no less than 5000 persons perished on this occasion.

In the year 1758, a desolating a plague raged here, that scarcely a sufficient number of the inhabitants survived to gather in the fruits of the earth. In the year 1772, three-fourth parts of the city were consumed by fire; and six years after it was visited by the most dreadful earthquakes, which continued from the 25th of June to the 5th of July; by which successive calamities the city has been so much reduced, that its former consequence is never likely to be restored.

The ladies here wear the oriental dress, consisting of large trousers or breeches, which reach to the ankle; long veils of rich silk or velvet, lined in winter with costly furs; and round their waist an embroidered zone with clays of silver or gold. Their hair is plaited, and descends down the back often in great profusion. The girls have sometimes above twenty thick tresses, besides two or three encircling the head as a coronet, and set off with shawers and plumes of feathers, pearls, or other jewels. They commonly stain it of a chieft colour, which is the most desired. Their apparel and carriage are alike antique. It is remarkable that the trustees are mentioned in a fragment of Sappho in part of the Knave's dress.

SMYRNIMUM, ALEXANDERS; a genus of plants belonging to the class of pentandria, and to the order of digynia; and in the natural system ranging under the 45th order, *Umbellatae*. See BOTANY INDIA.

SNAPPLE, in the woollen, is a very broad cloth made without any bias line, much used in England, the trade of which being reserved for war.

SNAIL, in Zoology. See HELIX, CONCHOLOGIA, &c. and LIMAX, HELIX, MURICOLELLA, &c.

SNARE, in Zoology. See ANGRIS and SERPENS, Ornithology Index.

Snake-stones, *Ammonia*, in Natural History, the name of a large genus of fossil shells, very few if any of which are yet known in their recent state, or living either on our own or any other shores; so that it seems wonderful whence to find a number and variety of them should be brought into our subterranean regions. They seem indeed dispersed in great plenty throughout the world, but nowhere are found in greater numbers, beauty, and variety, than in our island.

Mr Harenberg found prodigious numbers of them on the banks of a river in Germany. He traced this river through its several windings for many miles, and among a great variety of blemishes, cornua ammonis, and cochlites, of various kinds; he found also great quantities of wood of recent petrification, which still preserved plain marks of the axe by which it had been cut from the trees on growing in the forest. The water of this river he found in dry seasons, when its natural springs were not diluted with rains, to be considerably heavier than common water; and many experiments showed him that it contained ferruginous, as well as stony particles, in great quantity, whence the petrifications in it appeared the less wonderful, though many of them of recent date.

Of the cornua ammonis, or serpent-stones, he there observed more than 35 different species. They lie immersed in a bluish fossil stone, of a soft texture and sily appearance, in prodigious numbers, and of a great variety of sizes, from the larger known sorts down to such as could not be seen without very accurate inspection or the assistance of a microscope. Such as lie in the softest of these stones are soft like their matrix, and easily crumble to pieces; others are harder. In a piece of this stone, of the bigness of a finger, it is common to find 35 or more of these fossils; and often they are seen only in form of white specks, so minute that their figure cannot be distinguished till examined by the microscope.

They all consist of several volute, which are different in number in the different species, and their size also are extremely various; some very deep with very high ridges between them, others very slight; some straight, others crooked; others undulated, and some terminating in dots, tubercles, or cavities, towards the back, and others having tubercles in two or three places. They are all composed of a great number of chambers or cells, in the manner of the *nautilus Græcicum*, each having a communication with the others, by means of a pipe or siphunculus. There is a small white shell fish of Barbadoc, which seems truly a recent animal of this genus; and in the East Indies there is another also, small and grayish; but the large and beautifully marked ones are found only fossil.

They are composed of various fossil bodies, often of quarry stone, sometimes of the matter of the common pyrites, and of a great variety of other substances; and though they appear usually mere stones, yet in some the stony part of the original shell is preserved in all its beauty. Sometimes also, while the outer substance is of the matter of the pyrites, or other coarse, stony, or mineral matter, the inner cavity is filled with a pure white spar of the common plated texture. This gives a great beauty to the specimen. The cornua ammonis,

or snake-stones, are found in many parts of England, particularly in Yorkshire, where they are very plentiful in the same rocks of several sizes.

Snake-stone. See POLYGALA, Botany Index.

Snake-stone. See POLYGONUM, Botany Index.

SNAPEDRAGON. See ANTIRRHINUM, Botany Index.

SNEEZING, a convulsive motion of the muscles of the breast, whereby the air is expelled from the nose with much violence and noise. It is caused by the irritation of the upper membrane of the nose, occasioned by acrid substances floating in the air, or by medicines called *sneezing-herbs*.

This irritation is performed either externally, by strong smells, as marjoram, roses, &c. or by dust floating in the air, and taken in by inspiration; or by sharp pungent medicines, as cretels and other stimulators, which vilitate the membrane of the nose; or internally, by the acrimony of the lymph or mucus, which naturally moistens that membrane. The matters cast forth in sneezing come primarily from the nose and throat; the pituitary membrane continually exuding a mucus thicker; and, secondarily, from the breast, the trachea, and the bronchia of the lungs.

The practice of saluting the person who sneezed existed in Africa, among nations unknown to the Greeks and Romans. The accounts we have of Menometry inform us, that when the prince sneezes, all his subjects in the capital are advertised of it, that they may offer up prayers for his safety. The author of the conquest of Peru assures us, that the cacique of Guancha having sneezed in presence of the Spaniards, the Indians of his train fell prostrate before him, stretched forth their hands, and displayed to him the accustomed marks of respect, while they invoked the sun to enlighten him, to defend him, and to be his constant guard.

Every body knows that the Romans saluted each other on these occasions; and Pliny relates, that Tibullus exacted these signs of homage when drawn in his chariot. Superstition, whose influence can debase every thing, had degraded this custom for several ages, by attaching favourable or unfavourable omens to sneezing according to the hour of the day or night, according to the signs of the zodiac, according as a work was more or less advanced, or according as one had sneezed to the right or to the left. If a man sneezed at rising from his table or from his bed, it was necessary for him to sit or lie down again. You are struck with astonishment, said Timotheus to the Athenians, who wished to return into the harbour with their fleet, because he had sneezed; you are struck with astonishment, because among 10,000 there is one man whose brain is moist.

Polydore Virgil pretends, that in the time of Gregory the Great, there reigned in Italy an epidemic distemper, which carried off by sneezing all those who were seized by it; and that this pestilence ordered prayers to be made against it, accompanied by certain signs of the cross. But besides that, there are very few cases in which sneezing can be considered as dangerous, and that it is frequently a favourable symptom; it is evident, that we ought not to date from the sixth century the origin of a custom which loses itself in the obscurity of antiquity. Avicenna and Cardan say, it is a sort of convulsion, which gives occasion to dread an epilepsy, and that

Snake
||
Sneezing.

Strabo,
Frel. Acad.

Tibull. *Hyll.*
Nat. lib. 14.
cap. 2.

Strabo,
Hæmæ.
Conject.

Gregorius,
lib. 1. cap.
11.

Huff-
crat. *Hal.*
lib. 1. *Hyll.*

Speeding—In this disease is endeavoured to be worked off by prayers. Clement of Alexandria considers it as a mark of impotence and effeminacy, which ought to be prohibited. And he inveighs bitterly against those who endeavour to procure freezing by exorcism. Montaigne, on the contrary, explains this fact in a more rational manner. It is singular enough, that so many ridiculous, contradictory, and superstitious opinions, have not abolished those customary civilities which are still preferred equally among Turks and Jews; and which only the Anabaptists and Quakers have rejected, because they have renounced salutations in every case.

Among the Greeks freezing was almost always a good omen. It excited marks of respect, of respect, and attachment. The genius of Socrates informed him by freezing, when it was necessary to reform any action. The young Parthena, hurried on by her passion, resolved to write to Sarpedon an avowal of her love; and the freezes in the most tender and impassioned part of her letter: This is sufficient for her; this incident supplies the place of an answer, and persuades her that Sarpedon is her lover. Penelope, harassed by the vexatious criticism of her suitors, begins to curse them all, and to pour forth vows for the return of Ulysses. Her Penelope, machus interrupts her by a loud freeze. She instantly exalts with joy, and regards this sign as an assurance of the approaching return of her husband. Xerxes was haranguing his troops; a flasher freezes in the moment when he was exhorting them to embrace a dangerous but necessary resolution. The whole army, moved by this prodigy, determine to pursue the project of their general; and Xerxes orders sacrifices to Jupiter the preserver.

This religious reverence for freezing, so ancient and so universal even in the times of Homer, always excited the curiosity of the Greek philosophers and of the rabbins. These last have formed a tradition, that, after the creation of the world, God made a general law to this purpose, that every living man should freeze but once in his life, and that at the first instant he should render up his soul into the hand of his Creator, without any preceding infirmity. Jacob obtained an exemption from the common law, and the favour of being informed of his last hour: He froze and did not die; and this sign of death was changed into a sign of life. Notice of this was sent to all the princes of the earth; and they ordained, that in future freezing should be accompanied with forms of blessing, and vows for the persons who freeze.

Aristotle remarks likewise that the source of natural religion. He observes, that the brain is the origin of the nerves, of our sentiments, our sensations, the seat of the soul, the image of the Divinity; that upon all these accounts, the first use of the brain has ever been held in honour; that the first men were by their head; that they durst not touch nor eat the brains of any animal; that it was even a sacred word which they durst not pronounce. Filled with these ideas, it is not wonderful that they extended their reverence even to freezing. Such is the opinion of the most ancient and famous philosophers of Greece.

According to mythology, the first son of life Prometheus's artificial man gave was by fermentation. His first creator is said to have stolen a portion of the solar rays; and filling with them a phial, which he had

made on purple, sealed it up hermetically. He instantly flies by to his favourite automation, and opening the phial holds it close to the statue; the rays still retaining all their activity, infuse themselves through the pores, and let the fictitious man a freezing. Prometheus, is sported with the success of his machine, offers up a fervent prayer, which wishes for the preservation of his first-born a being. His automation observed him, remarking his calculations, was very careful, on the like occasion, to offer the wishes in behalf of his descendants, who perpetuated it from father to son in all their colonies.

SNIGGLING, a method of fishing for eels, chiefly used in the day-time, when they are found to like themselves near weirs, mills, or head-gates. It is performed thus: Take a strong line and hook, baited with a golden-worm, and observing the holes where the eels lie hid, thrust your bait into them by the help of a stick; and if there be any, you shall be sure to have a bite; and may, if you tacking hold, get the largest eels.

SNIFE, in *Omnithology*. See SCORPAX and SUCORISUS.

SNORING, in *Medicine*, where it is called *Stertor*, is a sound like that of the ceruleon, but greater and more manifest.

Many confound these affections, and make them to differ only in place and magnitude, calling by the name of *Stertor* that sound or noise which is heard or supposed to be made in the passage between the palate and the nostrils in those who sleep; that boiling or bubbling noise, which in respiration proceeds from the larynx or head, or orifice of the upper artery, they call *ceche*, but if the sound comes from the alpera arteria itself, it is called *ceche*; that is, as some understand it, a rattling, or as others a stridulous or whizzing roughness of the alpera arteria. In dying persons this affection is called by the Greeks *gryxer*, *stertor*, which is a moaning, or rattling kind of noise, proceeding as it were from a conflict between the breath and the humours in the alpera arteria.

This and such like affections are owing to a weakness of nature, as when the lungs are full of pus or humours; to which purpose we read in the Prognostics of Hippocrates, "It is a bad sign when there is no expectoration, and no discharge from the lungs; but a noise as from an agitation is heard in the alpera arteria from a pain of humor." Expectoration is supposed either by the viscosity of the humour, which requires to be discharged, and which adhering to the alpera arteria, and being there agitated by the breath, excites that bubbling noise or stertor; or by an obstruction of the bronchia; or, lastly, by a compression of the alpera arteria and throat, whence the passage is obstructed, in which the humours being agitated, excite such a kind of noise before described. Hence Galen calls those who are faint-hearted *stertorosi*. That author affirms but to be causes of this symptom, which are either the viscosity of the passage of respiration or redundancy of humours, or both together; but it is necessary to add a third, to wit, the weakness of the faculty, which is the cause of the stridulous in dying persons, where nature is too weak to make discharges.

From what has been said we conclude, that this symptom, or this sort of fever or ebullition in the

See
Stertor

• *Platarch*
de ceche
Stertor
• *Argylem*
etc.

• *Homer*
Od.
• *Virg.*
Aen.

• *Xerxes*
Arab.

• *Arab.*
Inf.
vol.

• *Argylem*
etc.

Breath. throat, is not always mortal, but only when nature is oppressed with the redundancy of humour, in such a manner, that the lungs cannot discharge themselves by spitting; or the pulse appointed for the breath (being the *arteria arteria*) is very much obstructed, upon which account many dying persons labour under a fluxion with their mouths gaping.

SNOW. a well known meteor, formed by the freezing of the vapour of water in the atmosphere. It differs from hail and hoar-frost, in being as it were crystallized, which they are not. This appears on examining a flake of snow by a magnifying glass; when the whole of it will appear to be composed of fine shining spicula diverging like rays from a centre. As the flakes fall down through the atmosphere, they are continually joined by more of these radiated spicula, and thus increase in bulk like the drops of rain or hailstones. Dr Greve, in a discourse of the nature of snow, observes, that many parts thereof are of a regular figure, for the most part stars of six points, and are as perfect and transparent ice as any we see on a pond, &c. Upon each of these points are other collateral points, set at the same angles as the main points themselves: among which there are divers other irregular, which are chiefly broken points, and fragments of the regular ones. Others also, by various winds, seem to have been thawed and frozen again into irregular clusters; so that it seems as if the whole body of snow were an infinite mass of icicles irregularly figured. That is, a cloud of vapours being gathered into drops, the said drops forthwith descend; upon which descent, meeting with a freezing air as they pass through a colder region, each drop is immediately frozen into an icicle, shooting itself forth into several points; but these still continuing their descent, and meeting with some intermitting gales of warmer air, or in their continual passage to and fro touching upon each other, some of them are a little thawed, blunted, and again frozen into clusters, or entangled so as to fall down in what we call *flakes*.

The lightness of snow, although it is firm ice, is owing to the excess of its surface, in comparison to the matter contained under it: as gold itself may be extended in surface till it ride upon the least breath of air.

The whiteness of snow is owing to the small particles into which it is divided; for ice, when pounded, will become equally white. An artificial snow has been made by the following experiment. A tall phial of aquafortis being placed by the fire till it is warm, and filings of pure silver, a few at a time, being put into it; after a little ebullition, the silver will dissolve slowly. The phial being then placed in a cold window, as it cools the silver particles will shoot into crystals, several of which running together will form a flake of snow, which will descend to the bottom of the phial. While they are descending, they represent perfectly a shower of silver snow, and the flakes will lie upon one another at the bottom, like real snow upon the ground.

According to Signor Beccaria, clouds of snow differ in nothing from clouds of rain, but in the circumstance of cold that freezes them. Both the regular diffusion of the snow, and the regularity of the structure of its parts, particularly the figures of snow or hail which fall about Turin, and which he calls *rosettes*, show that clouds of snow are acted upon by some uniform cause

like electricity; and he endeavours to show how electricity is capable of forming these figures. He was confirmed in his conjectures by observing, that his apparatus for observing the electricity of the atmosphere never failed to be electrified by snow as well as rain. Professor Winthrop sometimes found his apparatus electrified by snow when driven about by the wind, though it had not been acted by it when the snow itself was falling. A more intense electricity, according to Beccaria, unites the particles of hail more closely than the more moderate electricity does those of snow, in the same manner as we see that the drops of rain which fall from thunder-clouds are larger than those which fall from others, though the former descend through a less space.

But we are not to consider snow merely as a curious and beautiful phenomenon. The Great Dispenser of universal beauty has so ordered it, that it is eminently subservient, as well as all the works of creation, to his benevolent designs. Were we to judge from appearances only, we might imagine, that so far from being useful to the earth, the cold humidity of snow would be detrimental to vegetation. But the experience of all ages asserts the contrary. Snow, particularly in those northern regions where the ground is covered with it for several months, fructifies the earth, by guarding the corn or other vegetables from the interior cold of the air, and especially from the cold piercing winds. It has been a vulgar opinion, very generally received, that snow fertilizes the lands on which it falls more than rain, in consequence of the nitrous salts which it is supposed to acquire by freezing. But it appears from the experiments of Marsani, in the year 1751, that the chemical difference between rain and snow water is exceedingly small; that the latter contains a less proportion of earth than the former; but neither of them contain either earth or any kind of salt in any quantity which can be sensibly efficacious in promoting vegetation. Allowing, therefore, that nitre is a fertilizer of lands, which many are upon good grounds disposed utterly to deny, yet a very small is the quantity of it contained in snow, that it cannot be supposed to promote the vegetation of plants upon which the snow has fallen. The peculiar agency of snow, as a fertilizer in preference to rain, may admit of a very rational explanation, without recurring to nitrous salts supposed to be contained in it. It may be rationally ascribed to its furnishing a covering to the roots of vegetables, by which they are guarded from the influence of the atmospheric cold, and the internal heat of the earth is prevented from escaping.

The internal part of the earth, by some principle which we do not understand, is heated uniformly to the 48th degree of Fahrenheit's thermometer. This degree of heat is greater than that in which the watery juices of vegetables freeze, and it is propagated from the inward parts of the earth to the surface, on which the vegetables grow. The atmosphere being variably heated by the action of the sun in different climates, and in the same climate at different seasons, communicates to the surface of the earth and to some distance below it the degree of heat or cold which prevails in itself. Different vegetables are able to preserve life under different degrees of cold, but all of them perish when the cold which reaches their roots is extreme. Providence has therefore, in the coldest climates, provided a covering

of snow for the roots of vegetables, by which they are protected from the influence of the atmospheric cold. The snow keeps in the internal heat of the earth, which furrows the roots of vegetables, and defends them from the cold of the atmosphere.

Snow or ice water is always deprived of its fixed air, which escapes during the process of congelation. Accordingly, as some of the inhabitants of the Alps who use it for their constant drink have enormous wens upon their throats, it has been ascribed to this circumstance. If this were the cause of these wens, it would be easy to remove it by exposing the snow-water to the air for some time. But several eminent physicians have rejected the notion that snow-water is the cause of these wens; for in Greenland, where snow-water is commonly used, the inhabitants are not affected with such swellings; on the other hand, they are common in Samatra where snow is never seen.

Snow, in sea affairs, is generally the largest of all two-masted vessels employed by Europeans, and the most convenient for navigation.

The sails and rigging of the mainmast and foremast of a snow are exactly similar to those on the same masts in a ship; only that there is a small mast behind the mainmast of the former, which carries a sail usually resembling the mizen of a ship. The root of the mast is fixed on a block of wood on the quarter-deck about the mainmast; and the head of it is attached to the after-part of the maintop. The sail which is called the *trysail* is extended from its mast towards the stern of the vessel.

When the floes of war are rigged as snows, they are furnished with a horse, which answers the purpose of the trysail-mast, the fore-part of the sail being attached by rings to the said horse, in different parts of its height.

Snow-Caves, an excavation made by the waters on the side of Mount Etna, by making their way under the layers of lava, and by carrying away the bed of *pozzolana* below them. It occurred to the proprietor, that this place was very suitable for a magazine of snow; for in Sicily, at Naples, and particularly at Malta, they are obliged for want of ice to make a use of snow for cooling their wine, sherbet, and other liquors, and for making sweetmeats.

This grotto was hired or bought by the knights of Malta, who having not heretofore any snow on the burning rock which they inhabit, have hired several caverns on Etna, into which people whom they employ collect and preserve quantities of snow to be sent to Malta when needed. The grotto has therefore been repaired within at the expense of that order: eight of its parts are cut into it, as well as two openings for a above, by which they throw in the snow, and through which the grotto is enlightened. Above the grotto they have also levelled a piece of ground of considerable extent; this they have inclosed with thick and lofty walls, so that when the winds, which at this elevation blow with great violence, carry the snow from the higher parts of the mountains and deposit it in the inclosure, it is retained and amassed by the walls. The proprietors remove it to the grotto through the two openings; and it is there in the winter deposited in such a manner, as to reach the *base* of the former inclosure, as the layers of ice

with which the grotto is arched above protect them from making any impression.

When the season for exporting the snow comes on, it is put into large bags, into which it is pressed as closely as possible; it is then carried by men out of the grotto, and laid upon mules, which convey it to the floes, where small vessels are waiting to carry it away.

But before these lumps of snow are put into bags, they are wrapped in fresh leaves; so that while they are conveyed from the grotto to the floes, the leaves may prevent the rays of the sun from making any impression upon them.

The Sicilians carry on a considerable trade in snow, which affords employment to some thousands of mules, horses, and men. They have magazines of it on the summits of their loftiest mountains, from which they distribute it through all their cities, towns, and houses; for every person in the island makes use of snow. They consider the practice of cooling their liquors as absolutely necessary for the preservation of health; and in a climate the heat of which is constantly relaxing the fibres, cooling liquors, by communicating a proper tone to the fibres of the stomach, must give us life, when their performance of their functions.

In this climate a scarcity of fire is no less dreaded than a scarcity of corn, wine, or oil. We are informed by a gentleman who was at Syracuse in the year 1777, when there was a scarcity of wood, the people of the island learned that a small vessel loaded with that article was passing the coast without a moment's deliberation they ran a boat to the shore, and demanded her cargo: which when the crew refused to deliver up, the Syracusans attacked and took, though with the loss of several men.

Snow-Drain. See CHENANTHUS, Botany Index.

SNOWDON MOUNT, the name of a mountain in Carnarvonshire in Wales, generally thought to be the highest in Britain; though some have been of opinion that its height is equalled, or even exceeded, by mountains in the Highlands of Scotland. The mountain is furrowed by many others, called in the Welsh language *Crib Coch*, *Crib yn Ddu*, *Llwyd*, &c.

According to Mr Pennant's Travels, this mountain's soil yields for nearly any corn. Its produce is cattle and sheep; which, during summer, keep very high in the mountains, followed by their owners with their families, who reside during that season in *huts*, or "summer dairy-houses," as the farmers in the Swiss Alps do in their *chalets*. These houses consist of a long low room, with a hole at one end to let out the smoke from the fire which is made beneath. Their furniture is very simple; ponies are substituted for stools, and their beds are of hay, ranged along the sides. They manufacture their own clothes, and dye them with the *lichen omphalodes* and *lichen parietinus*, mosses collected from the rocks. During summer the men pass their time in tending their herds or in making hay, &c. and the women in milking or in making butter and cheese. For their own use they milk both ewes and goats, and make cheese of the milk. Their diet consists of milk, cheese, and butter; and their ordinary drink is water; though they have, by way of reserve, a few bottles of very strong beer, which they use as a cordial when sick. They are people of good industry, and very, and extremely, industrious.

thin, and of strong constitutions. In the winter-time they descend into the *low dreef*, or "oil dwelling," where they pass their time in idleness.

The view from the highest peak of Snowdon is very extensive. From it Mr Pennant saw the county of Chester, the high hills of Yorkshire, part of the north of England, Scotland, and Ireland; a plain view of the Isle of Man; and that of Anglesea appeared like a map extended under his feet, with every rivulet visible. Our author took much pains to have this view to advantage; fat up at a farm on the west till about 12, and walked up the whole way. The night was remarkably fine and starry; towards morning the stars faded away, leaving an interval of darkness, which, however, was soon dispelled by the dawn of day. The body of the sun appeared most distinct, with the roundness of the moon, before it appeared too brilliant to be looked at. The sea, which bounded the western part of the prospect, appeared gilt with the sun-beams, first in slender streaks, and at length glowed with redness. The prospect was disclosed like the gradual drawing up of a curtain in a theatre; till at last the heat became sufficiently strong to raise mists from the various lakes, which in a slight degree obscured the prospect. The shadow of the mountain extended many miles, and showed its bicapitated form; the Wyddfa making one head, and Crib y Ddill the other. At this time he counted between 20 and 30 lakes either in Caernarvon or in Merionethshire. In making another visit, the sky was obscured very soon after he got up. A vast mist involved the whole circuit of the mountain, and the prospect down was horrible. It gave an idea of numbers of abysses, concealed by a thick smoke furiously circulating around them. Very often a gulf of wind made an opening in the clouds, which gave a fine and distinct view of lake and valley. Sometimes they opened in one place, at others in many at once; exhibiting a most strange and perplexing sight of water, fields, rocks, and chasms. They then closed again, and every thing was involved in darkness; in a few minutes they would separate again, and repeat the above-mentioned scene with infinite variety. From this prospect our traveller descended with great reluctance; but before he had reached the place where his horses were left, he was overtaken by a thunder storm. The rolling of the thunder-claps, being reiterated by the mountains, was inexpressibly awful; and after he had mounted, he was in great danger of being swept away by the torrents which poured down in consequence of a very heavy rain.

It is very rare (Mr Pennant observes) that the traveller gets a proper day to ascend this hill: it indeed often appears clear; but by the evident attraction of the clouds by this lofty mountain, it becomes suddenly and unexpectedly enveloped in mist, when the clouds have just before appeared very high and very remote. At times he observed them lower to half their height; and notwithstanding they have been dispersed to the right and left, yet they have met from both sides, and united to involve the summit in one great obscurity.

The height of Snowdon was measured, in 1682, by Mr Caswell, with instruments made by Flamsteed: according to his mensuration, the height is 3725 feet; but more modern computations make it only 3668, reckoning from the quay at Caernarvon to the highest peak. The stone that composes this mountain is excellently

hard. Large coarse crystals, and frequently cubic pyrites, are found in the fissures. An immense quantity of water rushes down the sides of Snowdon and the neighbouring mountains, inasmuch that Mr Pennant supposes, if collected into one stream, they would exceed the waters of the Thames.

SNUFF, a powder chiefly made of tobacco, the use of which is too well known to need any description here.

Tobacco is usually the basis of snuff; other matter being only added to give it a more agreeable scent, &c. The kinds of snuff, and their several names, are infinite, and new ones are daily invented; so that it would be difficult, not to say impossible, to give a detail of them. We shall only say, that there are three principal sorts: the first granulated; the second an impalpable powder; and the third the bran, or coarse part remaining after sifting the second sort.

"Every professed, inveterate, and incurable snuff-taker (says Lord Stanhope), at a moderate computation, takes one pinch in ten minutes. Every pinch, with the agreeable ceremony of blowing and wiping the nose and other incidental circumstances, consumes a minute and a half. One minute and a half out of every ten, allowing 16 hours to a snuff-taking day, amounts to two hours and 24 minutes out of every natural day, or one day out of every ten. One day out of every 10 amounts to 36 days and a half in a year. Hence if we suppose the practice to be persisted in 40 years, two entire years of the snuff-taker's life will be dedicated to tickling his nose, and two more to blowing it. The expense of snuff, snuff boxes, and handkerchiefs, will be the subject of a second essay; in which it will appear, that this luxury encroaches as much on the income of the snuff taker as it does on his time; and that by a proper application of the time and money thus lost to the public, a fund might be constituted for the discharge of the national debt." See NICOTIANA.

SNYDERS, FRANCIS, a Flemish painter, born at Antwerp in 1570, and bred under his countryman Henry Van Balen. His genius first displayed itself in painting fruit: he afterwards attempted animals, huntings, &c. in which he exceeded all his predecessors. He also painted kitchens, &c. and gave dignity to subjects that seemed incapable of it. He was made painter to Ferdinand and Isabella, archduke and duchess, and became attached to the house of the cardinal infant of Spain. The king of Spain and the elector Palatine adorned their palaces with huntings by this artist. Rubens, Jordaens, and Snyders, used to co-operate in the enriching of each other's pictures according to their several talents; and thus they became more valuable than if finished by either of them singly. Snyders died in 1657.

SOAL-FISH. See PLEURONECTES, ICHTHYOLOGY *Index*.

SOAP, a composition of caustic, fixed alkaline salt, and oil, sometimes hard and dry, sometimes soft and liquid; much used in washing, whitening linens, and by dyers and fullers.—Soap may be made by several methods, which, however, all depend upon the same principle. The soap which is used in medicine is made without heat.

In manufactures where large quantities of it are prepared, soap is made with heat. A lixivium of quicklime and

and soda is made, but is less concentrated than that above referred to, and only so much that it can sustain a fresh egg. A part of this lixivium is to be even diluted and mixed with an equal weight of oil of olives. The mixture is to be put on a gentle fire, and agitated, that the union may be accelerated. When the mixture begins to unite well, the rest of the lixivium is to be added to it; and the whole is to be digested with a very gentle heat, till the soap be completely made. A trial is to be made of it, to examine whether the just proportion of oil and alkali has been observed. Good soap of this kind ought to be firm, and very white when cold; not subject to become mouldy by exposure to air, and entirely miscible with pure water, to which it communicates a milky appearance, but without any drops of oil floating on the surface. When the soap has not these qualities, the combination has not been well made, or the quantity of salt or oil is too great, which faults must be corrected.

In soft or liquid soaps, green or black soaps, cheaper oils are employed, as oil of nuts, of hemp, of fish, &c. These soaps, excepting in consistence, are not essentially different from white soap.

Fixed alkalies are much disposed to unite with oils that are not volatile, both vegetable and animal, since this union can be made even without heat. The compound resulting from this union partakes at the same time of the properties of oil and of alkali; but these properties are modified and tempered by each other, according to the general rule of combinations. Alkali formed into soap has not nearly the same acrimony as when it is pure; it is even deprived of almost all its causticity, and its other saline alkaline properties are almost entirely abolished. The same oil contained in soap is less combustible than when pure, from its union with the alkali, which is an unflammable body. It is miscible, or even soluble, in water, to a certain degree, by means of the alkali. Soap is entirely soluble in spirit of wine; and still better in a spirit sharpened by a little alkaline salt, according to an observation of Mr Geoffroy.

The manufacture of soap in London first began in the year 1524; before which time this city was served with white soap from foreign countries, and with gray soap speckled with white from Britol, which was sold for a penny a pound; and also with black soap, which sold for a halpenny the pound.

The principal soaps of our own manufacture are the soft, the hard, and the ball soap. The soft soap is either white or green. The process of making each of these shall now be described.

Green soft soap. The chief ingredients used in making this are lees drawn from pot-ash and lime, boiled up with tallow and oil. First, the ley of a proper degree of strength (which must be estimated by the weight of the liquor), and tallow, are put into the copper together, and as soon as they boil up the oil is added; the fire is then damped or stopped up, while the ingredients remain in the copper to unite; when they are united, the copper is again made to boil, being fed or filled with lees as it boils, till there be a sufficient quantity put into it; then it is boiled off and put into casks. When this soap is first made it appears uniform; but in about a week's time the tallow separates from the oil into those white grains which we see in common

soap. Soap thus made would appear yellow, but by a mixture of indigo added at the end of the boiling, it is rendered green, that being the colour which results from the mixture of yellow and blue.

White soap. Of this one sort is made after the same manner as green soft soap, oil alone excepted, which is not used in white. The other sort of white soft soap is made from the lees of albes of lime boiled up two different times with tallow. First, a quantity of lees and tallow are put into the copper together, and kept boiling, being fed with lees as they boil, until the whole is boiled sufficiently; then the lees are separated or discharged from the tallow part, which part is removed into a tub, and the lees are thrown away; this is called the *first half-boil*; then the copper is filled again with fresh tallow and lees, and the first half-boil is put out of the tub into the copper a second time, where it is kept boiling with fresh lees and tallow till the soap is produced. It is then put out of the copper into the same sort of casks as are used for green soft soap. The common soft soap used about London, generally of a greenish hue, with some white lumps, is prepared chiefly with tallow; a blackish sort, more common in some other places, is said to be made with whale oil.

Hard soap is made with lees from albes and tallow, and is most commonly boiled twice: the first, called the *half-boil*, hath the same operation as the first half-boil of soft white soap. Then the copper is charged with fresh lees again, and the first half-boil put into it, where it is kept boiling, and fed with lees as it boils, till it grains or is boiled enough; then the ley is discharged from it, and the soap put into a frame to cool and harden. Common salt is made use of for the purpose of graining the soap; for when the oil or tallow has been united with the ley, after a little boiling, a quantity of salt is thrown into the mass, which dissolving readily in water, but not in the oil or tallow, draws out the water in a considerable degree, so that the oil or tallow united with the salt of the ley swims on the top. When the ley is of a proper strength, less salt is necessary to raise the curd than when it is too weak. It must be observed, that there is no certain time for bringing off a boiling of any of these sorts of soap: it frequently takes up part of two days.

Ball soap, commonly used in the north, is made with lees from albes and tallow. The lees are put into the copper, and boiled till the watery part is quite gone, and there remains nothing in the copper but a sort of saline matter (the very strength or essence of the ley); to this the tallow is put, and the copper is kept boiling and stirring for above half an hour, in which time the soap is made; and then it is put out of the copper into tubs or baskets with sheets in them, and immediately (while soft) made into balls. It requires near 24 hours in this process to boil away the watery part of the ley.

When oil unites with alkali in the formation of soap, it is little altered in the connection of its principles; for it may be separated from the alkali by decomposing soap with any acid, and may be obtained nearly in its original state.

Concerning the decomposition of soap by means of acids, we must observe, first, that all acids, even the weakest vegetable acids, may occasion this decomposition, because every one of them has a greater affinity

tion oil with fixed alkali. Secondly, these acids, even when united with any basis, excepting fixed alkali, are capable of occasioning the same decomposition; whence all ammoniacal salts, all salts with bases of earth, and all those with metallic bases, are capable of decomposing soap, in the same manner as disengaged acids are; with this difference, that the oil separated from the fixed alkali, by the acid of these salts, may unite more or less intimately with the substance which was the basis of the neutral salt employed for the decomposition.

Soap may also be decomposed by distillation, as Lermery has done. When first exposed to fire, it yields a phlegm called by him a *spirit*; which nevertheless is neither acid nor alkaline, but some water which enters into the composition of soap. It becomes more and more coloured and empyreumatic as the fire is increased, which shows that it contains the most subtle part of the oil. It seems even to raise along with it, by help of the oil and action of the fire, a small part of the alkali of the soap: for as the same chemist observes, it occasions a precipitate in a solution of corrosive sublimate. After this phlegm the oil rises altered, precisely as if it had been distilled from quicklime, that is, empyreumatic, soluble in spirit of wine, at first sufficiently subtle and afterwards thicker. An alkaline residuous coal remains in the retort, consisting chiefly of the mineral alkali contained in the soap, and which may be disengaged from the coal by calcination in an open fire, and obtained in its pure state.

Alkaline soaps are very useful in many arts and trades, and also in chemistry and medicine. Their principal utility consists in a detestive quality that they receive from their alkali, which, although it is in some measure saturated with oil, is yet capable of acting upon oily matters, and of rendering them saponaceous and miscible with water. Hence soap is very useful to cleanse any substances from all fat matters with which they happen to be soiled. Soap is therefore daily used for the washing and whitening of linen, for the cleaning of woollen-cloths from oil, and for whitening silk and freeing it from the resinous varnish with which it is naturally covered. Pure alkaline lissiviums being capable of dissolving oils more effectually than soap, might be employed for the same purposes; but when this activity is not mitigated by oil, as it is in soap, they are capable of altering, and even of destroying entirely by their causticity, most substances, especially animal matters, as silk, wool, and others: whereas soap cleanses from oil almost as effectually as pure alkali, without danger of altering or destroying; which renders it very useful.

Soap was imperfectly known to the ancients. It is mentioned by Pliny as made of fat and ashes, and as an invention of the Gauls. Aretæus and others inform us, that the Greeks obtained their knowledge of its medicinal use from the Romans. Its virtues, according to Bergius, are detergent, resolvent, and aperient, and its use recommended in jaundice, gout, calculous complaints, and in obstructions of the viscera. The efficacy of soap in the first of these diseases was experienced by Sylvius, and since recommended very generally by various authors who have written on this complaint; and it has also been thought of use in supplying the place of bile in the prime viæ. The utility of this medicine in icterical cases was inferred chiefly from its supposed power of dissolving biliary concretions; but this medicine has

lost much of its reputation in jaundice, since it is now known that gall-stones have been found in many after death who had been daily taking soap for several months and even years. Of its good effects in urinary calculous affections, we have the testimony of several, especially when dissolved in lime-water, by which its efficacy is considerably increased; for it thus becomes a powerful solvent or mucus, which an ingenious modern author supposes to be the chief agent in the formation of calculi; it is, however, only in the incipient state of the disease that these remedies promise effectual benefit; though they generally abate the more violent symptoms where they cannot remove the cause. With Boerhaave soap was a general medicine: for he, he attributed most complaints to viscosity of the fluids, he, and most of the Boerhaavian school, prescribed it in conjunction with different resinous and other substances, in gout, rheumatism, and various visceral complaints. Soap is also externally employed as a resolvent, and gives name to several officinal preparations.

From the properties of soap we may know that it must be a very effectual and convenient anti-acid. It absorbs acids as powerfully as pure alkalies and absorbent earths, without having the causticity of the former, and without oppressing the stomach by its weight like the latter.

Lastly, we may perceive that soap must be one of the best of all antidotes to stop quickly, and with the least inconvenience, the bad effects of acid corrosive poisons, as aquafortis, corrosive sublimate, &c.

Soap imported is subject by 10 Ann. cap. 19. to a duty of 2d. a pound (over and above former duties); and by 12 Ann. stat. 2. cap. 9. to the farther sum of 1d. a pound. And by the same acts, the duty on soap made in the Kingdom is 1½d. a pound. By 19 G. III. cap. 52. no person within the limits of the head office of excise in London shall be permitted to make any soap unless he occupy a tenement of 10l. a year, be assessed, and pay the parish rates; or elsewhere, unless he be assessed, and pay to church and poor. Places of making are to be entered on pain of 50l. and covers and locks to be provided under a forfeiture of 100l.; the furnace-door of every utensil used in the manufacture of soap shall be locked by the excise officer, as soon as the fire is damped or drawn out, and fastenings provided, under the penalty of 50l.; and opening or damaging such fastening incurs a penalty of 100l. Officers are required to enter and survey at all times, by day or night, and the penalty of obstructing is 20l.; and they may unlock and examine every copper, &c. between the hours of five in the morning and eleven in the evening, and the penalty of obstructing is 100l. Every maker of soap before he begins any making, if within the bills of mortality, shall give 12 hours, if elsewhere 24 hours, notice in writing to the officer, of the time when he intends to begin, on pain of 50l. No maker shall remove any soap unsurveyed on pain of 20l. without giving proper notice of his intention. And if any maker shall conceal any soap or materials, he shall forfeit the same, and also 500l. Every barrel of soap shall contain 236 lb. avoirdupois, half barrel 128 lb. firkin 64 lb. half-firkin 32 lb. besides the weight or tare of each cask: and all soap, excepting hard cake soap and ball soap, shall be put into such casks and no other, on pain of forfeiture, and 5l. The maker shall

Soap
||
Society.

weekly enter in writing at the next office the soap made by him in each week, with the weight and quantity at each boiling, on pain of 5*l.*; and within one week after entry clear off the duties, on pain of double duty. See, besides the statutes above cited, 5 Geo. II. cap. 43. 12 Geo. III. cap. 46. 11 Geo. cap. 30. 1 Geo. stat. 2. cap. 36.

Acid SOAP. This is formed by the addition of concentrated acids to the expressed oils. Thus the oil is rendered partially soluble in water; but the union is not sufficiently complete to answer any valuable purpose.

SOAP-Berry Tree. See *SAPINDUS*, BOTANY Index.

SOAP-Earth. See *STREATITES*, MINERALOGY Index.

SOAPWORT. See *SAPONARIA*, BOTANY Index.

SOC (Sax.), signifies power or liberty to minister justice or execute laws; also the circuit or territory wherein such power is exercised. Whence our law-Latin word *foeca* is used for a feignory or lordship enfranchised by the king, with the liberty of holding or keeping a court of his *foekmen*: And this kind of liberty continues in divers parts of England to this day, and is known by the names of *foke* and *fofen*.

SOCAGE, in its most general and extensive signification, seems to denote a tenure by any certain and determinate service. And in this sense it is by our ancient writers constantly put in opposition to chivalry or knight-service, where the render was precarious and uncertain. The service must therefore be certain, in order to denominate it socage; as to hold by fealty and 2*s.* rent; or, by homage, fealty, and 20*s.* rent; or, by homage and fealty without rent; or, by fealty and certain corporal service, as ploughing the lord's land for three days; or, by fealty only without any other service: for all these are tenures in socage.

Socage is of two sorts: *free-socage*, where the services are not only certain but honourable; and *villain-socage*, where the services, though certain, are of a baser nature (see *VILLENAGE*). Such as hold by the former tenure are called, in Glanvil and other subsequent authors, by the name of *liberi foekmanni*, or tenants in free-socage. The word is derived from the Saxon appellation *foe*, which signifies liberty or privilege; and, being joined to an usual termination, is called *foeage*, in Latin *foecagium*; signifying thereby a free or privileged tenure.

It seems probable that the socage-tenures were the relics of Saxon liberty; retained by such persons as had neither forfeited them to the king, nor been obliged to exchange their tenure for the more honourable, as it was called, but at the same time more burthenome, tenure of knight-service. This is peculiarly remarkable in the tenure which prevails in Kent, called *gavelkind*, which is generally acknowledged to be a species of socage-tenure; the preservation whereof inviolate from the innovations of the Norman conqueror is a fact universally known. And those who thus preserved their liberties were said to hold in free and common socage.

As therefore the grand criterion and distinguishing mark of this species of tenure are the having its renders or services ascertained, it will include under it all other methods of holding free lands by certain and invariable rents and duties; and in particular, *POUR SERVICES*, *TENURE IN BURGAGE*, and *GAVELKIND*. See these articles.

SOCIETY, a number of rational and moral be-

ings, united for their common preservation and happiness.

There are flocks of fishes, herds of quadrupeds, and flocks of birds. But till observation enable us to determine with greater certainty, how far the inferior animals are able to look through a series of means to the end which they are calculated to produce, how far their conduct may be influenced by the hope of reward and the fear of punishment, and whether they are at all capable of moral distinctions—we cannot with propriety apply to them the term *Society*. We call crows and beavers, and several other species of animals, *gregarious*; but it is hardly good English to say that they are *social*.

It is only human society, then, that can become the subject of our present investigation. The phenomena which it presents are highly worthy of our notice.

Such are the advantages which each individual evidently derives from living in a social state; and to helpless does any human being appear in a solitary state, that we are naturally led to conclude, that it there ever was a period at which mankind were solitary beings, that period could not be of long duration: for their aversion to solitude and love of society would soon induce them to enter into social union. Such is the opinion which we are led to conceive, when we compare our own condition as members of civilized and enlightened society with that of the brutes around us, or with that of savages in the earlier and ruder periods of social life. When we hear of Indians wandering naked through the woods, destitute of arts, unskilled in agriculture, scarce capable of moral distinctions, void of all religious sentiments, or possessed with the most absurd notions concerning superior powers, and procuring means of subsistence in a manner equally precarious with that of the beasts of prey—we look down with pity on their condition, or turn from it with horror. When we view the order of cultivated society, and consider our institutions, arts, and manners—we rejoice over our superior wisdom and happiness.

Man in a civilized state appears a being of a superior order to man in a savage state; yet some philosophers tell us, that it is only he who, having been educated in society, has been taught to depend upon others, that can be helpless or miserable when placed in a solitary state. They view the savage who exerts himself with intrepidity to supply his wants, or bears them with fortitude, as the greatest hero, and possessing the greatest happiness. And therefore if we agree with them, that the propensities of nature may have prompted men to enter into social union, though they may have hoped to enjoy superior security and happiness by engaging to protect and support each other, we must conclude that the Author of the universe has declined man to attain greater dignity and happiness in a savage and solitary than in a social state; and therefore that those dispositions and views which lead us to society are fallacious and inimical to our real interest.

Whatever be the supposed advantages of a solitary state, certain it is that mankind, at the earliest period, were united in society. Various theories have been formed concerning the circumstances and principles which gave rise to this union: but we have elicited here, that the greater part of them are founded in error; that they suppose the original state of man to have

Black P.
Comment.
vol. II.

Def. 100.

Society.

Society.

been that of savages; and that such a supposition is contradicted by the most authentic records of antiquity. For though the records of the earlier ages are generally obscure, fabulous, and imperfect; yet happily there is *one* free from the imperfections of the rest, and of undoubted authenticity, to which we may safely have recourse.

* See Scrip- ture, N^o 7—

5
First state of Society according to authentic history.

This record is the Pentateuch of Moses, which presents us with a genuine account of the origin of man and of society, perfectly consonant to what we have laid down in the article referred to (see SAVAGE). According to Moses, the first society was that of a husband and wife united in the bonds of marriage: the first government that of a father and husband, the master of his family. Men lived together under the patriarchal form of government while they employed themselves chiefly in tending flocks and herds. Children in such circumstances cannot grow up to an equality with their parents, where a man's importance depends on his property, not on his abilities. When flocks and herds are the chief articles of property, the son can only obtain these from his father; in general therefore the son must be entirely dependent on the father for the means of subsistence. If the parent during his life bestow on his children any part of his property, he may do so on such conditions as shall make their dependence upon him continue till the period of his death. When the community are by this event deprived of their head, instead of continuing in a state of union, and selecting some one from among themselves whom they may invest with the authority of a parent, they separate into so many distinct tribes, each subjected to the authority of a different lord, the master of the family, and the proprietor of all the flocks and herds belonging to it. Such was the state of the first societies which the narrative of Moses exhibits to our attention.

6
Theories of Philosophy concerning the origin of Society.

Those philosophers who have made society, in its various stages between rudeness and refinement, the subject of their speculations, have generally considered mankind, in whatever region of the globe, and under whatever climate, as proceeding uniformly through certain regular gradations from one extreme to the other. They regard them, first, as gaining a precarious subsistence by gathering the spontaneous fruits of the earth, preying on the inhabitants of the waters, if placed on the sea-shore, or along the banks of large rivers; or hunting wild beasts, if in a situation where these are to be found in abundance; without foresight or industry to provide for future wants when the present call of appetite is gratified. Next, they fix, man rises to the shepherd state, and next to that of husbandman, when they turn their attention from the management of flocks to the cultivation of the ground. Next, these husbandmen improve their powers, and better their condition, by becoming artificers and merchants; and the beginning of this period is the boundary between barbarity and civilization.

These are the stages through which they who have employed themselves on the natural history of society have generally conducted mankind in their progress from rudeness to refinement; but they seem to have overlooked the manner in which mankind were at first established on this earth; for the circumstances in which the parents of the human race were originally placed; for the degree of knowledge communicated to them; and for the instruction which they must have been capable of

communicating to their posterity. They rather appear to consider the inhabitants of every different region of the globe as aborigines, springing at full from the ground, or dropped on the spot which they inhabit; no less ignorant than infants of the nature and relations of the objects around them, and of the purposes which they may accomplish by the exercise of their organs and faculties.

7
are fanciful.

The absurdity of this theory has been fully demonstrated in another place; and if we agree to receive the Mosaic account of the original establishment of mankind, we shall be led to view the phenomena of social life in a light very different. We must first allow, that though many of the rudest tribes are found in the state of *hunters or fishers*; yet the hunting or fishing state cannot have been invariably the primary form of society. Notwithstanding the powers with which we are endowed, we are in a great measure the creatures of circumstances. Physical causes exert, though indirectly, a mighty influence in forming the character and directing the exertions of the human race. From the information of Moses we gather, that the first societies of men lived under the patriarchal form of government, and employed themselves in the cultivation of the ground and the management of flocks. And as we know that mankind, being subjected to the influence both of physical and moral causes, are no less liable to degeneracy than capable of improvement; we may easily conceive, that though descending all from the same original pair, and though enlightened with much traditional knowledge relative to the arts of life, the order of society, moral distinctions, and religious obligations; yet as they were gradually, and by various accidents, dispersed over the earth, being removed to situations in which the arts with which they were acquainted could but little avail them, where industry was overpowered, or indolence encouraged by the severity or the profusion of nature, they might degenerate and fall into a condition almost as humble and precarious as that of the brutal tribes. Other moral causes might also concur to debase or elevate the human character in that early period. The particular character of the original settlers in any region, the manner in which they were connected with one another, and the arts which they were best qualified to exercise, with various other causes of a similar nature, would have considerable influence in determining the character of the society.

When laying aside the spirit of theory and system, we set ourselves, with due humility, to trace facts, and to listen to evidence, though our discoveries may be fewer than we should otherwise fancy them; yet the knowledge which we thus acquire will be more useful and solid, and our speculations more consistent with the spirit of true philosophy. Here, though we learn from the information of the sacred writings, that the first family of mankind was not cruelly exposed in this world, as children whom the inhumanity of their parents induces them to desert; yet we are not, in consequence of admitting this fact, laid under any necessity of denying or explaining away any of the other phenomena which occur to our observation when tracing the natural history of society. Tradition may be corrupted; arts and sciences may be lost; the sublimest religious doctrines may be debated into absurdity.

If then we are desirous of surveying society in its rudest

Society. del form, we must look, not to the earliest period of existence, but to those districts of the globe where excellent circumstances concur to drive them into a state of misery and wretchedness. Thus in many places of the happy clime of Asia, which a variety of ancient records appear with the fixed writings representing as the best peopled parts of the globe, we do not trace the form of society hitherto been described in nature. In that state indeed the herds which support society extend not to a wide range of individuals, and men remain for a long period in distinct families; but yet that state is highly favourable to knowledge, to happiness, and to virtue. Again, the torrid and the frozen regions of the earth, though probably peopled at a later period, and by tribes sprung from the same stock with the shepherds of Asia, have yet exhibited mankind in a much lower state. It is in the parched deserts of Africa and the wilds of America that human beings have been found in a condition approaching the nearest to that of the brutes.

We may therefore with some propriety defer the order of time, and take a view of the different stages through which philosophers have considered mankind as advancing, beginning with that of rudeness, though we have shown that it cannot have been the first in the progress.

Rudeness of Society. Where the human species are found in the lowest and rudest state, their rational and moral powers are very faintly displayed; but their external senses are acute, and their bodily organs active and vigorous. Hunting and fishing are then their chief employments on which they depend for support. During that portion of their time which is not spent in these pursuits, they are sunk in listless indolence. Destitute of foresight, they are roused to active exertion only by the pressure of immediate necessity or the urgent calls of appetite. Accustomed to endure the severity of the elements, and but scantily provided with the means of subsistence, they acquire habits of resignation and fortitude, which are beheld with astonishment by those who enjoy the plenty and indulgence of cultivated life. But in this state of want and depression, when the powers and possessions of every individual are scarcely sufficient for his own support, when even the calls of appetite are repressed because they cannot always be gratified, and the more refined passions, which either originate from such as are merely animal, or are intimately connected with them, have not yet been felt—in this state all the milder affections are unknown; or if the breast is at all sensible to their impulses, it is extremely feeble. Husband and wife, parent and child, brother and brother, are united by the weakest ties. Want and misfortune are not pitied. Why indeed should they, where they cannot be relieved? It is impossible to determine how far beings in this condition can be capable of moral distinctions. One thing certain is, that in no state are the human race entirely incapable of these. If we listen, however, to the relations of respectable travellers, we must admit that human beings have sometimes been found in that abject state where no proper ideas of subordination, government, or distinction of ranks, could be formed. No distinct notions of Deity can be here entertained. Brings in so humble a condition cannot look through the order of the universe and the harmony of nature to that Eternal Wisdom and Goodness which contrive,

and that Almighty Power which brought into existence the system of things. Of arts they must be almost totally destitute. They may use some instruments for killing or the chase; but their tools are extremely rude and simple. They have acquired but a very imperfect idea of their own strength, and are ignorant of the uses of their bodies and of the good which labour and industry procure.

But human beings have not been so found in a rude state as to be destitute of all the faculties of the human frame, and of the most part of their nature, derived from more animal life. They generally appear clothed under some species of government, resembling in some ways of reason, capable of morality, though that morality be not always very refined; displaying some degree of social virtues, and acting under the influence of religious sentiments. People who may be considered as but one degree higher in the scale than the abject and wretched beings whose condition we have traversed, are to be found still in the hunting and fishing state; but they are farther advanced towards social life, and are become more sensible to the impulse of affection. By unavoidable intercourse in their employments, a few individual hunters or fishers contract a certain degree of fondness for each other's company, and are led to take some part in each other's joys and sorrows; and when the social affections thus generated (see PARSON) begin to exert themselves, all the other powers of the mind are at the same time called forth, and the circumstances of the little society are immediately improved. We behold its members in a more comfortable condition, and find reason to view the human character with more complacency and respect. Huts are now built, more commodious clothes are fashioned, instruments for the annoyance of wild beasts and even of enemies are contrived, in short, arts, and science, and social order, and religious sentiment, and ceremonies, now make their appearance in the rising society, and serve to characterize it by the particular form which distinguishes each of them. But though social order is no longer unknown nor unobserved, yet the form of government is still extremely simple, and its ties are but loose and feeble. It will perhaps bear some resemblance to the patriarchal; only all its members are on a more equal footing, and at the same time less closely connected than in the shepherd state, to which that form of government seems almost peculiar. The old men are treated with veneration; but the young are not entirely subject to them. They may listen respectfully to their advice; but they do not submit to their arbitrary commands. Where mankind are in the state of hunters and fishers, where the means of subsistence are precariously acquired, and prudent foresight does not prompt to accumulate much provision for the future, no individual can acquire comparative wealth. As soon as the son is grown up, he ceases to be dependent on his father, as well as on the society in general. Difference of experience therefore constitutes the only distinction between the young and the old; and if the old have experience, the young have strength and activity. Here, then, neither age nor property can give rise to any striking distinction of ranks. All who have attained to manhood, and are not debilitated by unusual debility of strength or agility, or by the infirmities of old age, are on an equal footing; or if any one seeks a pre-eminence over the rest, he owes it to superior

superior address or fortitude. The whole tribe deliberate; and the old give their advice; each individual of the assembly receives or rejects it at his pleasure (for the whole body think not of exercising any compulsory power over the will of individuals); and the warrior who is most distinguished for strength, address, and valour, leads out the youth of the tribe to the chase or against the enemy. War, which in the former stage did not prevail, as they who were strangers to social sentiments were, at the same time, scarce capable of being enemies, now first begins to depopulate the thinly inhabited regions where those hunters and fishers pursue their prey. They are scattered, possibly in scanty and separate tribes, over an immense tract of country; but they know no medium between the affection which brethren of the same tribe bear to each other and the hatred of enemies. Though thinly scattered over the earth, yet the hunting parties of different tribes will sometimes meet as they range the forests; and when they meet, they will naturally view each other with a jealous eye; for the success of the one party in the chase may cause the other to be unsuccessful; and while the one snatches the prey, the other must return home to all the pangs of famine. Inveterate hostility will therefore long prevail among neighbouring tribes in the hunting state.

If we find them not incapable of social order, we may naturally expect that their conduct will be influenced by some sentiments of religion. They have at this period ideas of superior beings. They also practise certain ceremonies to recommend them to those beings; but both their sentiments and ceremonies are superstitious and absurd.

We have elsewhere shown (see POLYTHEISM) how savage tribes have probably degenerated from the pure worship of the one true God to the adoration of a multitude of imaginary divinities in heaven, earth, and hell. We have traced this idolatrous worship from that of the heavenly bodies, through all the gradations of demon-worship, hero-worship, and statue-worship, to that wonderful instance of absurd superstition which induced the inhabitants of some countries to fall prostrate in adoration before the vilest reptiles. But though we are convinced that the heavenly bodies have by all idolaters been considered as their first and greatest gods, we pretend not that the progress through the other stages of polytheism has been everywhere in the very same order. It is indeed impossible to exhibit under one general view an account of arts, manners, and religious sentiments, which may apply to some certain period in the history of every nation. The characters and circumstances of nations are scarce less various and anomalous than those of individuals. Among many of the American tribes, among the ancient inhabitants of the forests of Germany, whose manners have been so accurately delineated by the masterly pen of Tacitus, and in some of the islands scattered over the southern ocean, religion, arts, and government, have been found in that state which we have described as characterizing the second stage of social life. But neither can we pretend that all those simple and rude societies have been described by historians and travellers as agreeing precisely in their arts, manners, and religious sentiments; or that the difference of circumstances always enables us to account in a satisfactory manner for the distinction of their

characters. There is a variety of facts in the history of the early periods of society, which no ingenuity, no industry however painful, can reduce under general heads. Here, as well as when we attempt to philosophize on the phenomena of the material world, we find reason to confess that our powers are weak, and our observation confined within a narrow sphere.

But we may now carry our views a little forward, and survey human life as approaching somewhat nearer to a civilized and enlightened state. As property is acquired, inequality and subordination of ranks necessarily follow; and when men are no longer equal, the many are soon subjected to the will of the few. But what advantages rise to these new phenomena is, that after having often suffered from the precariousness of the hunting and fishing state, men begin to extend their cares beyond the present moment, and to think of providing some supply for future wants. When they are enabled to provide such a supply, either by pursuing the chase with new eagerness and perseverance, by gathering the spontaneous fruits of the earth, or by breeding tame animals—these acquisitions are at first the property of the whole society, and distributed from a common store to each individual according to his wants: But as various reasons will soon concur to convince the community, that by this mode of distribution, industry and activity are treated with injustice, while negligence and indolence receive more than their due, each individual will in a short time become his own steward, and a community of goods will be abolished. As soon as distinct ideas of property are formed, it must be unequally distributed; and as soon as property is unequally distributed, there arises an inequality of ranks. Here we have the origin of the depression of the female sex in rude ages, of the tyrannical authority exercised by parents over their children, and perhaps of slavery. The women cannot display the same perseverance, or activity, or address, as the men, in pursuing the chase. They are therefore left at home; and from that moment are no longer equals, but slaves and dependants, who must submit by the bounty of the males, and must therefore submit with implicit obedience to all their capricious commands. Even before the era of property, the female sex were viewed as inferiors; but till that period they were not reduced to a state of abject slavery.

In this period of society new notions are formed of the relative duties. Men now become citizens, masters, and servants; husbands, parents, &c. It is impossible to enumerate all the various modes of government which take place among the tribes who have advanced to this stage; but one thing certain is, that the authority of the few over the many is now first established, and that the rise of property first introduces inequality of ranks. In one place, we shall perhaps find the community subjected during this period to the will of a single person; in another, power may be lodged in the hands of a number of chiefs; and in a third, every individual may have a voice in creating public officers, and in enacting laws for the support of public order. But as no code of laws is formed during this period, justice is not very impartially administered, nor are the rights of individuals very faithfully guarded. Many actions, which will afterwards be considered as heinously immoral, are now considered as praise-worthy or indifferent. This is the age of hero-worship, and of household and tutelary gods;

for it is in this stage of society that the invention of arts, which gave rise to that worship, contrivances most conspicuously to the public good. War, too, which we considered as beginning first to ravage the earth during the former period, and which is another cause of the dedication of dead men, will still prevail in this age, and be carried on with no less ferocity than before, though in a more systematic form.

The prevalence of war, and the means by which subsistence is procured, cannot but have considerable influence on the character and sentiments of societies and individuals. The hunter and the warrior are characters in many respects different from the shepherd and the husbandman. Such, in point of government, arts, and manners, religious and moral sentiments, were several of the German tribes described by Tacitus; and the Britons whose character has been sketched by the pen of Cæsar: such, too, were the Romans in the early period of their history; such too the inhabitants of Asia Minor about the time of the siege of Troy, as well as the Greeks whom Homer celebrates as the destroyers of the Trojan state: the northern tribes also, who poured through Asia, Africa, and Europe, and overthrew the Roman empire, appear to have been of a nearly similar character. It seems to be a general opinion among those who have directed their attention to the history of society, that, in the scale ascending from the lowest condition of human beings to the most civilized and enlightened state of society, the shepherd state is the next in order above the hunting; and that as mankind improve in knowledge and in moral sentiments, and as the forests are gradually depopulated of their inhabitants, instead of destroying the inferior animals, men become their guardians and protectors. But we cannot unreservedly subscribe to this opinion: we believe, that in the shepherd state societies have been sometimes found superior to the most polished tribes of hunters; but upon viewing the annals of mankind in early ages, we observe that there is often no inconsiderable resemblance even between hunters and shepherds in point of the improvement of the rational faculties and the moral sense; and we are therefore led to think, that these two states are sometimes parallel: for instance, several of the American tribes, who still procure their subsistence by hunting, appear to be nearly in the state which we have described as the third stage in the progress of society; and the ancient shepherds of Asia do not appear to have been much more cultivated and refined. We even believe that men have sometimes turned their attention from hunting to agriculture, without passing through any intermediate state. Let us remember, that much depends upon local circumstances, and somewhat undoubtedly on original inspiration and traditional instruction. In this period of society the state of the arts well deserves our attention. We shall find, that the shepherds and the hunters are in that respect on a pretty equal footing. Whether we examine the records of ancient history, or view the islands scattered through the South sea, or range the wilds of America, or survey the snowy wastes of Lapland and the frozen coast of Greenland—still we find the useful arts in this period, though known and cultivated, in a very rude state; and the fine arts, or such as are cultivated merely to please the fancy or to gratify caprice, displaying an odd and fantastic, not a true or natural, taste; yet this is the period in which eloquence

shines with the truest lustre: all is metaphor or glowing sentiment. Languages are not yet copious; and therefore speech is figurative, expressive, and forcible. The tones and gestures of nature, not being yet laid aside, as they generally are, from regard to decorum, in more polished ages, give a degree of force and expression to the harangues of the rustic or savage orator, which the most laborious study of the rules of rhetoric and elocution could not enable even a more polished orator to display.

But let us advance a little farther, and contemplate our species in a new light, where they will appear in greater dignity and amiableness of character. Let us view them as husbandmen, artisans, and legislators. Whatever circumstances might turn the attention of any people from hunting to agriculture, or cause the herdman to yoke his oxen for the cultivation of the ground, certain it is that this change in the occupation would produce a happy change on the character and circumstances of men; it would oblige them to exert a more regular and persevering industry. The hunter is like one of those birds that are described as passing the winter in a torpid state. The shepherd's life is extremely indolent. Neither of these is very favourable to refinement. But different is the condition of the husbandman. His labours succeed each other in regular rotation through the year. Each season with him has its proper employments: he therefore must exert active persevering industry; and in this state we often find the virtues of rude and polished ages united. This is the period where barbarism ends and civilization begins. Nations have existed for ages in the hunting or the shepherd state, fixed as by a kind of stagnation, without advancing farther. But scarcely any instances occur in the history of mankind of those who once reached the state of husbandmen, remaining long in that condition without rising to a more civilized and polished state. Where a people turn their attention in any considerable degree to the objects of agriculture, a distinction of occupations naturally arises among them. The husbandman is so closely employed through the several seasons of the year in the labours of the field, that he has no longer leisure to exercise all the rude arts known among his countrymen. He has not time to fashion the instruments of husbandry, to prepare his clothes, to build his house, to manufacture household utensils, or to tend those tame animals which he continues to rear. Those different departments therefore now begin to employ different persons; each of whom dedicates his whole time and attention to his own occupation. The manufacture of cloth is for a considerable time managed exclusively by the women; but smiths and joiners arise from among the men. Metals begin now to be considered as valuable materials. The intercourse of mankind is now placed on a new footing. Before, every individual practised all the arts that were known, as far as was necessary for supplying himself with the conveniences of life. Now he confines himself to one or to a few of them; and, in order to obtain a necessary supply of the productions of those arts which he does not cultivate himself, he gives in exchange a part of the productions of his own labours. Here we have the origin of commerce.

After continuing perhaps for some time in this state, as arts and distinctions multiply in society, the cele-

Society

change of one commodity for another is found troublesome and inconvenient. It is ingeniously contrived to adopt a medium of commerce, which being estimated not by its intrinsic value, but by a certain nominal value which it receives from the agreement of the society among whom it is used, serves to render the exchange of property, which is so necessary for the purposes of social life, easy and expeditious. Wherever metals have been known, they appear to have been adopted as the medium of commerce almost as soon as such a medium began to be used; and this is one important purpose for which they serve; but they have still more important uses. Almost all the necessary arts depend on them. Where the metals are known, agriculture practised, and the necessary arts distributed among different orders of artificers—civilization and refinement, if not obstructed by some accidental circumstances, advance with a rapid progress. With regard to the first applying of the precious metals as the medium of commerce, we may observe, that this was probably not accomplished by means of a formal contract. They might be first used as ornaments; and the love of ornament, which prevails among rude as much as among civilized nations, would render every one willing to receive them in exchange for such articles as he could spare. Such might be the change produced on society with regard to the necessary arts by the origin of agriculture. As soon as ornament and amusement are thought of, the fine arts begin to be cultivated. In their origin therefore they are not long posterior to the necessary and useful arts. They appear long before men reach the comfortable and respectable condition of husbandmen; but so rude is their character at their first origin, that our *Dilettanti* would probably view the productions of that period with unspeakable contempt and disgust. But in the period of society which we now consider, they have aspired to a higher character; yet poetry is now perhaps less generally cultivated than during the shepherd state. Agriculture, considered by itself, is not directly favourable either to refinement of manners or to the fine arts. The conversation of shepherds is generally supposed to be far more elegant than that of husbandmen; but though the direct and immediate effects of this condition of life be not favourable to the fine arts, yet indirectly it has a strong tendency to promote their improvement. Its immediate influence is extremely favourable to the necessary and useful arts; and there are no less favourable to the fine arts.

One of the noblest changes which the introduction of the arts by agriculture produces on the form and circumstances of society, is the introduction of regular government and laws. In tracing the history of ancient nations, we scarcely ever find laws introduced at an earlier period. Minos, Solon, and Lycurgus, do not appear to have formed codes of wisdom and justice for regulating the manners of their countrymen, till after the Greeks, the Athenians, and even the Lacedæmonians, had made some progress in agriculture and the useful arts.

Religion, under all its various forms, has in every stage of society a mighty influence on the sentiments and conduct of men (see BELIEF); and the arts cultivated in society have on the other hand some influence on the system of religious belief. One happy effect

which will result from the invention of arts, though perhaps not immediately, will be, to render the character of the deities more benevolent and amiable, and the rites of their worship more mild and humane.

The female sex in this period generally find the yoke of their slavery somewhat lightened. Men now become easier in their circumstances; the social affections refine through influence over the mind; plenty, and security, and ease, at once communicate both delicacy and licentiousness to the sensual desires. All these circumstances concur to make men relax in some degree that tyrannical sway by which they before depressed the softer sex. The foundation of that empire, where beauty triumphs over both wisdom and strength, now begins to be laid. Such are the effects which history warrants as to attribute to agriculture and the arts; and such the outlines of the character of that which we reckon the fourth stage in the progress of society from rudeness to refinement.

Let us advance one step farther. We have not yet surveyed mankind in their most polished and cultivated state. Society is rude at the period when the arts first begin to flow themselves, in comparison of that state to which it is raised by the industrious cultivation of them. The neighbouring commonwealths of Athens and Lacedæmon afford us a happy opportunity of comparing this with the former stage in the progress of society. The chief effect produced by the institutions of Lycurgus seems to have been, to fix the manners of his countrymen for a considerable period in that state to which they had attained in his days. Spartan virtue has been admired and extolled in the language of enthusiasm; but in the same manner has the character and the condition of the savage inhabitants of the wilds of America, been preferred by some philosophers, to the virtues and the enjoyments of social life in the most polished and enlightened state. The Spartans in the days of Lycurgus had begun to cultivate the ground, and were not unacquainted with the useful arts. They must soon have advanced farther had not Lycurgus arisen, and by effecting the establishment of a code of laws, the tendency of which appears to have been in many particulars directly opposite to the designs of nature, retarded their progress towards complete civilization and refinement. The history of the Lacedæmonians, therefore, while the laws of Lycurgus continued in force, exhibits the manners and character of a people in that which we have denominated the fourth stage in the progress of society. But if we turn our eyes to their neighbours the Athenians, we behold in their history the natural progress of opinions, arts, and manners. The useful arts are first cultivated with such steady industry, as to raise the community to opulence, and to furnish them with articles for commerce with foreign nations. The useful arts cannot be raised to this height of improvement without leading men to the pursuit of science. Commerce with foreign nations, skill in the useful arts, and a taste for science, mutually aid each other, and conspire to promote the improvement of the fine arts. Hence magnificent buildings, noble statues, paintings expressive of life, action, and passion; and poems in which imagination adds new grace and sublimity to nature, and gives the appearances of social life more irresistible power over the affections of the heart. Hence are moral distinctions more carefully studied, and

Society

the rights of every individual and every order in society better understood and more accurately defined. Moral science is generally the first scientific pursuit which strongly attracts the attention of men. Lawgivers appear before geometers and astronomers. Some particular circumstances may cause these sciences to be cultivated at a very early period. In Egypt the overflowing of the Nile caused geometry to be early cultivated. Causes no less favourable to the study of astronomy, concurred to recommend that science to the attention of the Chaldeans long before they had attained the height of refinement. But, in general, we find, that the laws of morality are understood, and the principles of morals inquired into, before men make any considerable progress in physical science, or even prosecute it with any degree of keenness. Accordingly, when we view the state of literature in this period (for it is now become an object of so much importance as to force itself on our attention), we perceive that poetry, history, and morals, are the branches chiefly cultivated. Arts are generally casual inventions, and long untried before rules and principles on which they are founded assume the form of science. But morality, if considered as an art, is that art which men have longest and most constantly occasion to practise. Besides, we are to be constituted by the wisdom of nature, that human actions, and the events which befall human beings, have more powerful influence than any other object to engage and fix our attention. Hence we are enabled to explain why morality, and the branches of literature more immediately connected with it, are almost always cultivated in preference to physical science. Though poetry, history, and morals, be pursued with no small eagerness and success in that period of society which we now consider, we need not therefore be greatly surprised that natural philosophy is neither very generally nor very successfully cultivated. Were we to consider each particular in that happy change which is now produced on the circumstances of mankind, we should be led into a too minute and perhaps unimportant detail. This is the period when human virtue and human abilities shine with most splendor. Rusticity, ferocity, and barbarism, are now banished. Luxury has made her appearance; but as yet she is the friend and the benefactress of society. Commerce has stimulated and rewarded industry, but has not yet contracted the heart and debased the character. Wealth is not yet become the sole object of pursuit. The charms of social intercourse are known and relished; but domestic duties are not yet deserted for public amusements. The female sex acquire new influence, and contribute much to reform and polish the manners of their lords. Religion now assumes a milder and more pleasing form; splendid rites, magnificent temples, pompous sacrifices, and gay festivals, give even superstition an influence favourable to the happiness of mankind. The gloomy notions and barbarous rites of former periods fall into disuse. The system of theology produced in former ages still remains; but only the mild and amiable qualities of the deities are celebrated; and none but the gay, humane, and laughing divinities, are worshipped. Philosophy also teaches men to discard such parts of their religion as are unfriendly to good morals, and have any tendency to call forth or cherish unwholesome sentiments in the heart. War (for in this period of society enough of causes will arise to arm one

nation against another)—war, however, no longer retains its former ferocity; nations no longer strive to extirpate one another; to procure redress for real or imaginary injuries; to humble, not to destroy, is now its object. Prisoners are no longer murdered in cold blood, subjected to horrid and excruciating tortures, or condemned to hopeless slavery. They are ransomed or exchanged; they return to their country, and again fight under its banners. In this period the arts of government are likewise better understood, and practised so as to contribute most to the interests of society. Whether monarchy, or democracy, or aristocracy, be the established form, the rights of individuals and of the city are in general respected. The interests of society are so well understood, that the few, in order to preserve their influence over the many, find it necessary to act rather as the faithful servants than the imperious lords of the public. Though the liberties of a nation in this state be not accurately defined by law, nor their property guaranteed to them by any legal institutions, yet their governors dare not violate their liberties, nor deprive them wantonly of their properties. This is truly the golden age of society; every trace of barbarism is entirely effaced; and vicious luxury has not yet begun to sap the virtue and the happiness of the community. Men live not in listless indolence; but the industry in which they are engaged is not of such a nature as to over-weigh their strength or exhaust their spirits. The social affections have now the strongest influence on men's sentiments and conduct.

But human affairs are scarcely ever stationary. The ¹⁴Democracy circumstances of mankind are almost always changing, and degenerating, either growing better or worse. Their manners are ever in the same fluctuating state. They either advance towards perfection or degenerate. Scarcely have they attained that happy period in which we have just contemplated them, when they begin to decline till they perhaps fall back into a state nearly as low as that from which we suppose them to have emerged. Instances of this unhappy degeneracy occur more than once in the history of mankind; and we may finish this short sketch of the history of society by mentioning in what manner this degeneracy takes place. Perhaps, strictly speaking, every thing but the simple necessities of life may be denominated luxury: For a long time, however, the welfare of society is best promoted, while its members are after something more than the mere necessities of life. As long as these superfluities are to be obtained only by active and honest exertion; as long as they only engage the leisure hours, without becoming the chief objects of pursuit—the employment which they give to the faculties is favourable both to the virtue and the happiness of the human race.

The period arrives, however, when luxury is no longer serviceable to the interests of nations; when she is no longer a graceful, elegant, active form, but a languid, overgrown, and bloated carcass. It is the love of luxury, which contributed so much to the civilization of society, that now brings on its decline. Arts are cultivated and improved, and commerce extended, till enormous opulence be acquired: the efforts of industry to awaken the fancy, to conceive ideas of new and arduous wants, and to inflame the breast with new desires. Here we have the origin of that selfishness which, operating in conjunction with avarice and the violence of

unbridled passions, contributes so much to the corruption of virtuous manners. Selfishness, caprice, indolence, effeminacy, all join to loosen the bonds of society, to bring on the degeneracy both of the useful and the fine arts; to banish at once the mild and the austere virtues, to destroy civil order and subordination, and to introduce in their room anarchy or despotism.

Scarcely could we have found an example of the beautiful form of society which we last attempted to describe. Never, at least, has any nation continued long to enjoy such happy circumstances, or to display so amiable and respectable a character. But when we speak of the declining state of society, we have no difficulty in finding instances to which we may refer. History tells of the Assyrians, the Egyptians, and the Persians, all of them once flourishing nations, but brought low by luxury and an unhappy corruption of manners. The Greeks, the Romans, and the Assyrians, owed their fall to the same causes; and we know not if a similar fate does not now threaten many of those nations who have long made a distinguished figure in the system of Europe. The Portuguese, the Venetians, and the Spaniards, have already fallen; and what is the present state of our neighbours the French? They have long been a people destitute of religion, corrupted in morals, unsteady in conduct, and thus to pleasure and public amusements. Among them luxury had arrived at its highest pitch; and the consequence has been, that after capriciously flaking off the yoke of despotism, they have established, or rather set on foot (as it should be), a motley kind of government, which, in the course of a few years, has exhibited scenes of tyranny and oppression, to which we doubt if the rulers of the world can furnish any parallel. Yet this is the people who in manners the other nations of Europe were ambitious to imitate. May those nations take warning in time, and avoid the rocks upon which they have split.

Thus have we viewed the several stages in which society appears in its progress from rudeness to refinement and decay. The intelligent reader will perceive, that the various and anomalous phenomena which occur in the natural history of society, cannot easily be solved; hence the necessary information cannot be obtained. Others have been well accounted for by the researches of certain philosophical inquirers. Local circumstances, the influence of climate, the intercourse of nations in different states of civilization, have been taken notice of, its causes serving to accelerate or retard the progress of arts and manners. But our proper business here was merely to mark the gradations between barbarism and refinement; and as the disorder who is to exhibit a series of manners resembling the human form in infancy, puerility, youth, and manhood, will not think of delineating all the variety of figures and faces which each of those periods of life affords, and will find himself unable to represent in any single figure all diversities of form and features; so we have not once the thought of describing particularly under this article, all the various national characters, so relative to any one of these divisions; under which, we have viewed the progress of society, nor have we found it possible to comprehend under one consistent view, all the particulars which may be derived from the remains of antiquity, from the rela-

tions of later travellers, and the general records of history concerning the progressive character of mankind in various regions, and under the influence of various accidents and circumstances. This indeed would even have been improper, as all that information appears under other articles in this Work.

SOCIETIES, associations voluntarily formed by a number of individuals for promoting knowledge, industry, or virtue. They may therefore be divided into three classes; societies for promoting science and literature, societies for encouraging and promoting arts and manufactures, and societies for diffusing religion and morality and relieving distress. Societies belonging to the first class extend their attention to all the sciences and literature in general, or devote it to one particular science. The same observation may be applied to those which are instituted for improving arts and manufactures. These of the third class are established, either with a view to prevent crimes, as the Philanthropic Society; or for the diffusion of the Christian religion among unenlightened nations, as the Society for the Propagation of the Gospel in Foreign Parts, or for introducing arts and civilization, along with a knowledge of the Christian religion, as the Sierra Leone company.

The honour of planning and instituting societies for these valuable purposes is due to modern times. A literary association is said to have been formed in the reign of Charlemagne (see ACADEMY); but the plan seems to have been rude and defective. Several others were instituted in Italy in the 16th century; but from the accounts which we have seen of them, they seem to have been far inferior to those which are most flourishing at present. The most enlarged idea of literary societies seems to have originated with the great Lord Bacon, the father of modern philosophy, who recommended to the reigning prince to institute societies of learned men, who should give to the world from time to time a regular account of their researches and discoveries. It was the idea of this great philosopher, that the learned world should be united, as it were, into one immense republic; which, though consisting of many detached states, should hold a strict union and preserve a mutual intelligence with each other, in every thing that regards the common interest. The want of this union and intelligence he laments as one of the chief obstacles to the advancement of science; and, justly considering the institution of public societies, in the different countries of Europe, under the auspices of the sovereign, to be the best remedy for that defect, he has given, in his fanciful work, the New Atlantis, the delineation of a philosophical society on the most extended plan, for the improvement of all arts and sciences; a work which, though written in the language, and tinged with the colouring of romance, is full of the noblest philosophic views. The plan of Lord Bacon, which met with little attention from the age in which he lived, was destined to produce its effect in a period not very distant. The scheme of a philosophical college by Cowley is acknowledged to have had a successful influence in procuring the establishment of the Royal Society of London by charter from Charles II. 6; and Cowley's plan is manifestly copied in almost all its parts from that in the New Atlantis. The institution of the Royal Society of London was soon followed by the establishment of the Royal Aca-

Relig-
ious
and
Huma-
nita-
rian
Soc-
ies

deny of Sciences at Paris, and that it has been served a model to those who place themselves of highest reputation in the other kingdoms of Europe.

The experience of ages has shown, that their weakness of mind, nature are not enabled by facilities of liberal and ingenious men, calling on their labours without regard to nature, but of privacy, in one grand pursuit at once interesting to all, were any material premiums are worn off, and a humane philosophy spirit is extinguished. Men united together, and frequently meeting for the purpose of advancing the sciences, the arts, agriculture, manufactures, and commerce, may often almost forget such hints to one another as may be improved to important ends; and such societies, by using the opportunities of the observations and differences of the learned and ingenious, may from time to time furnish the world with useful publications which might otherwise be lost; for men of ingenuity and industry may not choose to sink their reputation, by sending abroad unpublished what a learned Society might judge highly worth the public eye; or perhaps their circumstances being distressed, they may not be able to delay the expense of publication. Societies instituted for promoting knowledge may also be of eminent service, by exciting a spirit of emulation, and by enquiring those points of genius which otherwise might for ever have been concealed; and if, when a field of fact is sufficient for the purpose, they record the exertions of the industrious and enterprising with peculiar premiums or honorary medals, many important experiments and useful discoveries will be made, from which the public may reap the highest advantages.

Eminent instances of the beneficial effects of such institutions we have in the Bayl Academy of Sciences at Paris, the Royal Society, and the Society instituted for the Encouragement of Arts, Manufactures, and Commerce, in London, and many others of a similar kind. Herby a spirit of discovery and improvement has been excited among the ingenious in almost every nation; knowledge of various kinds, and greatly useful to mankind, has taken place of the dry and uninteresting speculations of scholasticism; and bold and erroneous hypotheses has been obliged to give way to demonstrative experiment. In short, the establishment of these Societies, said learning and philosophy have more increased than they had done for many centuries before.

As to those Societies established for promoting industry, religion and morality, and relieving distress, the design is humane and excellent, and presents a beautiful picture of the philanthropy of modern times. We are every day finding, from the minutes of some of these Societies, that their beneficial effects are already considerable.

We will now give some account of the most eminent Societies arranged here under the three classes into which we have divided them: I. *Religious and Humanitarian Societies.* II. *Societies for Promoting Science and Literature.* III. *Societies for Encouraging Arts, Manufactures, &c.*

I. RELIGIOUS AND HUMANITARIAN SOCIETIES.

1. *Society for the Propagation of the Gospel in Foreign Parts*, was instituted by King William III. in 1701, in order to secure a number of the evangelists, clergy, &c. and to make other provision for propagating the

gospel in the plantations, colonies, and foreign parts beyond the seas. To that end he incorporated the archbishops, several of the bishops, and others of the nobility, gentry, and clergy, into the number of it, into a society, which, by the name of *The Society for the Propagation of the Gospel in Foreign Parts*, was to plead and to impetrate; to have perpetual succession, with privilege to purchase real and personal hereditance, and estates for lives or years, with other goods and chattels to any value. The charter and duty is authorized to give a commission, and to meet annually on the third Friday in February, for the purpose of choosing a president, vice-president, and clerks for the year ensuing; and on the third Friday in every month, or oftener if there shall be occasion, to transact business, and to debate persons to take subscriptions, and collect money contributed for the purposes aforesaid; and of all moneys received and laid out, it is obliged to give account yearly to the lords-warden or keeper, the two Justices of the King's Bench, the Lord-Justices of the Common-Pleas, or to any two of their magistrates. On this Society there is a standing committee at St Paul's church-house, to prepare matters for the monthly meeting, which is held at St Martin's Parsonage.

Before the incorporation of the Society for the propagation of the gospel in foreign parts, there had been formed, for the promotion of Christian knowledge both at home and in the colonies, a voluntary association of persons of rank and respectability, who in March 1699 began to hold stated meetings in London for that purpose, regulating themselves by the laws of the Land and the canons of the church; and when the new Society was formed, they had already transmitted to America and the West Indies Sermons, worth of Bibles, Books of Common Prayer, and treatises of a pious and religious nature, besides securing a tolerable number to several foreign clergymen on that continent. This association fell in 1718 under the domination of *The Society for Propagating Christian Knowledge*, and has been productive of much good in the cities of London and Westminster; but upon the formation of the new Society, into which all its original members were incorporated by name, the care which the voluntary association had taken of the societies devolved of course upon the incorporated Society; of which incorporation we believe the object has been sometimes mistaken, and the Libours of its millionaires grossly misrepresented. It has by many been supposed that the Society was incorporated for the sole purpose of converting the savage Americans; and it has been much blamed for sending missionaries into provinces where, in the common language of the company, a *gospel-ministry* was already established. But an impartial view of the kind and projects of the American provinces, now become independent States, will show the folly and injustice of these suppositions.

The first Societies in North America were in the provinces of New and New England by religious men; who, as it is said, were invited by their Indian brethren, in the year 1630, to visit in person the first and chief of the Indians, *Massachussetts*, *for the purpose of God according to the Christian religion*. At the same time there were divine ministers of the Episcopal church; at another, Congregations were far away by the presbytery, but as the resolutions of these three the civil power into the hands of the one or the other party; and not a few

See his
Sermon,
vol. 1. of
his Works,
410.

members of the CHURCH OF ROME were chased to the wilds of America by the united exertions of both. It has been often observed, that people persecuted for their religion become for the most part enthusiastically attached to it; and the conduct of those colonists was in perfect harmony with this observation. Their zeal, inflamed by their violent removal to the other hemisphere, kept religion alive and active among themselves; but their poverty disabled them from supplying fuel to the flame, by making provision for a ministry to instruct their off-spring. The consequence was, that the new Christian commonwealth, without the kindly assistance of its mother-country, would have been, in the words of the Roman historian, *Res unius atatis*. Against this danger a timely aid was to be provided by the society; which, as it consisted not of fanatical members, would not intrust the important business of the mission to financial preachers, who, though always ready for such spiritual enterprises, are never qualified to carry them on with success.

It was therefore thought fit to assign a decent maintenance for clergymen of the church of England, who might preach the gospel to their brethren in America: and though those missionaries in general carefully avoided the conduct of those of Rome, whose principal aim is to reduce all churches under submission to the papal tyranny; yet so lately as 1765, did some of the colonies, in which the puritanic spirit of the last century characterized the church established by law, raise a hideous outcry against the society for sending a mission into their quarters, though only for the service of the dispersed members of the Episcopal church residing among them, and for the conversion of those men whom their rigid fanaticism had prejudiced against Christianity itself.

Indeed the commodity called FREETHINKING, as Bishop Warburton exclaims it, was at an early period imported by the opulent and fashionable colonists. The celebrated Berkeley, who had resided some years in Rhode Island, and at his return was called upon to preach the anniversary sermon before the society, informs us, that the island where he lived was inhabited by an English colony, consisting chiefly of sectaries of many different denominations; that several of the better sort of the inhabitants of towns were accustomed to assemble themselves regularly on the Lord's day for the performance of divine worship; but that most of those who were dispersed through the colony rivalled some well-bred people of other countries, in a thorough indifference for all that is sacred, being equally careless of outward worship and of inward principles. He adds, that the missionaries had done, and were continuing to do, good service in bringing those planters to a serious sense of religion. "I speak it knowingly (says he), that the ministers of the gospel, in those provinces which go by the name of New England, sent and supported at the expence of the society, have, by their sobriety of manners, discreet behaviour, and a competent degree of useful knowledge, shewn themselves worthy of the choice of those who sent them." We have the honour to be acquainted with some of the missionaries sent at a later period, and have reason to believe that, down to the era of the American revolution, they had the same virtues, and were doing the same good services, which procured to their predecessors this honourable testimony

from one of the greatest and the best of men. Surely such a mission deserved not to be evil spoken of by sectarists of any denomination who believe in Christ; especially as the very charter of incorporation assigns as a reason for missionaries being sent to the colonies, "that by reason of their poverty those colonies were destitute and unprovided of a MAINTENANCE for ministers and the public worship of God."

The society, however, was incorporated for other purposes than this. It was obliged by its charter to attempt the conversion of the native Americans and the negro slaves; and we have reason to believe, that, as soon as the spiritual wants of the colonists were decently supplied, it was not inattentive to these glorious objects. Its success indeed in either pursuit has not been so great as could be wished; but it would be rash and unfair to attribute this failure to the president, vice-president, or other officers of the corporation at home. An erroneous notion, that the being baptized is inconsistent with a state of slavery, rendered the selfish colonists for a long time averse from the conversion of their negroes, and made them throw every obstacle in the way of all who made the attempt; while the difficulties of the Indian mission are such as hardly any clergyman educated in a Protestant country can be supposed able to surmount.

He who hopes successfully to preach the gospel among a tribe of savage wanderers, must have an ardent zeal and unwearied diligence; appetites subdued to all the distresses of want; and a mind superior to all the terrors of mortality. These qualities and habits may be acquired in the church of Rome by him who from infancy has been trained up in the severities of some of the monastic orders, and afterwards sent to the college *de propaganda fide* to be instructed in the languages, and inured to the manners and customs, of the barbarous nations whose conversion he is destined to attempt. But in the reformed churches of Britain there are no monastic orders, nor any college *de propaganda fide*; and yet without the regular preparation, which is to be looked for in such institutions alone, it is not in nature, whatever grace may effect, for any man cheerfully, and at the same time soberly, to undergo all the accumulated distresses ever ready to overtake a faithful missionary among savage idolaters. A fanatic zeal will indeed undertake it, though he is totally unqualified for every sober and important work; and a man of ruined fortunes may be pressed into the service, though the impotency of his mind has shewn him unable to bear either poverty or riches. The failure of the society therefore in its attempts to convert the American Indians may be attributed, we think, in the first instance, to the want of a college *de propaganda fide* for training up young men for the American mission.

Perhaps another cause of this failure may be found in the conduct of the missionaries, who, it is to be presumed, have not always employed in a proper manner even the scanty qualifications which they actually possessed. The gospel, plain and simple as it is, and fitted in its nature for what it was ordained to effect, cannot be apprehended but by an intellect somewhat raised above that of a savage. Such of the missionaries therefore as began their work with *preaching to savages and brutal men*, certainly set out at the wrong end; for to make the gospel understood, and much more to propa-

Religious
and Hu-
manic Do-
ctrines.

Religion
and His-
tory So-
cieties

gate and establish it; these savages should have been first taught the necessary arts of civil life, which, while they improve every bodily accommodation, tend at the same time to enlarge and enlighten the understanding. For want of this previous culture, we doubt not, it hath happened that such of the savages as have been civilized into the faith have so seldom persevered themselves, or been able in any degree to propagate among their tribes the Christianity which they had been taught, and that successive millions have always found it necessary to begin anew the work of conversion.

To one or other of these causes, or to both, may justly be attributed the little progress which reformed Christianity has made among the Indians of North America; and not to any want of zeal, attention, or liberality, in the directors of the society at home. During the dependence of the United States on the mother-country, great part of the society's funds was properly expended in keeping alive a just sense of religion among the Christian colonists from Europe, who had surely the first claims upon this sort of charities; but now that America has separated herself from Great Britain, and shown that she is able to maintain her independence, and to make ample provision for a regular clergy of her own, the members of the corporation must feel themselves at liberty to bestow greater attention, and to expend more money than they could formerly do, on the conversion of such Indians as have any intercourse with the settlements which we still possess. To a body so respectable, we presume not to offer advice; but we cannot help thinking, with Bishop Berkeley, that the most successful missions would be children of Indians, educated in a considerable number together from the age of ten or twelve in a college *de propaganda fide*, where they should be in no danger of losing their mother-tongue while they were acquiring a competent knowledge of religion, morality, history, practical mathematics, and agriculture. "If there were a yearly supply (says he) of a dozen such missionaries sent abroad into their respective countries, after they had received the degree of master of arts, and been admitted into holy orders, it is hardly to be doubted but that in a little time the world would see good and great effects of their mission."

2 *Society in Scotland for Propagating Christian Knowledge*, was instituted in the beginning of the eighteenth century. At that period the condition of the Scotch Highlanders was truly deplorable. Shut up in desolate islands by tempestuous seas, or dispersed over a wide extent of country, intersected by high mountains, rapid rivers, and arms of the sea, without bridges or highways, by which any communication could be kept open either with remote or neighbouring districts, they lived in small detached companies in hamlets or solitary huts. Being thus secluded from intercourse with the more civilized part of the island, they could not enjoy the advantages of trade and manufactures. As their soil was barren and their climate severe, in agriculture no pro-

gress was to be expected: and as they were acquainted with no language but Gaelic, in which no books were then written, to possess knowledge was impossible. Their parishes being of great extent, often 30 or 40 miles long and of a proportionable breadth, and sometimes consisting of several islands separated by seas, which are often impassable, a considerable number of the inhabitants was entirely deprived of religious instruction or fell a prey to Popish emissaries. A single school in such extensive parishes could be of little benefit; yet many parishes were entirely destitute even of this resource; and where schools were established, the want of books prevented them from producing the useful effects otherwise to have been expected from them (A). To all this we must add, that they lived in a state of the greatest oppression: For though the Highlands formed a part of the British empire, the blessings of the British constitution had not reached them. The feudal system reigned in its utmost rigour; the chieftains exercising the most despotic sway over the inferior Highlanders, whom at their pleasure they deprived of their lives or property (B).

Thus the Highlanders were ignorant, oppressed, and uncivilized; slaves rather than subjects; and either entirely destitute of the advantages of the Christian religion, or unqualified to improve them. Hitherto they had been unhappy and useless to themselves and dangerous to the state; for they were ready at the call of their chieftains to issue from their mountains, and to turn their arms against their lawful king and his loyal subjects. This character, however, arose from their situation. It was therefore impossible for benevolent minds to contemplate this unhappy situation of their countrymen without feeling a desire to raise them to the dignity of rational beings, and to render them useful as citizens.

Accordingly, in the year 1721, some private gentlemen of the city of Edinburgh, who had formed themselves into a society for the reformation of manners, directed their attention to the Highlands of Scotland, and endeavoured to devise some plan for alleviating the distresses of the inhabitants. The remedy which promised to be most efficacious was, to establish charity schools in different places. But as the exigency was great, it was no easy matter to raise a sufficient fund for this purpose. They began therefore with what voluntary subscriptions they could procure, hoping afterwards to increase their capital by vacant stipends and public contributions. A memorial with this view was presented to the General Assembly in 1723, which received their approbation; and they accordingly passed an act, recommending a general contribution. In 1726 the General Assembly appointed some of their number to inquire more carefully into the state of the Highlands, and the year following appointed a select committee to confer with the gentlemen who had suggested the plan. The result of these conferences was the publication of proposals "for propagating Christian know-

Religion
and His-
tory So-
cieties

(A) Even so late as the year 1778, not fewer than 175 parishes, within the bounds of 39 presbyteries, had no parochial school. We are sorry to add, that even in the present enlightened and benevolent age the complaint is not entirely removed.

(B) The feudal system was at length abolished in the year 1748 by the jurisdiction act.

Proposals
for the bet-
ter supply-
ing of
Churches
in our Fe-
reign Plan-
tations,
&c.

ledge in the Highlands and Islands of Scotland, and in foreign parts of the world." Copies of the proposals, with description papers, were distributed through the kingdom; and the contributions having been amounting to 1222*l.* her majesty Queen Anne created this useful society by her royal proclamation, and at the same time limited letters patent under the great seal of Scotland for exciting certain of the functioners into a corporation: the first nomination of whom was lodged with the lords of council and session.

This corporation held its first meeting on Thursday 31 November 1729. It was attended by several of the nobility, fourteen of the lords of session, many gentlemen of rank, together with most of the ministers of the city of Edinburgh and neighbourhood. A president, secretary, and treasurer, with a committee of fifteen directors, were appointed for the dispatch of business. At their second meeting in January 1732, a scheme of management was formed and approved, in which it was proposed, 1. To erect and maintain schools in each parish of Scotland, particularly in the Highlands and Islands, as should be found to need them most; in which schools all profits whatsoever should be taught by fit and well qualified schoolmasters, appointed by the society, to read the Holy Scriptures and other pious books as well to write, and to understand the common rules of arithmetic, with such other things as should be thought suitable to their circumstances. 2. That the schoolmasters should be particularly careful to instruct their scholars in the principles of the Christian reformed religion; and for that end should be obliged to catechise them at least twice a week, and to pray publicly with them twice a day. 3. That not only such as were unable to pray should be taught gratis, but that those whose circumstances required it, should have such farther encouragement as the society should think fit in a considerable way with their patent. 4. To name some prudent persons, ministers and others, to be overseers of those schools, who should take care that the schoolmasters do their duty, and that the instructions to be given from time to time by the society or their committee be punctually observed; which overseers should make their report to the society quarterly or half yearly at furthest. 5. To give suitable encouragement to such ministers or catechists as should be willing to contribute their assistance towards the farther instruction of the scholars remote from church, by not only catechising, but preaching to them; which ministers or catechists should take the same care of the other inhabitants as of the scholars. 6. To extend their endeavors for the advancement of the Christian religion to heathen nations; and for that end to give encouragement to ministers to preach the gospel among them.

Having then formed a plan, they immediately proceeded to erect high schools in the most useful and economical manner; and as the capital continued to accumulate, the interest was faithfully applied, and the utility of the institution was more extensively diffused.

Until the year 1738 the attention of the society had been wholly directed to the establishment of schools; but their capital being then considerably augmented, they began to extend their views of utility much farther. The grand object of all public associations ought cer-

tainly to be the promoting of religion and morality. It must, however, be evident to every man of reflection, that these cannot but be propagated more profusely among a people without agriculture, unaccustomed to commerce and manufactures, and consequently without labour or exertion. Languor and debility of mind must always be the companions of idleness. While the Highlanders roved about with arms in their hands, the latent vigour of their minds must often have been called forth into action; but when their arms were taken away, and themselves confined to a domestic life, where there was nothing to rouse their minds, they must have sunk into indolence and inactivity. All attempts therefore to instruct them in religion and morality, without introducing among them some of the necessary arts of life, would probably have been unavailing. The society accordingly resolved to adopt what appeared to them the most effectual methods of introducing industry among the Highlanders. But as their patent did not extend far enough, they applied to his majesty George II. for an enlargement of their powers; and accordingly obtained a second patent, by which they are empowered, " besides fulfilling the purposes of their original patent, to cause such of the children as they shall think fit to be bred to husbandry and housewifery, to trades and manufactures, or in such manual occupations as the society shall think proper."

The objects of this second patent the society have not failed to pursue; and though many obstacles and discouragements to their efforts occurred among a rude and barbarous people, yet their perseverance, and the obvious utility of their plans, at length so far overcame the reluctance of the inhabitants, that not fewer than 93 schools of industry in various parts of the Highlands and Islands are now upon their establishment, at which are educated 2360 scholars.

The society, while anxiously endeavouring to diffuse a spirit of industry through the Highlands, were still equally solicitous to promote the knowledge of the Christian religion. As the English language had been the only channel by which knowledge was conveyed to them (a language which, being not used in conversation, was in all respects foreign to them), it was judged requisite that they should have the Scriptures in their vernacular tongue. The society therefore first appointed a translation of the New Testament to be made into Gaelic: A translation was accordingly undertaken by the Rev. Mr Stewart minister of Killin in Perthshire, and printed in 1767, which is said to be executed with much fidelity. Of this work many thousand copies have been distributed in the Highlands. The greater part of the Old Testament has also been translated by the Rev. Dr Smith of Campbellton and others, but chiefly by the Rev. Dr Stewart of Luik, by the appointment and at the expense of the society: and as soon as the remaining part can be got ready, the whole will be sold at so low a price as the poor may without difficulty afford. This plan the society have judiciously chosen, in order to prevent discontent and murmuring; effects which the diffusion of the Scriptures ought never to produce; but which could not possibly have been prevented, had the distribution been gratuitous, and of course good.

For some years past the funds of the society have rapidly

Religious
and His-
tory Soc.
1817-18

privately accumulated, from the very liberal donations of several individuals.

Lady Glenorchy	-	L. 5,000
By a person unknown	-	10,000
Lord Van Vryhoaven of Holland	-	20,000
Miss Gray of Tealies	-	3,500

In consequence of these great additions to their Stock, infractions have been thrown out that the Society have become too wealthy as to be at a loss for proper objects on which to bestow their increased revenue. It is an opinion by *far* entertained by any one, we must beg him to remember, that the Society have erected and endowed not fewer than 323 schools for religion, the first principles of literature and industry, at the annual expence of 3214. 10s. sterling; and that at these seminaries are educated from 14,000 to 15,000 children; who, but for the means of instruction thus obtained, would in all probability be bred up in ignorance and idleness: That they employ 12 missionary ministers and catechists in remote parts of the Highlands and Islands, or among the ignorant Highlanders settled in the great towns of Scotland, at the annual expence of 2000: That they bestow a bursary or pension of 150. per annum on each of six students of divinity having the Gaelic language: That they employ 600 missionary ministers and one schoolmaster among the Onondia and Stockbridge Indians of North America (being the destination of certain legacies bequeathed to them for that purpose), at the annual expence of 1450. Such is their fixed scheme of annual expence, amounting in all to 3714. 10s. sterling—a sum it will be acknowledged of very considerable magnitude. The whole of their incidental expences arising from the Gaelic translation of the Scriptures of the Old Testament; from annuities which they have to pay, in consequence of sums left them as residuary legacies; from land and house taxes; from enabling candidates for the office of schoolmaster to come to Edinburgh for examination; from sending books to poor scholars in their various schools; and from removing scholars from one station to another, is generally about 8750. which added to the former sum makes the whole annual expence amount to 4589. 10s.

If it be inquired at what expence, in the *management* of it, this extensive and complicated charity is actually conducted, we are authorized to say, that the treasurer, bookholder, and clerk, are allowed each 250. per annum; the same 250s. which were annexed to these offices from the commencement of the Society. The head or officer is allowed 120. per annum. No salary whatever is enjoyed by any of the other officers of the Society. The secretary, comptroller, an assistant, and librarian, although subjected, some of them espe-

cially, to a small expence of time and labour, have no pecuniary recompense or emolument. Their sole labours are for which they seek, and expect no other reward than the confidence of an endeavouring to promote the best interests of mankind. The whole amount of the expence of managing the business of the Society, including the above salaries, and costs, candles, stationery, water, postage, and other incident, exceeds not at an average 1150. per annum. From this Statement it appears, that hitherto at least the directors have been at no loss for important objects within the proper sphere of their Institution on which to bestow their increased funds. They have, it is true, the disposal of very considerable sums for promoting the objects of the Institution; but they are far from accumulating wealth, that every year their expensiture, notwithstanding the late increase of their capital, exceeds rather than falls short of their income. They have depended upon a kind Providence and a generous public to refund their anticipations of their revenue, and hitherto they have never been disappointed.

This has the Society for Promoting Christian Knowledge proceeded for almost a century. It was founded by the pious exertions of a few private individuals, whose names are unknown to the world; and its funds, by faithful and judicious management, as well as by generous contributions, have now become so extensive, as to excite the hope that they will be productive of the most valuable effects. The charity arising from public charity, it is well known, depend entirely upon the true aims of their directors. If, by the advantages which have accrued from this Society in due to the public mind, and the nation. While eager to increase the number of schools, the Society have not been inattentive to their prosperity. In the year 1771 Mr Lewis Drummond, a gentleman in whom they placed great confidence, was commissioned by them to visit their Schools, and to make an exact report of their state and circumstances. Again, in the year 1790, a commission was granted to the Rev. Dr Kemp, one of the ministers of Edinburgh and Secretary to the Society, to visit all the Schools on their establishment. His labours and great toils took he accomplished in the course of four firmers with much ability and care, and happily to the satisfaction of the Society. At his return he communicated a variety of important information respecting the state of the Highlands and Islands, and the means necessary for their improvement in religion, literature, and industry; an abridgement of which was published by the Society in a pamphlet to the anniversary terms preached before them in the years 1789, 90, 91, and 92 (c).

The following table will exhibit at a glance the funds, establishments, and expensiture of the Society, from a few years after its commencement to the present time.

Where

(c) It is well known, that the number of Roman Catholics in the Highlands is considerable; but it must give much pleasure to the Protestant reader to be informed, that the most eminent spirit of Popery has in that distant place no place to hold an establishment. This is chiefly owing to the zealous and vigilant ministry of the presbytery in that quarter, where it is well supported by the Rev. Mr. Mackenzie. So far from being hostile to the views of the Society, he is warmly disposed to promote them. They accordingly received the following testimonial from his Grace the Duke of Argyll, in the year 1780, to be published in a pamphlet, the title of which is, *That the Roman Catholics in their own country, and especially in the Highlands, are not in the least prejudiced against the religion in which they themselves are engaged. What a kind of religion that*

Religious
and His-
tory Soc.
1817-18

Religious
and Hu-
mane So-
cieties.

Where the number of scholars is not mentioned, the defect may be supplied by taking an average from those years where a computation has been made. Where the capital is not mentioned, it may easily be made out by considering the salaries as the interest.

A. D.	Capital.	Schools.	Scholars.
1713		12	
1715	L. 6,177	25	
1710	8,168	48	
1727	9,131	78	2757
1732	13,348	109	
1742	19,287	128	
1753	24,378	152	
1758	28,413	176	6409
1781	34,000	180	7000
	Salaries		
1793	3,080	307	12,913
1794	3,214	323	14,370

Hitherto we have taken no notice of the corresponding board which was established at London so early as the year 1729, to receive subscriptions and lay out sums. That board indeed remained long inactive; but in 1773 its members began to co-operate more cordially with their brethren in Scotland. Since that period an annual sermon has been preached in recommendation of the charity; and the preacher is now selected without any regard to the religious denomination to which he belongs; sometimes from the church of England, sometimes from the church of Scotland, and sometimes from sectaries of dissent persuasions. The meetings of the corresponding board have been attended by many of the nobility and gentry, who have made great exertions to promote the views of the society. From its present flourishing state therefore, from the indefatigable exertion and laudable zeal of the managers, and from the countenance and support which they have received from persons of the first rank and respectability in the nation, the benevolent mind may look forward with much confidence and satisfaction to a period not very distant, when its beneficial effects shall be felt not only in the Highlands, but shall be communicated to the rest of the nation. We have been thus particular in our account of the Society for Propagating Christian Knowledge, because we have had access to the most authentic sources of information, and because we know it to be an institution calculated to enlighten and improve a considerable part of the British nation.

3. *Society of the Sons of the Clergy*, was incorporated by King Charles II. in 1678, by the name of *The Governors of the Charity for Relief of the Poor Widows and Children of Clergymen*. This society is under the direction and management of a president and vice president, three treasurers, and a court of assistants composed of forty members. Several hundreds of widows and children of the clergy have annually received considerable relief from this useful charity.

4. *Society for the Sons of the Clergy of the Established Church of Scotland*, was instituted at Edinburgh in February 1792, and was constituted a body corporate by his majesty's royal charter in 1792. The society, after several meetings, are of opinion, that the period in which the families of clergymen feel most urgently the need both of spiritual and pecuniary aid, is that which com-

mences with the introduction of the sons either to an university or to business, and terminates with their establishment in their respective professions; that many of the ministers of this church, living at great distances from the seats either of universities or of business, possess incomes which, in the present state of the country, are inadequate to the purposes of procuring for their sons either the literary or professional education which might enable them to come forward with credit and success in the world; that the sons of clergymen, from domestic tuition and example, have in general very advantageous means of receiving in their early years the impressions of virtue and honour, together with the rudiments of liberal knowledge; and that of course the public interest may be promoted, by enabling this class of young men to obtain their share in the respectable situations of life. The views of the society have been limited to the sons only of clergymen; as they are of opinion, that within the limits which they have fixed, the field of beneficence will be still very extensive, and the claims for aid as many and as great as their funds can be supposed able to answer, at least for many years to come. If the society shall ever be in a situation to undertake more than the aids which will be necessary in bringing forward the sons of the clergy, it may then be considered in what manner the daughters also may become sharers in its bounty.

A society of the same nature, and having the same objects in view, was instituted at Glasgow we think the year before; and both societies, we know, have in many cases proved highly beneficial in promoting the views for which they were instituted.

5. *Royal Humane Society*, was instituted in London in 1774, for the recovery of persons drowned or otherwise suffocated. We have already given some account of societies instituted in other countries with the same views, and have also copied the directions of this society for the recovery of life, for which see the article DROWNING. We have therefore only to state, that the plan of this society is to avert to any private interested views, that it acquits its founders of all sordid motives. For the medical practitioners, accept no pecuniary recompense for the time which they devote to a difficult and tedious process; for the anxiety which they feel while the event is doubtful; for the mortification which they too often undergo, when death, in spite of all their efforts, at last carries off his prey; nor for the insults to which they willingly expose themselves from vulgar incredulity. Their sole reward is in the Holy joy of doing good. Of an institution thus free in its origin from the suspicion of ambitious views, and in its plan renouncing self interest in every shape, philanthropy must be the only basis. The good intention therefore of the society is proved by its constitution; the wisdom and utility of the undertaking are proved by its success; not fewer than 3000 fellow-creatures having since its commencement been (1794) restored to the community by its timely and indefatigable exertions. For it is to be observed, that the benefit of this society is by no means confined to the two cases of drowning and suffocation. Its timely succours have roused the lethargy of opium taken in immoderate and repeated doses; they have rescued the wretched victims of intoxication; rekindled the life extinguished by the sudden stroke of lightning; recovered the apoplectic; restored life to the infant that had lost it in the birth; they have proved efficacious

Religious
and Hu-
mane So-
cieties.

Religious
and Hu-
man-
itarian
Societies.

efficacious in cafes of accidental smothering and of suffocation by noxious damps; in instances in which the tenderness of the infant body or the debility of old age greatly lessened the previous probability of success; inasmuch that no species of death seems to be placed beyond the reach of this society's assistance, where the mischief had gone no farther than an obstruction of the movements of the animal machine without any damage of the organs themselves. In consequence of every necessary assistance afforded by this society, similar institutions have been established at Algiers, Lisbon, Philadelphia, Boston, Jamaica, Dublin, Leith, Glasgow, Paisley, Aberdeen, Birmingham, Gloucester, Shropshire, Northamptonshire, Lancaster, Bristol, Whitehaven, Norwich, Exeter, Kent, and Newcastle. The society has published an 8vo volume with plates, consisting of cafes, correspondence, and a variety of interesting matter relating to the object of this benevolent institution.

6. *The Philanthropic Society*, was instituted in September 1788. It aims at the prevention of crimes, by removing out of the way of evil counsel, and evil company, those children who are, in the present state of things, destined to ruin. It proposes to educate and instruct in some useful trade or occupation the children of convicts or other infant poor who are engaged in vagrant or criminal courses; thus to break the chain of those pernicious confederacies, deprive the wicked of successors, the goals of inhabitants, justice of its victims, and by all these means add citizens to society. This institution is not only calculated to decrease vice and infamy, but to increase useful industry; so that those children who would otherwise succeed to their parents hereditary crimes, and become the next race of beggars and thieves, will now be taught to supply by honest means their own wants and the wants of others.

To carry into effect these desirable purposes, it is the first business of the society to select from prisons, and from the haunts of vice, profligacy, and beggary, such objects as appear most likely to become obnoxious to the laws, or prejudicial to the community; and, in the execution of this duty, the assistance of the magistrates, the clergy, and all who are interested in the promotion of good morals and good government, is most earnestly requested. For the employment of the children, several houses are supported, at Cambridge Heath, near Hackney, in each of which a master-workman is placed for the purpose of teaching the children some useful trade. The trades already established are those of a printer, carpenter, shoemaker, and taylor. The girls are at present educated as menial servants.

In the year 1791 not fewer than 70 children were under the protection of this society, among whom were many who have been guilty of various felonies, burglaries, and other crimes. Yet, singular as it may appear, in less than two years those very children became no less remarkable for industry, activity, decency, and obedience, than they formerly were for the contrary vices. Such are the grounds on which the Philanthropic Society now claims the attention and solicits the patronage of the public. If we regard humanity and religion, this institution opens an asylum to the most forlorn and object of the human race; it befriends the most friendless; it saves from the certain and fatal consequences of infamy and vicious courses orphans and deserted children. If we regard national prosperity and the public

welfare, it is calculated to increase industry; and it directs that industry into the most useful and necessary channels. If we regard self-interest, its immediate object is to protect our persons from assault and murder, our property from depredation, and our peaceful habitations from the desperate fury of midnight incendiaries.

One guinea per annum constitutes a member of the society; and 12s. at one payment a member for life. A life-subscription, or an annual payment of at least two guineas, is a necessary qualification for being elected into the committee.

II. SOCIETIES FOR PROMOTING SCIENCE AND LITERATURE.

1. *The Royal Society of London* is an academy or body of persons of eminent learning, instituted by Charles II. for the promoting of natural knowledge. The origin of this society is traced by Dr Sprat, its earliest historian, no farther back than to "some space after the end of the civil wars" in the 17th century. The scene of the first meetings of the learned men who laid the foundation of it, is by him fixed in the university of Oxford at the lodgings of Dr Wilkins warden of Wadham college. But Dr Birch, on the authority of Dr Wallis, one of its earliest and most considerable members, assigns it an earlier origin. According to him, certain worthy persons, residing in London about the year 1645, being "inquisitive into natural and the new and experimental philosophy, agreed to meet weekly on a certain day, to discourse upon such subjects, and were known by the title of *The Invisible or Philosophical College*." In the years 1648 and 1649, the company who formed these meetings was divided, part retiring to Oxford and part remaining in London; but they continued the same pursuits as when united, corresponding with each other, and giving a mutual account of their respective discoveries. About the year 1659 the greater part of the Oxford society returned to London, and again uniting with their fellow-labourers, met once, if not twice, a-week at Gresham college, during term time, till they were scattered by the public distractions of that year, and the place of their meeting made a quarter for soldiers. On the restoration 1660 their meetings were revived, and attended by a greater concourse of men eminent for their rank and learning. They were at last taken notice of by the king, who having himself a considerable taste for physical science, was pleased to grant them an ample charter, dated the 15th of July 1662, and afterwards a second dated 15th April 1673, by which they were erected into a corporation, consisting of a president, council, and fellows, for promoting natural knowledge; and to give their investigations, against which strange prejudices were entertained, every possible support, he sometimes honoured their meetings with his presence.

Their manner of electing fellows is by balloting. Their council are in number 21, including the president, vice-president, treasurer, and two secretaries; 11 of which are continued for the next year, and 10 more added to them; all chosen on St Andrew's day. Each member at his admission subscribes an engagement that he will endeavour to promote the good of the society, from which he may be freed at any time, by signifying to the president that he desires to withdraw. The charges have been different at different times, and were

...at first irregularly paid; but they are now five guineas paid to the treasurer at admission, and 13s. per quarter so long as the person continues a member; or, in lieu of the annual subscription, a composition of 25 guineas in one payment.

Their design is, to "make faithful records of all the works of nature or art which come within their reach; so that the present as well as future ages may be enabled to put a mark on errors which have been strengthened by long prescription; to restore truths that have been neglected; to push those already known to more various uses; and to make the way more passable to what remains unrevealed," &c. To this purpose they have made a great number of experiments and observations on most of the works of nature; and also numbers of short histories of nature, arts, manufactures, useful engines, contrivances, &c. The services which they have rendered to the public are very great. They have improved naval, civil, and military architecture; advanced the security and perfection of navigation; improved agriculture; and put not only this kingdom, but also Ireland, the plantations, &c. upon planting. They have registered experiments, histories, relations, observations, &c. and reduced them into one common stock; and have, from time to time, published those which they reckoned most useful, under the title of *Philosophical Transactions*, &c. and laid the rest up in public registers, to be nakedly transmitted to posterity, as a solid groundwork for future systems.

They have a library adapted to their institution; towards which Mr Henry Howard, afterwards duke of Norfolk, contributed the Norwichean library, and which is, at this time, greatly increased by a continual series of benefactions. The museum or repository of natural and artificial rarities, given them by Daniel Colwall, Esq. and since enriched by many others, is now removed to the British museum, and makes a part of that great repository. Their motto is *Nullius in verba*; and their place of assembling is Somerset-house in the Strand. Sir Godfrey Copley, baronet, left five guineas to be given annually to the person who should write the best paper in the year, under the head of experimental philosophy. This reward, which is now changed to a gold medal, is the highest honour the society can bestow. It is conferred on St Andrew's day.

2. *The Royal Society of Edinburgh*, was incorporated by royal charter on the 29th of March 1783, and has for its object the cultivation of every branch of science, erudition, and taste. Its rise and progress towards its present state was as follows: In the year 1718 a literary society was established in Edinburgh by the learned Ruddiman and others, which in 1731 was succeeded by a society instituted for the improvement of medical knowledge. In the year 1739 the celebrated Macbarrin conceived the idea of enlarging the plan of this society, by extending it to subjects of philology and literature. The institution was accordingly new-modelled by a printed set of laws and regulations, the number of members was increased, and they were distinguished from that time by the title of *The Society for Improving Arts and Sciences*, or more generally by the title of *The Philosophical Society of Edinburgh*. Its meetings, however, were soon interrupted by the disorders of the country during the rebellion in 1745; and they were not renewed till the year 1752. Soon after

this period the first volume of the *Transactions of the Philosophical Society of Edinburgh* was published, under the title of *Essays and Observations, Physical and Literary*, and was followed by other volumes of acknowledged merit. About the end of the year 1782, in a meeting of the professors of the university of Edinburgh, many of whom were likewise members of the Philosophical Society, and warmly attached to its interests, a scheme was proposed by the Rev. Dr Robertson, principal of the university, for the establishment of a new society on a more extended plan, and after the model of some of the foreign academies. It appeared an expedient measure to solicit the royal patronage to an institution of this nature, which promised to be of national importance, and to request an establishment by charter from the crown. The plan was approved and adopted; and the Philosophical Society, joining its influence as a body in seconding the application from the university, his majesty, as we have already observed, was most graciously pleased to incorporate *The Royal Society of Edinburgh* by charter.

This society consists of ordinary and honorary members; and the honorary places are restricted to persons residing out of Great Britain and Ireland. The election of new members is appointed to be made at two stated general meetings, which are to be held on the fourth Monday of January and the fourth Monday of June. A candidate for the place of an ordinary member must signify by a letter, addressed to one of the members, his wish to be received into the society. He must then be publicly proposed at least a month before the day of election. If the proposal be seconded by two of the members present, his name is to be inserted in the list of candidates, and hung up in the ordinary place of meeting. The election is made by ballot, and is determined in favour of a candidate, if he shall have the votes of two-thirds of those present, in a meeting consisting of at least 21 members. The general business of the society is managed by a president, two vice-presidents, with a council of 12, a general secretary, and a treasurer. These officers are chosen by ballot annually on the last Monday of November. All public deeds, whether of a civil or of a literary nature, are transacted by this board, and proceed in the name of the president or vice-president.

As it was thought that the members would have a greater inducement to punctual attendance on the meetings of the society, if they had some general intimation of the nature of the subjects which were to be considered, and made the topics of conversation, it was therefore resolved to divide the society into two classes, which should meet and deliberate separately. One of these classes is denominated the *Physical Class*, and has for its department the sciences of mathematics, natural philosophy, chemistry, medicine, natural history, and whatever relates to the improvement of arts and manufactures. The other is denominated the *Literary Class*, and has for its department literature, philology, history, antiquities, and speculative philosophy. Every member is desired at his admission to intimate which of those classes he wishes to be more particularly associated with; but he is at the same time intitled to attend the meetings of the other class, and to take part in all its proceedings. Each of the classes has four presidents and two secretaries, who officiate by turns. The meetings

Societies for
Promoting
Science and
Literature.

Societies for of the physical class are held on the first Mondays of
 Promoting January, February, March, April, July, August, N-
 Science and o- vember, and December; and the meetings of the Liter-
 Literature. ature class are held on the third Mondays of January,
 February, March, April, June, July, November, and
 December, at 7 o'clock afternoon.

At these meetings the written essays and observations of the members of the society, or their correspondents, are read publicly, and become the subjects of conversation. The subjects of these essays and observations are announced at a previous meeting, in order to engage the attendance of those members who may be particularly interested in them. The author of each dissertation is likewise desired to furnish the society with an abstract of it, to be read at the next ensuing meeting, when the conversation is renewed with increased advantage, from the knowledge previously acquired of the subject. At the same meetings are exhibited such specimens of natural or artificial curiosities, such remains of antiquity, and such experiments, as are thought worthy of the attention of the society. All objects of natural history presented to the society, are ordered by the charter of the institution to be deposited, on receipt, in the museum of the university of Edinburgh; and all remains of antiquity, public records, or ancient manuscripts, in the library belonging to the faculty of advocates at Edinburgh.

The ordinary members, whose usual residence is in the city of Edinburgh or its immediate neighbourhood, are expected to attend regularly the monthly meetings; and are required to defray, by an annual contribution, the current expences of the institution. The members who reside at such a distance from Edinburgh, that they cannot enjoy the advantages arising from a regular attendance on the meetings of the society, are not subjected to any contribution for defraying its expences, but have a right to attend those meetings when occasionally in Edinburgh, and to take part in all their proceedings.

Five volumes of the Transactions of the society have been published, which bear ample testimony to the learning and acuteness of their various authors.

3. *Medical Society* of London, instituted in the year 1752, on the plan recommended by Lord Bacon (*De Augm. Scient.* lib. iv. cap. 2.), to revive the Hippocratic method of composing narratives of particular cases, in which the nature of the disease, the manner of treating it, and the consequences, are to be specified; to attempt the cure of those diseases which, in his opinion, have been too boldly pronounced incurable; and, lastly, to extend their inquiries after the powers of particular medicines in the cure of particular cases; the collections of this society have been already published, under the title of *Medical Observations and Inquiries*, in several volumes.

4. *The Medical Society* of Edinburgh was incorporated by royal charter in 1778; but there appears to have been in that city a voluntary association of the same name from the first establishment of a regular school of physic in the university. To the voluntary society the public is indebted for six volumes of curious and useful essays, collected principally by the late Dr Monro from June 1731 to June 1736; but in the year 1739 that society was united to another, as we have already observed in a former article. The ordinary members

of the present medical society are elected by ballot, and three dissentients exclude a candidate; an ordinary member may also be elected an honorary member, who enjoys the privileges of the others, and receives a diploma, but is freed from the obligation of attendance, delivering papers in rotation, &c. to which the ordinary members are subject; but in this case the votes must be unanimous. The meetings of this society are held every Friday evening (formerly Saturday) in their own hall, during the winter season, when papers on medical subjects are delivered by the several members in rotation; and four of these are annually elected to fill the chair in rotation, with the title of annual presidents. This society possesses an excellent library of books on subjects connected with its pursuits.

5. *The Royal Medical Society* of Paris was instituted in 1776. The members are divided into associates ordinary, limited to 30, honorary to 12, extraordinary to 60, and foreign to 60, and correspondents. This society has published several volumes of *Memoirs* in 4to.

6. *Asiatic Society*, an institution planned by the late illustrious Sir William Jones, and actually formed at Calcutta on the 15th of January 1784, for the purpose of tracing the history, antiquities, arts, sciences, and literature, of the immense continent of Asia. As it was resolved to follow as nearly as possible the plan of the *ROYAL SOCIETY* of London, of which the king is *patron*, the patronage of the Asiatic Society was offered to the governor-general and council, as the executive power in the territories of the company. By their acceptance of this offer, Mr Hastings, as governor-general, appeared among the patrons of the new society; "but he seemed in his private station, as the first liberal promoter of useful knowledge in Bengal, and especially as the great encourager of Persian and Shanscrit literature, to deserve a particular mark of distinction;" he was requested, therefore, to accept the honorary title of president. This was handsomely declined in a letter from Mr Hastings, in which he requested "to yield his pretensions to the gentleman whose genius planned the institution, and was most capable of conducting it to the attainment of the great and splendid purposes of its formation." On the receipt of this letter, Sir William Jones was nominated president of the society; and we cannot give the reader a view of the object of the institution in clearer language than that which he employed in his first discourse for the chair.

"It is your design, I conceive (said the president), to take an ample space for your learned investigations, bounding them only by the geographical limits of Asia; so that, considering Hindostan as a centre, and turning your eyes in idea to the north, you have on your right many important kingdoms in the eastern peninsula, the ancient and wonderful empire of China with all her Tartarian dependencies, and that of Japan, with the cluster of precious islands, in which many singular curiosities have too long been concealed: before you lies that prodigious chain of mountains, which formerly perhaps were a barrier against the violence of the sea, and beyond them the very intertelling country of Tibet, and the vast regions of Tartary, from which, as from the Trojan horse of the poets, have issued so many consummate warriors, whose domain has extended at least from the banks of the Ilysius to the mouths of the Ganges: on your left are the beautiful and celebrated provinces

Societies for
Promoting
Science and
Literature.

of Iran or Persia, the unmeasured and perhaps unmeasurable deserts of Arabia, and the once flourishing kingdom of Yemen, with the pleasant isles that the Arabs have subdued or colonized; and farther westward, the Asiatic dominions of the Turkish sultans, whose moon seems approaching rapidly to its wane. By this great circumference the field of your useful researches will be inclosed; but since Egypt had unquestionably an old connection with this country, if not with China, since the language and literature of the Abyssinians bear a manifest affinity to those of Asia, since the Arabian arms prevailed along the African coast of the Mediterranean, and even erected a powerful dynasty on the continent of Europe, you may not be displeased occasionally to follow the streams of Asiatic learning a little beyond its natural boundary; and, if it be necessary or convenient that a short name or epithet be given to our society, in order to distinguish it in the world, that of *Asiatic* appears both classical and proper, whether we consider the place or the object of the institution, and preferable to *Oriental*, which is in truth a word merely relative, and though commonly used in Europe, conveys no very distinct idea.

"If now it be asked, What are the intended objects of our inquiries within these spacious limits? we answer, MAN and NATURE; whatever is performed by the one or produced by the other. Human knowledge has been elegantly analysed according to the three great faculties of the mind, *memory, reason, and imagination*, which we constantly find employed in arranging and retaining, comparing and distinguishing, combining and diversifying, the ideas, which we receive through our senses, or acquire by reflection: hence the three main branches of learning are, *history, science, and art*; the first comprehends either an account of natural productions, or the genuine records of empires and states, the second embraces the whole circle of pure and mixed mathematics, together with ethics and law, as far as they depend on the reasoning faculty; and the third includes all the beauties of imagery and the charms of invention, displayed in modulated language, or represented by colour, figure, or sound.

"Agreeably to this analysis, you will investigate whatever is rare in the stupendous fabric of nature, will correct the geography of Asia by new observations and discoveries; will trace the annals and even traditions of those nations who from time to time have peopled or desolated it; and will bring to light their various forms of government, with their institutions civil and religious; you will examine their improvements and methods in arithmetic and geometry; in trigonometry, mensuration, mechanics, optics, astronomy, and general physics; their systems of morality, grammar, rhetoric, and dialectic; their skill in chirography and medicine; and their advancement, whatever it may be, in anatomy and chemistry. To this you will add researches into their agriculture, manufactures, trade; and whilst you inquire with pleasure into their music, architecture, painting, and poetry, will not neglect those inferior arts by which the comforts and even elegancies of social life are supplied or improved. You may observe, that I have omitted their languages, the diversity and difficulty of which are a sad obstacle to the progress of useful knowledge; but I have ever considered languages as the mere instruments of real learning, and think them im-

properly confounded with learning itself: the attainment of them is, however, indispensably necessary; and if to the Persian, Armenian, Turkish, and Arabic, could be added not only the Shansic, the treasures of which we may now hope to see unlocked, but even the Chinese, Tartarian, Japanese, and the various insular dialects, an immense mine would then be open, in which we might labour with equal delight and advantage."

Of this society three volumes of the *Transactions* have been published, which are replete with information in a high degree curious and important; and we hope that the European world shall soon be favoured with another. The much-to-be-lamented death of the accomplished president may indeed damp the spirit of investigation among the members; for to conquer difficulties so great as they must meet with, a portion seems to be necessary of that enthusiasm which accompanied all the pursuits of Sir William Jones; but his successor is a man of great worth and learning, and we trust will use his utmost endeavours to have the plan completed of which Sir William gave the outlines.

5. *The American Philological Society*, held at Philadelphia, was formed in January 1769 by the union of two societies which had formerly subsisted in that city. This society extends its attention to geography, mathematics, natural philosophy, and astronomy; medicine and anatomy; natural history and chemistry; trade and commerce; mechanics and architecture; husbandry and American improvements. Its officers are a patron, president, three vice-presidents, one treasurer, four secretaries, and three curators, who are annually chosen by ballot. The duty of the president, vice-presidents, treasurer, and secretaries, is the same as in other societies. The business of the curators is to take the charge of all specimens of natural productions, whether of the animal, vegetable, or fossil kingdom; all models of machines and instruments; and all other matters belonging to the society which shall be intrusted to them. The ordinary meetings are held on the first and third Fridays of every month from October to May inclusive. This society was incorporated by charter 15th March 1780; and has published three volumes of its *Transactions*, containing many ingenious papers on general literature and the sciences, as well as respecting those subjects peculiar to America. It is a delightful prospect to the philosopher to consider, that Asia, Europe, and America, though far separated and divided into a variety of political states, are all three combined to promote the cause of knowledge and truth.

6. *A Literary and Philological Society* of considerable reputation has been lately established at Manchester, under the direction of two presidents, four vice-presidents, and two secretaries. The number of members is limited to 50; besides whom there are several honorary members, all of whom are elected by ballot; and the officers are chosen annually in April. Five volumes of valuable essays have been already published by this society.

A society on a similar plan has been established at Newcastle. It is composed of a number of most respectable members, and possesses a very valuable library and philosophical apparatus. Lectures on the different branches of natural philosophy have been delivered for several years at this institution.

7. *Society for Promoting the Discovery of the Interior Part.*

Societies for
Promoting
Science and
Literature.

Societies of Parts of Africa. This society or association for exploring the internal districts of Africa, of which so little is at present known, was formed in London by some opulent individuals in 1783; who, strongly impressed with a conviction of the practicability and utility of thus enlarging the fund of human knowledge, determined if possible to refine the age from that stigma which attaches to its ignorance of so large and to near a portion of the globe. The founders of this society resolved to admit no man a member for a shorter period than three years, during which he must pay annually into the public fund five guineas. After three years, any member, upon giving a year's notice, may withdraw himself from the association. During the first 12 months each of the members was allowed to recommend for the approbation of the society such of his friends as he might think proper to be admitted into it; but since that period we believe all additional members have been elected by a ballot of the association at large. A committee was chosen by ballot to manage the funds of the society, to choose proper persons to be sent on the discovery of the interior parts of Africa, and to carry on the society's correspondence, with express injunctions to disclose no intelligence received from their agents but to the society at large. But a fuller account of the nature of this establishment, and the very happy efforts they have made, may be seen in the superb edition of their proceedings printed in 1792, 4to, for their own use; or in the 8vo edition since made public. They soon found two gentlemen, Mr Lucas and Mr Ledyard, who were singularly well qualified for the important mission. The information they have acquired will be found in the above work; with a new map by Mr Rennel, exhibiting the geographical knowledge collected by the African association. Mr Ledyard very unfortunately died during his researches at Cairo.

Few of our readers are unacquainted with the travels of Mr Park under the patronage of the society. For an account of which see AFRICA. A second journey was undertaken by the same gentleman within these three years; but as he has not been heard of for a long time, the most serious apprehensions are entertained that he and his companions have fallen victims either to the inhospitable climate, or to the watchful jealousy of the Moors. Another enterprising traveller, Mr Horneman, was sent out by the society about 1800. He departed from Cairo with a caravan, and reached Mourzouk, a place situated south from Tripoli; and from thence sent a communication to his constituents which has since been published by the society. This is the last account that was received of this traveller, from which it is feared that he has also perished.

8. *The Society of Antiquaries of London*, was founded about the year 1572 by Archbishop Parker, a magnificent patron of learned men. For the space of 25 years it assembled in the house of Sir Robert Cotton; in 1599 they resolved to apply to Queen Elizabeth for a charter and a public building where they might hold their meetings; but it is uncertain whether any such application was ever made. In the mean time, the reputation of the society gradually increased, and at length it excited the jealousy of James I. who was afraid lest it should presume to canvass the secret transactions of his government. He accordingly dissolved it. But in the beginning of the last century, the Antiquarian Society began to re-

vive; and a number of gentlemen, eminent for their affection to this science, had weekly meetings, in which they examined the antiquities and history of Great Britain preceding the reign of James I. but without excluding any other remarkable antiquities that might be offered to them. From this time the society grew in importance; and in 1730 they unanimously resolved to petition the king for a charter of incorporation. This they obtained the year following, by the influence of the celebrated earl of Hardwicke, then lord-chancellor, and Martin Folkes, Esq; who was then their president. The king declared himself their founder and patron, and empowered them to have a body of statutes, and a common seal, and to hold in perpetuity lands, &c. to the yearly value of 1000*l*.

The chief object of the inquiries and researches of the society are British antiquities and history; not, however, wholly excluding those of other countries. It must be acknowledged, that the fruits of antiquity offers to the curious and inquisitive a large field for research and amusement. The inquirer in this branch furnishes the historian with his best materials, while he distinguishes from truth the actions of a bold invention, and ascertains the credibility of facts; and to the philosopher he presents a fruitful source of ingenious speculation, while he points out to him the way of thinking, and the manners of men, under all the varieties of aspect in which they have appeared.

An antiquarian ought to be a man of solid judgment, possessed of learning and science, that he may not be an enthusiastic admirer of every thing that is ancient merely because it is ancient; but be qualified to distinguish between those researches which are valuable and important, and those which are trifling and useless. It is from the want of these qualifications that some men have contracted such a blind passion for every thing that is ancient, that they have exposed themselves to ridicule, and their study to contempt. But if a regard to utility were always to regulate the pursuits of the antiquarian, the shafts of satire would no longer be levelled at him; but he would be respected as the man who labours to preserve or to retrieve such ancient productions as are suited to illuminate religion, philosophy, and history, or to improve the arts of life.

We by no means intend to apply these observations to any particular society of antiquarians; but we throw them out, because we know that an assiduous study of antiquity is apt, like the ardent pursuit of money, to lose sight of its original object, and to degenerate into a passion which mistakes the mean for the end, and considers possession without a regard to utility as enjoyment.

An association similar to that of the Antiquarian Society of London was founded in *Edinburgh* in 1780, and received the royal charter in 1783. A volume of the transactions of this society has been published; but with the exception of two or three memoirs, it contains little worthy of notice; and accordingly, it has never attracted the attention of the public.

Besides these literary societies here mentioned, there are a great number more in different parts of Europe, some of which are noticed under the article *Academy*. Those which are omitted here are omitted on account of the smallness of their objects, or their being less important than those which are mentioned here. But either be-

Societies for Encouraging and Promoting Arts, Manufactures, &c.

because we have had no access to authentic information, or because they resemble the societies already described so closely, that we could have given nothing but their names.

Societies for Encouraging and Promoting Arts, Manufactures, &c.

claim for a premium will be attended to, unless the conditions of the advertisement are fully complied with. No papers shall be opened but such as shall gain premiums, unless where it appears to the society absolutely necessary for the determination of the claim: all the rest shall be returned unopened, with the matters to which they belong, if inquired after by the marks within two years; after which time, if not demanded, they shall be publicly burnt unopened at some meeting of the society. All the premiums of this society are designed for that part of Great Britain called England, the dominion of Wales, and the town of Berwick upon Tweed, unless expressly mentioned to the contrary. No person shall receive any premium, bounty, or encouragement, from the society for any matter for which he has obtained or proposes to obtain a patent. No member of this society shall be a candidate for or intitled to receive any premium, bounty, or reward whatever, except the honorary medal of the society.

III. SOCIETIES FOR ENCOURAGING AND PROMOTING ARTS, MANUFACTURES, &c.

1. *London Society for the Encouragement of Arts, Manufactures, and Commerce*, was instituted in the year 1754 by Lord Folkestone, Lord Romney, Dr Stephen Hales, and a few private gentlemen; but the merit of this institution chiefly belonged to Mr William Striple, an ingenious mechanic; who, though deriving no advantages from learning, by unwearied personal attendance found means to engage a few persons of rank and fortune to meet at Pelee's coffeehouse in Fleet-street, and to adopt a plan for promoting arts and manufactures.

The office-bearers of this society are a president, 12 vice-presidents, a secretary, and register. Their proceedings are regulated by a body of rules and orders established by the whole society, and printed for the use of the members. All questions and debates are determined by the holding up of hands, or by ballot if required; and no matter can be confirmed without the assent of a majority at two meetings. They invite all the world to propose subjects for encouragement; and whatever is deemed deserving of attention is referred to the consideration of a committee, which, after due inquiry and deliberation, make their report to the whole society, where it is approved, rejected, or altered. A list is printed and published every year of the matters for which they propose to give premiums; which premiums are either sums of money, and those sometimes very considerable ones; or the society's medal in gold or silver, which they consider as the greatest honour they can bestow. All possible care is taken to prevent partiality in the distribution of their premiums, by desiring the claimants names to be concealed, and by appointing committees, (who when they find occasion call to their assistance the most skilful artists) for the strict examination of the real merit of all matters and things brought before them, in consequence of their premiums.

The chief objects of the attention of the Society for the Encouragement of Arts, Manufactures, and Commerce, in the application of their revenues, are ingenuity in the several branches of the polite and liberal arts, useful discoveries and improvements in agriculture, manufactures, mechanics, and chemistry, or the laying open of any such to the public; and, in general, all such useful inventions, discoveries, or improvements (though not mentioned in the book of premiums) as may appear to have a tendency to the advantage of trade and commerce.

The following are some of the most important regulations of this society. It is required that the matters for which premiums are offered be delivered in without names, or any intimation to whom they belong; that each particular thing be marked in what manner each claimant thinks fit, such claimant sending with it a paper sealed up, having on the outside a corresponding mark, and on the inside the claimant's name and address; and all candidates are to take notice, that no

The respectability of the members who compose it may be seen by perusing the list which generally accompanies their transactions. In the last volume (vol. xii.) it occupies no less than 43 pages. Some idea may be formed of the wealth of this society, by observing that the list of their premiums fills 96 pages, and amounts to 250 in number. These consist of gold medals worth from 30 to 50, and in a few instances to 100 guineas; and silver medals valued at 10 guineas.

This society is one of the most important in Great Britain. Much money has been expended by it, and many are the valuable effects of which it has been productive. Among these we reckon not only the discoveries which it has excited, but the institution of other societies on the same principles to which it has given birth; and we do not hesitate to conclude, that future ages will consider the founding of this society as one of the most remarkable epochs in the history of the arts. We contemplate with pleasure the beneficial effects which must result to this nation and to mankind by the diffusion of such institutions; and rejoice in the hope that the active minds of the people of Great Britain, instead of being employed as formerly in controversies about religion, which engender strife, or in discussions concerning the theory of politics, which lead to the adoption of schemes inconsistent with the nature and condition of man, will soon be more generally united into associations for promoting useful knowledge and solid improvement, and for alleviating the distresses of their fellow creatures.

1. *Society instituted at Bath for the Encouragement of Agriculture, Arts, Manufactures, and Commerce*. It was founded in the year 1777 by several gentlemen who met at the city of Bath. This scheme met with a very favourable reception both from the wealthy and learned. The wealthy subscribed very liberally, and the learned communicated many important papers. On application to the London and provincial societies instituted for the like purposes, they very politely offered their assistance. Seven volumes of their transactions have already been published, containing very valuable experiments and observations, particularly respecting agriculture, which well deserve the attention of all farmers in the kingdom. We have consulted them with much satisfaction on several occasions, and have frequently referred to them in the course of this work; and therefore, with pleasure, embrace

Societies for
Encouraging and
Promoting
Arts, Manu-
factures,
&c.

embrace the present opportunity of repeating our obligations. We owe the same acknowledgments to the Society for the Improvement of Arts, &c. of London.

3. *Society for working Mines*, an association lately formed on the continent of Europe. This institution arose from the accidental meeting of several mineralogists at Skleno near Schemnitz in Hungary, who were collected in order to examine a new method of amalgamation. Struck with the shackles imposed on mineralogy by monopolizers of new and useful processes, they thought no method so effectual to break them, as forming a society, whose common labours should be directed to fix mining on its surest principles; and whose memoirs, spread all over Europe, might offer to every adventurer the result of the researches, of which they are the object. By these means they supposed, that there would be a mass of information collected; the interests of individuals would be lost in the general interest; and the one would materially assist the other. Impoliture and quackery would, by the same means, be banished from a science, which must be improved by philosophy and experience; and the society, they supposed, would find, in the confidence which they inspired, the reward and the encouragement of their labours. They design, that the memoirs which they publish shall be short and clear; truth must be their basis, and every idle discussion, every foreign digression, must be banished; politics and finance must be avoided, though the dissertations may seem to lead towards them; and they oblige themselves to oppose the affectation of brilliancies, and the ostentation of empty speculation, when compared with plain, simple, and useful facts.

The object of the society is physical geography; mineralogy founded on chemistry; the management of ore in the different operations which it undergoes; subterraneous geometry; the history of mining; founderies, and the processes for the extraction of metals from the ores, either by fusion or amalgamation, in every instance applied to practice. The end of this institution is to collect, in the most extensive sense, every thing that can assist the operations of the miner, and to communicate it to the different members, that they may employ it for the public good, in their respective countries. Each member must consider himself as bound to send to the society every thing which will contribute to the end of its institution; to point out, with precision, the several facts and observations; to communicate every experiment which occurs, even the unsuccessful ones, if the relation may seem to be advantageous to the public; to communicate to the society their examination of schemes, and their opinions on questions proposed by it; and to pay annually two ducats (about 18s. 6d.) to the direction every Easter. The society, on the other hand, is bound to publish every novelty that shall be communicated to it; to communicate to each member, at the member's expence, the memoirs, designs, models, productions, and every thing connected with the institution; to answer all the necessary demands made, relating in any respect to mining; and to give its opinion on every plan or project communicated through the medium of an honorary member.

The great centre of all intelligence is to be at Zellerfeld in Hartz, Brunswick: but the society is not fixed to any one spot; for every particular state some practical mineralogist is nominated as director. Among these

are the names of Baron Born, M. Pallas, M. Charpentier, M. Prebra, and M. Henkel. Their office is to propose the members; to take care that the views of the society are pursued in the different countries where they reside; to answer the requests of the members of their country who are qualified to make them; in case of the death of a director, to choose another; and the majority is to determine where the archives and the strong box is to be placed.

All the eminent mineralogists in Europe are members of this society. It is erected on so liberal and so extensive a plan, that we entertain the highest hopes of its success; and have only to add, that we wish much to see the study of several other sciences pursued in the same manner.

4. *The Society for the Improvement of Naval Architecture*, was founded in 1791. The object of it is to encourage every useful invention and discovery relating to naval architecture as far as shall be in their power, both by honorary and pecuniary rewards. They have in view particularly to improve the theories of floating bodies and of the resistance of fluids; to procure draughts and models of different vessels, together with calculations of their capacity, centre of gravity, tonnage, &c.; to make observations and experiments themselves, and to point out such observations and experiments as appear best calculated to further their designs, and most deserving those premiums which the society can bestow. But though the improvement of naval architecture in all its branches be certainly the principal object of this institution, yet the society do not by any means intend to confine themselves merely to the form and structure of vessels. Every subordinate and collateral pursuit will claim a share of the attention of the society in proportion to its merits; and whatever may have any tendency to render navigation more safe, salutary, and even pleasant, will not be neglected.

This institution owes its existence to the patriotic disposition and extraordinary attention of Mr Sewel a private citizen of London, who (though engaged in a line of business totally opposite to all concerns of this kind) has been led, by mere accident, to take such ocular notice of, and make such observations on, the actual state of naval architecture in this country, as naturally occurred to a man of plain understanding, zealous for the honour and interest of his country, and willing to bestow a portion of that time for the public good, which men of a different description would rather have devoted to their own private advantage. His attention was the more ferreously excited, by finding that it was the opinion of some private ship-builders, who, in a debate on the failure of one of our naval engagements, pronounced, that such "would ever be the case while that business (the construction of our ships of war) was not studied as a science, but carried on merely by precedent; that there had not been one improvement in our navy that did not originate with the French, who had naval schools and seminaries for the study of it; and that our ships were not a match for those of that nation either singly or in a fleet, &c. &c."

In a short time the society were enabled to offer very considerable premiums for particular improvements in the construction of our shipping, &c. &c. and also to encourage our philosophers, mathematicians, and mechanics, to make satisfactory experiments, tending to ascertain

Societies for
Encouraging and
Promoting
Arts, Manu-
factures,
&c.

Societies for
Encouraging and
Promoting
Arts, Manu-
factures,
&c.

certain the laws of resistance of water to solids of different forms, in all varieties of circumstance. On this head the reward is not less than one hundred pounds or a gold medal. Other premiums of 50, 30, and 20 guineas, according to the importance or difficulty of the particular subject or point of investigation, are likewise offered, for different discoveries, inventions, or improvements. The terms of admission into the society are a subscription of two guineas annually, or twenty guineas for life.

5. *Society of Artists of Great Britain*, which consists of directors and fellows, was incorporated by charter in 1765, and empowered to purchase and hold lands, not exceeding 1000l. a-year. The directors of this society, annually elected, are to consist of 24 persons, including the president, vice-president, treasurer, and secretary; and it is required that they be either painters, sculptors, architects, or engravers by profession.

6. *British Society for Extending the Fisheries and Improving the Sea-Coasts of this Kingdom*, was instituted in 1786. The end and design of this society will best appear from their charter, of which we present an abstract.

The preamble states, "the great want of improvement in fisheries, agriculture, and manufactures, in the Highlands and Islands of North Britain; the prevalence of emigration from the want of employment in those parts; the prospect of a new nursery of seamen, by the establishment of fishing towns and villages in that quarter. The act therefore declares, that the persons therein named, and every other person or persons who shall hereafter become proprietors of the joint stock mentioned therein, shall be a distinct and separate body politic and corporate, by the name of *The British Society for Extending the Fisheries and Improving the Sea-coasts of this Kingdom*: That the said society may raise a capital joint stock not exceeding 150,000l. to be applied to purchasing or otherwise acquiring lands and tenements in perpetuity, for the building thereon, and on no other land whatever, free towns, villages, and fishing stations: That the joint stock shall be divided into shares of 50l. each: That no one person shall in his or her name possess more than ten shares, or 500l.: That the society shall not borrow any sum or sums of money whatsoever: That the sums to be advanced for this undertaking, and the profits arising therefrom, shall be divided proportionally to the sum subscribed; and that no person shall be liable for a larger sum than he or she shall have respectively subscribed: That one or two shares shall intitle to one vote and no more, in person or by proxy, at all meetings of proprietors; three or four shares to two votes; five, six, or seven shares, to three votes; eight or nine shares to four votes; and ten shares to five votes and no more: That more persons than one inclining to hold in their joint names one or more shares shall be intitled to vote, by one of such persons, according to the priority of their names, or by proxy: That bodies corporate shall vote by proxy under their seal: That all persons holding proxies shall be proprietors, and that no one person shall hold more than five votes by proxy: That the affairs of the society shall be managed by a governor, deputy governor, and 12 other directors, to be elected annually on the 25th of March, from among the proprietors of the society, holding at least one full share, by signed bills of their names to be transmitted by

the proprietors to the secretary of the society: that five Societies for proprietors, not being governor, director, or other officer, shall be in like manner annually elected to audit the accounts of the society: That there shall be one general meeting of the proprietors annually on the 25th of March: That occasional general meetings shall be called on the request of nine or more proprietors: That the general meetings of the proprietors shall make all by-laws and constitutions for the government of the society, and for the good and orderly carrying on of the business of the same: That no transfer shall be made of the stock of the society for three years from the 10th of August 1786: That the calls of the society shall be lodged in the bank of England, bank of Scotland, or the royal bank of Scotland: That no director, proprietor, agent, or officer of the society, shall retain any sum or sums of money in his hands beyond the space of 30 days, on any account whatsoever: That all payments by the society shall be made by drafts on the said banks, under the hands of the governor or deputy-governor, countersigned by the secretary or his deputy, and two or more directors: And that the books in which the accounts of the society shall be kept shall be open to all the proprietors."

The institution of this public-spirited society was in a great measure owing to the exertions of the patriotic John Knox; who, in the course of 23 years, traversed and explored the Highlands of Scotland not fewer than 16 times, and expended several thousand pounds of his own fortune in pursuing his patriotic designs.

7. *British Wool Society*. See *British Wool Society*. *SOCIETY ISLES*, a cluster of isles, so named by Captain Cook in 1769. They are situated between the latitudes of 16. 10. and 16. 55. south, and between the longitudes of 150. 57. and 152. west. They are eight in number; namely, Otaheite, Huahine, Ulieeta, Otaha, Bolabola, Maurua, Toobouai, and Tabooyamanoo or Saunders's Island. The soil, productions, people, their language, religion, customs, and manners, are so nearly the same as at Otaheite, that little need be added here on that subject. Nature has been equally bountiful in uncultivated plenty, and the inhabitants are as luxurious and as indolent. A plain branch is the emblem of peace, and exchanging names the greatest token of friendship. Their dances are more elegant, their dramatic entertainments have something of plot and consistency, and they exhibit temporary occurrences as the objects of praise or satire; so that the origin of ancient comedy may be already discerned among them. The people of Huahine are in general flatter and fairer than those of Otaheite, and this island is remarkable for its populousness and fertility. Those of Ulieeta, on the contrary, are smaller and blacker, and much less orderly. Captain Cook put on shore a Cape ewe at Bolabola, where a ram had been left by the Spaniards; and also an English boar and sow, with two goats, at Ulieeta. If the valuable animals which have been transported thither from Europe should be suffered to multiply, no part of the world will equal these islands in variety and abundance of refreshments for future navigators.

SOCINIANS, in *Church History*, a sect of Christian heretics, so called from their founder Faustus Socinus (see SOCINUS). They maintain, "That Jesus Christ was a mere man, who had no existence before he was conceived by the Virgin Mary; that the Holy Ghost is

Socinians,
Socinus.

no diſtinct perſon, but that the Father is truly and properly God. They own, that the name of God is given in the Holy Scriptures to Jeſus Chriſt; but contend, that it is only a deputed title, which, however, invests him with an abſolute ſovereignty over all created beings, and renders him an object of worſhip to men and angels. They deny the doctrines of ſatiſfaction and imputed righteouſneſs; and ſay that Chriſt only preached the truth to mankind, ſet before them in himſelf an example of heroic virtue, and ſealed his doctrines with his blood. Original ſin and abſolute predeſtination they eſteem ſchooliſtic chimeras. They likewiſe maintain the ſleep of the ſoul, which they ſay becomes ſenſible at death, and is raiſed again with the body at the reſurrection, when the good ſhall be eſtabliſhed in the poſſeſſion of eternal felicity, while the wicked ſhall be conſigned to a fire that will not torment them eternally, but for a certain duration in proportion to their demerits."

This ſect has long been indignant at being ſtyled Socinians. They diſclaim every human leader; and profeſſing to be guided ſolely by the word of God and the deductions of reaſon, they call themſelves Unitarians; and affect to conſider all other Chriſtians, even their friends the Arians, as Polytheiſts. Modern Unitarianiſm, as taught by Dr Pateſſey, is, however, a very different thing from Socinianiſm, as we find it in the Rucovian catechiſm and other ſtandard works of the ſect. This far-famed philoſopher has diſcovered, what eſcaped the ſagacity of all the *fratres poloni*, that Jeſus Chriſt was the ſon of Joſeph as well as Mary; that the evangelists miſtook the meaning of Iſaiah's prophecy, that "a virgin ſhould conceive and bear a ſon;" that the applying of this prophecy to the birth of our Saviour, led them to conclude that his conception was miraculous; and that we are not to wonder at this miſtake, as the apoſtles were not always inſpired, and were in general inconcluſive reaſoners. The modesty of the writer in claiming the merit of ſuch diſcoveries will appear in its proper colours to all our readers: the truth of his doctrine ſhall be conſidered in another place. See THEOLOGY.

SOCINUS, LÆLIUS, the firſt author of the ſect of the Socinians, was born at Sienna in Tuſcany in 1525. Being deſigned by his father for the law, he began very early to ſearch for the foundation of that ſcience in the Word of God; and by that ſtudy diſcovered that the Romiſh religion taught many things contrary to revelation; when, being deſirous of penetrating farther into the true ſenſe of the Scriptures, he ſtudied Greek, Hebrew, and even Arabic. In 1547 he left Italy, to go and converſe with the Proteſtants; and ſpent four years in travelling through France, England, the Netherlands, Germany, and Poland, and at length ſettled at Zurich. He by this means became acquainted with the moſt learned men of his time, who teſtified by their letters the eſteem they had for him: but as he diſcovered to them his doubts, he was greatly ſuſpected of hereſy. He, however, conducted himſelf with ſuch addreſs, that he lived among the capital enemies of his opinions, without receiving the leaſt injury. He met with ſome diſciples, who heard his inſtructions with reſpect; theſe were Italians who left their native country on account of religion, and wandered about in Germany and Poland. He communicated likewiſe his ſentiments to his relations by his writings, which he cauſed to be conveyed to them

at Sienna. He died at Zurich in 1602. Thoſe who were of ſentiments oppoſite to his, and were perſonally acquainted with him, conſider that his outward behaviour was blameleſs. He wrote a Paraphraſe on the firſt chapter of St John; and other works are aſcribed to him.

SOCINUS, Faſtius, nephew of the preceding, and principal founder of the Socinian ſect, was born at Sienna in 1539. The letters which his uncle Lælius wrote to him, and which he ſent to him in 1570, of hereſy, made an impreſſion upon him; ſo that, leaving himſelf not innocent, he fled as well as the reſt when the inquiſition began to perſecute that family. He was at Lyons when he heard of his uncle's death, and departed immediately to take poſſeſſion of his writings. He returned to Tuſcany; and made himſelf ſo agreeable to the grand duke, that the charms which he found in that court, and the honourable poſts he filled there, hindered him for twelve years from remembering that he had been conſidered as the perſon who was to put the laſt hand to the ſyſtem of ſamaſtrian divinity, of which his uncle Lælius had made a rough draught. At laſt he went into Germany in 1574, and paid no regard to the grand duke's advices to return. He ſtaid three years at Baſil, and ſtudied divinity there, and having adopted a ſet of principles very different from the ſyſtem of Proteſtants, he reſolved to maintain and propagate them; for which purpoſe he wrote a treatiſe *De Uſa Chriſti Servatore*. In 1579 Socinus retired into Poland, and deſired to be admitted into the communion of the Unitarians; but as he differed from them in ſome points, on which he reſuſed to be ſilent, he met with a reſuſe. However, he did not ceaſe to write in defence of their churches againſt thoſe who attacked them. At length his book againſt James Paleologus furniſhed his enemies with a pretence to excommunicate the king of Poland againſt him; but though the mere reading of it was ſufficient to refute his accuſers, Socinus thought proper to leave Cracow, after having reſided there four years. He then lived under the protection of ſeveral Polith lords, and married a lady of a good family; but her death, which happened in 1587, ſo deeply afflicted him as to injure his health; and to complete his ſorrow, he was deprived of his patrimony by the death of Francis de Medicis great duke of Florence. The conſolation he found in ſeeing his ſentiments at laſt approved by ſeveral miniſters, was greatly interrupted in 1593; for he met with a thouſand inſults at Cracow, and was with great difficulty ſaved from the hands of the rabble. His houſe was plundered, and he loſt his goods; but this loſs was not ſo uneaſy to him as that of ſome manuſcripts, which he extremely regretted. To deliver himſelf from ſuch dangers, he retired to a village about nine miles diſtant from Cracow, where he ſpent the remainder of his days at the houſe of Abraham Blouſki, a Polith gentleman, and died there in 1604. All Faſtius Socinus's works are contained in the two firſt volumes of the *Bibliotheca Fratrum Polonorum*.

SOCMANS, SOKEMANS, or Soemen (*Socmanni*), are ſuch tenants as hold their lands and tenements by ſocage tenure. See SOGAGE.

SOCOFORA, an iſland lying between Aſia and Arabia Felix; about 50 miles in length, and 22 in breadth. It is particularly noted for its fine aloe, known by the name of *Socotrine ALOES*. The religion of the natives

Socrates,
Socrates.

natives is a mixture of Mahometanism and Paganism; but they are civil to strangers who call there in their passage to the East Indies. It abounds in fruit and cattle; and they have a king of their own, who is dependent on Arabia.

SOCRATES, the greatest of the ancient philosophers, was born at Alopece, a village near Athens, in the fourth year of the 77th olympiad. His parents were of low rank; his father Sophroniscus being a stonemason, and his mother Phænareta a midwife. Sophroniscus brought up his son, contrary to his inclination, in his own manual employment; in which Socrates, though his mind was continually aspiring after higher objects, was not unsuccessful, for whilst he was a young man, he is said to have formed statues of the habited Graces, which were allowed a place in the citadel of Athens. Upon the death of his father he was left in such straitened circumstances as laid him under the necessity of exercising that art to procure the means of subsistence, though he devoted, at the same time, all the leisure which he could command to the study of philosophy. His distress, however, was soon relieved by Crito, a wealthy Athenian; who, remarking his strong propensity to study, and admiring his ingenuous disposition and distinguished abilities, generously took him under his patronage, and intrusted him with the instruction of his children. The opportunities which Socrates by this means enjoyed of attending the public lectures of the most eminent philosophers, so far increased his thirst after wisdom, that he determined to relinquish his occupation, and every prospect of emolument which that might afford, in order to devote himself entirely to his favourite pursuits. Under Anaxagoras and Archelaus he prosecuted the study of nature in the usual manner of the philosophers of the age, and became well acquainted with their doctrines. Prodicus the sophist was his preceptor in eloquence, Evemerus in poetry, Theodorus in geometry, and Dama in music. Aspasia, a woman no less celebrated for her intellectual than her personal accomplishments, whose house was frequented by the most celebrated characters, had also some share in the education of Socrates. Under such preceptors it cannot reasonably be doubted but that he became master of every kind of learning which the age in which he lived could afford; and being blessed with very uncommon talents by nature, he appeared in Athens, under the respectable characters of a good citizen and a true philosopher. Being called upon by his country to take arms in the long and severe struggle between Athens and Sparta, he signalized himself at the siege of Potidea, both by his valour and by the hardiness with which he endured fatigue. During the severity of a Thracian winter, whilst others were clad in furs, he wore only his usual clothing, and walked barefoot upon the ice. In an engagement in which he saw ALCIBIADES falling down wounded, he advanced to defend him, and saved both him and his arms: and though the prize of valour was on this occasion unquestionably due to Socrates, he generously gave his vote that it might be bestowed upon Alcibiades, to encourage his rising merit. He served in other campaigns with distinguished bravery, and had the happiness on one occasion to save the life of Xenophon, by bearing him, when covered with wounds, out of the reach of the enemy.

It was not till Socrates was upwards of 60 years of

Socrates.

age that he undertook to serve his country in any civil office, when he was chosen to represent his own district, in the senate of five hundred. In this office, though he at first exposed himself to some degree of ridicule from the want of experience in the forms of business, he soon convinced his colleagues that he was superior to them all in wisdom and integrity. Whilst they, intimidated by the clamours of the populace, passed an unjust sentence of condemnation upon the commanders, who, after the engagement at the Arginufian islands, had been prevented by a storm from paying funeral honours to the dead, Socrates stood forth singly in their defence, and to the last refused to give his suffrage against them, declaring that no force should compel him to act contrary to justice and the laws. Under the subsequent tyranny he never ceased to condemn the oppressive and cruel proceedings of the thirty tyrants; and when his boldness provoked their resentment, so that his life was in hazard, fearing neither treachery nor violence, he still continued to support with undaunted firmness the rights of his fellow citizens.

Having given these proofs of public virtue both in a military and civil capacity, he wished to do still more for his country. Observing with regret how much the opinions of the Athenian youth were misled, and their principles and taste corrupted by philosophers who spent all their time in refined speculations upon nature and the origin of things, and by sophists who taught in their schools the arts of false eloquence and deceitful reasoning; Socrates formed the wise and generous design of instituting a new and more useful method of instruction. He justly conceived the true end of philosophy to be, not to make an ostentatious display of superior learning and ability in subtle disputations or ingenious conjectures, but to free mankind from the dominion of pernicious prejudices; to correct their vices; to inspire them with the love of virtue; and thus conduct them in the path of wisdom to true felicity. He therefore assumed the character of a moral philosopher; and, looking upon the whole city of Athens as his school, and all who were disposed to lend him their attention as his pupils, he seized every occasion of communicating moral wisdom to his fellow citizens. He passed the greater part of his time in public; and the method of instruction of which he chiefly made use, was to propose a series of questions to the person with whom he conversed, in order to lead him to some unforeseen conclusion. He first gained the consent of his respondent to some obvious truths, and then obliged him to admit others from their relation or resemblance to those to which he had already assented. Without making use of any direct argument or persuasion, he chose to lead the person he meant to instruct, to deduce the truths of which he wished to convince him, as a necessary consequence from his own concessions. He commonly conducted these conferences with such address, as to conceal his design till the respondent had advanced too far to recede. On some occasions he made use of ironical language, that vain men might be caught in their own replies, and be obliged to confess their ignorance. He never assumed the air of a morose and rigid preceptor, but communicated useful instruction with all the ease and pleasantry of polite conversation. Though eminently furnished with every kind of learning, he preferred moral to speculative wisdom. Convinced that phi-

lophony

Socrates. Philosophy is valuable, not as it furnishes questions for the schools, but as it provides men with a law of life, he censured his predecessors for spending all their time in abstruse researches into nature, and taking no pains to render themselves useful to mankind. His favourite maxim was, Whatever is above us doth not concern us. He estimated the value of knowledge by its utility, and recommended the study of geometry, astronomy, and other sciences, only so far as they admit of a practical application to the purposes of human life. His great object in all his conferences and discourses was, to lead men into an acquaintance with themselves; to convince them of their follies and vices; to inspire them with the love of virtue; and to furnish them with useful moral instructions. Cicero might therefore very justly say of Socrates, that he was the first who called down philosophy from heaven to earth, and introduced her into the public walks and domestic retirements of men, that she might instruct them concerning life and manners.

Through his whole life this good man discovered a mind superior to the attractions of wealth and power. Contrary to the general practice of the preceptors of his time, he instructed his pupils without receiving from them any gratuity. He frequently refused rich presents, which were offered him by Alcibiades and others, though importunately urged to accept them by his wife. The chief men of Athens were his stewards: they sent him in provisions, as they apprehended he wanted them; he took what his present wants required, and returned the rest. Observing the numerous articles of luxury which were exposed to sale in Athens, he exclaimed, "How many things are there which I do not want!" With Socrates, moderation supplied the place of wealth. In his clothing and food, he consulted only the demands of nature. He commonly appeared in a neat but plain cloak, with his feet uncovered. Though his table was only supplied with simple fare, he did not scruple to invite men of superior rank to partake of his meals; and when his wife, upon some such occasion, expressed her dissatisfaction on being no better provided, he desired her to give herself no concern; for if his guests were wife men, they would be contented with whatever they found at his table; if otherwise, they were unworthy of notice. Whilft others, says he, live to eat, wife men eat to live.

Though Socrates was exceedingly unfortunate in his domestic connection, he converted this infelicity into an occasion of exercising his virtues. Xantippe, concerning whose ill humour ancient writers relate many amusing tales, was certainly a woman of a high and unmanageable spirit. But Socrates while he endeavoured to curb the violence of her temper, improved his own. When Alcibiades expressed his surprize that his friend could bear to live in the same house with so perverse and quarrelsome a companion, Socrates replied, that being daily injured to ill humour at home, he was the better prepared to encounter perverseness and injury abroad.

In the midst of domestic vexations and public disorders, Socrates retained such an unruffled serenity, that he was never seen either to leave his own house or to return home with a disordered countenance. In acquiring this entire dominion over his passions and appetites, he had the greater merit, as it was not effected without a violent struggle against his natural propensities. Zo-

pyrus, an eminent physiognomist, declared, that he discovered in the features of the philosopher evident traces of many vicious inclinations. The friends of Socrates who were present ridiculed the ignorance of this pretender to extraordinary sagacity. But Socrates himself ingenuously acknowledged his penetration, and confessed that he was in his natural disposition prone to vice, but that he had subdued his inclinations by the power of reason and philosophy.

Through the whole of his life Socrates gave himself up to the guidance of unbiaffed reason, which is supposed by some to be all that he meant by the genius or *dæmon* from which he professed to receive instruction. But this opinion is inconsistent with the accounts given by his followers of that *dæmon*, and even with the language in which he spoke of it himself. Plato sometimes calls it his *guardian*, and Apuleius his *god*; and as Xenophon attests that it was the belief of his master that the gods occasionally communicate to men the knowledge of future events, it is by means improbable that Socrates admitted, with the generality of his countrymen, the existence of those intermediate beings called *dæmons*, of one of which he might fancy himself the peculiar care.

It was one of the maxims of Socrates, "That a wife man will worship the gods according to the institutions of the state to which he belongs." Convinced of the weakness of the human understanding, and perceiving that the pride of philosophy had led his predecessors into futile speculations on the nature and origin of things, he judged it most consistent with true wisdom to speak with caution and reverence concerning the divine nature.

The wisdom and the virtues of this great man, whilst they procured him many followers, created him also many enemies. The Sophists*, whose knavery and ignorance he took every opportunity of exposing to public contempt, became inveterate in their enmity against so bold a reformer, and devised an expedient, by which they hoped to check the current of his popularity. They engaged Aristophanes, the first buffoon of the age, to write a comedy, in which Socrates should be the principal character. Aristophanes, pleased with so promising an occasion of displaying his low and malignant wit, undertook the task, and produced the comedy of *The Clouds*, still extant in his works. In this piece, Socrates is introduced hanging in a basket in the air, and thence pouring forth absurdity and profaneness. But the philosopher, showing in a crowded theatre that he was wholly unmoved by this ribaldry, the satire failed of its effect; and when Aristophanes attempted the year following to renew the piece with alterations and additions, the representation was so much disapproved, that he was obliged to discontinue it.

From this time Socrates continued for many years to pursue without interruption his laudable design of instructing and reforming his fellow-citizens. At length, however, when the inflexible integrity with which he had discharged the duty of a senator, and the firmness with which he had opposed every kind of political corruption and oppression, had greatly increased the number of his enemies, clandestine arts were employed to raise a general prejudice against him. The people were indolently reminded, that Critias, who had been one of the most cruel of the thirty tyrants, and Alcibiades,

Socrates, who had insulted religion, by defacing the public statues of Mercury, and perverting a mock representation of the Eleusinian mysteries, had in their youth been disciples of Socrates; and the minds of the populace being thus prepared, a direct accusation was preferred against him before the supreme court of judicature. His accusers were Anytus a leather-dresser, who had long entertained a personal enmity against Socrates, for reprehending his avarice, in depriving his sons of the benefits of learning, that they might pursue the gains of trade; Melitus, a young rhetorician, who was capable of undertaking any thing for the sake of gain; and Lycon, who was glad of any opportunity of displaying his talents. The accusation, which was delivered to the senate under the name of Melitus, was this: "Melitus, son of Melitus, of the tribe of Pythos, accuseth Socrates, son of Sophroniscus, of the tribe of Alopecce. Socrates violates the laws, in not acknowledging the gods which the state acknowledges, and by introducing new divinities. He also violates the laws by corrupting the youth. Be his punishment DEATH."

This charge was delivered upon oath to the senate; and Crito a friend of Socrates became surety for his appearance on the day of trial. Anytus soon afterwards sent a private message to Socrates, assuring him that if he would desist from censuring his conduct, he would withdraw his accusation. But Socrates refused to comply with so degrading a condition; and with his usual spirit replied, "Whilst I live I will never disguise the truth, nor speak otherwise than my duty requires." The interval between the accusation and the trial he spent in philosophical conversations with his friends, choosing to discourse upon any other subject rather than his own fault.

When the day of trial arrived, his accusers appeared in the senate, and attempted to support their charge in three distinct speeches, which strongly marked their respective characters. Plato, who was a young man, and a zealous follower of Socrates, then rose up to address the judges in defence of his master; but whilst he was attempting to apologise for his youth, he was abruptly commanded by the court to sit down. Socrates, however needed no advocate. Ascending the chair with all the serenity of conscious innocence, and with all the dignity of superior merit, he delivered, in a firm and manly tone, an unremitted defence of himself, which silenced his opponents, and ought to have convinced his judges. After tracing the progress of the conspiracy which had been raised against him to its true source, the jealousy and resentment of men whose ignorance he had exposed, and whose vices he had ridiculed and reformed, he distinctly replied to the several charges brought against him by Melitus. To prove that he had not been guilty of impiety towards the gods of his country, he appealed to his frequent practice of attending the public religious festivals. The crime of introducing new divinities, with which he was charged, chiefly as it seems on the ground of the admissions which he professed to have received from an invisible power, he disclaimed, by pleading that it was no new thing for men to consult the gods and receive instructions from them. To refute the charge of his having been a corrupter of youth, he urged the example which he had uniformly exhibited of justice, moderation, and temperance; the moral spirit and tendency of his discourses;

and the effect which had actually been produced by his doctrine upon the manners of the young. Then, disdaining to solicit the mercy of his judges, he called upon them for that justice which their office and their oath obliged them to administer; and professing his faith and confidence in God, resigned himself to their pleasure.

The judges, whose prejudices would not suffer them to pay due attention to this apology, or to examine with impartiality the merits of the cause, immediately declared him guilty of the crimes of which he stood accused. Socrates, in this stage of the trial, had a right to enter his plea against the punishment which the accusers demanded, and instead of the sentence of death, to propose some pecuniary amercement. But he at first peremptorily refused to make any proposal of this kind, imagining that it might be construed into an acknowledgement of guilt; and asserted, that his conduct merited from the state reward rather than punishment. At length, however, he was prevailed upon by his friends to offer upon their credit a fine of thirty *minæ*. The judges, notwithstanding, still remained inexorable: they proceeded, without farther delay, to pronounce sentence upon him; and he was condemned to be put to death by the poison of hemlock.

The sentence being passed, he was sent to prison: which, says Seneca, he entered with the same resolution and firmness with which he had opposed the thirty tyrants; and took away all ignominy from the place, which could not be a prison while he was there. He lay in fetters 30 days; and was constantly visited by Crito, Plato, and other friends, with whom he passed the time in dispute after his usual manner. Anxious to save so valuable a life, they urged him to attempt his escape, or at least to permit them to convey him away; and Crito went so far, as to assure him that, by his interest with the jailor, it might be easily accomplished, and to offer him a retreat in Thessaly; but Socrates rejected the proposal, as a criminal violation of the laws; and asked them, whether there was any place out of Attica which death could not reach.

At length the day arrived when the officers to whose care he was committed delivered to Socrates early in the morning the final order for his execution, and immediately, according to the law, set him at liberty from his bonds. His friends, who came thus early to the prison that they might have an opportunity of conversing with their master through the day, found his wife sitting by him with a child in her arms. Socrates, that the tranquillity of his last moments might not be disturbed by her unavailing lamentations, requested that the might be conducted home. With the most frantic expressions of grief she left the prison. An interesting conversation then passed between Socrates and his friends, which chiefly turned upon the immortality of the soul. In the course of this conversation, he expressed his disapprobation of the practice of suicide, and assured his friends that his chief support in his present situation was an expectation, though not unmixed with doubts, of a happy existence after death. "It would be inexcusable in me (said he) to despise death, if I were not persuaded that it will conduct me into the presence of the gods, who are the most righteous governors, and into the society of just and good men: but I derive confidence from the hope that something of man remains after death,

Socrates. death, and that the condition of good men will then be much better than that of the bad." Crito afterwards asking him, in what manner he wished to be buried? Socrates replied, with a smile, "As you please, provided I do not escape out of your hands." Then, turning to the rest of his friends, he said, "Is it not strange, after all that I have said to convince you that I am going to the society of the happy, that Crito still thinks that this body, which will soon be a lifeless corpse, is Socrates? Let him dispose of my body as he pleases, but let him not at its interment mourn over it as if it were Socrates."

Towards the close of the day he retired into an adjoining apartment to bathe; his friends, in the mean time, expressing to one another their grief at the prospect of losing so excellent a father, and being left to pass the rest of their days in the solitary state of orphans. After a short interval, during which he gave some necessary instructions to his domestics, and took his last leave of his children, the attendant of the prison informed him, that the time for drinking the poison was come. The executioner, though accustomed to such scenes, shed tears as he presented the fatal cup. Socrates received it without change of countenance or the least appearance of perturbation: then offering up a prayer to the gods that they would grant him a prosperous passage into the invisible world, with perfect composure he swallowed the poisonous draught. His friends around him burst into tears. Socrates alone remained unmoved. He upbraided their pusillanimity, and entreated them to exercise a manly constancy worthy of the friends of virtue. He continued walking till the chilling operation of the hemlock obliged him to lie down upon his bed. After remaining for a short time silent, he requested Crito (probably in order to refute a calumny which might prove injurious to his friends after his decease) not to neglect the offering of a cock which he had vowed to Esculapius. Then, covering himself with his cloak, he expired. Such was the fate of the virtuous Socrates! A story, says Cicero, which I never read without tears.

The friends and disciples of this illustrious teacher of wisdom were deeply affected by his death, and attended his funeral with every expression of grief. Apprehensive, however, for their own safety, they soon afterwards privately withdrew from the city, and took up their residence in distant places. Several of them visited the philosopher Euclid of Megara, by whom they were kindly received. No sooner was the unjust condemnation of Socrates known through Greece, than a general indignation was kindled in the minds of good men, who universally regretted that so distinguished an advocate for virtue should have fallen a sacrifice to jealousy and envy. The Athenians themselves, so remarkable for their caprice, who never knew the value of their great men till after their death, soon became sensible of the folly as well as criminality of putting to death the man who had been the chief ornament of their city and of the age, and turned their indignation against his accusers. Melitus was condemned to death; and Anytus, to escape a similar fate, went into voluntary exile. To give a further proof of the sincerity of their regret, the Athenians for a while interrupted public business; decreed a general mourning; recalled the exiled friends of Socrates; and erected a statue to his

memory in one of the most frequented parts of the city. His death happened in the first year of the 69th olympiad, and in the 70th year of his age.

Socrates left behind him nothing in writing; but his illustrious pupils Xenophon and Plato have in some measure supplied this defect. The Memoirs of Socrates, written by Xenophon, afford, however, a much more accurate idea of the opinions of Socrates, and of his manner of teaching, than the Dialogues of Plato, who everywhere mixes his own conceivings and diction with the ideas and language of his master. It is related, that when Socrates heard Plato recite his *Lylius*, he said, "How much does this young man make me say which I never conceived!"

His distinguishing character was that of a moral philosopher; and his doctrine concerning God and religion was rather practical than speculative. But he did not neglect to build the structure of religious faith upon the firm foundation of an appeal to natural appearances: He taught, that the Supreme Being, though invisible, is clearly seen in his works: which at once demonstrate his existence and his wise and benevolent providence. He admitted, besides the one Supreme Deity, the existence of beings who possess a middle station between God and man, to whose immediate agency he ascribed the ordinary phenomena of nature, and whom he supposed to be particularly concerned in the management of human affairs. Hence he declared it to be the duty of every one, in the performance of religious rites, to follow the customs of his country. At the same time, he taught, that the merit of all religious offerings depends upon the character of the worshipper, and that the gods take pleasure in the sacrifices of none but the truly pious.

Concerning the human soul, the opinion of Socrates, according to Xenophon, was, that it is allied to the Divine Being, not by a participation of essence, but by a similarity of nature; that man excels all other animals in the faculty of reason; and that the existence of good men will be continued after death in a state in which they will receive the reward of their virtue. Although it appears that on this latter topic he was not wholly free from uncertainty, the consolation which he professed to derive from this source in the immediate prospect of death, leaves little room to doubt that he entertained a real expectation of immortality: and there is reason to believe that he was the only philosopher of ancient Greece whose principles admitted of such an expectation (see *MEGALYSIS*, Part III. Chap. IV.). Of his moral system, which was in a high degree pure, and founded on the surest basis, the reader will find a short view in our article *MORAL PHILOSOPHY*, N^o 4.

SOCRATES was also the name of an ecclesiastical historian of the 5th century, born at Constantinople in the beginning of the reign of Theodosius: he protected the law and pleaded at the bar, whence he obtained the name of *Scholasticus*. He wrote an ecclesiastical history from the year 350, where Eusebius ended, down to 445; and wrote with great exactness and judgement. An edition of Eusebius and Socrates, in Greek and Latin, with notes by Reading, was published at London in 1725.

SODA, the name given by the French chemists to the mineral alkali, which is found native in many parts of the world: it is obtained by from common salt, and

Soda
Sodor.

from the ashes of the *halé*, a species of salfolia. See CHEMISTRY *Index*, for an account of its properties and combinations: but long after that article was written, soda and potash were decomposed by means of galvanism; and the alkalies, hitherto considered as simple substances, appear, from the experiments of Mr Davy, who first made the discovery, to be compounds of oxygen and a metallic base. Mr Davy's conclusions have been controverted by some of the French chemists; and as the subject may perhaps in a few months receive some farther elucidation, we shall delay our account of the whole till we come to describe the apparatus by which the experiments are conducted. See *TROUGH, Galvanic*.

SODA is also a name for a heat in the stomach, or heart-burn. See MEDICINE, N° 275.

SODOM, formerly a town of Palestine in Asia, famous in Scripture for the wickedness of its inhabitants, and their destruction by fire from heaven on account of that wickedness. The place where it stood is now covered by the waters of the Dead sea, or the lake Asphaltites. See ASPHALTITES.

SODOMY, an unnatural crime, so called from the city of Sodom, which was destroyed by fire for the same. The Levitical law adjudged those guilty of this execrable crime to death; and the civil law assigns the same punishment to it. The law of England makes it felony. There is no statute in Scotland against Sodomy; the libel of the crime is therefore founded on the divine law, and practice makes its punishment to be burned alive.

SODOR, a name always conjoined with Man, in mentioning the bishop of Man's diocese. Concerning the origin and application of this word, very different opinions have been formed by the learned. Buchanan (lib. i. cap. 34.) says, that before his time the name of *Sodor* was given to a town in the isle of Man. In Gough's edition of Camden's *Britannia* (vol. iii. p. 701.) it is said, that after the isle of Man was annexed to the crown of England, this appellation was given to a small island within musket-shot of Man, in which the cathedral stands, called by the Norwegians the *Holm*, and by the inhabitants the *Peel*. In support of this opinion a charter is quoted A. D. 1505, in which Thomas earl of Derby and lord of Man confirms to Huan Heketh bishop of Sodor all the lands, &c. anciently belonging to the bishops of Man. "Ecclesiam cathedralam sancti Germani in *Holm Sodor vel Pele* vocatam, ecclesiam sancti Patricii ibidem, et locum presatum in quo ecclesie prelate sita sunt." The truth of either, or perhaps of both, these accounts might be allowed; but neither of them is sufficient to account for the constant conjunction of Sodor and Man, in charters, registers, and histories. If Sodor was a small town or island belonging to Man, it cannot be conceived why it is always mentioned before it, or rather why it should be mentioned at all in speaking of a bishop's diocese. To speak of the bishopric of Sodor and Man in this case would be as improper as it would be to call the bishopric of Durham the bishopric of Holy Island and Durham, or the bishopric of Darlington and Durham; the former being a small island and the latter a town belonging to the county and diocese of Durham. Neither of these accounts, therefore, gives a satisfactory account of the original conjunction of Sodor and Man.

1

Sedor,
Sots.

The island of Iona was the place where the bishop of the Isles resided, the cathedral church of which, it is said, was dedicated to our Saviour, in Greek *Soter*, hence *Sotorenfes*, which might be corrupted into *Sodorenfes*, a name frequently given by Danish writers to the western isles of Scotland. That we may be the more disposed to accede to this Grecian etymology, the advocates for this opinion tell us, that the name *Iscolumhill*, which is often applied to this island, is also of Greek extraction, being derived from *Columba*, "a pigeon;" a meaning that exactly corresponds to the Celtic word *Colum* and the Hebrew word *Iona*. We must confess, however, that we have very little faith in the conjectures of etymologists, and think that upon no occasion they alone can establish any fact, though when concurring with facts they certainly tend to confirm and explain them. It is only from historical facts that we can know to what Sodor was applied.

It appears from the history of the Orkneys, compiled by an old Icelandic writer, translated and enlarged by Torfaus, that the *Æbudæ* or Western isles of Scotland were divided into two clusters, *Nordureys* and *Sudereys*. The *Nordureys*, which were separated from the *Sudereys* by the point of Ardnamurchan, a promontory in Argyleshire, consisted of Muck, Egg, Rum, Canna, Skye, Ralry, Barra, South Uist, North Uist, Benbecula, and Lewis, including Harris, with a great number of small isles. The *Sudereys* were, Man, Arran, Bute, Cumra, Avon, Gid, Ila, Colonafy, Jura, Scarba, Mull, Iona, Tiree, Coll, Ulva, and other small islands. All these, when joined together, and subject to the same prince, made up the kingdom of Man and the Isles. In the Norwegian language, *Suder* and *Norder* signify southern and northern, and *ey* or *ay* an island. When the *Æbudæ* were under one monarch, the seat of empire was fixed in the *Sudereys*, and the *Nordureys* were governed by deputies; hence the former are much oftener mentioned in history than the latter; hence, too, the *Sudereys* often comprehend the *Nordureys*, as in our days Scotland is sometimes comprehended under England. *Sudereys*, or *Suder*, when anglicised, became Sodor; and all the Western isles of Scotland being included in one diocese under the Norwegian prince, the bishop appointed to superintend them was called the bishop of Man and the Isles, or the bishop of Sodor and Man. Since Man was conquered by Edward III. it has been separated from the other isles, and its bishops have exercised no jurisdiction over them. Should it now be asked, why then is the bishop of Man still called the bishop of Sodor and Man? we reply, that we have been able to discover no reason; but suppose the appellation to be continued in the same way, as the title king of France has been kept up by the kings of Great Britain, for several centuries after the English were entirely expelled from France.

SOFA, in the east, a kind of alcove raised half a foot above the floor of a chamber or other apartment; and used as the place of state, where visitors of distinction are received. Among the Turks the whole floor of their state-rooms is covered with a kind of tapestry, and on the window-side is raised a sofa or *sofpha*, laid with a kind of mattress, covered with a carpet much richer than the other. On this carpet the Turks are seated, both men and women, like the tailors in England, cross-legged, leaning against the wall, which is

bolted

Soh
Soho.

bolstered with velvet, satin, or other stuff suitable to the season. Here they eat their meals; only laying a skin over the carpet to serve as a tablecloth, and a round wooden board over all, covered with plates, &c.

SOFALA, or **CEFALA**, a kingdom of Africa, lying on the coast of Mosambique, near Zanguebar. It is bounded on the north by Monomotapa; on the east by the Mosambique sea; on the south by the kingdom of Sabia; and on the west by that of Manica. It contains mines of gold and iron, and a great number of elephants. It is governed by a king, tributary to the Portuguese, who built a fort at the principal town, which is of the same name, and of great importance for their trade to the East Indies. It is seated in a small island, near the mouth of a river. E. Long. 35. 42. S. Lat. 20. 22.

SOFITA, or **SOFIT**, in *Architecture*, any timber ceiling formed of cross beams of flying corniches, the square compartments or panels of which are enriched with sculpture, painting, or gilding; such are those in the palaces of Italy, and in the apartments of Luxembourg at Paris.

SOFITA, or *Soffit*, is also used for the underside or face of an architrave; and more particularly for that of the corona or larmier, which the ancients called *lacunar*, the French *plafond*, and we usually the *drip*. It is enriched with compartments of roses; and in the Doric order has 18 drops, disposed in three ranks, six in each, placed to the right of the gutter, at the bottom of the triglyphs.

SOFI, or **SOPHI**. See **SOPHI**.

SOFTENING, in *Painting*, the mixing and diluting of colours with the brush or pencil.

SOHO, the name of a set of works, or manufactory of a variety of hardwares, belonging to the late Mr Boulton, situated on the borders of Staffordshire, within two miles of Birmingham; now so justly celebrated as to deserve a short historical detail.

About 30 years ago the premises consisted of a small mill and a few obscure dwellings. Mr Boulton, in conjunction with Mr Fothergill, then his partner, at an expense of 9000*l.* erected a handsome and extensive edifice, with a view of manufacturing metallic toys. The first productions consisted of buttons, buckles, watch-chains, trinkets, and such other articles as were peculiar to Birmingham. Novelty, taste, and variety, were however always conspicuous; and plated wares, known by the name of Sheffield plate, comprising a great variety of useful and ornamental articles, became another permanent subject of manufacture.

To open channels for the consumption of these commodities, all the northern part of Europe was explored by the mercantile partner Mr Fothergill. A wide and extensive correspondence was thus established, the undertaking became well known, and the manufacturer, by becoming his own merchant, eventually enjoyed a double profit.

Impelled by an ardent attachment to the arts, and by the patriotic ambition of forming his favourite Soho into a fruitful seminary of arts, the proprietor extended his

views; and men of taste and talents were now sought for, and liberally patronised. A successful imitation of the French or *mouffe* ornaments, consisting of vases, tripods, candelabra, &c. &c. extended the celebrity of the works. Services of plate and other works in silver, both massive and airy, were added, and an assay office was established in Birmingham.

Mr Watt, the ingenious improver of the steam-engine, was afterwards taken into partnership with Mr Boulton; and they carried on at Soho a manufactory of steam-engines, not less beneficial to the public than lucrative to themselves. This valuable machine, the nature and excellencies of which are described in another place (see *STEAM-Engine*), Mr Boulton proposed to apply to the operation of coining, and suitable apparatus was erected at a great expense, for the purpose of being employed by government to make a new copper-coinage for the kingdom. Artificers of merit were engaged, and specimens of exquisite delicacy were exhibited; the works were also employed upon highly finished medals and private coins. To enumerate all the productions of this manufactory would be tedious (A).

In a national view, Mr Boulton's undertakings are highly valuable and important. By collecting around him artificers of various descriptions, rival talents have been called forth, and by successive competition have been multiplied to an extent highly beneficial to the public. The manual arts partook of the benefit, and became proportionably improved.

A barren heath has been covered with plenty and population; and Mr Boulton's works, which in their infancy were little known and attended to, now cover several acres, give employment to more than 6000 persons, and are said to be the first of their kind in Europe.

SOIL, the mould covering the surface of the earth, in which vegetables grow. It serves as a support for vegetables, and as a reservoir for receiving and communicating their nourishment.

Soils are commonly double or triple compounds of the several reputed primitive earths, except the barytic. The magnesian likewise sparingly occurs. The more fertile soils afford also a small proportion of coaly substance arising from putrefaction, and some traces of marine acid and gypsum. The vulgar division into clay, chalk, sand, and gravel, is well understood. Loam denotes any soil moderately adhesive; and, according to the ingredient that predominates, it receives the epithets of clayey, chalky, sandy, or gravelly. The intimate mixture of clay with the oxides of iron is called *till*, and is of a hard consistence and a dark reddish colour. Soils are found by analysis to contain their earthy ingredients in very different proportions. According to M. Giobert, fertile mould in the vicinity of Turin, where the fall of rain amounts yearly to 40 inches, affords for each 100 parts, from 77 to 79 of silice, from 8 to 14 of argill, and from 5 to 12 of calx; besides about one-half of carbonic matter, and nearly an equal weight of gas, partly carbonic and partly hydrocarbonic. The same experimenter represents the composition of barren soils in similar situations to be from 42 to 88 per cent. of silice,

Soho,
Soil.

(A) It was at this place, in the year 1772, that Mr Eginton invented an expeditious method of copying pictures in oil; but we do not know how far this method has succeeded.

lex, from 20 to 30 of argill, and from 4 to 20 of calx. The celebrated Bergman found rich soils in the valleys of Sweden, where the annual quantity of rain is 24 inches, to contain, for each 100 parts, 36 of siliceous sand, 14 of argill, and 30 of calx. In the climate of Paris, where the average fall of rain is 20 inches, fertile mixtures, according to M. Tillet, vary from 46 to 52 per cent. of silicæ, and from 11 to 17 of argill, with 37 of calx. Hence it appears that in dry countries rich earths are of a closer texture, and contain more of the calcareous ingredient, with less of the siliceous. Mr Arthur Young has discovered, that the value of fertile lands is nearly proportioned to the quantities of gas which equal weights of their soil afford by distillation. See AGRICULTURE *Indev.*

SOISSONS, an ancient, large, and considerable city of France, in the department of Aisne and late province of Soissonois. It was the capital of a kingdom of the same name, under the first race of the French monarchs. It contains about 12,000 inhabitants, and is a bishop's see. The environs are charming, but the streets are narrow, and the houses ill-built. The fine cathedral has one of the most considerable chapters in the kingdom; and the bishop, when the archbishop of Rheims was absent, had a right to crown the king. The castle, though ancient, is not that in which the kings of the first race resided. Soissons is seated in a very pleasant and fertile valley, on the river Aisne, 30 miles west by north of Rheims, and 60 north-east of Paris. E. Long. 3. 24. N. Lat. 49. 23.

SOKE, or SOK. See SOGAGE.

SOKEMANS. See SOL and SOGAGE.

SOL, in *Musæc*, the fifth note of the gamut, *ut, re, mi, fa, sol, la*. See GAMUT.

SOL, or *Sau*, a French coin made up of copper mixed with a little silver, and is worth upwards of an English halfpenny, or the 23d part of an English shilling. The sol when first struck was equal in value to 12 deniers Tournois, whence it was also called *douzain*, a name it still retains, though its ancient value be changed; the sol having been since augmented by three deniers, and struck with a punchon of a fleur-de-lis, to make it current for 15 deniers. Soon after the old sols were coined over again, and both old and new were indifferently made current for 15 deniers. In 1729, the value of the same sol was raised to 18 deniers. Towards the latter end of the reign of Louis XIV. the sol of 18 deniers was again lowered to 15; and by the late king it was reduced to the original value of 12. What it is at present posterity may perhaps discover.

The Dutch have also two kinds of sols: the one of silver, called *sols de gros*, and likewise *sejelling*; the other of copper, called also the *stuiver*.

SOL, the *Sun*, in *Astronomy, Astrology*, &c. See ASTRONOMY, *partim*.

SOL, in *Chemistry*, is gold; thus called from an opinion that this metal is in a particular manner under the influence of the sun.

SOL, in *Heraldry*, denotes Or, the golden colour in the arms of sovereign princes.

SOLÆUS, or SOLLES, in *Anatomy*, one of the extensor muscles of the foot, rising from the upper and hinder parts of the tibia and fibula.

SOLAN-GOOSE. See PELICANS, ORNITHOLOGY *Indev.*

SOLANDRA, a genus of plants belonging to the class of monadelphia, and to the order of polyandria; and in the natural system arranged under the 38th order, *Tricoccoea*. See BOTANY *Index*.

SOLANUM, a genus of the monogynia order, belonging to the pentandria class of plants; and in the natural method ranking under the 28th order, *Luridae*. See BOTANY *Index*.

SOLAR, something belonging to the SUN.

SOLAR-Spots. See ASTRONOMY *Index*.

SOLDAN. See SULTAN.

SOLDANELLA, a genus of plants belonging to the class of pentandria, and order of monogynia; and in the natural system arranged under the 21st order, *Precie*. See BOTANY *Index*.

SOLDER, SODDER, or *Soder*, a metallic or mineral composition used in soldering or joining together other metals.

Solders are made of gold, silver, copper, tin, bismuth, and lead; usually observing, that in the composition there be some of the metal that is to be soldered mixed with some higher and finer metals. Goldsmiths usually make four kinds of solder, viz. folder of eight, where to seven parts of silver there is one of brass or copper; folder of six, where only a sixth part is copper; folder of four, and folder of three. It is the mixture of copper in the folder that makes raised plate come always cheaper than flat.

As mixtures of gold with a little copper are found to melt with less heat than pure gold itself, these mixtures serve as folders for gold: two pieces of fine gold are soldered by gold that has a small admixture of copper; and gold alloyed with copper is soldered by such as is alloyed with more copper: the workmen add a little silver as well as copper, and vary the proportions of the two to one another, so as to make the colour of the folder correspond as nearly as may be to that of the piece. A mixture of gold and copper is also a folder for fine copper as well as for fine gold. Gold being particularly disposed to unite with iron, proves an excellent folder for the finer kinds of iron and steel instruments.

The folder used by plumbers is made of two pounds of lead to one of block-tin. Its goodness is tried by melting it, and pouring the business of a crown-piece on a table; for, if good, there will arise little bright shining stars therein. The folder for copper is made like that of the plumbers; only with copper and tin; and for very nice works, instead of tin, they sometimes use a quantity of silver. Solder for tin is made of two thirds of tin and one of lead, or of equal parts of each; but where the work is any thing delicate, as in organ-pipes, where the juncture is scarce discernible, it is made of one part of bismuth and three parts of pewter. The pewterers use a kind of folder made with two parts of tin and one of bismuth; this composition melts with the least heat of any of the folders.

Silver folder is that which is made of two parts of silver and one of brass, and used in soldering those metals. Spelter folder is made of one part of brass and two of spelter or zinc, and is used by the braziers and copper-smiths for soldering brass, copper, and iron. This folder is improved by adding to each ounce of it one pennyweight of silver; but as it does not melt without a considerable degree of heat, it cannot be used when

Solfaterra
Solfaterra

Thus from *fa* to *sol* is a tone, also from *sol* to *la*, and from *la* to *mi*, without distinguishing the greater or less tone; but from *la* to *fa*, also from *mi* to *fa*, is only a semitone. If then these be applied in this order, *fa, sol, la, fa, sol, la, mi, fa*, &c. they express the natural series from C; and if that be repeated to a second or third octave, we see by them how to express all the different orders of tones and semitones in the diatonic scale; and still above *mi* will stand, *fa, sol, la*, and below it the same inverted *la, sol, fa*, and one *mi* is always distant from another an octave; which cannot be said of any of the rest, because after *mi* ascending comes always *fa, sol, la*, which are repeated invertedly descending.

To conceive the use of this, it is to be remembered, that the first thing in learning to sing, is to make one raise a scale of notes by tones and semitones to an octave, and descend again by the same; and then to rise and fall by greater intervals at a leap, as thirds and fourths, &c. and to do all this by beginning at notes of different pitch. Then those notes are represented by lines and spaces, to which these syllables are applied, and the learners taught to name each line and space thereby, which makes what we call *solfing*; the use whereof is, that while they are learning to tune the degrees and intervals of sound expressed by notes on a line or space, or learning a song to which no words are applied, they may not only do it the better by means of articulate sounds, but chiefly that by knowing the degrees and intervals expressed by those syllables, they may more readily know the places of the semitones, and the true distance of the notes. See the article SIXTEEN.

SOLFATERRA, a mountain of Italy in the kingdom of Naples, and Terra di Lavoro. This mountain appears evidently to have been a volcano in ancient times; and the soil is yet so hot, that the workmen employed there in making alum need nothing else besides the heat of the ground for evaporating their liquors. Of this mountain we have the following account by Sir William Hamilton. "Near Astruni (another mountain, formerly a volcano likewise) rises the Solfaterra, which not only retains its cone and crater, but much of its former heat. In the plain within the crater, smoke issues from many parts, as also from its sides: here, by means of stones and tiles heaped over the crevices, through which the smoke passes, they collect in an awkward manner what they call *sale armoniaco*; and from the sand of the plain they extract sulphur and alum. This spot, well attended to, might certainly produce a good revenue, whereas I doubt if they have hitherto ever cleared 200*l.* a-year by it. The hollow found produced by throwing a heavy stone on the plain of the crater of the Solfaterra, seems to indicate that it is supported by a sort of arched natural vault; and one is induced to think that there is a pool of water beneath this vault (which boils by the heat of a subterraneous fire still deeper), by the very moist steam that issues from the cracks in the plain of the Solfaterra,

which, like that of boiling water, runs off a sword or Solfaterra knife, presented to it, in great drops. On the outside, and at the foot of the cone of the Solfaterra, towards the lake of Agnano, water rushes out of the rocks so hot as to raise the quicksilver in Fahrenheit's thermometer to the degree of boiling water (A); a fact of which I was myself an eye-witness. This place, well worthy the observation of the curious, has been taken little notice of; it is called the *Pisciarelli*. The common people of Naples have great faith in the efficacy of this water; and make much of it in all cutaneous disorders, as well as for another disorder that prevails here. It seems to be impregnated chiefly with sulphur and alum. When you approach your ear to the rocks of the Pisciarelli, from whence this water oozes, you hear a horrid boiling noise, which seems to proceed from the huge cauldron that may be supposed to be under the plain of the Solfaterra. On the other side of the Solfaterra, next the sea, there is a rock which has communicated with the sea, till part of it was cut away to make the road to Puzzole; this was undoubtedly a considerable lava, that ran from the Solfaterra when it was an active volcano. Under this rock of lava, which is more than 75 feet high, there is a stratum of pumice and ashes. This ancient lava is about a quarter of a mile broad; you meet with it abruptly before you come in sight of Puzzole, and it finishes as abruptly within about 100 paces of the town. The ancient name of the Solfaterra was *Forum Vulcani*; a strong proof of its origin from subterraneous fire. The degree of heat that the Solfaterra has preserved for so many ages, seems to have calcined the stones upon its cone and in its crater, as they are very white and crumble easily in the hottest parts.

SOLICITOR, a person employed to take care of and manage suits depending in the courts of law or equity. Solicitors are within the statute to be sworn, and admitted by the judges, before they are allowed to practise in our courts, in like manner as attorneys.

There is also a great officer of the law, next to the attorney-general, who is styled the king's solicitor-general; who holds his office by patent during the king's pleasure, has the care and concern of managing the king's affairs, and has fees for pleading, besides other fees arising by patents, &c. He attends on the privy-council; and the attorney-general and he were anciently reckoned among the officers of the exchequer; they have their audience, and come within the bar in all other courts.

SOLID, in *Philosophy*, a body whose parts are so firmly connected together, as not easily to give way or slip from each other; in which sense *solid* stands opposed to *fluid*.

Geometricians define a solid to be the third species of magnitude, or that which has three dimensions, viz. length, breadth, and thickness or depth.

Solids are commonly divided into regular and irregular. The regular solids are those terminated by regular

(A) "I have remarked, that after a great fall of rain, the degree of heat in this water is much less; which will account for what Padre Torre says (in his book, intitled *Histoire et Phenomenes du Vesuvius*), that when he tried it in company with Monsieur de la Condamine, the degree of heat, upon Beaumou's thermometer, was 68°.

Solid
||
Soliman.Soliman
||
Suis.

and equal planes, and are only five in number, viz. the tetrahedron, which consists of four equal triangles; the cube or hexahedron, of six equal figures; the octahedron, of eight equal triangles; the dodecahedron, of twelve; and the icosahedron, of twenty equal triangles.

The irregular solids are almost infinite, comprehending all such as do not come under the definition of regular solids; as the sphere, cylinder, cone, parallelogram, prism, parallelepiped, &c.

SOLIDS, in *Anatomy*, are the bones, ligaments, membranes, muscles, nerves and vessels, &c.

The solid parts of the body, though equally composed of vessels, are different with regard to their consistence; some being hard and others soft. The hard, as the bones and cartilages, give firmness and attitude to the body, and sustain the other parts: the soft parts, either alone or together with the hard, serve to execute the animal functions. See *ANATOMY*.

SOLIDAGO, a genus of plants belonging to the class of *Juncagosa*, and to the order of *polygamia superflua*; and in the natural system ranging under the 49th order, *Compositae*. See *BOTANY Index*.

SOLIDITY, that property of matter, or body, by which it excludes all other bodies from the place which itself possesses; and as it would be absurd to suppose that two bodies could possess one and the same place at the same time, it follows, that the solid bodies are equally solid with the hardest. See *METAPHYSICS*, N^o 44. 173, &c.

Among geometers, the solidity of a body denotes the quantity of space contained in it, and is called also its solid content.

The solidity of a cube, prism, cylinder, or parallelepiped, is had by multiplying its basis into its height. The solidity of a pyramid or cone is had by multiplying either the whole base into a third part of the height, or the whole height into a third part of the base.

SOLILOQUY, a reasoning or discourse which a man holds with himself; or, more properly, according to Papias, it is a discourse by way of answer to a question that a man proposes to himself.

Soliloquies are become very common on the modern stage; yet nothing can be more inartificial, or more unnatural, than an actor's making long speeches to himself, to convey his intentions to the audience. Where such discourses are necessary to be made, the poets should rather take care to give the dramatic persons such confidants as may necessarily share their inmost thoughts; by which means they will be more naturally conveyed to the audience; yet even this is a shift which an accurate poet would not have occasion for. The following lines of the duke of Buckingham concerning the use and abuse of soliloquies deserve attention:

Soliloquies had need be very few,
Extremely short, and spoke in passion too.
Our lovers talking to themselves, for want
Of others, make the pit their confidant:
Nor is the matter mended yet, if thus
They trust a friend, only to tell it us.

SOLIMAN II. emperor of the Turks, surnamed the *Magnificent*, was the only son of Selim I. whom he succeeded in 1520. He was educated in a manner very different from the Ottoman princes in general; for he

was instructed in the maxims of politics and the secrets of government. He began his reign by restoring those periods their possessions whom his father had unjustly plundered. He re-established the authority of the tribunals, which was almost annihilated, and bestowed the government of provinces upon none but persons of wealth and probity: "I would have my viceroys (he used to say) resemble those rivers that fertilize the fields through which they pass, not those torrents which sweep every thing before them."

After concluding a truce with Ismael Sophy of Persia, and subduing Gozeli Bey, who had raised a rebellion in Syria, he turned his arms against Europe. Belgrade was taken in 1521, and Rhodes fell into his hands the year following, after an obstinate and enthusiastic defence. In 1526 he defeated and slew the king of Hungary in the famous battle of Mohatz. Three years after he conquered Buda, and immediately laid siege to Vienna itself. But after continuing 20 days before that city, and assaulting it 20 times, he was obliged to retreat with the loss of 80,000 men. Some time after he was defeated by the Persians, and disappointed in his hopes of taking Malta. He succeeded, however, in dispossessing the Genoese of Chio, an island which had belonged to that republic for more than 200 years.

He died at the age of 76, while he was besieging Sigeth, a town in Hungary, on the 30th August 1566.

He was a prince of the strictest probity, a lover of justice, and vigorous in the execution of it; but he tarnished all his glory by the cruelty of his disposition. After the battle of Mohatz he ordered 1500 prisoners, most of them gentlemen, to be ranged in a circle, and beheaded in presence of his whole army.

Soliman thought nothing impossible which he commanded: A general having received orders to throw a bridge over the *Draue*, wrote him, that it was impossible. The sultan sent him a long band of linen with these words written on it: "The emperor Soliman, thy master, orders thee to build a bridge over the *Draue* in spite of the difficulties thou mayest meet with. He informs thee at the same time, that if the bridge be not finished upon his arrival, he will hang thee with the very linen which informs thee of his will."

SOLIPUGA, or **SOLIPUGA**, in *Natural History*, the name given by the Romans to a small venomous insect of the spider-kind, called by the Greeks *hellecetrus*; both words signifying an animal which stings most in the country and seasons where the sun is most hot. Solinus makes this creature peculiar to Sardinia; but this is contrary to all the accounts given us by the ancients. It is common in Africa and some parts of Europe. Almost all the hot countries produce this venomous little creature. It lies under the sand to seize other insects as they go by; and if it meet with any uncovered part of a man, produces a wound which proves very painful; it is said that the bite is absolutely mortal, but probably this is not true. Solinus writes the word *solipuga*, and so do many others, erroneously deriving the name from the notion that this animal flies from the sun's rays, and buries itself in the sand.

SOLIS, ANTONIO DE, an ingenious Spanish writer, of an eminent and illustrious family, born at Alcala an Old Castle, in 1615. He was intended for the law; but his inclination toward poetry prevailed, and he cultivated it with great success. Philip IV. of Spain

made him one of his secretaries; and after his death the queen-regent appointed him historiographer of the Indies, a place of great profit and honour: his History of the Conquest of Mexico shows that he could not have aimed a fitter person. He is better known by his history at least abroad, than by his poetry and dramatic writings, though in these he was also distinguished. He turned priest at 57 years of age, and died in 1686.

SOLITARY, that which is remote from the company or commerce of others of the same species.

SOLITARIES, a denomination of nuns of St Peter of Alcantara, instituted in 1676, the design of which was to imitate the severe penitent life of that saint. Thus they are to keep a continual silence, never to open their mouths to a stranger; to employ their time wholly in spiritual exercises, and leave their temporal concerns to a number of maids, who have a particular superior in a separate part of the monastery: they always go bare-footed, without fans; gird themselves with a thick cord, and wear no linen.

SOLO, in the Italian music, is frequently used in pieces consisting of several parts, to mark those that are to perform alone; as *fauto solo*, *violino solo*. It is also used for sonatas composed for one violin, one German flute, or other instrument, and a bass; thus we say, *Corelli's solos*, *Geminiani's solos*, &c. When two or three parts play or sing separately from the grand chorus, they are called *dui soli*, *a tre soli*, &c. Solo is sometimes denoted by S.

SOLOMON, the son of David king of Israel, renowned in Scripture for his wisdom, riches, and magnificent temple and other buildings. Towards the end of his life he fell all his former glory by his apostasy from God; from which cause vengeance was denounced against his house and nation. He died about 975 B. C.

SOLOMON'S Seal, a species of CONVALLARIA, which see, **BOTANY Index**.

SOLO, one of the seven wife men of Greece, was born at Salamis, of Athenian parents, who were descended from Codrus. His father leaving little patrimony, he had recourse to merchandize for his subsistence. He had, however, a greater thirst after knowledge and fame than after riches, and made his mercantile voyages subservient to the increase of his intellectual treasures. He very early cultivated the art of poetry, and applied himself to the study of moral and civil wisdom. When the Athenians, tired out with a long and troublesome war with the Megarensians, for the recovery of the isle of Salamis, prohibited any one, under pain of death, to propose the renewal of their claim to that isle, Solon thinking the prohibition dishonourable to the state, and finding many of the younger citizens desirous to revive the war, feigned himself mad, and took care to have the report of his insanity spread through the city. In the mean time he composed an elegy adapted to the state of public affairs, which he committed to memory. Every thing being thus prepared, he sallied forth into the market-place with the kind of cap on his head which was commonly worn by sick persons, and, ascending the herald's stand, he delivered, to a numerous crowd, his lamentation for the desertion of Salamis. The verses were heard with general applause: and Pisistratus seconded his advice, and urged the people to renew the war. The decree was immediately repealed;

the claim to Salamis was resumed; and the conduct of the war was committed to Solon and Pisistratus, who, by means of a stratagem, defeated the Megarensians, and recovered Salamis.

His popularity was extended through Greece in consequence of a successful alliance which he formed among the states in defence of the temple at Delphos against the Carians. When dissensions had arisen at Athens between the rich creditors and their poor debtors, Solon was created archon, with the united powers of supreme legislator and magistrate. He soon restored harmony between the rich and poor: He cancelled the debts which had proved the occasion of so much oppression; and ordained that in future no creditor should be allowed to seize the body of the debtor for his security: He made a new distribution of the people, instituted new courts of judicature, and framed a judicious code of laws, which afterwards became the basis of the laws of the twelve tables in Rome. Among his criminal laws are many wise and excellent regulations; but the code is necessarily defective with respect to those principles which must be derived from the knowledge of the true God, and of pure morality, as the certain foundations of national happiness. Two of them in particular were very exceptionable; the permission of a voluntary exile to persons that had been guilty of premeditated murder, and the appointment of a less severe punishment for a rape than for seduction. Those who wish to see accurately stated the comparative excellence of the laws of Moses, of Lycurgus, and Solon, may consult Puzos's Dissertations relative to Natural and Revealed Religion by Teyler's Theological Society, vol. ix.

The interview which Solon is said to have had with Croesus king of Lydia, the solid remarks of the sage after surveying the monarch's wealth, the recollection of those remarks by Croesus when doomed to die, and the noble conduct of Cyrus on that occasion, are known to every schoolboy. Solon died in the island of Cyprus, about the 80th year of his age. Statues were erected to his memory both at Athens and Salamis. His thirst after knowledge continued to the last: "I grow old (said he) learning many things." Among the apophthegms and precepts which have been ascribed to Solon, are the following: Laws are like cobwebs, that entangle the weak, but are broken through by the strong. He who has learned to obey, will know how to command. In all things let reason be your guide. Diligently contemplate excellent things. In every thing that you do, consider the end.

SOLSTICE, in *Astronomy*, that time when the sun is in one of the solstitial points; that is, when he is at his greatest distance from the equator; thus called because he then appears to stand still, and not to change his distance from the equator for some time; an appearance owing to the obliquity of our sphere, and which those living under the equator are strangers to.

The solstices are two in each year; the vernal or summer solstice, and the hyemal or winter solstice. The former solstice is when the sun seems to describe the tropic of cancer, which is on June 22, when he makes the longest day: the winter solstice is when the sun enters the first degree, or seems to describe the tropic of capricorn, which is on December 22, when he makes the shortest day. This is to be understood as in our northern hemisphere; for in the southern, the sun's en-

Solstice
of
Somers.

trance into capricorn makes the summer solstice, and that into cancer the winter solstice. The two points of the celtic, when the sun's greatest ascent above the equator, and his descent below it, are terminated, are called the *solstitial points*; and a circle, supposed to pass through the poles of the world and these points, is called the *solstitial colure*. The summer solstitial point is in the beginning of the first degree of cancer; and is called the *solstitial or summer point*; and the winter solstitial point is in the beginning of the first degree of capricorn, and is called the *winter point*. These two points are diametrically opposite to each other.

SOLUTION, in *Chemistry*, denotes an intimate union of solid with fluid bodies, so as to form a transparent liquor. See *CHEMISTRY* *passim*.

SOLVENT, that which dissolves a solid body into a transparent fluid.

SOLWAY MOSS. See *Moving Moss*.

SOMBRIERO, the name of an uninhabited island in the West Indies in the form of an hat, whence the name is derived. It is also the name of one of the Nicobar islands in the East Indies.

Wonderful Plant of SOMBEREBO, is a strange kind of sensitive plant growing in the East Indies, in sandy bays and in shallow water. It appears like a tender straight stick; but when you attempt to touch it, immediately withdraws itself into the sand. Mr Miller gives an account of it in his description of Sumatra. He says, the Malays call it *hulan lont*, that is, sea grass. He never could observe any tentacula; but, after many unsuccessful attempts, drew out a broken piece about a foot long. It was perfectly straight and uniform, and resembled a worm drawn over a knitting needle. When dry it appears like a coral.

SOMERS, JOHN, lord high chancellor of England, was born at Worcester in 1652. He was educated at Oxford, and afterwards entered himself at the Middle Temple, where he studied the law with great vigour. In 1688 he was one of the counsel for the seven bishops at their trial, and argued with great learning and eloquence against the dispensing power. In the convention which met by the prince of Orange's summons, January 22, 1689, he represented Worcester; and was one of the managers for the House of Commons, at a conference with the House of Lords upon the word *abdicated*. Soon after the accession of King William and Queen Mary to the throne, he was appointed solicitor-general, and received the honour of knighthood. In 1692 he was made attorney general, and in 1693 advanced to the post of lord keeper of the great seal of England. In 1693 he proposed an expedient to prevent the practice of clipping the coin. In 1697 he was created lord Somers, baron of Evesham, and made lord high chancellor of England. In the beginning of 1702 he was removed from his post of lord chancellor, and the year after was impeached of high crimes and misdemeanors by the House of Commons, of which he was acquitted upon trial by the House of Lords. He then retired to a studious course of life, and was chosen president of the Royal Society. In 1726 he proposed a bill for the regulation of the law; and the same year was one of the principal managers for the union between England and Scotland. In 1728 he was made lord president of the council: from which post he was removed in 1729, upon the change of the ministry. In the latter end of

Somers
of
Somerset.

Queen Anne's reign his lordship grew very infirm in his health; which is supposed to be the reason that he held no other post than a seat at the council-table, after the accession of King George I. He died of an apoplectic fit in 1716. Mr Addison has drawn his character very beautifully in the *Freeholder*.

SOMERSETSHIRE, a county of England, taking its name from Somerset, once the capital, between 50° and 51° 27' north latitude, and between 1° 23' and 2° 59' west longitude. It is bounded on the west by Devonshire, on the south by Dorsetshire, on the north by Bristol channel or the Severn sea, on the north east by a small part of Gloucestershire, and on the east by Wiltshire. It is one of the largest counties in England, extending in length from east to west about 68 miles; in breadth, where broadest, from south to north, about 47; and 240 in circumference. It is divided into 42 hundreds, in which are 3 cities, 32 market-towns, 1700 villages, 383 parishes of which 132 are vicarages, containing more than 1,000,000 of acres, and about 273,750 souls. It sends 18 members to parliament, viz. two for the county, two for Bristol, two for Bath, two for Wells, two for Taunton, two for Bridgewater, two for Ilchester, two for Milbourn-port, and two for Minehead.

The air of this county is very mild and wholesome, especially that of the hilly part. The soil in general is exceeding rich, so that single acres very commonly produce forty or fifty bushels of wheat, and there have been instances of some producing fifty of barley. As there is very fine pasture both for sheep and black cattle, it abounds in both, which are as large as those of Lincolnshire, and their flesh of a finer grain. In consequence of this abundance of black cattle, great quantities of cheese are made in it, of which that of Cheddar is thought equal to Parmesan. In the hilly parts are found coal, lead, copper, and lapis calaminaris. Wool thrives in it as well as in any county of the kingdom. It abounds also in pease, beans, beer, cyder, fruit, wild-fowl, and salmon; and its mineral waters are celebrated all over the world.

The riches of this county, both natural and acquired, exceed those of any other in the kingdom, Middlesex and Yorkshire excepted. The woollen manufacture in all its branches is carried on to a very great extent; and in some parts of the county great quantities of linen are made. If to these the produce of various other commodities in which it abounds is added, the amount of the whole must undoubtedly be very great. Its foreign trade must also be allowed to be very extensive, when it is considered that it has a large trade for sea-coal, and poissides, besides other ports, that of Bristol, a town of the greatest trade in England, next to London.

Besides small streams, it is well watered and supplied with fish by the rivers Severn, Avon, Parrel, Frome, Ax, Torre, and Tone. Its greatest hills are Mendips, Pouldon, and Quantock, of which the first abounds in coal, lead, &c. The rivers Severn and Parrel breed very fine salmon. The chief town is Bristol.

SOMERTON, an ancient town in Somersetshire, from whence the county derives its name. It is 123 miles from London; it has five streets, containing 257 houses, which are mostly built of the blue stone from the quarries in the neighbourhood. It is governed by countables, and has a hall for petty sessions. The man-

SOMMAM
built
d
SONCHUS.

ket for corn is considerable, and it has several fairs for cattle. The church has, what is not very frequent, an *angular* tower with six bells. N. Lat. 51. 4. W. Long. 1. 33.

SOMNAMBULI, persons who walk in their sleep. See SLEEPWALKERS.

SOMNER, WILLIAM, an eminent English antiquary, was born at Canterbury in 1626. His first treatise was *The Antiquities of Canterbury*, which he dedicated to Archbishop Laud. He then applied himself to the study of the Saxon language; and having made himself master of it, he perceived that the old glossary prefixed to Sir Roger Twissden's edition of the laws of King Henry I. printed in 1644, was faulty in many places; he therefore added to that edition notes and observations valuable for their learning, with a very useful glossary. His *Treatise of Gavelkind* was finished about 1648, though not published till 1665. Our author was zealously attached to King Charles I. and in 1648 he published a poem on his sufferings and death. His skill in the Saxon tongue led him to inquire into most of the European languages ancient and modern. He assisted Dugdale and Dodsworth in compiling the *Monasticon Anglicanum*. His *Saxon Dictionary* was printed at Oxford in 1659. He died in 1669.

SON, an appellation given to a male child considered in the relation he bears to his parents. See PARENT and FILLIAL Piety.

SONATA, in *Music*, a piece or composition, intended to be performed by instruments only; in which sense it stands opposed to *cantata*, or a piece designed for the voice. See CANTATA.

The sonata then, is properly a grand, free, humorous composition, diversified with a great variety of motions and expressions, extraordinary and bold strokes, figures, &c. And all this purely according to the fancy of the composer; who, without confining himself to any general rules of counterpoint, or to any fixed number or measure, gives a loose to his genius, and runs from one mode, measure, &c. to another, as he thinks fit. This species of composition had its rise about the middle of the 17th century; those who have most excelled in it were Bassani and Corelli. We have sonatas of 1, 2, 3, 4, 5, 6, 7, and even 8 parts, but usually they are performed by a single violin, or with two violins, and a thorough bass for the harpsichord; and frequently a more figured bass for the bass viol, &c.

There are a thousand different species of sonatas; but the Italians usually reduce them to two kinds. *Sonate da chiesa*, that is, sonatas proper for church music, which usually begin with a grave solemn motion, suitable to the dignity and sanctity of the place and the service, after which they strike into a brisker, gay, and richer manner. These are what they more peculiarly call sonatas. *Sonate da camera*, or sonatas for the chamber, are properly series of several little pieces, for dancing, only composed to the same tune. They usually begin with a prelude or little sonata, serving as an introduction to all the rest; afterwards come the allemand, pavane, courant, and other serious dances; the jig, gavots, minnets, chuecons, passevolles, and other gay airs: the whole composed in the same tune or mode.

SONCHUS, SOW-THISTLE, in *Botany*, a genus of

plants belonging to the class of *syngenesia*, and to the order of *polygamia aequalis*; and in the natural system ranged under the 49th order, *Compositæ*. The receptacle is naked; the calyx is imbricated, belying and conical; the down of the seed is simple, sessile, and very soft; the seed is oval and pointed. There are 13 species; the maritimus, palustris, fruticosus, arvensis, oleaceus, tenerimus, piumieri, alpinus, floridanus, fibricus, tataricus, tuberosus, and canadensis. Four of these are natives of Britain.—1. *Paltifris*, marsh sow-thistle. The stem is erect, from six to ten feet high, branched and hairy towards the top; the leaves are firm, broad, half pinnated, serrated, and sharp-pointed; the lower ones sagittate at the base: the flowers are of a deep yellow, large, and dispersed on the tops of the branches: the calyx is rough. It is frequent in marshes, and flowers in July or August.—2. *Arvensis*, corn sow-thistle. The leaves are alternate, runcinate, and heart-shaped at the base; the root creeps under ground; the stem is three or four feet high, and branched at the top. It grows in corn-fields, and flowers in August.—3. *Oleaceus*, common sow-thistle. The stalk is succulent, pitular, and a cubit high or more; the leaves are broad, embracing the stem, generally deeply sinuated, smooth, or prickly at the edges; the flowers are of a pale yellow, numerous, in a kind of umbel, and terminal; the calyx is smooth. It is frequent in waste places and cultivated grounds.—4. *Alpinus*, blue-flowered sow-thistle. The stem is erect, purplish, branched, or simple, from three to six feet high: the leaves are large, smooth, and sinuated; the extreme segment large and triangular; the flowers are blue, and grow on hairy viscid pedicles, in long spikes: the calyx is brown. This species is found in Northumberland.

SONG, in *Poetry*, a little composition, consisting of easy and natural verses, set to a tune in order to be sung. See POETRY, N^o 120.

SONG, in *Music*, is applied in general to a single piece of music, whether contrived for the voice or an instrument. See AIR.

SONG of Birds, is defined by the honourable Daines Barrington to be a succession of three or more different notes, which are continued without interruption, during the same interval, with a musical bar of four crotchets in an adagio movement, or whilst a pendulum swings four seconds.

It is affirmed, that the notes of birds are no more innate than language in man, and that they depend upon imitation, as far as their organs will enable them to imitate the sounds which they have frequent opportunities of hearing; and their adhering so steadily, even in a wild state, to the same song, is owing to the nestlings attending only to the instruction of the parent bird, whilst they disregard the notes of all others that may perhaps be singing round them.

Birds in a wild state do not commonly sing above 10 weeks in the year, whereas birds that have plenty of food in a cage sing the greatest part of the year; and we may add, that the female of no species of birds ever sings. This is a wise provision of nature, because her song would discover her nest. In the same manner, we may rationally account for her inferiority in plumage. The faculty of singing is confined to the cock birds; and accordingly Mr Hunter, in dissecting birds of several species, found the muscles of the larynx to be stronger

SONCHUS
Song.

Song.

stronger in the nightingale than in any other bird of the same size; and in all those instances, where he differed both cock and hen, the same muscles were stronger in the cock. To the same purpose, it is an observation as ancient as the time of Pliny, that a capon does not crow.

Some have ascribed the singing of the cock-bird in the spring solely to the motive of pleasing his mate during incubation; others, who allow that it is partly for this end, believe it is partly owing also to another cause, viz. the great abundance of plants and insects in the spring, which, as well as seeds, are the proper food of singing birds at that time of the year.

Mr Barrington remarks, that there is no influence of any singing bird which exceeds our blackbird in any size; and this, he supposes, may arise from the difficulty of its concealing itself, if it called the attention of its enemies, not only by its bulk, but by the proportionable loudness of its notes. This writer farther observes, that some passages of the song in a few kinds of birds correspond with the intervals of our musical scale, of which the cuckoo is a striking and known instance; but the greater part of their song cannot be reduced to a musical scale; partly, because the rapidity is often so great, and it is also so uncertain when they may stop, that we cannot reduce the passages to form a musical bar in any time whatsoever; partly also, because the pitch of most birds is considerably higher than the most shrill notes of those instruments which have the greatest compass; and principally, because the intervals used by birds are commonly so minute, that we cannot judge of them from the more gross intervals into which we divide our musical octave. This writer apprehends, that all birds sing in the same key; and in order to discover this key, he informs us, that the following notes have been observed in different birds, A, B flat, C, D, F, and G; and therefore E only is wanting to complete the scale: now these intervals, he says, can only be found in the key of F with a sharp third, or that of G with a flat third; and he supposes it to be the latter, because admitting that the first musical notes were learned from birds, those of the cuckoo, which have been most attended to, form a flat third, and most of our compositions are in a flat third, where music is simple, and consists merely of melody. As a farther evidence that birds sing always in the same key, it has been found by attending to a nightingale, as well as a robin which was educated under him, that the notes reducible to our intervals of the octave were always precisely the same.

Most people, who have not attended to the notes of birds, suppose, that every species sing exactly the same notes and passages: but this is by no means true; though it is admitted that there is a general resemblance. Thus the London bird catchers prefer the song of the Kentish goldfinches, and Essex chaffinches; and some of the nightingale fanciers prefer a Surrey bird to those of Mid-Here.

Of all singing birds, the song of the nightingale has been most universally admired; and its superiority (deemed from a caged bird) consists in the following particulars: its tone is much more mellow than that of any other bird, though at the same time, by a proper exertion of its musical power, it can be very brilliant. Another point of superiority is its continuance of song with-

out a pause, which is sometimes no less than 20 seconds; and when respiration becomes necessary, it takes it with as much judgment as an opera-singer. The sky-lark in this particular, as well as in compass and variety, is only second to the nightingale. The nightingale also sings (if the expression may be allowed) with superior judgment and taste. Mr Barrington has observed, that his nightingale, which was a very capital bird, began softly like the ancient orators, reserving its breath to swell certain notes, which by these means had a most astonishing effect. This writer adds, that the notes of birds, which are annually imported from Asia, Africa, and America, both singly and in concert, are not to be compared to those of European birds.

The following table, formed by Mr Barrington, agreeably to the idea of M. de Piles in estimating the merits of painters, is designed to exhibit the comparative merit of the British singing birds; in which 20 is supposed to be the point of absolute perfection.

	Artificial of time.	Spoken notes.	Paraphrase notes.	Complexity.	Location.
Nightingale	19	14	19	19	19
Sky-lark	4	19	4	18	18
Wood-lark	18	4	17	12	8
Tit-lark	12	12	12	12	12
Linnet	12	16	12	16	18
Goldfinch	4	19	4	12	12
Chaffinch	4	12	4	8	8
Greenfinch	4	4	4	4	4
Hedge-sparrow	6	0	6	4	6
Aberdaine or filkin	2	4	0	4	4
Red-poll	0	4	0	4	4
Thrush	4	4	4	4	4
Blackbird	4	4	0	2	2
Robin	6	16	12	12	14
Wren	0	12	0	4	2
Reed sparrow	0	4	0	2	2
Black cap, or Norfolk mock nightingale	14	12	12	14	14

From the
of the
admit-
vo. 11111.

SONNA, a book of Mahometan traditions, which the orthodox muslimans are required to believe.

SONNERATIA, a genus of plants belonging to the class of *scandaria*, and to the order of *monogynia*. See BOTANY Index.

SONNET, in Poetry, a composition contained in 11 verses, viz. two hexameters or menures of four verses each, and two of three, the first eight verses being all in three rhimes.

SONNITES, among the Mahometans, an appellation given to the orthodox muslimans or true believers; in opposition to the several heretical sects, particularly the Shiites, or followers of Ali.

SOOOU, or SOY. See DOLICHOS.

SOONABURDAR, in the East Indies: an attendant, who carries a silver bladder in his hand about two or three feet long, and runs before the palanquin. He is inferior to the chubdar; the property of an Indian navy requiring two soonaburdars or every chubdar in the train. The chubdar proclaims the approach of visitors, &c. He generally carries a large fl-

—Soot

Sophtin.

ver staff about five feet long in his hands; and among the Nabobs he proclaims their praises aloud as he runs before their palanquins.

SOOT, a volatile matter arising from wood and other fuel along with the smoke; or rather, it is the smoke itself condensed and gathered to the sides of the chimney. Though once volatile, however, soot cannot be again resolved into vapour; but, if distilled by a strong fire, yields a volatile alkali and empyreumatic oil, a considerable quantity of fixed matter remaining at the bottom of the distilling vessel. If burnt in an open fire, it flames with a thick smoke, whence other soot is produced. It is used as a material for making sal ammoniac, and as a manure. See *AMMONIA, muriate of, CHEMISTRY Index.*

Soot-Black. See *COLOUR-Making.*

SOPHI, or **SOPI**, a title given to the emperor of Persia, importing as much as wise, sage, or philosopher.

The title is by some said to have taken its rise from a young shepherd named *Sophi*, who attained to the crown of Persia in 1370; others derive it from the *sophoi* or sages anciently called *magi*. Vossius gives a different account of the word: *sophi* in Arabic, he observes, signifies *wisdom*; and he adds, that it was applied by the Turks out of derision to the kings of Persia ever since Ithmael's time; because, according to their scheme of religion, he is to wear no other covering on his head but an ordinary red woollen stuff; whence the Persians are also called *hesel-waschet*, q. d. *red-heads*. But Bochart assures us, that *sophi* in the original Persian language, signifies one that is pure in his religion, and who prefers the service of God in all things: and derives it from an order of religious called by the same name. The *sophis* value themselves on their illustrious extraction. They are descended in a right line from Houssien, second son of Ali, Mahomet's cousin, and Fatima, Mahomet's daughter.

SOPHIS, or **Sopises**, a kind of order of religious among the Mahometans in Persia, answering to what are otherwise called *derwises*, and among the Arabs and Indians *fajris*. Some will have them called *sophis* from a kind of coarse camlet which they wear, called *souf*, from the city Souf in Syria, where it is principally manufactured. The more eminent of these *sophis* are complimented with the title *Schick*, that is, *reverend*, much as in Romish countries the religious are called *reverend fathers*. Schick *Sophi*, who laid the foundation of the grandeur of the royal house of Persia, was the founder, or rather the restorer of this order: Ithmael, who conquered Persia, was himself a *sophi*, and greatly valued himself on his being so. He chose all the guards of his person from among the religious of this order; and would have all the great lords of his court *sophis*. The king of Persia is still grandmaster of the order; and the lords continue to enter into it, though it be now fallen under some contempt.

SOPHISM, in *Logic*, a specious argument having the appearance of truth, but leading to falsehood. Sophisms are reduced by Aristotle into eight classes, an arrangement so just and comprehensive, that it is equally proper in present as in former times. 1. *Ignoratio elenchi*, in which the *sophist* attempts to determine the question, while he does it only in appearance. Thus the question, "Whether the excess of wine be hurtful?" seems to be

Sophtin,
Sophtin.

determined by proving, that wine revives the spirits and gives a man courage; but the principal point is here kept out of sight; for still it may be hurtful to health, to fortune, and reputation. 2. *Peitio principii*, a begging of the question, or taking for granted that which remains to be proved, as if any one should undertake to prove that the soul is extended through all the parts of the body, because it resides in every member. This is affirming the same thing in different words. 3. Reasoning in a circle; as when the Roman Catholics prove the Scriptures to be the word of God by the authority of the church, and the authority of the church from the Scriptures. 4. *Non causa pro causa*, or the assigning of a false cause to any effect. Thus the supposed principle, that nature abhors a vacuum, was applied to explain the rising of water in a pump before Galileo discovered that it was owing to the pressure of the atmosphere. In this way the vulgar ascribe accidents to divine vengeance, and the heretics and infidelity of modern times are said to be owing to learning. 5. *Fallacia accidentis*, in which the *sophist* represents what is merely accidental as essential to the nature of the subject. This is nearly allied to the former, and is committed by the Mahometans and Roman Catholics. The Mahometans forbid wine, because it is sometimes the occasion of drunkenness and quarrels; and the Roman Catholics prohibit the reading of the Bible, because it has sometimes promoted heresies. 6. By deducing an universal assertion from what is true only in particular circumstances, and the reverse: thus some men argue, "transcribers have committed many errors in copying the Scriptures, therefore they are not to be depended on." 7. By asserting any thing in a compound sense which is only true in a divided sense; so when the Scriptures assure us, that the worst of sinners may be saved, it does not mean that they shall be saved while they remain sinners, but that if they repent they may be saved. 8. By an abuse of the ambiguity of words. Thus Mr Hume reasons in his Essay on Miracles: "Experience is our only guide in reasoning concerning matters of fact; now we know from experience, that the laws of nature are fixed and invariable. On the other hand, testimony is variable and often false; therefore since our evidence for the reality of miracles rests solely on testimony which is variable, and our evidence for the uniformity of the laws of nature is invariable, miracles are not to be believed." The *sophistry* of this reasoning depends on the ambiguity of the word *experience*, which in the first proposition signifies the maxims which we form from our own observation and reflection; in the second it is confounded with testimony; for it is by the testimony of others, as well as our own observation, that we learn whether the laws of nature are variable or invariable. The Essay on Miracles may be recommended to those who wish to see more examples of *sophistry*; as we believe most of the eight species of *sophisms* which we have mentioned are well illustrated by examples in that essay.

SOPHIST, an appellation assumed in the early periods of Grecian history by those who devoted their time to the study of science. This appellation appearing too arrogant to Pythagoras, he declined it, and wished to be called a *philosopher*; declaring that, though he could not consider himself as a wise man, he was indeed a lover of wisdom. True wisdom and modesty are

generally

Sophocles
Sophocles

generally united. The example of Pythagoras was followed by every man of eminence; while the name *σοφιστής* was retained only by those who with a pomp of words made a magnificent display of wisdom upon a very slight foundation of knowledge. Those men taught an artificial structure of language, and a false method of reasoning, by which, in argument, the worse might be made to appear the better reason (see *SOPHISTS*). In Athens they were long held in high repute, and supported, not only by contributions from their pupils, but by a regular salary from the state. They were among the bitterest enemies of the illustrious Socrates, because he embraced every opportunity of exposing to contempt and ridicule their vain pretensions to superior knowledge, and the pernicious influence of their doctrines upon the taste and morals of the Athenian youth.

SOPHISTICATIOn, the mixing of any thing with what is not genuine; a practice too common in the making up of medicines for sale; as also among vintners, distillers, and others, who are accused of sophisticating their wines, spirits, &c. By mixing with them cheaper and coarser materials; and in many cases the cheat is carried on so artfully as to deceive the best judges.

SOPHOCLES, the celebrated Greek tragic poet, the son of Sophilus an Athenian, was born at Colonus, and educated with great attention. Superior vigour and address in the exercises of the palestra, and skill in music, were the great accomplishments of young men in the states of Greece. In these, Sophocles excelled; nor was he less distinguished by the beauty of his person. He was also instructed in the nobles of all sciences, civil polity and religion: from the first of these he derived an unshaken love of his country, which he served in some embassies, and in high military command with Pericles; from the latter he was impressed with a pious reverence for the gods, manifested by the inviolable integrity of his life. But his studies were early devoted to the tragic muse; the spirit of *Echylus* lent a fire to his genius, and excited that noble emulation which led him to contend with, and sometimes to bear away the prize from, his great master. He wrote 43 tragedies, of which 7 only have escaped the ravages of time: and having testified his love of his country by refusing to leave it, though invited by many kings; and having enjoyed the uninterrupted esteem and affection of his fellow-citizens, which neither the gallant actions and sublime genius of *Echylus*, nor the tender spirit and philosophic virtue of *Euripides*, could secure to them, he died in the 91st year of his age, about 456 years before Christ. The burial place of his ancestors was at Decelia, which the *Lacedaemonians* had at that time seized; and by *Lysander*, the Spartan chief, permitted the Athenians to inter their deceased poet; and they paid him all the honours due to his love of his country, integrity of life, and high poetic excellence. *Echylus* had at once seized the highest *poet* of honour in the field of poetry, the true sublimity; to that eminence his claim could not be disputed. *Sophocles* had a noble elevation of mind, but tempered with so fine a taste, and so chastened a judgement, that he never passed the bounds of propriety. Under his conduct the tragic muse appeared with the chaste dignity of some noble matron at a religious solemnity; harmony is in her voice, and grace in all her motions. From him the

theatre received some additional embellishments; and the drama the introduction of a third speaker, which made it more active and interesting; but his distinguished excellence is in the judicious disposition of the fable, and to notice a connection and dependence of the parts on each other, that they all agree to make the event not only probable, but even necessary. This is peculiarly admirable in his "*Oedipus King of Thebes*;" and in this important point he is far superior to every other dramatic writer.

The ingratitude of the children of *Sophocles* is well known. They wished to become immediate masters of their father's possessions; and therefore tired of his long life, they accused him before the *Arcopagus* of infamy. The only defence the poet made was to read his tragedy of *Oedipus at Colonus*, which he had lately finished; and then he asked his judges, whether the author of such a performance could be taxed with infamy! The father upon this was acquitted, and the children returned home covered with shame and confusion. The five tragedies of *Sophocles* which still remain, together with the Greek *Scholia* which accompany them, have been translated into Latin by *Johnson*, and into English by *Dr Franklin* and *Mr Potter*.

SOPHORA, a genus of plants belonging to the class of *dicandria*, and to the order of *monogynia*; and in the natural system arranged under the 32d order, *Pentagynaceae*. See *BOTANY Index*.

SOPORIFIC, or **SOPORIFEROUS**, a medicine that produces sleep. Such are opium, Laudanum, the seed of poppies, &c. The word is formed from the Latin *Sopor* "sleep." The Greeks in place of it use the word *hypnotic*.

SORBONNE, or **SORBON**, the house or college of the faculty of theology established in the university of Paris. It was founded in 1252 by *St Louis*, or rather by *Robert de Sorbon* his confessor and almoner, first canon of Cambury, and afterwards of the church of Paris; who gave his own name to it, which he himself took from the village of Sorbon or Serbon, near Sens, where he was born. The foundation was laid in 1252; *Queen Blanche*, in the absence of her husband, furnishing him with a house which had formerly been the palace of *Julian* the apostate, of which some remains are still seen. Afterwards the king gave him all the houses he had in the same place, in exchange for some others. The college has been since magnificently rebuilt by the cardinal de *Richelieu*. The design of its institution was for the use of poor students in divinity. There are lodgings in it for 36 doctors, who are said to be of the *Society of the Sorbonne*; those admitted to it without being doctors, are said to be of the *hospitality of the Sorbonne*. Six regent doctors formerly held lectures every day for an hour and a half each; three in the morning, and three in the afternoon.

SORBONNE, is also used in general for the whole faculty of theology at Paris; as the assemblies of the whole body are held in the house of the Sorbonne; and the bachelors of the other houses of the faculty, as the house of *Nivarre*, &c. come thither to hold their *fortiannique*, or act for being admitted doct'rs in divinity.

SORBUS, **SERVICE-FREE**, a genus of plants belonging to the class of *dicandria*, and to the order of *trigynia*. See *BOTANY Index*.—The *aucuparia*, mountain-ash, quicken-tree, quick-beam, or roan-tree, rises with

Sophocles
Sophocles

Sorbus.
Sorcery.

a straight upright stem and regular branching head, twenty or thirty feet high or more, covered with a smooth grayish brown bark; pinnated leaves of eight or ten pair of long, narrow, serrated folioles, and an odd one, smooth on both sides; and large umbellate clusters of white flowers at the sides and ends of the branches, succeeded by clusters of fine red berries, ripe in autumn and winter. There is a variety with yellow striped leaves. This species grows wild in many parts of this island in mountainous places, woods, and hedge-rows, often growing to the size of timber; and is admitted into most ornamental plantations, for the beauty of its growth, foliage, flowers, and fruit; the latter, in particular, being produced in numerous red large bunches all over the tree, exhibit a fine appearance in autumn and winter, till devoured by the birds, especially the black-bird and thrush, which are so allured by this fruit as to flock from all parts and feed on it voraciously.—In the island of Jura the juice of the berries is employed as an acid for punch. It is probable that this tree was in high esteem with the Druids; for it is more abundant than any other tree in the neighbourhood of those Druidical circles of stones, so common in North Britain. It is still believed by some persons, that a branch of this tree can defend them from enchantment or witchcraft. Even the cattle are supposed to be preserved by it from danger. The dairy-maid drives them to the summer pastures with a rod of the roan-tree, and drives them home again with the same. In Strathpey, we are told, a hoop is made of the wood of this tree on the 1st of May, and all the sheep and lambs are made to pass through it.

The *domestica*, or cultivated service-tree, with eatable fruit, grows with an upright stem, branching 30 or 40 feet high or more, having a brownish bark, and the young shoots in summer covered with a mealy down; pinnated leaves of eight or ten pair of broadish deeply serrated lobes and an odd one, downy underneath; and large umbellate clusters of white flowers at the sides and ends of the branches, succeeded by bunches of large, fleshy, edible red fruit, of various shapes and sizes. This tree is a native of the southern warm parts of Europe, where its fruit is used at table as a desert, and it is cultivated here in many of our gardens, both as a fruit-tree and as an ornament to diversify hardy plantations.

SORCERY; or MAGIC; the power which some persons were formerly supposed to possess of commanding the devil and the infernal spirits by skill in charms and invocations, and of soothing them by fumigations. Sorcery is therefore to be distinguished from witchcraft; an art which was supposed to be practised, not by commanding evil spirits, but by compass with the devil. As an instance of the power of bad smells over demons or evil spirits, we may mention the flight of the evil spirit mentioned in Tobit into the remote parts of Egypt, produced, it is said, by the smell of the burnt liver of a Eel. Lilly informs us, that one Evans having raised a spirit at the request of Lord Bothwell and Sir Kenelm Digby, and requesting a fumigation, the spirit, vexed at the disappointment, pulled him without the circle, and carried him from his house in the Minories into a field near B. A. Cadeaway.

King James, in his *Demologia*, has given a very full account of the art of sorcery. "Two principal

Sorcery.

things (says he) cannot well in that errand be wanted: holy water (whereby the devil mocks the papists), and some present of a living thing unto him. There are likewise certain daies and houres that they observe in this purpose. These things being all ready and prepared, circles are made, triangular, quadrangular, round, double, or single, according to the forme of the apparition they crave. When the conjured spirit appears, which will not be while after many circumstances, long prayers, and much muttering and murmuring of the conjurers, like a papist priest dispatching a hunting masse—how soone, I say, he appears, if they have missed one jote of all their rites; or if any of their feete once llyd over the circle, through terror of his fearful apparition, he paie himself at that time, in his owne hand, of that due debt which they ought him, and otherwise would have delayed longer to have paid him: I mean, he carries them with him, body and soule." How the conjurers made triangular or quadrangular circles, his majesty has not informed us, nor does he seem to imagine there was any difficulty in the matter. We are therefore led to suppose, that he learned his mathematics from the same system as Dr Sacheverell, who, in one of his speeches or sermons, made use of the following simile: "They concur like parallel lines, meeting in one common centre."

Another mode of consulting spirits was by the beryl, by means of a speculator or seer; who, to have a complete sight, ought to be a pure virgin, a youth who had not known woman, or at least a person of irreproachable life and purity of manners. The method of such consultation is this: The conjuror having repeated the necessary charms and adjurations, with the litany or invocation peculiar to the spirits or angels he wishes to call (for every one has his particular form), the seer looks into a crystal or beryl, wherein he will see the answer, represented either by types or figures; and sometimes, though very rarely, will hear the angels or spirits speak articulately. Their pronunciation is, as Lilly says, like the Irish, much in the throat. Lilly describes one of these beryls or crystals. It was, he says, as large as an orange, set in silver, with a cross at the top, and round about engraved the names of the angels Raphael, Gabriel, and Uriel. A delineation of another is engraved in the frontispiece to Aubrey's *Miscellanies*.

These forerisers or magicians do not always employ their art to do mischief; but, on the contrary, frequently exert it to cure diseases inflicted by witches; to discover thieves; to recover stolen goods; to forestall future events, and the fate of absent friends. On this account they are frequently called *white witches*. See **MAGIC**, **WITCHCRAFT**, &c.

Our forefathers were strong believers when they enacted, by statute 33 Hen. VIII. c. 8. all witchcraft and sorcery to be felony without benefit of clergy; and again, by statute 1 Jac. I. c. 12. that all persons involving any evil spirit, or consulting, covenanting with, entertaining, employing, feeding, or rewarding any evil spirit; or taking up dead bodies from their graves to be used in any witchcraft, sorcery, charm, or enchantment; or killing or otherwise hurting any person by such infernal arts; should be guilty of felony without benefit of clergy, and suffer death. And if any person should attempt by sorcery to discover hidden treasures,

Sarcery
Il
Secret.

or to restore stolen goods, or to provoke unlawful love, or to hurt any man or beast, though the fame were not effected, he or she should suffer imprisonment and pillory for the first offence, and death for the second. These acts continued in force till lately, to the terror of all ancient females in the kingdom; and many poor wretches were sacrificed thereby to the prejudice of their neighbours and their own illusions, not a few having by some means or other confessed the fact at the gallows. But all executions for this dubious crime are now at an end; our legislature having at length followed the wise example of Louis XIV. in France, who thought proper by an edict to restrain the tribunals of justice from receiving informations of witchcraft. And accordingly it is with us enacted, by statute 9 Geo. II. c. 5. that no prosecution shall for the future be carried on against any person for conjuration, witchcraft, sorcery, or enchantment: But the misdemeanour of persons pretending to use witchcraft, tell fortunes, or discover stolen goods, by skill in the occult sciences, is still severely punished with a year's imprisonment, and standing four times in the pillory.

SOREX, the **SHREW**, a genus of animals belonging to the class of *mammalia*, and order of *feræ*. See *MAMMALIA Index*.

SORITES, in *Logic*, a species of reasoning in which a great number of propositions are so linked together, that the predicate of the one becomes continually the subject of the next following, till at last a conclusion is formed by bringing together the subject of the first proposition and the predicate of the last. Such was that merry argument of Themistocles, to prove that his little son under ten years old governed the whole world. Thus: *My son governs his mother; his mother me; I the Athenians; the Athenians the Greeks; Greece commands Europe; Europe the whole world; therefore my son commands the whole world.* See *LOGIC*, N^o 96, 97.

SORNING, in *Scots Law*. See *LAW*, N^o CLXXXI, 30.

SORREL, in *Botany*, a species of the *RUMEX*, which grows in pastures and meadows, and is well known. The natives of England boil large quantities of the leaves in water, and mix the juice when cold with the milk of their rein-deer, which they esteem an agreeable and wholesome food. The Dutch are said to cultivate this plant for its usefulness in the dyeing of woollen cloths black; and we know that by means of the common broad-leaved sorrel an excellent black colour is, in many places of Scotland, given to woollen stuffs without the aid of coppers. As this mode of dyeing does not in the smallest degree injure the texture of the cloth, which continues to the last soft and silky, without that hardness to the touch which it acquires when dyed black by means of coppers, our readers will probably thank us for the following receipt, with which we have been favoured by a learned physician:

Let the stuff to be dyed be well washed with soap and water, and afterwards completely dried. Then of the common broad-leaved sorrel boil as much as shall be an acid decoction of sufficient quantity to let the stuff to be dyed lie in it open and easy to be stirred. The greater quantity of sorrel that is used, the better will the colour be; and therefore if the pot or cauldron will not hold enough at once, when part has been sufficiently boiled, it must be taken out and wrung, and a fresh

Sarcery
Il
Suttage.

quantity be boiled in the same juice or decoction. When the liquor is made sufficiently acid, strain it from the sorrel through a sieve, put the cloth or yarn into it, and let it boil for two hours, stirring it frequently. If stockings be among the stuff to be dyed, it will be expedient, after they have been an hour in the boiling liquor, to turn them inside out, and at the end of the second hour let the whole be poured into a tub or any other vessel. The pot or cauldron must then be washed, and water put into it, with half a pound of logwood chips for every pound of dry yarn or cloth. The logwood and water should boil slowly for four hours; and then the cloth or yarn being wrung from the four liquor, and put into the logwood decoction, the whole must be suffered to boil slowly for four hours, stockings, if there be any, being turned inside out at the end of two hours. Of this last decoction there must, as of the former, be enough to let the cloth lie open and easy to be stirred while boiling. At the end of the four hours the cloth must be taken out, and among the boiling liquor, first removed from the fire, must be poured a Scotch pint or half an English gallon of stale urine for every pound of dry cloth or other stuff to be dyed. When this compound liquor has been stirred and become cold, the cloth must be put into it and suffered to remain well covered for 12 hours, and then dried in the shade; after which, to divert it of smell or any other impurity, it may be washed in cold water, and dried for use.

Wood-SORREL. See *ONALIS*, *ESOTARY Index*.

SORREL-COLOUR, in the manege, is a reddish colour, generally thought to be a sign of a good horse.

SORRENTO, a sea-port town of the kingdom of Naples, with an archbishop's see. It is seated in a peninsula, on the bay of Naples, at the foot of a mountain of the same name, 17 miles south-east of Naples. It is the birth-place of Torquato Tasso. E. Long. 14. 24. N. Lat. 42. 36.

SORTILEGE, (*Sortilegium*) a species of divination performed by means of *fortes* or lots.

The *fortes Preternæ*, famous in antiquity, consisted in putting a number of letters, or even whole words, into an urn; and then, after shaking them together, they were thrown on the ground; and whatever sentences could be made out from them, constituted the answer of the oracle. To this method of divination succeeded that which has been called the *fortes Hæmerianæ* and *fortes Virgilianæ*, a mode of inquiring into futurity, which undoubtedly took its rise from a general custom of the oracular priests of delivering their answers in verse; it subsisted a long time among the Greeks and Romans; and being from them allowed by the Christians, it was not till after a long possession of centuries that it became exploded. Among the Romans it consisted in opening some celebrated poet at random, and among the Christians the Scriptures, and drawing, from the first passage which presented itself to the eye, a prognostic of what would befall one's self or others, or direction for conduct when under any emergency. There is good evidence that this was none of the vulgar errors; the greatest persons, philosophers of the best repute, admitted this superstition. Socrates, when in prison, hearing this line of Homer,

Within three days I Phœbi's store shall see,
Immediately said, within three days I shall be cut of the world;

world: gathering it from the double meaning of the word *Philia*, which in Greek is both the name of a country and signifies corruption or death. This prediction, addressed to Achilles, was not easily forgotten, as it was verified.

When this superstition passed from Paganism into Christianity, the Christians had two methods of consulting the divine will from the Scriptures; the one, usually, to open the divine writings, and take their direction, as above mentioned; the other, to go to church with a purpose of receiving, as a declaration of the will of heaven, the words of the Scripture, which were singing at the instant of one's entrance.

This unwarrantable practice of inquiring into futurity prevailed very generally in England till the beginning of the 18th century; and sometimes the books of Scripture, and sometimes the poems of Virgil, were consulted for oracular responses. One remarkable instance is that of King Charles I. who being at Oxford during the civil war, went one day to see the public library, where he was shown, among other books, a Virgil nobly printed and exquisitely bound. The lord Falkland, to divert the king, would have his majesty make a trial of his fortune by the *Sortes Virgilianae*. Whereupon the king opening the book, the passage which happened to come up was this:

*At bello audacis populi, vexatus et armis,
Finitus exoritur, conspectu avulsus Iuli.
Auxilium imploret; vadatque indigna iugum
Femora: nec, cum se, sub Igeis poenis iniquae
Tradiderat, regis aut optata luce fruatur;
Sed cadat ante dæm, mediæque inhumus arena.*
Æneid, lib. iv.

Yet let a race, untamed and haughty foes,
His peaceful entrance with dire arms oppose;
Oppressed with numbers in the unequal field,
His men discouraged, and himself expelled,
Let him for succour sue from place to place,
Torn from his subjects, and his foul's embrace:
First let him see his friends in battle slain,
And their untimely fate lament in vain;
And when at length the cruel war shall cease,
On hard conditions may he buy his peace,
Nor let him then enjoy supreme command,
But fall untimely by some hostile hand,
And lie unburied on the barren sand.

Lord Falkland observing that the king was concerned at this accident, would likewise try his own fortune in the same manner, hoping he might fall upon some passage that would have no relation to his case, and thereby divert the king's thoughts from any impression which the other might have upon him: but the place he stumbled upon was as much suited to his destiny as the other had been to the king's; being the lamentation of Evander for the untimely death of his son Pallas: for this lord's eldest son, a young man of an amiable character, had been slain in the first battle of Newbury.

We have ourselves known several whose devotion has not always been regulated by judgement prize this method of divination; and have generally observed, that the consequence has been despair or presumption. To such we beg leave to recommend one passage in Scrip-

ture which will never disappoint them: *Thou shalt not tempt the Lord thy God.*

SOIERIA, in antiquity, sacrifices offered to the gods for delivering a person from danger; as a sacred piece computed for the same purpose.

SOUBISE, a town of France, in the department of Lower Charente, and late territory of Saintonge. It is situated on the river Charente, 22 miles south of Rochelle, in W. Long. 1. 2. N. Lat. 45. 57.

SOUDAN, a kingdom of Africa, situated between 11° and 16° N. Lat. and 26° and 35° E. Long. See DAR FUR.

SOUGH, among miners, denotes a passage dug under ground, to convey off waters from mines. See MINE.

SOVEREIGN, in matters of government, is applied to the supreme magistrate or magistrates of an independent government or state; because their authority is only bounded by the laws of God and the laws of the state: such are kings, princes, &c. See PREROGATIVE, &c.

SOVEREIGN Power, or Sovereignty, is the power of making laws; for wherever that power resides, all others must conform to it, and be directed by it, whatever appearance the outward form and administration of the government may put on. For it is at any time in the option of the legislature to alter that form and administration by a new edict or rule, and to put the execution of the laws into whatever hands it pleases; and all the other powers of the state must obey the legislative power in the execution of their several functions, or else the constitution is at an end. In our constitution the law ascribes to the king the attribute of sovereignty; but that is to be understood in a qualified sense, i. e. as supreme magistrate, not as sole legislator; as the legislative power is vested in the king, lords, and commons, not in any of the three estates alone.

SOU. See SOR.

SOUFFRIERE, a small town, situated at the bottom of a bay, near the leeward extremity of the island of St. Lucia. Of itself it is not entitled to much notice, but the adjacent ground is very remarkable. The declivities of the surrounding hills are cultivated, and afford sugar-cane of a good quality.

The extremity of the fourth side of Souffriere bay runs into two steep hills of a conical shape, and nearly perpendicular, reckoned the highest on the island, and known by the appellation of the *Sugar-Loaf Hills*. It is impossible to ascend them; for although it was once attempted by two negroes, it is said that they never returned. Passing the hills to the windward of Souffriere, a fine level country presents itself, extending from 15 to 25 miles from the back of the Sugar-Loaf Hills along the sea coast, being wholly cultivated, and divided into rich estates. It is intersected by numerous rivers of very clear water, which, by art, are made subservient to the purpose of sugar-making. The rains here are less frequent than on any other part of the island, and the wind blows from the sea, or nearly so.

There is a volcano in the vicinity of this town. After passing one or two small hills, the smell of sulphur is sensibly felt before any vestige of the place is perceived. The first thing discerned is a rivulet of black running water, sending forth streams nearly in a state of ebullition, from which the volcano soon comes into view, situated

SOUND here is a hollow, and surrounded by hills on every side. There are many pits in the hollow, of a black and thick boiling matter, which appears to work with great force. Lava is ejected by flow degrees, and there is a large mass of it in the centre of the hollow, forming a fort of hill. The lava is said to be a sulphur mixed with calcareous earth and fine siliceous body. Small quantities of alum have been found in a perfect state; and there is a rivulet of good water in the opening, at the north side of the hollow. When the bottom of it is stirred, the water is very hot, so much so as not to be touched. The liquid running from the pits is strongly impregnated with sulphur, and very much resembles the preparation sold in the shops, called *aqua sulphurata*.

SOUL, the principle of perception, memory, intelligence, and volition, in man; which, since the earliest era of philosophy, has furnished questions of difficult investigation, and materials of keen and important controversy (see **METAPHYSICS**, Part III. chap. iii. iv. v.; and **RESURRECTION**, N° 22—48.). In the 4th volume of the Memoirs of the Literary and Philosophical Society of Manchester, the reader will find a very valuable paper by Dr Ferriar, proving, by evidence apparently complete, that every part of the brain has been injured without affecting the act of thought. An abridgement of that memoir would weaken its reasoning; which, built on matters of fact and experience, appears to us to have shaken the modern theory of the Materialists from its very foundation.

SOUL of Brutes. See **BRUTES**.

SOUND, in *Physics*, a term which expresses a simple idea; it is that primary information which we obtain of external things by means of the sense of hearing. See **ACOUSICS**.

SOUND, in *Geography*, denotes in general any Strait or inlet of the sea between two headlands. It is given by way of eminence to the Strait between Sweden and Denmark, joining the German ocean to the Baltic, being about three miles over. See **DENMARK**, N° 32. and **ELLSBORG**.

SOUND-Board, the principal part of an organ, and that which makes the whole machine play. It is a reservoir into which the wind, drawn in by the bellows, is conducted by a port vent, and thence distributed into the pipes placed over the holes of its upper part. The wind enters them by valves, which open by pressing on the keys, after the registers are drawn, by which the air is prevented from going into any of the other pipes, besides those in which it is required.

SOUND-Board also denotes a thin broad board placed over the head of a public speaker, to enlarge or extend and strengthen his voice.

Sound-boards are found by experience to be of no use in theatres, as their distance from the speaker is too great to be impressed with sufficient force. But sound-boards over a pulpit have frequently a good effect, when the case is constructed of a proper thickness, and according to particular principles.

SOUND-Piece, is a post placed in the inside of a violin, &c. as a prop between the back and belly of the instrument, and nearly under the bridge.

SOUNDING, the operation of trying the depth of the sea, and the nature of the bottom, by means of a plummet sunk from a ship to the bottom.

There are two plummet used for this purpose in navigation; one of which is called the *hand-lead*, weighing about 8 or 9 pounds; and the other the *deep-sea-lead*, which weighs from 25 to 30 pounds; and both are shaped like the frustum of a cone or pyramid. The former is used in shallow waters, and the latter at a great distance from the shore; particularly on approaching the land after a sea-voyage. Accordingly the lines employed for this purpose are called the *deep-sea-line*, and the *hand-lead-line*.

The hand lead-line, which is usually 20 fathoms in length, is marked at every two or three fathoms; so that the depth of the water may be ascertained either in the day or night. At the depth of two and three fathoms, there are marks of black leather; at 5 fathoms, there is a white rag; at 7, a red rag; at 10, black leather; at 12, black leather; at 15, a white rag; and at 17, a red ditto.

Sounding with the hand lead, which is called *heaving the lead* by seamen, is generally performed by a man who stands in the main-chains to windward. Having the line quite ready to run out without interruption, he holds it nearly at the distance of a fathom from the plummet; and having fowled the latter backwards and forwards three or four times, in order to acquire the greater velocity, he swings it round his head, and thence as far forward as is necessary; so that, by the lead's sinking whilst the ship advances, the line may be almost perpendicular when it reaches the bottom. The person sounding then proclaims the depth of the water in a kind of song resembling the cries of hawkers in a city. Thus if the mark of five fathoms is close to the surface of the water, he calls, 'By the mark five!' and as there is no mark at four, six, eight, &c. he estimates those numbers, and calls, 'By the dip four,' &c. If he judges it to be a quarter or an half more than any particular number, he calls, 'And a quarter five! and a half four,' &c. If he conceives the depth to be three quarters more than a particular number, he calls it a quarter less than the next; thus, at four fathoms and three fourths he calls 'A quarter less five!' and so on.

The deep sea lead is marked with two knots at 20 fathoms, three at 30, four at 40, and so on to the end. It is also marked with a single knot in the middle of each interval, as at 25, 35, 45 fathoms, &c. To use this lead more effectually at sea, or in deep water on the sea coast, it is usual previously to bring to the ship, in order to retard her course; the lead is then thrown as far as possible from the ship on the line of her drift, so that, as it sinks, the ship drives more perpendicularly over it. The pilot, feeling the lead strike the bottom, readily discovers the depth of the water by the mark on the line nearest its surface. The bottom of the lead being also well rubb'd over with tallow, retains the distinguishing marks of the bottom, as shells, ooze, gravel, &c. which naturally adhere to it.

The depth of the water, and the nature of the ground, which is called the *sounding*, are carefully marked in the log book, as well to determine the distance of the place from the shore, as to correct the observations of former pilots.

A machine for the same purpose has been invented by Mr Maffey, of which the following description is given:

"The importance of obtaining true soundings at sea is

be admitted by every seaman; and it is rather singular, that no other method than the common lead has hitherto been brought into use; as its imperfections are very generally acknowledged.

Many vessels have been lost, by depending upon the soundings taken in the usual way. The difficulty of obtaining the true perpendicular, and the uncertainty as to the exact moment when the lead strikes the bottom, upon which the accuracy of the result depends, must always prevent the possibility of obtaining the true depth, while the ship has any considerable way upon her. Indeed, it has been acknowledged by experienced seamen, during some experiments, made at various times, in the river Mersey, that they could not depend upon the common lead, when going five or six knots in the hour, in ten or twelve fathoms of water. When the depth is considerable, the vessel must be hoisted to, which is an operation attended with great loss of time, and sometimes considerable injury to the sails; and during a chase, this inconvenience must be particularly felt.

True soundings may be taken with this machine in thirty fathoms water, without the trouble of heaving the vessel to, although she may be going at the rate of six miles in the hour. True soundings may also thus be obtained in very deep water, where it is not possible to take them by the common lead.

Plate
CXXCVII.
Fig. 1.

Fig. 1. represents the founding machine. *a* is the founding weight, containing a regular, 1, 2, with two dials; the hand of the dial 1 makes one revolution when the weight has descended twenty fathoms, the other revolves once when the descent amounts to five hundred fathoms. A rotator, *b*, similar to that attached to the log, communicates with the wheel work of the dials 1, 2, by means of the rod *c*, on which there are three universal joints, 3, 4, and 5. This rod is supported during the descent of the weight, by the drop, *d*, at the end of which is a fork, 6, and a friction wheel, 7.

When the machine is to be used, a founding line is fastened to the ring, *e*; and one of the vanes of the rotator is slipped into the spring 8: the rotator will then be in the position indicated by the dotted lines, *x*. The indices must be set at 0, and the cover or lid, *f*, be shut. The machine must then be projected perpendicularly into the sea. As soon as it reaches the surface, the resistance of the water forces the dotted rotator, *x*, out of the spring 8, and it assumes its perpendicular direction as represented by the rotator *b*. As the machine descends, it is evident the rotator will revolve, and its motion be communicated freely past the friction wheel 7, and the universal joint 5, to the wheel work of the dials 1, 2, and thus indicate the space passed through in fathoms. When the machine has arrived at the bottom, the rotator, as it is no longer buoyed up by the reaction of the water, will fall to the bottom, quitting the fork of the drop *d*, which will also fall from its horizontal position, and in its descent, by means of the locking rod 9, prevent the rotator from revolving as the machine is drawn up. When at the bottom, the rotator will be in the position of the dotted lines *y*.

The machine, being in its construction, and scarcely more liable to accident than the common lead, accretions, with the utmost precision, the perpendicular depth, by the moment of descent through the water. No mistake can be made from that common cause of error, the drift or leeway of the ship during the time of descent;

nor does an operation of such importance depend upon the uncertain fermentation caused by the lead striking the bottom, on which the accuracy of the common log altogether depends, and which, it is well known, frequently and materially misleads the best seaman: for though a thousand fathoms of line were paid out, in the shallowest depth of water, no inaccuracy could arise, as the perpendicular depth, at the point of heaving, would be registered on the index. The only inconvenience experienced would be the additional labour necessary for hauling in the excess of line. The most inexperienced person may use this machine, without risk of error, in the most turbulent sea, and during the night.

The advantages already enumerated would render the founding machine of great importance; but there are other properties of still more consequence.

To heave a ship to, in order to obtain soundings, on a lee shore, in stormy weather, is a very disagreeable operation, attended with much trouble, and loss of way; also with considerable danger to the ship's sails; indeed, it would often, under such circumstances, be attended with great hazard to the safety of the ship. To avoid these unpleasant consequences, the master sometimes adopts a measure, which he conceives to be the less exceptionable alternative, by running on without sounding at all.

To prove how much inconvenience and danger are avoided by Massey's lead, it is enough to state, that soundings may be taken in depth from 60 to 80 fathoms, while the ship is under way, at the rate of three miles an hour; and as the rate of sailing may be still materially reduced, without entirely stopping the vessel, or altering her course, so, many soundings be had, to any depth required, while she is under way.

In order more clearly to show the superiority of this machine, and make it apparent, that the quantity of stay-line veered out does not at all affect the truth of the result: suppose the common lead thrown from the mizen chains of the ship, which may be represented by the point *a* of the triangle *abc*, (fig. 2.), and that the ship has moved forwards through the space equal to the line *bc*, while the lead has descended through the line *ac*; it is evident, that it is impossible, in this case, to ascertain the exact depth, as a quantity of line, equal to *ab*, would be paid out, whereas the true depth is equal only to the line *ac*, which is much less. But the case is very different when the patent founding machine is used, as the operation ceases when it has reached the bottom; not is the stay-line, *ab*, whatever its length, at all taken into the account.

It has been extremely difficult, and sometimes impossible, to obtain soundings in very deep water with the common lead, which may perhaps be thus accounted for. The common line which is used for sounding, though, if left to itself, it would sink in water, yet its descent would be much slower than that of the lead, separately; it consequently follows, that the lead must be so much impeded by curving the line with it, that when it does reach the bottom, there will be scarcely any sensible check to enable the seaman to know the precise moment. Indeed, if he can ascertain even this to a certainty, he still cannot depend upon the truth of his soundings; for if there be the least drift or current, the line itself will assume a curve, similar to that of the line of a kite in the air. These two causes will always operate

Sendings. Soup. rate against the perfection of the common mode of founding.

"After so fully describing the principle of the patent founding machine, it is scarcely necessary to prove, that is liable to neither of the foregoing objections; and it may be sufficient to say, that, as it will certainly find its way to the bottom, if a sufficient portion of straw-line be allowed to guard against its being checked in its progress, and the certainty of its having reached the bottom may be ascertained by the arming, there can be no doubt of the practicability of its obtaining foundings, in any depth, and no reasonable doubt of their correctness when obtained.

"From the construction of this machine, it might be imagined, that the rotator would impede its motion through the water, and that it could not descend so rapidly as the common lead; but during repeated trials, in thirteen fathoms water, in which the rotator was frequently detached, and the lead suffered to descend alone, there was no difference perceptible in the time of their descent, though an excellent quarter-second stop watch was used during the experiment, to detect any change. The following table shows how very uniformly the times of descent corresponded with the depths in fathoms, during a series of trials made on the river Mersey, with the patent lead, weighing 14 pounds.

"The manner of conducting these experiments was such as is deserving of perfect reliance. Two pilots, of well-known ability and experience, were employed: one threw the lead, and the other, the moment he found, by the slackening of the rope, that the weight had arrived at the bottom, cried 'stop,' to a third person who held the watch.

Time of descent.	Fathoms.	Time of descent.	Fathoms.
2 seconds	2½	7½ seconds	11½
2½	3	7½	11½
3	4	7½	11½
5	8	7½	12
5½	8½	7½	12½
6	10	8	13
6	10	8½	13½
7	11½	6	10

"Taken when under sail, at upwards of five knots in the hour.

"Several captains and masters in the navy have made trial of the log and founding machine, and given very favourable reports of their performance; and it has been adopted by order of the Navy Board in the British navy."

SOUP, a strong decoction of fish or other substances.

Portable or dry soup is a kind of cake formed by boiling the gelatinous parts of animal substances till the watery parts are evaporated. This species of soup is chiefly used at sea, and has been found of great advantage. The following receipt will show how it is prepared.

Of calves feet take 4; leg of beef 12 lbs.; knuckle of veal 3 lbs.; and leg of mutton 10 lbs. These are to be boiled in a sufficient quantity of water, and the foam taken off as usual; after which the fat is to be separated from the meat by straining and pressing. The

meat is then to be boiled a second time in other water; and the two decoctions, being added together, must be left to cool, in order that the fat may be exactly separated. The soup must then be clarified with five or six whites of eggs, and a sufficient quantity of common salt added. The liquor is then strained through flannel, and evaporated on the water-bath to the consistence of a very thick pale; after which it is spread rather thin upon a smooth stone, then cut into cakes, and hastily dried in a stove until it becomes brittle; these cakes are kept in well closed bottles. The same process may be used to make a portable soup of the flesh of poultry; and aromatic herbs may be used as a seasoning, if thought proper.

These tablets or cakes may be kept four or five years. When intended to be used, the quantity of half an ounce is put into a large glass of boiling water, which is to be covered, and let upon hot ashes for a quarter of an hour, or until the whole is entirely dissolved. It forms an excellent soup, and requires no addition but a small quantity of salt.

SOUR-CROUTE. See CROUTE.

SOUR-Gourd, or African Calabash-tree. See ADANSONIA, BOTANY Index.

SOUTH, DR ROBERT, an eminent divine, was the son of Mr William South a merchant of London, and was born at Hackney near that city in 1632. He studied at Westminster school, and afterwards in Christ-church college, Oxford. In 1654, he wrote a copy of Latin verses to congratulate Cromwell upon the peace concluded with the Dutch; and the next year a Latin poem, entitled *Missa Incomparans*. In 1665 he was elected public orator of the university; and the next year became domestic chaplain to Edward earl of Clarendon, lord-high chancellor of England. In 1665 he was installed prebendary of Westminster, admitted to the degree of doctor of divinity, and had a sinecure bestowed on him in Wales by his patron the earl of Clarendon; after whose retirement into France in 1667 he became chaplain to the duke of York. In 1670 he was installed canon of Christ church in Oxford; and in 1676 attended as chaplain to Laurence Hyde, Esq. ambassador extraordinary to the king of Poland. In 1678 he was presented to the rectory of Ilip in Oxfordshire; and in 1680 rebuilt the chancel of that church, as he afterwards did the rectory-house belonging to it. After the revolution he took the oath of allegiance to King William and Queen Mary, though he excused himself from accepting a great dignity in the church, vacated by the personal refusal of that oath. His health began to decline several years before his death, which happened in 1716. He was interred in Westminster Abbey, where a monument is erected to his memory. He published, 1. Animadversions on Dr Sherlock's Vindication of the Holy and Ever Blessed Trinity. 2. A Defence of his Animadversions. 3. Sermons, 8 vols 8vo. And after his decease were published his *Opera Posthuma Latina*, and his posthumous English works. Dr South was remarkable for his wit, which abounds in all his writings, and particularly in his sermons; but at the same time they equally abound in illumination, spleen, and satire. He was remarkable for being a time-server. During the life of Cromwell he was a dissenting Protestant, and then sided against the Independents; at the Restoration

Soup
||
South.

See N° 61.
Journal,
Vol. 25.

South
Southern.

tion he exerted his pulpit-eloquence against the Presbyterians; and in the reign of Queen Anne, was a warm advocate for Sacheverell.

SOUTH, one of the four cardinal points from which the winds blow.

SOUTH SEA, or PACIFIC OCEAN, is that vast body of water interposed between Asia and America. It does not, however, strictly speaking, reach quite to the continent of Asia, excepting to the northward of the peninsula of Malacca; for the water interposed between the eastern coast of Africa and the peninsula just mentioned has the name of the *Indian Ocean*. The South sea then is bounded on one side by the western coast of America, through its whole extent, from the unknown regions in the north to the straits of Magellan and Terra del Fuogo, where it communicates with the southern part of the Atlantic. On the other side, it is bounded by the coast of Asia, from the northern promontory of Tichukotkoi Nofs, to the peninsula of Malacca already mentioned. Thence it is bounded to the southward by the northern coasts of Borneo, Celebes, Moea, &c., New Guinea, New Holland, and the other islands in that quarter, which divide it from the Indian ocean. Then, walking the eastern coast of the great island of New Holland, it communicates with that vast body of water encompassing the whole southern part of the globe, and which has the general name of the *Southern ocean* all round. Thus does this vast ocean occupy almost the semicircumference of the globe, extending almost from one pole to the other, and about the equatorial parts extending almost 185° in longitude, or 12,500 of our miles.

The northern parts of the Pacific ocean are entirely destitute of land; not a single island having yet been discovered in it from the latitude of 45° north and upwards, excepting such as are very near the coast either of Asia or America; but in the southern part there are a great number.

Till very lately the South sea was in a great measure unknown. From the great extent of ice which covers the northern part of the globe, it was imagined that much more land existed there than in the northern regions; but that this could not be justly inferred merely from that circumstance, is plain from what has been advanced under the article AMERICA, N^o 3—24; and the southern continent, long known by the name of *Terra Australis*, has eluded the search of the most expert navigators sent out from Britain and France by royal authority. See TERRA AUSTRALIS.

SOUTH SEA COMPANY. See COMPANY.

SOUTHAMPTON, a sea-port town of Hampshire in England. It is commodiously seated on an arm of the sea; is a place of good trade, and well inhabited. It is surrounded by walls and several watch-towers, and had a strong castle to defend the harbour, now in ruins. It is a corporation and a county of itself, with the title of an earldom, and sends two members to parliament. W. Long. $1. 26$. N. Lat. $50. 55$.

SOUTHERN, THOMAS, an eminent dramatic writer, was born at Dublin in 1665, and received his education in the university there. He came young to London to study law; but instead of that devoted himself to poetry and the writing of plays. His *Perkin Prince*, or *Loyal Brother*, was introduced in 1682, when the Tory interest was triumphant in England;

and the character of the Loyal Brother being intended to compliment James Duke of York, he rewarded the author when he came to the throne with a commission in the army. On the Revolution taking place, he retired to his studies, and wrote several plays, from which he is supposed to have derived a very handsome subsistence, being the first who raised the advantage of play-writing to a second and third night. The most finished of all his plays is *Oroonoko*, or the *Royal Slave*, which is built on a true story related in one of Mrs Behn's novels. Mr Southern died in 1726, in the 86th year of his age; the latter part of which he spent in a peaceful serenity, having, by his commission as a soldier, and the profits of his dramatic works, acquired a handsome fortune; and being an exact economist, he improved what fortune he gained to the best advantage. He enjoyed the longest life of all our poets; and died the richest of them, a very few excepted. His plays are printed in two vols. 12mo.

SOUTHERN CONTINENT. See AMERICA, N^o 3—24, and TERRA AUSTRALIS.

SOUTHERNWOOD. See ARTEMISIA, BOTANY Index.

SOUTHWARK, a town of Surrey, and a suburb of the city of London, being separated from that metropolis only by the Thames. See LONDON, N^o 96.

SOW. See SUIV, MAMMALIA Index.

SOW, in the iron works, the name of the block or lump of metal they work at once in the iron furnace.

SOW-THISTLE. See SOSCHUS, BOTANY Index.

SOWING, in *Agriculture and Gardening*, the depositing any kind of seed in the earth for a future crop. See AGRICULTURE.

DRILL-SOWING. See DRILL-Sowing.

SOY. See DOUGROS.

SOZOMENUS, HELMIAS, an ecclesiastical historian of the 5th century, was born in Bethulia, a town of Palestine. He was educated for the law, and became a pleader at Constantinople. He wrote an *Abridgement of Ecclesiastical History*, in two books, from the ascension of our Saviour to the year 523. This compendium is full; but a continuation of it in nine books, written at greater length, down to the year 440, is still extant. He seems to have copied Socrates, who wrote a history of the same period. The style of Sozomenus is perhaps more elegant; but in other respects he falls far short of that writer, displaying throughout his whole book an amazing credulity and a superstitious attachment to monks and the monastic life. The best edition of Sozomenus is that of Robert Stephen in 1544. He has been translated and published by Valisius, and republished with additional notes by Reading at London, 1720, in 3 vols folio.

SPA, a town of Germany, in the circle of Westphalia and bishopric of Liege, famous for its mineral waters, lies in E. Long. $5. 50$. N. Lat. $50. 30$. about 21 miles south-east from Liege, and 7 south-west from Lomberg. It is situated at one end of a deep valley on the banks of a small rivulet, and is surrounded on all sides by high mountains. The sides of these mountains next to Spa are rude and uncultivated, presenting a rugged appearance as if shattered by the convulsions of earthquakes; but as they are strewed with tall oaks and abundance of shrubs, the country around forms a wild, romantic, and beautiful landscape. The access to the

Southern
Spa.

Spa
Spah.
been found by experiment, that by exposing it to a gentle heat, air-bubbles ascend in great numbers. It is in its greatest perfection when collected in cold dry weather; it is then pellucid, colourless, and without smell, and almost as light as distilled water. It varies in its heat from 52° or 53° to 67° of Fahrenheit's thermometer.

The Geronlere is a much weaker chalybeate water than the Pouhon; and as it is exceedingly nauseous, and tastes and smells like rotten eggs, it certainly contains some hepatic gas. This is a circumstance which Dr Ash seems not to have attended to sufficiently. The Sauceniere water also, when newly taken from the well, smells a little of sulphur. The Grottebeck contains more alkali, and almost as much gas as the Pouhon, and has been celebrated for its good effects in the case of calculous concretions. The Tonnet contains more gas than any of the rest. So small is the quantity of any fossil body held in suspension by the aerial acid in it, and so volatile is the gas, that it begins to pass off very rapidly the moment it is taken out of the well, and in a short time is entirely gone. Dr Ash informs us, that in the neighbourhood of this well, the cellars, on any approaching change of weather, are found to contain much fixed air; and the best prognostic which they have of rain is the avercion which cats show to be carried into these cellars.

The Spa waters are diuretic, and sometimes purgative. They exhilarate the spirits with an influence much more benign than wine or spirituous liquors, and they are more cooling, and allay thirst more effectually than common water. They are found beneficial in cases of weakness and relaxation, either partial or universal; in nervous disorders; in obstructions of the liver and spleen; in cases where the blood is too thin and putrescent; in cases of excessive discharges proceeding from weakness; in the gravel and stone; and in most cases where a strengthening remedy is wanted. But they are hurtful in confirmed obstructions attended with fever, where there is no free outlet to the matter, as in ulcerations of the lungs. They are also injurious to bilious and plethoric constitutions, when used before the body is cooled by proper evacuations.

SPACE. See METAPHYSICS, Part II. Chap. iv.

SPACE, in *Geometry*, denotes the area of any figure, or that which fills the interval or distance between the lines that terminate it.

SPADIX, in *Botany*, anciently signified the receptacle of the palms. It is now used to express every flower-stalk that is protuded out of a spathe or sheath.

The spadix of the palms is branched; that of all other plants simple. This last case admits of some variety; in *callis*, *dracontium*, and *pothos*, the florets cover it on all sides; in *arum*, they are disposed on the lower part only; and in *zosteria* on one side. See BOTANY.

SPAGIRIC ART, a name given by old authors to that species of chemistry which works on metals, and is employed in the search of the philosopher's stone.

SPAHIS, horsemen in the Ottoman army, chiefly

railed in Asia. The great strength of the grand Scignior's army consists in the janisaries, who are the foot; and the spahis, who are the horse.

SPAIN. The kingdom of Spain, which occupies by Situation and boundary, for the greater portion of the south-western peninsula of Europe, is bounded on the north by the bay of Biscay and Pyrenean mountains, which separate it from France; on the east by the Mediterranean sea; on the south by the straits of Gibraltar, which divide it from the African kingdom of Morocco; and on the west, partly by the Atlantic ocean, but chiefly by the narrow kingdom of Portugal. This last is the only artificial boundary of the Spanish territory, and consists of ideal lines, except in three parts, where the river Minho to the north, and the Douro and the Chanca, till its junction with the Guadiana to the east, form rather more natural limits.

From Cape Ortegal in N. Lat. $43^{\circ} 44'$, to the rock of Gibraltar, in N. Lat. $35^{\circ} 57'$, the continent of Spain extends through nearly 8° of latitude, while its extent from west to east, viz. from Cape Finisterre in Long. $9^{\circ} 17'$ W. from Greenwich to Cape Circus, or Croix, in Long. $3^{\circ} 30'$ E. from the same meridian, comprehends nearly 13° of longitude. In British miles, its length from north to south, viz. from Cape Penas to Gibraltar, may be estimated at 550 miles, while its medium breadth may be computed at 440. According to De Laborde, its superficial extent, exclusive of Portugal, is 25,137 square French leagues, or about 21,000 square English leagues.

Besides the continental part of Spain, this monarchy comprehends several islands in the Mediterranean, especially Majorca, Minorca, and Ivica; the Canary islands, and several places on the north-western coast of Africa; the Philippine and Ladronne islands; together with an immense territory both in North and South America, comprehending Mexico, or New Spain, New Mexico, the island of Cuba, Porto Rico, &c. in North America, and in the southern part of that continent, the greatest portion of *Terra Firma*, Peru, Chili, almost the whole of Paraguay, with an extensive territory lying on the banks of the river Plate.

The usual division of the Spanish continent is into fourteen provinces, viz. those of CATALONIA, ARAGON, and NAVARRE, on the confines of France; BISCAY, ASTURIAS, and GALLICIA, on the shores of the Atlantic; LEON and ESTREMADURA, on the side of Portugal; ANDALUSIA chiefly on the straits of Gibraltar; GRANADA, MURCIA, and VALENCIA, on the shores of the Mediterranean; OLD and NEW CASTLE in the centre.

The latest writer on the geography of Spain, De Laborde, reckons only 13 provinces, as he includes Granada under Andalusia. In the following table we have brought together the most important circumstances respecting each of these provinces, viz. their subdivisions, extent in square British miles, population at the end of the 18th century, and chief towns; and we have arranged the provinces in the order followed by Laborde.

Provinces.	Subdivisions.	Extent in square miles.	Population.	Chief Towns.
Province of CATALONIA.	County of Rouffillon } Cerdagne }	10,400	814,412	BARCELONA, Tarragona, Urgel, Lerida, Gerona, Salona, Vich, Tortosa, Figueras, &c.
Kingdom of VALENCIA.		7,800	932,150	VALENCIA, Alicante, Elche, Orihuela, Castellon, Alzira, Caraxente, Gandia, Xativa, Olmiente, Alcoy, Segorbe, &c.
Province of ESTREMADURA.		16,000	416,922	BADAJOS, Placencia, Coria, Merida, Truxillo, Xera de los Cavalleros, Llerena, Almatona, Zafra, &c.
Province of ANDALUSIA.	Kingdom of Seville	12,600	754,293	SEVILLE, Xeres de la Frontera, Arcos, Cadix, Real Ejo, Ayamonte, Nivela, &c.
	Granada	4,500	661,661	GRANADA, Malaga, Loxa, Santa Fé, Antiquera, Ronda, Guadix, Baza, &c.
	Cordova	1,080	236,016	CORDOVA, and Archidona, &c.
	Jaen	2,400	177,136	JAEN, Ubeda, Baeza, Anduxar, &c.
Kingdom of MURCIA.		8,812	337,686	MURCIA, Carthagena, Lorca, Chinchilla, Alba Cete, Villena, Almanza, &c.
Kingdom of ARAGON.		16,500	623,308	ZARAGOZA, Jaca, Barbastro, Huesca, Tarazona, Albarrazin, Teruel, &c.
Kingdom of NAVARRIE.		2,287	287,382	PAMPLUNA, Tudela, &c.
Province of BISCAY.	Biscay Proper } Alava } Guipuzcoa }	4,000	116,042 74,000 12,076	BILBOA, Vermijo, &c. VITTORIA, Trevino, Onate, &c. ST SEBASTIAN, Fuenaraba, Tolofa, Placentia, &c.
Principality of the ASTURIAS.	Oviedo } Santillana }	3,375 } 1,200 }	350,000	OVIEDO, Aviles, Lluarca, Gijon, &c. SANTILLANA, San Vincente, Riva de Sella, &c.
Kingdom of GALLICIA.		11,500	1,350,000	SAN JAGO DE COMPOSTELLA, Bayona, Lugo, Orense, Mondonedo, Corunna, Vigo, &c.
Kingdom of LEON.	Leon } Palencia } Zamora } Salamanca }	10,750	665,432	LEON, Duero, Astorga, Salamanca, Zamora, &c.
Kingdom of OLD CASTILE.	Burgos } Avila } Segovia } Toledo }	10,800	1,190,180	BURGOS, Ofma, Siguenza, Avila, Valladolid, Segovia, Calahorra, Soria, &c.
Kingdom of NEW CASTILE.	Cuenca } Lamanca }	22,000	1,146,809	MADRID, Toledo, Aranjuez, Talavera della Reyna, &c. CUENCA, Guete, Alacon, &c. OCANA, Hucles, Laguardia, Tarazona, &c.
Kingdom of MAJORCA.	Islands of Majorca } Cabrera }	1,440 }	136,000	PALMA, Alcudia, &c.
Island of MINORCA.	Iviça }	110 }	27,000	IVIÇA.
		360		MAHON, Cittadella.
			10,308,505	

Some account of these provinces will be found under the articles ANDALUSIA, ARAGON, ASTURIAS, BISCAY, CASTILE, CATALONIA, ESTREMADURA, GALLICIA, GRANADA, LEON, MURCIA, NAVARRIE, VALENCIA, IVIÇA, MAJORCA and MINORCA; but, for the best view of their present state, we must refer our readers to De L. borde's *View of Spain*, vols. i. ii. and iii. or to Playfair's *Geography*, vol. i.

In its general appearance, Spain presents a pleasing

variety of hill and dale, mountain and valley. It must be regarded as a mountainous country, its plains being few in number and of small extent. The most remarkable of these occupies the centre of the kingdom, especially New Castile, which forms the most elevated tract of level country to be found in Europe, having a mean elevation of more than 300 fathoms above the level of the sea. The country is well wooded, and abounds with rivers; but these are often very deficient in water, and

4
Face of the
Country.

Spain. Spain, especially on its eastern coast, is remarkable for the dryness of its soil. Notwithstanding this aridity, however, most parts of the kingdom teem with fertility, and native verdure and high cultivation render the scenery delightful. Here and there, indeed, occurs a tract of desert utterly incapable of cultivation; but, in general, nature has done much more for the country than the labour of its inhabitants.

5 The soil is said to be in general light, and easily wrought; but on many parts of the eastern coast it is composed chiefly of a stiff loam or clay. The most fertile parts of the kingdom are in Valencia, on the coast of Granada, in the kingdom of Old Castile, and in several parts of those of New Castile and Leon. The soil of Catalonia is very discouraging, except in the valleys, and the same may be said of all the provinces bordering on the Pyrenees; the soil of Estremadura, though naturally good, has been so long abandoned to itself, that it has almost ceased to produce, and that of Andalusia has a very mixed character. The soil of Murcia is uncommonly arid; that of the Asturias cold; and that of Galicia extremely wet. In the neighbourhood of Carthage there is an extensive tract, which is so covered with stones as to form a desert as sterile and unamenable as any on the sandy plains of Africa or Arabia.

6 Mountain. We have said that Spain is a mountainous country. The chain of the Pyrenees, common to it and France, is by no means the most considerable in point either of elevation or extent; though that chain may be regarded as the common root or origin of all the rest. From the western corner of the Pyrenees a vast ridge branches off through Navarre, Biscay, Asturias, and Galicia, terminating only at Cape Finisterre, and Cape Ortegal. This ridge is the *Cantabrian* mountains, and is distinguished into several subordinate groups, denominated from the principal towns situated in their vicinity. Thus we have the mountains of Mondonedo in Galicia. In general, these groups are called *Sierres*, from the jagged or *ferreted* appearance of their tops; as the *Sierra de la Asturias*, *Sierra d'Avila*, &c. The subordinate mountains that extend from the Sierra of the Asturias in the north, to the Alpujaras in the south, run in parallel lines; and the same direction prevails in the mountains of Saint Andero, which join the Pyrenees.

From the mountains of Biscay arises a main ridge, which, after proceeding a little to the south, divides into three or four branches. Of these the most northerly chain separates the provinces of Old Castile and New Castile, extending to the confines of Portugal, and called the mountains of Guadarrama. A second branch divides the principal part of New Castile from the province of La Mancha, running from the north-east to the south-west, as far as Badajoz in Estremadura. The most remarkable part of this chain is the Sierra of Guadalupe. South of these runs the Sierra Morena, or Sable mountains, rendered classical by the immitable pen of Cervantes. This is the last chain till we reach the Alpujaras, that extend through the provinces of Granada and Andalusia.

Of these mountains there are two points, which, in elevation, exceed Mont Perdu, the highest of the Pyrenees, viz. the Pico de Veneta, in the Sierra Nevada, or snowy mountains of Granada, which is elevated more than 1751 fathoms above the level of the ocean, and the peak of Mulahafen, in the same chain, raised above

1824 fathoms, which is within 76 fathoms of the peak of Tenerife.

The principal capes and promontories of the Spanish continent are, Cape Creus, Cape St Antoine, opposite the island of Iviza; Cape Palas, near Carthage; Cape de Gatte, near Almeria, and the promontory on which stands the town of Gibraltar, all on the coast of the Mediterranean; and Cape Machiaco, Cape Penas, Cape Ortegal, the promontory of Ferrol, Cape Finisterre, and Cape Trafalgar, on the coasts of the Atlantic.

The principal bays and gulfs on the coast of Spain, and pursuing the same course, are the following; the bay of Valencia, the bay of Alicante, the gulf of Carthage, the bay of Almeria, the bay of Gibraltar, the harbour of Cadiz, the bay of Corunna, commonly called the Groyne, and the bay of Biscay.

The rivers of Spain are intimately connected with the mountains from which they derive their source, and between the chains of which they generally flow. The most important are, the Ebro, rising in the mountains of Santillana in the Asturias, and running in a south-eastern direction between the Castiles and Valencia on the one hand, and the provinces of Navarre, Aragon, and Catalonia, on the other, till it reaches the Mediterranean, at a small distance from Tortosa; the Xacar, rising in the Sierra of Cuenca in New Castile, and flowing into the Mediterranean considerably to the southward of Valencia; the Segura, rising in a mountain of the same name, traversing the province of Murcia, and meeting the Mediterranean about midway in the capital of that province, and Alicante. These flow into the Mediterranean, and there are several other rivers of less note, which pour their waters into the same sea, and which we can merely enumerate. These are the Ter at Gerona, the Lobregate at Barcelona, and the Mirjares, passing by Segorbe. The rivers which flow into the Atlantic are, the Guadalquivir, rising at the foot of Mount Segura, from the opposite side of which originates the river of the same name, flowing with a sluggish course through the province of Andalusia, and meeting the Atlantic a little to the north-west of Xeres; the Gadiana, rising among some lakes to the north-west of Alcaraz in New Castile, and passing between the Sierra Morena and the Sierra de Guadalupe, till, near Badajoz, it enters the kingdom of Portugal, and runs nearly in a southerly direction, till it meets the Atlantic at Ayamonte; the Tagus, rising among the mountains of Albarcin in New Castile, and running westerly till, at Alcantara, it becomes a river of Portugal; the Douro, rising in Old Castile near Soria, and passing by Valladolid and Zamora, near which it forms a part of the boundary of Portugal; the Minho, rising in the mountains of Galicia, and running to the south-west, till it meets the Atlantic to the north of Camina. The only other river of any importance in this direction is the Lima, supposed to be the Lethe of the poets, which rises in Galicia, and flows into the sea below Viara.

If we except the series of small lakes from which we have said the river Gadiana takes its rise, there are, in Spain, few lakes that merit particular notice. The most remarkable of these is the lake of Abulera, in the province of Valencia. This lake begins near the village of Catarroja, about a league south of the city of Valencia, and extends nearly four leagues as far as Cullera. When

Spain.

It is full, it is about four leagues long, two in breadth, and six in circumference; but it is so shallow, that small boats can scarcely float in it. To supply the deficiency of water, an engine is employed, by which the neighbouring waters are drawn into the bed of the lake; and any superabundant water occasioned by heavy rains, is carried off into the sea by means of an artificial opening. This lake contains a great many fish, and numerous aquatic birds make it their haunt. On certain days in the year the inhabitants of Valencia make incursions hither to shoot the birds, and the surface of the lake is at these times covered with boats.

11
Forests.

Many parts of the kingdom of Spain abound in large tracts of wood. Extensive forests are found in Catalonia, the Asturias, Galicia, and in the Sierra Morena. It is in the mountainous chains that the forests of Spain are most remarkable; and there are few of these heights, except in the snowy regions of the Sierra Nevada, but what are covered with wood almost to their summits.

12
Clim. tem.
and season.

The climate of Spain is as delightful as that of any part of Europe; and though at certain seasons of the year the eastern coast is subject to excessive heat and drought, and the north-western to almost perpetual rains, the temperature is in general mild, and the air salubrious.

The climate of Spain has been admirably depicted by M. A. de Humboldt; and we shall here present to our readers the substance of his remarks, as they are related by De Laborde, in his view of Spain.

No country of Europe presents a configuration so singular as Spain. It is this extraordinary form which accounts for the dryness of the soil in the interior of the Castiles, for the power of evaporation, the want of rivers, and that difference of temperature which is observable between Madrid and Naples, two towns situated under the same degree of latitude.

The interior of Spain is, as we have seen, an elevated plane, which is higher than any of the same kind in Europe, occupying so large an extent of country. The mean height of the barometer at Madrid is 26 inches $2\frac{1}{2}$ lines. It is therefore $\frac{1}{2}$ lower than the mean height of the mercury at the level of the ocean. This is the difference of the pressure of the atmosphere that is experienced by all bodies exposed to the air at Madrid, and at Cadix and Bourdeaux. At Madrid the barometer falls as low as 25 inches 6 lines, and sometimes even lower.

The following is a table of the variations in the height of the barometer during the first nine months of the year 1793.

Months.	Maximum.		Minimum.		Mean Height of the Mercury	
	Inches.	Lines.	Inches.	Lines.	Inches.	Lines.
1793.						
January,	26	5.8	25	9.8	26	2.6
February,	26	5.3	25	6.2	26	1.6
March,	26	4.7	25	6.	25	11.6
April,	26	2.4	25	6.9	25	11.6
May,	26	4.6	25	10.5	26	0.8
June,	26	4.	25	11.8	26	1.6
July,	26	4.3	26	0.7	26	2.4
August,	26	3.2	25	11.5	26	1.4
September,	26	4.3	25	11.	26	1.7

Spain.

From the mean height of the barometer at Madrid, we find that capital to be elevated 329 $\frac{1}{2}$ fathoms above the level of the ocean. Madrid, consequently, stands as high as the town of Insbruck, situated in one of the highest defiles of the Tyrol, while its elevation is 15 times greater than that of Paris, and three times greater than that of Geneva.

According to M. Thalacker, the mineralogist, who has taken several heights with the barometer in the environs of Madrid, the elevation of the king's palace at San Ildefonso is 593 fathoms, which is higher than the edge of the crater of Mount Vesuvius, and is, strictly speaking, in the regions of the clouds, which generally float from 550 to 600 fathoms high.

The height of the plain of the Castiles has an evident effect on its temperature. We are alighted at not finding oranges in the open air under the same latitude as that of Tarentum, part of Calabria, Thessaly, and Asia Minor; but the mean temperature of Madrid is very little superior to that of Marseilles, Paris, and Berlin, and is nearly the same with that of Genoa and Rome. The following table shews the mean temperature at Madrid and at Rome, during the first nine months of the years 1793 and 1807.

Months.	At Madrid.		At Rome.	
	Deg. of Fahrenheit.	Deg. of Fahrenheit.	Deg. of Fahrenheit.	Deg. of Fahrenheit.
January,	39°	3	45°	11' 15"
February,	43	24	47	49 30
March,	47	54	50	15 45
April,	52	19 30"	54	33 30
May,	59	4 30	65	56 15
June,	72	32 15	72	30
July,	77	13 30	79	15
August,	81	34 30	79	15
September,	65	45	72	34 30

Thus, the mean temperature at Madrid appears to be 59° of Fahrenheit, while that of the coasts of Spain, from the 41° to the 36° of Lat. is between 63 $\frac{1}{2}$ ° and 68° of Fahrenheit. In the former climate we find that orange trees will not flourish in perfection, while in the latter we see banana trees, heliconias, and even sugarcanes, growing in situations that are sheltered from the cold winds.

13

Spain presents few species of animals that are not found in the other parts of southern Europe. Among the quadrupeds, we may remark, as peculiar to Spain, the genet, (*visonra genetta*). The bear is found in several parts of the great Pyrenean chain, especially on some of the mountains of Aragon, as well as those of Occar and Reynosa in Old Castile. Wolves are met with in all the higher and mountainous parts of the country, and wild boars on the mountains of Navarre, on the Pinar, and the Sierra de Caracoy, in the kingdom of Valencia. The raccoon is found on some of the mountains of Navarre, and the lynx and the ibex on those of Cuenca in New Castile, in the valleys of Aure and Guitau, as well as in the Pyrenees. The glory of Spanish zoology is the horse, for which this kingdom has been famous in all ages. The Spanish

horses

Spain.

horses have probably originated from the Barbs of the north of Africa, supposed to be the immediate offspring of the Arabian breed. The Spanish mules are also excellent, and the ass is here no ignoble animal, though not equal to those of Arabia. There is little remarkable in the breed of cattle, but the Merino sheep have long been distinguished, and are perhaps superior to any in the world for the beauty of the fleece, if not for the delicacy of the mutton. The flocks of Merino sheep are sometimes extremely large, and Mr Townsend mentions one nobleman who possessed not fewer than 40,000. The whole number in the kingdom may be estimated at about 5,000,000. These animals were, by a special code, called the *Mesta*, authorized to travel from one province to another, according as the season presented the best pasturage in the mountains or the plains. The fleece of the Merino sheep is esteemed double in value to that of any other breed.

Of the birds more peculiarly found in Spain, the *vulture*, *percepsiterus*, the *uculus glandarius*, *uculus tridactylus*, *motacilla hispanica*, *hirundo melia*, and *hirundo rufepennis*, are the most remarkable.

Fresh-water fishes are very plentiful in the Spanish rivers; but those in most esteem are from the small river Tormes in Old Castile, where have been taken trout of 20 lbs. weight. The tench of the lakes near Tobar in New Castile, are remarkably fine and delicate, and are taken in great abundance every year, during the months of May and June. The fish taken on the coasts are much the same as those of the other countries bordering on the Mediterranean and the Atlantic. The tunny was formerly taken on the eastern coast, where it formed a particular branch of the fishery, but is now, we believe, little regarded.

Among the Spanish insects, the most remarkable are, the cantharides, (*meloe vesicatorius*), and the kermes insect (*coccus ilicis*). The latter insect is much cultivated as an article of dyeing, especially in the territory of Bujalance, and of Fernan Nunes in the kingdom of Cordova, as also in the vicinity of the town of De las Aguas, four leagues from Alicante, and near the river Henares, in New Castile. The evergreen oaks on which these animals feed, present in the spring, a most singular appearance, from the red *nidi* of the kermes, with which their leaves are covered.

14
Vegetables. No country of Europe of the same extent, furnishes such an ample field for the researches of the botanist, as Spain; and indeed its botany constitutes a very important part of its natural history. The mountainous districts are clothed with the ever-green oak, the common oak, the chefnut, and in some places various species of pine; but their most useful production is the cork tree. The smaller heights produce the wild olive, the almond, the flumac, the laurel, the bay, the cypress, Canary and Portugal broom, the yellow jessamine, and the Provence rose. The vine, the palm tree, the orange, the lemon and the olive, are so nearly naturalized as to require but little cultivation; and the same may be said of the *ksli* (*Jal-la soda*), which is produced in large quantities on the coasts, and furnishes the best kind of kelp, commonly called *barilla*, used in the manufacture of soap and glass. The plains and valleys are covered with many of those plants which form some of the greatest ornaments of our flower gardens, as the tulip, several species of iris, the peony, the passion flower, the

Spain.

orange and martagon lily, the jonquil, several species of narcissus and hyacinth, and above all the rhododendron. The mountains, however, exhibit the greatest variety of botanical riches. Those most worthy of the visits and researches of the enterprising botanist, are, the Sierra de Guadalupe in Extremadura; the mountains of Moncayo in Aragon; of Pineda, Guadarrama, and Cuenca, in New Castile; of Carcoloy, in the kingdom of Murcia; of Pena-Colosa, Mongi, Aytosa, and Mariola, in the kingdom of Valencia, and the Pyrenees.

The sugar-cane, was, before the discovery of the West India islands, one of the most important objects of Spanish cultivation, and numerous sugar mills were established along the coast of the Mediterranean, especially in the kingdom of Granada. At the conquest of that Moorish kingdom, not fewer than fourteen sugar plantations and two mills, were found within the province. Some sugar canes are still cultivated in the kingdom of Valencia, but the manufacture of sugar is discontinued, and the canes are used only for distillation. There is, we believe, still a manufactory for sugar from Spanish canes in Granada.

15

Spain has long been celebrated for the riches of its Mineral Kingdom, and it may still be considered as the Mexico and Peru of Europe. There are few metals which may not be found in this kingdom; and, till the discovery of America put the Spaniards in possession of mines which far surpass their own in produce, the gold and silver mines of Spain were thought to be nearly the richest in the world. At present, no gold mines are wrought, but grains of that metal are found disseminated in ferruginous quartz, forming a vein that passes through a mountain near the village of San Ildefonso in Old Castile. Spangles of gold are found intermixed with emery, in a mine near Alocer in Extremadura, and in the territory of Molena in Aragon; and this metal is occasionally found in the sand of two rivers; the Agueda, in the kingdom of Leon, which rises from the mountains of Xalamo, and the Tagus in New Castile, especially in the vicinity of Toledo.

Silver is much more abundant, but most of its mines have also been abandoned. We believe the only silver mine now in work is that of the Sierra de Guadalupe, near the village of Logrozen, where the silver is found mixed with micaceous schistus. The most remarkable silver mines formerly worked are those of Alrodado del Campo; of Zalamea on the road to Alocer in Extremadura; of Almazaron near Carthage; three in the Sierra Morena, about a league from Guadalcanal, in the kingdom of Seville, and another about two leagues from Linarez, in the kingdom of Jaen. This last mine was well known both to the Carthaginians and the Romans; while Spain was under the dominion of the former it belonged to Himilca, the wife of Agdrubal. After having been long abandoned, it was again wrought in the 17th century, when a vein of ore five feet in diameter was discovered; at present, however, it is no longer in a state of activity.

Mines of copper are found near Pampeluna in Navarre, near Salva Tierra in Alava; near Escarray, and at the foot of the mountains of Guadarama in Old Castile; near Lorea in Murcia; near the Chartreuse of the Val de Chrilo in Valencia; in the Sierra de Guadalupe in Extremadura; in the mountains near Cordova; near Ricinto, and at la Canada de los Conejos in Seville;

16

^{Spain.} in the district of Albaludri in Granada, and near Linares in the kingdom of Jaen.

There are numerous lead mines, especially near Tortosa in Catalonia; at Zoma, Benafiques, and Plan in Aragon; near Logrofen and Aleofer in Eilremadura; in the mountain Guadarrama in Old Castile; near los Alumbres and Lorca in Murcia; at Alcaniz and Constantina in Seville, and at the district of Linares in Jaen.

The mines of iron are abundant, and need not be enumerated. Of antimony there are two mines, both in the district of La Mancha. One of these is at Alendia, near Almodovar; the other at the foot of the Sierra Morena. There is only one mine of cobalt, viz. in the province of Aragon, found in the valley of Gelfon. There are two mines of cinnabar in Valencia; one about two leagues from Alicante in the limestone mountains of Alceoray; the other between Valencia and San Felipe; and two others in the same province, that produce native mercury, but none of these are worked. The most abundant mine of mercury and cinnabar united is in the district of La Mancha, on the borders of Cordova. It is situated in a hill of sandstone which rests on slate. The whole length of the hill is traversed by two principal veins, both of which were wrought by the Romans. The whole of this mine was lately wrought by the agents of the king, and its produce was very abundant.

Plumbago is found in a thick vein intermixed with felspar, about a league from the village of Real Monasterio, in the kingdom of Seville. Mines of sulphur occur, both in Aragon and Murcia; jet has been found in the district of Old Colmenar, in Old Castile; and there is good evidence of the presence of coal at several places in Catalonia, in the Asturias, New Castile, and Aragon; but it is said that no coal mines have as yet been opened.

The marbles of Spain are very numerous and valuable. A black marble, veined with white, is procured near Barcelona; many dendritic marbles occur near Tortosa. Near the town of Molina, in Aragon, is found a granular marble spotted with red, yellow, and white. At the village of Salinos, in the district of Guipuzcoa, is a beautiful blue pyritical marble, containing marine shells. From Monte Sagarra, near Segorbia, in the province of Valencia, are procured several fine marbles, which were held in great estimation even by the Romans. The province of Granada, however, contains more valuable varieties of this beautiful mineral than all the rest of Spain; of these some of the principal are the following. A pure white statuary marble, of which the whole mountain of Filabra, near Almeria, is composed; a flesh-coloured marble from a mountain near Antiquera; an exquisitely beautiful wax-coloured alabaster, from the vicinity of the city of Granada; and a finely veined marble from the Sierra Nevada.

¹⁶ Mineral waters. Of the Spanish mineral waters the following are the most celebrated. The principal cold springs are, a hepatic water in the town of Buron, in Valencia; a carbonated water at Gerona, in Catalonia; a saline purgative water at Vacia-Madrid, three leagues from the capital, and another of a similar nature near Toledo.

The principal hot springs are, i. e. baths of Abu-Zulma, at Javal-Cohol, near Breza; a hepatic spring used for lathing near Alhama de Granada; another near Almeria, in the province of Granada, to which are at-

tached both bathing and vapour baths: all these were discovered, or at least brought into general use, by the Moors. A very copious hot spring near Merida, in Eilremadura, made use of by the Romans. The Calda de Bonar, in the neighbourhood of Leon, a spring of tepid water frequented by the Romans, and still exhibiting the ruins of baths and ancient inscriptions. A very hot spring, near Orenle, in Galicia. A spring at Alhama, near Calatayud, in Aragon, formerly much frequented, but now in a state of neglect. The Fuente de Buzot, near Alicant, a saline spring of the temperature of 104° Fahrenheit. A very copious and hot spring at Archena, near Murcia, where still remain the ruins of Roman and Moorish baths. A hepatic spring near Arnedillo, in Old Castile.

Among the natural curiosities of Spain, we may particularize the mountain of Montferat in Catalonia ¹⁷ Natural curiosities. (see GEOLOGY, N° 102.); the insulated hill of rock salt near the town of Cardona, in Catalonia (see GEOLOGY, N° 102.); the subterranean lake contained within a cavern in the neighbourhood of the Cava Perella, in the island of Minorca; the Italic cave called St Michael's, on the west side of the rock of Gibraltar, and the river Guadiana, which appears and disappears several times in the course of its progress to the sea.

The various groups of islands that are subject to Spain ¹⁸ Spanish islands. have long been distinguished by particular names. Thus *Majorca*, *Minorca*, *Cabrera* and *Dragonera*, were called by the ancients *Isule Balaeres*, and are still named the *Balaeric Isles*; while *Ivica* and *Ferrentara* form a lesser group, denominated the *Pityulic Isles*. Of these islands, the latter were taken possession of by the Carthaginians nearly 700 years before the Christian era; and about 200 years after that enterprising people made themselves masters of the Balaeric isles. After the fall of Carthage, all these islands long maintained a state of piratical independence, and only *Majorca* was ever completely subject to the Romans. In the time of Augustus we are told that the Balaeric isles were so infested with rabbits, that the inhabitants sent deputies to Rome for assistance to destroy these formidable invaders of their plantations. In the year 426 of the Christian era, these islands came into the possession of the Vandals, from whom they were taken at the end of the 8th century by the African Moors. At the beginning of the 9th century they were seized on by a fleet sent into the Mediterranean by Charlemagne; but they were soon after reconquered by the Moors, who maintained the sovereignty in these islands till, in 1228, they were finally disposed of by Don James grandson of Alphonso II. king of Aragon.

Though Spain appears to have been known to the Phœnicians nearly 1000 years before the birth of Christ, ¹⁹ Names of Spain. it seems to have been little regarded by the Greeks till after the period when Herodotus composed his history. Some part of this country was probably the *Tarshish* of Scripture, from which the Phœnicians imported gold, silver, and other precious commodities into Judea. When the Greeks had established a colony at Marcellis, they must have been well acquainted with at least the northern part of this peninsula, to which they gave the names of *Iberia* and *Celtiberia*, from two nations who then inhabited the country, and of *Hesperia*, from its extreme situation in the west of the then known world. The name *Hispania*, from which its modern appellation

Spain is derived, was bestowed on it by the Romans; and the etymology of this name is uncertain.

20
Original population.

The Aborigines of Spain were doubtless a Celtic tribe, which probably passed into this peninsula from the adjoining continent of Gaul, though at a very early period they appear to have been mixed with a colony of Mauritanians, or Moors from the coast of Africa. The Celtic inhabitants, or Celtiberi, seem to have possessed the north-east of the peninsula, while the Mauritanians occupied the southern and south-western districts.

21
Spain invaded by the Carthaginians.
An. 240.
B. C.

Nothing certain is known respecting the early state of Spain, till the commencement of the first Punic war between the Romans and the Carthaginians, in the middle of the third century before Christ. Not long before this date, probably at the beginning of the century, the latter people had possessed themselves of Catalonia, when their general Hamilcar Barca is said to have founded the city of Barceno, the modern Barcelona. The Carthaginian colony, however, seems to have been rather a mercantile than a warlike settlement, and the Celtiberi were more the allies than the subjects of their African neighbours. Of the contests carried on between the Carthaginians and the Romans, till the final subjugation of the former, and the consequent occupation of all their territories by the Roman republic, we have given an account under the articles CARTHAGE and ROME. We shall here briefly consider the state of Spain at the time of its occupation by the Romans, and relate the events to which that occupation gave rise, and which are less connected with the more immediate transactions of the Punic wars.

22
State of Spain at the Roman conquest.

At the time of the Roman conquest, Spain, though prodigious quantities of silver had been carried out of it by the Carthaginians and Tyrians, was yet a very rich country. In the most ancient times, indeed, its riches are said to have exceeded what is related of the most wealthy country in America. Aristotle assures us, that when the Phenicians first arrived in Spain, they exchanged their naval commodities for such immense quantities of silver, that their ships could neither contain nor sustain its load, though they used it for ballast, and made their anchors and other implements of silver. When the Carthaginians first came to Spain, they found the quantity of silver nothing lessened, since the inhabitants at that time made all their utensils, and even mangers, of that precious metal. In the time of the Romans this amazing plenty was very much diminished; however, their gleanings were by no means despicable, since in the space of nine years they carried off 111,542 pounds of silver, and 4295 of gold, besides an immense quantity of coin and other things of value (A). The Spaniards were always remarkable for their bravery, and some of Hannibal's best troops were brought from thence; but as the Romans penetrated farther into the country than the Carthaginians had done, they met with nations whose love of liberty was equal to their valour, and whom the whole strength of their empire was scarcely able to subdue. Of these the most for-

midable were the Numantines, Cantabrians, and Asturians.

Spain.
23
Successes of Viriathus against the Romans.

In the time of the third Punic war, one Viriathus, a celebrated hunter, and afterwards the captain of a gang of banditti, took upon him the command of some nation which had been in alliance with Carthage, and ventured to oppose the Roman power in that part of Spain called *Lusitania*, now Portugal. The pretor, named *Vetilius*, who commanded in those parts, marched against him with 10,000 men; but was defeated and killed, with the loss of 4000 of his troops. The Romans immediately dispatched another pretor with 10,000 foot and 1300 horse: but Viriathus having first cut off a detachment of 4000 of them, engaged the rest in a pitched battle; and having entirely defeated them, reduced great part of the country. Another pretor, who was sent with a new army, met with the same fate; so that, after the destruction of Carthage, the Romans thought proper to send a consul named *Quintus Fabius*, who defeated the Lusitanians in several battles, and regained two important places which had long been in the hands of the rebels. After the expiration of Fabius's consulate, Viriathus continued the war with his usual success, till the senate thought proper to send against him the consul *Q. Cæcilius Metellus*, an officer of great valour and experience. With him Viriathus did not choose to venture a pitched battle, but contented himself with acting on the defensive; in consequence of which the Romans recovered a great many cities, and the whole of Tarraconian Spain was obliged to submit to their yoke. The other consul, named *Servilianus*, did not meet with the same success; his army was defeated in the field, and his camp was nearly taken by Viriathus. Notwithstanding the good fortune of Metellus, however, he could not withstand the intrigues of his countrymen against him, and he was not allowed to finish the war he had begun with so much success. In resentment for this he took all imaginable pains to weaken the army under his command: he disbanded the slower of his troops, exhausted the magazines, let the elephants die, broke in pieces the arrows which had been provided for the Cætan archers, and threw them into a river. Yet, after all, the army which he gave up to his successor *Q. Pompeius*, consisting of 30,000 foot and 2000 horse, was sufficient to have cruised Viriathus if the general had known how to use it. But, instead of opposing Viriathus with success, the imprudent consul procured much more formidable enemies. The Termantines and Numantines, who had hitherto kept themselves independent, offered very advantageous terms of peace and alliance with Rome; but Pompeius insisted on their delivering up their arms. Upon this war was immediately commenced. The consul with great confidence invested Numantia; but being repulsed with considerable loss, he sat down before Termantia, where he was attended with ill success. The very first day, the Termantines killed 700 of his legionaries; took a great convoy which was coming to

(A) In this account we must allow something for the exaggerations of fabulous historians. There is no doubt, however, that Spain was at this time immensely rich, and if we may believe Strabo, there was then a mine near Carthage which yielded every day 25,000 drams of silver, or about 300,000l. per annum.

Spain. the Roman camp: and having defeated a considerable body of their horse, pushed them from post to post till they came to the edge of a precipice, where they all tumbled down, and were dashed to pieces. In the mean time Servilius, who had been continued in his command with the title of *proconul*, managed matters so ill, that Viriathus surrounded him on all sides, and obliged him to sue for peace. The terms offered to the Romans were very moderate; being only that Viriathus should keep the country he at that time possessed, and the Romans remain masters of all the rest. This peace the proconul was very glad to sign, and afterwards procured its ratification by the senate and people of Rome.

The next year Q. Pompeius was continued in his command against the Numantines in Further Spain, while Q. Servilius Cæpio, the new consul, had for his province Bætitia Spain, where Viriathus had established his new state. Pompeius undertook to reduce Numantia by turning aside the stream of the Durus, now the Duero, by which it was supplied with water; but, in attempting this, such numbers of his men were cut off, that, finding himself unable to contend with the enemy, he was glad to make peace with them on such worse terms than they had offered of their own accord. The peace, however, was ratified at Rome; but in the mean time Cæpio, desirous of showing his prowess against the renowned Viriathus, prevailed on the Romans to declare war against him without any provocation. As Cæpio commanded an army greatly superior to the Lusitanians, Viriathus thought proper to sue for peace; but finding that Cæpio would be satisfied with nothing less than a surrender at discretion, he resolved to stand his ground. In the mean time, the latter having bribed some of the intimate companions of Viriathus to murder him in his sleep, he by that infamous method put an end to a war which had lasted 14 years, very little to the honour of the republic.

After the death of Viriathus, the Romans with little treachery ordered their new consul Popilius to break the treaty with the Numantines. His infamous conduct met with the reward it deserved; the Numantines flying out, put the whole Roman army to flight with such slaughter, that they were in no condition to retreating the whole campaign. Mancebos, who forced Popilius, met with still worse success: his great army, consisting of 30,000 men, was utterly defeated by 400 Numantines, and 20,000 of them killed in the pursuit. The remaining 10,000, with their general, were pent up by the Numantines in such a manner that they could neither advance nor retreat, and would certainly have been all put to the sword or made prisoners, had not the Numantines, with a generosity which their enemies never possessed, offered to let them depart upon condition that a treaty should be concluded with them upon very moderate terms. This the consul very willingly promised, but found himself unable to perform. On the contrary, the people, not satisfied with declaring his treaty null and void, ordered him to be delivered up to the Numantines. The latter refused to accept him, unless he had along with him the 10,000 men whom they had relieved as before related. At last, after the consul had remained a whole day before the city, his successor Furius, thinking this a sufficient recompense to the Numantines for breaking the treaty, ordered him to be received again into the camp. However, Furius did not

chuse to engage with such a desperate and resolute enemy as the Numantines had showed themselves; and the war with them was discontinued till the year 133 B. C. when Scipio Æmilianus, the destroyer of Carthage, was sent against them. Against this renowned commander the Numantines with all their valour were not able to contend. Scipio, having with the utmost care introduced strict discipline among his troops, and reformed the abuses which his predecessors had suffered in their armies, by degrees brought the Romans to face their enemies, which at his arrival they had absolutely refused to do. Having then ravaged all the country round the town, it was soon blocked up on all sides, and the inhabitants began to feel the want of provisions. At last they resolved to make one desperate attempt for their liberty, and either to break through their enemies, or perish in the attempt. With this view they marched out in good order by two gates, and fell upon the works of the Romans with the utmost fury. The Romans, unable to stand this desperate shock, were on the point of yielding, when Scipio, hatching to the pieces attacked, with no fewer than 20,000 men, the unhappy Numantines were at last driven into the city, where they fastened for a little longer the miseries of famine. Finding at last, however, that it was altogether impossible to hold out, it was resolved by the majority to submit to the pleasure of the Roman commander. But this resolution was not universally approved. Many that themselves up in their books, and died of the hunger, while even those who had agreed to surrender, repeated their offer, and setting fire to their houses, perished in the flames with their wives and children, so that not a single Numantine was left alive to grace the triumph of the conqueror of Carthage.

After the destruction of Numantia the whole of Spain submitted to the Roman yoke; and nothing remarkable happened till the time of the Cimbric, when a powerful army was cut off in Spain by the Lusitanians. From this time nothing remarkable occurs in the history of Spain till the civil war between Marius and Sylla. The latter having crushed the Marian faction, as related under the article *Italy*, proscribed all those that had sided against him when he could not immediately destroy. Among these was Servilius, a man of consummate valour and experience in war. He had been appointed the governor of Sicily by Marius; and on the overthrow of Marius, retired to that province. Sylla no sooner heard of his arrival in that country, than he sent thither one Cælus Aulus with a powerful army to drive him out. As Servilius had but few troops along with him, he dispatched one Julius Silvanus with a body of 6000 men to guard the passes of the Pyrenees, and to prevent Aulus from entering the country. But Silvanus having been treacherously murdered by Aulus's hired by Aulus for that purpose, he no longer met with any obstructions; and Servilius was obliged to embark for the coast of Africa with great loss, being all that he had now remaining. With this he took his last stand; but in his man was being slain, he was slain, great numbers of them were cut off by the Philippians, and the misfortune obliged him to retire to the coast of Spain; but finding the whole coast filled with the troops of Aulus, he put to sea again, not knowing what course to steer. In this new voyage he met with a small fleet of Cilician pirates; and having prevailed

with them to join him, he made a descent on the coast of Ivisca, overpowered the garrison left there by Annus, and gained a considerable booty. On the news of this victory Annus set sail for Ivisca, with a considerable Squadron, having 5000 land forces on board. Sertorius, not intimidated by the superiority of the enemy, prepared to give them battle. But a violent storm arising, most of the ships were driven on shore and dashed to pieces, Sertorius himself with great difficulty clearing with the small remains of his fleet. For some time he continued in great danger, being prevented from putting to sea by the fury of the waves, and from landing by the enemy; at last, the storm abating, he passed the straits of Gades, now Gibraltar, and landed near the mouth of the river Bætis. Here he met with some seamen newly arrived from the Atlantic or Fortunæ islands: and was so charmed with the account which they gave him of those happy regions, that he resolved to retire thither to spend the rest of his life in quiet and happiness. But having communicated this design to the Celtic pirates, they immediately abandoned him, and set sail for Africa, with an intention to assist one of the barbarous kings against his subjects who had rebelled. Upon this Sertorius retired thither also, but took the opposite side; and having defeated the king named *Africanus*, obliged him to shut himself up in the city of *Lingis*, now *Tangier*, which he closely besieged. But in the mean time *Pacianus*, who had been sent by *Sylla* to assist the king, advanced with a considerable army against Sertorius. Upon this the latter, leaving part of his forces before the city, marched with the rest to meet *Pacianus*, whose army, though greatly superior to his own in number, he entirely defeated; killed the general, and took all his forces prisoners.—The fame of this victory soon reached Spain; and the Lusitanians, being threatened with a new war from *Annus*, invited Sertorius to head their armies. With this request he very readily complied, and soon became very formidable to the Romans. *Titus Didius*, governor of that part of Spain called *Bætica*, first entered the lists with him; but he being defeated, *Sylla* next dispatched *Metellus*, reckoned one of the best commanders in Rome, to stop the progress of this new enemy. But *Metellus*, notwithstanding all his experience, knew not how to act against Sertorius, who was continually changing his situation, putting his army into new forms, and contriving new stratagems. On his first arrival he sent for *L. Domitius*, then prætor of *Hispania*, to his assistance; but *Sertorius* being informed of his march, detached *Bertholus*, or *Hercules*, his quaestor, against him, who gave him a total overthrow. *Metellus* then dispatched *Lucius Lollius* prætor of *Narbonne* Gaul against *Hirculus*; but he met with no better success, being utterly defeated, and his date of general killed.

The fame of these victories brought to the camp of *Sertorius* such a number of *Hispania* Roman citizens as to form a new settlement, that he formed a design of erecting a Republic in a republic in opposition to that of Rome. *Sylla* was continually sending fresh supplies to *Metellus*; but he came with a handful of men, accosted to range about the mountains, to endure hunger and thirst, and live exposed to the inclemencies of the weather, to harass the Roman army, that *Metellus* should be obliged to retire. At last, *Sertorius*, being that *Metellus* had been disrespec-

fully of his courage, challenged his antagonist to end the war by single combat; but *Metellus* very prudently declined the combat, as being advanced in years; yet this refusal brought upon him the contempt of the unthinking multitude, upon which *Metellus* resolved to retrieve his reputation by some signal exploit, and therefore laid siege to *Lacobriga*, a considerable city in those parts. This he hoped to reduce in two days, as there was but one well in the place; but *Sertorius* having previously removed all those who could be of no service during the siege, and conveyed 6000 skins full of water into the city, *Metellus* continued a long time before it without making any impression. At last, his provisions being almost spent, he sent out *Aquinus* at the head of 6000 men to procure a new supply; but *Sertorius* falling unexpectedly upon them, cut in pieces or took the whole detachment; the commander himself being the only man who escaped to carry the news of the disaster; upon which *Metellus* was obliged to raise the siege with disgrace.

And now *Sertorius*, having gained some intervals of ease in consequence of the many advantages he obtained over the Romans, began to civilize his new subjects. Their savage and furious manner of fighting he changed for the regular order and discipline of a well-formed army; he bestowed liberally upon them gold and silver to adorn their arms, and by conversing familiarly with them, prevailed with them to lay aside their own dress for the Roman *toga*. He sent for all the children of the principal people, and placed them in the great city of *Olea*, now *Huelva*, in the kingdom of *Argon*, where he appointed them masters to instruct them in the Roman and Greek learning, that they might, as he pretended, be capable of sharing with him the government of the republic. Thus he made them really hostages for the good behaviour of their parents; however, the latter were greatly pleased with the care he took of their children, and all *Lusitania* were in the highest degree attached to their new sovereign. This attachment he took care to heighten by the power of superstition; for having procured a young hind of a milk-white colour, he made it so tame that it followed him wherever he went; and *Sertorius* gave out to the ignorant multitude, that this hind was inspired by *Diana*, and revealed to him the designs of his enemies, of which he always took care to be well informed by the great numbers of spies whom he employed.

While *Sertorius* was thus employed in establishing his authority, the republic of Rome, alarmed at his success, resolved to crush him at all events. *Sylla* was now dead, and all the eminent generals in Rome solicited this honourable though dangerous employment. After much debate a decree was passed in favour of *Pompey* the Great, but without recalling *Metellus*. In the mean time, the troops of one *Perpenna*, or *Perperna*, had, in spite of all that their general could do, abandoned him, and taken the oath of allegiance to *Sertorius*. This was a most essential advantage to *Sertorius*; for *Perpenna* commanded an army of 33,000 men, and had come into Spain with a design to settle there as *Sertorius* had done; but as he was discontented from one of the first families of Rome, he thought it below his dignity to serve under any general, however eminent he might be. But the troops of *Perpenna* were of a different opinion, and therefore declaring that they would

Spain, Obliged to raise the Siege of Lacobriga.

Spain, and Obliged to raise the Siege of Lacobriga.

Spain, and Obliged to raise the Siege of Lacobriga.

Spain,

Obliged to raise the Siege of Lacobriga.

Spain, and Obliged to raise the Siege of Lacobriga.

Spain, and Obliged to raise the Siege of Lacobriga.

Spain, and Obliged to raise the Siege of Lacobriga.

Spain, and Obliged to raise the Siege of Lacobriga.

and Andalusia; and Lusitania, comprehending the greater part of Extremadura, and the modern kingdom of Portugal. The province called *Tarracensis* was then inhabited by the following tribes, viz. the *Ausciani*, occupying the sea coast, at the north-east, between the Ter and the Lobregat, and having for their capital Germa; the *Cerretani*, inhabiting the district of Cerdania, at the foot of the Pyrenees, whose capital was Julia, the modern Livia; the *Falsetani*, occupying the sea coast between the rivers Ter and Lobregat, in the immediate neighbourhood of the *Ausciani*, and whose capital was Barcelona; the *Celsetani* to the left of the mouth of the Ebro, with Tarragona for their capital; the *Lacetani*, on the left bank of the river *Sicoris*; the *Ilurgetes*, extending from that river to the small stream Gillego, which joins the Ebro near Zaragoza, whose capital was Lerida; the *Jacetani* in the northern extremity of Aragon, having their seat of government at Jaca; the *Vascones* in Navarre, and the *Varduli* in the modern Guipuzcoa. These nations occupied the southern and eastern parts of the province. The northern was possessed by the *Carisii*, the *Ostreogones*, both in Biscay; the *Cantabri*, cantoned near the source of the Ebro, and along the bay of Biscay; the *Astures* in Asturias and part of Leon; the *Callisci* in Galicia; the *Vaccini* along the Douro; the *Arbaci* in Old Castile; the *Celtiberi*, between the Ebro and the source of the Tago, and many others of inferior note.

Lusitania was held by three principal tribes, the *Lusani*, occupying the greater part of the province, and having for their capital the modern Lisbon; the *Trojanos* and the *Celtici*.

Betica was inhabited by the *Turdetani*, the *Turduli*, the *Bastitani*, and the *Bastuli*.

All these districts, with their principal towns, are minutely treated of by Dr Poyfair, in the first volume of his geography.

When incorporated with the Roman empire, Spain partook of its tranquillity, and received in exchange for her liberty, at least wise laws and a mild government. If she could not prevent herself from falling under the dominion of the masters of the world, she was at least the most powerful, the richest, and the happiest province of their empire. Cluverius has left us an interesting account of her agriculture under the first emperors. The tradition of her ancient population is probably exaggerated, but the ruins of several towns prove it to have been considerable. It was increased by a great many Roman families after the conquest; several colonies were established in Spain; 25 colonies were distributed in the most fertile parts of the country, and intermarried with the inhabitants. After a while the Spaniards, seeing it ill in matters of countrymen, were the first to solicit the rights of Roman citizens, by which they were completely consolidated. Some municipal towns went so far as to desire permission to take the title of colonies, though in the change they lost their independence, nearly in the same manner as certain proprietors of lands under the feudal system converted their domains into fiefs, in order to enjoy the honours attached to them. The government was, in general, milder in Spain than in the other Roman provinces. The administration was carried on in the towns by magistrates named by themselves, and the different provinces were under the super-

intendant lance of, aetors, proconsuls, and legates or deputies, according to the different eras of the Roman empire; those in their respective departments took care of all the works of public utility, the aqueducts, baths, circuses, and highways, whose magnificent ruins are still existing; but they were principally employed in collecting the revenues of the state, which were singularly analogous to those of the present times. They principally arose from dues, fines, or alienations of property, and the produce of the mines. Spain at that time drew from her own mines the same riches she now draws from the new world, and they were distributed in nearly the same manner. One part belonged to the state, and the other to the inhabitants of the country, who paid a certain duty on the metals which they procured from the mines. Their returns went on increasing, and depended entirely on the number of hands which could be devoted to work in the mines. An employment, so laudable, however, which required a numerous population, tended to diminish that population by the excessive fatigues which it occasioned. Agriculture also suffered by the accumulation of estates in the hands of a few wealthy landholders. By the little attention paid to it by the proprietors, and by the defects inseparable from the system of cultivation by means of slaves, commerce and industry languished; and Spain, after having shared in the splendor of the Roman empire, was beginning to participate in its decline, when a new calamity, by completing her ruin, prepared her regeneration.

This calamity was the irruption of the northern hordes, which soon involved Spain in the general attack. This province was invaded first by the Franks, who in the third century had entered Gaul with a formidable force.

The Rhine, though dignified by the title of Safeguard Spain in the 45th of the Provinces, was an imperfect barrier against the daring spirit of enterprise with which the Franks were actuated. Their rapid devastations stretched from the river to the foot of the Pyrenees; nor were they stopped by those mountains. Spain, which had never dreaded, was unable to resist the inroads of the Germans. During 12 years, the greatest part of the reign of Gallienus, that opulent country was the theatre of unequal and destructive hostilities. Tarragona, the flourishing capital of a peaceful province, was sacked and almost destroyed; and so late as the days of Orosius, who wrote in the 5th century, wretched cottages, scattered amidst the ruins of magnificent cities, still recorded the rage of the barbarians. When the exhausted country no longer supplied a variety of plunder, the Franks seized on some vessels, and retreated to Mauritania.

The situation of Spain, separated, on all sides, from the 46
the enemies of Rome, by the sea, by the mountains, and by the intermediate provinces, had secured the long tranquility of that remote and sequestered country; and we may observe, as a sure symptom of domestic happiness, that, in a period of 420 years, Spain furnished very few materials to the history of the Roman empire. The footsteps of the Barbarians, who, in the reign of Gallienus, had penetrated beyond the Pyrenees, were soon obliterated by the return of peace; and in the 4th century of the Christian era, the cities of Emerita or Merida, of Corduba, Seville, Bracara, and Tarragona, were numbered with the most illustrious of the Roman world.

The

Spain in the 45th of the Provinces, was an imperfect barrier against the daring spirit of enterprise with which the Franks were actuated. Their rapid devastations stretched from the river to the foot of the Pyrenees; nor were they stopped by those mountains. Spain, which had never dreaded, was unable to resist the inroads of the Germans. During 12 years, the greatest part of the reign of Gallienus, that opulent country was the theatre of unequal and destructive hostilities. Tarragona, the flourishing capital of a peaceful province, was sacked and almost destroyed; and so late as the days of Orosius, who wrote in the 5th century, wretched cottages, scattered amidst the ruins of magnificent cities, still recorded the rage of the barbarians. When the exhausted country no longer supplied a variety of plunder, the Franks seized on some vessels, and retreated to Mauritania.

An. 459.

Spain. The various plenty of the animal, the vegetable, and the mineral kingdoms, was improved and manufactured by the skill of an industrious people; and the peculiar advantages of naval stores contributed to support an extensive and profitable trade. The arts and sciences flourished under the protection of the emperors; and if the character of the Spaniards was enticed by peace and servitude, the hostile approach of the Germans, who had spread terror and desolation from the Rhine to the Pyrenees, seemed to rekindle some sparks of military ardour. As long as the defence of the mountains was intrusted to the hardy and faithful militia of the country, they successfully repelled the frequent attempts of the Barbarians. But no sooner had the national troops been compelled to resign their post to the Huno-Goth bands, in the service of Constantine, than the gates of Spain were treacherously betrayed to the public enemy, about ten months before the sack of Rome by the Goths. The consciousness of guilt, and the thirst of rapine, prompted the mercenary guards of the Pyrenees to desert their station; to invite the arms of the Suevi, the Vandals, and the Alani; and to swell the torrent which was poured with irresistible violence from the frontiers of Gaul to the foot of Africa. The misfortunes of Spain may be described in the language of its most eloquent historian, who has concisely expressed the passionate, and perhaps exaggerated, declamations of contemporary writers. "The invasion of these nations was followed by the most dreadful calamities; as the Barbarians exercised their indiscriminate cruelty on the fortunes of the Romans and the Spaniards; and ravaged with equal fury the cities and the open country. The plagues of famine relaxed the miserable inhabitants to feed on the flesh of their fellow creatures; and even the wild beasts, who multiplied, without control, in the deserts, were exhausted, by the taste of blood, and the impatience of hunger, boldly to attack and devour their human prey. Pesticence soon appeared, the inseparable companion of famine; a large proportion of the people was swept away; and the groans of the dying excited only the envy of their surviving friends. At length the Barbarians, satiated with carnage and rapine, and afflicted by the contagious evil which they themselves had introduced, fixed their permanent seats in the desolated country. The ancient Gallia, whose limits included the kingdom of Old Castile, was divided between the Suevi and the Vandals, the Alani were settled over the provinces of Carthagen and Lusitania, and from the Mediterranean to the Atlantic ocean; and the fruitful territory of Bœtica was allotted to the Sævi, and her branch of the Vandalic nation. After regulating this partition, the conquering conquerors, with their new subjects, some reciprocal engagements of protection and obedience; the lands were again cultivated; and the towns and villages were again covered by a happy people. The great extent of the Spaniards were not disposed to prefer this new condition of peace and barbarism, to the severe oppressions of the Barbaric tyrants; yet there were many who still desired their former freedom, and who refused, more especially the mountains of Gætulia, to submit to the yoke of Rome."¹

The important contest of the heads of divisions and Sebastian, had annexed the provinces of Adolphus, and rebounded Gaul to the obedience of his brother Honorius. Peace was inconceivable with the situation and

temper of the king of the Goths. He readily accepted the proposal of turning his victorious arms against the barbarians of Spain; the troops of Constantius intercepted his communication with the sea-parts of Gaul, and gently pressed his march towards the Pyrenees. He passed the mountains, and surprised, in the name of the emperor, the city of Barcelona. The conduct of Adolphus to his punishment. Placidia, was attacked by time or possession; and the birth of a son, furnished, from his illustrious grandeur, Theodosius, appeared to fix him for ever in the interest of the republic. The loss of that infant, whose remains were deposited in a silver coffin in one of the churches near Barcelona, afflicted his parents; but the grief of the Gothic king was suspended by the labours of the field; and the course of his victories was soon interrupted by domestic treason. He had imprudently received into his service one of the followers of Suisa; a barbarian of a daring spirit, but of a diminutive stature; whose secret desire of revenging the death of his beloved patron, was continually incited by the fascinations of his insolent master. Adolphus was assassinated in the palace of Barcelona; the laws of the succession were violated by a tumultuous faction; and a stranger to the royal race, Singa, the brother of Suisa himself, was seated on the Gothic throne. The first act of his reign was the inhuman murder of the six children of Adolphus, the issue of a former marriage, whom he took, without pity, from the feeble arms of a venerable bishop. The unfortunate Placidia, instead of the respected companion, which the night have excited in the most savage breasts, was treated with cruel and unchristian insult. The daughter of the emperor Theodosius, who founded among a crowd of vulgar captives, was compelled to march on foot above 12 miles, before the house of a barbarian, the assassin of a husband whom Placidia loved and lamented.

But Placidia soon obtained the pleasure of revenge; and the view of her ignominious sufferings might rouse in an indignant people against the tyrant, who was assassinated on the seventh day of his usurpation. After the death of Singa, the free choice of the nation bestowed the Gothic sceptre on Wallia, whose warlike and ambitious temper appeared, in the beginning of his reign, extremely hostile to the republic. He marched, in arms, from Barcelona to the shores of the Atlantic ocean, which the Romans revered and dreaded as the boundary of the world. But when he reached the southern promontory of Spain, and, from the rock now covered by the ruins of Gibraltar, contemplated the neighbouring and fertile coast of Africa, Wallia refused the dregs of conquest, which had been interrupted by the death of Africa. The winds and waves disappointed the enterprises of the Goths; and the minds of a superstitious people were deeply affected by the reported disasters of Rome and its wrecks. In this disposition, the successor of Adolphus no longer refused to listen to a Roman ambassador, whose proposals were enforced by the real, or supposed, approach of a numerous army, under the conduct of the brave Constantius. A solemn treaty was stipulated and observed; Placidia was honourably restored to her father; her two nephews of whom she was delivered to the Vandalic Goths; and Wallia engaged to draw his sword in the service of the empire. A bloody war was instantly excited among the Barbarians of Spain; and the contending princes are said to

Spain.

An. 415.

An. 415.
—100.

• Mirissa de reb. Hisp. 247. c. 1. v.

have addressed their letters, their ambassadors, and their legates, to the throne of the western emperor, exhorting him to remain a tranquil spectator of their contest; the event of which must be favourable to the Romans, by the mutual slaughter of their common enemies. The Spanish war was ultimately supported, during three campaigns, with desperate valour, and various success; and the marvellous achievements of Wallia diffused through the empire the superior renown of the Gothic hero. He exterminated the Silingi, who had irretrievably ruined the elegant plenty of the province of Bætica. He flew in battle the king of the Alani; and the remains of those Scythian wanderers, who escaped from the field, instead of choosing a new leader, humbly sought a refuge under the standard of the Vandals, with whom they were ever afterwards confounded. The Vandals themselves, and the Suevi, yielded to the efforts of the invincible Goths. The promiscuous multitude of barbarians, whose retreat had been intercepted, were driven into the mountains of Gallicia, where they still continued, in a narrow compass, and on a barren soil, to exercise their domestic and implacable hostilities. In the pride of victory, Wallia was faithful to his engagements; he restored his Spanish conquests to the obedience of Honorius; and the tyranny of the imperial officers soon reduced an oppressed people to regret the time of their barbarian servitude. While the event of the war was still doubtful, the first advantages obtained by the arms of Wallia, had encouraged the court of Ravenna to decree the honours of a triumph to their feeble sovereign. He entered Rome like the ancient conquerors of nations; and if the monuments of servile corruption had not long since met with the fate which they deserved, we should probably find that a crowd of poets, and orators, of magistrates and bishops, applauded the fortune, the wisdom, and the invincible courage, of the emperor Honorius.

After the retreat of the Goths, the authority of Honorius had obtained a precarious establishment in Spain; except only in the province of Gallicia, where the Suevi and the Vandals had fortified their camps, in mutual discord, and hostile independence. The Vandals prevailed; and their adversaries were besieged in the Nervæan hills, between Leon and Oviedo, till the approach of Count Alerius compelled, or rather provoked, the victorious barbarians to remove the scene of the war to the plains of Bætica. The rapid progress of the Vandals soon required a more effectual opposition; and the master-general Cossinus marched against them with a numerous army of Romans and Goths. Vanquished in battle by an inferior enemy, Cossinus fled with dishonour to Tarragona; and this memorable defeat, which has been represented as the punishment, was most probably the effect, of his rash presumption. Seville and Carthæna became the reward, or rather the prey, of the kracious conquerors; and the vessels which they found in the harbours of Carthæna, might easily transport them to the hills of Majorca and Minorca, where the Spanish fugitives, as in a secure reef, had vainly concealed their families and their fortunes. The experience of navigation, and perhaps the prospect of Africa, induced the Vandals to accept the invitation which they received from Count Bonifacius; and the death of Theodoric served only to forward and animate the bold enterprise. In the room of a prince, not conspicuous

for any superior powers of the mind or body, they acquired his bastard brother, the terrible Genferic; a name which, in the destruction of the Roman empire, has deserved an equal rank with the names of Attila and Attila. Almost in the moment of his departure he was informed, that Hermanric, king of the Suevi, had presumed to ravage the Spanish territories, which he was resolved to abandon. Impatient of the insult, Genferic pursued the hasty retreat of the Suevi as far as Merida; precipitated the king and his army into the river Anas, and calmly returned to the sea shore, to embark his victorious troops. The vessels which transported the Vandals over the modern straits of Gibraltar, a channel only twelve miles in breadth, were furnished by the Spaniards, who anxiously wished their departure; and by the African general, who had implored their formidable assistance.

When Theodoric king of the Visigoths encouraged Avitus to assume the purple, he offered his person and his forces, as a faithful soldier of the republic. The exploits of Theodoric soon convinced the world, that he had not degenerated from the warrior virtues of his ancestors. After the establishment of the Goths in Aquitaine, and the passage of the Vandals into Africa, the Suevi, who had fixed their kingdom in Gallicia, aspired to the conquest of Spain, and threatened to extinguish the feeble remains of the Roman dominion. The provincials of Carthæna and Tarragona, afflicted by an hostile invasion, represented their injuries and their apprehensions. Count Fronto was dispatched, in the name of the emperor Avitus, with advantageous offers of peace and alliance; and Theodoric interposed his weighty mediation, to declare that, unless his brother-in-law, the king of the Suevi, immediately retired, he should be obliged to arm in the cause of justice and of Rome. "Tell him," replied the haughty Recharius, "that I despise his friendship and his arms; but that I shall soon try, whether he will dare to expect my arrival under the walls of Thoulouse." Such a challenge urged Theodoric to prevent the bold designs of his enemy: He passed the Pyrenees at the head of the Visigoths; the Franks and Burgundians served under his standard; and though he professed himself the dutiful servant of Avitus, he privately stipulated, for himself and his successors, the absolute possession of his Spanish conquests. The two armies, or rather the two nations, encountered each other on the banks of the river Urbicus, about 12 miles from Allorga; and the decisive victory of the Goths appeared for a while to have extirpated the name and kingdom of the Suevi. From the field of battle Theodoric advanced to Braga, their metropolis, which still retained the splendid vestiges of its ancient commerce and dignity. His entrance was not polluted with blood, and the Goths respected the chastity of their female captives, more especially of the consecrated virgins; but the greatest part of the clergy and people were made slaves, and even the churches and altars were confounded in the universal pillage. The unfortunate king of the Suevi had escaped to one of the ports of the ocean; but the officious of the winds opposed his flight; he was delivered to his implacable rival; and Recharius, who neither desired nor expected mercy, received, with manly constancy, the death which he would probably have inflicted. After this bloody sacrifice to policy or resentment, Theodoric carried his

An. 456.

An. 441.

Spain.

victorious arms as far as Merida, the principal town of Lusitania, without meeting any resistance, except from the miraculous powers of St. Eulalia; but he was dropped in the full career of success, and recalled from Spain, before he could provide for the security of his conquests. In his retreat towards the Pyrenees, he re-vengeed his disappointment on the country through which he passed; and in the sack of Pallentia and A-flordia, he showed himself a faithless ally, as well as a cruel enemy.

Reccared was the first Catholic king of Spain. He had imbibed the faith of his unfortunate brother, and he supported it with more prudence and success. Instead of revolting against his father, Reccared patiently expected the hour of his death. Instead of condemning his memory, he piously supposed, that the dying monarch had abjured the errors of Arianism, and recommended to his son the conversion of the Gothic nation. To accomplish that salutary end, Reccared convened an assembly of the Arian clergy and nobles, declared himself a Catholic, and exhorted them to imitate the example of their prince. The libidinous interpretation of doubtful texts, or the curious pursuit of metaphysical arguments, would have excited endless controversy; and the monarch discreetly proposed to his illiterate audience, two substantial and visible arguments, the testimony of Earth and of Heaven. The Earth had submitted to the Nicene synod; the Romans, the Barbarians, and the inhabitants of Spain, unanimously professed the same orthodox creed; and the Visigoths resisted, almost alone, the consent of the Christian world. A superstitious age was prepared to reverence, as the testimony of Heaven, the preternatural cures which were performed by the skill or virtue of the Catholic clergy; the baptismal fonts of Orléans in Batavia, which were spontaneously replenished each year, on the vigil of Easter; and the miraculous shrine of St. Martin of Tours, which had already converted the Suevic prince and people of Gallia. The Catholic king encountered some difficulties on this important change of the national religion. A conspiracy, secretly fomented by the queen-dowager, was formed against his life; and two counts excited a dangerous revolt in the Narbonnese Gaul. But Reccared dismissed the conspirators, defeated the rebels, and executed severe justice; which the Arians, in their turn, might brand with the reproach of persecution. Eminent bishops, whose names betray their Barbaric origin, abjured their errors; and all the books of Arian theology were reduced to ashes, with the heads in which they had been purposely collected. The whole body of the Visigoths and Saevi were allured or driven into the pace of the Catholic communion; the faith, at least, of the rising generation, was fervent and sincere; and the devout liberality of the Barbarians enriched the churches and monasteries of Spain. Seventy bishops assembled in the council of Toledo, received the institution of their congregations; and the zeal of the emperor, improved the Nicene creed, by declaring the procession of the Holy Ghost from the Son, as well as from the Father; a weighty note of doctrine, which produced, long afterwards, the schism of the Greeks, and Latin churches. The royal palace became more fully fortified and consolidated. The crown assumed the Great, a learned and holy prelate, whose talents were distinguished by the conversion of Ireland, and St. Patrick. The ambassadors of Reccared

respectfully offered on the threshold of the Vatican his rich presents of gold and gems; they accepted, as a lucrative exchange, the hairs of St. John the Baptist; a cross, which inclosed a small piece of the true wood; and a key, that contained true particles of iron which had been scraped from the chains of St. Peter.

After their conversion from idolatry or heresy, the Franks and the Visigoths were disposed to embrace, with equal submission, the inherent evils, and the accidental benefits of superstition. But the prelates of France, long before the extinction of the Merovingian race, had degenerated into fighting and hunting barbarians. They detained the use of synods; forgot the laws of temperance and chastity, and preferred the indulgence of private ambition and luxury, to the greatest interest of the sacerdotal profession. The bishops of Spain respected themselves, and were respected by the public: their indissoluble union disguised their vices, and confirmed their authority; and the regular discipline of the church introduced peace, order, and stability into the government of the state. From the reign of Reccared, the first Catholic king, to that of Witiza, the immediate predecessor of the unfortunate Roderic, sixteen national councils were successively convened. The six metropolitans, Toledo, Seville, Merida, Braga, Tarragona and Narbonne, presided according to their respective seniority; the assembly was composed of their suffragan bishops, who appeared in person, or by their proxies; and a place was assigned to the most holy, or opulent, of the Spanish abbots. During the first three days of the convocation, as long as they agitated the ecclesiastical questions of doctrine and discipline, the profane lay was excluded from their debates; which were conducted, however, with decent solemnity. But, on the morning of the fourth day, the doors were thrown open for the entrance of the great officers of the palace, the dukes and counts of the provinces, the judges of the cities, and the Gothic nobles; and the decrees of Heaven were ratified by the consent of the people. The same rules were observed in the provincial assemblies, the annual synods, which were empowered to hear complaints, and to redress grievances; and a legal government was supported by the prevailing influence of the Spanish clergy. The bishops who, in each revolution, were prepared to flatter the victorious, and to punish the prostrate, laboured, with diligence and success, to kindle the flames of persecution, and to exalt the mitre above the crown. Yet the national councils of Toledo, in which the free spirit of the Barbarians was tempered, and guided by episcopal policy, have established some prudent laws for the benefit of the king and people.

The vacancy of the throne was supplied by the choice of the bishops and palatines; and after the failure of the line of Maric, the regal dignity was still limited to the pure and noble blood of the Goths. The clergy, who anointed their lawful prince, always recommended, and sometimes proscribed, the duty of allegiance; and the spiritual censures were denounced on the heads of the impious subjects, who should resist his authority, consume a point his life, or violate, by an indecent union, the chastity even of his wives. But the monarch himself, when he ascended the throne, was bound by a religious oath to God and his people, that he would faithfully execute his important trust. The royal and imaginary faults of his administration were to be re-

Spain.

Gilbert's
St. Geo. 410
vol. III.
p. 549.

49
Legislative
assemblies
of the
Goths in
Spain.

48
Introduction
of
Christianity.
An. 586.
589.

the control of a powerful aristocracy; and the bishops and palatines were guarded by a fundamental privilege that they should not be degraded, imprisoned, tortured, nor punished with death, exile, or confiscation, unless by the free and public judgement of their peers.

59
Code of the Visigoths.

One of these legislative councils of Toledo, examined and ratified the code of laws which had been compiled by a succession of Gothic kings, from the fierce Eurice, to the devout Egica. As long as the Visigoths themselves were furnished with the rude customs of their ancestors, they indulged their subjects of Aquitaine and Spain in the enjoyment of the Roman law. Their gradual improvement in arts, in policy, and at length in religion, encouraged them to imitate, and to supersede, these foreign institutions, and to compose a code of civil and criminal jurisprudence, for the use of a great and united people. The same obligations, and the same privileges, were communicated to the nations of the Spanish monarchy; and the conquerors, insensibly renouncing the Teutonic idiom, submitted to the restraints of equity, and exalted the Romans to the participation of freedom. The merit of this impartial policy was enhanced by the situation of Spain, under the reign of the Visigoths. The provincials were long separated from their Asian masters, by the irreconcilable difference of religion. After the conversion of Recared had removed the prejudices of the Catholics, the coasts, both of the ocean and Mediterranean, were still possessed by the Eastern emperors, who secretly excited a discontented people to reject the yoke of the barbarians, and to assert the name and dignity of Roman citizens. The allegiance of doubtful subjects is indeed most effectually secured by their own persuasion, that they hazard more in a revolt, than they can hope to obtain by a revolution; but it has appeared so natural to oppress those whom we hate and fear, that the contrary system well deserves the praise of wisdom and moderation.

61
The Gothic monarchy was overthrown by the Saracens.

The Gothic princes continued to reign over a considerable part of Spain till the beginning of the 5th century, when their empire was overthrown by the Saracens. During this period, they had entirely expelled the eastern emperors from what they possessed in Spain, and even made considerable conquests in Barbary; but towards the end of the 7th century the Saracens overran all that part of the world with a rapidity which nothing could resist; and having soon possessed themselves of the Gothic dominions in Barbary, they made a descent upon Spain about the year 711 or 712. The king of the Goths at that time was called *Roderic*, and by his bad conduct had occasioned great dissatisfaction among his subjects. He therefore determined to put all to the issue of a battle, knowing that he could not depend upon the fidelity of his own people if he allowed the enemy time to tamper with them. The two armies met in a plain near Xeres in Andalusia. The Goths began the attack with great fury; but though they fought like men in despair, they were at last defeated with excessive slaughter, and their king himself was supposed to have perished in the battle, being never more heard of.

By this battle the Moors in a short time rendered themselves masters of almost all Spain. The poor remains of the Goths were obliged to retire into the

mountainous parts of Asturias, Burgos, and Biscay: the inhabitants of Aragon, Catalonia, and Navarre, though they might have made a considerable stand against the enemy, chose for the most part to retire into France. In 718, however, the power of the Goths began again to revive under Don Pelagio or Pelayo, a prince of the royal blood, who headed those that had retired to the mountains after the fatal battle of Xeres. The place where he first laid the foundation of his government was in the Asturias, in the province of Liebana, about nine leagues in length and four in breadth. This is the most inland part of the country, full of mountains enormously high, and so much fortified by nature, that its inhabitants are capable of resisting almost any number of invaders. Alakor the Saracen governor was no sooner informed of this revival of the Gothic kingdom, than he sent a powerful army, under the command of one Alchaman, to crush Don Pelagio before he had time to establish his power. The king, though his forces were sufficiently numerous (every one of his subjects arrived at man's estate being a soldier), did not think proper to venture a general engagement in the open field; but taking post with part of them himself in a cavern in a very high mountain, he concealed the rest among precipices, giving orders to them to fall upon the enemy as soon as they should perceive him attacked by them. These orders were punctually executed, though indeed Don Pelagio himself had repulsed his enemies, but not without a miracle, as the Spanish historians pretend. The slaughter was dreadful; for the troops who lay in ambushade joining the rest, and rolling down huge stones from the mountains upon the Moors (the name by which the Saracens were known in Spain), no fewer than 124,000 of these unhappy people perished in one day. The remainder fled till they were stopped by a river, and beginning to coast it, part of a mountain suddenly fell down, stopped up the channel of the river, and either crushed or drowned, by the sudden rising of the water, almost every one of that vast army.

57
The power of the Goths revived under Pelagio.
An. 718.

64
The Saracens a dreadful overthrow.

The Moors were not so much disheartened by this disaster, but that they made a second attempt against Don Pelagio. Their success was as bad as ever, the greater part of their army being cut in pieces or taken; in consequence of which, they lost all the Asturias, and never dared to enter the limits with Pelagio afterwards. Indeed, their bad success had in a great measure taken from them the desire of conquering a country where little or nothing was to be gained; and therefore they rather directed their force against France, where they hoped for more plunder. Into this country they poured in prodigious multitudes; but were utterly defeated, in 732, by Charles Martel, with the loss of 300,000 men, as the historians of those times pretend.

64
Another army cut in pieces or taken.

The subsequent history of Spain is rendered so confused by the numerous kingdoms that were established either by the Christians or the Moors, that some chronological guide is necessary to make it intelligible. Before pursuing the thread of the narration, we shall lay before our readers the following chronological table of the cotemporary monarchs from Pelagio to Ferdinand VII.

Chronological TABLE of the Kings of Spain.

Year.	Asturias and Leon.	Castile.	Aragon.	Navarre.	Saracens.
718	Pelagius.				
737	Favila.				
739	Alphonso I.				
755	- - -	- - -	- - -	- - -	Abdoulrahman I.
758	Froila I.				
768	Aurelio.				
774	Silo.				
783	Mauregat.				
788	Bermudo I.	- - -	- - -	- - -	Hiffem.
791	Alphonso II.				
795	- - -	- - -	- - -	- - -	Hachem.
822	- - -	- - -	- - -	- - -	Abdoulrahman II.
845	Ramiro I.				
851	Ordogno I.			Garcias Ximenes.	
853	- - -	- - -	- - -	- - -	Mahomet.
862	Alphonso III.				
880	- - -	- - -	- - -	Fortunio I.	
886	- - -	- - -	- - -	- - -	Almundar.
888	- - -	- - -	- - -	- - -	Abdallah.
925	- - -	- - -	- - -	Sancho I.	
910	Garcias.				
912	- - -	- - -	- - -	- - -	Abdoulrahman III.
913	Ordogno II.				
923	Froila II.				
924	Alphonso IV.				
926	- - -	- - -	- - -	Garcias II.	
927	Ramiro II.				
950	Ordogno III.				
956	Sancho.				
961	- - -	- - -	- - -	- - -	Alhacan.
967	Ramiro III.				
976	- - -	- - -	- - -	- - -	Hiffem.
978	- - -	- - -	- - -	Sancho II.	
982	Bermudo II.				
994	- - -	- - -	- - -	Garcias III.	
999	Alphonso V.				
1000	- - -	- - -	- - -	Sancho III.	
1014	- - -	- - -	- - -	- - -	Cordova overthrowed.
1027	Bermudo III.				
1035	- - -	- - -	Ramiro I.	Garcias IV.	
1037	Sancho I. Ferdinand I. of Castile.	Ferdinand I.			
1054	- - -	- - -		Sancho IV.	
1063	- - -	- - -	Sancho.		
1067	Sancho II.	Sancho I.			
1073	Alphonso VI.	Alphonso I.			
1076	- - -	- - -		Sancho V.	
1094	- - -	- - -	Pedro I.	Pedro I.	
1104	- - -	- - -	Alphonso I.	Alphonso I.	
1109	Urraca.	Alphonso II.			
1112	Alphonso VII.				

<i>Year.</i>	<i>Asturias and Leon.</i>	<i>Castile.</i>	<i>Aragon.</i>	<i>Navarre.</i>	<i>Saracens.</i>
1126	Alphonso VIII.	Alphonso III.			
1134	- - -	- - -	Ramiro II.	Garcias V.	
1137	- - -	- - -	Petronilla.		
1150	- - -	- - -	- - -	Sancho VI.	
1157	Ferdinand II.	Sancho II.			
1168	- - -	Alphonso IV.			
1162	- - -	- - -	Alphonso II.		
1188	Alphonso IX.	- - -	- - -	Sancho VII.	
1194	- - -	- - -	- - -		
1196	- - -	- - -	Pedro II.		
1213	- - -	- - -	James I.		
1214	- - -	Henry.			
1217	- - -	Berenger. Ferd. I.			
1234	- - -	- - -	- - -	Thibaut I.	
1236	- - -	- - -	- - -	- - -	Mahomet.
1252	- - -	Alphonso V.			
1253	- - -	- - -	- - -	Thibaut II.	
1270	- - -	- - -	- - -	Henry.	
1273	- - -	- - -	- - -	- - -	Muley.
1274	- - -	- - -	- - -	Joanna.	
1276	- - -	- - -	Pedro III.		
1284	- - -	Sancho III.			
1285	- - -	- - -	Alphonso III.		
1291	- - -	- - -	James II.		
1295	- - -	Ferdinand II.			
1302	- - -	- - -	- - -	- - -	Mahomet II.
1304	- - -	- - -	- - -	Lewis.	
1310	- - -	- - -	- - -	- - -	Nazer.
1312	- - -	Alphonso VI.			
1315	- - -	- - -	- - -	- - -	Eimael.
1316	- - -	- - -	- - -	Philip.	
1322	- - -	- - -	- - -	Charles.	
1326	- - -	- - -	- - -	- - -	Mahemet III.
1327	- - -	- - -	Alphonso IV.		
1328	- - -	- - -	- - -	Joanna II.	
1333	- - -	- - -	- - -	- - -	Juzaf I.
1336	- - -	- - -	Pedro IV.		
1349	- - -	- - -	- - -	Charles II.	
1350	- - -	Pedro.			
1354	- - -	- - -	- - -	- - -	Lago I.
1369	- - -	Henry II.			
1374	- - -	- - -	- - -	- - -	Mahomet IV.
1379	- - -	John.			Mahomet V.
1387	- - -	- - -	- - -	Charles III.	
1390	- - -	Henry III.			
1392	- - -	- - -	- - -	- - -	Juzaf II.
1395	- - -	- - -	Martin.		
1396	- - -	- - -	- - -	- - -	Ball a.
1404	- - -	John II.			
1408	- - -	- - -	- - -	- - -	Juzaf III.
1412	- - -	- - -	Ferdinand I.		
1416	- - -	- - -	Alphonso V.		
1423	- - -	- - -	- - -	- - -	El ziri.
1425	- - -	- - -	- - -	Blanche.	
1427	- - -	- - -	- - -	- - -	Zagair.
1432	- - -	- - -	- - -	- - -	Juzaf IV.
1441	- - -	- - -	- - -	John.	
1445	- - -	- - -	- - -	- - -	Pen O'min.

Spain	Year.	Asturias and Leon.	Castile.	Aragon.	Navarre.	Saracens.	Spain
	1450	- - -	Henry IV.	- - -	- - -		
	1455	- - -	- - -	- - -	- - -	Ismael.	
	1458	- - -	- - -	John II.	- - -		
	1459	- - -	- - -	Ferdinand II.	- - -		
	1474	- - -	Isabella and Ferdinand V.	- - -	- - -		
	1474	- - -	- - -	- - -	Eleonora.	Abuluffan.	
	1479	- - -	- - -	- - -	Francis.		
	1483	- - -	- - -	- - -	Catherine.		
	1485	- - -	- - -	- - -	John.	Abouabdalla.	
	1504	- - -	Joan.	- - -	- - -		
	1506	- - -	Philip I.	- - -	- - -		
	1516	- - -	Charles I.	- - -	Henry.		
	1553	- - -	- - -	- - -	Joanna III.		
	1556	- - -	Philip II.	- - -	Anthony.		
	1572	- - -	- - -	- - -	Henry.		
	1598	- - -	Philip III.	- - -	- - -		

Kings of Spain.

Years.	Monarchs.
	HOUSE OF AUSTRIA.
1516	Charles I. (V.).
1556	Philip II.
1598	Philip III.
1621	Philip IV.
1665	Charles II.
	HOUSE OF BOURBON.
1700	Philip V.
1723	Louis I.
1724	Philip V. again.
1746	Ferdinand VI.
1759	Charles III.
1788	Charles IV.
1808	Ferdinand VII.

Ab. 737. Don Pelagius died in 737, and soon after his death such intestine divisions broke out among the Moors, as greatly favoured the increase of the Christian power. In 745 Don Alouf the Catholic, son-in-law to Pelagius, in conjunction with his brother Felix, passed the mountains, and fell upon the northern part of Gallaecia; and meeting with little resistance, he recovered almost the whole of that province in a single campaign. Next year he invaded the plains of Leon and Gallicia; and before the Moors could assemble any force to oppose him, he reduced Astorga, Leon, Saldagna, Montes de Oza, Amaya, Alava, and all the country at the foot of the mountains. The year following he pushed his conquests as far as the borders of Portugal, and the next campaign ravaged the country as far as Castile. Being sensible, however, that he was yet unable to defend the flat country which he had conquered, he laid the whole

of it waste, obliged the Christians to retire to the mountains, and carried off all the Moors for slaves. Thus secured by a desert frontier, he met with no interruption for some years; during which time, as his kingdom advanced in strength, he allowed his subjects gradually to occupy part of the flat country, and to rebuild Leon and Astorga, which he had demolished. He died in 783, and was succeeded by his son Don Froila. In his time Abulhabmar, the Khalif's viceroy in Spain, threw off the yoke, and declared himself independent, fixing the seat of his government at Cordova. Thus the intestine divisions among the Moors were renewed; yet their forces were not so much diminished as before; for, in 781, Froila encountered the Moors with such success, that 24,000 of them were killed on the spot, and their general slain prisoner. Soon after he built the city of Oviedo, which he made

Spain. the capital of his dominions, in order to be in a better condition to defend the flat country, which he now determined to people.

57 History of the kingdom of Navarre. An. 832. In the year 830 the power of the Saracens received another blow by the rise of the kingdom of Navarre. This kingdom, we are told, took its origin from an accidental meeting of gentlemen, to the number of 600, at the tomb of an hermit named *John*, who had died among the Pyrenees. At this place, where they had met on account of the supposed sanctity of the deceased, they took occasion to converse on the cruelty of the Moors, the miseries to which the country was exposed, and the glory that would result from throwing off their yoke; which, they supposed, might easily be done, by reason of the strength of their country. On mature deliberation, the project was approved; one Don *Garcias Ximenes* was appointed king, as being of illustrious birth, and looked upon as a person of great abilities. He recovered *Aínsa*, one of the principal towns of the country, out of the hands of the infidels, and his successor *Don Garcias Inigas* extended his territories as far as *Biscay*; however, the Moors still possessed *Portugal*, *Murcia*, *Andalusia*, *Valencia*, *Granada*, *Tortosa*, with the interior part of the country as far as the mountains of *Castile* and *Zaragoza*. Their internal dissensions, which revived after the death of *Abdoulrahman*, contributed greatly to reduce the power of the infidels in general.

58 History of the Kingdom of Castile. In 778, Charles the Great being invited by some discontented Moorish governors, entered Spain with two great armies; one passing through *Catalonia*, and the other through *Navarre*, where he pushed his conquests as far as the *Ebro*. On his return he was attacked and defeated by the Moors; though this did not hinder him from keeping possession of all those places he had already reduced. At this time he seems to have been master of *Navarre*; however, in 831 *Count Azner*, revolting from *Peppin* son to the emperor *Louis*, asserted the independency of *Navarre*; but the sovereigns did not assume the title of kings till the time of *Don Garcias*, who began to reign in 857.

An. 921. In the mean time, the kingdom founded by *Don Pelagius*, now called the kingdom of *Leon* and *Oviedo*, continued to increase rapidly in strength, and many advantages were gained over the Moors, who having two enemies to contend with, lost ground every day. In 921, however, they gained a great victory over the united forces of *Navarre* and *Leon*, by which the whole force of the Christians in Spain must have been entirely broken, had not the victors conducted their affairs so wretchedly, that they suffered themselves to be almost entirely cut in pieces by the remains of the Christian army. In short, the Christians became at length so terrible to the Moors, that it is probable they could not long have kept their footing in Spain, had not a great general, named *Mohammed Eln Amir Almansor*, appeared, in 979, to support their sinking cause. This man was viceroy to the king of *Cordova*, and being exceedingly provoked against the Christians on account of what his countrymen had suffered from them, made war with the most implacable fury. He took the city of *Leon*, murdered the inhabitants, and reduced the *Castles* to ashes. *Barcelona* shared the same fate; *Castile* was reduced to a district; *Gallicia* and *Portugal* ravaged; and he is said to have overcome the Christians in six different engagements. At last, having taken

59 History of the Kingdom of Aragon. An. 979. This man was viceroy to the king of *Cordova*, and being exceedingly provoked against the Christians on account of what his countrymen had suffered from them, made war with the most implacable fury. He took the city of *Leon*, murdered the inhabitants, and reduced the *Castles* to ashes. *Barcelona* shared the same fate; *Castile* was reduced to a district; *Gallicia* and *Portugal* ravaged; and he is said to have overcome the Christians in six different engagements. At last, having taken

Spain. and demolished the city of *Compostella*, and carried off in triumph the gates of the church of *St James*, a flux happened to break out among his troops, which the superstitious Christians supposed to be a divine judgement on account of his sacrilege. Taking it for granted, therefore, that the Moors were now entirely destitute of all heavenly aid, they fell upon them with such fury in the next engagement, that all the valour and conduct of *Almanzor* could not prevent a defeat. He overcame with shame and despair at this misfortune, and he desired his followers to flit for themselves, while he felt to himself retired to *Medina Cœli*, and put an end to his death. An. 998. He is defeated, and starves himself.

60 Rise of the Kingdom of Castile. An. 1037. During this period a new Christian principality appeared in Spain, namely that of *Castile*, which is now divided into the *Old* and *New Castile*. The *Old Castile* was recovered long before that called the *New*. It was separated from the kingdom of *Leon* on one side by some little rivers; on the other, it was bounded by the *Asturias*, *Biscay*, and the province of *Rioja*. On the south it had the mountains of *Segovia* and *Avila*; thus lying in the middle between the Christian kingdom of *Leon* and *Oviedo*, and the Moorish kingdom of *Cordova*. Hence this district soon became an object of contention between the kings of *Leon* and those of *Cordova*; and as the former were generally victorious, some of the principal Castilian nobility retained their independence under the protection of the Christian kings, even when the power of the Moors was at its greatest height.

In 884 we first hear of *Don Rodriguez* assuming the title of *count of Castile*, though it does not appear that either his territory or title were given him by the king of *Leon*. Nevertheless, this monarch having taken upon him to punish some of the Castilian lords as rebels, the inhabitants made a formal renunciation of their allegiance, and set up a new kind of government. The supreme power was now vested in two persons of quality styled *judges*; however, this method did not long continue to give satisfaction, and the sovereignty was once more vested in a single person. By degrees *Castile* fell entirely under the power of the kings of *Leon* and *Oviedo*; and, in 1037, *Don Sancho* bestowed it on his eldest son *Don Ferdinand*, with the title of *king*; and thus the territories of *Castile* were first firmly united to those of *Leon* and *Oviedo*, and the sovereigns were thenceforth styled *kings of Leon and Castile*.

61 Rise of Aragon. An. 1035. Besides all these, another Christian kingdom was set up in Spain about the beginning of the 11th century. This was the kingdom of *Aragon*. The inhabitants were very brave, and lovers of liberty, so that it is probable they had in some degree maintained their independence, even when the power of the Moors was greatest. The history of *Aragon*, however, during its infancy, is much less known than that of any of the others hitherto mentioned. We are only assured, that about the year 1035, *Don Sancho*, furnished the *Great*, king of *Navarre*, erected *Aragon* into a kingdom in favour of his son *Don Ramon*, and afterwards it became very powerful. At this time, then, we may imagine the continent of Spain divided into two unequal parts by a straight line drawn from east to west, from the coasts of *Valencia* to a little below the mouth of the *Douro*. The country north of this belonged to the Christians, who, as yet, had the finest and best val-

Spain able there, and all the rest to the Moors. In point of wealth and real power, both by land and sea, the Moors were much superior; but their continual dissensions greatly weakened them, and every day facilitated the progress of the Christians. Indeed, had either of the parties been united, the other must soon have yielded; for though the Christians did not make war upon each other constantly as the Moors did, their mutual feuds were yet sufficient to have ruined them, had their adversaries made the proper use of the advantages thus afforded them. But among the Moors almost every city was a kingdom; and as these petty sovereignties supported one another very indifferently, they fell a prey one after another to their enemies. In 1085, the king of Toledo was engaged in a war with the king of Seville, another Moorish potentate; which being observed by Alphonso king of Castile, he also invaded his territories; and in four years made himself master of the city of Toledo, with all the places of importance in its neighbourhood; from thenceforth making Toledo the capital of his dominions. In a short time the whole province of New Castile submitted; and Madrid, the present capital of Spain, fell into the hands of the Christians, being at that time but a small place.

64
Toledo and Madrid taken by the Christians. An. 1085.

The Moors were so much alarmed at these conquests, that they not only entered into a general confederacy against the Christians, but invited to their assistance Mahomet Ben Joseph the sovereign of Barbary. He accordingly came, attended by an incredible multitude; but was utterly defeated by the Christians in the detiles of the Black Mountain, or Sierra Morena, on the borders of Andalusia. This victory happened on the 16th of July 1212, and the anniversary is still celebrated at Toledo. This victory was not improved; the Christian army immediately dispersed themselves, while the Moors of Andalusia were strengthened by the remains of the African army; yet, instead of being taught, by their past misfortunes, to unite among themselves, their dissensions became worse than ever, and the conquests of the Christians became daily more rapid.

65
A signal victory gained over the Moors. An. 1212.

In 1236, Don Ferdinand of Castile and Leon took the celebrated city of Cordova, the residence of the first Moorish kings; at the same time that James I. of Aragon dispossessed them of the island of Majorca, and drove them out of Valencia. Two years after, Ferdinand made himself master of Murcia, and took the city of Seville; and in 1253 Ferdinand IV. reduced Gibraltar.

An. 1236.

66
England interposes in the Spanish affairs. In the time of Edward III. we find England, for the first time, interfering in the affairs of Spain, on the following occasion. In the year 1284, the kingdom of Navarre had been united to that of France by the marriage of Donna Joanna queen of Navarre with Philip the Fair of France. In 1328, however, the kingdoms were again separated, though the sovereigns of Navarre were still related to those of France. In 1332, Charles, surnamed the *Black*, ascended the throne of Navarre, and married the daughter of John king of France. Notwithstanding this alliance, and that he himself was related to the royal family of France, he secretly entered into a negotiation with Edward, and all the French march, and even drew into his toils the dauphin Charles, afterwards surnamed the *Wife*. The young prince, however, was soon afterwards fully sensible of the danger and folly of the connections into which he had entered; and, by way of atonement, procured to

Spain sacrifice his associates. Accordingly he invited the king of Navarre, and some of the principal nobility of the same party, to a feast at Rouen, where he betrayed them to his father. The most obnoxious were executed, and the king of Navarre was thrown into prison. In this extremity, the party of the king of Navarre had recourse to England. The prince of Wales, surnamed the *Black Prince*, invaded France, defeated King John at Poitiers, and took him prisoner; which unfortunate event produced the most violent disturbances in that kingdom. The dauphin, now about 19 years of age, naturally assumed the royal power during his father's captivity; but possessed neither experience nor authority sufficient to remedy the prevailing evils. In order to obtain supplies, he assembled the states of the kingdom; but that assembly, instead of supporting his administration, laid hold of the present opportunity to demand limitations of the prince's power, the punishment of past malversations, and the liberty of the king of Navarre. Marcel, provost of the merchants of Paris, and first magistrate of that city, put himself at the head of the unruly populace, and pushed them to commit the most criminal outrages against the royal authority. They detained the dauphin in a kind of captivity, murdered in his presence Robert de Clermont and John de Conflans, marshals of France; threatened all the other ministers with the like fate; and when Charles, who had been obliged to temporize and dissemble, made his escape from their hands, they levied war against him, and openly rebelled. The other cities of the kingdom, in imitation of the capital, shook off the dauphin's authority, took the government into their own hands, and spread the contagion into every province.

63
Escape of Charles V. and the French malcontents. Amidst these disorders, the king of Navarre made his escape from prison, and presented a dangerous leader to the furious malcontents. He revived his pretensions to the crown of France; but in all his operations he acted more like a leader of banditti than one who aspired to be the head of a regular government, and who was engaged by his station to endeavour the re-establishment of order in the community. All the French, therefore, who wished to restore peace to their country, turned their eyes towards the dauphin; who, though not remarkable for his military talents, daily gained by his prudence and vigilance the ascendancy over his enemies. Marcel, the seditious provost of Paris, was slain in attempting to deliver that city to the king of Navarre. The capital immediately returned to its duty; the most considerable bodies of the mutinous partisans were dispersed or put to the sword; some bands of military robbers underwent the same fate; and France began once more to assume the appearance of civil government.

John was succeeded in the throne of France by his son Charles V. a prince educated in the school of adversity, and well qualified, by his prudence and experience, to repair the losses which the kingdom had sustained from the errors of his predecessors. Contrary to the practice of all the great princes of those times, who held nothing in estimation but military courage, he seems to have laid it down as a maxim, never to be out of the head of his affairs; and he was the first European monarch that showed the advantage of policy and prudence over a blind and precipitate valour.

Before Charles could think of counterbalancing the

Spain. The king of Navarre imprisoned by John king of France. See France. No. 44.

Spain
 69
 Is deposed
 and the d
 to be abate
 the terms
 proposed
 by Charles
 V. of
 France.

great a power as England, it was necessary for him to remedy the many disorders to which his own kingdom was exposed. He accordingly turned his arms against the king of Navarre, the great disturber of France during that age; and he defeated that prince, and reduced him to terms, by the valour and conduct of Bertrand du Guesclin, one of the most accomplished captains of those times, whom Charles had the discernment to choose as the instrument of his victories. He also settled the affairs of Brittany, by acknowledging the title of Mountfort, and receiving homage for his dominions. But much was yet to be done. On the conclusion of the peace of Breigni, the many military adventurers who had followed the fortunes of Edward, being dispersed into the several provinces, and possessed of strong holds, refused to lay down their arms, or relinquish a course of life to which they were now accustomed, and by which alone they could earn a subsistence.

75
 Account of
 the banditti
 raised com
 panies of
 some ad
 vantage

They associated themselves with the banditti, who were already inured to the habits of rapine and violence; and, under the name of *companies* and *companions*, became a terror to all the peaceable inhabitants. Some English and Gascon gentlemen of character were not alarmed to take the command of these ruffians, whose number amounted to near 40,000, and who bore the appearance of regular armies rather than bands of robbers. As Charles was not able by power to redress so enormous a grievance, he was led by necessity, as well as by the turn of his character, to correct it by policy; to discover some method of discharging into foreign countries this dangerous and intestine evil; and an occasion now offered.

71
 Reign of
 Pedro the
 Cruel, King
 of Castile.

Alphonso XI. king of Castile, who took the city of Algiers from the Moors, after a tedious siege of two years, during which artillery was said first to have been used by the besieged, had been succeeded by his son Pedro I. summoned *the Cruel*; a prince equally perfidious, debauched, and bloody. He began his reign with the murder of his father's mistress, Leonora de Guzman: his nobles fell every day the victims of his severity; he put to death his cousin and one of his natural brothers, from groundless jealousy; and he caused his queen Blanche de Bourbon, of the blood of France, to be thrown into prison, and afterwards poisoned, that he might enjoy in quiet the embraces of May de Padella, with whom he was violently enamoured.

72
 The Com
 14 was em
 ployed a
 gainst him.

Henry count of Trastamara, the king's natural brother, alarmed at the fate of his family, and desiring his own, took arms against the tyrant; but having failed in the attempt, he fled to France, where he found the minds of men much inflamed against Pedro, on account of the murder of the French prince. He asked permission of Charles to enlist the *companies* in his service, and to lead them into Castile against his brother. The French king, charmed with the project, employed du Guesclin in negotiating with the leaders of these banditti. The treaty was soon concluded; and du Guesclin having completed his levies, led the army first to Avignon, where the pope then resided, and demanded, sword in hand, abolition for his ruffian soldiers, who had been excommunicated, and the sum of 200,000 livres for their subsistence. The first was readily promised him, but some difficulty being made with regard to the second, du Guesclin replied, "My fellows, I be-

lieve, may make a shift to do without your abolition, but the money is absolutely necessary." His holiness then extorted from the inhabitants of the city and its neighbourhood the sum of 100,000 livres, and offered it to du Guesclin. "It is not my purpose (cried that generous warrior) to oppress the innocent people. The pope and his cardinals can spare me double the sum from their own pockets. I therefore insist, that this money be restored to the owners; and if I hear they are defrauded of it, I will myself return from the other side of the Pyrenees, and oblige you to make them restitution." The pope found the necessity of submitting, and paid from his own treasury the sum demanded.

A body of experienced and hardy soldiers, conducted by so able a general, easily prevailed over the king of Castile, whose subjects were ready to join the enemy against their oppressor. Pedro fled from his dominions, took shelter in Guienne, and craved the protection of the prince of Wales, whom his father had invested with the sovereignty of the ceded provinces, under the title of the *principality of Aquitaine*. The prince promised his assistance to the deposed monarch; and having obtained his father's consent, he levied an army, and set out on his enterprises.

The first loss which Henry of Trastamara suffered from the interposition of the prince of Wales, was the recalling of the companies from his service; and so much reverence did they pay to the name of Edward, that great numbers of them immediately withdrew from Spain, and enlisted under his standard. Henry, however, beloved by his new subjects, and supported by the king of Arragon, was able to meet the enemy with an army of 100,000 men, three times the number of those commanded by the Black Prince; yet du Guesclin, and all his experienced officers, advised him to delay a decisive action; so high was their opinion of the valour and conduct of the English hero! But Henry, trusting to his numbers, ventured to give Edward battle on the banks of the Ebro, between Najara and Navarrete; where the French and Spaniards were defeated, with the loss of above 20,000 men, and du Guesclin and other officers of distinction taken prisoners. All Castile submitted to the victor; Pedro was restored to the throne, and Edward returned to Guienne with his usual glory; having not only overcome the great strength of his age, but restrained the most blood-thirsty tyrant from executing vengeance on his prisoners.

This gallant warrior had soon reason to repent of his connection with a man like Pedro, lost to all sense of virtue and honour. The ungrateful monster refused the stipulated pay to the English forces. Edward abandoned him; he treated his subjects with the utmost barbarity; their animosity was roused against him; and du Guesclin having obtained his ransom, returned to Castile with the count of Trastamara, and some forces levied anew in France. They were joined by the Spanish malecontents; and having no longer the Black Prince to encounter, they gained a complete victory over Pedro in the neighbourhood of Toledo. The tyrant now took refuge in a castle, where he was soon after besieged by the victors, and taken prisoner in endeavouring to make his escape. He was conducted to his brother Henry; against whom he is said to have rushed in a transport of rage, disarmed as he was. Henry slew him with his

Spain
 73
 He is driven
 out, but ac
 cused by
 the Black
 Prince.

74
 The Span
 iards sieg
 ed, and
 Peter restor
 ed.

75
 He again
 drove out
 deposed,
 and put to
 death.

Spain. own hand, in resentment of his cruelties; and, though a ballad, was placed on the throne of Castile, which he transmitted to his posterity.

There is little doubt that the character of Pedro has been greatly misrepresented, and that what is considered by most historians as tyranny and wanton cruelty, was only an inflexible regard to justice, necessary perhaps, in those days of anarchy and rebellion. Perhaps that unfortunate monarch owes to the hatred of those he meant to reduce to order, much of the obloquy which has been so plentifully bestowed upon him by historians, who have painted him to us as a tyrant to bloody, so wicked, as almost to exceed the bounds of probability. In Andalusia, where he fixed his residence and seemed most to delight, his memory is not held in the same odious esteem. The Sevillian writers speak of him very differently; and instead of his usual appellation of *Pedro el cruel*, distinguish him by that of *el justiciero*. It is certain that his bastard-brother and murderer, Henry of Trastámara, was guilty of crimes fully as atrocious as any of those imputed to Don Pedro; but as he destroy'd him, his family, and adherents, the friends of the new ignominious race of monarchs were left at full liberty to blacken the characters of the adverse party, without the least being called to an account for calumny, or even contradicted. Truth is not out of our reach; and for want of proper proofs to the contrary, we must sit down contented with what history has left us; and allow Don Pedro to have been one of the most inhuman butchers that ever disgraced a throne.

After the death of Pedro the Cruel, nothing remarkable happened in Spain for almost a whole century; it is the detachments of Henry IV. of Castile round the resentment of his nobles, as I produced a most singular infurrection, which led to the aggrandizement of the Spanish monarchy.

This prince, surrounded the *Isabellas*, though continually surrounded with women, began his unhappy reign in 1455. He was totally enervated by his pleasures; and every thing in his court conspired to fet the Castilians an example of the most abject idleness and most abandoned dissoluteness. The queen, a daughter of Portugal, lived as openly with her parasites and her gallants as the king did with his minions and his mistress. Pleasure was the only object, and it finally by the only recommendation to favour: the affairs of the state went every day into disorder; till the nobility, with the archbishop of Toledo at their head, combining against the weak and dissolute administration of Henry, argued to themselves, as one of the privileges of their order, the right of trying and passing sentence on their sovereign; which they executed in a manner unprecedented in history.

All the malecontent nobility were summoned to meet at Avila: a spacious theatre was erected in a plain without the walls of the town; an image, representing the king, was seated on a throne, clad in royal robes, with a crown on his head, a sceptre in his hand, and the sword of justice by his side. The accusation against Henry was read, and the sentence of deposition pronounced, in presence of a numerous assembly. At the close of the first article of the charge, the archbishop of Toledo advanced, and tore the crown from the head of the image; at the close of the second, the Conde de Plasencia snatched the sword of justice from its side; at

the close of the third, the Conde de Benavente wrested the sceptre from his hand; and at the close of the last, Don Diego Lopez de Sarmiento tumbled it headlong from the throne. At the same instant, Don Alphonso, Henry's brother, a boy of about twelve years of age, was proclaimed king of Castile and Leon in his stead.

This extraordinary proceeding was followed by a civil war, which did not cease till some time after the death of the young prince, on whom the nobles had bestowed the kingdom. The archbishop and his party then continued to carry on war in the name of Isabella the king's sister, to whom they gave the title of *Infanta*; and Henry could not extricate himself out of these troubles, nor remain quiet upon his throne till he had signed one of the most humiliating treaties ever extorted from a sovereign; he acknowledged his sister Isabella the only lawful heiress of his kingdom, in prejudice to the rights of his reputed daughter Joan, whom the malecontents assumed to be the offspring of an adulterous commerce between the queen and Don La Cueva. The grand object of the malecontent party now was the marriage of the prince's Isabella, upon which, it was evident, the security of the crown and the happiness of the people must in a great measure depend. The alliance was sought by several princes; the king of Portugal offered her his hand; the king of France demanded her for his brother, and the king of Aragon for his son Ferdinand. The malecontents very wisely preferred the Aragonian prince, and Isabella prudently made the same choice; articles were drawn up; and vigils were privately manifested by the archbishop of Toledo.

Henry was enraged at this alliance, which he foresaw would utterly ruin his authority, by furnishing his rebellious subjects with the support of a powerful neighbouring prince. He disinherited his sister, and established the rights of his daughter. A furious civil war desolated the kingdom. The names of Joan and Isabella resounded from every quarter, and were everywhere the mottoes to arms. But peace was at length brought about. Henry was reconciled to his sister and Ferdinand; though it does not appear that he ever renounced Isabella's right to the succession: for he affirmed in his last moments, that he bequeathed Joan to be his own daughter. The queen twice to the same effect; and Henry left a written story deed, transmitting the crown to his princess, who was proclaimed queen of Castile at Plasencia. But the superior ambition and inferior animosity of Ferdinand and Isabella prevailed; the king of Portugal was obliged to abandon his niece and intended bride; by a cruel and unprovoked struggle, and several years of war, Joan retired into a convent; and the death of Ferdinand's father, which happened about this time, transferred the kingdoms of Aragon and Sicily to those of Leon and Castile.

Ferdinand and Isabella were persons of great prudence, and as sovereigns, highly worthy of imitation. But they do not seem to have merited all the praise bestowed upon them by the Spanish historians. They did not live like men of war, having all their command under the direction of the Infanta; but like two princes in close alliance, they neither loved nor hated each other; were seldom in company together; had each a separate council; and were frequently partial as to one another in the administration. But they

75
Reign of
Henry the
Fourth.
An. 1456.

77
Reign of
Isabella
and
Ferdinand.

Spain.

79
Isabella
to be
the
heir
to the
king-
dom.

77
She is mar-
ried to Fer-
dinand.

79
Joan
retires
into a
convent.

81
Ferdinand
and
Isabella
are
prudent
and
worthy
of
imitation.

were inseparably united by their common interests; always acting upon the same principles, and forwarding the same ends. The first object was the regulation of their government, which the civil wars had thrown into the greatest disorder. Rapine, outrage, and murder, were become so common, as not only to interrupt commerce, but in every measure to suspend all intercourse between one place and another. These evils the joint sovereigns repaired by their wise policy, at the same time that they extended the royal prerogative.

About the middle of the 13th century, the cities in the kingdom of Aragon, and after their example those in Castile, had formed themselves into an association, distinguished by the name of the *Holy Brotherhood*. They exacted a certain contribution from each of the affiliated towns; they levied a considerable body of troops, in order to protect travellers and pursue criminals; and they appointed judges, who opened courts in various parts of the kingdom. Whoever was guilty of murder, robbery, or any act that violated the public peace, and was seized by the troops of the Brotherhood, was carried before their judges; who, without paying any regard to the exclusive jurisdiction which the lord of the place might claim, who was generally the author or abettor of the injustice, tried, and condemned the criminals. The nobles often murmured against this salutary institution; they complained of it as an encroachment on one of their most valuable privileges, and endeavoured to get it abolished. But Ferdinand and Isabella, sensible of the beneficial effects of the Brotherhood, not only in regard to the police of their kingdom, but in its tendency to abridge, and by degrees annihilate, the territorial jurisdiction of the nobility, countenanced the institution upon every occasion, and supported it with the whole force of royal authority; by which means the prompt and impartial administration of justice was restored, and with it tranquillity and order returned.

But at the same time that their Catholic majesties (for such was the title they now bore) were giving vigour to their civil government, and securing their subjects from violence and oppression, an intemperate zeal led them to establish an ecclesiastical tribunal, equally contrary to the natural rights of humanity and the mild spirit of the gospel. This was the court of inquisition; which decides upon the honour, fortune, and even the life, of the unhappy wretch who happens to fall under the suspicion of heresy, or a contempt of any thing prescribed by the church, without his knowing, being confronted with his accusers, or permitted either defence or appeal. Six thousand persons were burnt by order of this arbitrary tribunal within four years after the appointment of Torquemada, the first inquisitor-general; and upwards of 100,000 felt its fury. The same furious and blinded zeal which led to the depopulation of Spain, led also to its general impoverishment.

The Moors of Granada now alone remained of all the Mohammedan possessions in Spain. Princes equally zealous and ambitious were naturally disposed to turn

their eyes to that fertile territory, and to think of increasing their hereditary dominions, by expelling the enemies of Christianity, and extending its doctrines. Every thing conspired to favour their project: the Moorish kingdom was a prey to civil wars; when Ferdinand, having obtained the bull of Sixtus IV. authorizing a crusade, put himself at the head of his troops, and entered Granada. He continued the war with rapid success: Isabella attended him in several expeditions; and they were both in great danger at the siege of Malaga; an important city, which was defended with great courage, and taken in 1487. Baza was reduced in 1489, after the loss of 25,000 men. Gaudix and Almeria were delivered up to them by the Moorish king Alzagal, who had first dethroned his brother Alboacen, and afterwards was chased from his capital by his nephew Abdali. That prince engaged in the service of Ferdinand and Isabella; who, after reducing every other place of eminence, undertook the siege of Granada. Abdali made a gallant defence; but all communication with the country being cut off, and all hopes of relief at an end, he capitulated, after a siege of eight months, on condition that he should enjoy the revenue of certain places in the fertile mountains of Alpuxarras; that the inhabitants should retain the undisturbed possession of their houses, goods, and inheritances; the use of their laws, and the free exercise of their religion (&c.). Thus ended the empire of the Arabs in Spain, after it had continued about 800 years. They introduced the arts and sciences into Europe at a time when it was lost in darkness; they possessed many of the luxuries of life, when they were not even known among the neighbouring nations; and they seem to have given birth to that romantic gallantry which so eminently prevailed in the ages of chivalry, and which, blending itself with the veneration of the northern nations for the softer sex, still particularly distinguishes ancient from modern manners. But the Moors, notwithstanding these advantages, and the eulogies bestowed upon them by some writers, appear always to have been destitute of the essential qualities of a polished people, humanity, generosity, and mutual sympathy.

The overthrow of the last Moorish kingdom was soon followed by the expulsion of the Saracens from Spain. This expulsion did not entirely take place till the 17th century. Vast numbers of the Moors, indeed, oppressed by their conquerors, abandoned a country where they could not reside with comfort and with freedom. From the reign of Ferdinand of Castile, to that of Philip III. of Spain, more than 3,000,000 of those people quitted Spain, and carried with them, not only a great part of their acquired wealth, but that industry and love of labour which are the foundation of national prosperity.

The state of Spain has never been so flourishing at any period of its civilization, as during the period when it was chiefly possessed by the Moors. The first Saracen invaders, and the twenty successive lieutenants of the caliphs of Damascus, were attended by a numerous train of civil and military followers, who preferred a dilant

(8) The particulars of the conquest of Granada are involved in much obscurity. If we were to credit the narrative of Giles Perez, as related by Mr. Smeburne, the circumstances which led to that conquest were of a most romantic nature. See Smeburne's Travels, Letter xxi.

Spain. dilant fortune to narrow circumstances at home; the private and public interest was promoted by the establishment of faithful colonies, and the cities of Spain were proud to commemorate the tribe or the country of their eastern progenitors. Ten years after the conquest, a map of the province was presented to the caliph, shewing the seas, the rivers, and the harbours, the inhabitants and cities, the climate, the soil, and the mineral productions of the earth. In the space of two centuries, the gifts of nature were improved by agriculture, the manufactures, and the commerce of an industrious people; though the effects of their diligence have been magnified by the idleness of their fancy. The first of the Omniads who reigned in Spain solicited the support of the Christians; and in his edict of peace and protection, he contents himself with a modest imposition of 10,000 ounces of gold, 10,000 pounds of silver, 10,000 horses, as many mules, 1000 cuirasses, with an equal number of helmets and lances. The most powerful of his successors derived from the same kingdom the annual tribute of 12,015,000 dinars or pieces of gold, about 6,000,000*l.* of sterling money; a sum which, in the 10th century, most probably surpassed the united revenues of the Christian monarchs. His royal seat of Cordova contained 600 mosques, 900 baths, and 200,000 houses; he gave laws to 80 cities of the first, to 300 of the second and third order; and the fertile banks of the Guadalquivir were adorned with 12,000 villages and hamlets. The Arabs might exaggerate the truth; but they created and they describe the most prosperous era of the riches, the cultivation, and the populousness of Spain (c).

86
Jews expelled from Spain.

The conquest of Granada was followed by the expulsion, or rather the pillage and banishment, of the Jews, who had engrossed all the wealth and commerce of Spain. The inquisition exhausted its rage against these unhappy

people, many of whom pretended to embrace Christianity, in order to preserve their property. About the same time their Catholic majesties concluded an alliance with the emperor Maximilian, and a treaty of marriage for their daughter Juana with his son Philip, archduke of Austria and sovereign of the Netherlands. About this time also the contract was concluded with Christopher Columbus for the discovery of new countries; and the counties of Roussillon and Cerdagne were agreed to be restored by Charles VIII. of France, before his expedition into Italy. The discovery of America was soon followed by extensive conquests in that quarter, as is related under the articles MEXICO, PERU, CHILI, &c. which tended to raise the Spanish monarchy above any other in Europe.

On the death of Isabella, which happened in 1506, Philip archduke of Austria came to Castile in order to take possession of that kingdom as heir to his mother-in-law; but he dying in a short time after, his son Charles V. afterwards emperor of Germany, became heir to the crown of Spain. His father at his death left the king of France governor to the young prince, and Ferdinand at his death left Cardinal Ximenes sole regent of Castile, till the arrival of his grandson. This man, whose character is no less singular than illustrious, who united the abilities of a great statesman with the abject devotion of a superstitious monk, and the magnificence of a prime minister with the severity of a mendicant, maintained order and tranquillity in Spain, notwithstanding the discontents of a turbulent and high-spirited nobility. When they disputed his right to the regency, he coolly shewed them the testament of Ferdinand, and the ratification of that deed by Charles; but these not satisfying them, and argument proving ineffectual, he led them insensibly towards a balcony, whence they had a view of a large body of troops under arms, and

53
Accession of Charles V. An. 1516.

(c) Abdoulrahman III. monarch of Cordova, surpassed all his predecessors in splendour, riches, and expence; and his subjects vied with each other in profusion and magnificence. Some idea may be entertained of the opulence and grandeur of the Moors of Cordova in the 10th century, by perusing the following enumeration of the presents made to Abdoulrahman by Abumelik his grand vizir, on his appointment to that office. We are told that the minister caused to be brought before the throne, and laid at the feet of his master,

400 lbs. of virgin gold.

Ingots of silver to the value of 420,000 sequins.

400 lbs. of lignum aloes, one piece weighing 14*l.* lb.

500 oz. of ambergris.

300 oz. of camphor.

30 pieces of gold tissue, so rich that none but the caliph could wear it.

10 suits of Khorassan sables.

100 suits of fur of a less valuable sort.

48 sets of gold and silk long trappings for horses.

4000 lbs. of silk.

30 Persian carpets.

800 iron coats-of-mail for war horses.

1000 shields.

100,000 arrows.

15 led horses of Arabia, as richly caparisoned as those on which the caliph was wont to ride.

100 horses of an inferior price.

20 mules with all their accoutrements.

40 young men, and 20 girls of exquisite beauty, and most sumptuously appared. This display of riches was accompanied with a most flattering poem, composed by the minister in praise of his sovereign, who in return for his homage, assigned him a pension of 100,000 pieces of gold, about 50,000*l.* sterling.

Spain and a formidable train of artillery. "Behold (said the cardinal) the powers which I have received from his Catholic majesty: by these I govern Castile; and will govern it, till the king, your master and mine, shall come to take possession of his kingdom." A declaration so bold and determined silenced all opposition; and Ximenes maintained his authority till the arrival of Charles in 1517.

90
Difference
and death
of Cardinal
Ximenes.

The young king was received with universal acclamations of joy; but Ximenes found little cause to rejoice. He was seized with a violent disorder, supposed to be the effect of poison; and when he recovered, Charles, prejudiced against him by the Spanish grandes and his Flemish courtiers, slighted his advice, and allowed him every day to sink into neglect. The cardinal did not bear this treatment with his usual fortitude of spirit. He expected a more grateful return from a prince to whom he delivered a kingdom more flourishing than it had been in any former age, and authority more extensive and better established than the most illustrious of his ancestors had ever possessed. Conscious of his own integrity and merit, he could not therefore refrain from giving vent, at times, to indignation and complaint. He lamented the fate of his country, and foretold the calamities to which it would be exposed from the insolence, the rapaciousness, and the ignorance of strangers. But in the mean time he received a letter from the king, dismissing him from his councils, under pretence of casting his age of that burden which he had so long and so ably sustained. This letter proved fatal to the minister; for he expired in a few hours after reading it.

91
Maximilian
attempts to
get Charles
elected em-
peror.

While Charles was taking possession of the throne of Spain, in consequence of the death of one grandfather, another was endeavouring to obtain for him the imperial crown. With this view Maximilian assembled a diet at Augsbourg, where he cultivated the favour of the electors by many acts of beneficence, in order to engage them to choose that young prince as his successor. But Maximilian himself never having been crowned by the pope, a ceremony deemed essential in that age, as well as in the preceding, he was considered only as king of the Romans, or emperor elect; and no example occurring in history of any person being chosen successor to a king of the Romans, the Germans, always tenacious of their forms, oblatinately refused to confer upon Charles a dignity for which their constitution knew no name.

But though Maximilian could not prevail upon the German electors to choose his grandson of Spain king of the Romans, he had disposed their minds in favour of that prince; and other circumstances, on the death of the emperor, conspired to the exaltation of Charles. The imperial crown had so long continued in the Austrian line, that it began to be considered as hereditary in that family; and Germany, torn by religious disputes, stood in need of a powerful emperor, not only to preserve its own internal tranquillity, but also to protect it against the victorious arms of the Turks, who under Selim I. threatened the liberties of Europe. This fierce and rapid conqueror had already subdued the Mamelukes, and made himself master of Egypt and Syria. The power of Charles appeared necessary to oppose that of Selim. The extensive dominions of the house of Austria, which gave him an interest in the preservation of Germany; the rich sovereignty of the Netherlands and Franche Comté; the entire possession of the

Spain great and warlike kingdom of Spain, together with that of Naples and Sicily, all united to hold him up to the first dignity among Christian princes; and the new world seemed only to be called into existence that its treasures might enable him to defend Christendom against the infidels. Such was the language of his partisans.

Francis I. however, no sooner received intelligence of the death of Maximilian, than he declared himself a candidate for the empire; and with no less confidence of success than Charles. He trusted to his superior years and experience; his great reputation in arms; and it was further urged in his favour, that the impetuosity of the French cavalry, added to the firmness of the German infantry, would prove irresistible, and not only be sufficient, under a warlike emperor, to set limits to the ambition of Selim, but to break entirely the Ottoman power, and prevent it from ever becoming dangerous again to Germany.

Both claims were plausible. The dominions of Francis were less extensive, but more united than those of Charles. His subjects were numerous, active, brave, lovers of glory, and lovers of their king. There were strong arguments in favour of his power, so necessary at this juncture: but he had no natural interest in the Germanic body; and the electors, hearing so much of military force on each side, became more alarmed for their own privileges than the common safety. They determined to reject both candidates, and offered the imperial crown to Frederic, surnamed the *Wise*, duke of Saxony. But he, undazzled by the splendour of an object courted with so much eagerness, by two mighty monarchs, rejected it with a magnanimity no less singular than great.

"In times of tranquillity (said Frederic), we with for an emperor who has no power to invade our liberties; times of danger demand one who is able to secure our safety. The Turkish armies, led by a warlike and victorious monarch, are now assembling: they are ready to pour in upon Germany with a violence unknown in former ages. New conjunctures call for new expedients. The imperial sceptre must be committed to some hand more powerful than mine or that of any other German prince. We possess neither dominions, nor revenues, nor authority, which enable us to encounter such a formidable enemy. Recourse must be had, in this exigency, to one of the rival monarchs. Each of them can bring into the field forces sufficient for our defence. But as the king of Spain is of German extraction, as he is a member and prince of the empire by the territories which descend to him from his grandfather, and as his dominions stretch along that frontier which lies most exposed to the enemy, his claim, in my opinion, is preferable to that of a stranger to our language, to our blood, and to our country." Charles was elected in consequence of this speech in the year 1520.

The two candidates had hitherto conducted their rivalry with emulation, but without enmity. They had even mingled in their competition many expressions of friendship and regard. Francis in particular declared with his usual vivacity, that his brother Charles and he were fairly and openly suitors to the same mistress: "The most assiduous and fortunate (added he) will win her; and the other must rest contented." But the preference was no sooner given to his rival, than Francis discovered

Spain

92
Francis I.
aspires to
the same
dignity.

93
Speech of
Frederic
duke of
Saxony in
favour of
Charles.

94
He is elect-
ed in conse-
quence of
this speech.
An. 1520.

94
A mutual
hate takes
place be-
tween
Charles and
Francis.

Spain

discovered all the passions natural to disappointed ambition. He could not suppress his chagrin and indignation at being balked in his favourite pursuit, and rejected, in the face of all Europe, for a youth yet unknown to fame. The spirit of Charles relented such contempt; and from this jealousy, as much as from opposition of interests, arose that emulation between those two great monarchs which involved them in almost perpetual hostilities, and kept their whole age in constant agitation.

95
Both court
the friend-
ship of Hen-
ry VIII. of
England.

Charles and Francis had many interfering claims in Italy; and the latter thought himself bound in honour to restore the king of Navarre to his dominions, unjustly seized by the crown of Spain. They immediately began to negotiate; and as Henry VIII. of England was the third prince of the age in power and in dignity, his friendship was eagerly courted by each of the rivals. He was the natural guardian of the liberties of Europe. Sensible of the consequence which his situation gave him, and proud of his pre-eminence, Henry knew it to be his interest to keep the balance even between the contending powers, and to restrain both, by not joining entirely with either; but he was seldom able to reduce his ideas to practice. Vanity and resentment were the great springs of all his undertakings; and his neighbours, by touching these, found an easy way to draw him into their measures, and force him upon many rash and inconsiderate enterprises.

96
An inter-
view pro-
jected be-
tween
Francis and
Henry.

All the impolitic steps in Henry's government must not, however, be imputed to himself; many of them were occasioned by the ambition and avarice of his prime minister and favourite Cardinal Wolsey. This man, who, by his talents and accomplishments, had risen from one of the lowest conditions in life to the highest employments both in church and state, enjoyed a greater degree of power and dignity than any English subject ever possessed, and governed the haughty, presumptuous, and untractable spirit of Henry, with absolute authority. Francis was equally well acquainted with the character of Henry and of his minister. He had successfully flattered Wolsey's pride, by honouring him with particular marks of his confidence, and bestowing upon him the appellations of *Father, Tutor, and Governor*; and he had obtained the restitution of Tournay, by adding a pension to those respectful titles. He now solicited an interview with the king of England near Calais; in hopes of being able, by familiar conversation, to attach him to his friendship and interest, while he gratified the cardinal's vanity, by affording him an opportunity of displaying his magnificence in the presence of two courts, and of discovering to the two nations his influence over their monarchs. Charles dreaded the effects of this projected interview between two gallant princes, whose hearts were no less susceptible of friendship than their manners were of inspiring it. Finding it impossible, however, to prevent a visit, in which the vanity of all parties was so much concerned, he endeavoured to defeat its purpose, and to pre-occupy the favour of the English monarch, and of his minister, by an act of compliance still more flattering and more uncommon. Relying wholly upon Henry's generosity for his safety, he landed at Dover, in his way from Spain to the Low Countries. The king of England, who was on his way to France, charmed with such an instance of confidence, hastened to receive his royal guest;

97
Charles vi-
sits Henry
in England.

and Charles, during his short stay, had the address not only to give Henry favourable impressions of his character and intentions, but to detach Wolsey entirely from the interdict of Francis. The tiara had attracted the eye of that ambitious prelate; and as the emperor knew that the papacy was the sole point of elevation beyond his present greatness, at which he could aspire, he made him an offer of his interest on the first vacancy.

98
Henry visits
Francis in
France.

The day of Charles's departure, Henry went over to Calais with his whole court, in order to meet Francis. Their interview was in an open plain between Guines and Ardres; where the two kings and their attendants displayed their magnificence with such emulation and profuse expence, as procured it the name of the *Field of the Cloth of Gold*. Here Henry erected a spacious house of wood and canvas, framed in London, on which, under the figure of an English archer, was the following motto, "He prevails whom I favour;" alluding to his own political situation, as holding in his hands the balance of power among the potentates of Europe. Feats of chivalry however, parties of gallantry, and such exercises as were in that age reckoned manly or elegant, rather than serious business, occupied the two courts during the time that they continued together, which was 18 days.

After taking leave of this scene of dissipation, the king of England paid a visit to the emperor and Margaret of Savoy at Gravelines, and engaged them to go along with him to Calais; where the artful and politic Charles completed the impression which he had begun to make on Henry and his favourite, and effected all the friendship to which the frank and generous nature of Francis had given birth. He renewed his assurances of assisting Wolsey in obtaining the papacy; and he put him in present possession of the revenues belonging to the sees of Badajoz and Palencia in Spain. He flattered Henry's pride, by convincing him of his own importance, and of the justness of the motto which he had chosen; offering to submit to his sole arbitration any difference that might arise between him and Francis.

99
Charles in-
vested with
the imperi-
al crown
at Aix-la-
Chapelle.

This important point being secured, Charles repaired to Aix-la-Chapelle, where he was solemnly invested with the crown and sceptre of Charlemagne, in presence of a more splendid and numerous assembly than had appeared at any former inauguration. About the same time Solyman the Magnificent, one of the most accomplished, enterprising, and victorious of the Turkish princes, and a constant and formidable rival to the emperor, ascended the Ottoman throne.

100
War bet-
ween
Francis and
Charles.
Ann. 1551

The first act of Charles's administration was to appoint a diet of the empire, to be held at Worms, in order to concert with the princes proper measures for checking the progress of "those new and dangerous opinions which threatened to disturb the peace of Germany, and to overturn the religion of their ancestors." The opinions propagated by Luther and his followers were here meant. But all his efforts for that purpose were insufficient, as is related under the articles LUTHER and REFORMATION.

101
War bet-
ween
Francis and
Charles.
Ann. 1551

In 1551, the Spaniards, dissatisfied with the departure of their sovereign, whose election to the empire they forelaw would interfere with the administration of his own Kingdom, and incensed at the avarice of the Flemings, to whom the direction of public affairs had

been committed since the death of Cardinal Ximenes, several grandees, in order to shake off this oppression, entered into an association, to which they gave the name of the *Sancta Junctio*; and the sword was appealed to as the means of redress. This formed to Francis a favourable juncture for reinstating the family of John d'Albert in the kingdom of Navarre. Charles was at a distance from that part of his dominions, and the troops usually stationed there had been called away to quell the commotions in Spain. A French army, under Andrew de Foix, speedily conquered Navarre; but that young and inexperienced nobleman, pushed on by military ardour, ventured to enter Castile. The Spaniards, though divided among themselves, united against a foreign enemy, routed his forces, took him prisoner, and recovered Navarre in a shorter time than he had spent in subduing it.

Hostilities thus began in one quarter, between the rival monarchs, soon spread to another. The king of France encouraged the duke of Buillon to make war against the emperor, and to invade Luxembourg. Charles, after humbling the duke, attempted to enter France; but was repelled and worsted before Mezieres by the famous Chevalier Bayard, distinguished among his contemporaries by the appellation of *The Knight without fear and without reproach*; and who united the talents of a great general to the punctilious honour and romantic gallantry of the heroes of chivalry. Francis broke into the Low Countries, where, by an excess of caution, an error not natural to him, he lost an opportunity of cutting off the whole imperial army; and, what was of still more consequence, he disgusted the constable Bourbon, by giving the command of the van to the duke of Alençon.

During these operations in the field, an unsuccessful congress was held at Calais, under the mediation of Henry VIII. It served only to exasperate the parties which it was intended to reconcile. A league was soon after concluded, by the intrigues of Wolsey, between the pope, Henry, and Charles, against France. Leo had already entered into a separate league with the emperor, and the French were fast losing ground in Italy.

The insolence and exactions of Marcell de Lautrec, governor of Milan, had totally alienated the affections of the Milanese from France. They resolved to expel the troops of that nation, and put themselves under the government of Francis Sforza, brother to Maximilian their late duke. In this resolution, they were encouraged by the pope, who excommunicated Lautrec, and took into his pay a considerable body of Swiss. The papal army, commanded by Prosper Colonna, an experienced general, was joined by supplies from Germany and Naples; while Lautrec, neglected by his court, and deserted by the Swiss in its pay, was unable to make head against the enemy. The city of Milan was betrayed by the inhabitants to the confederates; Parma and Piacenza were united to the ecclesiastical state; and of their conquests in Lombardy, only the town of Cremona, the castle of Milan, and a few inconsiderable forts, remained in the hands of the French.

Leo X. received the accounts of this rapid success with such transports of joy, as are said to have brought on a fever, which occasioned his death. The spirit of the confederacy was broken, and its operations suspended

by this accident. The Swiss were recalled; some other mercenaries disbanded for want of pay; and only the Spaniards, and a few Germans in the emperor's service, remained to defend the duchy of Milan. But Lautrec, who with the remnant of his army had taken shelter in the Venetian territories, delisted both of men and money, was unable to improve this favourable opportunity as he wished. All his efforts were rendered ineffectual by the vigilance and ability of Colonna and his associates.

Meantime much discord prevailed in the conclave. Wolsey's name, notwithstanding all the emperor's magnificent promises, was scarcely mentioned there. Julio de Medici, Leo's nephew, thought himself sure of the election; when, by an unexpected turn of fortune, Cardinal Adrian of Utrecht, Charles's preceptor, who at that time governed Spain in the emperor's name, was unanimously raised to the papacy, to the astonishment of all Europe and the great disgust of the Italians.

Francis, roused by the rising consequence of his rival, resolved to exert himself with fresh vigour, in order to wrest from him his late conquests in Lombardy. Lautrec received a supply of money, and a reinforcement of 10,000 Swiss. With this reinforcement he was enabled once more to act offensively, and even to advance within a few miles of the city of Milan; when money again failing him, and the Swiss growing mutinous, he was obliged to attack the imperialists in their camp at Bicocca, where he was repulsed with great slaughter, having lost his bravest officers and best troops. Such of the Swiss as survived fled out immediately for their own country; and Lautrec, despairing of being able to keep the field, retired into France. Genoa, which still remained subject to Francis, and made it easy to execute any scheme for the recovery of Milan, was soon after taken by Colonna: the authority of the emperor and his faction was everywhere established in Italy. The citadel of Cremona was the sole fortress which remained in the hands of the French.

The affliction of Francis for such a succession of misfortunes was augmented by the unexpected arrival of an English herald, who in the name of his sovereign declared war against France. The courage of this excellent prince, however, did not shake him; though his treasury was exhausted by expensive pleasures, no less than by hostile enterprises, he assembled a considerable army, and put his kingdom in a posture of defence for resisting this new enemy, without abandoning any of the schemes which he was forming against the emperor. He was surprised, but not alarmed, at such a denunciation.

Meanwhile Charles, willing to draw as much advantage as possible from so powerful an ally, paid a second visit to the court of England in his way to Spain, where his presence was become necessary. His success exceeded his most sanguine expectations. He not only gained the entire friendship of Henry, who publicly ratified the treaty of Bruges; but dissipated the resentment of Wolsey, by assuring him of the papacy on Adrian's death; an event seemingly not distant, by reason of his age and infirmities. In consequence of these negotiations an English army invaded France, under the command of the earl of Surrey; who, at the end of the campaign, was obliged to retire, with his forces greatly reduced,

reduced, without being able to make himself master of one place within the French frontier. Charles was more fortunate in Spain: he soon quelled the tumults which had there arisen in his absence.

While the Christian princes were thus wading each other's strength, Soliman the Magnificent entered Hungary, and made himself master of Belgrade, reckoned the chief barrier of that kingdom against the Turkish power. Encouraged by this success, he turned his victorious arms against the island of Rhodes, at that time the seat of the knights of St John of Jerusalem; and though every prince in that age acknowledged Rhodes to be the great bulwark of Christendom in the east, so violent was their animosity against each other, that they suffered Soliman without disturbance to carry on his operations against that city and island. Lile Adam, the grandmaster, made a gallant defence; but, after incredible efforts of courage, patience, and military conduct, during a siege of six months, he was obliged to surrender the place, having obtained an honourable capitulation from the sultan, who admired and respected his heroic qualities (see RHODES and MALTA). Charles and Francis were equally ashamed of having occasioned such a loss to Christendom by their contentions; and the emperor, by way of reparation, granted to the knights of St John the small island of Alia, where they fixed their residence, and continued long to retain their ancient spirit, though much diminished in power and splendour.

Adrian VI. though the creature of the emperor, and devoted to his interest, endeavoured to assume the impartiality which became the common father of Christendom, and laboured to reconcile the contending princes, that they might unite in a league against Soliman, whose conquest of Rhodes rendered him more formidable than ever to Europe. The Italian states were no less desirous of peace than the pope: and so much regard was paid by the hostile powers to the exhortations of his holiness, and to a bull which he issued, requiring all Christian princes to consent to a truce for three years, that the imperial, the French, and the English ambassadors at Rome, were empowered to treat of that matter; but while they waited their time in fruitless negotiations, their matters were continuing their preparations for war; and other negotiations soon took place. The confederacy against France became more formidable than ever.

The Venetians, who had hitherto adhered to the French interest, formed engagements with the emperor for securing Francis Sforza in the possession of the duchy of Milan; and the pope, from a persuasion that the ambition of the French monarch was the only obstacle to peace, acceded to the same alliance. The Florentines, the dukes of Ferrara and Mantua, and all the Italian powers, followed this example. Francis was left without a single ally, to resist the efforts of a multitude of enemies, whose armies every-where threatened, and whose territories encompassed his dominions. The emperor in person menaced France with an invasion on the side of Guienne; the forces of England and the Netherlands hovered over Picardy, and a numerous body of Germans was preparing to ravage Burgundy.

The dread of so many and such powerful adversaries, it was thought, would have obliged Francis to keep wholly on the defensive, or at least have prevented him

from entertaining any thoughts of marching into Italy. But before his enemies were able to strike a blow, Francis had assembled a great army, with which he hoped to disconcert all the emperor's schemes, by marching it in person into Italy; and this bold enterprise, the more formidable because unexpected, could scarcely have failed of the desired effect, had it been immediately carried into execution. But the discovery of a domestic conspiracy, which threatened the destruction of his kingdom, obliged Francis to stop short at Lyons.

Charles duke of Bourbon, lord high constable of France, was a prince of the most shining merit: his great talents equally fitted him for the council or the field, while his eminent services to the crown intitled him to its first favour. But unhappily Louisa duchess of Angoulême, the king's mother, had contracted a violent aversion against the house of Bourbon, and had taught her son, over whom she had acquired an absolute ascendancy, to view all the constable's actions with a jealous eye. After repeated affronts he retired from court, and began to listen to the advances of the emperor's ministers. Meantime the duchess of Bourbon died; and as the constable was no less amiable than accomplished, the duchess of Angoulême, still susceptible of the tender passions, formed the scheme of marrying him. But Bourbon, who might have expected every thing to which an ambitious mind can aspire, from the dutiful fondness of a woman who governed her son and the kingdom, incapable of imitating Louisa in her sudden transition from hate to love, or of meanly counterfeiting a passion for one who had so long pursued him with unprovoked malice, rejected the match with disdain, and turned the proposal into ridicule. At once despised and insulted by the man whom love only could have made her cease to persecute, Louisa was filled with all the rage of disappointed woman; she resolved to ruin, since she could not marry, Bourbon. For this purpose she commenced an iniquitous suit against him; and by the chicanery of Chancellor du Prat, the constable was stripped of his whole family-estate. Driven to despair by so many injuries, he entered into a secret correspondence with the emperor and the king of England; and he proposed, as soon as Francis should have crossed the Alps, to raise an insurrection among his numerous vassals, and introduce foreign enemies into the heart of France.

Happily Francis got intimation of this conspiracy before he left the kingdom; but not being sufficiently convinced of the constable's guilt, he suffered to dangerous a foe to escape; and Bourbon entering into the emperor's service, employed all the force of his enterprising genius, and his great talents for war, to the prejudice of his prince and his native country.

In consequence of the discovery of this plot, and the escape of the powerful conspirator, Francis relinquished his intention of leading his army in person into Italy. He was ignorant how far the infection had spread among his subjects, and afraid that his absence might encourage them to make some desperate attempt in favour of a man so much beloved. He did not, however, abandon his design on the Milanese, but sent forward an army of 30,000 men, under the command of Admiral Bonivet, Colonna, who was entrusted with the defence of that duchy, was in no condition to resist such a force; and the city of Milan, on which the whole territory depends,

Spain.
104
Rhodes taken by Soliman.

Spain.
106
Francis
107
words Italy
108
109
110
domestic
111
112

105
A powerful confederacy against Francis.

107
108
109
110
111
112

Spin.

pends, must have fallen into the hands of the French, had not Bonivert, who possessed none of the talents of a general, waited his time in frivolous enterprises, till the inhabitants recovered from their consternation. The imperial army was reinforced. Colonna died; and Lannoy, viceroy of Naples, succeeded him in the command: but the chief direction of military operations was committed to Bourbon and the marquis de Pefeara, the greatest generals of their age. Bonivert, destitute of troops to oppose this new army, and still more of the talents which could render him a match for its leaders, after various movements and encounters, was reduced to the necessity of attempting a retreat into France. He was followed by the imperial generals, and routed at Biagrasia, where the famous Chevalier Bayard was killed.

108
Defeated at
Biagrasia.

The emperor and his allies were less successful in their attempts upon France. They were baffled in every quarter: and Francis, though stripped of his Italian dominions, might still have enjoyed in safety the glory of having defended his native kingdom against one half of Europe, and have bid defiance to all his enemies; but understanding that the king of England, discouraged by his former fruitless enterprises, and disgusted with the emperor, was making no preparations for any attempt on Picardy, his ancient ardour seized him for the conquest of Milan, and he determined, notwithstanding the advanced season, to march into Italy.

109
Francis de-
termines to
enter
Italy in per-
son.

The French army no sooner appeared in Piedmont, than the whole Milanese was thrown into consternation. The capital opened its gates. The forces of the emperor and Sforza retired to Lodi: and had Francis been so fortunate as to pursue them, they must have abandoned that post, and been totally dispersed; but his evil genius led him to besiege Pavia, a town of considerable strength, well garrisoned, and defended by Antonio de Leyva, one of the bravest officers in the Spanish service; before which place he was defeated and taken prisoner on the twenty-fourth day of February 1524.

110
Is defeated
and taken
prisoner at
Pavia.
An. 1524.

The captivity of Francis filled all Europe with alarm. Almost the whole French army was cut off; Milan was immediately abandoned; and in a few weeks not a Frenchman was left in Italy. The power of the emperor, and still more his ambition, became an object of universal terror; and resolutions were everywhere taken to set bounds to it. Meanwhile Francis, deeply impressed with a sense of his misfortune, wrote to his mother Louisa, whom he had left regent of the kingdom, the following short but expressive letter: "All, Madam, is lost but honour." The same courier that carried this letter, carried also dispatches to Charles; who received the news of the signal and unexpected success which had crowned his arms with the most hypocritical moderation. He would not suffer any public rejoicings to be made on account of it; and said, he only valued it, as it would prove the occasion of restoring peace to Christendom. Louisa, however, did not trust to those appearances; if she could not perceive what was yet left, she determined at least that nothing should be lost through her negligence or weakness. Instead of giving herself up to such lamentations as were natural to a woman so remarkable for maternal tenderness, she discovered all the foresight, and exerted all the activity, of a consummate politician. She took every possible measure for

111
Hypocri-
tical conduct
of Charles.

putting the kingdom in a posture of defence, while she employed all her address to appease the resentment and to gain the friendship of England; and a ray of comfort from that quarter soon broke in upon the French affairs.

Spain.

Though Henry VIII. had not entered into the war against France from any concerted political views, he had always retained some imperfect idea of that balance of power which it was necessary to maintain between Charles and Francis; and the preservation of which he boasted to be his peculiar office. By his alliance with the emperor, he hoped to recover some part of those territories on the continent which had belonged to his ancestors; and therefore willingly contributed to give him the ascendancy above his rival; but having never dreamt of any event so decisive and fatal as the victory at Pavia, which seemed not only to have broken, but to have annihilated the power of Francis, he now became sensible of his own danger, as well as that of all Europe, from the loss of a proper counterpoise to the power of Charles. Instead of taking advantage of the distressed condition of France, Henry therefore determined to assist her in her present calamities. Some disputes also had taken place between him and Charles, and still more between Charles and Wolsey. The elevation of the cardinal of Medici to St Peter's chair, on the death of Adrian, under the name of Clement VII. had made the English minister sensible of the insincerity of the emperor's promises, while it extinguished all his hopes of the papacy; and he resolved on revenge. Charles, too, had so ill supported the appearance of moderation which he assumed, when first informed of his good fortune, that he had already changed his usual style to Henry; and instead of writing to him with his own hand, and subscribing himself "your affectionate son and cousin," he dictated his letters to a secretary, and simply subscribed himself "Charles." Influenced by all these motives, together with the glory of raising a fallen enemy, Henry listened to the flattering submissions of Louisa; entered into a defensive alliance with her as regent of France, and engaged to use his best offices in order to procure the deliverance of her son from a state of captivity.

112
Francis is
liberated by
Henry VIII.

Meanwhile Francis was rigorously confined; and severe conditions being proposed to him as the price of his liberty, he drew his dagger, and, pointing it at his breast, cried, "I were better that a king should die thus!" His hand was withheld; and flattering himself, when he grew cool, that such propositions could not come directly from Charles, he desired that he might be removed to Spain, where the emperor then resided. His request was complied with; but he languished long before he obtained a sight of his conqueror. At last he was favoured with a visit; and the emperor dreading a general combination against him, or that Francis, as he threatened, might, in the obliquity of his heart, resign his crown to the dauphin, agreed to abate somewhat of his former demands. A treaty was accordingly concluded at Madrid; in consequence of which Francis obtained his liberty. The chief article in this treaty was, that Burgundy should be restored to Charles as the rightful inheritance of his ancestors; and that Francis's two eldest sons should be immediately delivered up as hostages for the performance of the conditions stipulated. The exchange of the captive monarch

113
Francis se-
verely used
by his con-
queror.

114
Is at last
released.

narch for his children was made on the borders between France and Spain. The moment that Francis entered his own dominions, he mounted a Turkish horse, and putting it to its speed, waved his hand, and cried aloud several times, "I am yet a king! I am yet a king!"

Francis never meant to execute the treaty of Madrid: he had even left a protest in the hands of notaries before he signed it, that his consent should be considered as an involuntary deed, and be deemed null and void. Accordingly, as soon as he arrived in France, he assembled the states of Burgundy, who protested against the article relative to their province; and Francis coldly replied to the imperial ambassadors, who urged the immediate execution of the treaty, that he would religiously perform the articles relative to himself, but in those affecting the French monarchy, he must be directed by the sense of the nation. He made the highest acknowledgements to the king of England for his friendly interposition, and offered to be entirely guided by his counsels. Charles and his ministers saw that they were over-reached in those very arts of negotiation in which they so much excelled, while the Italian states observed with pleasure, that Francis was resolved not to execute a treaty which they considered as dangerous to the liberties of Europe. Clement absolved him from the oath which he had taken at Madrid; and the kings of France and England, the pope, the Switz, the Venetians, the Florentines, and the duke of Milan, entered into an alliance, to which they gave the name of the *Holy League*, because his Holiness was at the head of it, in order to oblige the emperor to deliver up Francis's two sons on the payment of a reasonable ransom, and to re-establish Sforza in the quiet possession of the Milanese.

In consequence of this league, the confederate army took the field, and Italy once more became the scene of war. But Francis, who it was thought would have infused spirit and vigour into the whole body, had gone through such a scene of distress, that he was become diffident of himself, distrustful of his fortune, and desirous of tranquillity. He flattered himself, that the dread alone of such a confederacy would induce Charles to listen to what was equitable, and therefore neglected to send due reinforcements to his allies in Italy. Meantime the duke of Bourbon, who commanded the Imperialists, had made himself master of the whole Milanese, of which the emperor had promised him the investiture; and his troops beginning to mutiny for want of pay, he led them to Rome, and promised to enrich them with the spoils of that city. He was as good as his word; for though he himself was slain in planting a scaling ladder against the walls, his soldiers, rather enraged than discouraged by his death, mounted to the assault with the utmost ardour, animated by the greatness of the prize, and, entering the city sword in hand, plundered it for several days.

Never did Rome in any age suffer so many calamities, not even from the Barbarians, by whom she was often subdued, the Huns, Vandals, or Goths, as now from the subjects of a Christian and Catholic monarch. Whatever was respectable in modesty, or sacred in religion, seemed only the more to provoke the rage of the soldiery. Virgins suffered violation in the arms of their parents, and upon those altars to which they had fled for safety. Venerable prelates, after enduring every indignity and every torture, were thrown into dungeons,

and menaced with the most cruel death, in order to make them reveal their secret treasures. Clement himself, who had neglected to make his escape in time, was taken prisoner, and found that the sacredness of his character could neither procure him liberty nor respect. He was confined till he should pay an enormous ransom the emperor all the places of strength belonging to the church.

Charles received the news of this extraordinary event with equal surprize and pleasure; but in order to conceal his joy from his Spanish subjects, who were filled with horror at the insult offered to the sovereign pontiff, and to lessen the indignation of the rest of Europe, he expressed the most profound sorrow for the success of his arms. He put himself and his court into mourning; stopped the rejoicings for the birth of his son Philip, and ordered prayers to be put up in all the churches of Spain for the recovery of the pope's liberty, which he could immediately have procured by a letter to his generals.

The concern expressed by Henry and Francis for the calamity of their ally was more sincere. Alarmed at the progress of the imperial arms, they had, even before the taking of Rome, entered into a closer alliance, and agreed to invade the Low Countries with a powerful army; but no sooner did they hear of the pope's captivity, than they changed, by a new treaty, the scene of the projected war from the Netherlands to Italy, and resolved to take the most vigorous measures for restoring him to liberty. Henry, however, contributed only money. A French army entered Italy, under the command of Marshal Lautrec; Clement obtained his freedom; and war was for a time carried on by the confederates with success; but the death of Lautrec, and the revolt of Andrew Doria, a Genoese admiral in the service of France, entirely changed the face of affairs. The French army was utterly ruined; and Francis, discouraged and almost exhausted by so many unsuccessful enterprises, began to think of peace, and of obtaining the release of his sons by concessions, not by the terror of his arms.

At the same time Charles, notwithstanding the advantages he had gained, had many reasons to wish for an accommodation. Sultan Solymán having overrun Hungary, was ready to break in upon the Austrian territories with the whole force of the East; and the progress of the Reformation in Germany threatened the tranquillity of the empire. In consequence of this situation of affairs, though pride made both parties conceal or dissemble their real sentiments, two ladies were permitted to restore peace to Europe. Margaret of Austria, Charles's aunt, and Louisa, Francis's mother, met in 1529 at Cambray, and settled the terms of accommodation between the French king and the emperor. Francis agreed to pay two millions of crowns as the ransom of his two sons, to resign the sovereignty of Flanders and Artois, and to forego all his Italian claims; and Charles ceased to demand the restitution of Burgundy.

All the steps of this negotiation had been communicated to the king of England; and Henry was, on that occasion, so generous to his friend and ally Francis, that he sent him an acquittal of near six hundred thousand crowns, in order to enable him to fulfil his agreement

Spain.
Francis never meant to execute the treaty of Madrid: he had even left a protest in the hands of notaries before he signed it, that his consent should be considered as an involuntary deed, and be deemed null and void.

115
Francis never meant to execute the treaty of Madrid: he had even left a protest in the hands of notaries before he signed it, that his consent should be considered as an involuntary deed, and be deemed null and void.

116
Francis never meant to execute the treaty of Madrid: he had even left a protest in the hands of notaries before he signed it, that his consent should be considered as an involuntary deed, and be deemed null and void.

117
Francis never meant to execute the treaty of Madrid: he had even left a protest in the hands of notaries before he signed it, that his consent should be considered as an involuntary deed, and be deemed null and void.

118
Francis never meant to execute the treaty of Madrid: he had even left a protest in the hands of notaries before he signed it, that his consent should be considered as an involuntary deed, and be deemed null and void.

119
Francis never meant to execute the treaty of Madrid: he had even left a protest in the hands of notaries before he signed it, that his consent should be considered as an involuntary deed, and be deemed null and void.

Spain.
Francis never meant to execute the treaty of Madrid: he had even left a protest in the hands of notaries before he signed it, that his consent should be considered as an involuntary deed, and be deemed null and void.

115
Francis never meant to execute the treaty of Madrid: he had even left a protest in the hands of notaries before he signed it, that his consent should be considered as an involuntary deed, and be deemed null and void.

116
Francis never meant to execute the treaty of Madrid: he had even left a protest in the hands of notaries before he signed it, that his consent should be considered as an involuntary deed, and be deemed null and void.

117
Francis never meant to execute the treaty of Madrid: he had even left a protest in the hands of notaries before he signed it, that his consent should be considered as an involuntary deed, and be deemed null and void.

118
Francis never meant to execute the treaty of Madrid: he had even left a protest in the hands of notaries before he signed it, that his consent should be considered as an involuntary deed, and be deemed null and void.

119
Francis never meant to execute the treaty of Madrid: he had even left a protest in the hands of notaries before he signed it, that his consent should be considered as an involuntary deed, and be deemed null and void.

Spain. with Charles. But Francis's Italian confederates were less satisfied with the treaty of Cambray. They were almost wilfully abandoned to the will of the emperor; and seemed to have no other means of security left but his equity and moderation. Of these, from his past conduct, they had not formed the most advantageous idea. But Charles's present circumstances, more especially in regard to the Turks, obliged him to behave with a generosity inconsistent with his character. The Florentines alone, whom he reduced under the dominion of the family of Medici, had reason to complain of his generosity. Sforza obtained the inviolability of Milan and his pardon: and every other power experienced the lenity of the conqueror.

122
Charles goes into Germany.

After having received the imperial crown from the hands of the pope at Bologna, Charles proceeded on his journey to Germany, where his presence was become highly necessary; for although the conduct and valour of his brother Ferdinand, on whom he had conferred the hereditary dominions of the house of Austria, and who had been elected king of Hungary, had obliged Solyman to retire with infamy and loss, his return was to be feared, and the disorders of religion were daily increasing; an account of which, and of the emperor's transactions with the Protestants, is given under the article REFORMATION.

123
He undertakes an expedition against the state of Barbary. An. 1541.

Charles having exerted himself as much as he could against the reformers, undertook his first expedition against the piratical states of Africa. Barbary, or that part of the African continent lying along the coast of the Mediterranean sea, was then nearly in the same condition which it is at present. Morocco, Algiers, and Tunis, were its principal states; and the two last were nests of pirates. Barbarossa, a famous corsair, had succeeded his brother in the kingdom of Algiers, which he had formerly assisted him to usurp. He regulated with much prudence the interior police of his kingdom, carried on his piracies with great vigour, and extended his conquests on the continent of Africa; but perceiving that the natives submitted to his government with impotence, and fearing that his continual depredations would one day draw upon him a general combination of the Christian powers, he put his dominions under the protection of the grand seignior. Solyman, flattered by such an act of submission, and charmed with the boldness of the man, offered him the command of the Turkish fleet. Proud of this distinction, Barbarossa repaired to Constantinople, and made use of his influence with the sultan to extend his own dominion. Partly by force, partly by treachery, he usurped the kingdom of Tunis; and being now possessed of greater power, he carried on his depredations against the Christian states with more destructive violence than ever.

Daily complaints of the piracies and ravages committed by the galleys of Barbarossa were brought to the emperor by his subjects, both in Spain and Italy; and all Christendom seemed to look up to him, as its greatest and most fortunate prince, for relief from this new and odious species of oppression. At the same time Muley-Hafsen, the exiled king of Tunis, finding none of the African princes able or willing to support him in recovering his throne, applied to Charles for assistance against the usurper. Equally desirous of delivering his dominions from the dangerous neighbourhood of Barbarossa, of appearing as the protector of an un-

fortunate prince, and of acquiring the glory annexed in that age to every expedition against the Mahometans, the emperor readily concluded a treaty with Muley Hafsen, and set sail for Tunis with a formidable armament. The Goletta, a sea-port town, fortified with 300 pieces of cannon, was taken, together with all Barbarossa's fleet: he was defeated in a pitched battle, and 10,000 Christian slaves, having knocked off their fetters, and made themselves masters of the ciadel, Tunis was prepared to surrender. But while Charles was deliberating on the conditions, his troops fearing that they would be deprived of the booty which they had expected, broke suddenly into the town, and pillaged and massacred without distinction. Thirty thousand persons perished by the sword, and 10,000 were made prisoners. The sceptre was restored to Muley Hafsen, on condition that he should acknowledge himself a vassal of the crown of Spain, put into the emperor's hands all the fortified sea-ports in the kingdom of Tunis, and pay annually 12,000 crowns for the subsistence of the Spanish garrison in the Goletta. These points being settled, and 20,000 Christian slaves freed from bondage either by arms or by treaty, Charles returned to Europe, where his presence was become necessary; while Barbarossa, who had retired to Bona, recovered new strength, and again became the tyrant of the ocean.

124
Tunis taken, and the inhabitants crucified, massacred.

The king of France took advantage of the emperor's absence to revive his pretensions in Italy. The treaty of Cambray had repressed but not extinguished the flames of discord. Francis in particular, who waited only for a favourable opportunity of recovering the territories and reputation which he had lost, continued to negotiate against his rival with different courts. But all his negotiations were disconcerted by unforeseen accidents. The death of Clement VII. (whom he had gained by marrying his son the duke of Orleans, afterwards Henry II. to Catharine of Medici, the niece of that pontiff), deprived him of all the support which he hoped to receive from the court of Rome. The king of England, occupied with domestic cares and projects, declined engaging in the affairs of the continent; and the Protestant princes, associated by the league of Smalkalde, to whom Francis had also applied, and who seemed disposed at first to listen to him, filled with indignation and resentment at the cruelty with which some of their reformed brethren had been treated in France, refused to have any connection with the enemy of their religion.

Francis was neither cruel nor bigotted: he was too indolent to concern himself about religious disputes; but his principles becoming suspected, at a time when the emperor was gaining immortal glory by his expedition against the infidels, he found it necessary to vindicate himself by some extraordinary demonstration of reverence for the established faith. The indifereet zeal of some Protestant converts furnished him with the opportunity. They had affixed to the gates of the Louvre and other public places papers containing indecent reflections on the rites of the Romish church. Six of the persons concerned in this rash action were seized; and the king, pretending to be struck with horror at their blasphemies, appointed a solemn procession, in order to avert the wrath of heaven. The holy sacrament was carried through the city of Paris in great pomp: Francis walked uncovered before it, bearing a torch in his hand;

125
Francis attempts to revive his pretensions.

126
His barbarous treatment of Protestants.

Spain. hand; the princes of the blood supported the canopy over it; the nobles walked behind. In presence of this numerous assembly, the king declared, that if one of his hands were infected with heresy, he would cut it off with the other; "and I would sacrifice (added he) even my own children, if found guilty of that crime." As an awful proof of his sincerity, the six unhappy persons who had been seized were publicly burnt, before the procession was finished, and in the most cruel manner. They were fixed upon a machine which defended into the flames, and retired alternately, until they expired.—No wonder that the Protestant princes were incensed at such barbarity!

117 Causes an army march to-wards Italy. Francis, though unsupported by any ally, commanded his army to advance towards the frontiers of Italy, under pretence of chastising the duke of Milan for a breach of the law of nations, in putting to death his ambassador. The operations of war, however, soon took a new direction. Instead of marching directly to the Milanese, Francis commenced hostilities against the duke of Savoy, with whom he had cause to be dissatisfied, and on whom he had some claims; and before the end of the campaign, this feeble prince saw himself stripped of all his dominions, except the province of Piedmont. To complete his misfortunes, the city of Geneva, the sovereignty of which he claimed, and where the reformed opinions had already got footing, threw off his yoke; and its revolt drew along with it the loss of the adjacent territory. Geneva was then an imperial city, and till lately remained entirely free.*

118 Geneva throws off the yoke of the duke of Savoy. * See Geneva.

In this extremity the duke of Savoy saw no resource but in the emperor's protection; and as his misfortunes were chiefly occasioned by his attachment to the imperial interest, he had a title to immediate assistance. But Charles, who was just returned from his African expedition, was not able to lend him the necessary support. His treasury was entirely drained, and he was obliged to disband his army till he could raise new supplies. Mean time the death of Sforza duke of Milan entirely changed the nature of the war, and afforded the emperor full leisure to prepare for action. The French monarch's pretext for taking up arms was at once cut off; but as the duke died without issue, all Francis's rights to the duchy of Milan, which he had yielded only to Sforza and his descendants, returned to him in full force. He instantly renewed his claim to it; and if he had ordered his army immediately to advance, he might have made himself master of it. But he unfortunately wasted his time in fruitless negotiations, while his more politic rival took possession of the duchy as a vacant fief of the empire; and though Charles seemed still to admit the equity of Francis's claim, he delayed granting the investiture under various pretences, and was secretly taking every possible measure to prevent him from regaining footing in Italy.

119 Weakness of Francis. During the time gained in this manner, Charles had recruited his finances, and of course his armies; and finding himself in a condition for war, he at last threw off the mask under which he had so long concealed his designs from the court of France. Entering Rome with great pomp, he pronounced before the pope and cardinals, assembled in full consistory, a violent invective against Francis, by way of reply to his propositions concerning the investiture of Milan. Yet Francis, by an unaccountable fatality, continued to negotiate, as if it

had been still possible to terminate their differences in an amicable manner; and Charles, finding him so eager to run into the snare, favoured the deception, and, by seeming to listen to his proposals, gained yet more time for the execution of his ambitious projects.

If misfortunes had rendered Francis too diffident, success had made Charles too sanguine. He presumed on nothing less than the subversion of the French monarchy; nay, he considered it as a certain event. Having chased the forces of his rival out of Piedmont and Savoy, he pushed forward at the head of 50,000 men, contrary to the advice of his most experienced ministers and generals, to invade the southern provinces of France; while two other armies were ordered to enter it, the one on the side of Picardy, the other on the side of Champagne. He thought it impossible that Francis could resist so many unexpected attacks on such different quarters; but he found himself mistaken.

The French monarch fixed on the most effectual plan for defeating the invasion of a powerful enemy; and he prudently persevered in following it, though contrary to his own natural temper and to the genius of his people. He determined to remain altogether upon the defensive, and to deprive the enemy of subsistence by laying waste the country before them. The execution of this plan was committed to the marshal Montmorency its author, a man happily fitted for such a trust by the inflexible severity of his disposition. He made choice of a strong camp, under the walls of Avignon, at the confluence of the Rhone and Durance, where he assembled a considerable army; while the king, with another body of troops, encamped at Valence, higher up the Rhone. Marseilles and Arles were the only towns he thought it necessary to defend; and each of these he furnished with a numerous garrison of his best troops. The inhabitants of the other towns were compelled to abandon their habitations: the fortifications of such places as might have afforded shelter to the enemy were thrown down; corn, forage, and provisions of every kind, were carried off or destroyed; the mills and ovens were ruined, and the wells filled up or rendered useless.

This devastation extended from the Alps to Marseilles, and from the sea to the confines of Dauphiny; so that the emperor, when he arrived with the van of his army on the confines of Provence, instead of that rich and populous country which he expected to enter, beheld nothing but one vast and desert solitude. He did not, however, despair of success, though he saw that he would have many difficulties to encounter; and as an encouragement to his officers, he made them liberal promises of lands and honours in France. But all the land which any of them obtained was a grave, and their matter lost much honour by his rash and presumptuous enterprise. After unsuccessfully investing Marseilles and Arles, after attempting in vain to draw Montmorency from his camp at Avignon, and not daring to attack it, Charles having spent two inglorious months in Provence, and lost one half of his troops by disease or by famine, was under the necessity of ordering a retreat; and though he was some time in motion before the enemy suspected his intention, it was conducted with so much precipitation and disorder, as to deserve the name of a flight, since the light troops of France turned it into a perfect rout. The invasion of

^{Spain.} Picaardy was not more successful: the imperial forces were obliged to retire without effecting any conquest of importance.

Charles had no sooner conducted the shattered remains of his army to the frontiers of Milan, than he set out for Genoa; and unwilling to expose himself to the scorn of the Italians after such a reverse of fortune, he embarked directly for Spain.

¹³⁴
Violent animosity between him and Francis.

Meanwhile Francis gave himself up to that vain resentment which had formerly disgraced the prosperity of his rival. They had frequently, in the course of their quarrels, given each other the lie, and mutual challenges had been sent; which, though productive of no serious consequences between the parties, had a powerful tendency to encourage the pernicious practice of duelling. Charles, in his invective pronounced at Rome, had publicly accused Francis of perjury and breach of faith; Francis now exceeded Charles in the indecency of his accusations. The dauphin dying suddenly, his death was imputed to poison: Montecuculi his cup-bearer was put to the rack; and that unhappy nobleman, in the agonies of torture, accused the emperor's generals Gonzaga and de Leyva, of instigating him to the detestable act. The emperor himself was suspected; nay, this extorted confession, and some obscure hints, were considered as incontrovertible proofs of his guilt; though it was evident to all mankind, that neither Charles nor his generals could have any inducement to perpetrate such a crime, as Francis was still in the vigour of life himself, and had two sons besides the dauphin, grown up to a good age.

But the incensed monarch's resentment did not stop here. Francis was not satisfied with endeavouring to blacken the character of his rival by an ambiguous testimony which led to the most injurious suspicions, and upon which the most cruel constructions had been put; he was willing to add rebellion to murder. For this purpose he went to the parliament of Paris; where being seated with the usual solemnities, the advocate-general appeared, and accused Charles of Austria (so he affected to call the emperor) of having violated the treaty of Cambray, by which he was freed from the homage due to the crown of France for the counties of Artois and Flanders; adding, that this treaty being now void, he was still to be considered as a vassal of France, and consequently had been guilty of rebellion in taking arms against his sovereign. The charge was sustained, and Charles was summoned to appear before the parliament of Paris at a day fixed. The term expired; and no person appearing in the emperor's name, the parliament gave judgement, that Charles of Austria had forfeited, by rebellion and contumacy, the counties of Flanders and Artois, and declared these fiefs reunited to the crown of France.

¹³⁴
Charles summoned to appear at Paris.

Francis, soon after this vain display of his animosity, marched into the Low Countries, as if he had intended to execute the sentence pronounced by his parliament; but a suspension of arms took place, through the interposition of the queens of France and Hungary, before any thing of consequence was effected: and this cessation of hostilities was followed by a truce, concluded at Nice, through the mediation of the reigning pontiff Paul III. of the family of Farnese, a man of a venerable character and pacific disposition.

Each of these rival princes had strong reasons to in-

cline them to peace. The finances of both were exhausted; and the emperor, the more powerful of the two, was deeply impressed with the dread of the Turkish arms, which Francis had drawn upon him by a league with Solyman. In consequence of this league, Barbarossa with a great fleet appeared on the coast of Naples; filled that kingdom with consternation; landed without resistance near Taranto; obliged Cairo, a place of some strength, to surrender; plundered the adjacent country; and was taking measures for securing and extending his conquests, when the unexpected arrival of Doria, the famous Genoese admiral, together with the pope's galleys and a squadron of the Venetian fleet, made it prudent for him to retire. The sultan's forces also invaded Hungary, where Mahmet the Turkish general, after gaining several inferior advantages, defeated the Germans in a great battle at Essek on the Drave. Happily for Charles and Europe it was not in Francis's power at this juncture either to join the Turks or assemble an army strong enough to penetrate into the Milanese. The emperor, however, was sensible that he could not long resist the efforts of two such powerful confederates, nor expect that the same fortunate circumstances would concur a second time in his favour; he therefore thought it necessary, both for his safety and reputation, to give his consent to a truce: and Francis chose rather to run the risk of disobliging his new ally the sultan, than to draw on his head the indignation, and perhaps the arms, of all Christendom, by obstinately obstructing the re-establishment of tranquillity, and contributing to the aggrandizement of the Infidels.

^{Spain.}

¹³⁵
Francis leagues with the Turks.

¹³⁶
A truce concluded.

These considerations inclined the contending monarchs to listen to the arguments of the holy father; but he found it impossible to bring about a final accommodation between them, each inflexibly persisting in asserting his own claims. Nor could he prevail on them to see one another, though both came to the place of rendezvous; so great was the remains of distrust and rancour, or such the difficulty of adjusting the ceremonial! Yet, improvable as it may seem, a few days after signing the truce, the emperor, in his passage to Barcelona, being driven on the coast of Provence, Francis invited him to come ashore; frankly visited him on board his galley, and was received and entertained with the warmest demonstrations of esteem and affection. Charles, with an equal degree of confidence, paid the king next day a visit at Aigues-mortes; where these two hostile rivals and vindictive enemies, who had accused each other of every kind of baseness, conversing together with all the cordiality of brothers, seemed to vie with each other in expressions of respect and friendship.

¹³⁷
Interview between Francis and Charles.

Besides the glory of having restored tranquillity to Advantage Europe, the pope gained a point of much consequence to his family. He obtained for his grandson, Margaret of Austria, the emperor's natural daughter, formerly wife of Alexander de Medici, whom Charles had raised to the supreme power in Florence. Laurence de Medici, the kinsman and intimate companion of Alexander, had assassinated him by one of the blackest treasons recorded in history. Under pretence of having secured him an ascription with a lady of the highest rank and great beauty, he drew him into a secret apartment of his house, and there stabbed him as he lay carelessly on a couch, expecting the embrace of the lovely fair, whom he had often

¹³⁸
Advantage gained by the pope from this justification.

Spain. often solicited in vain. Laurein, however, did not reap the fruits of his crime; for though some of his countrymen extolled him as a third Brutus, and endeavoured to seize this occasion for recovering their liberties, the government of Florence passed into the hands of Cosmo II. another kinsman of Alexander. Cosmo was delirious of marrying the widow of his predecessor; but the emperor chose rather to oblige the pope, by bestowing his daughter upon Octavio Farnefe, son of the duke of Parma.

139 Charles distressed. Charles had soon farther cause to be sensible of his obligations to the holy father for bringing about the treaty of Nice. His troops everywhere mutinied for want of pay, and the ability of his generals only could have prevented a total revolt. He had depended, as his chief resource for discharging the arrears due to his soldiers, upon the subsidies which he expected from his Castilian subjects. For this purpose he assembled the Cortes of Castile at Toledo; and having represented to them the great expence of his military operations, he proposed to levy such supplies as the present exigency of affairs demanded, by a general excise on commodities; but the Spaniards, who already felt themselves oppressed by a load of taxes unknown to their ancestors, and who had often complained that their country was drained of its wealth and inhabitants, in order to prosecute quarrels in which they had no interest, determined not to add voluntarily to their own burdens. The nobles, in particular, inveighed with great vehemence against the imposition proposed, as an encroachment on the valuable and distinguishing privilege of their order, that of being exempted from the payment of any tax. After employing arguments and promises in vain, Charles dismissed the assembly with indignation; and from that period neither the nobles nor the prelates have been called to the Cortes, on pretence that such as pay no part of the public taxes should not claim a vote in laying them on. These assemblies have since consisted merely of the procurators or representatives of 18 cities, two from each; in all 36 members, who are absolutely at the devotion of the crown.

140 The Spaniards refuse to assist him with money. The citizens of Ghent, still more bold, broke out not long after into open rebellion against the emperor's government, on account of a tax which they judged contrary to their ancient privileges, and a decision of the council of Mechlin in favour of the imperial authority. Enraged at an unjust imposition, and rendered desperate on seeing their rights betrayed by that very court which was bound to protect them, they flew to arms, seized several of the emperor's officers, and drove such of the nobility as resided among them out of the city. Sensible, however, of their inability to support what their zeal had prompted them to undertake, and desirous of securing a protector against the formidable forces with which they might expect soon to be attacked, they offered to acknowledge the king of France as their sovereign, to put him into immediate possession of their city, and to assist him in recovering those provinces in the Netherlands which had anciently belonged to his crown. True policy directed Francis to comply with this proposal. The counties of Flanders and Artois were more valuable than the duchy of Milan, for which he had so long contended; and their situation in regard to France made it more easy to conquer or to defend them. But Francis over-rated the Milanese. He had lived in friend-

Spain. ship with the emperor ever since their interview at Aigues-mortes, and Charles had promised him the investiture of that duchy. Forgetting, therefore, all his past injuries, and the deceitful promises by which he had been so often duped, the credulous, generous Francis, not only rejected the propositions of the citizens of Ghent, but communicated to the emperor his whole negotiation with the malecontent.

Judging of Charles's heart by his own, Francis hoped by this seemingly disinterested proceeding to obtain at once the investiture of Milan; and the emperor, well acquainted with the weakness of his rival, flattered him in this apprehension, for his own selfish purposes. His presence being necessary in the Netherlands, he demanded a passage through France. It was immediately granted him; and Charles, to whom every moment was precious, let out, notwithstanding the remonstrances of his council and the fears of his Spanish subjects, with a small but splendid train of 100 persons. He was met on the frontiers of France by the dauphin and the duke of Orleans, who offered to go into Spain, and remain there as hostages, till he should reach his own dominions; but Charles replied, that the king's honour was sufficient for his safety, and prosecuted his journey without any other security. The king entertained him with the utmost magnificence at Paris, and the two young princes did not take leave of him till he entered the Low Countries; yet he still found means to evade his promise, and Francis continued to believe him sincere.

141 Charles to the city of Ghent. The citizens of Ghent, alarmed at the approach of the emperor, who was joined by three armies, sent ambassadors to implore his mercy, and offered to throw open their gates. Charles only condescended to reply, "That he would appear among them as a sovereign and a judge, with the sceptre and the sword." He accordingly entered the place of his nativity on the anniversary of his birth; and instead of that lenity which might have been expected, exhibited an awful example of his severity. Twenty-six of the principal citizens were put to death: a greater number was banished: the city was declared to have forfeited its privileges; a new system of laws and political administration was prescribed; and a large fine was imposed on the inhabitants, in order to defray the expence of erecting a citadel, together with an annual tax for the support of a garrison. They were not only deprived of their ancient immunities, but made to pay, like conquered people, for the means of perpetuating their own slavery.

142 H. base treatment of Francis. Having thus re-established his authority in the Low Countries, and being now under no necessity of continuing that scene of falsehood and dissimulation with which he had amused the French monarch, Charles began gradually to throw aside the veil under which he had concealed his intentions with respect to the Milanese, and at last peremptorily refused to give up a territory of great value, or voluntarily to make such a liberal addition to the strength of an enemy by diminishing his own power. He even denied that he had ever made any promise which could bind him to an action so foolish, and so contrary to his own interest.

This transaction exposed the king of France to as much scorn as it did the emperor to censure. The credulous simplicity of Francis seemed to merit no other return, after experiencing so often the duplicity and artifice of his rival. He remonstrated, however, and ex-

Spain

claimed as if this had been the first circumstance in which the emperor had deceived him. The insult offered to his understanding affected him even more sensibly than the injury done to his interest; and he discovered such resentment as made it obvious that he would seize on the first opportunity of revenge, and that a new war would soon disturb the European continent.

126
He is obliged to make concessions to the Protestants.

Meanwhile Charles was obliged to turn his attention towards the affairs of Germany. The Protestants having in vain demanded a general council, pressed him earnestly to appoint a conference between a select number of divines of each party, in order to examine the points in dispute. For this purpose a diet was assembled at Ratisbon: and such a conference, notwithstanding the opposition of the pope, was held with great solemnity in the presence of the emperor. But the divines chosen to manage the controversy, though men of learning and moderation, were only able to settle a few speculative opinions, all points relative to worship and jurisdiction serving to inflame the minds of the disputants. Charles, therefore, finding his endeavours to bring about an accommodation ineffectual, and being impatient to close the diet, prevailed on a majority of the members to approve of the following edict of recess; viz. that the articles concerning which the divines had agreed, should be held as points decided; that those about which they had differed, should be referred to the determination of a general council, or if that could not be obtained, to a national synod: and should it prove impracticable also to assemble a synod of Germany, that a general diet of the empire should be called within 18 months, in order to give final judgment on the whole controversy; that, in the mean time, no innovations should be attempted, nor any endeavours employed to gain proselytes.

This diet gave great offence to the pope. The bare mention of allowing a diet, composed chiefly of laymen, to pass judgement in regard to articles of faith, appeared to him no less criminal and profane than the worst of those heresies which the emperor seemed so zealous to suppress. The Protestants also were dissatisfied with it, as it considerably abridged the liberty which they at that time enjoyed. They murmured loudly against it; and Charles, unwilling to leave any seeds of discontent in the empire, granted them a private declaration, exempting them from whatever they thought injurious or oppressive in the recess, and ascertaining to them the full possession of all their former privileges.

The situation of the emperor's affairs at this juncture made these extraordinary concessions necessary. He foresaw a rupture with France to be unavoidable, and he was alarmed at the rapid progress of the Turks in Hungary. A great revolution had happened in that kingdom. John Zepol Scerius, by the assistance of Solyman, had wrested from the king of the Romans a considerable part of the country. John died, and left an infant son. Ferdinand attempted to take advantage of the minority, in order to repossess himself of the whole kingdom; but his ambition was disappointed by the activity and address of George Martinuzzi, bishop of Waradi, who shared the regency with the queen. So sensible that he was unable to oppose the king of the Romans in the field, Martinuzzi fortified himself with holding out the fortified towns, all of which he provided with every thing necessary for defence; and at the same

Spain

time he sent ambassadors to Solyman, beseeching him to extend towards the son that imperial protection which had so generously maintained the father on his throne. Ferdinand used his utmost endeavours to thwart this negotiation, and even meanly offered to hold the Hungarian crown on the same ignominious condition by which John had held it, that of paying tribute to the Porte. But the sultan saw such advantages from espousing the interest of the young king, that he instantly marched into Hungary; and the Germans, having formed the siege of Buda, were defeated with great slaughter before that city. Solyman, however, instead of becoming the protector of the infant sovereign whom he had relieved, made use of this success to extend his own dominions: he sent the queen and her son into Transylvania, which province he allotted them, and added Hungary to the Ottoman empire.

Happily for the Protestants, Charles received intelligence of this revolution soon after the diet at Ratisbon; and by the concessions which he made them, he obtained such liberal supplies, both of men and money, as left him under little anxiety about the security of Germany. He therefore hastened to join his fleet and army in Italy, in order to carry into execution a great and favourite enterprise which he had concerted against Algiers; though it would certainly have been more consistent with his dignity to have conducted the whole force of the empire against Solyman, the common enemy of Christendom, who was ready to enter his Austrian dominions. But many reasons induced Charles to prefer the African expedition: he wanted strength, or at least money, to combat the Turks in so distant a country as Hungary; and the glory which he had formerly acquired in Barbary led him to hope for the like success, while the cries of his Spanish subjects roused him to take vengeance on their ravagers. But the unfortunate event of this expedition has already been related under the article ALGIERS, N^o 14—20.

The loss which the emperor suffered in this calamitous expedition encouraged the king of France to begin hostilities, on which he had been for some time resolved; and an action dishonourable to civil society furnished him with too good a pretext for taking arms. The marquis del Guasto, governor of the Milanese, having got intelligence of the motions and destination of two ambassadors, Kincaid and Fergo, whom Francis had dispatched, the one to the Ottoman Porte, the other to the republic of Venice; knowing how much his master wished to discover the intentions of the French monarch, and of what consequence it was to retard the execution of his measures, he employed some soldiers belonging to the garrison of Pavia to lie in wait for these ambassadors as they laid down the Po, who murdered them and most of their attendants, and seized their papers. Francis immediately demanded reparation for this barbarous outrage; and as Charles endeavoured to put him off with an evasive answer, he appealed to all the courts of Europe, setting forth the heinousness of the injury, the iniquity of the emperor in disregarding his just request, and the necessity of vengeance. But Charles, who was a more profound negotiator, defeated in a great measure the effects of these representations: he secured the fidelity of the Protestant princes in Germany, by granting them new concessions; and he engaged the king of England to espouse his cause, and under

147
Understands in articles of union expedition against Algiers.

148
War between Francis and Charles.

pretence of defending Europe against the Halls; while Francis was only able to form an alliance with the kings of Denmark and Sweden (who for the first time interested themselves in the quarrels of the more potent monarchs of the main), and to renew his treaty with Solomon, which drew on him the indignation of Carthendom.

But the activity of Francis supplied all the defects of his negotiation. Five armies were soon ready to take the field, under different generals, and with different destinations. Nor was Charles wanting in his preparations. He and Henry a second time made an ideal division of the kingdom of France. But as the hostilities which followed terminated in nothing decisive, and were distinguished by no remarkable event, except the battle of Cerifoles (gained by Count d'Enghien over the imperialists, and in which 10,000 of the emperor's best troops fell), and in which Francis and Charles, mutually tired of harassing each other, concluded at Crepy a treaty of peace, in which the king of England was not mentioned; and from being implacable enemies, became once more, to appearance, cordial friends, and even allies by the ties of blood.

The chief articles of this treaty were, that all the conquests which either party had made since the truce of Nice should be restored; that the emperor should give in marriage to the duke of Orleans, either his own eldest daughter, with the Low Countries, or the second daughter of his brother Ferdinand, with the investiture of the Milanese; that Francis should renounce all pretensions to the kingdom of Naples, as well as to the sovereignty of Flanders and Artois, and Charles give up his claim to the duchy of Burgundy; and that both should unite in making war against the Turks.

The emperor was chiefly induced to grant conditions to advantageous to France, by a desire of humbling the Protestant princes in Germany. With the papal jurisdiction, he foresaw they would endeavour to throw off the imperial authority; and he determined to make his zeal for the former a pretence for enforcing and extending the latter. However, the death of the duke of Orleans before the consummation of his marriage, disentangled the emperor from the most troublesome stipulation in the treaty of Crepy; and the French monarch, being still engaged in hostilities with England, was unable to obtain any reparation for the loss which he suffered by this unforeseen event. These hostilities, like those between Charles and Francis, terminated in nothing decisive. Equally tired of a struggle attended with no glory or advantage to either, the contending princes concluded, at Campe, near Ardies, a treaty of peace; in which it was stipulated, that France should pay the arrears due by former treaties to England. But these arrears did not exceed one-third of the sums expended by Henry on his military operations; and Francis being in no condition to discharge them, Bouloigne (a chargeable pledge) was left in the hands of the English as a security for the debt.

In consequence of the emperor's resolution to humble the Protestant princes, he concluded a dishonourable peace with the Porte, stipulating that his brother Ferdinand should pay tribute for that part of Hungary which he still possessed; while the sultan enjoyed the imperial and undisturbed possession of all the rest. At the same time he entered into a league with Pope

Paul III. for the extirpation of heresy; but in reality with a view to oppress the liberties of Germany. Here, however, his ambition met with a severe check; he though he was successful at first, he was obliged in 1552 to conclude a peace with the Protestants on their own terms; as has been related under the article FERDINAND, N^o 26—37.

By the peace concluded on this occasion the emperor lost Metz, Toul, and Verdun, which had formed the frontier barrier of the empire on two quarters; and thereafter soon after put himself at the head of an army, in order to recover these three bishoprics. In order to conceal the destination of his army, he gave out, that he intended to lead it into Hungary, to defend Maurice in his operations against the Halls; and as this pretext failed him, when he began to advance towards the Rhine, he propagated a report that he was marching first to challenge Albert of Brandenburg, who had refused to be included in the treaty of Pannu, and whose cruel exactions in that part of Germany called loudly for redress.

The French, however, were not deceived by these arts. Henry immediately quitted the true object of Charles's armament, and resolved to defend his conquests with vigour. The defence of Metz, against which it was foreseen the whole weight of the war would be turned, was committed to Francis of Lorraine, duke of Guise, who possessed in an eminent degree all the qualities that render men great in military command. He required with joy the dangerous situation; and many of the French nobility, and even princes of the blood, eager to distinguish themselves under such a leader, entered Metz as volunteers. The city was of great extent, ill fortified, and the suburbs large. For all these defects the duke endeavoured to provide a remedy. He repaired the old fortifications with all possible expedition, labouring with his own hands; the officers imitated his example; and the soldiers, thus encouraged, cheerfully submitted to the most severe toils; he erected new works, and he levelled the suburbs with the ground. At the same time he filled the magazines with provisions and military stores, compelled all useless persons to leave the place, and laid waste the neighbouring country; yet his were his popular talents, as well as his arts of acquiring an ascendancy over the minds of men, that the citizens not only refrained from murmuring, but seconded him with no less ardour than the soldiers in all his operations—in the ruin of their estates, and in the havoc of their public and private buildings.

Meanwhile the emperor continued his march towards Lorraine, at the head of 60,000 men. On his approach Albert of Brandenburg, whose army did not exceed 20,000 withdrew into that principality, as if he intended to join the French king; and Charles, notwithstanding the advanced season, it being towards the end of October, laid siege to Metz, contrary to the advice of his most experienced officers.

The attention of both the beneficers and the besiegers was turned for some time towards the motions of Albert, who still hovered in the neighbourhood, undetermined which side to take, though resolved to lend his service. Charles at last came up to his post, and he joined the imperial army. The emperor now perceived himself that nothing could resist his forces; but he could himself be deceived. After a siege of about 60 days, the

Eng

Spain

Spain

149
Peace concluded at Crepy.

150
Charles obliged to conclude a disadvantageous peace with the Turks and Protestants.

Spain. King which he had attempted all that was thought possible for art or valour to effect, and had lost upwards of 30,000 men by the inclemency of the weather, diseases, or the sword of the enemy, he was obliged to abandon the enterprise.

153
Miserable
condition of
his army.

When the French sallied out to attack the enemy's rear, the imperial camp was filled with the sick and wounded, with the dead and the dying. All the roads by which the army retired were strewn with the same miserable objects; who, having made an effort beyond their strength to escape, and not being able to proceed, were left to perish without assistance. Happily that, and all the kind offices which their friends had not the power to perform, they received from their enemies. The duke of Guise ordered them all to be taken care of, and supplied with every necessary; he appointed physicians to attend, and direct what treatment was proper for the sick and wounded, and what refreshments for the feeble; and such as recovered he sent home, under an escort of soldiers, and with money to bear their charges. By these acts of humanity, less common in that age, the duke of Guise completed that heroic character which he had justly acquired by his brave and successful defence of Metz.

154
No further
advances.

The emperor's misfortunes were not confined to Germany. During his residence at Villach, he had been obliged to borrow 200,000 crowns of Cosmo de Medici; and so low was his credit, that he was obliged to put Cosmo in possession of the principality of Piombino as a security for that inconsiderable sum; by which means he lost the footing he had hitherto maintained in Tuscany. Much about the same time he lost Sienna. The citizens, who had long enjoyed a republican government, rose against the Spanish garrison, which they had admitted as a check upon the tyranny of the nobility, but which they found was meant to enslave them; forgetting their domestic animosities, they recalled the exiled nobles; they demolished the citadel, and put themselves under the protection of France.

To these unfortunate events one still more fatal had almost succeeded. The severe administration of the viceroy of Naples had filled that kingdom with murmuring and dissatisfaction. The prince of Salerno, the head of the malecontents, fled to the court of France. The French monarch, after the example of his father, applied to the grand signior; and Solyman, at that time highly incensed against the house of Austria on account of the proceedings in Hungary, sent a powerful fleet into the Mediterranean, under the command of the corsair Dragut, an officer trained up under Barbarossa, and scarcely inferior to his master in courage, talents, or in good fortune. Dragut appeared on the coast of Calabria at the time appointed; but not being joined by the French fleet according to concert, he returned to Constantinople, after plundering and burning several places, and filling Naples with consternation.

155
I first dis-
ful in the
L. w. Coun-
tries.

Highly mortified by so many disasters, Charles retired into the Low Countries, breathing vengeance against France: and here the war was carried on with considerable vigour. Impatient to efface the stain which his military reputation had received before Metz, Charles laid siege to Terouane; and the fortifications being in disrepair, that important place was carried by assault.

Heldin also was invested, and carried in the same manner. The king of France was too late in assembling his forces to afford relief to either of these places; and the emperor afterwards cautiously avoided an engagement.

156
But not so
in other
places.

The imperial arms were less successful in Italy. The viceroy of Naples failed in an attempt to recover Sienna; and the French not only established themselves more firmly in Tuscany, but conquered part of the island of Corica. Nor did the affairs of the house of Austria go on better in Hungary during the course of this year. Isabella and her son appeared once more in Transylvania, at a time when the people were ready for revolt, in order to revenge the death of Martuzzi, whose loss they had severely felt. Some noblemen of eminence declared in favour of the young king; and the ballaw of Belgrade, by Solyman's order, espousing his cause, in opposition to Ferdinand, Castaldo, the Austrian general, was obliged to abandon Transylvania to Isabella and the Turks.

157
Marriage
between his
son Philip
and Mary of
England.
An. 1554.

In order to counterbalance these and other losses, the emperor, in 1554, concerted a marriage between his son Philip and Mary of England, in hopes of adding that kingdom to his other dominions. Meanwhile the war between Henry and Charles was carried on with various success in the Low Countries, and in Italy much to the disadvantage of France. The French, under the command of Strozzi, were defeated in the battle of Merciano; Sienna was reduced by Medicino, the Florentine general, after a siege of ten months; and the gallant Siennese were subjected to the Spanish yoke. Much about the same time a plot was formed by the Franciscans, but happily discovered before it could be carried into execution, to betray Metz to the Imperialists. The father guardian, and twenty other monks, received sentence of death on account of this conspiracy; but the guardian, before the time appointed for his execution, was murdered by his incensed accomplices, whom he had seduced; and six of the youngest were pardoned.

158
Charles re-
gains his
dominions
to his son
Philip.
An. 1556.

While war thus raged in Italy and the Low Countries, Germany enjoyed such profound tranquillity, as afforded the diet full leisure to confirm and perfect the plan of religious pacification agreed upon at Passau, and referred to the consideration of the next meeting of the Germanic body. During the negotiation of this treaty, an event happened which astonished all Europe, and confounded the reasonings of the wisest politicians. The emperor Charles V. though no more than 56, an age when objects of ambition operate with full force on the mind, and are generally pursued with the greatest ardour, had for some time formed the resolution of resigning his hereditary dominions to his son Philip. He now determined to put it in execution. Various have been the opinions of historians concerning a resolution so singular and unexpected; but the most probable seem to be, the disappointments which Charles had met with in his ambitious hopes, and the daily decline of his health. He had early in life been attacked with the gout; and the fits were now become so frequent and severe, that not only the vigour of his constitution was broken, but the faculties of his mind were sensibly impaired. He therefore judged it more decent to conceal his infirmities in some solitude, than to expose them any longer to the public eye; and as he was unwilling

Spain. to forfeit the fame, or lose the acquisitions of his better years, by attempting to guide the reins of government when he was no longer able to hold them with steadiness, he determined to seek in the tranquillity of retirement, that happiness which he had in vain pursued amidst the tumults of war and the intrigues of state.

In consequence of this resolution, Charles, who had already ceded to his son Philip the kingdom of Naples and the duchy of Milan, assembled the states of the Low Countries at Brussels: and seating himself for the last time in the chair of state, he explained to his subjects the reasons of his resignation, and solemnly devolved his authority upon Philip. He recounted with dignity, but without ostentation, all the great things which he had undertaken and performed since the commencement of his administration. "I have dedicated (observed he), from the 17th year of my age, all my thoughts and attention to public objects, reserving no portion of my time for the indulgence of ease, and very little for the enjoyment of private pleasure. Either in a pacific or hostile manner, I have visited Germany nine times, Spain six times, France four times, Italy seven times, the Low Countries ten times, England twice, Africa as often; and while my health permitted me to discharge the duty of a sovereign, and the vigour of my constitution was equal in any degree to the arduous office of governing such extensive dominions, I never shunned labour, nor repined under fatigue; but now, when my health is broken, and my vigour exhausted by the rage of an incurable dilemma, my growing infirmities admonish me to retire; nor am I so fond of reigning, as to retain the sceptre in an impotent hand, which is no longer able to protect my subjects. Instead of a sovereign worn out with diseases (continued he), and scarce half alive, I give you one in the prime of life, already accustomed to govern, and who adds to the vigour of youth all the attention and sagacity of maturer years." Then turning towards Philip, who fell on his knees, and kissed his father's hand, "It is in your power (said Charles), by a wife and virtuous administration, to justify the extraordinary proof which I give this day of my paternal affection, and to demonstrate that you are worthy of the extraordinary confidence which I repose in you. Preserve (added he) an inviolable regard for religion; maintain the Catholic faith in its purity; let the laws of your country be sacred in your eyes; encroach not on the rights of your people; and if the time should ever come when you shall wish to enjoy the tranquillity of private life, may you have a son to whom you can resign your sceptre with as much satisfaction as I give up mine to you." A few weeks after, he resigned to Philip the sovereignty of Spain and America; reserving nothing to himself out of all these vast possessions but an annual pension of 100,000 crowns.

Charles was now impatient to embark for Spain, where he had fixed on a place of retreat; but by the advice of his physicians, he put off his voyage for some months, on account of the feverish of the season: and, by yielding to their judgment, he had the satisfaction before he left the Low Countries of taking a considerable step towards a peace with France. This he ardently longed for; not only on his son's account, whose administration he

Spain. wished to commence in quietness, but that he might have the glory, when quitting the world, of restoring to Europe that tranquillity which his ambition had banished out of it almost from the time that he assumed the reins of government.

The great bar to such a pacification, on the part of France, was the treaty which Henry had concluded with the Pope; and the emperor's claims were too numerous to hope for adjusting them suddenly. A truce of five years was therefore proposed by Charles; during which term, without discussing their respective pretensions, each should retain what was in his possession; and Henry, through the persuasion of the confiable Montmorency, who represented the imprudence of sacrificing the true interests of his kingdom to the rash engagements that he had come under with Paul, authorized his ambassadors to sign at Vaucelles a treaty, which would insure to him for so considerable a period the important conquest which he had made on the German frontier, together with the greater part of the duke of Savoy's dominions.

The Pope, when informed of this transaction, was no less filled with terror and astonishment than rage and indignation. But he took equal care to conceal his fear and his anger. He affected to approve highly of the truce; and he offered his mediation, as the common father of Christendom, in order to bring about a definitive peace. Under this pretext, he appointed Cardinal Rebibo his nuncio to the court of Brussels, and his nephew Cardinal Caraffa to that of Paris. The public instructions of both were the same; but Caraffa, besides these, received a private commission, to spare neither intreaties, promises, nor bribes, in order to induce the French monarch to renounce the truce and renew his engagements with the holy see. He flattered Henry with the conquest of Naples; he gained by his address the Guises, the queen, and even the famous Diana of Poitiers, duchess of Valentinois, the king's mistress; and they easily swayed the king himself, who already leaned to that side towards which they wished to incline him. All Montmorency's prudent remonstrances were disregarded; the nuncio (by powers from Rome) absolved Henry from his oath of truce; and that weak prince signed a new treaty with the Pope; which rekindled with fresh violence the flames of war, both in Italy and the Low Countries.

No sooner was Paul made acquainted with the success of this negotiation than he proceeded to the most indecent extremities against Philip. He ordered the Spanish ambassadors to be imprisoned; he excommunicated the Colonnas, because of their attachment to the imperial house; and he considered Philip as guilty of high treason, and to have forfeited his right to the kingdom of Naples, which he was supposed to hold of the holy see, for afterward affording them a retreat in his dominions.

Alarmed at a quarrel with the Pope, whom he had been taught to regard with the most superstitious veneration, as the vicegerent of Christ and the common father of Christendom, Philip tried every gentle method before he made use of force. He even consulted some Spanish divines on the lawfulness of taking arms against a person so sacred. They decided in his favour; and Paul continuing inexorable, the duke of Alva, to whom

120
A truce of
five years
concluded
with
France.

16
Quarrel be-
tween the
Pope and
King Phi-
lip.

Spain

the negotiations as well as the war had been committed, entered the ecclesiastical state at the head of 10,000 veterans, and carried terror to the gates of Rome.

The haughty pontiff, though still inflexible and undaunted himself, was forced to give way to the fears of the cardinals, and a truce was concluded for 40 days. Mean time the duke of Guise, arriving with a supply of 20,000 French troops, Paul became more arrogant than ever, and banished all thoughts from his mind but those of war and revenge. The duke of Guise, however, who had precipitated his country into this war, chiefly from a desire of gaining a field where he might display his own talents, was able to perform nothing in Italy worthy of his former fame. He was obliged to abandon the siege of Civitella; he could not bring the duke of Alva to a general engagement; his army perished by diseases; and the Pope neglected to furnish the necessary reinforcements. He begged to be recalled; and France stood in need of his abilities.

Philip, though willing to have avoided a rupture, was no sooner informed that Henry had violated the truce of Vaucelles, than he determined to act with such vigour, as should convince Europe that his father had not erred in resigning to him the reins of government. He immediately assembled in the Low Countries a body of 50,000 men, and obtained a supply of 10,000 from England, which he had engaged in his quarrel; and as he was not ambitious of military fame, he gave the command of his army to Emanuel Philibert duke of Savoy, one of the greatest generals of that warlike age.

The duke of Savoy kept the enemy for some time in suspense with regard to his destination; at last he seemed to threaten Champagne, towards which the French drew all their troops; then turning suddenly to the right, he advanced by rapid marches into Picardy, and

161
The French
embarked
St. Quentin.
At 1527.

had siege to St. Quentin. It was deemed in those times a town of considerable strength; but the fortifications had been much neglected, and the garrison did not amount to a fifth part of the number requisite for its defence; it must therefore have surrendered in a few days, if the admiral de Coligny had not taken the gallant resolution of throwing himself into it with such a body of men as could be collected on a sudden. This he effected in spite of the enemy, breaking through their main body. The place, however, was closely invested, and the comdable Montmorency, anxious to extricate his nephew out of that perilous situation, in which his zeal for the public had engaged him, as well as to save a town of such importance, rashly advanced to its relief with forces one half inferior to those of the enemy. His army was cut in pieces, and he himself made prisoner.

The cautious temper of Philip on this occasion saved France from devastation, if not ruin. The duke of Savoy proposed to overlook all inferior objects, and march speedily to Paris, which, in its present conformation, he could not have failed to make himself master of; but Philip, afraid of the consequences of such a bold enterprise, desired him to continue the siege of St. Quentin, in order to secure a safe retreat in case of any disastrous event. The town, long and gallantly defended by Coligny, was at last taken by storm; but not till France was in a state of defence.

Philip was now sensible that he had lost an opportunity which could never be recalled, of distribling his

Spain

enemy, and contented himself with reducing Horn and Catelet; which petty towns, together with St. Quentin, were the sole fruits of one of the most decisive victories gained in the 16th century. The Catholic king, however, continued in high exultation on account of his success; and as all his passions were tinged with superstition, he vowed to build a church, a monastery, and a palace, in honour of St. Laurence, on the day sacred to whose memory the battle of St. Quentin had been fought. He accordingly laid the foundation of an edifice, in which all these were included, and which he continued to forward at vast expence, for 22 years. The same principle which dictated the vow directed the building. It was so formed as to resemble a griddle—on which culinary instrument, according to the legendary tale, St. Laurence had suffered martyrdom. Such is the origin of the famous Ecurial near Madrid, the royal residence of the kings of Spain.

The first account of that fatal blow which France had received at St. Quentin, was carried to Rome by the courier whom Henry had sent to recal the duke of Guise. Paul remonstrated warmly against the departure of the French army; but Guise's orders were peremptory. The arrogant pontiff therefore found it necessary to accommodate his conduct to the exigency of his affairs, and to employ the mediation of the Venetians, and of Cosmo de Medici, in order to obtain peace. The first overtures of this nature were eagerly listened to by the Catholic king, who still doubted the justice of his cause, and considered it as his greatest misfortune to be obliged to contend with the Pope. Paul agreed to renounce his league with France; and Philip stipulated on his part, that the duke of Alva should repair in person to Rome, and after asking pardon of the holy father in his own name and in that of his master, for having invaded the patrimony of the church, should receive absolution from that crime. Thus Paul, through the superstitious timidity of Philip, finished an unpropitious war not only without any detriment to the apostolic see, but saw his conqueror humbled at his feet; and so excessive was the veneration of the Spaniards in that age for the papal character, that the duke of Alva, the proudest man perhaps of his time, and accustomed from his infancy to converse with princes, acknowledged, that when he approached Paul, he was so much overawed, that his voice failed, and his presence of mind forsok him.

163
Confederates of the
in 1611.

But though this war, which at its commencement threatened mighty revolutions, was terminated without effecting any alteration in those states which were its immediate object, it produced effects of considerable consequence in other parts of Italy. In order to detach Octavio Farnese, duke of Parma, from the French interest, Philip restored to him the city of Piacenza and its territory, which had been seized by Charles V. and he granted to Cosmo de Medici the investiture of Sicily, as an equivalent for the sums due to him. By these treaties, the balance of power among the Italian states was poised with more equality, and rendered less variable than it had been since it received the first violent shock from the invasion of Charles VIII. and Italy henceforth ceased to be the theatre on which the monarchs of Spain, France, and Germany, contended for fame and dominion. Their hostilities, excited by new objects, rained other regions of Europe with blood,

162
Peace con-
cluded.

Spain, and made other states feel, in their turn, the miseries of war.

¹⁰⁴ The duke of Guise, who left Rome the same day that his adversary the duke of Alva made his humiliating submission to the Pope, was received in France as the guardian angel of the kingdom. He was appointed lieutenant-general in chief, with a jurisdiction almost unlimited; and, eager to justify the extraordinary confidence which the king had reposed in him, as well as to perform something suitable to the high expectations of his countrymen, he undertook in winter the siege of Calais. Having taken that place, he next invested Thionville in the duchy of Luxembourg, one of the strongest towns on the frontiers of the Netherlands; and forced it to capitulate after a siege of three weeks. But the advantages on this quarter were more than balanced by an event which happened in another part of the Low Countries. The marshal de Termes governor of Calais, who had penetrated into Flanders and taken Dunkirk, was totally routed near Gravelines, and taken prisoner by Count Egmont. This disaster obliged the duke of Guise to relinquish all his other schemes, and hasten towards the frontiers of Picardy, that he might there oppose the progress of the enemy.

The eyes of all France were now turned towards the duke of Guise, as the only general on whose aims victory always attended, and in whose conduct as well as good fortune they could confide in every danger. His strength was nearly equal to the duke of Savoy's, each commanding about 40,000 men. They encamped at the distance of a few leagues from one another; and the French and Spanish monarchs having joined their respective armies, it was expected that, after the vicissitudes of war, a decisive battle would at last determine which of the rivals should take the ascendancy for the future in the affairs of Europe. But both monarchs, as if by agreement, stood on the defensive; neither of them discovering any inclination, though each had it in his power, to rest the decision of a point of such importance on the issue of a single battle.

¹⁶⁵ During this state of inaction, peace began to be mentioned in each camp, and both Henry and Philip discovered an equal disposition to listen to any overture that tended to re-establish it. The private inclinations of both kings concurred with their political interests and the wishes of their people. Philip languished to return to Spain, the place of his nativity, and peace only could enable him, either with decency or safety, to quit the Low Countries. Henry was now desirous of being freed from the avocations of war, that he might have leisure to turn the whole force of his government towards suppressing the opinions of the reformers, which were spreading with such rapidity in Paris and the other great towns, that they began to grow formidable to the established church. Court-intrigues conspired with these public and avowed motives to hasten the negotiation, and the abbey of Cercamp was fixed on as the place of congress.

While Philip and Henry were making these advances towards a treaty which restored tranquillity to Europe, Charles V. whose ambition had so long disturbed it, but who had been for some time dead to the world, ended his days in the monastery of St Juitus in Eilremdura, which he had chosen as the place of his retreat, and is particularly related under the article CHARLES V.

VOL. XIX. Part II.

After the death of Charles, the kingdom of Spain soon lost great part of its consequence. Though Charles had used all his interest to get his son Philip elected emperor of Germany, he had been totally disappointed; and thus the grandeur of Philip II. never equalled that of his father. His dominions were also considerably abridged by his tyrannical behaviour in the Netherlands. In consequence of this, the United Provinces revolted; and after a long and bloody war obtained their liberty. In this quarrel Elizabeth of England took part against Philip, which brought on a war with Spain. The great losses he sustained in this war exhausted the kingdom both of men and money, notwithstanding the great sums imported from America. Indeed the discovery of that country has much impoverished, instead of enriching Spain; for thus the inhabitants have been rendered lazy and averse to every kind of manufacture or traffic, which only can be a durable source of riches and strength to any nation. The ruin of the kingdom in this respect, however, was completed by Philip III. who, at the instigation of the acquisition, and by the advice of his prime minister the duke of Lerma, expelled from the kingdom all the Morecoes or Moors, descendants of the ancient conquerors of Spain. Thirty days only were allowed them to prepare for their departure, and it was death to remain beyond that time. The reason for this barbarous decree was, that these people were still Mahometans in their hearts, though they conformed externally to the rites of Christianity, and thus might corrupt the true faith. The Morecoes, however, chose themselves a king, and attempted to oppose the royal mandate; but, being almost entirely unprovided with arms, they were soon obliged to submit, and were all banished the kingdom. By this violent and impolitic measure, Spain lost almost a million of industrious inhabitants; and as the kingdom was already depopulated by bloody wars, by repeated emigrations to America, and enervated by luxury, it now sank into a state of languor from which it has never recovered.

The reign of Philip IV. the successor of Philip III. commenced in 1621. He had not been long seated on the throne before the expiration of the 12 years truce which Philip III. had concluded with the United Provinces, again involved Spain in the calamities of war. The renewed contest was carried on with vigour by both the contending powers, till in the year 1648 the Spanish monarch was compelled to sign the treaty of Munster, by which the United Provinces were declared free and independent. From this period the power of the Spanish monarchy began to decline, as it had already been severely shaken by the loss of Portugal.

This event took place in 1645, when the Portuguese finally threw off the Spanish yoke, and that country remained an independent kingdom, till the power of Bonaparte compelled its lawful monarch to abandon his European territories. Philip IV. also prosecuted an unsuccessful war with France. This war was terminated in 1659, and Philip died about six years after.

The new monarch, Charles II. was only four years old when he succeeded to the throne. He was of a feeble constitution, and a weak capacity. The war which had been occasioned by the revolt of Portugal, continued till the year 1668, when a peace was concluded, and the independence of that kingdom was acknowledged. Hostilities had been renewed with France,

Spain. but greatly to the disadvantage of the Spaniards, who lost some of the richest and best fortified towns which they still possessed in Flanders. The peace of Nimwegen between France and Spain was signed in the year 1678. Charles II. died in 1700, and with him ended the male line of the house of Austria; a dynasty to which Spain owes less than to any other race of its monarchs.

Historians have been fond of representing the dominion of the Austrian princes in Spain as productive of the greatest glory and advantage to that kingdom. The reign of Charles V. may indeed be said to have been a glorious reign; but little of its glory belonged to Spain, and the emperor certainly neglected her interests in advancing those of his more favoured territories. The picture given by the Spanish historians of the state of Spain at the accession and during the reign of Philip II. fully evinces how little that kingdom had profited by the change in the line of its succession. Agriculture was neglected; commerce was fettered by enormous duties, and the people were held in the chains of ignorance and superstition.

173
Accession
of the
House of
Bourbon.
An. 1722.

Charles II. was succeeded by Philip V. duke of Anjou, and grandson to Louis XIV. of France, who had been nominated heir to the Spanish throne by the late monarch. The transactions of the war which was soon declared against France and Spain, by England, Holland, and the empire, assisted by Savoy, Portugal, and Prussia, have been already related under the article BRITAIN, from N^o 345 to N^o 371. The treaty of Utrecht, which terminated the differences between the principal contending powers, was signed in 1713, and in 1715 a permanent peace was concluded between Spain and Portugal. Hostilities, however, still continued with Savoy and Sardinia, and in 1715 the island of Sardinia was taken by a Spanish fleet, and the year following another fleet belonging to the same nation invaded Sicily, but was defeated by the British admiral Byng. By a new treaty in 1720, Sardinia was given to the duke of Savoy, and Sicily to the emperor; and by the treaty of Seville, concluded in 1729, the duchies of Tuscany, Parma, and Placentia, were ceded to Spain. In 1731, the Spanish king invaded Naples, took possession of that kingdom, and conferred it on his son Don Carlos, in consequence of which war was declared between Spain and the empire in 1733. At the end of that year the palace of Madrid was consumed by fire, and all the archives relating to the Indies perished in the flames.

In 1739, hostilities were renewed between Spain and Britain, (see BRITAIN, N^o 423); but the only successes acquired by the latter power were the capture of Porto Bello by Admiral Vernon, and that of the Manilla galeon by Commodore Anson. After a long and turbulent reign, Philip V. died in 1746.

174
Ferdinand
VI.
An. 1746.

Ferdinand VI., a mild, prudent, and beneficent prince, reformed abuses in the administration of justice, and management of the finances. He revived commerce, established manufactures, and promoted the prosperity of his kingdom. In April A. D. 1755, Quilo in South America was destroyed by an earthquake.

175
Charles III.
An. 1759.

Charles III. succeeded Ferdinand in 1759. The famous family compact was concluded at Versailles, A. D. 1761, among the four kings of the house of Bourbon. The English, alarmed by the naval preparations of Spain, declared war in 1762 (see BRITAIN, N^o 435), and took

Havannah in the island of Cuba, and Manilla in the East Indies. Notwithstanding this success, peace was hastily concluded at Fountainebleau, in November, by which the Havannah was restored. In 1767 the Jesuits were expelled from Spain. An unsuccessful expedition was concerted against Algiers, A. D. 1775, the particulars of which are related in M. Swinburne's Travels, letter v. In the war between Great Britain and her American colonies, Spain, by the intrigues of the French court, was prevailed on to take up arms in support of the latter. At the conclusion of that calamitous war, Great Britain in a treaty with Spain, ceded to this power, East and West Florida, and the island of Minorca. Charles died in 1788, and was succeeded by his second son Charles Anthony prince of Asturias, the eldest having been declared incapable of inheriting the crown.

Spain.

Charles IV. had not long been seated on the throne before the portentous revolution in France involved Europe in a general scene of political and military contest. The king of Spain joined the general confederacy against the new republic, and in consequence was numbered among the objects of its resentment, by a declaration of war in 1792. The military operations of Spain, however, were extremely languid; and after two campaigns, in which the might be said to carry on rather a defensive than offensive war, against the republican armies (see FRANCE, N^o 411), he was compelled to conclude a treaty of peace, which was signed at Basle on the 22d July 1795. By this treaty the French republic restored to the king of Spain all the conquests which she had made from him since the commencement of hostilities, and received in exchange all right and property in the Spanish part of St Domingo.

176
Charles IV.
An. 1788.

177
Engages in
the contest
against
France
An. 1795.

This treaty was soon followed by a rupture with Great Britain. On 31st October 1796, the court of Spain published a manifesto against this country, to which the court of London made a spirited reply; and about the same time was published a treaty of offensive and defensive alliance, which had been concluded about two months before, between the king of Spain and the French republic. In the war which followed between Spain and Great Britain, his Catholic majesty could boast of but little honour or success; and the French republic gained little from its new ally, but the contributions of money, which she from time to time compelled him to advance. On the 12th of February 1797, a Spanish fleet of 27 sail of the line was defeated by Sir John Jervis off Cape St Vincent (see FRANCE, N^o 482); and four of the Spanish line of battle ships were left in the hands of the victors. From this time till the temporary termination of hostilities by the peace of Amiens in 1802, there is nothing remarkable in the transactions of Spain.

178
War be-
tween Spain
and Britain.
An. 1796.

An. 1797.

On the renewal of the war in 1803, Spain was again compelled, by the overbearing power of France, to take an active part against Great Britain, and fitted out a formidable fleet, which was united to a considerable naval force of the new-made emperor of the French. The Spanish declaration of war against Britain is dated at Madrid on the 12th of December 1804; and on the 21st of October 1805, the combined fleets of France and Spain were nearly annihilated by Lord Nelson's decisive victory off Cape Trafalgar.

An. 1803.

An. 1805.

After this terrible blow to the naval power of Spain, nothing

Spain. nothing of importance took place till 1808, when the designs of Bonaparte against the independence of Spain, which had been long suspected, were openly avowed, in consequence of a domestic dispute, probably fomented by the emilleries of France, which took place between Charles IV. and the prince of Asturias. During the winter of 1807-8 the public mind in Spain had been greatly agitated. Some accused the prince of the Peace, Don Manuel Godoy, (who had long held the helm of state, and was the richest and most powerful subject in the kingdom), of having concerted with the queen to destroy the prince of Asturias. Others accused the prince of Asturias of being at the head of a party to dethrone his father. Solemn councils and long proceedings, followed up by exiles and violent acts, far from calming opinions, served to agitate them still more.

In March 1808, several disturbances happened at Aranjuez. These disturbances were excited by a report that the royal family were about to quit Spain and emigrate to America. In consequence of this report, the populace of the neighbouring villages repaired in crowds to Aranjuez, where they found the attendants of the court packing up the baggage of the royal household; and understood that relays of horses were stationed on the road to Seville, and that every thing was prepared for the departure of the royal fugitives, who were to take shipping at that port. It was suspected that Don Manuel Godoy, or, as he has commonly been called, the prince of the Peace, was the chief instigator of this unpopular measure; and the fury of the people was directed chiefly against that nobleman, whose palace they attacked on the 18th of March. He, however, found means to escape for the present, but was afterwards arrested in a garret of his own house. In the mean time the king issued two decrees with a view to allay the popular ferment; but as this still continued, he on the 19th took the extraordinary resolution of abdicating the throne in favour of the prince of Asturias. This resolution was made known by a royal decree, in which Charles declared that, as his natural infirmities no longer permitted him to support the weight of government, and the re-establishment of his health required a change of climate, he had after the most mature deliberation resolved to abdicate his crown in favour of his heir the prince of Asturias; and this resolution he declared to be the result of his own free will.

The new sovereign was accordingly proclaimed by the title of Ferdinand VII. and issued an edict confiscating the effects of Don Manuel Godoy, and announcing the appointment of the duke of Infantado, a nobleman deservedly popular for his talents and virtues, to the presidency of Castile and the command of the royal guards.

These disturbances have commonly been attributed to the machinations of the French emperor, who had gained a complete ascendancy over the weak Charles; and had rendered the prince of the Peace entirely subservient to the views which he had formed on the independence and the liberties of Spain. How far this supposition is correct, it is impossible for us at this time to determine; but it is rendered probable by the active measures taken about this time by Napoleon to awe by a French force the Spanish nation. Murat the grand duke of Berg was at this time on his march towards the capital with a body of French troops; and his march

was hastened by the information which he had received of the tumults at Aranjuez. This general caused it to be intimated to Ferdinand, that the emperor of the French was on his journey to Spain, and advised him to meet his master on the road. In the mean time he was tampering with the self-deposed monarch, whom he assured of the assistance of Bonaparte in reinstating him on the throne. Charles accordingly addressed a letter to Bonaparte, in which he contradicts the assertion of his decree of the 19th; and declares that his abdication was a measure of compulsion; and throws himself on the protection of that great monarch, his friend and ally, from whom alone he and his subjects can hope to derive tranquillity and happiness.

It appears to have been the design of Murat to draw out of Spain the whole of the royal family, and in this design he completely succeeded. Ferdinand set out to meet Bonaparte, accompanied by the French general Savary, and had advanced as far as Vittoria, where he was left by Savary, and where he found himself surrounded by French troops. He was compelled to remain at Vittoria, until Savary, who had proceeded to Bayonne, where Bonaparte then was, should return and intimate to him the pleasure of his master. When the general returned, he brought with him a letter from Napoleon to Ferdinand. In this letter, which is addressed to Ferdinand as prince of Asturias, and not as king of Spain, Bonaparte assured the prince, that the sole object of his journey into Spain was to make such reforms in that kingdom as would be agreeable to the public feelings. Without pretending to judge respecting the late revolution, he cautions Ferdinand against the danger to be apprehended from sovereigns permitting their subjects to take justice into their own hands. After insinuating his own power over the royal family of Spain, and advertising to the tumults that had taken place, in which some of his troops had fallen, he makes use of the following expression, "a few of my soldiers may be murdered; but the subjugation of Spain shall be the consequence of it."

Ferdinand confounded at the conduct of the French emperor, and alarmed for his own personal safety, was compelled to proceed on his journey. When he arrived at Bayonne he was received by the prince of Neuchâtel and Daroc, and was conducted to a place by no means suited to his rank or his character as ally of Bonaparte. He however dined with the emperor; but after he had retired, General Savary brought a message from his master, intimating his determination that the present royal family of Spain should give up to him all right and title to the crown of that kingdom, and that they should be succeeded by a branch of his own family. Astonished at this intimation, Ferdinand sent his prime minister Cevallos, to canvass the matter with M. Champagny, the confidential secretary of Napoleon. The conference was held in an apartment adjoining the cabinet of the emperor, and, as it appeared, within his hearing: for when Cevallos was arguing with great warmth and strength of reasoning on the injustice and even impolicy of the proposed measures, both he and Champagny were ordered into the emperor's presence; and the former was reviled in the grossest terms, branded with the appellation of a traitor, accused of having maintained that the recognition of Bonaparte was not necessary to the validity of his master's title to the throne of Spain, and of

524. having affirmed that if the French dared to attack the independence of the Spanish monarchy, three hundred thousand men would rise to defend it and repel the invaders. After Napoleon had thus indulged the violence of his temper, he entered in a harsh and arrogant style on a discussion of the points in dispute between his secretary and Cevallos; and finding that he could neither convince nor silence the Spanish minister, he abruptly concluded with the following peremptory declaration: "I have a system of policy of my own; you ought to adopt more liberal ideas, to be less susceptible on the point of honour, and not sacrifice the prosperity of Spain to the interest of the House of Bourbon." From this time the destiny of the Spanish royal family was fixed. Ferdinand the monarch of the people's choice was already a captive, and not many days elapsed before the rest of the royal family was in the same situation. On the first of May, Ferdinand had made a conditional renunciation of his crown in favour of his father, and on the fifth of the same month Bonaparte had a long conversation with Charles the fourth and his queen. Ferdinand was called in by his father, to hear, in the presence of him and the queen, the disgusting and humiliating expressions which were uttered by the French emperor, expressions of such a nature, that Cevallos says he dares not record them. All the parties were seated except Ferdinand; he was ordered by his father to make an absolute renunciation of the crown, on pain of being treated as an usurper and a conspirator against the right of his parents. With this requisition Ferdinand complied, and thus completed the abdication of his family; for it appeared that on the preceding day Charles had executed the deed of resignation, which transferred to the emperor of the French his title to the crown of Spain, on consideration of receiving during his life an annuity of eighty millions of reals, of a dowry to his queen of two millions of reals, and to the infants of Spain the annual sum of four hundred thousand livres.

Thus had Bonaparte effected the transference of the Spanish nation from the Bourbon dynasty to his own family, as far at least as that transference could be effected by the formal renunciation in his favour of the royal family, and by a strong but suspicious recommendation from them to the Spanish nation to receive their new sovereign, whoever he should be, with submission and obedience. Filled as the annals of mankind are with examples of treachery, perfidy, and violence, it would be difficult to point out a deed which in every part of its performance, in its own nature, or in the character of the means by which it was effected, bears such strong marks of unjust and lawless tyranny.

It was soon understood that Napoleon designed the crown of Spain for his brother Joseph, who had some time before been placed on the throne of Naples. In an address to the Spanish nation, which Bonaparte published immediately after the abdication of Charles and Ferdinand, he informed them that he did not mean to reign over them in person, but that he would give them a sovereign every way resembling himself. In the beginning of June Joseph Bonaparte arrived in the neighbourhood of Bayona, where he was received by a deputation of the grandees of Spain and from the council of Castile, and presented with a congratulatory address, written in the most fulsome style of adulation, on his accession to the Spanish throne.

Spain. 182
Opposed by a general insurrection of the Spaniards.

But though the nomination of Joseph Bonaparte was easily effected, it was not so easy to place him on the throne in opposition to the almost unanimous will of the Spanish nation. Ferdinand the seventh was the darling of the people; and his accession to the crown had been hailed by them, both as placing them under the dominion of a beloved monarch, and as releasing them from the tyranny of Godoy, who was an object of almost universal detestation. They had hitherto submitted with patience to the influence and power of France, hopeless of rescuing themselves while Charles possessed the throne, and while the prince of the Peace directed his councils; but the accession of Ferdinand, and the consequent disgrace of the favourite, had led them to hope that they should now find a sovereign willing to direct and assist their efforts to regain their independence. Under these expectations, a great part of the nation had come forward to offer their assistance in supporting the claims of the new monarch. The province of Catalonia, the most industrious and the most warlike of the Spanish nation, particularly distinguished itself by the promptitude and extent of its offers. Soon after Ferdinand had ascended the throne, the captain-general of Catalonia, relying on the well known resources and dispositions of the inhabitants, had come forward with an offer of a military force of above a hundred thousand men; and other provinces would have followed this example, but Ferdinand had discouraged these military preparations, and appeared willing to submit quietly to French bondage.

The spirit which had animated the Spaniards thus boldly to support their favourite sovereign, was not of a nature to be chilled and repressed by his timidity or example. The hatred which they had conceived against the French daily found fresh sources of nourishment. They saw Ferdinand, who had rejected their proffered services lest he should expose himself to the suspicion or displeasure of Bonaparte, enticed by deceit, or compelled by violence, to relinquish his kingdom and commit himself to the power of his enemy. They anticipated the consequences, and prepared to resist them with vigour and unanimity. The renunciation of the royal family in favour of Bonaparte was no sooner known in Spain, than the northern provinces burst into open insurrection. Asturias and Galicia set the glorious example; and it was soon followed by almost every part of Spain, not immediately occupied or overawed by the armies of France.

One of the first steps taken by the leaders of the insurrection was, to assemble the juntas or general assemblies of the provinces. When these were organized, they issued proclamations, calling on the Spaniards to rise in defence of their sovereign, and in the assertion of their own independence. Besides these proclamations from the provincial juntas, addresses were published in almost every province by the leaders of the popular cause; in particular, the province of Aragon was addressed by Palafox, a name celebrated in the annals of the Spanish revolution, in a bold and spirited manifesto. The junta of Seville, which assembled on the 27th of May, formed itself into a supreme junta of government, caused Ferdinand to be proclaimed king of Spain, took possession of the military stores, and issued an order for all males from 16 to 45, who had not children, to enrol themselves in the national armies.

It was natural that, when entering on so determined an

153
Peace and
alliance
with Bri-
tain.

an opposition to the measures of Bonaparte, the Spaniards should turn their eyes towards that nation, by whom alone the ambitious views of that potentate had been successfully combated. A peace and alliance with Britain was evidently not only a measure of policy, but would afford them the most effectual assistance in the formidable struggle in which they were about to engage. Accordingly, deputies were dispatched to Great Britain from several of the provinces, to solicit the aid and friendship of that country, and to concert measures with the British ministry for executing the plans which had been contrived for freeing the kingdom from the French yoke. The junta of Seville issued a declaration of war with France, and declared the Spanish nation on terms of peace and amity with Britain. The Spanish deputies were empowered to solicit supplies of arms, ammunition, clothing and money; but it was thought that a supply of British troops would be unnecessary, the Spanish patriots considering themselves as fully equal to the defence of their country. The cause of the Spanish patriots was eagerly embraced by the court of London, and by the British nation at large, and the most active measures were quickly taken to lend them effectual aid.

154
Statement
of the
French and
Spanish
forces.

While these preparations were making on the part of the Spaniards, the French forces were collecting in great numbers, both on the frontiers, and in the neighbourhood of the capital. Above 250,000 men, under the command of Belieres and Lasloes, threatened the provinces of Asturias and Biscay, or occupied the plains of Castile. Ten thousand men were shut up in the citadel of Barcelona; and to relieve them, a strong body of French troops had marched from the frontiers, and laid siege to Zaragoza. A considerable body under General Monecy attacked the city of Valencia; while the grand duke of Berg, after having detached General Dupont at the head of 20,000 men, to quiet the insurrection of the southern provinces, held Madrid with about 15,000 troops. Junot, with about 25,000 men, had entered Portugal, and taken possession of the capital. The whole French force at this time in Spain cannot be computed at less than 100,000 men. They were opposed by a very numerous, but undisciplined force, commanded by generals of acknowledged bravery, but differing widely from each other in experience and military prudence. General Palafox commanded in Aragon; General Castanos in the southern provinces; and General Blake in the north.

156
Successes
of the Spa-
nish pa-
triot.

The first exertions of the Spanish patriots were eminently successful, though they have been greatly exaggerated in the newspapers published under authority of the juntas. The harbour of Cadiz, which contained a numerous and well-appointed fleet, was under the command of the marquis de Solano, a man notoriously attached to the French interest; and here lay a French fleet, consisting of five ships of the line and a frigate. One of the first efforts of the patriots was, to obtain possession both of Cadiz and the French fleet, and in this they completely succeeded. Solano was arrested and put to death, and Don Morla was appointed in his room. In the beginning of June the French fleet was summoned to surrender, and on the admiral's refusal, was furiously attacked by the batteries on shore, and obliged to capitulate. The force detached by Murat, under Dupont, was attacked near Baylen, on the 22d July, by Major-general Reding, second in command under Castanos, and after having been defeat-

Spain

ed, was compelled to surrender at discretion. The French force besieging Zaragoza, was repeatedly attacked by General Palafox, and suffered considerable losses, while that city held out with the most heroic bravery. Perhaps there are few instances in the annals of modern warfare, in which such persevering and successful courage has been displayed, as by the defenders of Zaragoza. All the means of attack which were in possession of the French, directed by the skill with which their long experience and success had supplied them, were made use of. The inhabitants were obliged continually to be upon their guard, and to be prepared to refill the most unexpected and secret, as well as the most open and violent assaults. The city was frequently bombard- ed in the middle of the night, at the same time that the gates were attempted to be forced, under cover of the shells. More than once the French got into some parts of the town; but they were received with so much coolness and bravery, that they were never able to preserve what they had with so much difficulty and loss acquired. The women vied with their husbands, sons, and brothers, in the display of patriotism and contempt of danger: regardless of the fire of the enemy, they rushed into the very middle of the battle, administering support and refreshment to the exhausted and wounded, and animating, by their exhortations and example, all ranks to such a display of firmness and bravery. long secured this important city. When it is recollected, that the attacks of the French were numerous and varied, that they were constantly repeated with fresh, and generally with increasing forces, and that the sole defence of the city rested with its spirited inhabitants and the army of Palafox; some idea may be formed of the difficulties they must have undergone and surmounted, and of the glory to which they are so justly entitled. The patriots had gained possession of most of the sea ports in the bay of Biscay, and headed by the bishop of St. Andero, repulsed the French in several attacks. The French force under General Monecy was also repulsed before Valencia, and the patriots were equally successful in several other quarters; so that by the end of July there did not remain above 40,000 French forces within the Spanish territory.

156
Arrival and
flight of
Joseph Bon-
aparte.

In the meantime preparations were making at Madrid for the reception of the new sovereign Joseph; and Murat, under pretence of ill health, quitted the capital, to give way to the brother of his master. Joseph Bonaparte arrived at Madrid in the latter end of July, with a guard of 10,000 men; but soon after his arrival the news of the defeat and capitulation of Dupont reached Madrid, and threw the new court into the utmost consternation. They understood that the victorious army of Castanos was on its march towards the capital; and if he did not speedily retire from so dangerous a position, King Joseph dreaded either falling into the hands of the conqueror of Dupont, or of being intercepted in his retreat by the army of General Blake. In this situation he found himself under the necessity of quitting the capital which he had so lately entered, and before the end of the month he had reached Burgos in his precipitate flight towards the frontiers. Thus, within the space of two months, did the people of Spain behold their country almost entirely freed from the presence of the French; and this glorious and happy issue had been brought about by their own intrepidity. At a time when their situation was the most dispiriting and de-

Spain born; when their king had been compelled to forsake them, and to make over his right to the throne to a foreign potentate; when they beheld scarcely any troops surrounding them on all sides, but those of that potentate, they rose in arms, and opposed themselves, unskilled as they were in war, and totally unprepared for it, to a man before whom the mightiest empires in Europe had fallen.

177
Reveries. The success of the Spanish arms, though brilliant and important, were but transient. The leaders of the insurrection appear to have been but ill calculated to oppose the system of tactics which had been so often practised with success by the conqueror of Marengo, of Jena, and of Austerlitz. Though the conquests of Austria and Prussia had been effected by the same system which the French were now pursuing in Spain, the military men of this kingdom were incapable of analyzing them, or of adopting effectual measures of opposition or defence. In a series of about 30 bulletins, published from the French army of Spain, comprehending from the beginning of November 1808 to the middle of January 1809, we read of nothing but the rapid movements and successes of the French, and the defeat and annihilation of the best appointed armies of the insurgents. In Galicia, General Blake, after having withstood the duke of Dantzick (Marshal Ney), in several encounters, was at length defeated, and his army dispersed. A division of the army of Estremadura, under Count Belvidier, which had marched from Madrid to support the city of Burgos, was attacked and defeated by a division of the French army under the dukes of Tilly and Dalmatia; while the army of General Caisanos was in a great measure dispersed, after a severe conflict on the heights of Tudela. According to the French account, the army of Caisanos consisted of 45,000 men. It was opposed by the duke of Montebello, and entirely defeated, with the loss of nearly 4000 killed, and 5000 taken prisoners.

In the meantime Bonaparte had entered Spain, and taken the command of the French army. He advanced by rapid marches towards Madrid, and at the end of November his advanced guard reached the important pass of Somosierra. This pass was defended by a body of 13,000 Spaniards, with sixteen pieces of cannon. They were attacked by the French under the duke of Belluno, and after making a considerable stand, were entirely defeated. On the 2d of December Bonaparte arrived in the neighbourhood of Madrid, and on the 5th he was master of that capital.

178
A full exhibition in support of the Spanish patriots. While the Spanish patriots were thus pursuing their plan of opposition to French tyranny with various success, the British cabinet were fitting out formidable expeditions to the coasts of Spain and Portugal. The result of the expedition under Sir Harry Burrard and Sir Arthur Wellesley, the battle of Vimera, the convention of Cintra, and the consequent evacuation of Portugal by the French, in the month of August 1808, have been already noticed under Portugal, N^o 49 and 50. After these transactions, the greater part of the British army under the command of Lieutenant-general Sir John Moore, proceeded on their march to the frontiers of Spain. The progress and operations of this army will be detailed mentioned. About the middle of the same month, a body of 13,000 British troops, under the command of Sir David Baird, arrived at Corunna,

Spain, and proceeded through the interior of the country, intending to join Sir John Moore in the neighbourhood of Madrid. A brigade of 10,000 men under General Hope, reached that capital, and established themselves at the Escurial; but on the approach of Bonaparte, were under the necessity of retreating.

189
Sir John Moore to Sahagun. Experience has shown that in their military campaigns on the continent, British forces have to contend with numerous difficulties, surmountable only by the utmost prudence and vigilance on the part of the commanding officers, and by a considerable degree of skill and foresight on that of the projectors of such undertakings. Never perhaps were these difficulties more severely felt than in the march of Sir John Moore from Portugal to the centre of the Spanish territory. It was found that in whatever direction he might prosecute his march, he would encounter either bad roads or scanty supplies of provisions. In particular, the difficulty of transporting the artillery over the Portuguese mountains was extreme; and the Portuguese at Lisbon were either egregiously ignorant of the state of the roads which led through their own country to the Spanish frontiers, or were unwilling to communicate the information which they really possessed. Under these circumstances it was found necessary to divide the British army; and it was determined to send forward one division consisting of 6000 men under the command of Lieutenant-General Hope, which was directed to march by Elvas, to enter Spain by Badajoz, and to proceed along the Madrid road by way of Espinar. Another division, consisting of two brigades under General Paget, was detached by way of Elvas and Alcantara, where it was to pass the Tagus. Two brigades under General Beresford moved through Portugal by way of Coimbra and Almeida towards Salamanca, while three brigades under General Frazer marched towards the frontiers of Spain by Abrantes and Almeida.

Burgos had been recommended by the Spanish government as the point of union for the British troops, and Madrid and Valladolid were appointed for magazines. The British had been led to expect that they would find between 60,000 and 70,000 Spaniards assembled under General Blake and the marquis de la Romana in the provinces of Asturias and Galicia, and that a much greater number was ready to co-operate with them under the command of Caisanos on the front and left of the principal French position. The Spaniards had been represented as unanimous in their enthusiasm for the cause of liberty, and as ready to treat the British troops as the saviours of their country. How far this information was correct, will be seen presently.

In marching through the Portuguese territory, the troops first encountered difficulties which they were not prepared to expect. The contractor at Lisbon, who had agreed to supply the divisions with rations on the march, failed in his contract, and excessive inconvenience was experienced from the want of money. The divisions under Generals Frazer and Beresford were obliged to halt, and it was some time before they could again set forward. The proceedings of the central junta, on which all the movements both of the British and Spanish armies chiefly depended, were languid, tardy, and irresolute; and before the British troops could assemble in any force in Spain, the principal armies of the patriots had been defeated and dispersed in almost every

every quarter. On the 8th of November Sir John Moore reached Almeyda. The weather was at this time extremely unfavourable, and the troops were exposed to almost incessant rain. They entered Spain on the 11th of November, and on the 13th Sir John arrived with his advanced guard at Salamanca, where he halted, intending to assemble there all the troops which were on their march through Portugal. While he remained at Salamanca, he was informed that a considerable French force had advanced and taken possession of Valladolid, at the distance of only twenty leagues, by which one of the places that had been intended for magazines was lost. At this time Sir John had with him only three brigades of infantry without artillery, and it would be at least ten days before the whole of the divisions could come up. He was thus exposed to almost an immediate attack by the French without any effectual support from the boasted patriotism of the Spaniards.

The situation of affairs in Spain had now become extremely critical; and every account sent to Sir John Moore by men of sound judgement, was filled with convincing proofs that the Spanish government had concealed from their ally the very desperate state of their affairs. General Hope, by a long and tiresome march, had reached the neighbourhood of Madrid, whence he wrote a letter to Sir John, stating that every branch was affected by the disjointed and inefficient construction of the government. On the 28th of November Sir John was adverted of the late defeat and dispersion of Castanos, and of the little probability there was of his being able to march forward, so as to effect any thing of advantage. He therefore determined to fall back, though this determination was evidently in opposition to the wishes and advice of his officers. Fresh dispatches, however, from the seat of government, diminishing the losses which had been sustained by the patriots, and exaggerating the ardour with which the people were actuated, induced him to delay his retreat, especially as he had now a complete, though small corps, with cavalry and artillery, and could, by a movement to the left, easily effect a junction with Sir David Baird, while the division under General Hope had, by rapid marches, arrived in the neighbourhood of Salamanca.

In addition to the misrepresentations by which the commanders of the British forces, and the British envoy at Aranjuez, had been deceived, they had now to contend with two designing men, who, it soon appeared, were in the French interest. These were Don Morla, the late governor of Cadiz, and a M. Charmilly. By the machinations of these men, Mr Frere was led to advise, and Sir John Moore strongly incited to undertake, bringing the whole of the British force to the neighbourhood of Madrid, where they would soon have been completely within the power of the enemy. Though by these arts Sir John was effectually misled, he did not suffer himself to be drawn into so dangerous a snare. He, however, advanced beyond Salamanca, and sent forward the reserve and General Beresford's brigade towards Toro on the Duero, where they were to unite with the cavalry under Lord Paget, who had advanced thither from Astorga. On December 12th, Lord Paget, with the principal part of the cavalry, marched from Toro to Fordellias, while the brigade under General Stewart moved from Arivolo. In the vicinity of Fordellias,

near the village of Rueda, the British forces were first opposed by the French, a small party of whom were attacked and defeated.

While Sir John Moore was at Toro, he received intelligence that the duke of Dalmatia was at Saldana with a considerable body of French troops, that Junot, duke of Abrantes, was marching with another towards Burgos, and that a third under the duke of Treviso was detained for Zaragoza. He was very desirous that the first of these generals should advance to meet him, and with this view he had come forward to Toro, which he reached on the 16th of December. He had hoped for effectual assistance from the corps commanded by the marquis de la Romana, but he soon found that this general could render him no support. He had now resolved to threaten the communication between France and Madrid; and, if a favourable opportunity offered, to attack the duke of Dalmatia's corps, or any of the covering divisions that should present themselves. He foresaw that this would necessarily draw upon him a large French force, and of course would prove an important diversion in favour of the Spaniards; who would by this means have the opportunity of collecting in the south, and restoring their affairs. The army was now near the French position. The cavalry under Lord Paget were pushed forward, that their patrol reached as far as Valladolid, and had frequent successful skirmishes with the enemy. Colonel Ostry met a detachment of French cavalry, charged them, and made the whole prisoners.

On the 18th of December, Sir John's head-quarters were at Castro Nuevo, and Sir David Baird's at Benavente, on the road to join him. On the 20th Sir John reached Majorca, where he was joined by Sir David Baird. The united British army now amounted to rather fewer than 26,000 men, of whom about 2000 were cavalry. The weather was extremely cold, and the ground covered with deep snow. Still the exertions of the troops were indefatigable, and the cavalry in particular attacked and defeated a considerable body of French horse. On the 21st the army reached Sabagan, where Sir John established his head-quarters, and determined to halt for some time, to refresh his troops, after the fatigues which they had undergone.

Sir John had now arrived within a very short distance from Saldana, where the duke of Dalmatia was posted, with the flower of the French army; and preparations were made for an attack, which was waited for with all the ardour and impatience which distinguish British troops. In the mean time, however, repeated couriers arrived at head-quarters, the bearings of unpleasant intelligence. Certain information was received, that a strong French reinforcement had arrived at Carrion, a little to the right of Sabagan, that the French corps, which was marching to the south, had halted at Lalava, and that the enemy were advancing from Madrid in considerable force. Sir John now saw that his motions had been watched by Bonaparte, and that all the arts of this experienced general had been preparing to entrap him. To advance was inadvisable; to retreat, almost in the face of an enemy, was a measure of the utmost danger, but it was the only alternative.

On the 24th of December Sir John began silently to retreat, and secretly to prepare for his retreat, so as to pass, as far as possible, for the defence of those parts of the

Spain.

country which were still held by the patriots. With this latter view, he directed Sir David Baird to take the route towards Valencia de Don Juan, while the rest of the army was to proceed by Castro Gonzalo. By this division the magazines and stores which had been deposited at Benevente and Zamora, were also effectually secured.

According to the arrangement made, General Frazer, followed by General Hope, marched with their divisions on the 24th December to Valderos and Majorga, and Sir David Baird proceeded with his to Valencia. To conceal this movement, Lord Paget was ordered to push on strong patrols of cavalry close to the advanced posts of the enemy. The reserve, with two light corps, did not retire from Sahagun till the morning of the 25th, following General Hope. Lord Paget was ordered to remain with the cavalry until evening, and then follow the reserve. These last were accompanied by Sir John. The retreat commenced in this deliberate manner. On the 26th of December, Sir David Baird reached the Eilar, and passed the ferry with less difficulty than was expected. He took post, according to his orders, at Valencia, and wrote to the marquis of Romana, urging him to blow up the bridge of Manilla. The other divisions of infantry proceeded unmolested to Castro Gonzalo. On the 24th the advanced guard of Bonaparte's army marched from Tordeillas, 120 miles from Madrid, and strong detachments of cavalry had been pushed forward to Villalpando and Majorga. On the 26th, Lord Paget fell in with one of those detachments at the latter place. His lordship immediately ordered Colonel Leigh, with two squadrons of the 10th hussars, to attack this corps, which had halted on the summit of a steep hill. One of Colonel Leigh's squadrons was kept in reserve; the other rode briskly up the hill; on approaching the top, where the ground was rugged, the colonel judiciously reined-in to refresh the horses, though exposed to a severe fire from the enemy. When he had nearly gained the summit, and the horses had recovered their breath, he charged boldly and overthrew the enemy; many of whom were killed and wounded, and above 100 surrendered prisoners. Nothing could exceed the coolness and gallantry displayed by the British cavalry on this occasion. The 18th dragoons had signaled themselves in several former skirmishes; they were successful in six different attacks. Captain Jones, when at Palencia, had even ventured to charge 100 French dragoons with only 30 British; 14 of the enemy were killed, and six taken prisoners. The cavalry, the horse-artillery, and a light corps, remained on the night of the 26th, at Castro Gonzalo; and the divisions under Generals Hope and Frazer marched to Benevente. On the 27th, the rear guard crossed the Eilar, and followed the same route, after completely blowing up the bridge.

We shall not attempt any farther detail of this dangerous and calamitous retreat, in which our army suffered extremely, from the fatigues of constant marching, from the badness of the weather, and even from the brutality of the Spaniards, in whose cause they had embarked. Before they reached Astorga, it was found necessary to divide the army. A body of 3000 men, under Brigadier-general Crawford, was detached on the road to Orense towards Vigo, while the main

body, under the command of Sir John Moore, marched by Astorga and Lugo, on the road to Corunna. They left Astorga on the 30th of December, and on the 11th of January came in sight of Corunna. The army had now reached the sea port from which they were to embark, but adverse winds had detained the transports, or the whole of the troops would have been speedily and safely on board. Only a few ships lay in the harbour, and in these some sick men and a few stragglers, under pretence of sickness, had immediately embarked.

During the whole march from Sahagun to Corunna, the British army was closely followed by the French, under Bonaparte and the duke of Dalmatia; and the two armies were often so near each other, that the French patrols fell in, during the night, with the cavalry piquets of the British. The duke of Dalmatia had joined Bonaparte at Astorga, and had increased his force to nearly 70,000 men, while the whole force of the British did not exceed 26,000. When Sir John's army reached Lugo, it was found that three divisions of the French were arranged in front, and it was thought advisable, on the 8th of January, to offer the enemy battle. This offer, however, the French thought proper to decline, and the duke of Dalmatia stirred not from his post. When the army reached Corunna, the French were far in the rear, and it was hoped that the transports might arrive before the enemy could come up.

The retreat of the British, considering the circumstances under which it was effected, was a brilliant and successful achievement. Two hundred and fifty miles of country had been traversed in 11 days, during the worst season of the year, through bad roads, over mountains, defiles, and rivers, and in almost daily contact with an enemy nearly three times their numbers. Though often engaged, the rear guard of the British had never been beaten, nor even thrown into confusion. Many losses had indeed been sustained, in baggage, artillery, and horses, and many stragglers had fallen into the hands of the enemy; but neither Napoleon nor the duke of Dalmatia could boast of a single military trophy taken from the retreating army. The greatest danger was still to be incurred; the position of Corunna was found to be extremely unfavourable; the transports had not arrived, and the enemy began to appear upon the heights. The situation of the army was by most of the officers thought so desperate, that they advised the general to propose terms to the duke of Dalmatia, that they might be suffered to embark unmolested; but this advice Sir John, without hesitation, rejected.

On the 12th of January, the French were seen moving in considerable force on the opposite side of the river Mero. They took up a position near the village of Perillo, on the left flank of the British, and occupied the houses along the river. In the mean time Sir John was incessantly occupied in preparing for the defence of his post, and in making every arrangement for the embarkation of the troops.

On the 13th, Sir David Baird marched out of Corunna with his division, and took post on a rising ground, where he determined to remain all night. A division under General Hope was sent to occupy a hill on the left, which commanded the road to Becanzos, forming a semicircle with Sir David Baird's division on the right. General Frazer's division was drawn up near the road to Vigo, about half a mile from Corunna, and communicated

Spain.

An. 1809.

To 1
Closely fol-
lowed by
the French.To 2
Position of
the army.

communicated with that under Sir David Baird, by means of the rifle corps attached to the latter, which formed a chain across the valley. The reserve under Major-general Paget occupied a village on the Betanzos road, about half a mile from the rear of General Hope. The higher grounds on the rear and flanks of the British were possessed by the French, a situation which gave the latter a considerable advantage.

In the evening the transports from Vigo hove in sight; but the enemy was now so near, and had, during this day, shown so much disposition to molest the British, that a general action was become inevitable. On the 13th, the enemy had advanced to a height where, the day before, a magazine, containing nearly 4000 barrels of gun powder, had been blown up, and which was immediately opposite to the position of the British. On this day some skirmishes took place.

On the 16th, every thing was prepared for a general action. Most of the artillery had been embarked, as it was found that, from the nature of the ground, much artillery could not be employed with advantage. During the 13th and 14th, the sick, the dismounted cavalry and horses, were also nearly all embarked. On the morning of the 16th, the French on the hills were apparently quiet, and it was hoped that the embarkation might be effected in the course of that night; but about noon the enemy, who had in the morning received reinforcements, and had placed some guns in front of the right and left of his line, was observed to be getting under arms, to be moving troops towards his left flank, and forming various columns of attack at that extremity of the front and commanding position which he had taken on the 13th, in front of the British line. This indication of his intention was immediately succeeded by a rapid and determined attack on the division under Sir David Baird, which formed the right wing, and was the weakest part of the line. The first effort of the enemy was met by Sir John Moore and Sir David Baird at the head of the 42d regiment, and the brigade under Lord William Bentinck. The village on the right became an object of oblique contest. While leading on his division to support this position, Sir David had his arm shattered with a grape shot.

Not long after, while Sir John Moore was riding from post to post, everywhere encouraging his troops, and pointing out the most advantageous opportunities for attack or defence, his conspicuous situation had exposed him to the fire of the enemy. A cannon-ball struck his left shoulder, and beat him to the ground. He raised himself, and sat up with an unaltered countenance, looking intently at the Highlanders, who were warmly engaged. Captain Haddinge threw himself from his horse, and took him by the hand; then, observing his anxiety, he told him the 42d were advancing, upon which his countenance immediately brightened. His friend Colonel Graham now dismounted to assist him; and, from the composure of his features, entertained hopes that he was not even wounded: but observing the horrid laceration and effusion of blood, he rode off for surgeons. The general was carried from the field on a blanket, by a sergeant of the 42d, and some soldiers. On the way he ordered Captain Haddinge to report his wound to General Hope, who assumed the command. Many of the soldiers knew that their two chiefs were carried off: yet they conti-

nued to fight with undiminished courage; and, by the most determined bravery, not only repelled every attempt of the enemy to gain ground, but actually forced him to retire, though he had brought up fresh troops in support of those originally engaged.

The enemy finding himself foiled, in every attempt to force the right of the position, endeavoured by numbers to turn it. A judicious and well-timed movement, which was made by Major-general Paget, with the reserve, which corps had moved out of its cantonments to support the right of the army, by a vigorous attack, defeated this intention. The major-general having pushed forward the 93th (rifle corps) and 111th battalion 52d regiment, drove the enemy before him; and, in his rapid and judicious advance, threatened the left of the enemy's position. This circumstance, with the position of Lieutenant-general Frazer's division (calculated to give still farther security to the right of the line) induced the enemy to relax his efforts in that quarter. They were, however, more forcibly directed towards the centre, where they were again successfully resisted by the brigade under Major-general Manningham, forming the left of Sir David Baird's division, and a part of that under Major-general Leith, forming the right of the division under General Hope. Upon the left the enemy at first contented himself with an attack upon our picquet, which, however, in general, maintained their ground. Finding, however, his efforts unavailing on the right and centre, he seemed determined to render the attack on the left more serious, and had succeeded in obtaining possession of the village through which the great road to Madrid passes, and which was situated in front of that part of the line. From this point, however, he was soon expelled with considerable loss, by a gallant attack of some companies of the 2d battalion of the 14th regiment, under Lieutenant-colonel Nicholls. Before five in the evening, the British had not only successfully repelled every attack made upon the position, but had gained ground in almost all points, and occupied a more forward line than at the commencement of the action, whilst the enemy confined his operations to a cannonade, and the fire of his light troops, with a view to draw off his other corps. At six the firing ceased. The different brigades were reassembled on the ground which they occupied in the morning, and the picquets and advanced posts resumed their original stations.

Notwithstanding the decided and marked superiority which at this moment the gallantry of the troops had given them over an enemy, who, from his numbers and the commanding advantages of his position, no doubt expected an easy victory, General Hope did not, on reviewing all circumstances, conceive that he should be warranted in departing from what he knew was the previous and fixed determination of the late commander of the forces, to withdraw the army on the evening of the 16th, for the purpose of embarkation, the previous arrangements for which had already been made by his order, and were in fact far advanced at the commencement of the action. The troops quitted their position about 10 at night, with a degree of order that did them credit. The artillery that remained unembarked, having been withdrawn, the troops followed in the order prescribed, and marched to their respective points of embarkation in the town and neighbourhood of Corruna. The picquets remained at their posts till five in

Spain.

the morning of the 17th, when they were also withdrawn with similar order, and without the movement having been discovered by the enemy.

By the unremitting exertion of the captains of the royal navy, who had been entrusted with the service of embarking the army, and in consequence of the arrangements made by the agents for transports, the whole of the forces were embarked with an expedition which has been seldom equalled. The brigades under Major-generals Hill and Beresford were destined to remain till daylight, in order to watch the movements of the enemy. The brigade under General Beresford, which was alternately to form the rear-guard, occupied the land in front of Corunna, while that under General Hill was stationed on the promontory in the rear of the town by way of reserve.

The enemy pushed his light troops towards the town, soon after eight o'clock in the morning of the 17th, and shortly after occupied the heights of St Lucia, which commanded the harbour. But notwithstanding this circumstance, and the manifold defects of the place, there being no apprehension that the rear-guard could be forced, and the disposition of the Spaniards appearing to be good, the embarkation of Major-general Hill's brigade was commenced and completed by three in the afternoon. After having fully explained, to the satisfaction of the Spanish governor, the nature of the movement, and having made every previous arrangement, General Beresford withdrew his corps from the land in front of the town soon after dark, and was, with all the wounded that had not previously been removed, safely embarked before one o'clock of the morning of the 18th.

In this action the British troops had come off with glory, and there can be no doubt, from the repulse of the French forces, and their subsequent inactivity, that the honour of the victory belonged to the British. The victory had indeed cost them dear. They had lost one of their best generals; and probably nearly 12000 men had been killed or wounded during the action. It had been achieved at the termination of a long and harassing service. The superior numbers, and advantageous position of the enemy, not less than the actual situation of the British army, did not admit of any advantage being reaped from success. The lustre of the British arms had, however, been maintained under the most disadvantageous circumstances. The army which had entered Spain amidst the fairest prospects, had no sooner completed its junction, than owing to the multiplied disasters that dispersed the native armies around it, it was left to its own resources. The advance of the British troops from the Douro afforded the best hope, that the south of Spain might be relieved; but this generous effort to save an unfortunate people, also afforded the enemy the opportunity of directing every effort of his numerous troops, and concentrating all his principal resources for the destruction of the only regular force in the north of Spain. These circumstances had produced the necessity of rapid and harassing marches, which had diminished the numbers, exhausted the strength, and impaired the equipment of the army. Notwithstanding all these disadvantages, and those more immediately attached to a defensive position, which the imperious necessity of covering the harbour of Corunna, for a time, had rendered indispensable to assume, the native and un-

daunted valour of British troops was never more conspicuous.

At daybreak on the 18th, the English convoy was under sail, and on the 19th it had entirely left the Spanish coast.

Notwithstanding the ill success which had thus attended the expedition under Sir John Moore, the spirit of patriotism which appeared still to actuate the southern provinces of Spain, and the hope that the common cause might there be supported to greater advantage, induced the British ministry to lend another military force to the western peninsula of Europe, to co-operate with the patriots who still continued in arms. Accordingly, a body of about 15,000 forces, under the command of Sir Arthur Wellesley, whose bravery and good conduct in the battle of Vimiera, had recommended him, in a particular manner, both to the ministry and the nation, was dispatched towards the coast of Portugal, where Marshal Beresford still maintained a British force; while General Hill, with about 5000 infantry, and 400 cavalry, sailed from Ireland with the same destination. General Hill arrived at Lisbon on the 4th of April, and soon after Sir Arthur landed with the main body. On the 7th of April the army moved forward towards the Douro, and crossed that river during the night of the 11th, a little above Oporto. Here they fell in with a French detachment from the army of the duke of Dalmatia, which they routed and put to flight, after a short but well-contested action.

After this action the duke of Dalmatia found it necessary to retreat. He passed through the denes of Salamonde, and thus gained considerably on the British army, though he was obliged to leave behind him part of his artillery. On the 19th of May he was at Alaritz, and on the 20th he continued his retreat across the Miho, which he passed at Orense, thus leaving Portugal once more in possession of the British forces.

Sir Arthur Wellesley, after having remained for some time in the Portuguese territory, to refresh his men after the fatigues which they had undergone, advanced into Spain, and effected a junction with General Cuesta, who then commanded a considerable part of the remains of the patriotic army. In the latter end of July, the allied army had advanced to Talavera de la Reyna, in the neighbourhood of which they were encountered by a formidable French force, consisting of a corps commanded by Marshal Victor, another under General Sebastiani, the guards of Joseph Bonaparte, amounting to 8000 men, and the garrison of Madrid. This large force was commanded by Joseph Bonaparte in person, assisted by Marshals Jourdan and Victor, and General Sebastiani.

On the 27th of July, an attack was made by the French army on that of the allies, who had taken up their position at Talavera. The attack was vigorous, but was repelled with great spirit and success, though not without considerable loss on the part of the British.

The defeat of this attempt was followed about noon of the 28th by a general attack of the enemy's whole force, on the whole of that part of the position which was occupied by the British army. The general attack began by the march of several columns of infantry into the valley, with a view to attack the height occupied

Spain.

104
Second ex-
pedition
under Sir
Arthur
Wellesley.

195
Battle of
Talavera.

by

Spain. by Major-general Hill. These columns were immediately charged by the 1st German light dragoons, and 2d dragoons, under the command of General Anlon, and supported by General Fane's brigade of heavy artillery; and although the 2d dragoons suffered considerable loss, the charge had the effect of preventing the execution of that part of the enemy's plan. At the same time an attack was directed upon Brigadier-general Alexander Campbell's position in the centre of the combined armies, and on the right of the British. This attack was most successfully repulsed by Brigadier-general Campbell, supported by the king's regiment of Spanish cavalry, and two battalions of Spanish infantry; and the allies were left in possession of the enemy's cannon.

An attack was also made at the same time on Lieutenant-general Sherbrooke's division, which was on the left and centre of the first line of the British army. This attack was most gallantly repulsed by a charge with bayonets, by the whole division; but the brigade of guards which were on the right, having advanced too far, were expoied on their left flank to the fire of the enemy's battery, and of their retiring columns; and the division was obliged to retire towards the original position, under cover of the second line of General Cotton's brigade of cavalry, which had moved from the centre, and the 1st battalion 48th regiment. This regiment was removed from its original position on the heights, as soon as the advance of the guards was perceived, and formed in the plain; it advanced upon the enemy, and covered the formation of Lieutenant-general Sherbrooke's division. Shortly after the repulse of this general attack, in which apparently all the enemy's troops were employed, he commenced his retreat across the Alberche, which was conducted in the most regular manner, and effected during the night, leaving in the hands of the British 25 pieces of cannon, ammunition, tumbrils, and some prisoners.

Though the French were defeated in this engagement, and, according to Sir Arthur Wellesley's account, must have lost at least 10,000 men, the loss of the British was very great. By the official returns it is stated to exceed 5000, namely, in killed, 34 officers, 28 sergeants, 2 drummers, and 735 rank and file; in wounded 195 officers, 164 sergeants, 16 drummers, and 3537 rank and file; and in missing 9 officers, 15 sergeants, 9 drummers, and 620 rank and file. The action, though brilliant, does not appear to have been attended with much advantage to the allies, as, from the reinforcements which the French army was daily receiving, Sir Arthur Wellesley (now Lord Wellington) was soon compelled to fall back towards the frontiers of Portugal, leaving behind him much of his baggage, and the whole of his sick and wounded. It must be recorded to the honour of the French commander, into whose hands these unfortunate men had fallen, that, in consequence of a representation in their favour by Lord Wellington, he treated them with the utmost humanity, and afforded them every accommodation which the nature of their situation admitted.

Since the battle of Talavera, nothing of importance has transpired respecting the state of affairs in Spain. It appears that the patriots still continue to make a stand against their invaders; but it cannot be expected that their opposition will be ultimately attended with suc-

cess. The resources of the French are so numerous and extensive, and the force which he is able to draw towards the Spanish peninsula, has been so much increased in consequence of the peace lately concluded between France and Austria, that the liberties of Spain must, we fear, fall a sacrifice, and that kingdom must contribute to swell the already exorbitant power of the house of Bonaparte.

We shall conclude the historical part of this article with a summary recapitulation of the principal revolutions which have taken place in Spain. 105 Summary view of Spanish history.

From the year 245 B. C. to the year 206 B. C. Spain was in some degree under the dominion of the Carthaginians. From the year 206 B. C. to the commencement of the fifth century of the Christian era, it continued almost entirely in possession of the Romans. The Goths reigned in Spain from the year 411 to 711; the Moors from the year 711 till 716, in part of the Asturias; till 820 in Catalonia; till 750 in Sobrarba; till 923 in Leon; till 1073 in different parts of the two Castiles; till 1118 in Aragon; till 1236 in Cordova and Jaen; till 1248 in Seville; till 1264 in the kingdom of Valencia; till 1265 in that of Murcia; and even so late as 1292 in Granada. During the wars against the Moors, the Goths reigned in the Asturias, Galicia, and, finally, in the kingdom of Leon till 1035.

The house of Navarre, descended from the French house of Bigorre, which had previously reigned in Castile for 10 years, united with it the crown of Leon till the year 1126. This was succeeded by the family of Bourbon, descended from the royal family of France, which reigned over these countries till 1555. The house of Charleagne, a French family descended from that prince, ruled over Catalonia from the year 802 till 1132. The French family of Bigorre first reigned in Sobrarba, and afterwards in Aragon, from the year 750 to 1162; at that period the French family of Barcelona succeeded to the government, and united to the crown of Aragon that of Catalonia, and afterwards the kingdom of Valencia, over which it reigned till the year 1430. These parts of Spain then came into the possession of the princes of the French branch of Navarre, which reigned in Castile, and continued in their descendants to 1515; at which time the different states of the Spanish monarchy were united under the government of Joanna the Foolish, who reigned over them till her death, which happened in 1555. The Austrian family then possessed the throne till 1700, since which time it has been occupied by a branch of the house of Bourbon, till the late revolution, by placing the Spanish monarchs in the power of the French, has given rise to a new dynasty of princes in the person of Joseph Bonaparte.

The earliest Spanish antiquities which can be with certainty ascertained, belong to the Roman period; and of these the examples are extremely numerous. They abound in the provinces of Catalonia, Valencia, and those which border on the Pyrenees. We cannot here enumerate, much less describe, all the remains of Roman antiquity mentioned by Saint-Barne, Tavernier, De La Harde, and other travellers in Spain. The most remarkable are, the aqueduct at Segovia, in Old Castile, consisting of 119 arches, extending about 742 yards, and being at least 94 feet high, where it crosses the valley; the amphitheatre of the ancient *Seguntum*, near 107 Antiquities.

Spain.

the modern Morvedro in Valencia, which was hewn out of the solid rock, and appears to have been capable of containing 10,000 spectators; a superb Roman arch, supported by Corinthian pillars, and having a very lofty gateway, not far from Tarragona; a monument near the same place, supposed to be the tomb of the father and uncle of Scipio Africanus; and a considerable amphitheatre on an eminence near Seville. It is supposed that the ancient city of Italica, built by Scipio Africanus for the reception of his wounded soldiers, stood near this spot; but we are assured by Mr Swinburne, that no traces of it now remain.

Of the Gothic edifices, no certain remains are to be found; but the Moorish antiquities are numerous and splendid. Of these, the most remarkable are the palace of the Alhambra in the city of Granada, and the mosque of Cordova. Of the former we have already given an account under ALHAMBRA. The mosque, now the cathedral of Cordova, was begun by Abdoulrahman I. caliph of Cordova, and is computed to contain not fewer than 800 columns. The architecture of its doors, windows, and arches, especially those of the chapel of the Koran, at least equals that of the Alhambra in grandeur of design, and beauty of execution, and exceeds that palace in variety of decoration. This superb edifice has been minutely described by Mr Swinburne, in his travels into Spain, Letter 35. Not far from Cordova stood the magnificent city of Zehra, built by Abdoulrahman III. and which is said to have employed 25 years in building, and to have cost more than 2,500,000 l. of our present sterling money. In this city was a palace containing 1173 columns, of African, Spanish, Italian, and Asiatic marbles. This splendid palace, and the city in which it stood, were entirely destroyed during the wars by which Spain was desolated in the middle ages.

It has been computed, that under the dominion of the Romans, Spain contained a population of nearly 50,000,000 of people; but this calculation is, by De Laborde, diminished to 20,000,000.

At the close of the 14th century, the population is stated by most Spanish writers as follows.

In the states of Castile	11,000,000
States of Aragon,	7,700,000
Kingdom of Granada,	3,000,000
	<hr/>
	21,700,000

On what De Laborde deems better authority, he reduces this number to 16,000,000.

In the reign of Ferdinand and Isabella, at the end of the 15th century, the total population of Spain has generally been estimated at 20,000,000, but this too is reduced by Laborde to 14,000,000 or 15,000,000.

The population was reduced

in 1688 to	-	-	-	10,000,000
1700	-	-	-	8,000,000
1715	-	-	-	6,000,000

In 1768 it had risen to	-	-	-	9,307,800
1788	-	-	-	10,143,975

Spain.

According to the table of the provinces, collected chiefly from De Laborde, it amounted, at the end of the 18th century, to 10,308,505; by the last census, taken in the years 1797 and 1798, the statements of which have not been published, but were lately locked up in the office belonging to the minister of finance, it appears that the population, at the end of the 18th century, exceeded 12,000,000.

From these statements we observe, that the population of Spain had gradually diminished from its conquest by the Romans, to the reign of Philip V. in the beginning of the 18th century; but that during the last hundred years it has rapidly increased.

Various causes have been assigned for the remarkable depopulation that had taken place in the Spanish dominions. Perhaps the following by Dr Playfair are sufficiently plausible. "The pestilential fevers and epidemical diseases, which carried off one-third of the inhabitants in the year 1347, and have produced great mortality during the two last centuries; almost incessant struggles for dominion, from 714 till the conquest of Granada, and union of the two crowns of Castile and Aragon; the expulsion of about 400,000 Jews by Ferdinand and Isabella, and of 900,000 Moors, A. D. 1610; the discovery of South America in 1493, which has gradually drained the country of its inhabitants and its industry; the calamities of war, during two centuries, from the accession of the emperor Charles V.; the form of government, and national prejudices, which discourage foreigners from settling in the kingdom, and are inimical to manufactures, commerce, and agriculture; the debauchery that prevails among all ranks; the great number of convents; the celibacy of the clergy; religious oppression, and numerous festivals, which lessen the number of working days, and so abridge the labour of the people."

Of the number above stated, the clergy are reckoned at least 147,722: viz. of secular clergy, 60,240; of monks 49,270; of nuns and friars, 22,337, and of subaltern ministers of the church 15,875. The numbers of the clergy have indeed diminished by more than 27,000, during the last 30 years of the 18th century, as in the year 1768 they amounted to 176,057.

According to a calculation in the year 1776, the cities, towns, villages, and hamlets, amounted to 84459 (D); towns, villages, &c.

It appears that there exist in Spain 2,628,557 individuals of both sexes, who do not contribute, or at least are not supposed to contribute, to the population. From this view, and the progress we have already stated, it will be easy to discover, by comparative calculations with the detailed statements of population in other countries, the proportionate number of births, deaths, marriages, &c. which annually take place in Spain.

The Spanish government, which was of a limited nature, during the dynasties of the kings of Castile and Aragon, afterwards became an absolute monarchy. At that

(D) In the year 1788, the number of villages was estimated at 19,219; and that of parishes at 20,080.

Spain. that period the royal prerogative was confined both by the express tenor of the laws and the forms of their administration. The peculiar privileges of the two states of Castile and Aragon continued to exist long after their reunion; but the royal authority was constantly taking umbrage at their exercise. The princes of the Austrian family did not openly attack them, but had recourse to the more effectual method of secretly undermining them; and thus they were so far diminished, that at the close of the 17th century they amounted to little more than mere forms. The attachment of Aragon to the cause of the archduke Charles, induced the first sovereign of the royal family of France to abolish them entirely. Philip V. having subdued Aragon, suppressed the states-general, the last meeting having been held at Zaragoza in the year 1720, on which occasion Queen Isabella of Savoy presided in the absence of her husband, who was at that time in Italy. Since that period no further power is left the *Cortes* of Castile and Aragon, but the privilege of nominating deputies to the states-general of the kingdom, whenever they are summoned by the monarch.

The whole authority, previous to the late revolution, centred in the king and his ministers; the national affairs were conducted by the different councils, appointed by the crown, which deliberated and formed their plans in the capital. Some of these possessed both legislative and executive power, and exercised the double function of advising the king and administering justice. The council of Castile, in this distribution of power, was paramount; its decrees being decisive in the courts, but its judgements were under the controul of the king. The resolutions were transmitted to the monarch by a certain number of members, under the title of the *Chamber of Castile*, whose influence was prodigiously great. This council was so denominated, because the members chosen by the king formerly co-operated with ministers in expediting the affairs of state in the royal chamber, and for this purpose they attended the court wherever it was held.

Besides the council of Castile, there was the royal and supreme council of the Indies, invested with the same powers, and exercising similar functions with respect to the American colonies, as the council of Castile with respect to the European territory.

It is not easy to ascertain the amount of the revenues under the late government. They arose from a tax on imports and exports; from the chief objects of internal consumption; from the monopolies of the crown; from landed estates; from tythes of church and abbey lands; from the sale of indulgences; and from the trade with the American colonies. Their total amount has been variously stated. M. Jordan has computed it to exceed 7,000,000*l.* sterling; by M. De Laborde, the revenues for the European continent alone, are calculated to exceed 8,000,000*l.* sterling.

It would be absurd to attempt any estimate of the military strength of Spain in its present state of disorganization and confusion. During the latter part of the

18th century, the land forces in time of peace seldom exceeded 50,000 ill-disciplined troops; but in time of war, the army was capable of being augmented to a formidable force. In the year 1798 the standing forces of the Spanish monarchy amounted to 100,000 effective men.

Till of late the Spanish navy was highly respectable, both as to strength and discipline. In the year 1778 the Spanish fleet consisted of 148 vessels of all descriptions; and of these more than 60 were ships of the line. In 1788, the number of ships of the line amounted to 63, and that of large frigates to 47. In the present long contest among the powers of Europe, the navy of Spain has been greatly diminished; and the only fleet of any importance now existing is that in the harbour of Cadiz.

There are in Spain several orders of knighthood, or ²²¹Orders of as they are called, military orders. The principal is knighthood that of the *Golden Fleece*, instituted in the year 1430, by Duke Philip the Good. The order of St Jago di Compostella was instituted by Ferdinand II. in the year 1175, and its badge is a red uniform cross in twelve departments. The order of Calatrava, instituted by Sancho III. of Castile, has for its badge a red cross in five departments. The order of Alcantara was instituted by Ferdinand II.; and its badge is a lily placed crossways. The order of Montesa, instituted in the year 1317, by James III. king of Aragon, is composed of 19 commanderies.

The money of Spain is either real or imaginary, the former serving for the purpose of exchange, the latter for keeping accounts and transacting business. Both these are common through the whole kingdom; but several kinds of both are to be found in the different provinces.

Two kinds of real money, both in gold and silver, are distinguished in Spain; the old, that is, such as were coined before the year 1772, and those coined subsequent to that period. None of the former are uniform, but consist of small pieces of different sizes unequally cut, and their currency is only by weight. The latter uniformly bear the head of the sovereign on the obverse, and on the reverse side the arms of Spain; the ancient gold coins are more intrinsically valuable than the modern. The last only will be here described.

Modern Gold Coins.

Coins.	Value in Sterling money.
Durito	
Escudo chico de oro	} - 4s. 2d. (E)
Veniento de oro	
Escudo de oro	} - 8s. 4d.
Doblon fenzillo	
Doblon de oro	} - 16s. 8d.
Doblon de quatre	
Medio doblon de a ocho	} 1 <i>l.</i> 13s. 4d.
Media onza de oro	
Doblon de ocho	} - 3 <i>l.</i> 6s. 8d.
Onza de oro	

Modern

(E) In computing the value of the Spanish coins in sterling money, we have employed M. De Laborde's tables, in which their value is estimated in money tournois, computing the livre tournois at 10*l.* sterling, and the sol at 1*l.* sterling.

Spain.

Spain.

220
Revenues.

221
Military strength.

221
Orders of knighthood.

224
Coins.

Modern Silver Coins.

Coins.	Value in Castilian money.
Real	
Real de vellon	2½d.
Medio real de plata	
Real de plata	5d.
Media pecata	
Pecata	10d.
Real de a dos	
Efcudo	2s. 1d.
Medio duro	
Duro	
Pezodaro	4s. 2d.
Real de 8 ocho	

255
Weights
and mea-
sures.

The Spanish weights and measures vary considerably in different parts of the kingdom, as almost every province has both peculiar to itself. The pound generally consists of 16 ounces in that part of the kingdom formerly belonging to the crown of Castile, and of 12 ounces in those annexed to the crown of Aragon; viz. in Aragon, in the kingdom of Valencia, and in Catalonia; but the ounce is not the same. We shall here only particularize the weights of Castile.

In the Castiles they reckon by charges, quintals, arrobas, arredes, pounds, ounces, and drams. The following table gives the proportional value of the Castilian weights.

		lb.	oz.
The charge contains	3 quintals	300	0
— quintal	4 arrobas	100	0
— arroba	25 pounds	25	0
— arrede	4 pounds	4	0
— pound	16 ounces	1	0
— ounce	16 drams	1	0
— dram	30 grains	1	16
— grain			250

The measures are still more complicated than the weights; and especially the measures of capacity, will require to be considered rather more in detail. We shall, as usual, distinguish them into long measure, superficial or land measure, and measures of capacity.

Long measure.—The standard lineal measure in Spain is the royal foot, consisting of 133 $\frac{1}{10}$ lines; and bearing to the English foot the proportion of about 153 to 144, or of 17 to 16. This foot, however, is not in general use, almost every province having its own foot, which is generally rather less than the royal foot. Thus, the foot in Castile is 8 lines less, and that of Valencia about 9 $\frac{1}{2}$ lines less than the standard.

Of royal feet 100 are equivalent to 102 feet 7 inches of Catalonia, to 107 feet of Valencia, to 115 feet 10 inches and 4 lines of Castile.

One hundred feet of Catalonia are equal to 92 feet 2 inches 3 lines of the royal foot, to 97 feet 5 $\frac{1}{2}$ lines of Valencia, and to 104 feet 11 inches 11 lines of Castile.

In Valencia 100 feet are equivalent to 93 feet 4 inches 12 lines of the royal foot, to 98 feet 9 inches of Catalonia; and to 77 feet 2 inches 6 lines of Castile.

In Castile, 100 feet are equal to 86 feet 1 inch 5 lines of the royal foot; to 93 feet 4 inches 9 $\frac{1}{2}$ lines of Valencia; and to 92 feet 2 inches 3 lines of Catalonia.

Cloths and stuff in Catalonia are measured by *canas*,

in other parts of the kingdom by *varas*; the *cana* is divided into 8 *pams*, the *vara* into four. The proportions which these bear to the royal foot will be seen from the following table:

	Feet.	Inches.	Lines.
Pam of Catalonia,	0	7	4
Canas of Catalonia,	4	10	8
Six pams make the Paris ell.			
Pam of Castile,	0	7	8
Vara of Castile,	2	6	8
Pam of the kingdom of Valencia,	2	9	4
Five pams and a little more than $\frac{1}{2}$ th, or one vara one pam and a little more than $\frac{1}{2}$ th, make a Paris ell.			
Pam of Aragon,	0	6	7 $\frac{1}{2}$
Vara of the Asturias,	2	5	9 $\frac{1}{2}$
Vara of Aragon,	2	2	5 $\frac{1}{2}$
A little less than 6 pams, or one vara two pams, make a Paris ell.			
Pam of Galicia for linen drapery,	0	9	2
Vara of Galicia for ditto,	2	6	8

Land Measure.—Land in the provinces belonging to the crown of Castile is measured by *ungadas*, *fanegas*, *estadales*, *braffes*, *varas*, *pas*, and *aranzadas*. Of these the *ungada* contains 50 *fanegas*, about 204 $\frac{1}{3}$ feet; the *fanega* 400 *estadales* = about 4 $\frac{8}{10}$ feet; the *estadale* two *braffes* = about ten feet; the *brafs* two *varas*, or about 5 feet 1 inch 4 lines; the *pas* about 1 $\frac{1}{3}$ d of a *vara*, and the *aranzada* about 73 *varas*. This last is only used for measuring vineyards.

In Biscay land is measured by *carros*, *plazas*, and *celemines*; and in Valencia by *yugadas*, *calibzadas*, *fanegas*, *braffes*, and *pams*.

Measures of Capacity.—Corn is measured in the provinces belonging to the crown of Castile by *calixas*, *fanegas*, *celemines*, and *quartillos*; and in Biscay the same measures are used, with the exception of the *calixta*. The *calixta* contains 12 *fanegas*, and is = about 1 $\frac{1}{2}$ lb. French; the *fanega* contains 12 *celemines* = 124 lb.; the *celeminie* 4 *quartillos* = 12 lb. 5 $\frac{1}{2}$ ounces, and the *quartillo* = 2 lb. 7 $\frac{1}{2}$ ounces.

In Catalonia grain is measured by *salmas*, *charges*, *quarteras*, *cortans*, and *picots*. The *salma* contains 2 *charges* or 6 *quintals* = 546 lb.; the *charge* contains 2 *quarteras* or 3 *quintals* = 273 lb.; and the *quartero* 12 *cortans* or $\frac{1}{2}$ *quintal* = 136 lb. 8 oz.; the *cortan* contains 4 *picots* or 13 lb. of 12 oz. = 11 lb. 6 oz.; and the *picoti* 3 $\frac{1}{2}$ lb. of 12 oz. = 2 lb. 13 $\frac{1}{2}$ oz.

The measures for liquids vary exceedingly, according to the liquid they are intended to contain. Thus, at Madrid, honey is measured by *arrobas* and *quartillos*, the *quartillo* being about 1 $\frac{1}{2}$ lbs. and the *aroba* containing 32 *quartillos*. Oil is measured in New Castile also by *arrobas* and *quartillos*, but the *quartillo* is = 6 $\frac{1}{2}$ lbs; and the *aroba* contains 4 *quartillos*, or 25 lbs. In Seville, oil is measured by the pipe and *aroba*, the pipe containing 34 *arrobas*; while in Valencia it is measured by *charges*, *arrobas*, and *cantaras*, the *charge* containing 12 *arrobas*, and the *cantaro* equal 28 lbs. 1 oz.

Wine in New Castile is measured by *moyos*, an imaginary measure, *cantaras*, *azumbres*, *quartillos*, and *sextarios*.

Spain. tarios. The moyo contains 16 cantaras, the cantara 12 azumbres, the azumbre 4 quartillos, each equal to 1 lb. At Caliz wine is measured by tonneux, arabas, azumbres, and quartillos. The tonneau contains 30 arabas, the araba 8 azumbres, the azumbre 4 quartillos, each of which is equal to 1 lb. 1 oz. At Seville the measures for wine are cantaras, azumbres, and quartillos. The cantara contains 3 azumbres, the araba 8, the same, the azumbre 4 quartillos, each of which is equal to 17 ounces. In Valencia these measures are, botas or tonneaux, charges, arabas, or cantaras, and azumbres or cuecotas; and in Catalonia, pipes, charges, quintals, arabas, quartos, and quantos, of which the pipe contains 4 charges, the charge 3 quintals, the quintal 4 arabas, the araba 22 quartos, the quarto 4 quantos, and the quarto is equal to nearly 3 ounces of Catalonian measure.

206
Laws. The laws of Spain, which for a long time varied greatly in the different states of the monarchy, are at present reduced to a considerable degree of uniformity. Navarre and Biscay have retained their ancient laws and constitution; but the revolution which took place in Spain at the beginning of the 18th century, enabled Philip V. to introduce into Catalonia and the kingdoms of Aragon and Valencia the laws of Castile; which, excepting a few alterations, rendered necessary by local peculiarities, still continue in full effect.

The laws of Castile, which are thus become those of almost all Spain, are contained in the codes known by the titles of the *Fuero juzgo*, *Ley de las siete partidas*, *Ordenamiento real*, *Fuero real*, and *Recepilacion*; of these the last is a collection of occasional edicts of the kings of Spain, and enjoys the highest authority.

The Roman law has no validity in Spain, and though it may be studied by a few lawyers, as containing first principles universally applicable; yet it is never quoted in the courts, and is expressly excepted against by some of the old laws of Castile.

207
Administration of justice. The conducting of a law suit in Spain is subject to very complicated forms; whence necessarily results a slowness of progress. The whole business is carried on by writers, a peculiar branch of the legal profession. In the superior tribunals, the management of causes is in like manner committed to a kind of subaltern magistrates, called reporters (*relatores*), who contrive to render their own department a situation of much greater emolument than that of the judge.

In all the branches of civil, military, ecclesiastical, and judicial administration, in Spain, is evident a spirit of mildness and paternal indulgence, which often degenerates into great abuse. By multiplying courts for the administration of justice, and by establishing the long series of appeals from jurisdiction to jurisdiction, in order that each case may be heard and re-heard, and receive an equitable sentence, the still more important advantages of prompt decision are sacrificed, and a door is opened for chicanery.

It is universally acknowledged that the courts of execution are far too numerous; they enfeeble the authority of the established judges, and withdraw a number of individuals from the superintendance of magistrates who reside among them, and are readily accessible, to consign them to the care of distant and dilatory tribunals.

A considerable degree of jealousy and opposition also subsists among many of the tribunals; hence they mutu-

ally weaken each other's authority, and the clients are confined over from court to court; so that lawsuits become intolerably protracted, and a family is held in suspense for two or three generations. The consequence of this is, that the rich wear out those of inferior fortune.

Even the ordinary and regular forms of civil process are slow and complicated. The husbandman is called from his labour, the merchant from his commercial concerns, the artist from his work, and all from their domestic affairs. Nearly an equal tardiness takes place in criminal processes, so that wretches die, and means of proof are lost, while the guilty often escape unpunished; and those who have been formally acquitted, are still subject to a long detention in prison, whence they are at length dismissed without indemnity, and irretrievably ruined.

In consequence of the great number of courts, the facility of appeal from one to the other, and the tediousness of law suits; the multitude of judges, advocates, writers, and other subordinate officers employed in the administration of justice is prodigious. The number of persons employed in the different law establishments has been estimated at 100,000, which is nearly an hundredth part of the population of the country; and the very last general enumeration of the inhabitants of Spain makes the number of advocates amount to 3675, and of writers to 9351; besides the judges and their secretaries, the attorneys and their clerks, and the innumerable host of alguazils and inferior officers.

Another serious inconvenience in the administration of Spanish law, is the necessity of reposing entire and blind confidence in a class of subaltern officers of the courts, called writers. This appears to be a branch of the profession wholly peculiar to Spain; the writer exercising at the same time the functions of secretary, solicitor, notifier, registrar, and being the sole medium of communication between the client and the judge.

It is not customary in Spain to allow either of the parties concerned any copy of the documents requisite for carrying on a suit, except by the express order of the judge. All the writings on both sides are collected together and bound up into a volume, which remains steadily in the possession of the writer, who entrusts it for a certain time to the attorneys of the parties for the instruction of advocates. The writer, to whose care the documents of any suit are committed, also registers the decrees and sentences of the judges on the case, and notifies to the parties concerned, each step of the process, by reading to them the proper instrument; without, however, allowing them to have a copy of it.

The union of so many important functions in the same person, necessarily affords various opportunities for dishonesty; and the chance of being imposed upon is still further increased by an unwise regulation which obliges the defendant, in any action, to choose the same writer as is employed by the plaintiff.

It may be remarked that scarcely any other persons are under equal temptations to dishonesty on account of the almost total impunity that they enjoy in consequence of the following regulation. In all those districts where there are either a corregidor and superior alcade, or two superior alcades; each of these officers has an independent tribunal for the decision of law suits; and the right of pronouncing sentence in any particular case belongs to him of the two at whose tribunal the first application

Spain.

tion was made. Now the established salaries of these officers are so small, that the largest part of their emoluments arises from their fees: this portion of their income depends wholly on the writers, who have the power of instituting suits in which of the two courts they please. The natural consequence is, that the judges are induced to overlook and pass by in silence those malpractices of the writers which they cannot prevent without incurring a serious personal loss. Finally, the authority of the writers is irrefragably established by the entire control that they execute over all causes. They alone receive the declarations and personal answers of the parties concerned; they alone receive the depositions of the witnesses on each side; put what questions to them they please; and record the answers without the interposition, and even in the absence, of the judges.

Another serious defect in the administration of justice in Spain, is, that the party condemned, however clearly unjust may have been his demand, or however weak may have been his defence, is scarcely ever obliged to pay his adversary's costs of suit; whence it perpetually happens, that the expences of gaining a just cause are much greater than the loss of submitting to an unjust demand; hence also it is in the power of a rich villain to oppress and ruin all those who are unable to support the expences of a law suit; which in Spain are enormous, and perhaps the more so, because the established charges are very light.

7-8
Religion.

The religion of Spain is the Roman Catholic; which, in this country and Portugal, has been carried to a pitch of fanaticism unknown to the Italian states, or even in the papal territory. The inquisition, has in these unhappy kingdoms, been invested with exorbitant power, and has produced the most ruinous effects; having been formerly conducted with a spirit totally the reverse of the mildness and charity of Christianity. This evil has been recently subdued in a considerable degree; but one fanatic reign would suffice to revive it. A yet greater evil, which has sprung from fanaticism, is the destruction of morals; for the monks being extremely numerous, and human passions ever the same, those ascetics atone for the want of marriage by the practice of adultery; and the husbands, from dread of the inquisition, are constrained to connive at this enormous abuse. The conscience is seared by the practice of absolution, and the mind becomes reconciled to the strangest of all phenomena, theoretic piety and practical vice united in bonds almost indissoluble.

According to the returns made to the government, the Spanish clergy then stood as follows.

Parochial clergy, called curas	- - -	16,689
Assistants, called tenientes curas	- - -	5,771
Sacristans or sextons	- - -	10,873
Acolytes to assist at the altar	- - -	5,503
Ordinados de patrimonio, having a patrimony of three rials per day	}	13,244
Ordinados de menores, with inferior ecclesiastical orders		10,774
Beneficiados, or canons of cathedrals, and other beneficiaries	}	23,692
Monks		61,617
Carry forward		148,163

	Brought over	Spain.
Nuns	- - - -	148,163
Beatas	- - - -	32,500
Syndics to collect for the mendicants	- - - -	1,130
Inquiritors	- - - -	4,127
		2,705
		188,625

The archbishops were eight in number; and the bishops 46. The most opulent see was that of Toledo, supposed to yield annually about 90,000*l*. The Mozarabic Missal, compiled by St Ildefonso for the Gothic church, after the conversion from Arianism to the Catholic faith, continued to be used in Spain till the Moors were subdued, when the Roman form was introduced.

The Spanish clergy, in proportion to the population of the country, is less numerous than was the clergy of France prior to the revolution; even their wealth is less considerable, but better administered; and their contribution to the public revenue is much greater. As to the general conduct of the Spanish church, and its influence on the state, we may remark that after all the perverted and malicious industry that has been exerted in the examination of this question, the result has turned out highly favourable to the superior orders of the Spanish clergy, who are, for the most part, free from those irregularities which are charged on the clergy of other countries. The conspicuous situations in the Spanish church are by no means considered as the patrimony of the rich and noble, but as the well-merited reward of irreproachable conduct. Whatever may be the rank of an ecclesiastic in the sacerdotal hierarchy, he never habitually absents himself from his proper place of residence, where he expends the revenue of his benefice in alms or public works. From the period of the reconquest of Spain from the Moors, most of the public establishments owe their foundation to the clergy, by whom also whole towns have been rebuilt and raised from their ruins. The most beautiful aqueducts, fountains, and public walks in the cities, have been constructed at the expence of their bishops; from them also the poor have received the most effectual relief in times of scarcity, epidemic disease, and war. The bishop of Orense converted his episcopal palace into an almshouse, where were lodged and supported 300 French ecclesiastics, condemned to transportation during the furies of the revolution; the prelate himself took his place at their table, and refused to partake of any indulgence that he could not also procure for his guests. Cardinal Orenzana, archbishop of Toledo, converted the alcazar of that city into an establishment wherein are received 200 children, and 700 poor persons of all ages. The bishop of Cordova, during the scarcity of 1804, and for a long time afterwards, made a daily distribution of 1200 rations of bread to the poor inhabitants of his diocese. The aqueduct which conveys water to the city of Tarragona is the work of their archbishop, who has thus conferred upon the place the inappreciable benefits of cleanliness and health; to both of which it was long a stranger. Similar instances of public merit may be found in almost every diocese.

With regard to the religious orders, their conduct is certainly less exemplary, though by no means meriting the reproaches that have been so liberally cast upon them.

them. The reforms that have taken place at various periods: have stopped the progress of the abuses introduced by length of time; and as the numbers of the monks have diminished, their pernicious influence on public opinion has proportionally declined. Some progress has been made in the desirable policy of uniting the different orders of the same rule into a single order; and from the present prohibition to receive novices, it is probable that several orders are about to be totally suppressed.

The Spanish language is one of the great Southern dialects which spring from the Roman; but many of the words become difficult to the French or Italian student, because they are derived from the Arabic used by the Moors. The speech is grave, sonorous, and of exquisite melody, containing much of the flow and formal manner of the orientals.

The Spanish language is, in some respects, very rich; it abounds in compound words, in superlatives, derivatives, augmentatives, diminutives, and frequentative verbs; it has many quite synonymous words, and others which well express the different shades of meaning. In the technical terms of arts and sciences it is, however, extremely poor; a few of these it has borrowed from the Latin, and almost all the rest from the French.

On the whole, the Spanish is one of the finest of the European languages. It is dignified, harmonious, energetic, and expressive; and abounds in grand and forcible expressions, which unite into measured periods, whose cadence is very agreeable to the ear. It is a language well adapted to poetry; but it also inclines to exaggeration, and its vehemence easily degenerates into bombast. Though naturally grave, it easily admits of playfulness. In the mouth of well educated men it is polite and expressive; lively and pointed in that of the common people; sweet, seductive, and persuasive, when uttered by a female. Amongst the orators it is touching and imposing, though rather diffuse; at the bar and in the schools it is barbarous, and is spoken about the court in a concise and agreeable manner.

The literature of Spain is highly respectable, though little known to the other countries of Europe since the decline of Spanish power. The Bibliotheca Hispanica of Antonio will completely satisfy the curious reader on this subject. Among the fathers of literature in this country must be named Isidore of Seville, many of whose works are extant, and inferior in merit to few of that epoch. Lives of saints, and chronicles, are also found among the earliest productions; and facetious writers may be traced to the 11th century, when they become numerous; but before mentioning some Spanish authorities posterior to that period, it will be proper to recollect that Arabian learning flourished under the caliphs of Cordova, and produced many illustrious names well known to the oriental scholar, as Aben Ros, or Averroes, Aben Zair, Rhazes, &c. nor must it be forgotten that Aben Nazari wrote a book on the learning and authors of Spain. On this subject the inquisitive are referred to the work of Casiri.

In the 11th century, the Spanish authors began to increase in number, and the native language begins to appear. This was the epoch of the famous *Cad. Roderic D'har de Bivar*, whose actions against the Moors were celebrated in contemporary songs, and by a long poem

written in the following century. After the 13th century, it would be idle to attempt enumerating all the Spanish authors, among whom are Alphons the Wise, who wrote the *Libro del Terrolo*, a treatise on the Three Parts of Philosophy; and at whose command were compiled the famous Alphonsine Tables of Astronomy. Raymond Lully is said to have written not fewer than 319 books, full of metaphysical froth. In the 15th century appeared Juan de Mena, a poet of surpassing powers, since which time a department of literature can scarcely be mentioned in which the Spaniards have not excelled. It would be unnecessary to repeat the well-known names of Cervantes, Quevedo, Lopez de Vega, and others, whose works are known to all Europe. The history of Mexico has been celebrated as a composition; but in fact it is defective and erroneous. The name of Boyer in learning, and of Feys in general knowledge, have recently attracted deserved respect; nor has the line of royal authors failed, an elegant translation of Sallust having been published by the heir apparent to the monarchy, the present Ferdinand VII*.

As the rudiments of education are in Spain generally imparted by the monks, it can scarcely be expected that useful knowledge should be common in that country. The accounts given on this subject by travellers, have thrown so little light on the state of education in Spain, that it can be generally understood only by comparison with other Catholic countries. In this comparison Spain will be found inferior to France and Italy, but in many respects superior to Austria and the German states.

The number of universities in Spain was formerly 24, but only the following 17 now remain, viz. that of Pampeluna, in Navarre; of Oviedo, in the Asturias; of San Jago, in Galicia; of Seville, and of Granada, in the provinces of the same name; of Huesca and Zaragoza, in Aragon; of Avila, Omsa, and Valladolid, in Old Castile; of Toledo, Sigüenza, and Alcala de Harnarez, in New Castile; of Cervera, in Catalonia; of Oahuaca and Valencia, in Valencia; and of Salamanca, in the province of Leon. Of these the most celebrated, are the universities of Zaragoza, Toledo, Alcala, Cervera, and Salamanca.

The university of Zaragoza has 22 professors, and that of Toledo has 24; about 920 students attend the classes of the former, and nearly 2000 those of the latter; yet neither of these establishments is known in Europe, or regarded as of high reputation even in Spain.

The university of Alcala, established at a prodigious expence by Cardinal Ximenes, answered for nearly a century the views of its illustrious founder. This splendid institution consists of 31 general professors, and 13 colleges, each of which has its particular establishment of masters and professors, and of students, who receive gratuitous support and instruction. At present, however, this university is gone to entirely to decay, that scarcely a vestige of its ancient splendour remains, and the whole number of students scarcely amounts to 300.

The university of Cervera, founded at the commencement of the 15th century, with a magnificence truly royal, possesses 43 professors, five colleges, about 920 students; but it partakes of the radical fault of all the Spanish universities: the course of study is incomplete and antiquated, and the very name of the institution is scarcely known beyond the boundaries of Catalonia.

The university of Salamanca, the most ancient of any in Spain, has enjoyed a degree of celebrity which entitles it to a particular description.

It was founded by Alphonso IX. between the years 1230 and 1244, and was considerably enlarged by Ferdinand III. his grandson. But its most magnificent patron was Alphonso X. furnished the Wife, son and successor of the last mentioned sovereign. This prince richly endowed it, and drew up a set of statutes for its government. He established a professorship of civil law, with a salary of 500 maravedies; a professorship of canon law, with a salary of 300 maravedies; two professorships of decretals with salaries of 500 maravedies; two professors of natural philosophy, and as many of logic, with salaries of 200 maravedies each; and two masters of grammar, with salaries of 300 maravedies. It experienced also the liberality of many succeeding sovereigns, and received from the popes a vast extent of privileges.

For many years this university enjoyed a high reputation; its fame extended over all Europe; it was consulted by kings and by popes, and its deputies were received into the general councils, where they well sustained the character of the body which they represented. Students flocked to it not only from all the provinces of Spain and Portugal, and from the islands of Majorca and the Canaries, but also from the West Indies and New Spain, and even from France, Flanders, and England. The number of students who attended the classes amounted nearly to 15,000. The whole of this vast establishment consisted of 25 colleges, a library, and an hospital, called *Del Estudio*, intended for the amelioration of poor scholars.

The celebrity of Salamanca continued in full vigour during many ages; but, at length, as rival institutions sprang up, declined by slow degrees, so that by the year 1505, the number of students did not exceed 7000*.

After the evacuation of Spain by the Romans, theatrical representations were discontinued till they were restored by the Moors, and from them adopted by the Gothic Spaniards, who soon became passionately fond of the stage, a taste which they have ever since preserved.

They had at first neither theatres nor a stage, their dramas were acted in a court, a garden, or the open fields: the actors and spectators were mingled, and were equally exposed to the injuries of the weather.

At a subsequent period the stage was marked out by a kind of boarded platform, and was surrounded by old clothes, drawn back, on occasion, by means of cords, which formed the only decorations, and behind which the actors dressed. Their properties consisted only of crowns, some wigs and false beards, and a few white skins, trimmed with gold fringe.

Theatrical exhibitions became more regular and decent towards the end of the 16th century, when a new form was given to them by the exertions of Bartholomew Naharro, a middling dramatic poet. Theatres were then erected, but the greatest part were upon wheels, and two parallel pieces of canvas formed their frames, which were sometimes chequered with various colours, sometimes covered with miserable paintings, or adorned with foliage, trees, &c.

During all these periods, the prompter, with a candle in his hand, sat near the back of the stage by the side of the performers, and, ere speaking, and jumped from side to side whenever the actors changed their places.

This custom prevailed at the end of the 17th century, and even still prevails among the strolling companies of small towns.

Theatres have at length, however, assumed a handsomer appearance in this country, and customs more conformable to the rest of Europe. Handsome theatres have been multiplied, and their stages are now well arranged and decorated; all the great cities are well provided with them, and many of the smaller towns may boast of elegant and not ill furnished playhouses.

The prompter no longer runs from one side of the stage to the other; he is placed in the middle before the scenes, in a kind of well, where he no longer offends the sight and taste of the spectator: but an old custom which is still observed, greatly injures the interest and effect of the representation. The prompter, who has the piece before him, does not wait till the actor is at a loss to prompt him, but recites the whole drama aloud, so that the actor appears to follow him in his declamation. By this means two voices are heard in the theatre pronouncing the same words, which are confounded, and often produce a discord, and the spectator who has first heard the piece recited, no longer takes an equal interest in the same verses, phrases, and words, which the actor afterwards declaims.

The Spanish theatres are divided into a *patio*, or area, and boxes called *balcos* and *apoyentos*. The orchestra, where the musicians are stationed, adjoins the stage; an inclosure between it and the pit is let round with arm chairs, and destined for the reception of the higher class: the *patio*, or pit, is placed behind, and filled with benches, and the *gradas* consist of two rows of benches disposed amphitheatrically on each side below the boxes, and sometimes also across the lower end of the theatre. This last division is found only in a few theatres; in others, the space beneath the boxes is empty, and persons stand in it. The *patio* and the *gradas* contain the common people, the most numerous, most noisy, and most imperious part of the public.

There are commonly only two tiers of boxes, sometimes three; they extend on each side from the stage to the end of the theatre. The form is the usual one, but they are divided from each other by partitions, which completely shut them up on each side, a circumstance which greatly injures the beauty of the general effect.

There is commonly at the end of the theatre fronting the stage, a large box with seats placed semicircularly behind one another, which is called the *cazuela*. No man is allowed to enter it, and only women muffled up in their *mantillas* are admitted.

There are several things very singular and amusing in this *cazuela*. Women of every age and condition are there united; the married are confounded with the single; the wives of the common people with those of tradesmen and the ladies of the court; the poor woman with the rich one who would not be at the trouble of dressing to appear in her box. Their appearance is most curious; they are all covered with their *mantillas*, a kind of white or black veil, and give the idea of a choir of nuns. It is the place for chattering, and between the acts there proceeds from the *cazuela* a confused noise like the hum of bees, which noises and divers all who hear it for the first time. Scarcely is the performance ended, when the door of this box, its galleries, passages, and the staircase leading to it, are

all besieged by a great crowd of men of every condition; some attracted by curiosity; others coming to wait upon the women who are in it.

Notwithstanding all that has been done for its improvement, the Spanish stage is still far from the celebrity which it once possessed; and the people do not second the efforts of their best writers. The acting is in a still lower state. The performers possess neither that dignity which characterizes great personages, and ennobles a subject without injuring its interest; nor that sweet expression of voice and gesture which goes to the heart, and awakens the sentiments it expresses. In their acting every thing is violent or inanimate; every thing departs from nature. Their recitation is a feat of strength, and is performed at the sole expense of the lungs. Cries and tricks are its most impressive part, and the most applauded by the majority of the audience. They put nothing in its proper place: all their action is exaggerated; when they threaten they roar; when they command they thunder; when they sigh, it is with an effort which completely exhausts the breath. They substitute anger for dignity, violence for spirit, insipidity for gallantry. Their gestures rarely correspond with the sentiments they ought to express; but resemble their recitation; and are usually monotonous, capricious, ignoble, and almost always violent. The women, in their bursts of passion, become furies; warriors become villains; generals robbers; and heroes bravos. Nothing, as they manage it, is pathetic; nothing makes any impression on the audience. The spectators, equally unmoved at the end of the piece, as at the beginning, see it, without having experienced a single moment of interest or emotion*.

As labour and culture are reckoned derogatory to the Spanish character, a sufficient quantity of grain for the support of the inhabitants is not raised, though societies for the encouragement of agriculture have been established in different parts of the kingdom. The principal products are wine, delicious fruits, oil, silk, honey, and wax. A considerable proportion of the mountains and valleys is satured by immense flocks of sheep, whose wool is extremely fine and valuable. Eitremadura is noted for its excellent pastures; and the wool in Old Castile is reputed the finest in the kingdom. In Catalonia the hills are covered with forest and fruit trees. Valencia is celebrated for its silk, and for the exquisite flavour of its melons. Murcia abounds in mulberry trees; and the southern provinces yield the most delicious wines and fruits. Upon the whole, it has been observed of Spain, that few countries owe more to nature, and less to industry.

The soil in general resides on beds of gypsum, which is an excellent manure. The common course of husbandry about Barcelona begins with wheat; which being ripe in June, is immediately succeeded by Indian corn, hemp, millet, cabbage, kidney beans, or lettuce. The second year these same crops succeed each other as before. The next year they take barley, beans, or vetches; which coming off the ground before midsummer, are sown, as in the former years, by other crops, only changing them according to the season, so as to have on the same spot the greatest possible variety. Near Cisthagna the course is wheat, barley, and fallow. For wheat they plough thrice, and sow from the middle of November to the beginning of December; in July they reap from 10 to 100 for one, as the season happens to be

humid. The rich vale of Alicant yields a perpetual succession of crops. Barley is sown in September, reaped in April; succeeded by maize, reaped in September; and by a mixed crop of cucumbers which follow. Wheat is sown in November, and reaped in June; flux in September, pulled in May. In the vale of Valencia wheat yields from 20 to 40; barley from 18 to 24; oats from 20 to 30; maize 100; rice 40. The Spanish plough is generally light; and is drawn by oxen with the yoke over the horns; the most proper and natural mode, as the chief strength of the animal centres in the head. For a very minute account of agriculture in Spain, see *De Laboribus Vici*, vol. iv. chap. 2.

That prejudice which regards the mechanic arts as base, is not yet extinguished in Spain; hence it happens that these arts are either neglected, or abandoned to such unskilful hands as in general to render the Spaniards much behind their neighbours, in the useful arts of life. The influence of this prejudice is least in the province of Catalonia, where the laws, customs, and opinions are favourable to artizans; and it is accordingly in this province that the mechanic arts have made the greatest progress. Foreign artizans experience great difficulties in this country. They are not allowed to practice without gaining admission into some incorporation or company, and this has almost always been refused them.

Some arts have, however, made considerable progress in Spain, especially those of gilding leather, and printing, which has lately acquired a great degree of perfection.

The fabrication of articles of gold and silver might become an important object in a country where these metals abound; but it is neglected, and the demand is almost entirely supplied from foreign markets. What little they perform in this way at home is usually very ill executed, and exorbitantly dear. Madrid, however, begins to possess some good workmen in this way; encouragement would increase their number, and facilitate the means of improvement; but manual labour is there excessively dear. Hence the Spaniards prefer foreign articles of this kind, which, notwithstanding the expense of carriage, and the enormous duties which are paid on these articles, and the profits of the merchants, are still cheaper than those made at home.

The liberal arts are cultivated in this country with more assiduity and success. The 16th century was the most brilliant period of the arts in Spain, as well as of the sciences, of literature, and of the power and grandeur of the monarchy. A crowd of able architects appeared at once under Charles V. and Philip II. They erected numerous edifices, which will immortalize the reigns of these princes and the names of the artizans. John de Herrera and Cepedes displayed the highest talents; Pedro de Uta constructed the magnificent bridge of Almaraz, in Eitremadura; John-Baptist-Moniego of Toledo, assisted in the building of the Escorial, and of the church of St Peter at Rome.

The structures of this age are the finest in Spain, and perhaps the only ones in the country which deserve to fix the attention of the skilful spectator. There are some among them which, in regularity, solidity, and magnificence, deserve to be compared with the fine buildings of the Romans. The bridges of Barbujoc over the Guadiana, and of Toledo, over the Manzanares, are of this period; as are also the grand house or palace, now the

* *De La-borde*.
214
Produce and agriculture.

212
State of the arts.

216
Architectures.

Spain. co. situated in Madrid, and the beautiful edifices which adorn Toledo; the palace of Las Vargas; the hospital of St John the Baptist, and that of the Holy Child. During the same time, the *alcázar* of this city, built under Alphonso X. was restored with the grandeur and magnificence which it still displays; and the royal palace was rebuilt, known under the name of the House of Plater, at Madrid.

That magnificent building the Escorial, which the king had planned the eighth wonder of the world, which used to lodge at once the king and his court, and 200 monks; his famous palace, which astonishes us by its magnitude and extent, by the strength of its structure, the regularity of its proportions, and the splendour of its decorations, as much as by the repulsive appearance of its site and neighbourhood, also belongs to the same period, having been erected in the reign of Philip II.

The decline of architecture became as complete in the 17th century as its state had been flourishing in the preceding age. From this period no architect occurs worthy of remembrance; and the buildings are monstrous masses, destitute of order, taste, and regularity. One only deserves notice, the prison of Madrid, called *Carcel de Conte*, the work of a happy genius, who knew how to profit by the bright examples of the preceding period.

About the middle of the 18th century, however, architecture began again to be cultivated with success. The academy of San-Fernando, at Madrid, has already produced several able men in this branch, who pursue their art with credit. The handsome bridge built over the Xarama, between Aranjuez and Madrid, in the reign of Charles III. displays the talents of Mark de Vienna, his architect; the custom-house of Valencia, and the temple-church of the same city, constructed on the plan of Michael Fernandez; the exchange of Barcelona; the triumphal arch which forms the gate of Alcala; at Madrid, and the linen manufactory at Seville, do honour to the Spanish architecture of the present day.

Spain justly boasts of many eminent sculptors; but of all the liberal arts, painting is that which has been most cultivated in Spain, and in which its natives have been the most successful. The Spanish school is much less known than it deserves; it holds a middle place between the Italian and Flemish schools; it is more natural than the former, more noble than the latter, and partakes of the beauties of both. It has particularly excelled in sacred subjects; and we recognise in the Spanish pictures the feelings usually exercised by the people of the mysteries of religion. By none have devotion, fervour, and genuine piety, been so well expressed, or the mystic passion given with so much truth. It is not in correctness of design, or nobleness of form, that the Spanish artists usually excel, but in the penetration of nature, in grace, truth, effect, and the expression of feelings.

The Spaniards have at length opened their eyes to the utility of the arts; they acknowledge them to be advantageous, and deserving of respect, and have begun to give them such encouragement as is likely to promote a taste for them, and to induce their advancement. Government has done something by affording protection and countenance to the new establishments; but the strongest impulse has been given by individuals, or private associations.

Spain now possesses an academy of painting, at Seville, and two academies of the fine arts, one at Madrid, and the other at Valencia. The first owes its origin to an association of the painters of Seville formed by themselves, about the year 1665; Charles III. revived it, and established there a school of the fine arts. That of Madrid was founded by Philip V. The last was established by the exertions of some private persons, assisted by the benefaction of Andrew Majoral, archbishop of Valencia, and the protection of the municipal body. Charles III. came to its assistance 26 years after its establishment, with an annual gift of nearly 700*l*. These academies have for their object the study and improvement of painting, sculpture, and architecture; they give public lessons on these three arts, and distribute annual prizes among their pupils. That of Madrid, or San-Fernando, sends its pupils to Rome at the expence of government, to complete their studies.

Public and gratuitous schools for drawing have been established within the last 20 years in different places; at Madrid, Cordova, Valencia, Seville, Zaragoza, Barcelona, &c. The last of these is supported by the merchants; that of Vergara was founded by the patriotic society of Biscay; and those of Zaragoza and Cordova owe their birth to the zeal and generosity of two individuals; the first to Don Martin Noy Coebear, the last to Don Antonio Cavallero, the present bishop of Cordova. Those of Madrid, Seville, and Valencia, depend on the academies of these cities.

The manufactures of Spain were more flourishing during the government of the Moors in that country, than they have been at any subsequent period. So completely had the kingdom declined in this respect at the end of the 16th century, when Philip V. ascended the throne, that it is said by De Laforce to have been absolutely destitute of trade. The intestine wars which ravaged the kingdom during the first 14 years of that reign, and the low state to which the national finances were reduced, prevented the government from paying attention to manufactures; and it was not till after tranquillity had been restored, and regulations adopted with respect to the public revenue, that the natives were induced to wear articles of their own manufacture. Since the reigns of Ferdinand VI. and Charles III. this part of the internal trade of the kingdom has greatly improved, and the manufactures of Spain are now once more on a respectable footing.

The Spanish manufactures enumerated by De Laforce, in his *View of Spain*, are those of cloth and other woollen goods; silks; brocaded stuffs in gold and silver; lins and other articles formed from flax or hemp; cottons; leather, and other articles manufactured from skins and hides; paper; china and delft ware; brandies; beer; aquafortis; salt of lead; shears for the woollen trade; copper, iron, and brass goods; glass and mirrors; soap; hats; articles for the marine; military implements; arms and ammunition; tobacco and snuff. Of these, the most important are, the woollen and silk manufactures; leather; brandy; military weapons; soap and tobacco.

The principal places for the woollen manufactures are, Avul, Avers, Vich, and the convent of Giracine in Catalonia; Jaca, and the district of Cinevilla in Aragon, and Burgos in Old Castile, for woollen stockings; Barcelona, Zaragoza, and Burgos, for blankets; Junquera, Segovia, Burgos, and many others for baizes

and flannels; Etella in Navarre, Escoray in Biscay, Grazolerna in Seville, Toledo, &c. for coarse cloths, which last article is manufactured in large quantities throughout the kingdom. The woollen stuffs fabricated in Spain are in general of a very inferior quality, the wool being imperfectly sorted, and the dyeing so ill executed that the colours are never permanent.

The chief manufactures for silken articles are those for blonde lace throughout Catalonia, and at Almagro in La Mancha; for silk stockings, at Malaga, Zaragoza, Valencia, Talavera, and Barcelona; and for silk taffeties, serges, damasks, and velvets, at Jaen, Granada, Murcia, Valencia, Malaga, Zaragoza, Toledo, Talavera, and Barcelona. The articles of this manufacture are in general stout and excellent; but they do not possess that brilliancy of appearance so remarkable in the French silks.

Tanning, currying, and dressing hides, skins, and all kinds of leather, are very general throughout Spain; but the skins and hides prepared at Arevaca and Pozuelo, are in greatest repute. The greatest quantity of sole leather is manufactured in the provinces of Aragon and Catalonia; and in the latter province are made and exported a prodigious number of shoes.

The making of brandy is confined chiefly to the states belonging to the crown of Aragon, especially at Torres in Aragon; at Selva, Mataro, &c. in Catalonia; and in Valencia.

Spain has long been famous for its manufacture of military weapons; and it is well known that the swords, sabres, bayonets, and bayonets, made at Toledo and Barcelona, are of a very superior temper. Large manufactories for fire-arms occur in the district of Guipuzcoa, and two royal foundries for brass cannon, are established at Barcelona and Seville.

There is only one manufactory for tobacco and snuff in Spain, viz. at Seville; but this is on a most extensive scale, and is supposed to yield an annual profit of 800,000 sterling. Here are employed 222 mills, turned by 300 horses or mules; and the various operations call for the daily labour of above 1400 persons.

Considering the extent of sea coast belonging to the kingdom of Spain, its commerce is but inconsiderable, and principally takes place between the mother-country and the American colonies. Spain, indeed, carries on a foreign trade with every country in Europe; but its principal transactions are, with England, Holland, Italy, and France. Its exports to these countries consist almost entirely of raw produce, as, if we except oil, wine, brandy, shoes, salt, and a few coarse cloths and silken articles, the trade in manufactured goods is almost wholly confined to the interior of the country. Its chief exports, and the amount yielded by each for the several provinces, as well as the whole amount of the export trade of Spain, to the rest of Europe, will be seen in the following table.

Value of Exports from each Province in pounds sterling.

Goods exported.	Catalonia	Valencia	Andalusia	Murcia	Aragon	Other Provinces	Total
Wine	L. 26,200	-	208,333	-	-	L. 8,356	L. 343,889
Oil	26,667	-	-	-	-	-	235,000
Cork	23,667	-	-	-	-	-	235,000
Wine	2,667	103,333	328,333	31,250	-	-	645,583
Linen and cotton stuffs	29,500	-	-	-	-	-	295,000
Silk handkerchiefs	51,242	-	-	-	-	-	51,242
Paper	73,333	-	-	-	-	-	73,333
Brandy	262,500	125,000	-	-	-	-	387,500
Shoes and shoe soles	22,224	-	-	-	-	-	22,224
Raffine	-	12,625	625,000	-	-	-	637,625
Dried figs	-	3,333	34,375	-	-	-	37,708
Almonds	-	6,363	-	-	-	-	6,363
Dates	-	6,250	-	-	-	-	6,250
Bayilla	-	15,875	-	128,333	-	-	144,208
Kermes	-	7,292	-	-	-	-	7,292
Salt	-	9,250	838,333	-	-	-	847,583
Spout worked	-	-	-	4,166	-	-	4,166
Silk	-	-	-	229,166	38,333	-	267,500
Cutlery	-	-	-	5,000	-	-	5,000
Ribbons	-	-	-	2,283	-	-	2,283
Corn	-	-	-	78,041	53,437	-	131,478
Saffron	-	-	-	2,500	-	-	2,500
Wool	-	-	-	-	48,750	64,082	69,832
Flax	-	-	-	-	1,458	-	1,458
Coarse cloths	-	-	-	-	2,666	-	2,666
Silk and wool mixtures	-	-	-	-	58,333	-	58,333
Worsted stockings	-	-	-	-	540	-	540
Salt pr vilvins	-	-	-	-	-	A large quantity from Galicia	-
Oranges and lemons	-	-	-	-	-	-	-
Hemp	-	-	-	-	79,063	-	79,063
Madder	-	-	-	-	-	From Old Castile	66,607
Brooms	6,250	-	-	-	-	-	6,250
	1,002,167	1,793,321	2,209,374	460,539	250,280	716,685	4,928,304

Spain.

The above table is confined almost entirely to the European exports. To these must be added the amount of Spanish exports to the American colonies in order to acquire a just view of the total amount of the export commerce. The following table will show the amount of the exports, both of home and foreign produce, from Spain to America in 1784, as estimated by Mr Townsend in pounds sterling.

	Home produce	Foreign produce	Total
Cádiz	1,438,92	2,182,531	3,621,443
Malaga	196,879	14,321	210,680
Seville	62,713	37,543	93,256
Barcelona	122,631	21,242	143,871
Coruna	64,575	39,962	104,537
Santander	36,715	97,173	126,888
Canaries	24,974		24,974
Tortosa	7,669	289	7,958
Gijon	4,381	10,190	14,471
Total	L.1,958,859	L.2,379,219	L.4,384,878

Of these exports we are to regard chiefly those of Spanish produce, and these Mr Townsend has probably estimated too high. M. de Laborde, on whose authority we are more disposed to rely, states the value of Spanish domestic merchandise exported to America in the year 1788, as amounting to 1,635,658l. sterling, while in 1792, it amounted to 2,812,500l. sterling, and on an average of five years, from 1788 to 1792, it amounted to 1,833,333l. sterling. The amount of foreign merchandise exported in 1788, was 1,484,315l. sterling. Adding the average to this last sum, we have 3,317,648l. sterling for the whole export trade to America. This added to 8,225,952l. sterling for the whole export trade of Spain.

The Spanish imports are much more considerable than the exports. Before the present troubles, Spain imported from Holland, tapes, linen drapery, common lace, cutlery goods and paper; from Silesia linen drapery; from Germany, more particularly from Hamburg, quantities of haberdashery; from England, calicoes, iron and steel goods, fine cloth, quantities of cod fish and ling; the value of the last articles is estimated at three millions of duros, five millions livres tournois, (208,333l. 18s. 4d.); from France, calicoes, linen drapery, silk it cloths, silks, camlets, and other kinds of worked silks, fine cloths, gilded articles, jewellery, iron goods, haberdashery, steel goods, and perfumery.

We have not satisfactory documents sufficient to ascertain the amount of these imports, but it was certainly much less than that of the imports from the American colonies. These latter, according to Mr Townsend's statement, amounted in 1784 to 12,655,173l. sterling; to which, if we add nearly half a million for duty, we shall have a total of above thirteen millions sterling for American imports alone. De Laborde estimates the total amount of American imports for the year 1788 at 8,382,327l. sterling, of which Cadiz alone imported 6,678,731l. sterling. If to the above amount we add 577,609l. for the duty at the same period, we shall have a total of 8,962,259l. sterling against the mother coun-

try, deducting from this 3,317,648l. for the average exports, we have 5,642,361l. as the balance of trade in favour of the Spanish colonies.

Though there are in Spain many navigable rivers, few canals of communication have been constructed to improve the internal navigation of the country. The canal of Aragon, completed during the reign of Charles IV. must be highly beneficial to that province. Two canals, viz. that of Tuentre and the imperial canal, both of which begin at Navarre, run in various windings through Aragon, by turns receding from or approaching the river Ebro, where at length they terminate. Besides the dykes, banks, sluices, and bridges necessary in the course of these canals, an aqueduct has been constructed in the valley of Riozalet, 710 fathoms in length, and 17 feet thick at the base, in which the canal runs.

The canal of Castile, projected and begun in the last reign, has been almost abandoned. It was to commence at Segovia, sixteen leagues north of Madrid, to follow the course of the Ereima, that falls into the Douro, and to be continued as far north as Reynosa; which is twenty leagues from St Ander, a sea port. At Reynosa is the communication with the canal of Aragon, that unites the Mediterranean to the bay of Biscay. Above Palencia, a branch goes westward through Rio-Seco and Benevento to Zamora; making the canal of Castile, in its whole extent 140 leagues; where it is completed, viz. between Reynosa and Rio-Seco, its width at top is 56 feet, at bottom 20, and nine in depth.

In 1784, a canal was planned, which, from the foot of the mountains of Guadarama near the Ecurial, should proceed southward to the Tagus; afterwards to the Guadiana, and terminate at the Guadalquivir above Andaxar. Some other attempts to improve the inland navigation of the country have been unsuccessful.

There is no nation in Europe which displays such a variety of national character as Spain. In no two provinces are the manners and character exactly alike. It is therefore difficult to collect traits on which to found the national character of the Spaniards; and this character has been variously represented by different writers. From the transactions which have lately taken place between that people and the British nation, we confess ourselves prejudiced against them; and we shall therefore, instead of sketching their character according to our own preconceived notions, endeavour to delineate it as concisely as possible from De Laborde, who is probably a sufficiently competent judge.

The national pride, says this author, is every where the same. The Spaniard has the highest opinion of his nation and himself, and this he expresses with energy, in his gestures, words, and actions. This opinion is discovered among all ranks in life, and all classes of society. Its result is a kind of haughtiness, sometimes repulsive to him who is its object, but useful in giving to the mind a sentiment of nobleness and self-esteem which fortifies it against all mannefs.

In later times the Spaniards have not degenerated from the value of their ancestors. The Spanish soldier is still one of the best in Europe, when placed under an experienced general, and brave and intelligent officers. He possesses a cool and steady valor; he long endures fatigue and hunger, and easily inures himself to labour.

The Spaniards are very reserved, and rather wait for,

Spain.

220
T and na
igation.227
Gen ral
character
of the
Spaniards

Spain. than court the advances of a stranger. Yet in spite of their apparent gravity, they possess an inward gaiety, which frequently shines out when proper occasions call it forth.

The Spaniard is very flow in all his operations; he often deliberates when he ought to act, and spoils affairs as much by temporising as the natives of other countries do by precipitation. This tardiness would be but a slight defect, did it not proceed from a serious radical want, from the invincible indolence and hatred of labour which prevails among all ranks of society.

That jealousy which was formerly proverbial among the Spaniards, is now greatly diminished; husbands are much less suspicious, and women much more accessible. Lattices have disappeared; duennas exist only in romances; veils are exchanged for mantelas; houses are thrown open, and the women have recovered a liberty by which they are less tempted to go astray than when their virtue was entrusted to locks and grates, and to the superintendance of guards often faithless and easily corrupted.

In fine, the Spaniards are sober, discreet, adroit, frank, patient in adversity, slow in decision, but wise in deliberation; ardent in enterprise, and constant in pursuit. They are attached to their religion, faithful to their king, hospitable, charitable, noble in their dealings, generous, liberal, magnificent; good friends, and full of honour. They are grave in carriage, serious in discourse, gentle and agreeable in conversation, and enemies to falsehood and evil speaking.

Such is the Spanish character as drawn by De Laborde. Its varieties in the several provinces are thus flated by the same author. The Old Castilians are silent, gloomy, and indolent, and are the most severely grave of all the Spaniards; but they possess a steady prudence, an admirable constancy under adversity, an elevation of soul, and an unalterable probity and uprightness. The character of the natives of New Castile is nearly the same, but more open, and less grave and taciturn. Inodocility and conceit make part of the character of the people of Navarre: they are distinguished by lightness and adroitness. The Biscayans are proud, impetuous, and irritable; abrupt in discourse and in action; haughty and independent, but industrious, diligent, faithful, hospitable, and sociable. The Galicians are gloomy, and live very little in society; but they are bold, courageous, laborious, very sober, and distinguished for their fidelity. The Asturias partake of the character of the Galicians and Biscayans; but they are less industrious than the former, less civilized, less sociable, less amiable, and more haughty than the latter. The people of Extremadura are proud, haughty, vain, serious, indolent; but remarkably sober, honourable, and much attached to their own province, which they seldom quit. The Murcians are lazy, listless, plotting, and suspicious; attached neither to sciences, arts, commerce, navigation, nor a military life. The Valencians are light, inconstant, and indelicate: gay, fond of pleasure, little attached to each other, and still less to strangers, but sensible, agreeable, and discreet. The Catalans are proud, haughty, violent in their passions, rude in discourse and in action, turbulent, untractable, and possess mostly a fond of independence: they are not particularly liberal, but active, industrious, and indefatigable; they are sailors, husbandmen, and builders, and resort to all corners of the world to seek their fortunes. They are

brave, insipid, sometimes rash, obstinate in adhering to their schemes, and often successful in vanquishing, by their steady perseverance, obstacles which would appear insurmountable to others.

The natives of almost every province have some distinguishing peculiarity in their dress, manners, and pursuits. Before the accession of the house of Bourbon to the throne, the usual dress of a Spanish nobleman consisted of a laced hat, a long black or brown cloak, short jerkin, and frait breeches, with a long Toledo sword; but French dresses are now introduced at court. The higher classes wear their hats under their arm. The common people wrap themselves up to the eyes in a brown cloak, called *alepa*, that reaches to the ground; and conceal their hair beneath a cotton cap, and a broad hat called a *zambra*. When a lady walks abroad, her head and upper part of her body are covered with a mantela; that is, a white or black veil, so that it is impossible the should be known. At home, the dress is a jacket and a petticoat of silk or cotton. The hair is generally a fine black; and powder is rare.

In romance, the ladies are celebrated for beauty, and some of them deserve that character; yet beauty is not their general character. They are of a tender make, but with great art they supply the defects of nature. By an indiscriminate use of paint, they disguise their complexion and smother their skin.

Several of the Spanish customs and habits, which seem ridiculous to foreigners, are gradually wearing out, and in process of time will no doubt be corrected. The higher classes at breakfast use chocolate, and seldom tea. Dinner generally consists of beef, veal, pork, mutton, and beans, boiled together. They are fond of garlic; and it is proverbial that olives, salad, and radishes, are food for gentlemen. The men drink little wine, and the women use water or chocolate. Both sexes sleep after dinner, and air themselves in the cool of the evening. Their repasts are composed of sweetmeats, biscuit, coffee and fruit, which servants distribute to the company; who keep their seats, and have little conversation.

Dancing and cards are favourite amusements. Theatrical exhibitions are generally insipid or ridiculous bombast, low wit, absurdity, and buffoonery. The combats of the cavaliers and bull fights, are almost peculiar to this country. On these occasions young gentlemen were used to show their courage to their mistresses; and were honoured and rewarded according to their success. But these exhibitions were lately concluded with greater economy and parsimony; and mercenary champions studied in the most secure and gradual manner to destroy the devoted animal. See *Bull-Fighting*.

The chief defect in all ranks is an aversion to labour and industry. The higher orders bestow no attention on agriculture and commerce; they reside for the most part at court and in the metropolis, reckoning it beneath their dignity to live in villas or their estates among their tenants. In their estimation, a labouring man quits the dignity of the Spanish character, and renders himself an object of contempt. Hence a little indolence prevails. Households waste their time in total want of every circumstance to action. Their intellects are never exercised, and their views and exertions are confined within the narrow sphere of mere existence. The country people have no encouragement to industry; and not a single

Spain.
Manners
at court.

222
Diversities
of character
in the
several pro-
vinces.

concern for the welfare of a country where a few overgrown families engross every thing valuable, and never think of the condition of their vassals. The indigent Spaniard does not bestir himself unless impelled by want, because he perceives no advantage to be derived from industry. A stranger to intemperance and excess, his society is easily procured; and under a climate so propitious, few clothes are required. The hovel which he occupies, together with all its contents, has a mean, filthy, despicable appearance; and all that relates to him bears the impression of wretchedness and misery *.

There are certain customs which may be regarded as peculiar to the Spaniards, or which at least are scarcely found in any other European country. The number of servants retained in the families of the higher ranks is prodigious; and even a tradesman's wife, in narrow circumstances, will frequently have four maid servants, though she cannot, with propriety, employ more than two. The houses of gentlemen, and especially of grandees, swarm with them; and, not unrequently, all the principal servants will have their wives and children lodged with them, and supported by their master. We have heard of one nobleman who was at the daily expence of 120*l.* merely for the maintenance of his numerous retainers.

The Spaniards are fond of meeting in the evening in parties, which are often very numerous. On these occasions, the ladies as they arrive place themselves in one room, and the gentlemen in another; or else the ladies range themselves in a line along the side of the room, the lady of the house always taking the lowest place next to the door, whilst the men remain standing, or seat themselves on the opposite side. They remain separated in this manner till the card parties are introduced. They play at *loo*, *loto*, and other games of a similar kind. These who do not play, either look on, or embrace the opportunity of chatting with the person most interesting to them. Others form little circles, where the conversation is usually very animated. These parties very much resemble the French evening, and the English rout.

A *refresco* sometimes makes part of these entertainments, but only on particular occasions, when the company is more than usually numerous. But oranges, lemonade, orangeade, ices of different kinds, sweetmeats, and biscuits, are distributed with uncommon profusion; and chocolate ends the *funcion*, as all these entertainments are called.

Many precautions are taken in Spain against the heat. The rooms are watered several times a-day, and the windows are shaded on the outside with awnings of cloth or ticking, or on the inside by large and full curtains. In some places, as at Valencia, the glass is taken out of the windows at the approach of summer, and the doors of the apartments are all set open.

The beds in Spain are hard, being made of mattresses, laid on paillasses, resting on a wooden bottom. The furniture of the houses is usually very simple, and the floors are covered with matting or printed cloth. The chairs have rush bottoms, and are usually of different heights, those for the ladies being one-third lower than those for the gentlemen.

Among the principal amusements of the Spaniards must be reckoned music and dancing. Though the Spaniard have no taste for music, they are by no means

proficients in that accomplishment. Their principal instrument is the guitar, which is in the hands of every body. Different provinces have also their peculiar instruments. Thus the Gallicians use a dull and heavy bagpipe; the Catalonians a large flageolet, and a little drum or tabor; and the Bilegians a short flute, with four holes. Catnettes are also extremely common, and are employed with great dexterity and address in the national dances.

The Spaniards are passionately fond of dancing, and they have certain dances which are peculiar to Spain. Of these the *fundango* is the most celebrated, and appears to be the most ancient. It is a very extraordinary dance, in which the whole body is thrown into a regular and harmonious convulsion, expressive of the most lascivious ideas.

The passion of the Spaniards for these dances is carried to a height which can scarcely be imagined. No sooner are the guitar and the singing to which they are danced heard in a ball room or theatre, than a murmur of delight arises on all sides; all faces become animated: the feet, hands, and eyes of all present are put in motion; it is impellible to describe the effect produced. Mr Townsend, an English traveller, affirms, that if a person were to come suddenly into a church or a court of justice playing the *fundango*, or the *cohero*, priests, judges, lawyers, criminals, audience, one and all, grave and gay, young or old, would quit their functions, forget all distinctions, and all set themselves a dancing.

The Spanish balls are directed by two persons chosen among the visitors, who are called *lasteneras*, and with the hat under the arm, and the cane in the hand, perform the office of masters of the ceremonies. One is for the gentlemen, the other for the ladies. It is their business to appoint who is to dance, whether minuets or country dances; they are in general very attentive to the observance of precedence and etiquette, and have usually the complaisance to contrive that those shall dance together to whom it is peculiarly agreeable to meet.

A singular custom is observed at these balls, which appears new and strange to a foreigner. The lady chosen to dance rises, crosses the room alone, and places herself where she is to begin dancing, without waiting for her partner to lead her out; and after the dance is over, her partner makes his bow to her again in the middle of the room without taking any further concern about her, or handing her back to her place. But this custom prevails only in the provinces.

The bull-fights noticed above were once not only a favourite but a fashionable spectacle in Spain. Every city, and almost every small town, had a place set apart for these darling combats; and either all ranks and ages resorted with the greatest avidity, and witnessed the proofs of the combatants, and the torture of the wretched animals, whom they were hired to butcher, with the most savage expressions of delight. These fights made a part of every festival, and, as soon as they were announced, the housewife left her family, the tradesman forsook his shop, the artist his work-room, the labourer his field, and joy and expectation were painted on every countenance. To the honour of the nation, these cruel sports are at length abolished, and Spain has thus set an example of humanity, which Britain, with all her civilization and refinement, need not blush to copy.

SPALATRO. See MEXICO.

SPALATRO, or SPALATRO, a rich, populous, and flourishing town of the republic of Venice, capital of Venetian Dalmatia, with a good harbour and an archbishop's see. Here are the ruins of the palace of Diocletian, of which the late Mr Robert Adam published in 1764 a splendid account, enriched with 71 folio plates. In 1784, Spalatro was nearly depopulated by the plague. It is strong by situation, being built on a peninsula, which is joined to terra firma by a neck of land half a mile over. It is seated on the gulf of Venice, 33 miles south-east of Sebenico, and 102 north-west of Ragusa. E. Long. 17. 31. N. Lat. 44. 4.

SPALLANZANI, LAZARUS, accelerated naturalist, was born at Scandiano, in the duchy of Modena, in January 1729. He began his studies in his native county, and went to Reggio de Modena at 15 years of age, to prosecute them further. He was intrusted in the *belles lettres* by the Jesuits, who contended with the Dominicans in order to secure his attachment; but his thirst for knowledge determined him to go to Bologna, where his relative Laura Balli, a woman highly celebrated for her genius, eloquence, and skill in natural philosophy and mathematics, was one of the most distinguished professors of the Institute of Italy. Under this enlightened guide, he was taught to prefer the study of nature to that of her commentators, judging of the real value of the commentary by its resemblance to the original. He availed himself of the wisdom of that lady's counsels, the happy effects of which he very soon experienced. Spallanzani's taste for philosophy was not exclusive, for he carefully studied his own language, became a proficient in the Latin tongue, and attached himself above every other to the Greek and French. By the advice of a father whom he ardently loved, he applied himself to jurisprudence; but being urged by Anthony Vallisneri to renounce his vocation, by procuring the consent of his father, he gave himself up to the study of mathematics with more zeal than ever, at the same time devoting himself to the study of languages, both living and dead.

It was not long before he was known all over Italy, and what is seldom the case, his own country did not but that value on his talents which they justly merited. He was chosen professor of logic, metaphysics and Greek, in the university of Reggio, in the year 1747, where he taught during ten years, devoting every moment of his leisure time to the study and contemplation of the works of nature. The attention of Haller and Bonnet was fixed by his observations on the similitude of insensations, the latter assisting him in his doubtless concern, and ever after distinguished him as one of the learned interpreters of nature.

Spallanzani was invited to the university of Modena in the year 1762, and some years after he declined to accept of the offers made to him by the academy of Petersburg, as well as similar ones from Coimbra, Parma, and Osnaburg, through extremely advantageous. He preferred his native town, and therefore continued at Modena till the year 1768, and was raised up by his care a large number of men contributing to the true glory of Italy, among whom we find Venturi, Bellini, Lucchesini, and Agostini Buzzo.

While Spallanzani resided at Modena, he published his *Saggio di Osservazioni Microscopiche concettive* Vol. XIX. Part II.

il Sistema di Needham e Buffon, in 1765, in which he establishes, by a number of the most ingenious and solid experiments, the *annuity of microscopic animals*. This work was sent by the author to Bonnet, who drew from it a prediction respecting the future celebrity of Spallanzani, which he lived to see accomplished. This circumstance gave birth to the most intimate friendship, which lasted to the close of life, and constituted their chief happiness. During the same year he published a truly original work, entitled *De Lapillibus ab aqua resistentibus*, in which he proves, in opposition to the commonly received opinion, by the most satisfactory experiments, that what are called *dicks* and *drabs*, are not produced by the elasticity of the water, but by the effect naturally resulting from the change of direction experienced by the stone in its motion, after it has struck the water, and that it has been considered over the hollow of the cup formed by the concussion.

When the university of Padua was re-established upon a larger scale, the Count de Firmian was directed by the empress Maria Theresia, to invite Spallanzani to be professor of natural history, to which his great reputation made him competent, although it was solicited by many celebrated characters; and he merited it by his success, as immense crowds of students thronged to his lectures. He had a fine genius, and his knowledge was of vast extent; his method was simple, but rigorous in its nature, and what he knew he connected with principles firmly established. He acquired the valuable art of interpreting nature by himself, which diffused such a light over his lectures, that every thing became perspicuous, which could be said to afford any instruction. His discourses were plain and animated, and the elegance and purity of his style charmed every hearer. He prepared his lectures a year before hand, and it was his chief aim to render them useful in an eminent degree. His new observations made them always new and engaging. Many learned persons who attended his lectures were not above becoming his scholars, in order to acquire a more extensive knowledge of what they knew before, and to learn that which otherwise they might probably never have known. The *Contemplation de la Nature* of Bonnet was his text book, the vacancies of which he ably filled up, fully explained the ideas, and established the theories by his own experiments. This work was translated by him into the Italian language, and he added much to its value by notes of his own, the first volume of which he published in 1769, and the second the following year.

His connection with Bonnet tended, in a great measure, to influence his genius, which yielded to the severe method of investigation adopted by the philosopher of Geneva. He was proud of being the pupil of such an illustrious character, upon whose writings he incessantly bestowed every day his thoughts, and thus became anxious to learn from Nature herself the proofs of Bonnet's foundations respecting the generation of organized bodies, the pleasing nature of which research captivated his attention for a considerable time.

The first two volumes of this work entitled *Opuscoli di Filosofia Naturale e Fisica*, were published in the year 1776, containing the calculation or part of the microscope's observations which were previously given to the world.

It must be admitted that the art of accurate obser-

tion is by far the most difficult, it cannot be denied that it is at the same time the most necessary, and requires the most brilliant talents and abilities, which were possessed by Spallanzani in a remarkable degree, as is fully evinced by all his researches and all his admirable writings.

In the same manner in which he conducted his dispute with Needham respecting the phenomena of generation, heaved for him a high degree of applause. On this occasion he treated of the influence of cold upon animals, and proved that the triplicity of some during winter does not depend on the impression the blood may receive from it. Once a frog deprived of blood, becomes rigid when reduced to the same cold state by being immersed in ice, and swims as formerly when restored to a proper degree of warmth.

Spallanzani travelled through Switzerland and the Grisons in the year 1779, after which he went to Geneva, spending a month with his friends, by whom his conversation was as much admired as his masterly writings. From this place he returned to Pavia, and in 1780 published two more volumes of his *Differtazione di Flogia Animale e Vegetabile*, wherein he unfolded the secrets of the interpretation of two very intricate phenomena, concerning the economy of animals and vegetables. He was led to this study from some experiments made by him upon *d'eggliori*, for his lectures; and he repeated the experiments of Beaurmur on gallinaceous birds, remarking that the titillation which in this case is requisite to digestion, could not be a very powerful means. He perceived that the gizzard of those birds, by which the fibres of fruit are pulverized, did not digest the powder thus formed, it being necessary that it should undergo a new operation in the stomach, previous to its becoming chyle for the production of the blood and other humours.

This subject may be regarded as one of the most difficult in physiology, because the observer is always under the necessity of acting and looking in the midst of darkness; the animal must be managed with care, that the derangement of the operations may be avoided; and when the experiments are completed with great labour, it is requisite that the comic penances he will distinguish. Spallanzani in this work is truly enchanting, analyzing facts with ferretility, in order to ascertain their causes, with exactness; comparing Nature with his experiments, in order to form a correct judgement respecting them; laying hold of every thing essential to them in his observations, and mediating their solidity by the increase or diminution of supposed causes.

Mr John Hunter appears to have been greatly hurt by this work, which led him to publish, in the year 1785, *Some Observations upon Digestion*, in which he threw out some bitter freedoms against the Italian naturalist, who took ample revenge by publishing this work in the Italian language, and addressing to Calaneo in 1788, *Una Lettera Anologica in R. Spella alle Osservazioni del Signor Giovanni Hunter*. In this he expressed with great moderation, but at the same time with logic which nothing could resist, the mistakes and errors of the British physiologist, leaving the power of a reply altogether hopeless.

The generation of animals and plants is treated of in the second volume of this last-mentioned work, in which he proves the pre-existence of germs to fecundation, by

experiments as satisfactory as surprising; shewing also the existence of tadpoles in the females of five different species of frogs, in salamanders, and toads, before their fecundation. He likewise accounts the success of some artificial fecundations upon the tadpoles of those five species, and even upon a quadruped.

In the year 1781, he took the advantage of the academical vacation, for the purpose of making a journey, in order to add to the cabinet of Pavia. He set out for Marseilles in the month of July that year, where he began a new history of the sea, which presented him with many new and curious facts on numerous genera of the natives of the ocean. He went also to Finale, Genoa, Massia, and Carrara, to make observations on the quarries of marble, held by statuarys in such estimation. He then returned to Spezza, and brought from thence to Pavia a vast number of fishes, which he deposited in the cabinet of that city, wholly collected by himself. With the same view and success he visited the coasts of Istria in 1782, and the Apennine mountains the subsequent year, taking notice of the dreadful hurricanes, and the astonishing vapours by which that year became so noted in meteorology. The emperor Joseph, on examining this cabinet presented Spallanzani with a gold medal. In 1785, he was offered the chair of natural history by the university of Padua, vacant by the death of Anthony Vallisiceni; but in order to prevent his acceptance of it, his salary was doubled by the archduke, and he went to Constantinople with Chevalier Zuliani, who had been appointed ambassador from the Venetian republic. He set out on the 21st of August, and reached the Turkish metropolis on the 11th of October, where he remained during eleven months. His attention was fixed by the physical and moral phenomena of this country, which were new even to Spallanzani. He traversed along the borders of the two seas, and ascended the mountains in the vicinity; he paid a visit to the island of Chalki, discovering to the Turks a copper mine, the existence of which they had never once conjectured. He discovered an iron mine not far from Constantinople, in the island of Principi, of which the Turks were equally ignorant, and prepared to return for Italy on the 16th of August 1786.

A voyage by sea was undoubtedly the safest, but the dangers to which he would be exposed by land were regarded as nothing when contrasted with the idea of being beneficial to science and to man. Having reached Bucharest, Mauroceni the friend of science, received Spallanzani with marks of distinction, presented him with many rarities which the country produced, and gave him horses for travelling, with an escort of 30 troopers, to the utmost confines of his own dominions. Our philosopher passed by Hermannstadt in Transylvania, and reached Vienna on the 7th of December, where he remained during five days, and had two long conferences with the emperor Joseph II. was much esteemed by the nobility of that city, and respectfully visited by many literary characters. When he arrived at Pavia, the students went out of the city gates to meet him, and testified their joy at his return by repeated acclamations. He was almost instantly drawn to the auditory, and compelled to ascend the chair from which he had been accustomed to deliver his fascinating lectures; but their demonstrations of joy and shouts of applause made him request of them to give over, and indulge him with

Spallan-
zani.

that repose in his own house which was now so absolutely necessary. His studies this year exceeded 500.

So extensive was the fame of Spallanzani become by this time, that envy was determined, it possible, to wound his reputation. If his discoveries were too new, solid, and original, to be successfully disputed, that vile passion, or rather *feud*, began to question his integrity and uprightness respecting the administration of the cabinet of Paris; but this iniquitous attempt to tarnish his honour, only made it shine forth with redoubled splendour. The juridical examination of the tribunals made his integrity appear even purer than before; and it must be mentioned to his honour, that he had the fortitude to forget this event; his enemies in general confessed their mistake, renounced their unprovoked animosity, and still hoped to regain a friendship or which they had proved themselves too unworthy.

In the voyage of Spallanzani we meet with what may be denominated a new volcanology. We are there instructed how to measure the intensity of volcanic fires, and in his analysis of the lava, almost to touch the particular gas which tears those torrents of stone in sulcus from the bowels of the earth, and raises them to the top of Mount Etna. This delightful work is clothed by some important enquiries into the nature of Svalows, the mildness of their dispositions, the rapidity of their flight, discussing the celebrated problem respecting their remaining torpid during the winter season, proving that artificial cold, much more intense than what is ever naturally experienced in our climate, does not reduce these birds to the torpid state.

Things apparently impossible were often discovered by Spallanzani. In the year 1795 he made one of his descriptions, which he gave to the world in his *Lectures sopra il sospetto d'un nuovo senso nei Pipistrelli*. In that work we are informed that bats, if deprived of sight, act with the same precision in every instance as those which have their eyes; that they flun in the same manner the most trivial obstacles, and also know where to fix themselves when their flight is terminated. Several philosophers confirmed these astonishing experiments, from which a suspicion arose, that these animals must have a new sense, as it appeared to Spallanzani that the other known senses could not compensate for the want of sight; but he was afterwards inclined to think, in consequence of Professor Jarine's experiments on the organ of hearing in bats, that in this particular instance the sense of hearing might possibly supply the want of sight.

The literary career of this celebrated naturalist was terminated by a letter to Gohert, entitled *Spra la pianca chiusa ne vidi una l'acqua e l'aria, e spesse a l'immediata lume solare e a l'ombra*. These numerous works, which met with the highest approbation, do not comprehend the whole of his multifarious labours; for the phenomena of respiration had occupied his attention a considerable time; their points of resemblance and dissimilitude in many species of animals; and he had nearly finished his voyage to Constantinople, as well as collected many valuable materials for the history of the sea, when his life and labours were unfortunately terminated.

He was seized with a retention of urine on the 4th of February 1790, and next morning was deprived of the regular use of his faculties, only enjoying a sound mind

during very short intervals. Tourdes and Professor Scarpa did every thing to save him, which could be produced by the joint exertions of genius, experience, and friendship, but in vain. He died on the 17th; but we know not what credit is due to the assertion, that he edified those around him during his last moments by his piety. Be that as it may, while his works exist to speak for themselves, impartial posterity will regard him as a very extraordinary man. These works have been translated into almost every European language, and he was admitted a member of the academies and learned societies of London, Stockholm, Göttingen, Holland, Lyons, Bologna, Turin, Padua, Mantua, and Geneva, and he received from Frederick the Great the diploma of member of the academy of Berlin.

SPAN, a measure taken from the space between the thumb and the tip of the little finger when both are stretched out. The span is estimated at three hand's breadths or nine inches.

SPANDELLI, the solid work on each haunch of an arch, to keep it from spreading.

SPANHEIM, EZEKIEL, a learned writer in the 17th century, was born at Gerwen in 1629; and in 1642 went to Leyden to study. Here he distinguished himself to great advantage; and his reputation spreading, Charles Louis elector palatine sent for him to be tutor to his only son. This task our author discharged to the entire satisfaction of the elector; by whom he was also employed in divers negotiations at foreign courts. He afterwards entered into the service of the elector of Brandenburg, who in 1680 sent him envoy extraordinary to the court of France, and soon after made him a minister of state. After the peace of Ryswick, he was again sent on an embassy to France where he continued from the year 1697 to 1722. The elector of Brandenburg having during that interval assumed the title of *King of Prussia*, conferred on him the title and dignity of a baron. In 1702 he left France; and went ambassador to England, where he had been several times. Here he died in 1710, aged 81 years. It is surprising, that in discharging the duties of a public minister with so much exertions, and amidst so many different journeys, he could find time enough to write the several books published by him. It may be said of him, that he acquitted himself in his negotiations like a person who had nothing else in his thoughts; and that he wrote like a man who had spent his whole time in his study. The principal of his works are, 1. *De praesentia et usu nuptiarum antiquorum*; the best edition of which is in two volumes folio. 2. Several letters or dissertations on scarce and curious medals. 3. A preface and notes to the edition of the emperor Julian's works, printed at Leipzig in 1696, folio.

SPANIEL, in *Zoology*. See CANIS, MAMMALIA, *Index*.

SPAR, in *Mineralogy*, a name given chiefly to some of the crystallized combinations of lime, as the carbonate and the fluate; the former being called simply *lime spar*, the latter fluor spar, or Derbyshire spar, from the name of the place where it is found in greatest abundance. See MINERALOGY.

SPARGANIUM, BUR-KELD, a genus of plants belonging to the class of monarxia, and to the order of triandria; and in the natural system ranged under the 3d order, *Calamariae*. See BOTANY *Index*.

Spallan-
zani.Spallan-
zani.

Sparta. should all sup together with Plato, with one accord they fet up a shout of joy, as if they had been invited to a banquet.

Xerxes, after pouring out a libation at the rising of the sun, began to move with the whole body of his army, as he had been advised by Epistates. Upon their approach, Leonidas advanced to the broadest part of the passage, and fell upon the enemy with such undaunted courage and resolution, that the Persian officers were obliged to stand behind the divisions they commanded, in order to prevent the flight of their men. Great numbers of the enemy falling into the sea, were drowned; others were trampled under foot by their own men, and a great many killed by the Greeks; who knowing they could not avoid death upon the arrival of those who were advancing to fall upon their rear, exerted their utmost efforts. In this action fell the brave Leonidas; which Abrocomes and Hyperanthes, two of the brothers of Xerxes, observing, advanced with great resolution to seize his body, and carry it in triumph to Xerxes. But the Lacedæmonians, more eager to defend it than their own lives, repelled the enemy four times, killed both the brothers of Xerxes, with many other commanders of distinction, and refused the body of their beloved general out of the enemy's hands. But in the mean time, the army that was led by the treacherous Epistates, advancing to attack their rear, they retired to the narrowest piece of the passage, and drawing all together except the Thebans, posted themselves on a rising ground. In this place they made head against the Persians, who poured in upon them on all sides, till at length, not vanquished, but oppressed and overwhelmed by numbers, they all fell, except one who escaped to Sparta, where he was treated as a coward and traitor to his country; but afterwards made a glorious reputation in the battle of Plataea, where he distinguished himself in an extraordinary manner. Some time after, a magnificent monument was erected at Thermopylae, in honour of those brave defenders of Greece, with two inscriptions; the one general, and relating to all those who died on this occasion, importing, that the Greeks of Peloponnesus, to the number only of 4000, made head against the Persian army, consisting of 3000000. The other related to the Spartans in particular, and was composed by the poet Simonides, to this purport: "Go, passenger, and acquaint the Spartans that we died here in obedience to their just command." At those tombs a funeral oration was yearly pronounced in honour of the dead heroes, and public games performed with great solemnity, wherein none but the Lacedæmonians and Thebians had any share, to show that they alone were concerned in the glorious defence of Thermopylae.

At the end of the 27th Olympiad, a most dreadful earthquake happened at Sparta, in which, according to Diodorus, 22,000 persons lost their lives; and Plutarch tells us, that only five houses were left standing in the whole city. On this occasion the Helotes or slaves, whom the Spartans had all along treated with the utmost cruelty, attempted to seize themselves, by taking up arms, and marching directly to the ruins of the city, in hopes of finding ease to some of those who had escaped from the earthquake. But in this they were prevented, with the assistance of the Spartan king Areolaudas. He lay, and told the citizens were more affected with grief by their effects than taking care of

their own lives, caused an alarm to be sounded, as if he had known that an enemy was at hand. On this the citizens armed themselves in haste with such weapons as they could come at; and having marched a little way from the city, met the Helotes, whom they found compelled to retire. The latter, however, knowing that they had now no mercy to expect from those who had already treated them with such cruelty, resolved to defend themselves to the last. Having therefore seized a sea-port town in Messenia, they from thence made such incursions into the Spartan territories, that they compelled those imperious masters to ask assistance from the Athenians. This was immediately granted; but when the Spartans saw that the skill of the Athenians in besieging towns was much greater than their own, they became jealous, and dismissed their allies, telling them, that they had now no farther occasion for their services. On this the Athenians left them in disgust; and as the Helotes and Messenians did not choose to come to an engagement with a Spartan army in the field, but took shelter in their fortified places, the war was protracted for ten years and upwards. At last the Helotes were reduced to their former misery; and the Messenians were obliged to leave Peloponnesus, on pain of being made slaves also. These poor people were then received by the Athenians, who granted them Naupactus for their residence, and afterwards brought them back to a part of their own country, from whence in the course of the Peloponnesian war they had driven the Spartans.

In the year 431 B. C. the Peloponnesian war commenced; of which a full account has been given under the article ATHENS, N^o 116—165. It ended most unfortunately for the Athenians; their city being taken and dismantled, as related in the article above mentioned. Thus were the Spartans raised to the highest pitch of glory; and, in the reign of Agellus, they seemed to be on the point of overthrowing the Persian empire, as related under the article PERSIA, N^o 24. But here their good fortune and their views of empire were suddenly checked. Agellus had carried on the war in Asia with the greatest success; and as he would be taken to no terms of accommodation, a Persian governor named *Tiphobates*, having first attempted in vain to bribe the king, dispatched Timocraes the Rhodian with 50 talents into Greece, in order to try whether he could there meet with any persons less incorruptible than the Spartan monarch. This agent found many who offered to accept his offers; particularly in Thebes, Corinth, and Argos. By distributing the money in a proper manner, he influenced the inhabitants of these three cities against the Spartans; and of all others the Thebans came into his terms with the greatest readiness. They few that their ancestors would not of their own accord, seek with any of the states of Greece, and did not chuse to begin the war themselves, because the cities of the Persian faction were unwilling to be accountable for the event. For this reason they persuaded the Locrians to invade a small district which lay in dispute betwixt the Thebans and themselves. On this the Thebans invaded Locris; the Locrians applied to the Thebans, and the Persians to the Spartans. The Locrians are glad of an opportunity of breaking with the Thebans; but not with a much warmer disposition than they expected. Their old general *Leotides* had

5
Leonidas
killed with
all his men.

Sparta.
7
The Helotes.

6
A general
of Sparta.

A general
of Sparta.

¹⁰ *Sparta.* reduced Athens, was defeated and killed, with the loss of 12000 men: on which disaster Agefilus was recalled, and obliged to relinquish all hopes of conquering the Persians. His return changed the fortune of the war so much, that all the states began to grow weary of a contest from which nobody derived any advantage except the king of Persia. In a short time a treaty was concluded, known in history by the name of the *peace of Antalcidas*. The terms of this treaty were highly disadvantageous and dishonourable to the Greeks; for even the Spartans, though successful in Greece, had lost a great battle at sea with the Persian fleet under Conon the Athenian, which entirely broke their power in Asia.

By the peace of Antalcidas, the government of Bœotia was taken from the Thebans, which they had for a long time enjoyed; and by this they were so much provoked, that at first they absolutely refused to accede to the treaty; but as Agefilus made great preparations to invade them, they thought proper at last to comply. However, it was not long before a new war commenced, which threatened the total subversion of the Spartan state. As, by the peace of Antalcidas, the king of Persia had in a manner guaranteed the sovereignty of Greece to Sparta, this republic very soon began to exercise its power to the utmost extent. The Mantinians were the first who felt the weight of their resentment, although they had been their allies and confederates. In order to have a pretence for making war against them, they commanded them to quit their city, and to retire into five old villages which, they said, had served their forefathers, and where they would live in peace themselves, and give no umbrage to their neighbours. This being refused, an army was sent against them to besiege their city. The siege was continued through the summer with very little success on the part of the Spartans; but having during the winter season dammed up the river on which the city stood, the water rose to such a height, as either to overflow or throw down the houses; which compelled the Mantinians to submit to the terms prescribed to them, and to retire into the old villages. The Spartan vengeance fell next on the Peloponnesians and Olynthians, whom they forced to come into such measures as they thought proper. After this they fell on the Thebans, and, by attempting to seize on the Piræum, drew the Athenians also into the quarrel. But here their career was stopped: the Thebans had been taught the art of war by Chæribias the Athenian; so that even Agefilus himself took the command of the Spartan army in vain. At sea they were defeated by Timotheus the son of Conon; and by land the battle of Leuctra put an end to the superiority which SPARTA had held over Greece for near 500 years.

SE LUCITRA.

After this dreadful defeat, the Spartans had occasion to exert all their courage and resolution. The women and nearest relations of those who were killed in battle, instead of spending their time in lamentations, took each other by the hand, while the relations of those who had escaped from the battle hid themselves among the women; or if they were obliged to go abroad, they appeared in tattered clothes, with their arms folded, and their eyes fixed on the ground. It was a law among the Spartans, that such as fled from battle should be degraded from their honours, should be constrained to ap-

Sparta. pear in garments patched with divers colours, to wear their beards half-shaved, and to suffer any to beat them who pleaded, without resistance. At present, however, this law was dispensed with; and Agefilus by his prudent conduct kept up the spirits of the people, at the same time that by his skill in military affairs he checked the progress of the enemy. Yet, during the lifetime of Epaminondas the Theban general, the war went on equally to the disadvantage of the Spartans; but he being killed at the battle of Mantinea, all parties became quickly desirous of peace. Agefilus did not long survive; and with him, we may say, perished the glory of Sparta. Soon after this all the states of Greece fell under the power of Alexander the Great; and the Spartans, as well as the rest, having become corrupt, and lost their martial spirit, became a prey to domestic tyrants, and to foreign invaders. They maintained their ground, however, with great resolution against the celebrated Pyrrhus king of Epirus; whom they repulsed for three days successively, though not without assistance from one of the captains of Antigonus. Soon after this, one of the kings of Sparta named *Agis*, perceiving the universal degeneracy that had taken place, made an attempt to restore the laws and discipline of Lycurgus, by which he supposed the state would be restored to its former glory. But though at first he met with some appearance of success, he was in a short time tried and condemned by the ephori as a traitor to his country. Cleomenes, however, who ascended the throne in 216 B. C. accomplished the reformation which Agis had attempted in vain. He suppressed the ephori; cancelled all debts; divided the lands equally, as they had been in the time of Lycurgus; and put an end to the luxury which prevailed among the citizens. But at last he was overborne by the number of enemies which surrounded him; and being defeated in battle by Antigonus, he fled to Egypt, where he put an end to his own life. With him perished every hope of retrieving the affairs of Sparta: the city for the present fell into the hands of Antigonus; after which a succession of tyrants took place; till at last all disturbances were ended by the Romans, who reduced MACEDON and GRECE to provinces of their empire, as has been related under these articles.

It remains now only to say something concerning the character, manners, and customs of the Spartans, which, as they were founded on the laws of Lycurgus, may best be learned from a view of these laws.

The institutions of Lycurgus were divided into tables. The first comprehended such of the Spartan laws as regarded religion. The statues of all the gods and goddesses were represented in armour, even to Venus herself; the reason of which was, that the people might conceive a military life the most noble and honourable, and not attribute, as other nations did, sloth and luxury to the gods. As to sacrifices, they consisted of things of very small value; for which Lycurgus himself gave this reason, That want might never hinder them from worshipping the gods. They were forbidden to make long or rash prayers to the heavenly powers, and were enjoined to ask no more than that they might live honestly and discharge their duty. Graves were permitted to be made within the bounds of the city, contrary to the custom of most of the Greek nations; nay, they buried close by their temples, that all degrees

^{Sparta.} of people might be made familiar with death, and not conceive it such a dreadful thing as it was generally esteemed elsewhere: on the same account, the touching dead bodies, or assisting at funerals, made none unclean, but were held to be as innocent and honourable duties as any other. There was nothing thrown into the grave with the dead body; magnificent sepulchres were forbidden; neither was there so much as an inscription, however plain or modest. Tears, sighs, outcries, were not allowed in public, because they were thought dishonourable in Spartans, whom their lawgiver would have to bear all things with equanimity. Mourning was limited to 11 days; on the 12th the mourner sacrificed to Ceres, and threw aside his weeds. In favour of such as were slain in the wars, however, and of women who devoted themselves to a religious life, there was an exception allowed as to the rules before mentioned; for such had a short and decent inscription on their tombs. When a number of Spartans fell in battle, at a distance from their country, many of them were buried together under one common tomb; but if they fell on the frontiers of their own Rate, then their bodies were carefully carried back to Sparta, and interred in their family sepulchres.

¹⁵
concerning
the division
of land.

II. Lycurgus divided all the country of Laecodia into 30,000 equal shares: the city of Sparta he divided into 9,000, as some say; into 6,000, as others say; and as a third party will have it, into 3,000. The intent of the legislator was, that property should be equally divided among his citizens, so that none might be powerful enough to oppress his fellows, or any be in such recidity, as to be therefrom in danger of corruption. With the same view he forbade the buying or selling these possessions. If a stranger acquired a right to any of these shares, he might quietly enjoy it, provided he submitted to the laws of the republic. The city of Sparta was unwall'd; Lycurgus trusting it rather to the virtue of its citizens than to the art of masons. As to the houses, they were very plain; for their ceilings could only be wrought by the axe, and their gates and doors only by the saw; and their utensils were to be of a like plainness, that luxury might have no instruments among them.

¹⁷
of the citi-
zens, children,
&c.

III. The citizens were to be neither more nor less than the number of city lots; and if at any time there happened to be more, they were to be led out in colonies. As to children, their laws were equally harsh and unreasonable; for a father was directed to carry his new-born infant to a certain place, where the gravest men of his tribe looked upon the infant; and if they perceived its limbs straight, and thought it had a wholesome look, they then returned it to its parents to be educated; otherwise it was thrown into a deep cavern at the foot of the mountain Taygetus. This law seems to have had one very good effect, viz. making women very careful, when they were with child, of either eating, drinking, or exercising, to excess: it made them also excellent nurses; for which they were in mighty request throughout Greece. Strangers were not allowed to reside long in the city, that they might not corrupt the Spartans by teaching them new customs. Citizens were also forbidden to travel, for the same reason, unless the good of the Rate required it. Such as were not bred up in their youth according to the law, were not allowed the liberty of the city; be-

cause they held it unreasonable, that one who had not submitted to the laws in his youth should receive the benefit of them when a man. They never preferred any stranger to a public office; but if at any time they had occasion for a person not born a Spartan, they first made him a citizen, and then preferred him.

IV. Celibacy in men was intamous, and punished in a most extraordinary manner; for the old bachelor was constrained to walk naked, in the depth of winter, through the market place; while he did this, he was obliged to sing a sang in disparagement of himself; and he had none of the honours paid him which otherwise belonged to old age, it being held unreasonable, that the youth should venerate him who was refused to leave none of his progeny behind him, to revive them when they grew old in their turn. The time of marriage was also fixed; and if a man did not marry when he was of full age, he was liable to an action; as were such also a man who abate or below themselves. Such as had three children had great immunities; such as had four were free from all taxes whatsoever. Virgins were married without portions; because neither want should hinder a man, nor riches induce him, to marry contrary to his inclinations. When a marriage was agreed on, the husband committed a kind of rape upon his bride. Husbands went for a long time, secretly and by stealth, to the beds of their wives, that their love might not be quickly and easily extinguished. Husbands were allowed to lend their wives; but the kings were forbidden to take this liberty. Some other laws of the like nature there were, which as they were evidently against modesty, so they were far from producing the end for which Lycurgus designed them; since, though the men of Sparta were generally remarkable for their virtue, the Spartan women were as generally decried for their boldness and contempt of decency.

V. It was the care of Lycurgus, that, from their very birth, the Laecodemians should be inured to conquer their appetites; for this reason he directed, that nurses should accustom their children to spare meals, and now and then to fasting; that they should carry them, when 12 or 13 years old, to those who should examine their education, and who should carefully observe whether they were able to be in the dark alone, and whether they had got over all other follies and weaknesses incident to children. He directed, that children of all ranks should be brought up in the same way; and that none should be more favoured in food than another, that they might not, even in their infancy, perceive any difference between poverty and riches, but consider each other as equals, and even as brethren, to whom the same portions were assigned, and who, through the course of their lives, were to fare alike: the youths alone were allowed to eat flesh; older men ate their black broth and pulse; the lads slept together in chambers, and after a manner somewhat resembling that still in use in Turkey for the Janizaries; their beds, in the summer, were very hard, being composed of the reeds plucked by the hand from the banks of the Eurotas; in winter their beds were softer, but by no means downy, or fit to indulge immoderate sleep. They ate altogether in public; and in case any abstinence from coming to the tables, they were fined. It was likewise strictly forbidden for any to eat or drink at home before they came to the common meal: even then

each had his proper portion, that every thing might be done there with gravity and decency. The black broth was the great rarity of the Spartans, which was composed of salt, vinegar, blood, &c. so that, in our times, it would be esteemed a very unwholesome soup. If they were moderate in their eating, they were so in their drinking also; thirst was the true measure thereof; and never any Lacedæmonian thought of drinking for pleasure: as for amusements, it was both infamous and severely punished; and, that young men might perceive the reason, slaves were compelled to drink to excess, that the beastliness of the vice might appear. When they retired from the public mirth, they were not allowed any torches or lights, because it was expected, that men who were perfectly sober should be able to find their way in the dark: and, besides, it gave them a facility of marching without light; a thing wonderfully useful to them in time of war.

VI. As the poor ate as well as the rich, so the rich could war nothing better than the poor: they neither changed their fashion nor the materials of their garments; they were made for warmth and strength, not for gallantry and show: and to this custom even their kings conform'd, who wore nothing gaudy in right of their dignity, but were contented that their virtue should distinguish them rather than their clothes. The youths wore a tunic till they were twelve years old; afterwards they had a cloak given them, which was to serve them a year: and their clothing was, in general, so thin, that a Lacedæmonian vest became proverbial. Boys were always us'd to go without shoes; but when they grew up, they were indulg'd with them, in the manner of life they led required it; but they were always inured to run without them, as also to climb up and slip down steep places with bare feet: nay, the very shoe they us'd was of a particular form, plain and strong. Boys were not permitted to wear their hair; but when they arriv'd at the age of twenty, they suffer'd their hair and beard to grow. Baths and anointing were not much in use among the Lacedæmonians; the river Eurotas supplied the former, and exercise the latter. In the field, however, their sumptuary laws did not take place so strictly as in the city; for when they went to war, they wore purple habits; they put on crowns when they were about to engage the enemy; they had also rings, but they were plain; which metal was most esteemed by this nation. Young women wore their veils or jerkins only to their knees, or, as some think, not quite so low; a custom which both Greek and Roman authors censure as indecent. Gold, precious stones, and other costly ornaments, were permitted only to common women; which permission was the strongest prohibition to women of virtue, or who affect'd to be thought virtuous. Virgins went abroad without veils, with which married women, on the contrary, were always covered. In certain public exercises, in which girls were admitted as well as boys, they were both oblig'd to perform naked. Plutarch apologises for this custom, saying, that there could be no danger from nakedness to the morals of youth whose minds were firm'd and habituated to virtue. One of Lyncurgus's principal views in his institutions, was to eradicate the very seeds of civil dissension in his republic. Hence proceeded the equal division of estates enjoined by him; before the contempt of wealth, and the neglect

of other distinctions, as particularly birth, he considering the people of his whole state as one great family; distinctions which, in other commonwealths, frequently produce tumults and confusions that shake their very foundation.

VII. Though the Spartans were always free, yet it was with their restriction, that they were subjeet to their own laws, which bound them as strictly in the city as soldiers, in other states, were bound by the rules of war in the camp. In the first place, strict obedience to their superiors was the great thing required in Sparta. This they looked upon as the very basis of government; without which neither laws nor magistracies availed much. Old age was an indubitable title to honour in Sparta: to the old men the youth rose up whenever they came into any public place; they gave way to them when they met them in the streets, and were silent whenever their elders spake. As all children were looked upon as the children of the state, so all the old men had the authority of parents; they reprehended whatever they saw amiss, not only in their own, but in other people's children: and by this method Lyncurgus provided, that as youth are everywhere apt to offend, they might be nowhere without a monitor. The laws went still further: if an old man was present where a young one committed a fault, and did not reprove him, he was punished equally with the delinquent. Amongst the youths there was one of their own body, or at most two years older than the rest, who was stiled *iron*: he had authority to question all their actions, to look strictly to their behaviour, and to punish them if they did amiss; neither were their punishments light, but, on the contrary, very severe; whereby the youth were made hardy, and accustomed to bear stripes and rough usage. Silence was a thing highly commended at Sparta, where modesty was held to be a most becoming virtue in young people; nor was it restrain'd only to their words and actions, but to their very looks and gestures; Lyncurgus having particularly directed, that they should look forward, or on the ground, and that they should always keep their hands within their robes. A stupid inconsiderate person, one who would not listen to instruction, but was careless of whatever the world might say of him, the Lacedæmonians treated as a scandal to human nature; with such a one they would not converse, but threw him off as a rotten-branch and worthless member of society.

VIII. The plainness of their manners, and their being so very much addicted to war, made the Lacedæmonians less fond of the sciences than the rest of the Greeks. A soldier was the only reputable profession in Sparta; a mechanic or husbandman was thought a low fellow. The reason of this was, that they imagin'd professions which required much labour, some constant posture, being continually in the house, or always about a fire, weakened the body and depress'd the mind: whereas a man brought up hardily, was equally fit to attend the service of the republic in time of peace, and to fight its battles when engag'd in war. Such occupations as were necessary to be followed for the benefit of the whole, as husbandry, agriculture, and the like, were left to their slaves the Helotes; but for curious arts, and such as served only to luxury, they would not so much as suffer them to be introduced in their city; in consequence of which, rhetoricians, augurs,

Sparta.

gurs, bankers, and dealers in money, were shut out. The Spartans admitted not any of the theatrical diversions among them; they would not bear the representation of evil even to produce good; but other kinds of poetry were admitted, provided the magistrates had the perusal of pieces before they were handed to the public.

Above all things, they affected brevity of speech, and accustom'd their children, from their very infancy, never to express themselves in more words than were strictly necessary; whence a concise and sententious oratory is to this day styled *Laconic*. In writing they used the same conciseness; of which we have a signal instance in a letter of Archidamus to the Eleans, when he understood that they had some thoughts of assisting the Arcadians. It ran thus: "Archidamus to the Eleans: It is good to be quiet." And therefore Epaminondas thought that he had reason to glory in having forced the Spartans to abandon their monosyllables, and to lengthen their discourses.

The greatest part of their education consisted in giving their youth right ideas of men and things: the iron or maul propos'd questions, and either commended the answers that were made him, or reproved such as answered weakly. In these questions, all matters, either of a trivial or abstruse nature, were equally avoided; and they were confined to such points as were of the highest importance in civil life; such as, Who was the best man in the city? wherein lay the merit of such an action? and, Whether this or that hero's fame was well-founded? Harmless rallery was greatly encouraged; and this, join'd to their short manner of speaking, rendered laconic replies universally admired.

Music was much encouraged; but in this, as in other things, they adhered to that which had been in favour with their ancestors; nay, they were so strict therein, that they would not permit their slaves to learn either the tune or the words of their most admired odes; or, which is all one, they would not permit them to sing them if they had learned them. Though the youth of the male sex were much cherish'd and beloved, as those that were to build up and continue the future glory of the state, yet in Sparta it was a virtuous and modest affection, untinged with that sensuality which was so scandalous at Athens. The good effects of this part of Lycurgus's institutions were seen in the union that reigned among his citizens; and which was so extraordinary, that even in cases of competition, it was hardly known that rivals bore ill-will to each other; but, on the contrary, their love to the same person begat a secondary friendship among themselves, and united them in all things which might be for the benefit of the person beloved.

Some authors have accus'd this great lawgiver of encouraging theft in his institutions; which, they say, was not held scandalous among the Spartans, if it were so dexterously managed as that the person was not detected in it. But this is certain, and seems to be a strong contradiction of the heinous charge, that when a theft was discovered, it was punished with the utmost severity: a person even suspected of it would endure the heaviest punishments rather than acknowledge it, and be branded with so base a crime.

IX. The exercises instituted by law fall under the ninth table. In these all the Greeks were extremely
VOL. XIX. Part II.

careful, but the Lacedaemonians in a degree beyond the rest: for if a youth, by his corpulence, or any other means, became unfit for these exercises, he underwent public contempt at least, if not banishment.—Hunting was the usual diversion of their children; nay, it was made a part of their education, because it had a tendency to strengthen their limbs, and to render those who practis'd it supple and fleet. They likewise bred up dogs for hunting with great care. They had a kind of public dances, in which they exceedingly delighted, and which were common alike to virgins and young men: indeed, in all their sports, girls were allowed to divert themselves with the youth: inso much, that, at darting, throwing the quoit, pitching the bar, and such like robust diversions, the women were as dexterous as the men. For the manifest oddity of this proceeding, Lycurgus assigned no other reason, than that he sought to render women, as well as men, strong and healthy, that the children they brought forth might be so too. Violent exercises, and a laborious kind of life, were only enjoined the youth; for when they were grown up to men's estate, that is, were upwards of 30 years old, they were exempted from all kinds of labour, and employ'd themselves wholly either in affairs of state or in war. They had a method of whipping, at a certain time, young men in the temple of Diana, and about her altar; which, however palliated, was certainly unnatural and cruel. It was esteem'd a great honour to sustain these flagellations without weeping, groaning, or showing any sense of pain; and the thirst of glory was so strong in these young minds, that they very frequently suffered death without heeding a tear or breathing a sigh. A desire of overcoming all the weaknesses of human nature, and thereby rendering his Spartans not only superior to their neighbours, but to their species, runs through many of the institutions of Lycurgus; which principle, if well attended to, thoroughly explains them, and without attending to which it is impossible to give any account of them at all.

X. Gold and silver were, by the constitutions of Lycurgus, made of no value in Sparta. He was so well apprized of the danger of riches, that he made the very possession of them venal; but as there was no living without some sort of money, that is, some common measure or standard of the worth of things, he directed an iron coinage, whereby the Spartans were supplied with the useful money, and at the same time had no temptation to covetousness afford'd them; for a very small sum was sufficient to load a couple of horses, and a great one might have been kept in a barn or warehouse. The introduction of all foreign money was also prohibited, that corruption might not enter under the name of commerce. The most ancient method of dealing, viz. by barter, or exchange of one commodity for another, was preserv'd by law in Sparta long after it had gone into disuse everywhere else. Interest was a thing forbidden in the Spartan commonwealth; where they had also a law against alienation of lands, accepting presents from foreigners, even without the limits of their own country, and when their authority and character might well seem to excuse them.

XI. Such of the laws of Sparta as related to courts of justice may be brought under the 11th table. Thirty years must have pass'd over the head of him who had a right to concern himself in juridical proceedings.

23

Exercises.

Sparta.

25

Court of
justice.

Sparta.

Young men were thought unfit for them; and it was even held indecent, and of ill report, for a man to have any fondness for law-suits, or to be buying himself at the tribunals, when he had no affairs there of his own. By these rules Lycurgus thought to shut out litigiousness, and to prevent that multiplicity of suits which is always scandalous in a state. As young people were not permitted to inquire about the laws of other countries, and as they were hindered from hearing judicial proceedings in their courts, so they were likewise forbidden to ask any questions about, or to endeavour to discover, the reasons of the laws by which themselves were governed. Obedience was their duty; and to that alone they would have them kept. Men of abandoned characters, or who were notoriously of ill fame, lost all right of giving their votes in respect of public affairs, or of speaking in public assemblies; for they would not believe that an ill man in private life could mean his country better than he did his neighbour.

26
Military
Service.

XII. Till a man was 30 years old, he was not capable of serving in the army, as the best authors agree; though some think that the military age is not well ascertained by ancient writers. They were forbidden to march at any time before the full-moon; the reason of which law is very hard to be discovered, if indeed it had any reason at all, or was not rather founded on some superstitious opinion, that this was a more lucky conjuncture than any other. They were likewise forbidden to fight often against the same enemy; which was one of the wisest maxims in the political system of Lycurgus: and Agellus, by offending against it, destroyed the power of his country, and lost her that authority which for many ages she maintained over the rest of Greece; for, by continually warring against the Thebans, to whom he had an inveterate hatred, he at last beat them into the knowledge of the art of war, and enabled them, under the command of Epaminondas, to maintain for a time the principality of Greece. Maritime affairs they were forbidden to meddle with, though the necessity of things compelled them, in process of time, to transgress this institution, and by degrees to transfer to themselves the dominion of the sea as well as of the land: but, after the Peloponnesian war, they again neglected naval affairs from a persuasion that sailors and strangers corrupted those with whom they conversed. As they never fortified Sparta, they were not ready to undertake sieges: fighting in the field was their proper province, and, while they could overcome their enemies there, they rightly conceived that nothing could hurt them at home. In time of war they relaxed somewhat of their strict manner of living, in which they were singular. The true reason for this was, in all probability, that war might be less burdensome to them; for, as we have more than once observed, a strong desire to render them bold and warlike was the reigning passion of their legislator. They were forbidden to remain long encamped in the same place, as well to hinder their being surpris'd, as that they might be more troublesome to their enemies, by waiting every corner of their country. They slept all night in their armour; but their outwards were not allowed their shields, that, being unprovided of defence, they might not dare to sleep. In all expeditions they were careful in the performance of religious rites; and,

after their evening meal was over, the soldiers sung together hymns to their gods. When they were about to engage, the king sacrificed to the muses, that, by their assistance, they might be enabled to perform deeds worthy of being recorded to latest times. Then the army advanced in order to the sound of flutes, which played the hymn of Calliope. The king himself sung the psalm, which was the signal to charge. This was done with all the solemnity imaginable; and the soldiers were sure either to conquer or die: indeed they had no other choice; for if they fled they were infamous, and in danger of being slain, even by their own mothers, for disgracing their families. In this consisted all the excellency of the Spartan women, who, if possible, exceeded in bravery the men, never lamenting over husbands or sons, if they died honourably in the field; but deploring the shame brought on their house, if either the one or the other escaped by flight. The throwing away a shield also induced infamy; and, with respect to this, mothers, when they embraced their departing sons, were wont to caution them, that they should either return armed as they were, or be brought back so when they were dead; for, as we have observed, such as were slain in battle were neverthelike buried in their own country. When they made their enemies fly, they pursued no longer than till victory was certain; because they would seem to fight rather for the honour of conquering, than of putting their enemies to death. According to their excellent rules of war, they were bound not to spoil the dead bodies of their enemies; but in process of time, this, and indeed many other of their most excellent regulations, fell into desuetude. He who overcame by stratagem, offered up an ox to Mars; whereas he who conquered by force, offered up only a cock; the former being esteemed more manly than the latter. After 40 years service, a man was, by law, no longer required to go into the field; and consequently, if the military age was 30, the Spartans were not held invalids till they were 70.

SPARTIANUS, ÆLIUS, a Latin historian, who wrote the lives of Adrian, Caracalla, and four other Roman emperors. He lived under the reign of Diocletian, about the year 290.

SPARTIUM, BROOM, a genus of plants belonging to the class of diadelphia, and order of decandria; and in the natural system arranged under the 32d order, *Papilionaceæ*. See BOTANY Index.

The flower buds are in some countries pickled, and eaten as capers; and the seeds have been used as a bad substitute for coffee. The branches are used for making beloms, and tanning leather. They are also used instead of thatch to cover houses. The old wood furnishes the cabinet-maker with beautiful materials for veneering. The tender branches are in some places mixed with hops for brewing, and the macerated bark may be manufactured into cloth.

The *juncea*, or Spanish broom, grows naturally in the southern provinces of France, as well as in other parts of the south of Europe. It grows in the poorest soils, on the steepest declivities of the hills, in a stony soil, where hardly any other plant could vegetate. In a few years it makes a vigorous shrub; insinuating its roots between the interstices of the stones, it binds the soil, and retains the small portion of vegetable earth scattered over these hills, which the autumnal rains would other-

Sparta
||
Spartium.Journal de
Physique.

with

Spartium: wife wash away. It is most easily raised from seed, which is usually sown in January, after the ground has received a slight dressing.

The shrub serves two useful purposes. Its branches yield a thread of which linen is made, and in winter support sheep and goats.

In manufacturing thread from broom, the youngest plants are cut in the month of August, or after harvest, and gathered together in bundles, which at first are laid in the sun to dry: they are then beaten with a piece of wood, washed in a river or pond, and left to steep in the water for about four hours. The bundles thus prepared are taken to a little distance from the water, and laid in a hollow place made for them, where they are covered with fern or straw, and remain thus to steep for eight or nine days; during which time, all that is necessary, is to throw a little water once a-day on the heap, without uncovering the broom. After this, the bundles are well washed, the green rind of the plant or epidermis comes off, and the fibrous part remains; each bundle is then beaten with a wooden hammer upon a stone, to detach all the threads, which are at the same time carefully drawn to the extremity of the branches. After this operation, the faggots are untied, and spread upon stones or rocks till they are dry. The twigs must not be peeled till they are perfectly dry; they are then dressed with the comb, and the threads are separated according to the fineness, and spun upon a wheel.

The linen made of this thread serves various purposes in rural economy. The coarsest is employed in making sacks and other strong cloths for carrying grain or seeds. Of the finest is made bed, table, and body linen. The peasants in several places use no other, for they are unacquainted with the culture of hemp or flax, their soil being too dry and too barren for raising them. The cloth made with the thread of the broom is very useful; it is as soft as that made of hemp; and it would perhaps look as well as that made of flax if it was more carefully spun. It becomes white in proportion as it is steeped. The price of the finest thread, when it is sold, which seldom happens, is generally about a shilling a pound.

The other use to which this broom is applied, is to maintain sheep and goats during winter. In the mountains of Lower Languedoc these animals have no other food from November to April, except the leaves of trees preserved. The branches of this broom therefore are a resource the more precious, that it is the only fresh nourishment which at that season the flocks can procure, and they prefer it at all times to every other plant. In fine weather the sheep are led out to feed on the broom where it grows; but in bad weather the shepherds cut the branches, and bring them to the sheep folds. There is, however, an inconvenience attending the continued use of this food. It generally produces inflammation in the urinary passages. But this inconvenience is easily removed by cooling drink, or a change of food, or by mixing the broom with something else.

It is perhaps needless to add, that it differs much from the broom that is common everywhere in the north of Europe, though this too, in many places, is used for food to cattle. Both of them produce flowers that are very much resorted to by bees, as they contain a great quantity of honey juice. And this should be

another inducement to the cultivation of the Spanish broom.

SPARUS, GILTHEAD, a genus of fishes belonging to the order of *thoracici*. See *ICHTHYOLOGY Index*. The *parus auratus*, or gilthead, was well known to the Romans, who did not esteem them unless they were fed with Lucrine oysters, as Martial informs us,

*Non omnis laudem pretiumque ACURATA meretur,
Sed qui solus est in concha Lucrina cibus.*

Lib. xiii. Ep. 97.

SPASM, a convulsion. See *MEDICINE*, n^o 278.

SPATHA, in *Botany*, a sheath; a species of calyx, which bursts lengthwise, and protrudes a stalk supporting one or more flowers, which commonly have no perianthium or flower-cup.

SPATHACEÆ (from *spatha*, "a sheath"), the name of the ninth order in Linnaeus's Fragments of a Natural Method, consisting of plants whose flowers are protruded from a spatha or sheath. See *BOTANY Index*.

SPATHELIA, a genus of plants belonging to the class of pentandria, and to the order of triogynia. See *BOTANY Index*.

SPAW. See *SPA*.

SPAWN, in *Natural History*, the eggs of fishes or frogs.

SPAVENTO. See *SCANTO*.

SPAVIN, in the manege, a disease in horses, being a swelling or stiffness, usually in the ham, occasioning a lameness. See *FARRIERY Index*.

SPAYING, or **SPADING**, the operation of castrating the females of several kinds of animals, as sows, bitches, &c. to prevent any further conception, and promote their fattening. It is performed by cutting them in the mid flank, on the left side, with a sharp knife or lancet, taking out the uterus, and cutting it off, and so stitching up the wound, anointing the part with tar, and keeping the animal warm for two or three days. The usual way is to make the incision oblique, two inches and a half long; that the fore-ginger may be put in towards the back, to feel for the ovaries, which are two kernels as big as acorns on both sides of the uterus, one of which is drawn to the wound, and thus both taken out.

SPEAKER of the House of Commons, a member of the house elected by a majority of votes thereof to act as chairman or president in putting questions, reading briefs, or bills, keeping order, reprimanding the refractory, adjoining the house, &c. See *PARLIAMENT*.

SPEAKING, the art or act of expressing one's thoughts in articulate sounds or words. See *GRAMMAR, LANGUAGE, READING, and ORATORY, Part iv.*

SPEAKING-Trumpet. See *TRUMPET*.

SPEAR-MINT. See *MENTHA, BOTANY Index*.

SPEAR-Wort. See *RANUNCULUS, BOTANY Index*.

SPECIAL, something that is particular, or has a particular designation; from the Latin *species*, in opposition to the *general*, from *genus*.

SPECIES, in *Logic*, a relative term, expressing an idea which is comprised under some general one called a *genus*. See *LOGIC, N^o 68*.

SPECIES, in *Commerce*, the several pieces of gold, silver, copper, &c. which having passed their full preparation

Species
||
Specific
Gravity.

preparation and coinage, are current in public. See MONEY.

SPECIES, in *Algebra*, are the letters, symbols, marks, or characters, which represent the quantities in any operation or equation. This short and advantageous way of notation was chiefly introduced by Vieta, about the year 1590; and by means of it he made many discoveries in algebra, not before taken notice of.

SPECIES, in *Optics*, the image painted on the retina by the rays of light reflected from the several points of the surface of an object, received by the pupil, and collected in their passage through the crystalline, &c.

It has been a matter of dispute among philosophers, whether the species of objects which give the seal an occasion of seeing, be an effusion of the substance of the body; a mere impression which they make on all bodies under certain circumstances; or whether they are not some more subtle body, such as light. The moderns have decided this point by the invention of artificial eyes, in which the species of objects are received on paper, in the same manner as in the natural eye.

SPECIFIC, in *Philosophy*, that which is peculiar to any thing, and distinguishes it from all others.

SPECIFICS, in *Medicine*. By specifics is not meant such as infallibly and in all patients produce salutary effects. Such medicines are not to be expected, because the operations and effects of remedies are not formally inherent in them, but depend upon the mutual action and reaction of the body and medicine upon each other; hence the various effects of the same medicine in the same kind of disorders in different patients, and in the same patient at different times. By specific medicines we understand such medicines as are found to be more uniform in their effects than others in any particular disorder.

SPECIFIC Gravity, is a term much employed in the discussions of modern physics. It expresses the weight of any particular kind of matter, as compared with the weight of the same bulk of some other body of which the weight is supposed to be familiarly known, and is therefore taken for the standard of comparison. The body generally made use of for this purpose is pure water.

The specific gravity of bodies is a very interesting question both to the philosopher and to the man of business. The philosopher considers the weights of bodies as measures of the number of material atoms, or the quantity of matter which they contain. This he does on the supposition that every atom of matter is of the same weight, whatever may be its sensible form. This supposition, however, is made by him with caution, and he has recourse to specific gravity for ascertaining its truth in various ways. This shall be considered by and by. The man of business entertains no doubt of the matter, and proceeds on it as a sure guide in his most interesting transactions. We measure commodities of various kinds by tons, pounds, and ounces, in the same manner as we measure them by yards, feet, and inches, or by bushels, gallons, and pints; nay, we do this with much greater confidence, and prefer this measurement to all others, whenever we are much interested to know the exact proportions of matter that bodies contain. The weight of a quantity of grain is allowed to inform us much more exactly of its real quantity of useful matter than the most accurate measure of its bulk. We see

Specific
Gravity.

many circumstances which can vary the bulk of a quantity of matter, and these are frequently such as we cannot regulate or prevent; but we know very few indeed that can make any sensible change in this weight without the addition or subtraction of other matter. Even taking it to the summit of a high mountain, or from the equator to the polar region, will make no change in its weight as it is ascertained by the balance, because there is the same real diminution of weight in the pounds and ounces used in the examination.

Notwithstanding the unavoidable change which heat and cold make in the bulk of bodies, and the permanent varieties of the same kind of matter which are caused by different circumstances of growth, texture, &c. most kinds of matter have a certain constancy in the density of their particles, and therefore in the weight of a given bulk. Thus the purity of gold, and its degree of adulteration, may be inferred from its weight, it being purer in proportion as it is more dense. The density, therefore, of different kinds of tangible matter becomes characteristic of the kind, and a test of its purity; it marks a particular appearance in which matter exists, and may therefore be called, with propriety, **SPECIFIC**.

But this density cannot be directly observed. It is not by comparing the distances between the atoms of matter in gold and in water that we say the first is 19 times denser than the last, and that an inch of gold contains 19 times as many material atoms as an inch of water; we reckon on the equal gravitation of every atom of matter whether of gold or of water; therefore the weight of any body becomes the indication of its material density, and the weight of a given bulk becomes specific of that kind of matter, marking its kind, and even ascertaining its purity in this form.

It is evident that, in order to make this comparison of general use, the standard must be familiarly known, and must be very uniform in its density, and the comparison of bulk and density must be easy and accurate. The most obvious method would be to form, with all nicety, a piece of the standard matter of some convenient bulk, and to weigh it very exactly, and keep a note of its weight: then, to make the comparison of any other substance, it must be made into a mass of the same precise bulk, and weighed with equal care; and the most convenient way of expressing the specific gravity would be to consider the weight of the standard as unity, and then the number expressing the specific gravity is the number of times that the weight of the standard is contained in that of the other substance. This comparison is most easily and accurately made in fluids. We have only to make a vessel of known dimensions equal to that of the standard which we employ, and to weigh it when empty, and then when filled with the fluid. Nay, the most difficult part of the process, the making a vessel of the precise dimensions of the standard, may be avoided, by using some fluid substance for a standard. Any vessel will then do; and we may ensure very great accuracy by using a vessel with a slender neck, such as a phial or matras; for when this is filled to a certain mark in the neck, any error in the estimation by the eye will bear a very small proportion to the whole. The weight of the standard fluid which fills it to this mark being carefully ascertained, is kept in remembrance. The specific gravity of any other fluid is had by weighing the contents of this vessel when filled with it, and dividing

Specific Gravity.

dividing the weight by the weight of the standard. The quotient is the specific gravity of the fluid. But in all other cases this is a very difficult problem: it requires very nice hands, and an accurate eye, to make two bodies of the same bulk. An error of one hundredth part in the linear dimensions of a solid body makes an error of a 30th part in its bulk; and bodies of irregular shapes and triable substance, such as the ores of metals, cannot be brought into convenient and exact dimensions for measurement.

From all these inconveniences and difficulties we are freed by the celebrated Archimedes, who, from the principles of hydrostatics discovered or established by him, deduced the accurate and easy method which is now universally practised for discovering the specific gravity and density of bodies. (See ARCHIMEDES and HYDRODYNAMICS.) Instead of measuring the bulk of the body by that of the displaced fluid (which would have been impossible for Archimedes to do with any thing like the necessary precision), we have only to observe the loss of weight sustained by the solid. This can be done with great ease and exactness. Whatever may be the bulk of the body, this loss of weight is the weight of an equal bulk of the fluid; and we obtain the specific gravity of the body by simply dividing its whole weight by the weight lost: the quotient is the specific gravity when this fluid is taken for the standard, even though we should not know the absolute weight of any given bulk of this standard. It also gives us an easy and accurate method of ascertaining even this fundamental point. We have only to form any solid body into an exact cube, sphere, or prism, of known dimensions, and observe what weight it loses when immersed in this standard fluid. This is the weight of the same bulk of the standard to be kept in remembrance; and thus we obtain, by the bye, a most easy and accurate method for measuring the bulk or solid contents of any body, however irregular its shape may be. We have only to see how much weight it loses in the standard fluid; we can compute what quantity of the standard fluid will have this weight. Thus should we find that a quantity of sand, or a furze bulb, loses 250 ounces when immersed in pure water, we learn by this that the solid measure of every grain of the sand, or of every twig and prickle of the furze, when added into one fath, amounts to the fourth part of a cubic foot, or to 432 cubic inches.

To all these advantages of the Archimedean method of ascertaining the specific gravity of bodies, derived from his hydrostatical doctrines and discoveries, we may add, that the immediate standard of comparison, namely, water, is, of all the substances that we know, the fittest for the purpose of an universal standard of reference. In its ordinary natural state it is sufficiently constant and uniform in its weight for every examination where the utmost mathematical accuracy is not wanted; all its variations arise from impurities, from which it may at all times be separated by the simple process of distillation: and we have every reason to think that when pure, its density, when of the same temperature, is invariable.

Water is therefore universally taken for the unit of that scale on which we measure the specific gravity of bodies, and its weight is called 1. The specific gravity

Specific Gravity.

of any other body is the real weight in pounds and ounces, when of the bulk of one pound or one ounce of water. It is therefore of the first importance, in all difficulties respecting the specific gravity of bodies, to have the precise weight of some known bulk of pure water. We have taken some pains to examine and compare the experiments on this subject, and shall endeavour to ascertain this point with the precision which it deserves. We shall reduce all to the English cubic foot and avoirdupois ounce of the Exchequer standard, on account of a very convenient circumstance peculiar to this unit, viz. that a cubic foot contains almost precisely a thousand ounces of pure water, so that the specific gravity of bodies expresses the number of such ounces contained in a cubic foot.

We begin with a trial made before the house of commons in 1696 by Mr Everard. He weighed 2145.6 cubic inches of water by a balance, which turned sensibly with 6 grains, when there were 30 pounds in each scale. The weights employed were the Troy weights, in the deposit of the Court of Exchequer, which are still preserved, and have been most scrupulously examined and compared with each other. The weight was 1131 ounces 14 pennyweights. This wants just 11 grains of a thousand avoirdupois ounces for 1728 cubic inches, or a cubic foot; and it would have amounted to that weight had it been a degree or two colder. The temperature indeed is not mentioned; but as the trial was made in a comfortable room, we may presume the temperature to have been about 55° of Fahrenheit's thermometer. The dimensions of the vessel were as accurate as the nice hand of Mr Abraham Sharp, Mr Flamstead's assistant at Greenwich, could execute, and it was made by the Exchequer standard of length.

This is confided in by the naturalists of Europe as a very accurate standard experiment, and it is confirmed by many others both private and public. The standards of weight and capacity employed in the experiment are still in existence, and publicly known, by the report of the Royal Society to parliament in 1742, and by the report of a committee of the house of commons in 1758. This gives it a superiority over all the measures which have come to our knowledge.

The first experiment, made with proper attention, that we meet with, is by the celebrated Snellius, about the year 1615, and related in his *Eratosthenes Batavus*. He weighed a Rhinland cubic foot of distilled water, and found it 62.79 Amsterdam pounds. If this was the ordinary weight of the hops, containing 7626 English Troy grains, the English cubic foot must be 62 pounds 9 ounces, only one ounce more than by Everard's experiment. If it was the Mint pound, the weight was 62 pounds 6 ounces. The only other trials which can come into competition with Mr Everard's are some made by the Academy of Sciences at Paris. Picart, in 1691, found the Paris cubic foot of the water of the fountain d'Arcueil to weigh 69.588 pounds, *pois de Paris*. Du Hamel obtained the very same result; but Mr Monge, in 1753, says that filtered rain-water of the temperature 12° (Reaumur) weighs 69.3792. Both these measures are considerably below Mr Everard's, which is 62.5, the former giving 62.53, and the latter 61.868. M. Lavoisier states the Paris cubic foot at 72 pounds, which makes the English foot 62.47. But there is an incon-

fidelity

Specific Gravity.

fidely among them which makes the comparison impossible. Some changes were made in 1688, by royal authority, in the national standards, both of weight and length; and the academicians are exceedingly puzzled to this day in reconciling the differences, and cannot even ascertain with perfect assurance the lineal measures which were employed in their most boistered geodetical operations.

Such variations in the measurements made by persons of reputation for judgement and accuracy engaged the writer of this article some years ago to attempt another. A vessel was made of a cylindrical form, as being more easily executed with accuracy, whose height and diameter were 6 inches, taken from a most accurate copy of the Exchequer standard. It was weighed in distilled water of the temperature 55° several times without varying 2 grains, and it lost 42895 grains. This gives for the cubic foot 998.74 ounces, deficient from Mr Everard's an ounce and a quarter; a difference which may be expected, since Mr Everard used the New River water without distillation.

We hope that these observations will not be thought superfluous in a matter of such continual reference, in the most interesting questions both to the philosopher and the man of business; and that the determination which we have given will be considered as sufficiently authenticated.

Let us, therefore, for the future take water for the standard, and suppose that, when of the ordinary temperature of summer, and in its state of greatest natural purity, viz. in clean rain or snow, an English cubic foot of it weighs a thousand avoirdupois ounces of 437.5 troy grains each. Divide the weight of any body by the weight of an equal bulk of water, the quotient is the specific gravity of that body; and if the three first figures of the decimal be accounted integers, the quotient is the number of avoirdupois ounces in a cubic foot of the body. Thus the specific gravity of the very finest gold which the refiner can produce is 19.365, and a cubic foot of it weighs 19365 ounces.

But an important remark must be made here. All bodies of homogeneous or unorganised texture expand by heat, and contract by cooling. The expansion and contraction by the same change of temperature is very different in different bodies. Thus water, when heated from 60° to 100° , increases its volume nearly $\frac{1}{11}$ of its bulk, and mercury only $\frac{1}{17}$, and many substances much less. Hence it follows, that an experiment determines the specific gravity only in that very temperature in which the bodies are examined. It will therefore be proper always to note this temperature; and it will be convenient to adopt some very useful temperature for such trials in general: perhaps about 60° of Fahrenheit's thermometer is as convenient as any. It may always be procured in these climates without inconvenience. A temperature near to freezing would have some advantages, because water changes its bulk very little between the temperature 32° and 45° . But this temperature cannot always be obtained. It will much conduce to the facility of the comparison to know the variation which heat produces on pure water. The following table, taken from the observations of Dr Blagden and Mr Gilpin (Phil. Trans. 1792) will answer this purpose.

Specific Gravity.

Temperature of Water.	Bulk of Water.	Specific Gravity.
30		
35	99910	1.00090
40	99970	1.00091
45	99914	1.00086
50	99932	1.00068
55	99962	1.00038
60	100000	1.00000
65	100050	0.99950
70	100106	0.99894
75	100171	0.99830
80	100242	0.99759
85	100320	0.99681
90	100404	0.99598
95	100501	0.99502
100	100622	0.99402

Those gentlemen observed the expansion of water to be very anomalous between 32° and 45° . This is distinctly seen during the gradual cooling of water to the point of freezing. It contracts for a while, and then suddenly expands. But we seldom have occasion to measure specific gravities in such temperature.

The reader is now sufficiently acquainted with the principles of this hydrostatical method of determining the specific gravity of bodies, and can judge of the propriety of the forms which may be proposed for the experiment.

The specific gravity of a fluid may be determined either by filling with it a vessel with a narrow neck, or by weighing a solid body that is immersed in it. It is hard to say which is the best way. The last is not subject to any error in filling, because we may suspend the solid by a fine wire, which will not displace any sensible quantity of the fluid; and if the solid is but a little heavier than the fluid, the balance being loaded only with the excess, will be very sensible to the smallest want of equilibrium. But this advantage is perhaps compensated by an obstruction to the motion of the solid up or down in the fluid, arising from viscosity. When the weight in the opposite scale is yet too small, we slowly add more, and at last gain by grain, which gradually brings the beam to the level. When it is exactly level, the weight in the scale is somewhat too great; for it not only balances the preponderance of the solid, but also this viscosity of the fluid. But we may get rid of this error. Add a small quantity more; this will bring the beam over to the other side. Now put as much into the scale on the same side with the solid; this will not restore the beam to its level. We will add more till this be accomplished; and this addition is the measure of the viscosity of the fluid, and must be subtracted from the weight that was in the other scale when the beam came *first* to a level. This effect of viscosity is not insensible, with nice apparatus, even in the purest water, and in many fluids it is very considerable—and, what is worse, it is very changeable. It is greatly diminished by heat; and this is an additional reason for making

Specific Gravity.

making those trials in pretty warm temperatures. But for fluids of which the viscosity is considerable, this method is by no means proper; and we must take the other, and weigh them in a vessel with a narrow neck. Mercury must also be treated in this way, because we have no solid that will sink in it but gold and platinum.

It is not so easy as one would imagine to fill a vessel precisely to the same degree upon every trial. But if we do not operate on too small quantities, the unavoidable error may be made altogether insignificant, by having the neck of the vessel very small. If the vessel hold a pound of water, and the neck do not exceed a quarter of an inch (and it will not greatly retard the operation to have it half this size), the examiner must be very careful indeed to err one part in two thousand; and this is perhaps as near as we can come with a balance. We must always recollect that the capacity of the vessel changes by heat, and we must know this variation, and take it into the account. But it is affecting to regard (as Mr Homberg would make us believe that he did) the distension of the vessel by the pressure of the fluid. His experiments of this kind have by no means the consistency with each other that should convince us that he did not commit much greater errors than what arose from distension.

In examining either solids or fluids, we must be careful to free their surface, or that of the vessel in which the fluid is to be weighed, from air, which frequently adheres to it in a peculiar manner, and, by forming a bubble, increases the apparent bulk of the solid, or diminishes the capacity of the vessel. The greatest part of what appears on those occasions seems to have existed in the fluid in a state of chemical union, and to be set at liberty by the superior attraction of the fluid for the contiguous solid body. These air bubbles must be carefully brushed off by hand. All greasy matters must be cleared off for the same reason: they prevent the fluid from coming into contact.

We must be no less careful that no water is imbibed by the solid, which would increase its weight without increasing its bulk. In some cases, however, a very long maceration and imbibition is necessary. Thus, in examining the specific gravity of the fibrous part of vegetables, we should err exceedingly if we imagined it as small as appears at first. We believe that in most plants it is at least as great as water, for after long maceration they sink in it.

It is almost needless to say that the nicest and most sensible balances are necessary for this examination. Balances are even constructed on purpose, and fitted with several pieces of apparatus, which make the examination easy and neat. We have described (see BALANCE) Mr Gravesande's as one of the most convenient of any. His contrivance for observing the fractions of a grain is extremely ingenious and expeditious, especially for the detecting of effect of viscosity.

The hydrometer, or areometer, is another instrument for ascertaining the specific gravity of fluids. This very pretty instrument is the invention of a lady, as eminent for intellectual accomplishments as she was admired for her beauty. Hypatia, the learned daughter of the celebrated mathematician Theon of Alexandria, became so eminent for her mathematical knowledge, that she was made public professor of the science in the first school in the world. She wrote a commentary on the works

Specific Gravity.

of Apollonius and of Diophantus, and composed Astronomical Tables; all of which are lost. These rare accomplishments, however, could not save her from the fury of the fanatics of Alexandria, who cut her in pieces for having taken an offensive part in a dispute between the governor and patriarch.—We have described some of the most approved of these instruments in the article HYDROMETER, and shall in this place make a few observations on the principles of their construction, not as they are usually made, accommodated to the examination of particular liquors, but as indicators of pure specific gravity. And we must premise, that this would, for many reasons, be the best way of constructing them. The very ingenious contrivances for accommodating them to particular purposes are unavoidably attended with many sources of error, both in their adjustment by the maker and in their use; and all that is gained by a very expensive instrument is the saving the trouble of inspecting a table. A simple scale of specific gravity would expose to no error in construction, because all the weights but one, or all the points of the scale but one, are to be obtained by calculation, which is incomparably more exact than any manual operation, and the table can always be more exact than any complex observation. But a still greater advantage is, that the instruments would by this means be fitted for examining all liquors whatever, whereas at present they are almost useless for any but the one for which they are constructed.

Hydrometers are of two kinds. The most simple and the most delicate are just a substitute for the hydrostatical balance. They consist of a ball (or rather an egg or pear-shaped vessel, which moves more easily through the fluid) A (fig. 1.) having a foot projecting down from it, terminated by another ball B, and a slender stalk or wire above, carrying a little dish C. The whole is made so light as to float in the lightest fluid we are acquainted with; such as vitriolic or muriatic ether, whose specific gravity is only 0.73. This number should be marked on the dish, indicating that this is the specific gravity of the fluid in which the instrument floats, sinking to the point D of the stem. The ball B is made heavy, and the foot is of some length, that the instrument may have stability, and swim erect, even if considerably loaded above; and, for the same reason, it must be made very round, otherwise it will lean to a side. When put into a heavier liquor, its buoyancy will cause it to float with a part of the ball above the surface. Weights are now put into the scale C, till the instrument sink to D. The weight put into the scale, added to the weight of the instrument, is the weight of the displaced fluid. This, compared with the weight of the whole when the instrument is swimming in pure water, gives the specific gravity of the fluid. All trouble of calculation may be avoided by marking the weights with such numbers as shall indicate the specific gravity at once. Thus having loaded the instrument to as to sink it to D in pure water, call the whole weight 1000; then weigh the instrument itself, and say, "as the weight when swimming in water is to its present weight, so is 1000 to a 4th proportional." This is the specific gravity of the liquor which would float the unloaded instrument. Suppose this to be 730. The hydrometer would just float in muriatic ether, and this should be marked on the file. Now make a set of small weights,

Plate
CCCXCIII.

Specific Gravity

weights, and mark them, not by their weights in grains, but in such units that 270 of them shall be equal to the weight which fits the instrument for pure water.

Suppose that, in order to float this instrument in a certain brandy, there are required 186 in these small weights. This added to 732 gives 918 for the specific gravity, and shows it to be precisely excise proof spirit. Nine weights, viz. 256, 128, 64, 32, 16, 8, 4, 2, 1, will suffice for all liquors from ether to the strongest worts. And that the trouble in changing the weights may be greatly lessened, let a few circles *a, b, c, d, e*, be marked on the top of the ball. When we see it float unloaded at the circle C for instance, we know it will require at least 128 to sink it to D on the stem.

If the weights to be added above are considerable, it raises the centre of gravity so much, that a small want of equilibrium, by laying the weights on one side, will produce a great inclination of the instrument, which is unsightly. Instead therefore of making them loose weights, it is proper to make them round plates, with a small hole in the middle, to go on a pin in the middle of the scale. This will keep the instrument always upright. But unless the hydrometer is of a considerable size, it can hardly be made so as to extend from the lightest to the heaviest fluid which we may have occasion to examine, even though we except mercury. Some of the mineral acids are considerably more than twice the weight of ether. When there is such a load at top, the hydrometer is very apt to overset, and inclines with the smallest want of equilibrium. Great size is inconvenient even to the philosopher, because it is not always in his power to operate on a quantity of fluid sufficient to float the instrument. Therefore two, or perhaps three, are necessary for general examination. One may reach from ether to water; another may serve for all liquors of a specific gravity between one and one and a half; and the third, for the mineral acids, may reach from this to two. If each of these be about two fold inches in capacity, we may easily and expeditiously determine the specific gravity within one ten thousandth part of the truth: and this is precision enough for most purposes of science or business.

The chief questions are, 1. To ascertain the specific gravity of an unknown fluid. This needs no farther explanation. 2. To ascertain the proportion of two fluids which are known to be in a mixture. This is done by discovering the specific gravity of the mixture by means of the hydrometer, and then deducing the proportion from a comparison of this with the specific gravities of the ingredients.

In this mode of examination the bulk is always the same; for the hydrometer is immersed in the different fluids to the same depth. Now if an inch, for example, of this bulk is made up of the heaviest fluid, there is an inch wanting of the lightest; and the change made in the weight of the mixture is the difference between the weight of an inch of the heaviest, and of an inch of the lightest ingredients. The number of inches therefore of the heaviest fluid is proportional to the addition made to the weight of the mixture. Therefore let B and *b* be the bulks of the heaviest and lightest fluids in the bulk β of the mixture; and let D, *d*, and δ be the densities, or the weights, or the specific gravities (for they are in one ratio) of the heavy fluid, the light fluid, and

Specific Gravity

the mixture (their bulk being that of the hydrometer). We have $\beta = B + b$. The addition which would have been made to the bulk β , if the lightest fluid were changed entirely for the heaviest, would be $D - d$; and the change which is really made is $\delta - d$. Therefore $\beta : B = D - d : \delta - d$. For similar reasons we should have $\beta : B = D - d : D - \delta$; or, in words, "the difference between the specific gravities of the two fluids, is to the difference between the specific gravities of the mixture and of the lightest fluid, as the bulk of the whole to the bulk of the heaviest contained in the mixture;" and "the difference of the specific gravities of the two fluids, is to the difference of the specific gravities of the mixture and of the heaviest fluids, as the bulk of the whole to that of the lightest contained in the mixture." This is the form in which the ordinary business of life requires the answer to be expressed, because we generally reckon the quantity of liquors by bulk, in gallons, pints, quarts. But it would have been equally easy to have obtained the answer in pounds and ounces; or it may be had from their bulk, since we know their specific gravities.

The hydrometer more commonly used is the ancient one of Hypatia, consisting of a ball A (fig. 2.) made steady by an addition B, below it like the former, but having a long stem CF above. It is so loaded that it sinks to the top F of the stem in the lightest of all the fluids which we propose to measure with it, and to sink only to C in the heaviest. In a fluid of intermediate specific gravity it will sink to some point between C and F.

In this form of the hydrometer the weight is always the same, and the immediate information given by the instrument is that of different bulks with equal weight. Because the instrument sinks till the bulk of the displaced fluid equals it in weight, and the additions to the displaced fluid are all made by the stem, it is evident that equal bulks of the stem indicate equal additions of volume. Thus the stem becomes a scale of bulks to the same weight.

The only form in which the stem can be made with sufficient accuracy is cylindrical or prismatic. Such a stem may be made in the most accurate manner by wire-drawing, that is, passing it through a hole made in a hardened steel plate. If such a stem be divided into equal parts, it becomes a scale of bulks in arithmetical progression. This is the easiest and most natural division of the scale; but it will not indicate densities, specific gravities, or weights of the same bulk in arithmetical progression. The specific gravity is as the weight divided by the bulk. Now a series of divisors (the bulks), in arithmetical progression, applied to the same dividend (the bulk and weight of the hydrometer as it floats in water), will not give a series of quotients (the specific gravities) in arithmetical progression: they will be in what is called *harmonic progression*, their differences continually diminishing. This will appear even when physically considered. When the hydrometer sinks a tenth of an inch near the top of the stem, it displaces one tenth of an inch of a light fluid, compared with that displaced by it when it is floating with all the stem above the surface. In order therefore that the divisions of the stem may indicate equal changes of specific gravity, they must be in a series of harmonic progressions increasing. The point at which the instrument floats in pure water should be marked 1000, and those above it 999, 998, 997, &c.; and those

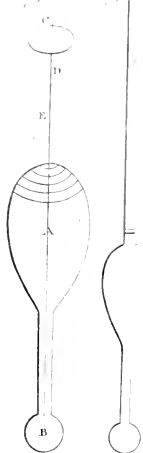

SPRITIOUS Liquors.

Fig. 1.

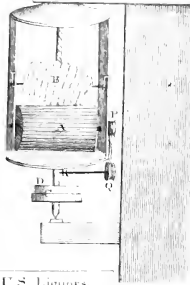
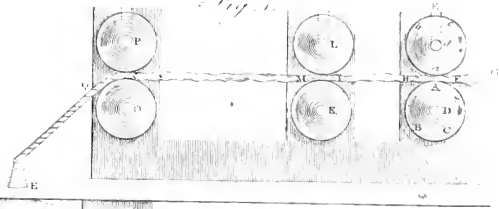

Fig. 2.

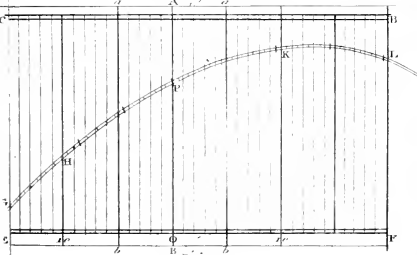
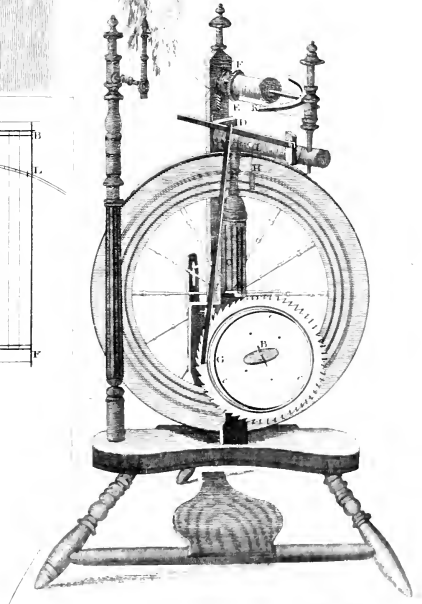
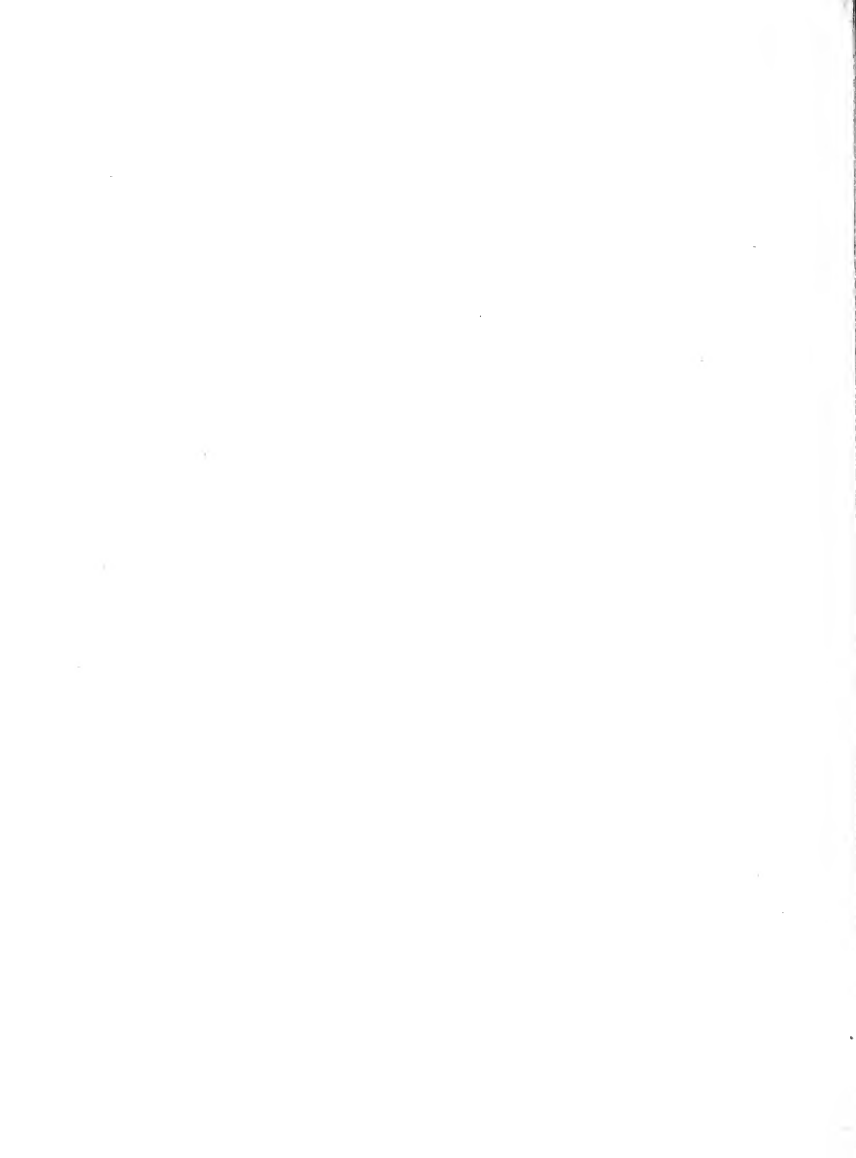

Fig. 2.





Specific Gravity. those below the water mark must be numbered 1001, 1002, 1003, &c. Such a scale will be a very accurate picture of the densities of fluids, for the density or vicinity of the divisions will be precisely similar to the density of the fluids. Each interval is a bulk of fluid of the same weight. If the whole instrument were drawn out into wire of the size of the stem, the length from the water mark would be 1000.

Such are the rules by which the scale must be divided. But there must be some points of it determined by experiment, and it will be proper to take them as remote from each other as possible. For this purpose let the instrument be accurately marked at the point where it stands, in two fluids, differing as much in specific gravity as the instrument will admit. Let it also be marked where it stands in water. Then determine with the utmost precision the specific gravities of these fluids, and put their values at the corresponding points of the scale. Then the intermediate points of the scale must be computed for the different intervening specific gravities, or it must be divided from a pattern scale of harmonic progressions in a way well known to the mathematical instrument makers. If the specific gravities have been accurately determined, the value 1000 will be found to fall precisely in the water mark. If we attempt the division entirely by experiment, by making a number of fluids of different specific gravities, and marking the stem as it stands in them, we shall find the divisions turn out very anomalous. This is however the way usually practised; and there are few hydrometers, even from the best maker, that hold true to a single division or two. Yet the method by computation is not more troublesome; and one scale of harmonic progressions will serve to divide every stem that offers. We may make use of a scale of equal parts for the stem, with the assistance of two little tables. One of these contains the specific gravities in harmonic progression, corresponding to the arithmetical scale of bulks on the stem of the hydrometer; the other contains the divisions and fractions of a division of the scale of bulks, which correspond to an arithmetical scale of specific gravities. We believe this to be the best method of all. The scale of equal parts on the stem is so easily made, and the little table is so easily inspected, that it has every advantage of accuracy and dispatch, and it gives, by the way, an amusing view of the relation of the bulks and densities.

We have hitherto supposed a scale extending from the lightest to the heaviest fluid. But unless it be of a very inconvenient length, the divisions must be very minute. Moreover, when the bulk of the stem bears a great proportion to that of the body, the instrument does not swim freely; it is therefore proper to limit the range of the instrument in the same manner as those of the first kind. A range from the density of ether to that of water may be very well executed in an instrument of very moderate size, and two others will do for all the heavier liquors; or an equal range in any other densities as may suit the usual occupations of the experimenter.

To avoid the inconveniences of a hydrometer with a very long and slender stem, or the necessity of having a series of them, a third sort has been contrived, in which the principles of both are combined. Suppose a hydrometer with a stem, whose bulk is $\frac{1}{4}$ th of that of the ball, and that it sinks in ether to the top of the stem; it is evident that in a fluid which is $\frac{1}{4}$ th heavier,

Specific Gravity. the whole stem will emerge; for the bulk of the displaced fluid is now $\frac{1}{4}$ th of the whole bulk, and the weight is the same as before, and therefore the specific gravity is $\frac{1}{4}$ th greater.

Thus we have obtained a hydrometer which will indicate, by means of divisions marked on the stem, all specific gravities from 0.73 to 0.8033; for 0.8033 is $\frac{1}{4}$ th greater than 0.73. These divisions must be made in harmonic progression, as before directed for an entire scale, placing 0.73 at the top of the stem and 0.8033 at the bottom.

When it floats at the lowest division, a weight may be put on the top of the stem, which will again sink it to the top. This weight must evidently be 0.073, or $\frac{1}{4}$ th of the weight of the fluid displaced by the unloaded instrument. The hydrometer, thus loaded, indicates the same specific gravity, by the top of the stem, that the unloaded instrument indicates by the lowest division. Therefore, when loaded, it will indicate another series of specific gravities, from 0.8033 to 0.8833 ($=0.8033 + 0.08033$), and will float in a liquor of the specific gravity 0.8833 with the whole stem above the surface.

In like manner, if we take off this weight, and put on 1 $= 0.08033$, it will sink the hydrometer to the top of the stem; and with this new weight it will indicate another series of specific gravities from 0.8833 to 0.97163 ($=0.8833 + 0.08833$). And, in the same manner, a third weight $= 0.08833$ will again sink it to the top of the stem, and fit it for another series of specific gravities up to 1.068792. And thus, with three weights, we have procured a hydrometer fitted for all liquors from ether to a wort for a malt liquor of two barrels per quarter. Another weight, in the same progression, will extend the instrument to the strongest wort that is brewed.

This is a very commodious form of the instrument, and is now in very general use for examining spirituous liquors, worts, ales, brines, and many such articles of commerce. But the divisions of the scale are generally adapted to the questions which naturally occur in the business. Thus, in the commerce of strong liquors, it is usual to estimate the article by the quantity of spirit of a certain strength which the liquor contains.— This we have been accustomed to call proof spirit, and it is such that a wine gallon weighs 7 pounds 12 ounces, and it is by this strength that the excise duties are levied. Therefore the divisions on the scale, and the weights which connect the successive repetitions of the scale, are made to express at once the number of gallons or parts of a gallon of proof spirits contained in a gallon of the liquor. Such instruments save all trouble of calculation to the exciseman or dealer; but they limit the use of a very delicate and expensive instrument to a very narrow employment. It would be much better to adhere to the expression either of specific gravity or of bulk; and then a very small table, which could be compressed in the smallest case for the instrument, might render it applicable to every kind of fluid.

The reader cannot but have observed that the successive weights, by which the short scale of the instrument is extended to a great range of specific gravities, do not increase by equal quantities. Each difference is the weight of the liquor displaced by the graduated stem of the instrument when it is sunk to the top of

the scale. It is a determined aliquot part of the whole weight of the instrument so loaded, (in our example it is always $\frac{1}{10}$ th of it). It increases therefore in the same proportion with the preceding weight of the loaded instrument. In short, both the successive additions, and the whole weights of the loaded instrument, are quantities in geometrical progression; and, in like manner, the divisions on the scale, if they correspond to equal differences of specific gravity, must also be unequal.— This is not sufficiently attended to by the makers; and they commit an error here, which is very considerable when the whole range of the instrument is great. For the value of one division of the scale, when the largest weight is on, is as much greater than its value, when the instrument is not loaded at all, as the full loaded instrument is heavier than the instrument unloaded. No manner whatever of dividing the scale will correspond to equal differences of specific gravity through the whole range with different weights; but if the divisions are made to indicate equal proportions of gravity when the instrument is used without a weight, they will indicate equal proportions throughout. This is evident from what we have been just now saying; for the proportion of the specific gravities corresponding to any two immediately succeeding weights is always the same.

The best way, therefore, of constructing the instrument, so that the same divisions of the scale may be accurate in all its successive repetitions with the different weights, is to make these divisions in geometrical progression. The corresponding specific gravities will also be in geometric proportion. These being all inserted in a table, we obtain them with no more trouble than by inspecting the scale which usually accompanies the hydrometer. This table is of the most easy construction; for the ratio of the successive bulks or of specific gravities being all equal, the differences of the logarithms are equal.

This will be illustrated by applying it to the example already given of a hydrometer extending from 0.73 to 1.068793 with three weights. This gives four repetitions of the scale on the stem. Suppose this scale divided into 40 parts, we have 40 specific gravities.— Let these be indicated by the numbers 0, 1, 2, 3, &c. to 40. The mark 0 is affixed to the top of the stem, and the divisions downwards are marked 1, 2, 3, &c. the lowest being 40. These divisions are easily determined. The stem, which we may suppose 5 inches long, was supposed to be $\frac{1}{10}$ th of the capacity of the ball. It may therefore be considered as the extremity of a rod of 11 times its length, or 55 inches; and we must find nine mean proportionals between 50 and 55 inches. Subtract each of these from 55 inches, and the remainders are the distances of the points of division from 0, the top of the scale. The smallest weight is marked 10, the next 20, and the third 30. If the instrument loaded with the weight 20 sinks in some liquor to the mark 7, it indicates the specific gravity 27, that is, the 27th of 40 mean proportionals between 0.73 and 1.068793, or 0.944242. To obtain all these intermediate specific gravities, we have only to subtract

9.8633220, the logarithm of 0.73, from that of 1.068793, viz. 0.0288937, and take 0.0041393, the 40th part of the difference. Multiply this by 1, 2, 3, &c. and add the logarithm of 0.73 to each of the products. The sums are the logarithms of the specific gravities required. These will be found to proceed so equally, that they may be interpolated ten times by a simple table of proportional parts without the smallest sensible error. Therefore the stem may be divided into a hundred parts very sensible to the eye (each being nearly the 20th of an inch), and 426 degrees of specific gravity obtained within the range, which is as near as we can examine this matter by any hydrometer. Thus the specific gravities corresponding to N^o 26, 27, 28, 29, are as follow:

		1st Diff.	2d Diff.
26	0.93529	895	
27	0.94424	904	9
28	0.95328	913	9
29	0.96241		

Nay, the trouble of inspecting a table may be avoided, by forming on a scale the logarithms of the numbers between 7300 and 1068793, and placing along side of it a scale of the same length divided into 400 equal parts, numbered from 0 to 400. Then, looking for the mark shown by the hydrometer on this scale of equal parts, we see opposite to it the specific gravity.

We have been thus particular in the illustration of this mode of construction, because it is really a beautiful and commodious instrument, which may be of great use both to the naturalist and to the man of business.— A table may be compiled in 20 octavo pages, which will contain the specific gravities of every fluid which can interest either, and answer every question relative to their admixture with as much precision as the observations can be made. We therefore recommend it to our readers, and we recommend the very example which we have given as one of the most convenient. The instrument need not exceed eight inches in length, and may be contained in a pocket case of two inches broad and as many deep, which will also contain the scale, a thermometer, and even the table for applying it to all fluids which have been examined.

It is unfortunate that no graduated hydrometer can be made so easily for the examination of the corrosive mineral acids (A). These must be made of glass, and we cannot depend on the accurate cylindrical form of any glass stem. But if any such can be procured, the construction is the same. The divided scale may either be on thin paper pasted on the inside of the stem, or it may be printed on the stem itself from a plate, with ink made of a metallic calx, which will attach itself to the glass with a very moderate heat. We would recommend common white enamel, or arsenical glass, as the fittest material for the whole instrument; and the ink used, in taking the impression of the scale, may be the same that is used for the low-priced printing on Delft ware pottery.—First form the scale on the stem. Then, having measured the solid contents of the graduated part as exactly as possible, and determined on the general shape

(A) It would be worth while to try copper enamelled.

Specific Gravity.

of the ball and counterpoise below, calculate its size, so that it may be a little less than ten times that of the stem. The glass-blower can copy this very nearly, and join it to the stem. Then make two brines or other liquors, which shall have specific gravities in the ratio of 10 to 11. Load the instrument so that it may sink to 10 in the lightest. When put into the heaviest, it should rise to 10. If it does not rise so high, the immersed part is too small. Let the glass-blower enlarge the ball of the counterpoise a little. Repeat this trial till it be exact. Nothing now remains but to form the weights: And here we observe, that when the instrument is to have a very great range, as for examining all states of the vitriolic acid, it has a chance of being very tottering when loaded with the greatest weight on the top of so long a scale. To avoid this, Mr Quin and others have added some of their weights below.— But this will not fulfil the present construction, because it will alter the proportion between the bulks of the stem and immersed part. Therefore let these weights consist of cylinders of metal small enough to go into the stem, and let them be soldered to the end of long wires, which will let them go to the bottom, and have a small hook or ring at top. These can be slung to the instrument in its case. This is indeed the best construction for every hydrometer, because it makes it incomparably more steady. The instrument is poised by small shot or mercury. But it will be much better to do it with Newton's fusible metal (three parts of tin, five parts of lead, and eight parts of bismuth) in cast-iron filings. When the exact quantity has been put in, the instrument may be set in a vessel of oil, and this kept on the fire till all is completely melted. It soon freezes again, and remains fast. If this metal is not to be had, let a few bits of sealing-wax be added to the mercury or shot, to make up the counterpoise. When heated, it will float a-top, and when it freezes again it will keep all fast. Thus we shall make a very complete and cheap instrument.

There is yet another method of examining the specific gravities of fluids, first proposed by Dr Wilson, late professor of astronomy in the university of Glasgow. This is by a series of small glass bubbles, differing equally, or according to some rule, from each other in specific gravity, and each marked with its proper number. When these are thrown into a fluid which is to be examined, all those which are heavier than the fluid will fall to the bottom. Then holding the vessel in the hand, or near a fire or candle, the fluid expands, and one of the floating bubbles begins to sink. Its specific gravity, therefore was either equal to, or a little less than, that of the fluid; and the degree of the thermometer, when it began to sink, will inform us how much it was deficient, if we know the law of expansion of the liquor. Sets of these bubbles fitted for the examination of spirituous liquors, with a little treatise showing the manner of using them, and calculating by the thermometer, are made by Mr Brown, an ingenious artist of Glasgow, and are often used by the dealers in spirits, being found both accurate and expeditious.

Also, though a bubble or two should be broken, the strength of spirits may easily be had by means of the remainder, unless two or three in immediate succession be wanting: for a liquor which answers to N^o 4 will sink N^o 2, by heating it a few degrees, and therefore

N^o 3, may be spared. This is a great advantage in ordinary business. A nice hydrometer is not only an expensive instrument, but exceedingly delicate, being so very thin. If broken or even bruised, it is useless, and can hardly be repaired except by the very maker.

As the only question here is, to determine how many gallons of excise proof spirits is contained in a quantity of liquor, the artist has contrived this series of bubbles in the simplest manner possible, by previously making 40 or 50 measures of spirits and water, and then adjusting the bubbles to these mixtures. In some sets the number on each bubble is the number of gallons of proof spirits contained in 100 gallons of the liquor. In other sets the number on each bubble expresses the gallons of water which will make a liquor of this strength, if added to 14 gallons of alcohol. Thus, if a liquor answers to N^o 4, then 4 gallons of water added to 14 gallons of alcohol will make a liquor of this strength. The first is the best method; for we should be mistaken in supposing that 18 gallons, which answer to N^o 4, contains exactly 14 gallons of alcohol: it contains more than 14, for a reason to be given by and by.

By examining the specific gravity of bodies, the philosopher has made some very curious discoveries. The most remarkable of these is the change which the density of bodies suffers by mixture. It is a most reasonable expectation, that when a cubic foot of one substance is mixed *any how* with a cubic foot of another, the bulk of the mixture will be two cubic feet; and that 18 gallons of water joined to 18 gallons of oil will fill a vessel of 36 gallons. Accordingly this was never doubted; and even Archimedes, the most scrupulous of mathematicians, proceeded on this supposition in the solution of his famous problem, the discovery of the proportion of silver and gold in a mixture of both. He does not even mention it as a postulate that *may* be granted him, so much did he conceive it to be an axiom. Yet a little reflection seems sufficient to make it doubtful and to require examination. A box filled with musket-balls will receive a considerable quantity of small shot, and after this a considerable quantity of fine sand, and after this a considerable quantity of water. Something like this might happen in the admixture of bodies of porous texture. But such substances as metals, glass, and fluids, where no discontinuity of parts can be perceived, or was suspected, seem free from every chance of this kind of introduction. Lord Bacon, however, without being a naturalist or mathematician *ex professo*, inferred from the mobility of fluids that they consisted of discrete particles, which must have pores interposed, whatever be their figure. And if we ascribe the different densities, or other sensible qualities, to difference in size or figure of those particles, it will frequently happen that the smaller particles will be lodged in the interstices between the larger, and thus contribute to the weight of the sensible mass without increasing its bulk. He therefore suspects that mixtures will be in general less bulky than the sum of their ingredients.

Accordingly, the examination of this question was one of the first employments of the Royal Society of London, and long before its institution had occupied the attention of the gentlemen who afterwards composed it. The register of the Society's early meetings contains many experiments on this subject, with mixtures of gold and silver, of other metals, and of various

Specific Gravity.

Specific Gravity.

fluids, examined by the hydrostatical balance of Mr Boyle. Dr Hooke made a prodigious number, chiefly on articles of commerce, which were unfortunately lost in the fire of London.

It was soon found, however, that Lord Bacon's conjecture had been well founded, and that bodies changed their density very sensibly in many cases. In general, it was found that bodies which had a strong chemical affinity increased in density, and that their admixture was accompanied with heat.

By this discovery it is manifest that Archimedes had not solved the problem of detecting the quantity of silver mixed with the gold in King Hiero's crown, and that the physical solution of it requires experiments made on all the kinds of matter that are mixed together. We do not find that this has been done to this day, although we may affirm that there are few questions of more importance. It is a very curious fact in chemistry, and it would be most desirable to be able to reduce it to some general laws: For instance, to ascertain what is the proportion of two ingredients which produces the greatest change of density. This is important in the science of physics, because it gives us considerable information as to the mode of action of those natural powers or forces by which the particles of tangible matter are united. If this introduction, concentration, penetration, or by whatever name it be called, were a mere reception of the particles of one substance into the interstices of those of another, it is evident that the greatest concentration would be observed when a small quantity of the recipient is mixed with, or disseminated through, a great quantity of the other. It is thus that a small quantity of fine sand will be received into the interstices of a quantity of small shot, and will increase the weight of the bagful without increasing its bulk. The case is nowise different when a piece of freestone has grown heavier by imbibing or absorbing a quantity of water. If more than a certain quantity of sand has been added to the small shot, it is no longer concealed. In like manner, various quantities of water may combine with a mass of clay, and increase its size and weight alike. All this is very conceivable, occasioning no difficulty.

But this is not the case in any of the mixtures we are now considering. In all these, the fit additions of either of the two substances produce but an inconsiderable change of general density; and it is in general most remarkable, whether it be condensation or rarefaction, when the two ingredients are nearly of equal bulk. We can illustrate even this difference, by reflecting on the imbibition of water by vegetable solids, such as timber. Some kinds of wood have their weight much more increased than their bulk; other kinds of wood are more enlarged in bulk than in weight. The like happens in grains. This is curious, and shows in the most unquestionable manner that the particles of bodies are not in contact, but are kept together by forces which act at a distance. For this distance between the centres of the particles is most evidently susceptible of variation; and this variation is occasioned by the introduction of another substance, which, by acting on the particles by attraction or repulsion, diminishes or increases their mutual distances, and makes new distances necessary for bringing all things into equilibrium. We refer the curious reader to the ingenious theory of

Specific Gravity.

the abbé Boscovich for an excellent illustration of this subject (*Theor. Phil. Nat. § de Solutione Chémica*).

This question is no less important to the man of business. Till we know the condensation of those metals by mixture, we cannot tell the quantity of alloy in gold and silver by means of their specific gravity; nor can we tell the quantity of pure alcohol in any spirituous liquor, or that of the valuable salt in any solution of it. For want of this knowledge, the dealers in gold and silver are obliged to have recourse to the tedious and difficult test of the assay, which cannot be made in all places or by all men. It is therefore much to be wished, that some persons would institute a series of experiments in the most interesting cases: for it must be observed, that this change of density is not always a small matter; it is sometimes very considerable and paradoxical. A remarkable instance may be given of it in the mixture of brass and tin for bells, great guns, optical speculums, &c. The specific gravity of cast brass is nearly 8.006, and that of tin is nearly 7.363. If two parts of brass be mixed with one of tin, the specific gravity is 8.917; whereas, if each had retained its former bulk, the sp. grav.

would have been only $7.793 \left(= \frac{2 \times 8.006 + 7.363}{3} \right)$. A

mixture of equal parts should have the specific gravity 7.684; but it is 8.441. A mixture of two parts tin with one part brass, instead of being 7.577, is 8.027.

In all these cases there is a great increase of specific gravity, and consequently a great condensation of parts or contraction of bulk. The first mixture of eight cubic inches of brass, for instance, with four cubic inches of tin, does not produce 12 cubic inches of bell-metal, but only 10 $\frac{1}{2}$ nearly, having shrunk $\frac{1}{4}$. It would appear that the distances of the brass particles are most affected, or perhaps it is the brass that receives the tin into its pores; for we find that the condensations in these mixtures are nearly proportional to the quantities of the brass in the mixtures. It is remarkable that this mixture with the lightest of all metals has made a composition more heavy and dense than brass can be made by any hammering.

The most remarkable instance occurs in mixing iron with platinum. If 10 cubic inches of iron are mixed with 14 of platinum, the bulk of the compound is only 9 $\frac{1}{2}$ inches. The iron therefore has not simply received the platinum into its pores: its own particles are brought nearer together. There are similar results in the solution of turbit mineral, and of some other salts, in water. The water, instead of rising in the neck of the vessel, when a small quantity of the salt has been added to it, sinks considerably, and the two ingredients occupy less room than the water did alone.

The same thing happens in the mixture of water with other fluids and different fluids with each other: But we are not able to trace any general rule that is observed with absolute precision. In most cases of fluids the greatest condensation happens when the bulks of the ingredients are nearly equal. Thus, in the mixture of alcohol and water, we have the greatest condensation when 16 $\frac{1}{2}$ ounces of alcohol are mixed with 20 ounces of water, and the condensation is about $\frac{1}{7}$ of the whole bulk of the ingredients. It is extremely various in different substances, and no classification of them can be made in this respect.

A dissertation has been published on this subject by Da

Specific Gravity.

Dr Hahn of Vienna, intitled *De Efficacia Mixture in mutandis Corporum Voluminibus*, in which all the remarkable instances of the variation of density have been collected. All that we can do (as we have no directing principle) is to record such instances as are of chief importance, being articles of commerce.

The first that occurs to us is the mixtures of alcohol and water in the composition of spirituous liquors. This has been considered by many with great care. The most scrupulous examination of this, or perhaps of any mixture, has been lately made by Dr Blagden (now Sir Charles Blagden) of the Royal Society, on the requisition of the Board of Excise. He has published an account of the examination in the *Philosophical Transactions of London* in 1791 and 1792. We shall give an account of it under the article *SPIRITUOUS LIQUORS*; and at present only select one column, in order to show the condensation. The alcohol was almost the strongest that can be produced, and its specific gravity, when of the temperature 62°, was 0.825. The whole mixtures were of the same temperature.

Column 1. contains the pounds, ounces, or other measures by weight, of alcohol in the mixture. Column 2. contains the pounds or ounces of water. Column 3. is the sum of the bulks of the ingredients, the bulk of a pound or ounce of water being accounted 1. Column 4. is the observed specific gravity of the mixture, taken from Dr Blagden's dissertation. Column 5. is the specific gravity which would have been observed if the ingredients had each retained its own specific gravity. This we calculated by dividing the sum of the two numbers of the first and second columns by the corresponding number of the third. Column 6. is the difference of column 4. and column 5. and exhibits the condensation.

TABLE.

A.	W.	Volume.	Sp. Grav. observed.	Sp. Grav. calculated.	Condensation.
20	0	24.2424	0.8250	0.8250	00
20	1	24.2424	0.8260	0.8220	40
20	2	24.2424	0.8270	0.8233	74
20	3	24.2424	0.8283	0.8243	100
20	4	24.2424	0.8291	0.8250	123
20	5	24.2424	0.8299	0.8259	143
20	6	24.2424	0.8307	0.8267	160
20	7	24.2424	0.8317	0.8274	175
20	8	24.2424	0.8327	0.8281	188
20	9	24.2424	0.8337	0.8289	199
20	10	24.2424	0.8347	0.8296	216
20	11	24.2424	0.8357	0.8304	218
20	12	24.2424	0.8365	0.8310	226
20	13	24.2424	0.8373	0.8316	233
20	14	24.2424	0.8381	0.8321	238
20	15	24.2424	0.8389	0.8326	243
20	16	24.2424	0.8397	0.8331	247
20	17	24.2424	0.8405	0.8336	252
20	18	24.2424	0.8413	0.8341	254
20	19	24.2424	0.8421	0.8346	257
20	20	24.2424	0.8429	0.8351	259
10	20	24.2424	0.8437	0.8356	262
18	20	24.2424	0.8445	0.8361	265

Specific Gravity.

A.	W.	Volume.	Sp. Grav. observed.	Sp. Grav. calculated.	Condensation.
17	20	42.6261	0.9375	0.9112	263
16	20	39.3939	0.9402	0.9139	263
15	20	35.1818	0.9430	0.9167	263
14	20	30.9697	0.9458	0.9197	261
13	20	25.7576	0.9488	0.9229	259
12	20	21.5455	0.9518	0.9263	255
11	20	17.3333	0.9549	0.9300	249
10	20	13.1212	0.9580	0.9340	240
9	20	9.0091	0.9612	0.9382	230
8	20	5.0000	0.9644	0.9429	215
7	20	2.84849	0.9675	0.9479	196
6	20	2.72727	0.9707	0.9533	174
5	20	2.60626	0.9741	0.9593	148
4	20	2.48485	0.9777	0.9659	118
3	20	2.36364	0.9818	0.9731	87
2	20	2.24242	0.9865	0.9811	54
1	20	2.12121	0.9924	0.9900	24
0	20	20.0000	1.0000	1.0000	

It is to be remarked, that the condensation is greatest when 16½ ounces of alcohol have been added to 20 of water, and the condensation is $\frac{1}{17}$, or nearly $\frac{1}{18}$ th of the computed density. Since the specific gravity of alcohol is 0.825, it is evident that 16½ ounces of alcohol and 20 ounces of water have equal bulks. So that the condensation is greatest when the substances are mixed in equal volumes: and 18 gallons of alcohol mixed with 18 gallons of water will produce not 36 gallons of spirits, but 35 only.

We may also observe, that this is the mixture to which our revenue laws refer, declaring it to be *one to six* or *one in seven* under proof, and to weigh 7 pounds 12 ounce per gallon. This proportion was probably selected as the most easily compounded, viz. by mixing equal measures of water and of the strongest spirit which the known processes of distillation could produce. Its specific gravity is 0.939 very nearly.

We must consider this elaborate examination of the mixture of water and alcohol as a standard series of experiments, to which appeal may always be made, whether for the purposes of science or of trade. The regularity of the progression is so great, that in the column which we have examined, viz. that for temperature 62°, the greatest anomaly does not amount to one part in five thousand. The form of the series is also very judiciously chosen for the purposes of science. It would perhaps have been more directly beneficial had the proportions of the ingredients been stated in bulks, which are more immediately connected with density. But the author has assigned a very cogent reason for his choice, viz. that the proportion of bulks varies by a change of temperature, because the water and spirits follow different laws in their expansion by heat.

This is a proper opportunity for taking notice of a mistake which is very generally made in the conclusions drawn from experiments of this kind. Equal additions of the spirit or water produce a series of specific gravities, which decrease or increase by differences continually diminishing. Hence it is inferred that there is a contraction of bulk. Even Dr Lewis, one of our most judicious

continued

Sp. Gravity.

complicated naturalists, advances this position, in a dissertation on the potash of America; and it considerably affects his method for estimating the strength of the potash leys. But that it is a mistake, appears plainly from this, that although we add for ever equal quantities of the spirits, we shall never produce a mixture which has as small a specific gravity as alcohol. Therefore the series of successive gravities must approximate to this without end, like the ordinates of a hyperbolic curve referred to its asymptote.

That this may appear in the most general terms, let w represent the weight of the constant quantity of water in the mixture, and let a be the weight of the small addition of spirits. Also let w represent the bulk of this quantity of water, and b the bulk of the small addition of alcohol. The weight of the mixture is $w+a$, and its bulk is $w+b$, and its specific gravity is $\frac{w+a}{w+b}$.

If we now add a second equal quantity of spirits, the weight will be $w+2a$, and if the spirit retains its density unchanged, the bulk will be $w+2b$, and the specific gravity is $\frac{w+2a}{w+2b}$: and after any number m of such equal additions of spirits, the specific gravity will be $\frac{w+ma}{w+mb}$. Divide the numerator of this fraction by its denominator, and the quotient or specific gravity will be $1 + \frac{m \times a - b}{w + mb}$. This consists of the constant part 1,

and the variable part $\frac{m(a-b)}{w+mb}$. We need attend only to this part. If its denominator were constant, it is plain that the successive specific gravities would have equal differences, each being $= \frac{a-b}{w+mb}$, because m increases by the continual addition of an unit, and $a-b$ is a constant quantity. But the denominator $w+mb$ continually increases, and therefore the value of the fraction $\frac{a-b}{w+mb}$ continually diminishes.

Therefore the gradual diminution of the increments or decrements of specific gravity, by equal additions of one ingredient to a constant measure of the other, is not of itself an indication of a change of density of either of the ingredients; nor proves that in very diluted mixtures a greater proportion of one ingredient is absorbed or lodged in the interstices of the other, as is generally imagined. This must be ascertained by comparing each specific gravity with the gravity expressed by $1 + \frac{m(a-b)}{w+mb}$.

This series of specific gravities resembles such a numerical series as the following, 1;; 1.56; 1.63; 1.69; &c. the terms of which also consist of the constant integer 1, and the decimal fractions 0.156; 0.163; 0.169; &c. The fraction $\frac{m(a-b)}{w+mb}$ expresses this decimal part. Call this d , or make $d = \frac{m(a-b)}{w+mb}$.

This will give us $b = \frac{m(a-d)}{m(1+d)}$. Now a is the weight of the added ingredient, and d is the variable part of

Specific Gravity.

the specific gravity observed; and thus we learn whether b , the bulk of the added ingredient, suffers any change. We shall have occasion by and by to resume the consideration of this question, which is of the first moment in the theory of specific gravities, and has great influence in many transactions of commerce.

This series of specific gravities is not so well fitted for commercial transactions. In these the usual question is, how many gallons of alcohol is there in a cask, or some number of gallons of spirit? and it is more directly answered by means of a table, formed by mixing the ingredients in aliquot parts of one constant bulk. The following table, constructed from the experiments of Mr Brillon of the academy of Paris, and published in the Memoirs for 1769, is therefore inserted.

W.	A.	Density observed.	Density computed.	Condensation.	Bulk of 10000 grains.
0	16	0.8371	0.8371		1.0000
1	15	0.8527	0.8473	63	0.9937
2	14	0.8674	0.8575	115	0.9885
3	13	0.8815	0.8677	157	0.9844
4	12	0.8947	0.8778	189	0.9811
5	11	0.9075	0.8880	214	0.9786
6	10	0.9199	0.8982	235	0.9765
7	9	0.9317	0.9084	251	0.9749
8	8	0.9427	0.9186	256	0.9744
9	7	0.9519	0.9287	243	0.9757
10	6	0.9598	0.9389	217	0.9783
11	5	0.9674	0.9491	189	0.9811
12	4	0.9733	0.9593	144	0.9856
13	3	0.9791	0.9695	99	0.9901
14	2	0.9852	0.9796	57	0.9943
15	1	0.9919	0.9898	21	0.9979
16	0	1.0000	1.0000		1.0000

In this table the whole quantity of spirituous liquor is always the same. The first column is the number of measures (gallons, pints, inches, &c.) of water in the mixture: and column 2d gives the measures of alcohol. Column 3d is the specific gravity which was observed by Mr Brillon. Column 4th is the specific gravity which would have been observed if the spirits, or water, or both, had retained their specific density unchanged. And the 5th column marks the augmentation of specific gravity or density in parts of 10,000. A 6th column is added, showing the bulk of the 16 cubic measures of the two ingredients. Each measure may be conceived as the 16th part of 10,000, or 625; and we may suppose them cubic inches, pints, gallons, or any solid measure.

This table scarcely differs from Sir Charles Blagden's; and the very small difference that may be observed, arises from Mr Brillon's having used an alcohol not so completely rectified. Its specific gravity is 9,8371, whereas the other was only 0.8250.

Here it appears more distinctly that the condensation is greatest when the two ingredients are of equal bulk.

Perhaps this series of specific gravities is as declarative as the other, whether or not there is a change of density induced in either of the ingredients. The whole

Specific Gravity.

whole bulk being always the same, it is plain that the successive equal additions to one of the ingredients is a successive equal abstraction of the other. The change produced, therefore, in the weight of the whole, is the difference between the weight of the ingredient which is taken out and the weight of the equal measure of the other which supplies its place. Therefore, if neither ingredient changes its density by mixture, the weights of the mixtures will be in arithmetical progression. If they are not, there is a variation of density in one or both the ingredients.

We see this very clearly in the mixtures of water and alcohol. The first specific gravity differs from the second by 156, and the last differs from the preceding by no more than 81. Had neither of the densities changed, the common difference would have been 102. We observe also, that the augmentation of specific gravity, by the successive addition of a measure of water, grows less and less: till 12 measures of water is mixed with 4 of alcohol, when the augmentation is only 38, and then it increases again to 81.

It also appears, that the addition of one measure of water to a quantity of alcohol produces a greater change of density than the mixture of one measure of alcohol to a quantity of water. Hence some conclude, that the water disappears by being lodged in the interstices of the spirit. But it is more agreeable to the just notions which we can form of the internal constitution of tangible bodies to suppose that the particles of water diminish the distances between the particles of alcohol by their strong attractions, and that this diminution (exceedingly minute in itself) becomes sensible on account of the great number of particles whose distances are thus diminished. This is merely a probability founded on this, that it would require a much greater diminution of distances if it was the particles of water which had their distances thus diminished. But the greater probability is, that the condensation takes place in both.

We have been so particular in our consideration of this mixture, because the law of variation of density has, in this instance, been ascertained with such precision by the elaborate examination of Sir Charles Blagden, to that it may serve as an example of what happens in almost every mixture of bodies. It merits a still farther discussion, because it is intimately connected with the action of the cohesive forces, and an exact knowledge of the variations of distance between the particles will go far to ascertain the law of action of these forces. But the limits of a work like this will not permit us to dwell longer on this subject. We proceed therefore to give another useful table.

The vitriolic or sulphuric acid is of extensive use in manufactures under the name of oil of vitriol. Its value depends entirely on the saline ingredient, and the water is merely a vehicle for the acid. This, being much denser than water, affects its specific gravity, and thus gives us a method of ascertaining its strength.

The strongest oil of vitriol that can be easily manufactured contains 612½ grains of dry acid, united with 387½ grains of water, which cannot be separated from it by distillation, making 1000 grains of oil of vitriol. Its specific gravity in this state is 1.877.

The following table shows its specific gravity at the

temperature of 53° when diluted by the successive addition of parts of water by weight.

Specific Gravity.

O. Vit.	Water.	Specific Gravity.		
		Observed.	C. I. P. d.	Corr.
10	0	1.877	1.877	.000
	4	1.644	1.501	.143
	8	1.474	1.350	.124
	12	1.381	1.269	.112
	16	1.320	1.210	.110
	20	1.274	1.184	.090
	24	1.243	1.159	.084
	28	1.211	1.140	.071
	32	1.195	1.125	.070
	36	1.183	1.113	.070
	40	1.172	1.103	.070
	50	1.148	1.084	.064
	60	1.128	1.069	.059

Here is observed a much greater condensation than in the mixture of alcohol and water. But we cannot assign the proportion of ingredients which produces the greatest condensation; because we cannot, in any case, say what is the proportion of the saline and watery ingredients. The strongest oil of vitriol is already a watery solution; and it is by a considerable and uncertain detour that Mr Kirwan has assigned the proportion of C 12 and 388 nearly. If this be the true ratio, it is unlike every other solution that we are acquainted with; for in all solutions of salts, the salt occupies less room in its liquid form than it did when solid; and here it would be greatly the reverse.

This solution is remarkable also for the copious emergence of heat in its dilutions with more water. This has been ascribed to the great superiority of water in its capacity for heat; but there are facts which render this very doubtful. A vessel of water, and another of oil of vitriol, being brought from a cold room into a warm one, they both imbibe heat, and rise in their temperature; and the water employs nearly the same time to attain the temperature of the room.

Aquafortis or nitrous acid is another fluid very much employed in commerce; so that it is of importance to ascertain the relation between its saline strength and its specific gravity. We owe also to Mr Kirwan a table for this purpose.

The most concentrated state into which it can easily be brought is such, that 1000 grains of it consists of 563 grains of water and 437 of dry acid. In this state its specific gravity is 1.537. Let this be called *nitrous acid*.

Nit. Ac.	Water.	Specific Gravity.		
		Observed.	C. I. P. d.	Corr.
10	0	1.537	1.537	.000
	1	1.474	1.474	.000
	6	1.350	1.273	.0077
	11	1.269	1.191	.0078
	16	1.214	1.147	.0070
	21	1.175	1.120	.0055
	26	1.151	1.101	.0050
	31	1.127	1.087	.0040
	36	1.106	1.077	.0029
	41	1.086	1.068	.0018

There is not the same uniformity in the densities of this acid in its different states of dilution. This seems

owing

Specific Gravity.

owing to the variable proportion of the deleterious and vital air which compose this acid. It is more dense in proportion as it contains more of the latter ingredient.

The proportions of the aeriform ingredients of the muriatic acid are so very variable, and so little under our command, that we cannot frame tables of its specific gravity which would enable us to judge of its strength.

It is a general property of these acids, that they are more expandible by heat as they are more concentrated.

There is another class of fluids which it would be of great consequence to reduce to some rules with respect to specific gravity, namely, the solutions of salts, gums, and resins. It is interesting to the philosopher to know in what manner salts are contained in these watery solutions, and to discover the relation between their strength and density; and to the man of business it would be a most desirable thing to have a criterion of the quantity of salt in any brine, or of extractable matter in a decoction. It would be equally desirable to those who are to purchase them as to those who manufacture or employ them. Perhaps we might ascertain in this way the value of sugar, depending on the quantity of sweetening matter which it contains; a thing which at present rests on the vague determination of the eye or palate. It would therefore be doing a great service to the public, if some intelligent person would undertake a train of experiments with this view. Accuracy alone is required; and it may be left to the philosophers to compare the facts, and draw the consequences respecting the internal arrangement of the particles.

One circumstance in the solution of salts is very general; and we are inclined, for serious reasons, to think it universal: this is a diminution of bulk. This indeed in some salts is inconsiderable. Sedative salt, for instance, hardly shows any diminution, and might be considered as an exception, were it not the single instance. This circumstance, and some considerations connected with our notions of this kind of solution, dispose us to think that this salt differs in contraction from others only in degree, and that there is some, though it was not sensible, in the experiments hitherto made.

These experiments, indeed, have not been numerous. Those of Mr Achard of Berlin, and of Dr Richard Watson of Cambridge, are perhaps the only ones of which we have a descriptive narration, by which we can judge of the validity of the inferences drawn from them. The subject is not susceptible of much accuracy; for salts in their solid form are seldom free from cavities and shivery interstices, which do not admit the water on their first immersion, and thereby appear of greater bulk when we attempt to measure their specific gravity by weighing them in fluids which do not dissolve them, such as spirits of turpentine. They also attach to themselves, with considerable tenacity, a quantity of atmospheric air, which merely adheres, but makes no part of their composition. This escapes in the act of solution, being set at liberty by the stronger affinity of the water. Sal gem, however, and a few others, may be very accurately measured; and in these instances the degree of contraction is very constant.

The following experiments of Dr Watson appear to

us the most instructive as to this circumstance. A glass vessel was used, having a slender cylindrical neck, and holding 67 ounces of pure water when filled to a certain mark. The neck above this mark had a scale of equal parts passed on it. It was filled to the mark with water. Twenty-four pennyweights of salt were thrown into it as speedily as possible, and the bulk of the salt was measured by the elevation of the water. Every thing was attended to which could retard the immediate solution, that the error arising from the solution of the first particles, before the rest could be put in, might be as small as possible; and in order that both the absolute bulk and its variations might be obtained by some known scale, 24 pennyweights of water were put in. This raised the surface 58 parts of the scale. Now we know exactly the bulk of 24 pennyweights of pure water. It is 2.275 cubic inches; and thus we obtain every thing in absolute measures: And by comparing the bulk of each salt, both at its first immersion and after its complete solution, we obtain its specific gravity, and the change made on it in passing from a solid to a fluid form. The following table is an abstract of these experiments. The first column of numbers is the elevation of the surface immediately after immersion; the second gives the elevation when the salt is completely dissolved; and the third and fourth columns are the specific gravities of the salts in these two states.

Specific Gravity.

Twenty-four Pennyweights.	I.	II.	III.	IV.
Water -	58			
Glauber's salt -	42	36	1.380	1.611
Mild volatile alkali -	40	33	1.450	1.787
Sal ammoniac -	40	39	1.450	1.487
Refined white sugar -	39	36	1.487	1.611
Coarse brown sugar -	39	36	1.487	1.611
White sugar candy -	37	36	1.567	1.611
Lymington Glauber's salt -	35	29	1.657	2.000
Terra foliata tartari -	37	30	1.567	1.933
Rochelle salt -	33	28	1.757	2.071
Alum not quite dissolved -	33	28	1.757	2.061
Borax not one-half dissolved in two days -	33	31	1.757	
Green vitriol -	32	26	1.812	2.230
White vitriol -	32	24	1.933	2.416
Nitre -	32	21	1.933	2.766
Sal gem from Northwich -	27	17	2.143	3.411
Blue vitriol -	26	20	2.230	2.900
Peal ashes -	25	10	2.320	3.800
Tart. vitriolatus -	22	11	2.636	5.272
Green vitriol calcined to white -	22	11	2.636	5.272
Dry salt of tartar -	21	13	2.761	4.461
Basket sea-salt -	19	15	3.052	3.866
Corrosive sublimate -	14	10	4.142	3.800
Turbith mineral -	9	0	6.444	

The inspection of this list naturally suggests two states of the case as particularly interesting to the philosopher studying the theory of solution. The first state is when the lixivium approaches to saturation. In the very point of saturation any addition of salt retains its bulk unchanged. In diluted brines, we shall see that the den-

density

city of the fluid salt is greater, and gradually diminishes as we add more salt. It is an important question, Whether this diminution goes on continually, till the fluid density of the salt is the same with its solid density? or, Whether there is an abrupt passage from some degree of the one to the fixed degree of the other, as we observe in the freezing of iron, the setting of fluxes, and some other instances?

The other interesting state is that of extreme dilution, when the differences between the successive densities bear a great proportion to the densities themselves, and thus enable the mathematician to ascertain with some precision the variations of corporeal force, in consequence of a variation of distance between the particles. The sketch of an investigation of this important question given by Boërovich, in his Theory of Natural Philosophy, is very promising, and should incite the philosophical chemist to the study. The first thing to be done is to compare the law of specific gravity; that is, the relation between the specific gravity and quantity of salt held in solution.

Wishing to make this work as useful as possible, we have searched for experiments, and trains of experiments, on the density of the many brines which make important articles of commerce; but we were mortified by the scantiness of the information, and disappointed in our hopes of being able to combine the detached observations, failed to the immediate views of their authors, in such a manner as to deduce from them scales (as they may be called) of their strength. We rarely found these detached observations attended with circumstances which would connect them with others; and there was frequently such a discrepancy, nay opposition, in series of experiments made for ascertaining the relation between the density and the strength, that we could not obtain general principles which enable us to construct tables of strength *à priori*.

Mr Lambert, one of the first mathematicians and philosophers of Europe, in a dissertation in the Berlin Memoirs (1762), gives a narration of experiments on the brines of common salt, from which he deduces a very great condensation, which he attributes to an absorption in the weak brines of the salt, or a lodgement of its particles in the interstices of the particles of water. Mr Achard of the same academy, in 1785, gives a very great list of experiments on the bulks of various brines, made in a different way, which show no such intension; and Dr Watson thinks this confirmed by experiments which he narrates in his Chemical Essays. We see great reason for hesitating our assent to either side, and do not think the experiments decisive. We incline to Mr Lambert's opinion; for this reason, that in the successive dilutions of oil of vitriol and aquafortis there is a most evident and remarkable condensation. Now what are these two brines, of which we have not been able to get the saline ingredient in a separate form? The experiments of Mr Achard and Dr Watson were made in such a way that a single grain in the measurement here to create a proportion to the whole change of specific gravity. At the same time, some of Dr Watson's are so single in their nature that it is very difficult to withhold the assent.

In this case of uncertainty, in a subject which seems to us to be of a little importance, we thought it our duty to undertake a train of experiments to which responsibility always belongs. Work like this

are seldom considered as sources of original information; and it is thought sufficient when the knowledge already diffused is judiciously compiled. But a due respect for the public, and gratitude for the very honourable recognition hitherto given to our labours, induce us to exert ourselves with honest zeal to merit the continuance of public favour. We assure our readers that the experiments were made with care, and in quantities sufficiently large to make the unavoidable irregularities in such cases quite insignificant. The law of density was ascertained in each substance in two ways. We dissolved different portions of salt in the same quantity of water, and examined the specific gravity of the brine by weighing it in a vessel with a narrow neck. The portions of salt were each of them one eighth of what would make a nearly saturated solution of the temperature 55°. We did not make the brine stronger, that there might be no risk of a precipitation in form of crystals. We considered the specific gravities as the ordinates of a curve, of which the abscissæ were the numbers of ounces of dry salt contained in a cubic foot of the brine. Having thus obtained eight ordinates corresponding to 1, 2, 3, 4, 5, 6, 7, and 8 portions of salt, the ordinates or specific gravities for every other proportion of salt were had by the usual methods of interpolation.

The other method was, by first making a brine nearly saturated, in which the proportion of salt and water was exactly determined. We then took out one eighth of the brine, and filled up the vessel with water, taking care that the mixture should be complete; for which purpose, besides agitation, the diluted brine was allowed to remain 24 hours before weighing. Taking out one eighth of the brine also takes out one eighth of the salt; so that the proportion of salt and water in the diluted brine was known. It was now weighed, and thus we determined the specific gravity for a new proportion of salt and water.

We then took out one seventh of the brine. It is evident that this takes out one eighth of the original quantity of salt; an abstraction equal to the former. We filled the vessel with water with the same precautions; and in the same manner we proceeded till there remained only one eighth of the original quantity of salt.

The specific gravities by these two methods agreed extremely well. In the very deliquescent salts the first method exhibited some small irregularities, arising from the unequal quantities of water which they had imbibed from the atmosphere. We therefore confined most in the experiments made with diluted brines.

That the reader may judge of the authority of the tables which we shall insert, we submit to his inspection one series of experiments.

Two thousand one hundred and eighty-eight grains of very pure and dry (but not decrepitated) common salt, prepared in large crystals, were dissolved in 6562 grains of distilled water of the temperature 55°. A small matrass with a narrow neck, which held 425.5 grains of distilled water, was filled with this brine. Its contents weighed 5227 grains. Now $6562 \div 2585 = 2537 = 5227 - 2690$. Therefore the bottle of brine contained 12567.5 grains of salt dissolved in 5772.5 grains of water. Its specific gravity is $\frac{5227}{2585} = 2.0217$, or 1.060875; and a cubic foot of brine weigh-

Specific Gravity.

1196.9 ounces avoirdupois. Also 5027 : 1256.75 = 1196.9 : 299.28. Therefore a cubic foot of this brine contains 299.28 ounces of perfectly dry salt.

The subsequent steps of the process are represented as follows.

Salt.	Brine.	Water.	Wt. of Cub. Ft.	Salt in Cub. Ft.
8) 1256.75 157.1	8) 5027 628.4	3770.25 = $\frac{1}{2}$ of brine.	1196.9	299.28 37.41
	4598.6 527.4	Remains. Water to fill it again.		
7) 1099.6 157.1	7) 4026.0 703.7	2d Brine. $\frac{1}{2}$ taken out.	1172.7	261.87 37.41
	4222.3 604.7	Water added.		
942.5 157.1	6) 4827.0 804.5	3d Brine. Taken out.	1149.3	224.46
	4022.5 706.5	Remains. Water added.		
785.4 157.1	5) 4729.0 946	4th Brine. Taken out.	1125.9	187.05
	3783 847	Remains. Water added.		
628.3 157.1	4) 4630 1157.5	5th Brine. Taken out.	1102.3	149.64
	3472.5 1054.5	Remains. Water added.		
471.2 157.1	3) 4527 1509	6th Brine. Taken out.	1077.9	112.25
	5018 1405	Remains. Water added.		
314.1 157.1	2) 4423 2212	7th Brine. Taken out.	1053.3	74.82
	2211 2102	Remains. Water added.		
157.0	4313	8th Brine.	1027.9	37.41

Thus, by repeated abstraction of brine, so as always to take out $\frac{1}{2}$ th of the salt contained in one constant bulk, we have obtained a brine consisting of 157 grains of salt united with 4313—157, or 4156 grains of water.

Its specific gravity is $\frac{4313}{4256} = 1.0279$, and a cubic foot of it weighs 1028 ounces, and contains 37.4 ounces of dry salt. In like manner may the specific gravity, the weight of a cubic foot, and the salt it contains, be estimated for the intermediate brines.

When these eight quantities of salt contained in a

cubic foot are made the abscissæ, and the weights of the cubic foot of brine are the corresponding ordinates, the curve will be found to be extremely regular, resembling a hyperbolic arch whose asymptote makes an angle of 35° with the axis. Ordinates were then interpolated analytically for every 10 ounces of contained salt, and thus the table was constructed. We did not, however, reit it on one series alone; but made others, in which one-fourth of the salt was repeatedly abstracted. They agreed, in the case of common salt, with great exactness, and in some others there were some very inconsiderable irregularities.

To show the authority of the tables of strength by no means our only motive for giving an example of the process. It may be of use as a pattern for similar experiments. But, besides, it is very instructive. We see, in the first place, that there is a very sensible change of density in one or both of the ingredients. For the series is of that nature (as we have formerly explained), that if the ingredients retained their densities in every proportion of commixture, the specific gravities would have been in arithmetical progression; whereas we see that their differences continually diminish as the brines grow more dense. We can form some notion of this by comparing the different brines. Thus in the first brine, weighing 5027 grains, there are 3770 grains of water in a vessel holding 4200. If the density of the water remains the same, there is left for the salt only as much space as would hold 430 grains of water. In this space are lodged 1257 grains of salt, and its specific gravity, in its liquid form, is $\frac{1257}{430} = 2.907$ very nearly. But in the 8th brine the quantity of water is 4156, the space left for 157 grains of salt is only the bulk of 44 grains of water, and the density of the salt is $\frac{157}{44} = 3.568$, considerably greater than before. This induced us to continue the dilution of the brine as follows, beginning with the 8th brine.

157	2) 4313	8th brine
78.5	2156.5	
	2156.5	
	2105.5	
78.5	2) 2620	9th brine
39.7	2131	
	2102	
39.7	2) 2233	10th brine
	2116.5	
	2116.5	
	2102	
19.8	4218	11th brine.

This last brine contains 4198.2 grains of water, leaving only the bulk of 1.8 grains of water to contain 19.8 of salt, so that the salt is ten times denser than water. This will make the strength 243 instead of 210 indicated by the specific gravity. But we do not pretend to measure the densities with accuracy in these diluted brines. It is evident from the process that a

Specific Gravity.

Specific Gravity.

single grain of excess or defect in taking out the brine and replacing it with water has a sensible proportion to the whole variation. But we see with sufficient evidence, that from the strong to the weak brines the space left for the portion of salt is continually diminishing. In the first dilution 527½ grains of water were added to fill up the vessel; but one-eighth of its contents of pure water is only 52½; so that here is a diminution of two grains and a half in the space occupied by the remaining salt. The subsequent additions are 604.7; 706.5; 847; 1051.5; 1455.1; 2102; 2105.5; 2102; 2102; instead of 600; 700; 840; 1050; 1400; 2100; 2100; 2100; 2100. Nothing can more plainly show the condensation in general, though we do not learn whether it happens in one or both of the ingredients; nor do the experiments show with sufficient accuracy the progression of this diminution. The excesses of the added water being only six or seven grains, we cannot expect a nice repartition. When the brine is taken out, the upper part of the vessel remains lined with a briny film containing a portion of salt and water, perhaps equal or superior to the differences. Had our time permitted, we should have examined this matter with scrupulous attention, using a vessel with a still narrower neck, and in each dilution abstracting one half of the brine. The curve, whose abscissæ and ordinates represent the weight of the contained salt and the weight of a constant bulk of the brine, exhibits the best and most synoptical view of the law of condensation, because the position of the tangent in any point, or the

value of the symbol $\frac{d}{dt}$, always shows the rate at which

the specific gravity increases or diminishes. We are inclined to think that the curve in all cases is of the hyperbolic kind, and complete; that is, having the tangent perpendicular to the axis at the beginning of the curve. The mathematical reader will easily guess the physical notions which incline us to this opinion; and will also see that it is hardly possible to discover this experimentally, because the mistake of a single grain in the very small ordinates will change the position of the tangent many degrees. It was for this reason that we thought it useless to prosecute the dilution any farther. But we think that it may be prosecuted much farther in Dr Watson's or Mr Achard's method, viz. by dissolving equal weights of salt in two vessels, of very different capacities, having tubular necks, in which the change of bulk may be very accurately observed. We can only conclude, that the condensation is greater in the strongest brines, and probably attains its maximum when the quantities of true saline matter and water are nearly equal, as in the case of vitriolic acid, &c.

We consider these experiments as abundantly sufficient for deciding the question "Whether the salt can be received into the pores of the water, or the water into the pores of the salt, so as to increase its weight without increasing its bulk;" and we must grant that it may. We do not mean that it is simply lodged in the pores, as sand is lodged in the interstices of small shot; but the two together occupy less room than when separate. The experiments of Mr Achard were insufficient for a decision, because made on so small a quantity as 600 grains of water. Dr Watson's experiments have, for the most part, the same defect. Some of them, however, are of great value in this question, and are very fit for ascer-

taining the specific gravity of dissolved salts. In one of them (not particularly narrated) he found that a quantity of dissolved salt occupied the same bulk in two very different states of dilution. We cannot pretend to reconcile this with our experiments. We have given these as they stood; and we think them conclusive, because they were so numerous and so perfectly consistent with each other; and their result is so general, that we have not found an exception. Common salt is by no means the most remarkable instance of condensation. Vegetable alkali, sal ammoniac, and some others, exhibit much condensation.

We thought this a proper opportunity of considering this question, which is intimately connected with the principles of chemical dilution, and was not perhaps considered in sufficient detail under the article CHEMISTRY. We learn from it in general, that the quantities of salt in brines increase at somewhat a greater rate than their specific gravities. This difference is in many cases of sensible importance in a commercial view. Thus an alkaline lixivium for the purposes of bleaching or soap-making, whose specific gravity is 1.234, or exceeds that of water by 234, contains 361 ounces of salt in a cubic foot; a ley, which exceeds the weight of water twice as much, or 468 ounces per cubic foot, contains 777 ounces of salt, which exceeds the double of 361 by 55 ounces more than that seven per cent. Hence we learn, that hydrometers for discovering the strength of brines, having equal divisions on a cylindrical stem, are very erroneous; for even if the increments of specific gravity were proportional to the quantities of salt in a gallon of brine, the divisions at the bottom of the stem ought to be smaller than those above.

The construction of the following table of strengths from the above narrated series of brines is sufficiently obvious. Column 1st is the specific gravity as discovered by the balance or hydrometer, and also is the number of ounces in a cubic foot of the brine. Col. 2d is the ounces of the dry salt contained in it.

TABLE of Brines of Common Salt.

Weight (Cub. Ft. Brine.)	Salt in (Cub. Ft.)	Weight (Cub. Ft. Brine.)	Salt in (Cub. Ft.)
1.000	0	1.115	170
1.008	10	1.122	180
1.015	20	1.128	190
1.022	30	1.134	200
1.029	40	1.140	210
1.036	50	1.147	220
1.043	60	1.153	230
1.050	70	1.159	240
1.057	80	1.165	250
1.064	90	1.172	260
1.070	100	1.178	270
1.077	110	1.184	280
1.083	120	1.190	290
1.090	130	1.197	300
1.096	140	1.203	310
1.103	150	1.209	316
1.109	160	1.208	320

Specific Gravity.

Specific
Gravity.

The table differs considerably from Mr Lambert's. The quantities of salt corresponding to any specific gravity are about $\frac{1}{4}$ th less than in his table. But the reader will see that they correspond with the series of experiments above narrated; and these were but a few of many which all corresponded within an hundredth part. The cause of the difference seems to be, that most kinds of common salt contain magnesian salts, which contain a very great proportion of water necessary for their crystallization. The salt which we used was of the purest kind, but such as may be had from every salt work, by Lord Dandonville's very easy process, viz. by passing through it a saturated solution boiling hot, which carries off with it about four-fifths of all the bitter salts. Our aim being to ascertain the quantities of pure sea-salt, and to learn by the bye its relation to water in respect of density, we thought it necessary to use the purest salt. We also dried it for several days in a stove, so that it contained no water not absolutely necessary for its crystallization. An ounce of such salt will communicate a greater specific gravity to water than an ounce of a salt that is less pure, or that contains extraneous water.

The specific gravity 1.209 is that of ordinary pickles, which are estimated as to strength by floating an egg.

We cannot raise the specific gravity higher than 1.226 by simply dissolving salt in cold water. But it will become much denser, and will even attain the specific gravity 1.242 by boiling, then holding about 366 ounces in the cubic foot of hot brine. But it will deposit by cooling, and when of the temperature 55° or 60°, hardly exceeds 1.226. We obtained a brine by boiling till the salt grained very rapidly. When it cooled to 65°, its specific gravity was 1.2263; for a vessel which held 3506 grains of distilled water held 4229 of this brine. This was evaporated to dryness, and there were obtained 1344 grains of salt. By this was computed the number interposed between 310 and 320 in the table. We have, however, raised the specific gravity to 1.217, by putting in no more salt than was necessary for this density, and using heat. It then cooled down to 65° without quitting any salt; but if a few grains of salt be thrown into this brine, it will quickly acquire a great deal more, and its density will decrease to 1.226. We find this to hold in all salts; and it is a very inclusive fact in the theory of crystallization; it resembles the effect which a magnet produces upon iron filings in its neighbourhood. It makes them temporary magnets, and causes them to arrange themselves as if they had been really made permanent magnets. Just as a crystal already formed disposes the rest to crystallize. We imagine that this analogy is complete, and that the forces are similar in both cases.

The above table is computed for the temperature 55°; but in other temperatures the strength will be different on two accounts, viz. the expansion of the brine and the dissolving power of the water. Water expands about 42 parts in 1000 when heated from 65° to 212°. Saturated brine expands about 48 parts, or one-fifth more than water; and this excess of expansion is nearly proportional to the quantity of salt in the brine. If therefore any circumstance should oblige us to examine a brine in a temperature much above 65°, allowance should be made for this. Thus, should the specific gravity of brine of the temperature 130° (which is nearly half way

Specific
Gravity.

between 60 and 212) be 1.140, we must increase it by 20 (half of 40); and having found the strength 240 corresponding to this corrected specific gravity, we must correct it again by adding 1 to the specific gravity for every 45 ounces of salt.

But a much greater and more uncertain correction is necessary on account of the variation of the dissolving power of water by heat. This indeed is very small in the case of sea-salt in comparison with other salts. We presume that our readers are apprised of this peculiarity of sea-salt, that it dissolves nearly in equal quantities in hot or in cold water. But although water of the temperature 60 will not dissolve more than 320 or 325 ounces of the purest and dryest sea-salt, it will take up above 25 ounces more by boiling on it. When thus saturated to the utmost, and allowed to cool, it does not quit any of it till it is far cooled, viz. near to 60°. It then deposits this redundant salt, and holds the rest till it is just going to freeze, when it lets it go in the instant of freezing. If evaporated in the state in which it continues to hold the salt, it will yield above 400 ounces per cubic foot of brine, in good crystals, but rather overcharged with water. And since in this state the cubic foot of brine weighs about 1220 ounces, it follows, that 820 ounces of water will, by boiling, dissolve 400 of crystallized salt.

The table shows how much any brine must be boiled down in order to grain. Having observed its specific gravity, find in the table the quantity of salt corresponding. Call this x . Then, since a boiling hot graining or saturated solution contains 340 ounces in the cubic foot of

brine, say $340 : 1000 :: \frac{1000}{340} x$. This is the bulk

to which every cubic foot (valued at 1000) must be boiled down. Thus suppose the brine has the specific gravity 1109. It holds 160 ounces per foot, and we

must boil it down to $\frac{1000 \times 160}{340}$ or 471; that is, we

must boil off $\frac{529}{1000}$ of every cubic foot or gallon.

These remarks are of importance in the manufacture of common salt; they enable us to appreciate the value of salt springs, and to know how far it may be prudent to engage in the manufacture. For the doctrine of latent heat assures us, that in order to boil off a certain quantity of water, a certain quantity of heat is indispensably necessary. After the most judicious application of this heat, the consumption of fuel may be too expensive.

The specific gravity of sea water in these climates does not exceed 1.023, or the cubic foot weighs 1020 ounces, and it contains about 41 ounces of salt. The brine-pits in England are vastly richer; but in many parts of the world brines are boiled for salt which do not contain above 12 or 20 ounces in the cubic foot.

In buying salt by weight, it is of importance to know the degree of humidity. A salt will appear pretty dry (if free from magnesian salts) though moistened with one per cent. of water; and it is found that incipient humidity exposes it much to further deliquescence. A much smaller degree of humidity may be discovered by the specific gravity of a brine made with a few ounces of the salt. And the inspection of the table informs us,

that

Specific Gravity.

that the brine should be weak; for the differences of specific gravity go on diminishing in the stronger brines: 300 ounces of dry salt dissolved in 807 ounces of water should give the specific gravity 1197. Suppose it be but 1190, the quantity of salt corresponding is only 295; but when mixed with 807 ounces of water, the weight is 1197, although the cubic foot is only 1190. There is therefore more than a cubic foot of the brine, and there is as much salt as will make more than a cubic foot of the weight 1190. There is $290 \times \frac{1197}{1190}$, or 291 $\frac{1}{2}$ ounces, and there is 8 $\frac{1}{2}$ ounces of water attached to the salt.

The various informations which we have pointed out as deducible from a knowledge of the specific gravity of the brines of common fait, will serve to suggest several advantages of the knowledge of this circumstance in other lixivia. We shall not therefore resume them, but simply give another table or two of such as are most interesting. Of these, alkaline leys are the chief, being of extensive use in bleaching, soap-making, glass-making, &c.

We therefore made a very strong ley of the purest vegetable alkali that is ever used in the manufactories, not thinking it necessary, or even proper, to take it in

its state of utmost purity, as obtained from cubic nitre and the like. We took fait of tartar from the apothecary, perfectly dry, of which 3963 grains were dissolved in 3540 grains of distilled water; and after agitation for several days, and then standing to deposit sediment, the clear ley was decanted. It was again agitated; because, when of this strength, it becomes, in a very short time, rarer above and denser at the bottom. A flask containing 4200 grains of water held 6165 of this ley when of the temperature 3°. Its specific gravity was therefore 1.4678, and the 6165 grains of ley contained 3264 grains of fait. We examined its specific gravity in different states of dilution, till we came to a brine containing 51 grains of fait, and 4189 grains of water, and the contents of the flask weighed 4240 grains: its specific gravity was therefore 1.2093. In this train of experiments the progression was most regular and satisfactory; so that when we constructed the curve of specific gravities geometrically, none of the points deviated from a most regular curve. It was considerably more incurvated near its commencement than the curve for sea-salt, indicating a much greater condensation in the diluted brines. We think that the following table, constructed in the same manner as that for common fait, may be depended on as very exact.

Spes. G. Grav. 119.

Weight of Cub. Foot, oz.	Salt cont. oz.	Weight of Cub. Foot oz.	Salt cont. oz.	Weight of Cub. Foot oz.	Salt cont. oz.	Weight of Cub. Foot oz.	Salt cont. oz.
1000	0	1174	260	1329	520	1471	780
1016	20	1187	280	1340	540	1482	800
1031	40	1200	300	1351	560	1493	820
1045	60	1212	320	1362	580	1504	840
1058	80	1223	340	1372	600	1515	860
1071	100	1236	360	1383	620	1526	880
1084	120	1248	380	1395	640	1537	900
1098	140	1259	400	1406	660	1547	920
1112	160	1270	420	1417	680	1557	940
1125	180	1281	440	1428	700	1567	960
1138	200	1293	460	1438	720	1577	980
1150	220	1305	480	1449	740	1586	1000
1162	240	1317	500	1460	760		

We see the same augmentation of the density of the fait in the diluted brines here as in the case of common fait. Thus a brine, of which the cubic foot weighs 1482 ounces, or which has the specific gravity 1.482, contains 800 ounces of dry alkali and 682 of water. Therefore, if we suppose the density of the water unchanged, there remains the bulk of 318 ounces of water

to receive 840 ounces of fait: its density is therefore $\frac{840}{318}$

= 2.512 nearly. But in the line whose weight per foot is only 1216 there are 20 ounces of fait, and therefore 996 of water; and there is only four ounce-measures of water, that is, the bulk of four ounces of water, to receive 20 ounces of fait. Its specific gravity there-

fore is $\frac{20}{4}$ = 5, almost twice as great as in the strong brine. Accordingly Mr Adlard is disposed to admit the

absorption (as it is carelessly termed) in the case of fait tart. But it is a general (we think an universal) fact in the solution of salts. It must be carefully distinguished from the fait contraction of bulk which salts undergo in passing from a solid to a fluid form. The contraction now under consideration is analogous to the contraction of oil of vitriol when diluted with water; for oil of vitriol must be considered as a very strong brine which we cannot dephlegmate by distillation, and therefore cannot obtain the dry saline ingredient in a separate form, so as to observe its solid density, and say how much it contracts in first becoming fluid. The way of conceiving the fait contraction in the act of solution as a lodging of the particles of the one ingredient on the interstices of the other, "qu'il se nichent, en augmentant le poids sans effectuer le volume de la saumure," as Euler and Linnæus express themselves, is impossible, i. e., when both are fluids. Indeed it is but a loosely way of

the Phil.

Sp. Gr.
Gravity.

thinking in either case, and should be avoided, because inadvertent persons are apt to use as a physical principle what is merely a mode of speech.

We learn from the table, that a hydrometer with equal-distant divisions on a cylindrical or prismatic stem is still more erroneous than in the brines of common salt.

We learn from the experiments of Kirwan, Lavoisier, and others, that dry salt of tartar contains about one-fourth of its weight of fixed air. In many applications of this salt to the purposes of manufacture, this ingredient is of no use. In some it is hurtful, and must be abstracted by lime. Soap-maker's ley consists of the pure alkaline salt dissolved in water. It is therefore of importance to ascertain its quantity by means of the specific gravity of the brine. For this purpose we took a ley of fil tart. whose specific gravity was 1.22417, containing 314 ounces of mild alkali in a cubic foot of ley, and we rendered it nearly caustic by lime. The specific gravity was then 1.1897. This is a very unexpected result. Nothing is employed with more success than quicklime for dephlegmating any watery fluid. We should rather have expected an increase of specific gravity by the abstraction of some of the water of the menstruum, and perhaps the water of the crystallization, and the aerial part of the salt. But we must ascribe this to the great density in which the fixed air exists in the mild alkali.

It is unnecessary to give similar tables for all the salts, unless we were writing a dissertation on the theory of their solution. We shall only observe, that we examined with particular attention sal ammoniac, because Mr Achar, who denies what is called the absorption of salts, finds himself obliged to allow something like it in this salt. It does not, however, differ from those of which we have given an account in detail in any other respect than this, that the changes of fluid density are much less than in others (instead of being greater, as Achar's experiments seem to indicate) in all brines of moderate strength. But in the very weak brines there is indeed a remarkable difference; and if we have not committed an error in our examination, the addition of one part of sal ammoniac to 64 of water occupies less room than the water alone. We think that we have met with this as an accidental remark by some author, whose work we do not recollect. But we do not choose to rest so much on our form of the experiment in such weak brines. The following mixtures will abundantly serve for constructing the table of its strength: Sal ammoniac = 950 grains was dissolved in 3506 grains of water, making a brine of 4466 grains. A phial which held 1600 grains water held 1698 of this brine. It contained

$\frac{1698 \times 950}{4466}$, or 365 grains of salt. The specific gra-

vity was $\frac{1698}{1600} = 1.061$, and the cubic foot weighed

1061 ounces. It also contained $\frac{1061 \times 365}{1698}$, or 288

ounces of salt. By repeated abstraction of brine, and replacing with water, we had the following series:

Series	Brine.	Sp. Gr.	Oz. Salt in Cub. Ft.	Specific Gravity, in Scales.
Weight of brine,	1 <i>l</i> , 1698	1.061	228	
After taking out $\frac{1}{2}$,	2 <i>l</i> , 1676	1.048	171	
After taking out $\frac{2}{3}$,	3 <i>l</i> , 1653	1.033	114	
After taking out $\frac{3}{4}$,	4 <i>l</i> , 1630	1.019	57	
After taking out $\frac{4}{5}$,	5 <i>l</i> , 1616	1.012	28 <i>l</i>	
$\frac{4}{5}$,	6 <i>l</i> , 1610	1.0263	14 <i>l</i>	
$\frac{4}{5}$,	7 <i>l</i> , 1605	1.0238	7 <i>l</i>	

This series is extremely regular, and the progress of density may be confidently deduced from it.

From the whole of this disquisition on the relation between the specific gravities of brines and the quantities of salt contained, we see in general that it may be guessed at, with a useful degree of precision, from the density or specific gravity of saturated solutions. We therefore conclude with a list of the specific gravities of several saturated solutions, made with great care by the bishop of Landaff.—The temperature was 42°. The first numerical column is the density of saturated brine, and the next is the density of a brine consisting of 12 parts (by weight) of water and one of salt. From this may be inferred the quantity in the saturated solution, and from this again may be inferred the quantity corresponding to inferior densities.

Borax,	1.910		
Cor. Sublim.	1.037		
Alum,	1.033		
Glaub. salt,	1.054	1.029	
Common salt,	1.198	1.059	
Sal. cath. amar.	1.232	1.039	
Sal ammon.	1.072	1.026	
Vol. alk. nitre,	1.087		
Nitre,	1.095	1.050	
Rochelle salt,	1.114		
Blue vitriol,	1.150	1.052	
Green vitriol,	1.157	1.043	
White vitriol,	1.386	1.045	
Pearl ash,	1.534		

SPECTACLES, in *Dioptrics*, a machine consisting of two lenses set in silver, horn, &c. to assist the defects of the organ of sight. Old people, and others who have flat eyes, use convex spectacles, which cause the rays of light to converge so as to meet upon the retina: whereas myopes, or short-sighted people, use concave lenses for spectacles, which cause the rays to diverge, and prevent their meeting ere they reach the retina. See OPTICS.

Some cases of a peculiar nature have been met with where the sight receives no assistance from the use of either convex or concave glasses. To remedy this, the following method was contrived and successfully adopted. A man about sixty years of age having almost entirely lost his sight, could see nothing but a kind of thick mist with little black specks in it which seemed to float in the air. He could neither read, walk the streets, nor distinguish his friends who were most familiar to him. In this deplorable situation he procured some spectacles with large rings; and having taken out the glasses,

lised by many (see *SECOND Sight*); viz. that future events are foretold by certain individuals by means of spectral representation.

So general has the belief of spectres been, that this circumstance alone may be thought by some sufficient to prove that it must have its foundation in human nature, or must rest upon rational evidence. When any doctrine has been universally received by all nations, by generations living several thousand years from one another, and by people in all the different stages of society, there is certainly the strongest presumption to conclude that such a doctrine has its foundation in reason and in truth. In this way we argue in favour of the existence of a God, concerning moral distinction, and the doctrine of a future state: and certainly so far we argue well. But if the same argument be applied to idolatry, to sacrifices, or to apparitions, we shall find that it is applied improperly. Idolatry was very general among ancient nations; so was the offering of sacrifices, so was polytheism: but they were by no means universal. Should we allow, for the sake of shortening the argument, that all ancient nations were polytheists and idolaters, and presented oblations to their imaginary deities, all that could be concluded from this concession is, that they fell into these mistakes from their ignorance and from the rude state of society, from which their imperfect knowledge of theology and moral philosophy was never able to rescue them. Those erroneous notions fled before the brighteners of the Christian system; while the doctrines of the existence of God, of moral distinction, and of a future state, have been more thoroughly confirmed and ascertained. The same thing may be said of the belief of spectres. However generally it has been adopted in the first stages of society, or by civilized nations who had made but little progress in the study of divine things, it has been rejected, we may say invariably, wherever theology and philosophy have gone hand in hand.

As all popular and long established opinions are objects of curiosity and research for the philosopher, we think the belief of spectres worthy of some attention even in this light. It will therefore, we hope, give some satisfaction to the philosophical reader to see a short account of the sources or principles from which this belief is derived. But as the belief of spectres is connected with other opinions which appear to us highly injurious to religion; opinions which have been supported by many learned men, and which are still believed by some men of literary education—it will also be proper, in the first place, to consider the evidence on which this belief rests, in which we must consider both their probability and credibility.

In the present investigation we mean to set aside altogether the celestial appearances recorded in Scripture, as being founded on unquestionable evidence, and perfectly agreeable to those rules by which the Deity acts in the usual course of his Providence. The Israelites, during the existence of their state, were immediately under the authority of God, not only as the moral governor of the world, but as the king of Israel. In the infancy of the world, while men were rude and unenlightened, and entirely under the influence of idolatry, many revelations were necessary to preserve in their minds pure ideas of the nature of God, and of the worship due to him. They were necessary also to pave the

way for that illustrious dispensation which the Lord Jesus came from Heaven to diffuse over the world. Every celestial appearance recorded in Scripture was exhibited for some wise and important purpose, which must be apparent to every person who considers these appearances with attention. But when the Scriptures were written and published, and the Christian religion fully established, revelation ceased, and miracles and heavenly messages were no longer requisite. What credit then ought we to give to those marvellous stories related in ancient authors concerning prodigies in the heavens, and the apparition of angels both good and bad?

It is not pretended that any of those prodigies and appearances were exhibited for purposes equally great and important with those which are described in Scripture: And can we suppose that the all-wise Governor of the world would permit his angels to render themselves visible to the eye of man for no purpose at all, or for a purpose which might have been equally well accomplished without their interposition? Would this be consistent with perfect wisdom, or would it be consistent even with the excellence and superiority of understanding which we are taught to ascribe to these elevated beings? The whole will of God is revealed to us in the Scriptures; what further use for the visible interposition of angels? It may be objected, Are they not all ministering spirits, sent forth to minister for them who shall be heirs of salvation? * We answer, That angels may animate and support good men by an invisible interposition. But the Apollie is not speaking of celestial spirits. The word *angelos* signifies "a messenger;" and in Scripture often refers to men. In the passage which we are now reviewing it certainly is applied with much more propriety to men than to angels: for the Apollie is stating a comparison between the *Prophets*, by whom God, at sundry times and in divers manners, spake in time past to the fathers, and *the Son*, by whom he hath spoken in these last days.

And if God has given no commission to his angels to deliver to men since the publication of the Christian religion, is there any probability that he would give any commission or any licence to evil spirits? It will be said, that this doctrine is clearly taught in the New Testament, in these words, "The devil goeth about as a roaring lion seeking whom he may devour." We will not avail ourselves of the interpretation of some, who say that the word *devil*, which in the Greek language signifies an *adversary*, or *slenderer*, refers here to some human being, who was a violent enemy of the Christians. All that can be deduced from these words, upon the supposition that they refer to a malignant spirit, is merely that he goeth about seducing men to vice. But it is not by assuming a hideous form, and presenting himself to the midnight traveller, that such a purpose is to be accomplished. A spirit may probably have direct access to our minds without the intervention of any thing corporeal; and by exciting our passions may plunge us into vice, which is the only object such a being is supposed to have in view. None of the marvellous stories which we have heard concerning the apparition of evil spirits lead us to conclude that they appear to wise men to commit crimes. We never heard of any evil spirits that required men to steal, to perpetrate robbery or murder. They only appeared to terrify some crazy superstitious individuals, who have whims and fancies

* Heb. i.

But 14.

enow of their own to agitate their minds, though no preternatural vision should ever appear to them. It is not consistent, therefore, with the character of God, and what he has revealed to us of his will, to believe that he would commission good angels, or permit evil angels, to appear to men since the propagation of the gospel, or indeed at any former period of the world, unless some great and mighty purpose was to be fulfilled. It is not consistent with what we know of the nature of good or bad angels to suppose, that though permission were granted them occasionally to show themselves to men, that they would appear in that way which story-tellers describe.

It is equally improbable that the spirits of the dead who have removed from this world should again be permitted to visit it. At death men undergo as great, perhaps a greater change, than when they came first into the light of the sun. Is it not therefore as improbable that a man should return in a visible corporeal form after death, as that, after having arrived at manhood, he should return to the state in which he was before his birth? Such changes as these are evidently made permanent by the invariable laws of nature. But suppose it were possible, for what purpose should they return? To describe to us what is passing in the other world, to animate us to virtue, by informing us of the rewards which there await the good; or to alarm us, by describing the punishment of the wicked. These seem important reasons. But Divine Providence has wisely thrown a veil over futurity. We know every thing of the other world from the scripture which it is proper for us at present to know. And as to incentives to virtue, we are already blessed with a number sufficiently great and powerful for moral beings, who are to act from rational motives, and not from compulsion. "He that will not hear Moses and the prophets, will not be persuaded though one rose from the dead."

There is one strong objection against the probability of spectres, which is sufficient to prove that they are not intelligent creatures; or at least that they possess so small a degree of intelligence, that they are unqualified to act with prudence, to propose any end to themselves, or use the proper means to accomplish that end. Ghosts often appear in order to discover some crime that has been committed; but they never appear to a magistrate, or person in authority, but to some illiterate clown, who happens to live near the place where the crime was perpetrated; to some person who has no connection with the affair at all, and who in general is the most improper in the world for making the discovery. For instance, in Glanville's *Saducismus triumphatus* (a book written in the last century by a chaplain of Charles II. in support of the common opinions respecting witchcraft and apparitions), we have the following story: James Haddock, a farmer, was married to Elenor Welsh, by whom he had a son. After the death of Haddock, his wife married one Davis; and both agreed to defraud the son by the former marriage of a lease bequeathed to him by his father. Upon this the ghost of Haddock appeared to one Francis Taverner the servant of Lord Chichester, and desired him to go to Elenor Welsh, and to inform her that it was the will of her former husband that their son should enjoy the lease. Taverner did not at first execute this commission; but

he was continually haunted by the apparition in the most hideous shapes, which even threatened to tear him in pieces, till at last he delivered the message. Now, had this spectre had the least common sense, it would have appeared first to Elenor Welsh and her husband Davis, and frightened them into compliance at once, and not have kept poor Taverner in such constant disquietude, who had no concern in the matter.

Another very odd circumstance respecting apparitions in general must not be omitted, which is, that they have no power to speak till they are addressed. In the 27th of Glanville's Relations we read of an old woman that appeared often to David Hunter, a near-herd, at the house of the bishop of Down and Connors. Whenever she appeared, he found himself obliged to follow her; and for three quarters of a year poor David spent the whole of almost every night in scampering up and down through the woods after this old woman. How long this extraordinary employment might have continued, it is impossible to guess, had not David's violent fatigue made him one night exclaim, "Lord bless me! would I were dead!—shall I never be delivered from this misery!" On which the phantom replied, "Lord bless me too! It was happy you spoke first, for till then I had no power to speak, though I have followed you so long." Then she gave him a message to her two sons, though David told her he remembered nothing about her. David, it seems, neglected to deliver the message; at which the old woman was so much provoked, that she returned and hit him a heavy blow on the shoulder, which made him cry out, and then speak to her. Now if she could not speak till David addressed her, why might she not have applied this oratorical medicine the first time she appeared to him? It would have saved both herself and him many a weary journey; and certainly David would much rather have had even half a dozen of blows from her chappy fists than have wanted so many nights sleep. To complete the story, we must add, that when David's wife found it impossible to keep him from following the troublesome visitor, she trudged after him, but never was gratified with a sight of the enchantress. David's little dog too was a dutiful attendant on his master during his pilgrimage.

It is remarked by Glanville, that ghosts are generally very eager to be gone. Indeed they are often so much so, that they do not stay to tell their errand. One would be induced from this, as well as the circumstances already mentioned, to think that they are the stupidest and dullest of the dead that assume the appearance of ghosts; unless we adopt the ingenious solution of Glanville, "that it is a very hard and painful thing for them to force their thin and tenuous bodies into a visible consistence; that their bodies must needs be exceedingly compressed; and that therefore they must be in haste to be delivered from the unnatural pressure."

With respect to the evidence in favour of spectres, if examined ever so slightly, it will be found very defective. They only appear to one person at a time; they are seen only in the night; they are visible only to ignorant, illiterate, and credulous persons, and never present themselves before men of education and learning.

That spectres only appear to one person at a time, even though there are more in company, is an objection against the credibility of their appearance quite insurmountable.

mountable. How is it possible that two men of eyesight equally good, directing their eyes to the same spot, should not see so large an object as that of a man or woman at a small distance equally well? Some will tell us that a mist is cast over the eyes of the one, while the view of the other is free from obstruction. But how is this to be proved? and besides, what purpose would it serve? Ghosts have seldom any secrets to disclose; they might be proclaimed to a multitude with as much propriety as confined to one person. Shall we be told, that the spectre has the power of becoming visible to some, and of remaining invisible to others? This cannot be allowed without adopting opinions destructive to revealed religion; for it would be a miracle: and we cannot be persuaded, without evidence, that God would empower any inferior being to controul at pleasure the wise Laws which he has ordained for governing the world. To him who is of a different opinion, we would recommend Farmer on Miracles; a book in which this question is fully examined.

Spectres appear only in the night. But why should they shun the light of the sun? Those mischievous ghosts that Glanville mentions might indeed have some reason to choose midnight for the execution of their pranks, as they would be more easily detected in open day. Such was the roguish drummer that haunted Mr Mompesson's house, who beat his drum all night, threw the old gentlewoman's clothes about the room, hid her Bible in the ashes, plucked the clothes off the bed, and amused himself with tossing about Mr Mompesson's shoes. But why should a grave serious ghost appear at midnight? Might it not deliver its message with as much ease and more success in the day-time? In the day-time it would not excite much fear; it would be listened to therefore with more attention; and did it choose to exhibit itself before a number of witnesses, its grievances would be more speedily redressed, because more persons would interest themselves in seeing justice done to the injured ghost.

Spectres not only choose the most improper time, but the most improper persons. To render the testimony of any person credible, he must not only be a man of veracity, but he must have sufficient ability to judge of the subject to which he is to bear witness. It is not on the evidence of an ignorant illiterate person, who has more

fancy and fear than judgement, that we are to rest our belief of what is supernatural. It is also worthy of remark, that we have never heard of a ghost appearing to any person who did not previously believe their existence. A man must be prejudiced in favour of this opinion, or he will never see a ghost. But sensible men know, that he who has been accustomed to hear frightful stories of ghosts and apparitions gliding through a churchyard, or haunting some particular place, can scarcely pass through a churchyard, or haunted spot without conjuring up in his imagination the hideous phantoms which he has been accustomed to associate with such places. Is it strange, then, that an ignorant man, with a mind uncultivated and uninformed, with all the prejudices of the nursery about him, should imagine he sees ghosts in those places where he believes they hover, especially in the dead hour of midnight, when, with the slightest aid of the imagination, a cow may be turned into a monstrous phantom, and the reflection of the beams of the moon from a little water be converted into a ghost with a winding-sheet? But why should apparitions shun men of understanding and learning? Why should learning be formidable to them (A)? It was not so with the celestial messengers mentioned in the Scriptures: they appeared to the patriarchs and prophets; and the miracles there recorded were performed in the most public places, before the eyes of Rabbies, of Scribes, and Pharisees. Indeed this circumstance is sufficient to destroy the evidence of spectres. They have never been seen by any but men of weak or disordered minds, or by men who have previously believed in them.

Having now considered the evidence on which the belief of spectres rests, we will endeavour to give some account of the foundation of it. To trace an opinion that has prevailed so generally in the world to its source, is a labour not unworthy of the philosopher, even though the opinion be false. It is always gratifying to detect the causes of error: it is no less useful; for in order to refute error, it is often sufficient to point out the sources from which it has sprung. To reach the origin of the belief of spectres is not more difficult than to account for idolatry or polytheism. In the infant state of the intellectual powers every thing is considered as possessing life and intelligence. The child beats the

foot

(A) The celebrated historian De Thou had a very singular adventure at Saumur, in the year 1598. One night, having retired to rest very much fatigued, while he was enjoying a sound sleep, he felt a very extraordinary weight upon his feet, which, having made him turn suddenly, fell down and awakened him. At first he imagined that it had been only a dream, but hearing soon after some noise in his chamber, he drew aside the curtains and saw, by help of the moon, which at that time shone very bright, a large white figure walking up and down, and at the same time observed upon a chair some rags, which he thought belonged to thieves who had come to rob him. The figure then approaching his bed, he had the courage to ask it what it was. "I am (said it) the Queen of Heaven." Had such a figure appeared to any credulous ignorant man in the dead of night, and made such a speech, would he not have trembled with fear, and have frightened the whole neighbourhood with a marvellous description of it? But De Thou had too much understanding to be so imposed upon. Upon hearing the words which dropped from the figure, he immediately concluded that it was some mad woman, got up, called his servants, and ordered them to turn her out of doors; after which he returned to bed and fell asleep. Next morning he found that he had not been deceived in his conjecture, and that having forgot to shut his door, this female figure had escaped from her keepers, and entered his apartment. The brave Schomberg, to whom De Thou related his adventure some days after, confessed that in such a case he would not have shown so much courage. The king also, who was informed of it by Schemberg, made the same acknowledgment.

stool over which he has fallen with the same passion that he would treat his companion : The young girl talks to her doll as if it understood her : The savages ascribe every change which they observe on the face of nature to the action of some animated being. As knowledge advances, they single out those beings which seem to produce the most striking effects, arrange them into some kind of order, and divide the government of the world among them. Unable, at the same time, to conceive any notion of a pure spirit, they imagine those divinities are corporeal beings. This is the foundation of idolatry. The belief of spectres is but another step. That these animated corporeal beings, to whom they address their prayers, and who preside over the world, should on particular occasions display themselves to the human eye, is what they must be previously disposed to expect. Hence the numberless appearances of the heathen gods, of the Persian and Mahometan genii. The belief of ghosts may be easily deduced from the opinions entertained respecting a future state. These opinions are founded on that essential doctrine of natural religion, that there is another world in which men shall exist when death has removed them hence. This doctrine has been universally received both by savage and civilized nations ; but, as might be expected, men have formed very different sentiments concerning the nature of a future state, of the situation and employments of departed spirits, according to the degree of knowledge which they possessed. But the general opinion in ancient and rude nations was, that departed spirits retained the same external appearance, the same passions and principles as before. Nothing therefore was more natural than the opinion, that they might occasionally revisit this world, from an anxious desire to alleviate the sufferings of those beloved friends and relations whom they had left behind them, or to communicate from the unseen world what might be important to their welfare. Upon such an errand did Cæcilia appear to Æneas. The apparition of the ghosts of murderers is easily explained upon the same general principles. The remorse and horror of mind which the murderer feels are supposed to haunt him in the other world, and to render his situation there intolerable (especially if the murder was never detected and punished), till he return and give information against himself. In this way, then, we think it highly probable the belief of spectres has originated. But many other causes concur to confirm and propagate this belief. These are, imperfect vision united with fear, dreams, opium, diseases, drunkenness, and opium.

1. Indistinct vision is one source of apparitions, especially when the mind is under the influence of fear. It is well known, that the sense of seeing conveys no idea of distance till improved by experience and observation ; and how we come at length to distinguish objects at a distance from those that are near, has been explained in another place (see METAPHYSICS, N^o 50.).

In the daytime we seldom commit mistakes, because we know the object at which we look ; but at night,

when we see objects obscurely, and know not what they are, we have no distinct idea either of their distances or of their magnitude. We may mistake a bush that is near us for a tree at a distance ; or if the imagination be under the influence of fear, it will easily convert it into a gigantic figure. " It is generally asserted (says Buffon) that these figures exist only in the imagination ; yet they may have a real existence in the eye ; for whenever we have no other mode of judging of an unknown object but by the angle it forms in the eye, its magnitude will uniformly increase in proportion to its proximity. If it appears, when at the distance of 20 or 30 paces, to be only a few feet high, its height, when within two or three feet of the eye, will be many fathoms. An object of this kind must naturally excite terror and astonishment in the spectator, till he approaches and recognises it by actual feeling ; for the moment a man knows an object, the gigantic appearance it assumed in the eye instantly diminishes, and its apparent magnitude is reduced to its real dimensions. But if, instead of approaching such an object, the spectator flies from it, he can have no other idea of it but from the image which it formed in his eye ; and, in this case, he may affirm with truth that he saw an object terrible in its aspect, and enormous in its size. Thus the notions concerning spectres is founded in nature, and depend not, as some philosophers affirm, upon the imagination alone."

In addition to these observations of Buffon, we may take notice, that objects are always magnified in a fog ; so that when a fog happens in the night-time, objects may be magnified to an enormous size. But, at any rate, whether there be fog in the night or not, there is such a great analogy between darkness and a fog, that if the latter deceive us with respect to the size of objects, the former will also deceive us. The writer of this article was passing the ditch of Forth at Queensferry, near Edinburgh, one morning which was extremely foggy. Though the water be only two miles broad, the boat did not get within sight of the southern shore till it approached very near it. He then saw to his great surprise a large perpendicular rock, where he knew the shore was low and almost flat. As the boat advanced a little nearer, the rock seemed to split perpendicularly into portions, which separated at a little distance from one another. He next saw these perpendicular divisions move ; and upon approaching a little nearer, found it was a number of people standing on the beach, waiting the arrival of the ferry-boat.

2. Dreams are another fertile source of apparitions. It is well known to every person, that while the mind is under the influence of a dream it considers it as much a reality as it does any particular action while awake. Now if a person of a weak superstitious mind should have a very lively dream, which interests his passions, particularly the passion of fear, it may make so deep an impression, that he may be firmly convinced that he has actually seen with his eyes what has only passed before his imagination (see APPARITION) (B). We shall here tell a story, by way of illustration, which we

(B) When the thoughts are much troubled, and when a person sleeps without the circumstances of going to bed, or putting off his clothes, as when he naps in his chair, it is very difficult, as Hobbes remarks, to distinguish a dream from a reality. On the contrary, he that composes himself to sleep, in case of any uncouth or absurd fancy, easily suspects it to have been a dream.—*Leviathan*, par. i. c. 1.

have received on unquestionable authority. An East India captain had an honest faithful servant named *John*, for whom he had a great regard. *John* died, if we recollect right, on a voyage from England to the East Indies during a French war. As the ship approached the place of its destination the captain had a dream, in which *John* appeared to him, and earnestly besought him not to fail to the port for which he was bound, as it was in the hands of the French. The captain, though not addicted to superstition, thought it prudent to follow this admonition; and after landing at a different port, he was informed that the place to which he had intended to steer was, according to the information of the dream, captured by the French. On the voyage home, the captain had a second dream, in which *John* again appeared to him, and gave him notice that he should soon die, and that the ship should be taken in the mouth of the Channel by the French. Next morning the captain called his first mate, told him his dream, which he believed was prophetic, and delivered his papers, that he might take proper care of them after his decease. Every thing happened exactly as the dream had foretold; the captain died, and the vessel was taken by a French man of war in the mouth of the Channel. This dream, wonderful as it appears, is easily explained. In the voyage out to India, nothing was more natural than that the captain should sometimes be thinking, that amidst the various chances of war, the port to which he was bound might be taken; perhaps it was a place of consequence, which the French might be eager to possess. The captain being accustomed to revolve these thoughts in the day-time, they would naturally return at night; the regret which he felt for the loss of a faithful servant might mingle with his apprehensions, and thus produce the dream. Perhaps the advice was such as *John* would have given had he been alive. It is equally easy to explain the cause of the dream in the passage home. The captain, we are told, was very ill, and thought himself dying, at the very time he had the second dream, and therefore did not expect to reach England. This part of the dream, then, was only his own thoughts, delivered by his servant. As to the other part, that his ship should be taken in the mouth of the Channel, it may be thought unaccountable how the very place should be foreseen. But we must recollect, that the mouth of the Channel, being ever against the coast of France, was by far the most dangerous place in the whole passage; and that, therefore, the captain had more reason to be afraid of losing his ship there than in any other place. The use which we mean to make of this story is this: Had the captain been a man of a weak mind, he would certainly have considered the dream as a reality, and believed that, instead of having dreamed of the things on which his imagination had dwelt, he had actually seen his servant return from the dead, and heard him deliver the message. But, on the other hand, the captain, though he believed the dream was prophetic, mentioned it without any signs of fear; and no man of courage and reflection ever sees an apparition. This fight is reserved for the weak, the timid, and the superstitious. Of this many instances might be mentioned.

3. Spectres are also sometimes occasioned by opium. Gassendi the philosopher found a number of people going to put a man to death for having intercourse with the devil; a crime which the poor wretch readily ac-

knowledged. Gassendi begged of the people that they would permit him first to examine the wretch before putting him to death. They did so; and Gassendi, upon examination, found that the man firmly believed himself guilty of this impossible crime. He even offered to Gassendi to introduce him to the devil. The philosopher agreed; and when midnight came, the man gave him a pill, which he said it was necessary to swallow before setting off. Gassendi took the pill, but gave it to his dog. The man having swallowed his, fell into a profound sleep; during which he seemed much agitated by dreams. The dog was affected in a similar manner. When the man awoke, he congratulated Gassendi on the favourable reception he had met with from his fable highness. It was with difficulty Gassendi convinced him that the whole was a dream, the effect of soporific medicines, and that he had never stirred from one spot during the whole night.

4. That diseases, especially the night-mare, the hypochondria, hysterical passion, and madnets, are another source of spectres, we have the strongest reason to affirm. Persons subject to the night-mare often imagine that they see spectres. This is still more the case with hypochondriac and hysterical persons, and those who are in any degree deranged in their intellects. A fact which fell within the observation of the writer of this article will both prove and illustrate this assertion. In a village in one of the midland counties of Scotland, lived a widow distinguished among her neighbours for decency of manners, integrity, and respect for religion. She affirmed, that for several nights together she had heard a supernatural voice exclaiming aloud, *Murder! murder!* This was immediately reported through the neighbourhood; all were alarmed, and looked around them with solicitude for the detection of the murder which they supposed to have been committed; and it was not long till a discovery seemed actually to be made. It was reported, that a gentleman, who had relations at no great distance, and had been residing in the West Indies, had lately arrived with a considerable fortune; that he had lodged in an inn about three miles off; and that he had afterwards been seen entering a house in the village where the widow lived, from which he had never returned. It was next affirmed, that a tradesman passing the churchyard about twelve at midnight had seen four men carry a dead corpse into that cemetery. These three facts being joined together seemed perfectly to agree and to confirm one another, and all believed some horrible murder had been committed. The relations of the gentleman thought they were called upon to make inquiry into the truth of these allegations: they accordingly came first to the churchyard, where, in company with the sexton, they examined all the graves with great care, in order to discover whether any of them had been lately dug, or had the appearance of containing more than one coffin. But this search was to no purpose, for no alteration had been made upon the graves. It was next reported that the murdered man had been buried in a plantation about a mile distant from the village. As the alarm was now very general, a number of the inhabitants proposed of their own accord to explore it. They accordingly spread themselves over the wood, and searched it with care, but no grave nor new dug earth was found. The writer of this article, who was then a boy at school, was along with them. The mat-

ter did not rest here: The person who was said to have seen four men carry a dead corpse into the churchyard at midnight was summoned to appear before a meeting of the justices of the peace. Upon examination he denied any knowledge of the affair, but referred the court to another person from whom he had received his information. This person was examined, and the result was the same as the former. In short, one person had heard it from another, who had received it from a third, who had heard it from a fourth; but it had received a little embellishment from every person who repeated it. It turned out to be the same with Smollet's story of the three black crows, which some body was said to have vomited.

Upon inquiry at the inn where the West Indian gentleman had lodged, no such gentleman had been seen there. It was found afterwards he had never left the West Indies. Still, however, the veracity of the widow was not disputed; and some dark and secret transaction was suspected. But the whole affair was at length explained by discovering that she was somewhat deranged by melancholy. And the cries which she had at first imagined she had heard were afterwards imitated by some rough person, who was highly amused with spreading terror among the credulous.

5. Drunkenness also has the power of creating spectres. Its natural effect in most cases is to derange the understanding, to throw it off its guard, and to give full scope to that passion which has a natural disposition to gain an ascendancy; and sometimes it excites passions which scarcely seem to exist at any other time. It makes some men licentious, some furious, some all benevolence and kindness, some from being cowardly it renders undaunted heroes. It seldom, if ever, excites fear; and therefore it may be thought it gave that men should imagine they see ghosts when intoxicated. But it would be remarked, that the ghosts which the drunkard sees, he sees not with the same alarm and terror as men who are sober. He is not afraid of them. He has the courage to converse with them, and even to fight with them, if they give him provocation. A man returning home intoxicated, affirmed that he had met with the devil; and that after a severe encounter he had vanquished him and brought him to the ground, to which he had nailed him fast by driving his staff through his body. Next morning the staff was found stuck with great violence into a heap of turfs!

6. Many apparitions of spectres have no other origin than the artifices of the waggish or self-interested. Dr Plot, in his Natural History of Oxfordshire, relates a marvellous story, which will illustrate this assertion. Soon after the murder of King Charles I. a commission was appointed to survey the king's house at Woodstock, with the manor, park, woods, and other demesnes to that manor belonging; and one Collins, under a feigned name, hired himself as secretary to the commissioners, who, upon the 13th of October 1649. met, and to look up their residence in the King's own rooms. His majesty's bed-chamber they made their kitchen, the council hall their pantry, and the presence-chamber was the place where they sat for the dispatch of business. His majesty's dining-room they made their wood yard, and stored it with the wood of the famous royal-oak from the High Park, which, that nothing might be left with the name of king about it, they had dug up

by the roots, and split and bundled up into faggots for their firing. Things being thus prepared, they sat on the 16th of the same month for the dispatch of business; and in the midst of their first debate there entered a large black dog (as they thought, which made a dreadful howling, overturned two or three of their chairs, and then crept under a bed and vanished. This gave them the greater surmise, as the doors were kept constantly locked, so that no real dog could get in or out. The next day their surmise was increased, when sitting at dinner in a lower room, they heard plainly the noise of persons walking over their heads, though they well knew the doors were all locked, and there could be no body there. Presently after they heard also all the wood of the king's oak brought by parcels from the dining-room, and thrown with great violence into the presence chamber; as also all the chairs, stools, tables, and other furniture, forcibly hurried about the room; their papers, containing the minutes of their transactions were torn, and the ink-glasses broken. When all this noise had ceased, Giles Sharp, their secretary, proposed to enter first into these rooms; and in presence of the commissioners, from whom he received the key, he opened the doors, and found the wood spread about the room, the chairs tumbled about and broken, the papers torn, the ink-glasses broken (as has been said), but not the least track of any human creature, nor the least reason to suspect one, as the doors were all fast, and the keys in the custody of the commissioners. It was therefore unanimously agreed, that the power who did this mischief must have entered the room at the key-hole. The next night following, Sharp the secretary, with two of the commissioners servants, as they were in bed in the same room, which room was contiguous to that where the commissioners lay, had their bed's feet lifted up so much higher than their heads, that they expected to have their necks broken, and then they were let fall at once with so much violence as shook the whole house, and more than ever terrified the commissioners. On the night of the 19th, as all were in bed in the same room for greater safety, and lights burning by them, the candles in an instant went out with a sulphurous smell, and that moment many trenchers of wood were hurled about the room, which next morning were found to be the same their honours had eaten on the day before, which were all removed from the pantry, though not a lock was found open in the whole house. The next night they fared still worse; the candles went out as before, the curtains of their honours beds were rattled to and fro with great violence; their honours received many cruel blows and bruises, by eight great pester-dishes and a number of wooden trenchers being thrown on their beds, which being heated off, were heard rolling about the room, though in the morning none of these were to be seen. This night likewise they were alarmed with the tumbling down of oaken listels about their beds, and other frightful noises; but all was clear in the morning, as if no such thing happened. The next night the keeper of the king's house and his dog lay in the commissioners room, and then they had no disturbance. But on the night of the 22d, though the day lay in the room as before, yet the candles went out, a number of brick bats fell from the chimney into the room, the dog howled piteously, their bed clothes were all stripped off, and their terror increased. On the

24th they thought all the wood of the king's oak was violently thrown down by their bed sides; they counted 64 billets that fell, and some hit and shook the beds in which they lay; but in the morning none were found there, nor had the door been opened where the billet wood was kept. The next night the candles were put out, the curtains rattled, and a dreadful crack like thunder was heard; and one of the servants running in haste, thinking his master was killed, found three dozen of trenchers laid smoothly under the quilt by him. But all this was nothing to what succeeded afterwards: The 29th, about midnight, the candles went out, something walked majestically through the room, and opened and shut the windows; great stones were thrown violently into the room, some of which fell on the beds, others on the floor; and at about a quarter after one a noise was heard as of forty cannon discharged together, and again repeated at about eight minutes distance. This alarmed and raised all the neighbourhood, who coming into their honours room, gathered up the great stones, fourscore in number, and laid them by in the corner of a field, where, in Dr Plot's time, who reports this story, they were to be seen. This noise, like the discharge of cannon, was heard through all the country for 16 miles round. During these noises, which were heard in both rooms together, the commissioners and their servants gave one another over for lost, and cried out for help; and Giles Sharp, snatching up a sword, had well nigh killed one of their honours, mistaking him for the spirit, as he came in his shirt from his own room to theirs. While they were together, the noise was continued, and part of the tiling of the house was stript off, and all the windows of an upper room were taken away with it. On the 30th at midnight something walked into the chamber treading like a bear; it walked many times about, then threw the warming-pan violently on the floor; at the same time a large quantity of broken glass, accompanied with great stones and horses bones, came pouring into the room with uncommon force. These were all found in the morning to the astonishment and terror of the commissioners, who were yet determined to go on with their business. But on the first of November the most dreadful scene of all ensued: Candles in every part of the room were lighted up, and a great fire made; at midnight, the candles all yet burning, a noise like the bursting of a cannon was heard in the room, and the burning billets were tossed about by it even into their honours beds; who called Giles and his companions to their relief, otherwise the house had been burnt to the ground; about an hour after the candles went out as usual, the crack as if many cannon was heard, and many pailsful of green stinking water were thrown upon their honours beds; great stones were also thrown in as before, the bed curtains and bedsteads torn and broken, the windows shattered, and the whole neighbourhood alarmed with the most dreadful noises; nay, the very rabbit-dealers that were abroad that night in the warren were so terrified, that they fled for fear and left their ferrets behind them. One of their honours this night spoke, and, in the name of God, asked what it was, and why it disturbed them so? No answer was given to this; but the noise ceased for a while, when the spirit came again; and, as they all agreed, brought with it seven devils worse than itself. One of the servants now lighted a large

candle, and set it in the door-way between the two chambers, to see what passed; and as he watched it, he plainly saw a hoof striking the candle and candlestick into the middle of the room, and afterwards making three serapes over the snuff, scraped it out. Upon this the same person was so bold as to draw a sword; but he had scarce got it out when he felt another invisible hand holding it too, and pulling it from him; and at length prevailing, struck him so violently on the head with the pommel, that he fell down for dead with the blow. At this instant was heard another burst like the discharge of the broadside of a ship of war, and at about a minute or two's distance each no less than 19 more such: these shook the house so violently, that they expected every moment it would fall upon their heads. The neighbours, on this, as has been said, being all alarmed, flocked to the house in great numbers, and all joined in prayer and psalm singing; during which the noise still continued in the other rooms, and the discharge of cannons was heard as from without, though no visible agent was seen to discharge them. But what was the most alarming of all, and put an end to their proceedings effectually, happened the next day as they were all at dinner, when a paper, in which they had signed a mutual agreement to reserve a part of the premises out of the general survey, and afterwards to share it equally amongst themselves, (which paper they had hid for the present under the earth in a pot in one corner of the room, and in which an orange-tree grew), was consumed in a wonderful manner, by the earth's taking fire with which the pot was filled, and burning violently with a blue flame, and an intolerable stench; so that they were all driven out of the house, to which they could never again be prevailed upon to return.

This wonderful contrivance was all the invention of the memorable Joseph Collins of Oxford, otherwise called *Funny Joe*, who having hired himself as secretary, under the name of *Giles Sharp*, by knowing the private traps belonging to the house, and the help of *pulvis fulminans* and other chemical preparations, and letting his fellow-servants into the scheme, carried on the deceit without discovery to the very last; inasmuch that the Dr Plot, in his *Natural History*, relates the whole for fact, and concludes in this grave manner, "That though tricks have been often played in affairs of this kind, many of the things above related are not reconcilable with juggling; such as the loud noises, beyond the power of man to make without such instruments as were not there; the tearing and breaking the beds; the throwing about the fire; the hoof treading out the candle; and the striking for the sword, and the blow the man received from the pommel of it."

SPECTRE of the Broken, a singular phenomenon observed on the top of the *Broken*, one of the Hartz mountains in Hanover, of which M. Hane has given the following account. "After having been here (says he) for the thirtieth time, and having procured information respecting the above-mentioned atmospheric phenomenon, I was at length, on the 23d of May 1797, so fortunate as to have the pleasure of seeing it; and perhaps my description may afford satisfaction to others who visit the Broken through curiosity. The sun rose about four o'clock, and, the atmosphere being quite serene towards the east, his rays could pass without any obstruction over the *Heinrichshöhe*. In the south-west, how-

Spectre
in
speculum

ever, towards Achtermannshöhe, a brisk west wind carried before it thin transparent vapours, which were not yet condensed into thick heavy clouds.

"About a quarter past four I went towards the inn, and looked round to see whether the atmosphere would permit me to have a free prospect to the south-west; when I observed, at a very great distance towards Achtermannshöhe, a human figure of a monstrous size. A violent gust of wind having almost carried away my hat, I clapped my hand to it by moving my arm towards my head, and the colossal figure did the same.

"The pleasure which I felt on this discovery can hardly be described; for I had already walked many a weary step in the hopes of seeing this shadowy image, without being able to gratify my curiosity. I immediately made another movement by bending my body, and the colossal figure before me repeated it. I was desirous of doing the same thing once more—but my colossus had vanished. I remained in the same position, waiting to see whether it would return; and in a few minutes it again made its appearance on the Achtermannshöhe. I paid my respects to it a second time, and it did the same to me. I then called the landlord of the Broken; and having both taken the same position which I had taken alone, we looked towards the Achtermannshöhe, but saw nothing. We had not, however, stood long, when two such colossal figures were formed over the above eminence, which repeated our compliments by bending their bodies as we did; after which they vanished. We retained our position; kept our eyes fixed on the same spot, and in a little the two figures again stood before us, and were joined by a third. Every movement that we made by bending our bodies these figures imitated—but with this difference, that the phenomenon was sometimes weak and faint, sometimes strong and well defined. Having thus had an opportunity of discovering the whole secret of this phenomenon, I can give the following information to such of my readers as may be desirous of seeing it themselves. When the rising sun, and according to analogy the case will be the same at the setting sun, throws his rays over the Broken upon the body of a man standing opposite to fine light clouds floating around or hovering past him, he needs only fix his eyes steadfastly upon them, and, in all probability, he will see the singular spectacle of his own shadow extending to the length of five or six hundred feet, at the distance of about two miles before him."

SPECULARIS LAPIS, composed of large plates of extreme thinness. (See *TALC*, *MINERALOGY Index*.) The white variety with large and broad leaves, commonly called *specularis* and *Mulcovy glass*, is imported in great quantities; the miniature-painters cover their pictures with it; the lantern-makers sometimes use it instead of horn; and minute objects are usually preferred between two plates of it, for examination by the microscope.

SPECULATIVE, something relating to the theory of some art or science, in contradistinction to practical.

SPECULUM for reflecting telescopes, is made of a kind of white copper consisting of 32 parts fine red copper, one of brass, 15 of grain tin, and three of white arsenic. The process given by the late J. Edwards, who was rewarded by the Board of Longitude

for disclosing it to the public, was published in the *Nautical Almanack* for 1785, and is as follows: Melt the copper in a large crucible, employing some black flux, composed of two parts of tartar and one of nitre; when melted, add to it the brass and the silver. Let the pure tin be melted in another crucible, also with some black flux. Take them both from the fire, and pour the melted tin into the fused mass in the large crucible. Stir the whole well with a dry spatula of birch, and pour off the fused metal immediately into a large quantity of cold water. The sudden chill of the water will cause the fluid metal to divide into an infinite number of small particles, which will cool instantly.

If the copper be completely furnished, the fracture of one piece of this mixed metal will appear bright, and of a glossy look, resembling the face of pure quicksilver. But if it is of a brown reddish colour, it wants a little more tin. To ascertain the required proportion, melt a small quantity, known by weight, of the mixed metal, with a known very small part of tin; and, if necessary, repeat the trial with different dose, till the fracture of the new mixture looks as already described. Having now ascertained the necessary addition of tin that is required, proceed to the last melting of the whole metal, together with the additional proportional dose of tin; fuse the whole, observing the same cautions as before; and you will find that the mixture will melt with a much less heat than that for the first fusion. Have ready as many ounces of white arsenic in coarse powder as there are pounds in the weight of the metal; wrap up the arsenic in a small paper, and put it, with a pair of tongs, into the crucible; stir it well with the spatula, retaining the breath to avoid the arsenical fumes or vapours (which however are not found to be hurtful to the lungs) till they disappear; take the crucible off the fire, clear away the dross from the top of the metal, pour in about one ounce of powdered rosin, with as much nitre, in order to give the metal a clean surface, and pour out the metal into the moulded flasks.

The speculum should be moulded with the concave surface downwards, and many small holes should be made through the sand upwards, to discharge the air. The moulding sand from Highgate near London, used by the founders, is as good as any for casting these metallic mirrors. The cast metal should be taken out from the sand of the flasks whilst it is hot, or else it may happen to crack if left to cool within. See *TELESCOPE*.

But in addition to what has now been said, we must notice some other information relative to the grinding, polishing, and other important circumstances connected with the method of preparing the most perfect speculum for telescopes. The metal being taken out of the flask, as already noticed, and this should be done as soon as it has become fluid, and while it is yet red hot, care must be taken to keep the face downwards to prevent it from sinking. Holding it in that position by the gilt, force out the sand from the hole in the middle of the mirror with a piece of wood or iron, and place the speculum in an iron pot, with a large quantity of hot ashes or small coals, so as to bury the speculum in them a sufficient depth. If the sand is not forced out of the hole in the manner above directed, the metal, by sinking as it cool-

Spectre
in
speculumC. Webb's
Illustrations
p. 51
p. 71

Speculum

will embrace the sand in the middle of the speculum so tight, as to cause it to crack before it becomes entirely cold. And if the metal be not taken out of the fand, and put in a pot with hot ashes or coals to anneal it, the moisture from the fand will always break the metal. Let the speculum remain in the ashes till the whole is become quite cold. The gilt may be easily taken off by marking it round with a common fine half round file, and giving it then a gentle blow. The metal is then to be rough ground and figured.

But before we proceed to describe that process, it may be proper to give an account of another composition for the speculum of a reflecting telescope, which has been employed with great success, by Rochon director of the marine observatory at Breil. Of this composition the principal ingredient is platina; which, in grains, must be purified in a strong fire by means of nitre and the salt of glass, or that flux which in the English glass-houses is called by the workmen *sandifer*. To the platina, when purified, add the eighth part of the metal employed in the composition of common specula; for tin without red copper would not produce a good effect. This mixture is then to be exposed to the most violent heat, which must be still excited by the oxygen gas that disengages itself from nitre when thrown into the fire. One melting would be insufficient: five or six are requisite to bring the mixture to perfection. It is necessary that the metal should be in a state of complete fusion at the moment when it is poured into the mould. By this process I have been enabled (says the author) to construct a telescope with platina, which magnifies the diameters of objects five hundred times, with a degree of clearness and distinctness requisite for the nicest observations. The large speculum of platina weighs fourteen pounds: it is eight inches in diameter, and its focus is six feet. Though the high price of platina will, in all probability, for ever prevent it from coming into general use for the speculums of telescopes, we thought it proper to notice this discovery, and shall now proceed to the grinding of the speculum.

For accomplishing this object, a very complicated process is recommended in Smith's Optics, and one not much more simple, by Mr Mudge in the 67th volume of the *Philosophical Transactions*; but according to Mr Edwards, whose speculums are confessedly the best, neither of these is necessary. Besides a common grindstone, all the tools that he made use of are a rough grinder, which serves also as a polisher, and a bed of hones. When the speculum was cold, he ground its surface bright on a common grindstone, previously brought to the form of the gage; and then took it to the rough grinder.

The tool is composed of a mixture of lead and tin, or of pewter, and is made of an elliptical form, of such dimensions, that the shortest diameter of the ellipse is equal to the diameter of the mirror or speculum, and the longest diameter is to the shortest in the proportion of ten to nine. This rough grinder may be fixed upon a block of wood, in order to raise it higher from the bench; and as the metal is ground upon it with fine emery, Mr Mudge, with whom, in this particular, Mr Edwards agrees, directs a hole or pit to be made in the middle of it as a lodgement for the emery, and deep grooves to be cut out across its surface with a graver

for the same purpose. By means of a handle, fixed on the back of the metal with soft cement, the speculum can be whirled round upon this grinder so rapidly, that a common labourer has been known to give a piece of metal, four inches in diameter, so good a face and figure as to fit it for the lunes in the space of two hours. The emery, however fine, will break up the metal very much; but that is remedied by the subsequent processes of honing and polishing.

When the metal is brought to a true figure, it must be taken to a convex tool, formed of some stones from a place called Edgedon in Shropshire, situated between Ludlow and Bishop's Castle. The common blue hones, used by many opticians for this purpose, will scarcely touch the metal of Mr Edwards's speculums; but where they must be employed for want of the others, as little water should be used as possible when the metal is put upon them; because it is found by experience that they cut better when but barely wet, than when drenched with water. The stones, however, from Edgedon are greatly preferable; for they cut the metal more easily, and having a very fine grain, they bring it to a smooth face. These stones are directed by Mr Mudge to be cemented in small pieces upon a thick round piece of marble, or of metal made of tin and lead like the former composition, in such a manner, that the lines between the stones may run straight from one side to the other; so that placing the teeth of a very fine saw in each of these divisions, they may be cleared from one end to the other of the cement which rises between the stones. As soon as the hones are cemented down, this tool must be fixed in the lathe, and turned as exactly true to the gage as possible. It should be of a circular figure, and but very little larger than the metal intended to be figured upon it. If it be made considerably larger, it will grind the metal into a larger sphere and a bad figure; and if it be made exactly of the same size, it will work the metal indeed into a figure truly spherical, but will be apt to shorten its focus, unless the metal and tool be worked alternately upwards. On these accounts, Mr Edwards recommends it to be made about one twentieth part longer in diameter than the speculum, because he has found that it does not then alter its focus; and he earnestly dissuades the use of much water on the hone pavement at the time of using it, otherwise, he says, that the metal in different parts of it will be of different degrees of brightness.

The metal being brought to a very fine face and figure by the bed of stones, is ready to receive a polish, which is given to it by the elliptical rough grinder covered with pitch. With respect to the consistency of this pitch, Mr Mudge and Mr Edwards give very different directions. Whilst the former says that it should be neither too hard nor too soft, the latter affirms that the harder the pitch is, the better figure it will give to the metal. Pitch may be easily made of a sufficient hardness by adding a proper quantity of rosin; and when it is hardened in this way, it is not so brittle as pitch alone, which is hardened by boiling. Mr Edwards advises to make the mixture just so hard as to receive, when cold, an impression from a moderate pressure of the nail of one's finger. When the elliptical tool is to be covered with this mixture, it must be made pretty warm, and in that state have the mixture poured upon it when beginning to cool in the crucible. Our

author

author recommends this coating to be made everywhere of about the thickness of half a crown; and to give it the proper form, it must, when somewhat cool, be pressed upon the face of the mirror, which has first been dipped in cold water, or covered over with very fine writing paper. If it be not found to have taken the exact figure from the first preface, the surface of the pitch must be gently warmed, and the operation repeated as before. All the superfluous pitch is now to be taken away from the edge of the polisher with a pen knife, and a hole to be made in the middle, accurately round, with a conical piece of wood. This hole should go quite through the tool, and should be made of the same size, or somewhat less than the hole in the middle of the speculum. Mr Edwards says, that he has always found that small mirrors, though without any hole in the middle, finish much better, and take a more correct figure, for the polisher's having a hole in the middle of it.

The polisher being thus formed, it must be very gently warmed at the fire, and divided into several squares by the edge of a knife. These, by receiving the small portion of metal that works off in polishing, will cause the figure of the speculum to be more correct than if no such squares had been made. Mr Mudge directs the polisher to be strewed over with very fine putty; but Mr Edwards prefers COLCOATH of vitriol. Putty (says he) gives to metals a white lustrous, or, as workmen call it, a silver hue; but good colcoath of vitriol will polish with a very fine and high black lustrous, so as to give the metal finished with it the complexion of polished steel. To know if the colcoath of vitriol is good, put some of it into your mouth, and if you find it dissolves away it is good; but if you find it hard, and crunch between your teeth, then it is bad, and not well burned. Good colcoath of vitriol is of a deep red, or of a deep purple colour, and is soft and oily when rubbed between the fingers; bad colcoath of vitriol is of a light red colour, and feels harsh and gritty. The colcoath of vitriol should be levigated between two surfaces of polished steel, and wrought with a little water; when it is worked dry, you may add a little more water, to carry it lower down to what degree you please. When the colcoath of vitriol has been wrought dry three or four times, it will acquire a black colour, and will be low enough, or sufficiently fine, to give an exquisite lustrous. This levigated colcoath of vitriol must be put into a small phial, and kept with some water upon it. When it is to be used, every part of the pitch-polisher must be first brushed over with a fine camel's hair brush, which has been dipped in pure water, and rubbed gently over a piece of dry clean soap. The washed colcoath of vitriol is then to be put upon the polisher; and Mr Edwards directs a large quantity of it to be put on at once, so as to saturate the pitch, and form a fine coating. If a second or third application of this powder be found necessary, it must be used very sparingly, or the polish will be destroyed which has been already attained. When the metal is nearly polished, there will always appear some black mud upon its surface, as well as upon the tool. Part of this must be wiped away with some very soft wash leather; but if the whole of it be taken away, the polishing will not be so well completed.

With respect to the *parabolic figure* to be given to
VOL. XIX. Part II.

the mirror, Mr Edwards assures us, that a very little experience in these matters will enable any one to give it with certainty, by polishing the speculum in the common manner, only with cross strokes in every direction, upon an elliptical tool of the proper dimensions.

SPECTULUM, a looking glass or mirror, capable of reflecting the rays of the sun.

SPECTULUM, in *Surgery*, an instrument for dissecting a wound, or the like, in order to examine it attentively. See *SURGERY*.

SPEECH, in general, the art or act of expressing a person's thoughts by means of articulate sounds, which we call words. See *LANGUAGE, GRAMMAR, READING, and ORATORY, Part IV.*

SPEED, JOHN, an English historian, was born at Farington, in Cheshire, in the year 1542. He was by profession a taylor, and freeman of the company of merchant taylors in the city of London. In 1606, he published his *Theatre of Great Britain*, which was afterwards reprinted in folio, under the title of the *Theatre of the Empire of Great Britain*. His Genealogies of Scripture were first bound up with the Bible in 1611, when the first edition of the present translation was printed. In 1614 appeared his *History of Great Britain*, which has been translated into Latin; and in 1616 he published his *Cloud of Witnesses*, in octavo. He lived in marriage 57 years with his wife, by whom he had twelve sons and six daughters; and died in 1629. He was interred in the church of St Giles's, Cripplegate, London, where a monument was erected to his memory.

SPEEDWELL. See *VERONICA, BOTANY Index.*

SPELL, a charm consisting of some words of occult power, generally attended with some ceremony.—In order to explain it, we will produce a few examples. On St Agnes's night, 21st of January, take a row of pins, and pull out every one, one after another, saying a Pater-noster on flicking a pin in your sleeve, and you will dream of him or her you shall marry.

Another method to see a future spouse in a dream. *Go to's Prop.*
The party inquiring must lie in a different county from that in which he commonly resides, and on going to bed must knit the left garter about the right-legged stocking, letting the other garter and stocking alone; and as he rehearses the following verses, at every comma knit a knot:

This knot I knit,
To know the thing I know not yet;
That I may see
The man (woman) that shall my husband (wife) be,
How he goes, and what he wears,
And what he does all days and years.

Accordingly, in a dream, he will appear with the insignia of his trade or profession.

Another, performed by charming the moon, thus: At the first appearance of the new moon, immediately after the new year's day, (though some say any other new moon is as good), go out in the evening, and stand over the spars of a gate or stile, and, looking on the moon, repeat the following lines:

All hail to the moon! all hail to thee!
I prithee, good moon, reveal to me
This night who my husband (wife) shall be.

Immediately after you shall go to bed, when you will dream of the person destined for your future husband or wife.

SPELLING, in *Grammar*, that part of orthography which teaches the true manner of resolving words into their syllables.

All words are either simple or compound, as *use, a life; done, undone*; and the rules for dividing each must be such as are derived from the analogy of language in general, or from the established custom of speaking; which, for the English language, are reduced to the following rules: 1. A consonant between two vowels must be joined with the latter in spelling, as *na-ture, covi-sly, ge-ne-rous*; except, however, the letter *x*, which is joined to the first, as in *flax-en, ox-en*, &c. and compound words, as in *up-on, un-ufed*, &c. 2. A double consonant must be divided, as in *let-ter, man-ner*, &c. 3. Those consonants which can begin a word must not be parted in spelling, as in *de-fraud, re-prove, di-strict*; however, this rule is found sometimes to fail; for though *gn* begins a word, as *gnave, gnaw*, &c. yet it must be divided in spelling, as in *cog-ni-sance, ma-lig-ni-ty*, &c. 4. Those consonants which cannot begin a word must be divided, as *ll* in *feldom, ll* in *mul-ti-tude, mp* in *temper, rd* in *er-dent*; but in final syllables there are exceptions, as *ll* in *ti-tle, dl* in *hand-les*, &c. 5. When two vowels come together, and are both of them distinctly sounded, they must be separated in spelling, as in *co-e-val, ma-tu-ral*, &c. 6. The grammatical terminations or endings must be separated in spelling, as *ed* in *wing-ed, est* in *de-li-er-est, ing* in *lear-ing, ance* in *de-li-er-ance*, &c. 7. Compound words must be resolved into their simple or component words, as *up-on, in-to, ne-ver-the-less, not-with-stand-ing*, &c.

SPELTMAN, SIR HENRY, an eminent English antiquarian, was descended from an ancient family, and born at Cengham, near Lynn in Norfolk, about the year 1561. He was knighted by King James I. who had a particular esteem for him on account of his known capacity for business; and he employed him several times in Ireland on public affairs. When he was about 50 years of age, he went to reside in London; where falling into a study to which his own genius had always inclined him, he collected all such books and MSS. as concerned the subject of antiquities, either foreign or domestic. In 1626, he published the first part of his well-known Glossary, which he never carried beyond the letter L; because, as some have suggested, he had said things under "Magna charta," and "Maximum contumeliam," that could not then have appeared without giving offence. Upon his death all his papers came into the hands of his son Sir John Spelman, a gentleman who had abilities to have completed his father's design, if death had not prevented him. The second part was afterwards published by Sir William Dugdale; but with all the marks of a scanty unfinished performance. The next work he entered upon was an edition of the English Councils, of which he published the first volume about two years before his death, leaving the second volume, as well of this as of his Glossary, to be published by Sir William Dugdale. Sir Henry wrote several other things, all relating to ancient laws and customs, and died in 1641. His Posthumous Works

were published in folio, 1698, under the inspection of Mr Gibson, afterwards bishop of London.

SPELTER, in *Metallurgy*, the same with ZINC.

SPENCE, JOSHUA, an eminent writer, was fellow of New College, Oxford, where he took the degree of A. M. in 1727. About that time he became first known as an author, by an *Essay on Pope's Odyssey*, in which some particular beauties and blemishes of that work are considered; a work of great merit, and which for sound criticism and candid disquisition is almost without a parallel. He was elected professor of poetry by the university in 1728, and held that office ten years, which is as long as the statutes will allow. His History of Stephen Duck was first published in 1731; but it was afterwards much altered, and prefixed to an edition of Duck's poems.

About this time he travelled into Italy as tutor to the earl of Lincoln, afterwards duke of Newcastle.— In 1736 he republished Gorboduc, at Mr Pope's desire, with a preface giving an account of the author, the earl of Dorset. He quitted his fellowship in 1742, upon being presented by the Society of New College to the rectory of Great Harwood in Buckinghamshire.— He never resided in his living; but paid it an annual visit, distributing large sums of money among the poor, and providing for many of their children. The same year he was made professor of modern history at Oxford. In 1747 he published *Polymetis*; or an inquiry concerning the agreement between the works of the Roman poets and the remains of ancient artists, being an attempt to illustrate them mutually from each other. This work was treated by Gray with a contempt which it did not deserve. He raises objections because the author did not illustrate his subject from Greek writers; that is, because he failed to execute what he never undertook. He was installed prebendary of the tenth stall at Durham the 24th May 1754. He published the same year, "An Account of the Life, Character, and Poems, of Mr Blacklock, student of philosophy at Edinburgh;" which was afterwards prefixed to his Poems. The prose pieces which he printed in the Museum he collected and published, together with some others, in a pamphlet called *Moralities*, by Sir Harry Beaumont. Under the same name he published "Crito, or a Dialogue on Beauty," and "A particular Account of the Emperor of China's Gardens near Peking, in a letter from F. Attiret, a French missionary now employed by that emperor to paint the apartments in those gardens, to his friend at Paris." Both these treatises are printed in Doddsley's fugitive pieces, as is also "A Letter from a Swiss Officer to his friend at Rome;" which Mr Spence first published in the Museum. In 1758 he published "A Parallel, in the Manner of Plutarch, between a most celebrated man of Florence and one scarce ever heard of in England." This was also inserted in the fugitive pieces. The same year he made a journey into Scotland, which he described in an affectionate letter to Mr Shenstone, published in Hall's Collection of Letters, 1778. In 1764 he was very well described by Mr James Hildely, in his admirable Tales of the Genii, under the name of *Phelot Eneeps* (his name read backwards), derive of the groves. A letter from Mr Spence to that ingenious moralist, under the same signature, is preserved in the 3d volume of "Let-

ters of Eminent Persons." In 1768 he published "Remarks and Dissertations on Virgil, with some other classical observations, by the late Mr Holdsworth." On the 20th of August the same year he was unfortunately drowned in a canal in his garden at Byfleet in Surrey. He was found flat upon his face at the edge of the canal, where the water was so shallow as not even to cover his head. The accident, it was supposed, for he was quite alone, was owing to a fit.

The duke of Newcastle possesses some manuscript volumes of anecdotes collected by Mr Spence, from which Dr Johnson was permitted to insert many extracts in his Lives of the Poets.

SPENCER, DR JOHN, an eminent divine, was born in Kent in 1632, and educated at Cambridge. He was chosen fellow of his college, and took a doctor's degree in 1663. In 1667 he was chosen master of Corpus Christi College, and preferred to the deanery of Ely in 1677. He died on the 23th of May 1695. His works are, 1. The Righteous Ruler; a sermon on Proverbs xxix. 2. preached June 28. 1660. 2. A Discourse concerning Prodiges, wherein the vanity of presages by them is reprehended, and their true and proper ends asserted and vindicated. To this excellent work was afterwards added, A Discourse concerning vulgar prophecies, wherein the vanity of receiving them as the certain indications of any future event is exposed; and some marks of distinction between true and pretended prophecies are laid down. 3. A Latin Dissertation concerning Urim and Thummim. 4. His famous treatise *De legibus Hebræorum ritualibus et earum rationibus*. The intention of this book, as he informs us himself, was to vindicate the Deity from the imputation of acting from arbitrary and fantastical motives. It has been highly and justly esteemed both for the elegance of style and the uncommon erudition and sound sense which it displays. It has, however, (that part of it particularly which endeavours to deduce some of the Jewish ceremonies from the practices of their heathen neighbors), alarmed many persons, as if such a doctrine, if it could be proved, would derogate from the Divine wisdom, and undermine revelation. But this is so far from being the case, that Dr Spencer's attempt, whether successful or not, deserves the gratitude of Christians, because it has a tendency to throw light on an important and difficult subject.

SPENSER, EDMUND, the poet, was born in London in the year 1553, and descended from an ancient family of the Spensers in Northamptonshire. All we know concerning his education is, that he was admitted a sizer of Pembroke-hall in Cambridge, and matriculated in 1569. At this time began his intimacy with Mr Gabriel Harvey, a man of genius and a poet. In 1576, having completed his degrees in arts, he left the university, as it is conjectured, for want of subsistence, and retired to the north of England. Here he had the misfortune to become enamoured of his kinsland, who, after flattering his passion for a time, at length prekr-

red his happier rival. Spenser continued in the country till the year 1578, when, at the persuasion of his friend Mr Harvey he removed to London, where that gentleman introduced him to Mr Sidney (afterwards Sir Philip Sidney). Concerning his first introduction to Sir Philip, there is indeed a different story, which was first told by the writer of his life, prefixed to his works in 1679, and transcribed by Hughes, Cibber, and several others; which, nevertheless, is certainly not true. The purport of it is, that Spenser, being unknown to this Meccenas of the age, went to Leicester-house, and sent in the 9th canto of the first book of the Fairy Queen; that, on reading part of it, Sir Philip ordered his steward to give the bearer 50l.; on reading a little farther 50l. more; then 200l. bidding him to make haste and pay the money, lest he should give the poet his whole estate. The story tells prettily enough; but it is very certain, that the Fairy Queen was begun long after his acquaintance with Sir Philip. By this universal patron of genius, however, he was presented to Queen Elizabeth, who honoured him with the place of poet-laureat. About this time he finished his *Shepherd's Calendar*, which was first printed in 1579; and in the following year, being recommended by his patron to the earl of Leicester, he went to Ireland as secretary to the lord Grey of Wilton, then appointed lord-lieutenant of that kingdom. Lord Grey was recalled in 1582, and with him Spenser returned to London, where he continued till after the death of Sir Philip Sidney in 1586; a loss which he bewailed to the end of his life. The following year, our poet, having obtained a royal grant of 3000 acres of forfeited lands in the county of Cork in Ireland, set out for that kingdom, took possession of his estate, and fixed his residence in the castle of Kilcolman, which had belonged to the earl of Desmond. In this retirement he resumed his great work of the Fairy Queen; and continued in Ireland till, being visited by his old friend Sir Walter Raleigh in 1589, he came over with him to England, but returned to Ireland the year following, where he fell in love with a country girl, and married her. Soon after his marriage, he paid another visit to his native country, where we also find him in 1596. In the following year he returned once more to Kilcolman; but on the rebellion of Lord Tyrone, who ravaged the whole county of Cork, he was obliged to fly for safety with his family to England, where, in the year 1599, he died in extreme poverty (A). He was buried in Westminster Abbey, according to his request, near Chaucer. A monument was erected to his memory by Ann countess of Dorset. We know but little of his character as a man; as a poet, considering the age in which he lived, he deserves our utmost veneration. He wrote various pieces besides those above mentioned. His whole works, with his life by Hughes, were published in six volumes 12mo, in 1715 and 1730.

SPERGULA, SPURKEY, a genus of plants belonging to the class of decandria; and in the natural system

(A) This is Camden's account, and it has been generally believed; but Mr Malone, the last editor of Shakespeare's works, by examining the patent roll, 33 Eliz. p. 3. has discovered, that in February 1600-1 Spenser obtained from Queen Elizabeth an annuity or pension of 50l. during his life; a sum equivalent to 200l. at present.

Sperm. arranged under the 22d order, *caryophylleæ*. See Botany Index.
Spermat. *Ind. v.*

SPERM, the feed whereof an animal is formed. See PHYSIOLOGY.

SPERMACEŬ, a whitish, stenuous, staky substance, prepared from oil, but chiefly from the brains of a species of whale called *physeter macrocephalus*.

The method of preparing spermaceti is kept a secret; but the process is said to be this: The brains being taken out of the animal, are then, as some say, melted over a gentle fire, poured into moulds, and when cold melted again; and this process is continued till they are purified. Others say, that after being pressed and drained they are more thoroughly purified by steeping them in a ley of alkaline salt and quicklime. The brains are then washed, and cut into thin flakes or slices with woccken knives. One fifth is said to afford some tons of brains. Good spermaceti is glossy and semitransparent, in fine white flakes; soft and unctuous to the touch, yet dry and friable; in taste, somewhat like butter, and of a faint smell like that of tallow. Some adulterate it with wax; but the deceit is discovered, either by the smell of the wax or by the dulness of the colour. Some also sell a preparation of oil taken from the tail of the whale instead of that from the brain; but this kind turns yellow as soon as exposed to the air. Indeed it is apt in general to grow yellowish, and to contract a rancid stinky smell if not carefully secured from the air. The more perfectly it has been purified at first, the less susceptible it is of these alterations; and after it has been changed, it may be rendered white and sweet again by keeping it afresh in a ley of alkaline salt and quicklime. It melts in a small degree of heat, and congeals again as it cools.

Spermaceti is of use in medicine. Quincy says it is a noble remedy in the asthma, &c. though chiefly used in bruises, inward hurts, and after delivery. For internal use, it may be dissolved in aqueous liquors into the form of an emulsion, by trituration with almonds, the yolk or white of an egg, and more elegantly by mucilages; or made into a lochoc, by mixing two drams of it with a suitable quantity of yolk of egg, then adding half an ounce of fresh drawn oil of almonds, and an ounce of balsamic syrup. Spermaceti is not capable of being dissolved by caustic alkalies, and of forming soaps, like other oily matters; but it is altogether soluble in oils, and unites by liquefaction with wax and resin; and in these forms is applied externally. But it is certain, its greatest property, and that which makes it so much in vogue in many places, is its softening the skin. Whence it comes to be used by the ladies in pastes, washes, &c.

Spermaceti candles are of modern manufacture: they are made smooth, with a fine gloss, free from rings and tears, superior to the finest wax candles in colour and lustre; and, when genuine, leave no spot or stain on the finest silk, cloth, or linen.

A method has been lately proposed by Dr Smith Gibbs of Bristol, to convert animal muscle into a substance much resembling spermaceti. The process is remarkably simple: Nothing more is necessary than to take a dead carcase and expose it to a stream of running water: it will in a short time be changed to a mass of fatty matter. To remove the offensive smell, a quantity

of nitrous acid may then be poured upon it, which uniting with the fetid matter, the fat is separated in a pure state. This acid indeed turns it yellow, but it may be rendered white and pure by the action of the oxygenated muriatic acid. Mr Gibbs brought about the same change in a much shorter time. He took three lean pieces of mutton and poured on them the three mineral acids, and he perceived that at the end of three days each was much altered; that in the nitrous acid was much softened, and on separating the acid from it, he found it to be exactly the same with that which he had before got from the water; that in the muriatic acid was not in that time so much altered; the vitriolic acid had turned the other black.

SPERMACOCE, BUTTON-WOOD, a genus of plants belonging to the class of tetrandria; and in the natural system arranged under the 47th order, *Stellateæ*. See Botany Index.

SPERMATIC, in Anatomy, something belonging to the sperm or seed.

SPEUSIPPUS, an Athenian philosopher, the nephew and successor of Plato. Contrary to the practice of Plato, Speusippus required from his pupils a stated gratuity. He placed statues of the Graces in the school which Plato had built. On account of his infirm state of health, he was commonly carried to and from the academy in a vehicle. On his way thither one day met Diogenes, and saluted him; the surly philosopher refused to return the salute, and told him, that such a feeble wretch ought to be ashamed to live; to which Speusippus replied, that he lived not in his limbs, but in his mind. At length, being wholly incapacitated, by a paralytic stroke, for the duties of the chair, he resigned it to Xenocrates. He is said to have been of a violent temper, fond of pleasure, and exceedingly avaricious. Speusippus wrote many philosophical works, which are now lost, but which Aristotle thought sufficiently valuable to purchase at the expence of three talents. From the few fragments which remain of his philosophy, it appears that he adhered very strictly to the doctrine of his master.

SPEY, a river of Scotland, rising from a lake of the same name in Badenoch, and, after a serpentine course of 76 miles, passes by Rothes cattle, and falls into the German sea at Garmoch near Elgin. Mr Pennant tells us, that the Spey is a dangerous neighbour to Cattle Gordon, overflowing frequently in a dreadful manner, as appears by its ravages far beyond its banks. The bed of the river is wide and full of gravel, and the channel very shifting. In 1746 the duke of Cumberland passed this river at Belly church, near Cattle Gordon, when the channel was so deep as to take an officer, from whom Mr Pennant had the account, and who was six feet four inches high, up to the breast. The banks are here very high and steep; so that had not the rebels been intoxicated in such a manner as to neglect opposition, the passage must have been attended with considerable loss. On this river there is a great salmon-fishery; about 1700 barrels full are caught in the season, and the shore was formerly rented for about 1200l. per annum: now it is probably doubled.

SPHACELUS, in Surgery and Medicine, an absolute and perfect corruption or death of the parts.

SPHERANTHUS, a genus of plants belonging to the

Sphagnum the class of *fyngenefia*, and to the order of *polygamia* *felegata*; and in the natural system arranged under the 49th order, *Compositae*. See **BOTANY Index**.

SPHAGNUM, Bog-moss, a genus of plants belonging to the class of *cryptogamia* and order of *musci*. See **BOTANY Index**.

OS SPHENOIDES, the seventh bone of the cranium or skull. See **ANATOMY**, N° 11.

SPHERE, is a solid contained under one uniform round surface, every point of which is equally distant from a certain point in the middle called its *cent*; and is formed by the revolution of a femicircle about its diameter. See **GEOMETRY**.

Projection of the SPHERE. See **PROJECTION**.

SPHERE, in *Astronomy*, that concave orb or expanse which invests our globe, and in which the heavenly bodies appear to be fixed, and at an equal distance from the eye.

The better to determine the places of the heavenly bodies in the sphere, several circles are supposed to be described on the surface thereof, hence called the *circles of the sphere*: of these some are called *great circles*, as the equinoctial, ecliptic, meridian, &c. and others *small circles*, as the tropics, parallels, &c. See **GEOGRAPHY**; and **ASTRONOMY**, *passim*.

Armillary SPHERE. See **GEOGRAPHY**.

SPHERE of Activity of a Body, is that determinate space or extent to which, and no farther, the effluvia continually emitted from that body reach; and where they operate according to their nature.

SPHERES, in *Optics*, the same with *metalline mirrors*, for telescopes or other purposes. See **MIRROR**.

SPHEROID, in *Geometry*, a solid approaching to the figure of a sphere. It is generated by the entire revolution of a semi-ellipsis about its axis. When the revolution is made round the largest axis, the spheroid is called *prolate*; and when round the shortest, *oblate*. This last is the figure of the earth, and of all the planets.

SPHEX, *ICHNEUMON WASP*, or *Savage*; a genus of insects belonging to the order of *hymenoptera*. See **ENTOMOLOGY Index**.

SPHINCTER, in *Anatomy*, a term applied to a kind of circular muscles, or muscles in form of rings, which serve to close and draw up several orifices of the body, and prevent the excretion of the contents.

SPHINX, in fabulous history, a monster which had the head and breasts of a woman, the body of a dog, the tail of a serpent, the wings of a bird, the paws of a lion, and a human voice. It sprang from the union of Orthos with the Chimæra, or of Typhon with Echidna. The Sphinx had been sent into the neighbourhood of Thebes by Juno, who wished to punish the family of Cadmus, which she persecuted with immortal hatred, and it laid this part of Bœotia under continual alarms, by proposing enigmas, and devouring the inhabitants if unable to explain them. In the midst of their consideration the Thebans were told by the oracle, that the sphinx would destroy herself as soon as one of the enigmas she proposed was explained. In this enigma she wished to know what animal walked on four legs in the morning, two at noon, and three in the evening. Upon this Creon King of Thebes promised his crown and his sister Jocasta in marriage to him who could deliver his

country from the monster by a successful explanation of the enigma. It was at last happily explained by Oedipus, who observed, that man walked on his hands and feet when young, or in the morning of life; at the noon of life he walked erect; and in the evening of his days he supported his infirmities upon a stick. (*Utd. Oedipus*). The sphinx no sooner heard this explanation than she dashed her head against a rock, and immediately expired. Some mythologists wish to unriddle the fabulous traditions about the sphinx by the supposition that one of the daughters of Cadmus, or Laius, infected the country of Thebes by her continual depredations, because she had been refused a part of her father's possessions. The lion's paw expressed, as they observe, her cruelty, the body of the dog her lasciviousness, her enigmas the fires she laid for strangers and travellers, and her wings the dispatch she used in her expeditions.

Among the Egyptians the sphinx was the symbol of religion, by reason of the obscurity of its mysteries; and on the same account the Romans placed a sphinx in the pinnacles or porch of their temples. Sphinxes were used by the Egyptians to show the beginning of the water's rising in the Nile: with this view, as it had the head of a woman and body of a lion, it signified that the Nile began to swell in the months of July and August, when the sun passes through the signs of Leo and Virgo. There are several of these still to be seen; one in particular, near the pyramids, much spoken of by the ancients; being of a prodigious size, and cut out of the rock; the head and neck appear only at present, the rest of the body being hid in the sand. This, according to Thevenot, is 26 feet high, and 15 feet from the ear to the chin: but Pliny assures us, the head was no less than 102 feet in circumference, and 62 feet high from the belly, and that the body was 143 feet long, and was thought to be the sepulchre of King Amasis.

The learned Mr Bryant* observes, that the sphinx ^{Asiatic} seems to have been originally a vast rock of different strata; which, from a diapedesis ^{of the} ^{10. 46.} ^{12. 24.} into a sphinx, the Egyptians fashioned into an object of beauty and veneration. The Egyptians used this figure in their building; from them the Greeks derived it, and afterwards improved it into an elegant ornament. It is also frequently used in modern architecture.

It is proper to observe, that the sphinx of the Egyptians is laid in the Asiatic Researches† to have been found in India. Colonel Percie was told by Munari Pandit, a man of learning among the Hindoos, that the sphinx, there called *singh*, is to appear at the end of the world, and as soon as he is born will prey on an elephant: he is therefore figured seizing an elephant in his claws; and the elephant is made small, to show that the *singh*, even a moment after his birth, will be very large in proportion to it. But in opposition to this account given by Munari Pandit, the late Sir William Jones, the learned and illustrious president of the Asiatic Society, was assured by several Brahmins, that the figure taken for a sphinx was a representation of a lion seizing a young elephant. This point therefore requires farther investigation.

SPHINX, *HETEROMELA*, a genus of insects belonging to the order of *hymenoptera*. See **ENTOMOLOGY Index**.

SPHIGLIA, Water-moss, a genus of plants belonging to the order of *musci*.

Sphinx,
Sphix

Lom-
priore's Di-
stichæ
Sphix

10. 11.
12. 12.

longing to the class of pentandria; and in the natural system arranged under the 47th order, *Stellatee*. See **BOTANY** and **MATERIA MEDICA Index**.

SPICE, any kind of aromatic drug that has hot and pungent qualities: such are pepper, nutmeg, ginger, cinnamon, cloves, &c.

SPICE-Islands, in the East Indies. See **BANDA, MOLUCCA-Islands**, and **Ceylon**.

SPIDER. See **ARANEAE, ENTOMOLOGY Index**.

SPIDERWORT. See **PHALANGIUM**, } **BOTANY In-**

SPIGNEL. See **ATHAMANTA**, } **dex.**

SPIKE, or *Oil of SPIKE*, a name given to an essential oil distilled from lavender, and much used by the varnish-makers and the painters in enamel.

SPIKENARD. See **NARDUS, BOTANY Index**.

SPILANTHUS, a genus of plants belonging to the class of syngenesia. See **BOTANY Index**.

SPINA CERVINA, an old name for rhamnus catharticus. See **RHAMNUS, BOTANY Index**.

SPINA-Ventosa, in *Surgery*, that species of corruption of the bones which takes its rise in the internal parts, and by degrees enlarges the bone, and raises it into a tumor. See **SURGERY**.

SPINACIA, SPINAGE, a genus of plants belonging to the class of diccia; and in the natural system arranged under the 12th order, *Holoraceae*. See **BOTANY Index**; and for an account of the method of cultivating spinage in the garden, see **GARDENING**.

SPINAGE, or **SPINACH**. See **SPINACIA**.

SPINÆ, in *Botany*, thorns, rigid prickles: a species of *arma*, growing on various parts of certain plants for their defence; *spinæ ramorum arcent pecora*. On the branches we find examples in the pyrus, prunus, citrus, hippophaea, melina, rhamnus, lycium, &c.; on the leaves, in the aloe, agave, yucca, ilex, hippomane, theopratta, carlina, &c.; on the calyx, in the carduus cnicus, centaurea, moluccella, galopsis, &c.; on the fruit, in the trapa, tribulus, murex, spinacia, agrimonia, datura, &c.

SPINAL MARROW. See **ANATOMY Index**.

SPINALIS, in *Anatomy*, the name of several muscles, &c. of the spine.

SPINDLE, in *Geometry*, a solid body generated by the revolution of some curve line about its base or double ordinate; in opposition to a conoid, which is generated by the rotation of the curve about its axis or absciss, perpendicular to its ordinate. The spindle is denominated circular, elliptic, hyperbolic, or parabolic, according to the figure of its generating curve.

SPINDLE-TREE. See **EUONYMUS, BOTANY Index**.

SPINE, SPINA DORSI. See **ANATOMY, N^o 30**.

SPINE. See **SPINÆ**.

SPINET, or SPINETT, a musical instrument ranked in the second or third place among harmonious instruments. It consists of a chest or belly made of the most porous and resinous wood to be found, and a table of it glued on slips of wood called *fammers*, which bear on the sides. On the table are raised two little prominences or bridges, wherein are placed so many pins as there are chords or strings to the instrument. It is played on by two ranges of continued keys, the former range being the order of the diatonic scale, and that behind the order of the artificial notes or semitones. The keys are so many flat pieces of wood, which, touched and pressed down at the end, make the other raise a

jack which strikes and sounds the strings by means of the end of a crow's quill, wherewith it is armed. The 30 first strings are of brass, the other more delicate ones of steel or iron-wire; they are all stretched over the two bridges already mentioned. The figure of the spinet is a long square or parallelogram; some call it an *harp couched*, and the harp an *inverted spinet*. See the article **HARP**.

This instrument is generally tuned by the ear, which method of the practical musicians is founded on a supposition that the ear is a perfect judge of an octave and a fifth. The general rule is to begin at a certain note, as C, taken towards the middle of the instrument, and tuning all the octaves up and down, and also the fifths, reckoning seven semitones to each fifth, by which means the whole is tuned. Sometimes to the common or fundamental play of the spinet is added another similar one in unison, and a third in octave to the first, to make the harmony the fuller; they are either played separately or together by means of a stop: these are called *double* or *triple spinets*; sometimes a play of violins is added, by means of a bow, or a few wheels parallel to the keys, which press the strings and make the sound last as long as the musician pleases, and heighten and soften them more or less, as they are more or less pressed. The harpichord is a kind of spinet, only with another disposition of the keys (see the article **HARPSICHORD**). The instrument takes its name from the small quill ends which touch the strings, resembling *spine* or thorns.

SPINFEX, a genus of plants belonging to the class of *polygamia*. See **BOTANY Index**.

SPINNING, in *Commerce*, the act or art of reducing silk, flax, hemp, wool, hair, or other matters, into thread. Spinning is either performed on the wheel, or with a distaff and spindle, or with other machines proper for the several kinds of working. Hemp, flax, nettle-thread, and other like vegetable matters, are to be wetted in spinning: silks, wools, &c. are spun dry, and do not need water; yet there is a way of spinning or reeling silk as it comes off the cases or balls, where hot and even boiling water is to be used (see **SILK**). The vast variety, and the importance of those branches of our manufactures, which are produced from cotton, wool, and flax, spun into yarn, together with the cheapness of provisions, and the low price of labour in many foreign countries, which are our rivals in trade, have occasioned many attempts at home to render spinning more easy, cheap, and expeditious; for which see **COTTON-SPINNING** and **COTTON MILLS**.

To give an intelligible and accurate description of a cotton mill would be abundant employment for a volume. Our limits admit of nothing like this; but as we are certain that many of our readers have viewed a cotton mill with wonder, but not with intelligence, or with leisure to trace the steps by which the wool from the bag ultimately assumes the form of a very fine thread. Bewildered by such a complication of machinery, all in rapid motion, very few, we imagine, are able to recollect with distinctness and intelligence the essential part of the progress by which the form of the cotton is so wonderfully changed. Such readers will not think a page or two misemployed, if they are thereby able to understand this particular, to which all the rest of the process is subservient.

We pass over the operation of carding, by which all the

Spinning. the clots and inequalities of the cotton wool are removed, and the whole is reduced to an uniform thin fleece, about 20 inches broad. This is gradually detached from the finishing card, and, if allowed to hang down from it, would pile up on the floor as long as the mill continues to work; but it is guided off from the card, very tenderly, in a horizontal direction, by laying its detached end over a roller, which is slowly turned round by the machine. Another roller lies above the fleece, pressing it down by its weight. By this pressure, a gentle hold is taken of the fleece, and therefore the slow motion of the rollers draws it gently from the card at the same rate as it is disengaged by the comb; but between the card and the rollers a set of smooth pins are placed in two rows, leading from the card to the rollers, and gradually approaching each other as we approach the rollers. By these pins the broad fleece is hemmed in on both sides, and gradually contracted to a thick roll; and in this state passes between the rollers, and is compressed into a pretty firm flat riband, about two inches broad, which falls off from the rollers, and piles up in deep tinplate cans set below to receive it.

It is upon this stripe or riband of cotton wool that the operation of spinning begins. The general effect of the spinning process is to draw out this massive roll, and to twist it as it is drawn out. But this is not to be done by the fingers, pulling out as many cotton fibres at once as are necessary for composing a thread of the intended fineness, and continuing this manipulation regularly across the whole end of the riband, and thus, as it were, nibbling the whole of it away. The fingers must be directed, for this purpose, by an attentive eye. But in performing this by machinery, the whole riband must be drawn out together, and twisted as it is drawn. This requires great art, and very delicate management. It cannot be done at once; that is, the cotton roll cannot first be stretched or drawn out to the length that is ultimately produced from a tenth of an inch of the roll, and then be twisted. There is not cohesion enough for this purpose; we should only break off a bit of the roll, and could make no farther use of it. The fibres of cotton are very little implicated among each other in the roll, because the operation of carding has laid them almost parallel in the roll; and though compressed a little by its contraction from a fleece of 20 inches to a riband of only two, and afterwards compressed between the discharging rollers of the carding machine, yet they cohere so slightly, that a few fibres may be drawn out without bringing many others along with them. For these reasons, the whole thickness and breadth of two or three inches of the riband is stretched to a very minute quantity, and then a very slight degree of twist is given it, viz. about three turns in the inch; so that it shall now compose an extremely soft and spongy cylinder, which cannot be called a thread or cord, because it has scarcely any firmness, and is merely rounder and much flenderer than before, being stretched to about thrice its former length. It is now called *slab*, or *roove*.

Although it be still extremely tender, and will not carry a weight of two ounces, it is much more cohesive than before, because the twist given to it makes all the longitudinal fibres bind each other together, and compress those which lie athwart; therefore it will require more force to pull a fibre from among the rest, but still not nearly enough to break it. In drawing out a single

fibre, others are drawn out along with it; and if we take hold of the whole assemblage, in two places, about an inch or two inches asunder, we shall find that we may draw it to near twice its length without any risk of its separating in any intermediate part, or becoming much smaller in one part than another. It seems to yield equally over all.

Such is the state of the slab or roove of the first formation. It is usually called the *preparation*; and the operation of spinning is considered as not yet begun. This preparation is the most tedious, and requires more attendance and hand labour than any subsequent part of the process. For the stripes or ribands from which it is made are so light and bulky, that a few yards only can be piled up in the cans let to receive them. A person must therefore attend each thread of slab, to join fresh stripes as they are expended. It is also the most important in the manufacture: for as every inch of the slab meets with precisely the same drawing and the same twisting in the subsequent parts of the process, therefore every inequality and fault in the slab (indeed in the fleece as it quits the finishing card) will continue through the whole manufacture. The spinning of cotton yarn now divides into two branches. The first, performed by what are called *jenner*, perfectly resembles the ancient spinning with the distaff and spindle; the other, called *spinning of twist*, is an imitation of the spinning with the fly-wheel. They differ in the same manner as the spinning with the old wool or cotton wheel differs from the spinning with the flax-wheel. Mr Arkwright's chief invention, the substitution of machinery for the immediate work of the human finger, is seen only in the manufacture of twist. We shall therefore confine our attention to this.

The rest of the process is little more than a repetition of that gone through in making the first slab or roove. It is formed on bobbins. These are set on the back part of the drawing frame; and the end of the slab is brought forwards toward the attending workman. As it comes forward, it is stretched or drawn to about four-thirds of its former length, or lengthened one-third; and is then twisted about twice as much as before, and in this state wound up on another bobbin. In some mills two rooves, after having been properly drawn, are brought together through one hole, and twisted into one; but we believe that, in the greater number of mills, this is deferred to the second drawing. It is only after the first drawing that the produce of the operation gets the name of *slab*; before this it is called *preparation*, or *roove*, or by some other name. The slab is still a very feeble, soft, and delicate yarn, and will not carry much more weight than it did before in the form of roove. The perfection of the ultimate thread or yarn depends on this extreme softness; for it is this only which makes it susceptible of an equal stretching; all the fibres yielding and separating alike.

The next operation is the *second drawing*, which no way differs from the first, except in the different proportions of the lengthening, and the proportion between the lengthening and the subsequent twist. On these points we cannot give any very distinct information. It is different in different mills, and with different species of cotton wool, as may be easily imagined. The immediate mechanism or manipulation must be skillfully accommodated to the nature of that which

Spinning

Spinning.

which the fibres of cotton exert on each other, enabling one of them to pull others along with it. This is greatly aided by the contorted curled form of a cotton fibre, and a considerable degree of elasticity which it possesses. In this respect it greatly resembles woollen fibres, and differs exceedingly from those of flax: and it is for this reason that it is scarcely possible to spin flax in this way: its fibres become lank, and take any shape by the slightest compression, especially when damp in the slightest degree. But besides this, the surface of a cotton fibre has a harshness or roughness, which greatly augments their mutual friction. This is probably the reason why it is so unfit for tents and other dressings for wounds, and is refused by the surgeon even in the meanest hospital. But this harshness and its elasticity fit it admirably for the manufacture of yarn. Even the thorniness of the fibre is favourable; and the manufacture would hardly be possible if the fibre were twice as long as it generally is. If it be just so long that in the finished thread a fibre will rather break than come out from among the rest, it is plain that no additional length can make the yarn any stronger with the same degree of compression by twisting. A longer fibre will indeed give the same firmness of adherence with a smaller compression. This would be an advantage in any other yarn; but in cotton yarn the compression is already as slight as can be allowed; were it less, it would become woolly and rough by the smallest usage, and is already too much disposed to tangle out. It can hardly be used as sewing thread. Now suppose the fibres much longer; some of them may chance to be stretched along the flax through their whole length. If the flax is pulled in opposite directions, by pinching it at each end of such fibres, it is plain that it will not stretch till this fibre be broken or drawn out; and that while it is in its extended state, it is acting on the other fibres in a very unequal manner, according to their positions, and renders the whole apt to separate more irregularly. This is one great obstacle to the spinning of flax by similar machinery; and it has hitherto prevented (we believe) the working up of any thing but the *florts* or tow, which is separated from the long fine flax in the operation of hatching.

A third, and sometimes even a fourth, drawing is given to the flax formed on the bobbin of this second operation. The flax produced is now a slender, but still extremely soft cord, susceptible of considerable extension, without risk of separation, and without the smallest chance of breaking a single fibre in the attempt. In one or more of the preparatory drawings now described, too, and sometimes three flabs, of a former drawing, are united before the twist is given them. The practice is different in different mills. It is plain, that unless great care be taken to preserve the flax extremely soft and compressible during the whole process, the subsequent drawing becomes more precarious, and we run a risk of at last making a bad loose thread instead of a uniform and simple yarn. Such a thread will have very little lateral connection, and will not bear much handling without separating into strands. The perfection of the yarn depends on having the last flax as free of all appearance of strands as possible.

The last operation is the spinning this flax. This hardly differs from the foregoing drawings in any thing but the twist that is given it after the last stretching in

its length. This is much greater than any of the preceding, being intended to give the yarn hardness and firmness, so that it will now break rather than stretch any more.

The reader, moderately acquainted with mechanics, cannot but perceive that each of the operations now described, by which the roove is changed into the soft flax, and each of these into one slenderer and somewhat firmer, by alternately teasing out and twining the soft cord, is a substitute for a single pull of the finger and thumb of the spinner, which it accommodates precisely to the peculiar condition of the lock of wool which she touches at the moment. She can follow this through all its irregularities; and perhaps no two succeeding plucks are alike. But when we cannot give this momentary attention to every minute portion, we must be careful to introduce the roove in a state of perfect uniformity; and then every inch being treated in the same manner, the final result will be equable—the yarn will be uniform.

We are now to describe the mechanism by which all this is effected. But we do not mean to describe a cotton mill; we only mean to describe what comes into immediate contact with the thread; and in so doing, to confine ourselves to what is necessary for making the reader perceive its ability to perform the required task. We see many cases where individuals can apply this knowledge to useful purposes. More than this would, we think, be improper, in a national point of view.

Let ABC represent the section of a roller, whose pivot D does not turn in a pivot hole, but in the bottom of a long narrow notch DE, cut in an iron stand. *abc* is the section of another iron roller, whose pivot *d* is in the same notches at each end, while the roller itself lies or rests on the roller ABC below it. The surfaces of these rollers are fluted lengthwise like a column; only the flutings are very small and sharp, like deep strokes of engraving very close together. It is plain, that if the roller ABC be made to turn slowly round its axis by machinery, in the direction ABC (as expressed by the dart), the roughness of the flutings will take hold of the similar roughness of the upper roller *abc*, and carry it round also in the direction of the dart, while its pivots are engaged in the notches DE, which they cannot quit. If therefore we introduce the end F of the cotton string or riband, formed by the carding machine, it will be pulled in by this motion, and will be delivered out on the other side at H, considerably compressed by the weight of the upper roller, which is of iron, and is also pressed down by a lever which rests on its pivots, or other proper places, and is loaded with a weight. There is nothing to hinder this motion of the riband thus compressed between the rollers, and it will therefore be drawn through from the cans. The compressed part at H would hang down, and be piled up on the floor as it is drawn through; but it is not permitted to hang down in this manner, but is brought to another pair of sharp fluted iron rollers K and L. Supposing this pair of rollers to be of the same diameter, and to turn round in the same time, and in the same direction, with the rollers ABC, *abc*; it is plain that K and L drag in the compressed riband at I, and would deliver it on the other side at M, still more compressed. But the roller K is made (by the wheelwork) to turn round more swiftly than

Spinning.

Plate
CCCCXCLX

than ABC. The difference of velocity at the surface of the rollers is, however, very small, seldom exceeding one part in 12 or 15. But the consequence of this difference is, that the skin of cotton H1 will be lengthened in the same proportion; for the upper rollers pressing on the under ones with a considerable force, their sharp flutings take good hold of the cotton between them; and since K and L take up the cotton faster than ABC and *abc* deliver it out, it must either be forcibly pulled through between the first rollers, or it must be stretched a little by the fibres slipping among each other, or it must break. When the extension is so very moderate as we have just now said, the only effect of it is merely to begin to draw the fibres (which at present are lying in every possible direction) into a more favourable position for the subsequent extensions.

The fibres being thus drawn together into a more favourable position, the cotton is introduced between a third pair of rollers O, P, constructed in the same way, but so moved by the wheelwork that the surface of O moves nearly or fully twice as fast as the surface of K. The roller P being also well loaded, they take a firm hold of the cotton, and the part between K and O is nearly or fully doubled in its length, and now requires a little twining to make it roundish, and to consolidate it a little.

It is therefore led sloping downwards into a hole or eye in the upper pivot of the first fly, called a *jack*. This turns round an upright axis or spindle; the lower end of which has a pulley on it to give it motion by means of a band or belt, which passes round a drum that is turned by the machinery. This jack is of a very ingenious and complicated construction. It is a substitute for the fly of the common spinning wheel. If made precisely in the form of that fly, the thread, being so very bulky and spongy, and unable to bear close packing on the bobin, would frang out by the whirling of the fly, and would never coil up. The bobin therefore is made to lie horizontally; and this occasions the complication, by the difficulty of giving it a motion round a horizontal axis, in order to coil up the twisted rove. Mr Arkwright has accomplished this in a very ingenious manner; the essential circumstances of which we shall here briefly describe. A is a roller of hard wood, having its surface cut into sharp flutes longitudinally. On the axis, which projects through the side of the general frame, there is a pulley P, connected by a band with another pulley Q, turning with the horizontal axis QR. This axis is made to turn by a contrivance which is different in every different cotton mill. The simplest of all is to place above the pulley C (which is turned by the great band of the machinery, and thus gives motion to the jack), a thin circular disc D, loose upon the axis, so as to turn round on it without obstruction. If this disc exceed the pulley in breadth about $\frac{1}{4}$ of an inch, the broad belt which turns the pulley will also turn it; but as its diameter is greater than that of the pulley, it will turn somewhat slower, and will therefore have a relative motion with respect to the axis QR. This can be employed, in order to give that axis a very slow motion, such as one turn of it for 20 or 30 of the jack. This we leave to the ingenuity of the reader. The bobin B, on which the rove is to be coiled up, lies on this roller, its pivots passing through upright bits in the sides of the general

frame. It lies on A, and is moved round by it, in the same manner as the uppermost of a pair of drawing rollers lies on the under one, and receives motion from it. It is evident that the fluted surface of A, by turning slowly round, and carrying the weight of the bobin, compresses a little the cotton that is between them; and its flutings, being sharp, take a slight hold of it, and cause it to turn round also, and thus coil up the rove, pulling it in through the hole E in the upper pivot (which resembles the fore pivot or eye of a spinning wheel fly) in so gentle a manner as to yield whenever the notion of the bobin is too great for the speed with which the cotton skin is discharged by the rollers: O and P—N. B. The axis QR below, also gives motion to a guide within the jack, which leads the rove gradually from one end of the bobin to the other, and back again, so as to coil it with regularity till the bobin is full. The whole of this internal mechanism of the jack is commonly shut up in a tin cylinder. This is particularly necessary when the whirling motion must be rapid, as in the second and third drawings. If open, the jacks would meet with much resistance from the air, which would load the mill with a great deal of useless work.

The reader is desired now to return to the beginning of the process, and to consider it attentively in its different stages. We apprehend that the description is sufficiently perspicuous to make him perceive the efficacy of the mechanism to execute all that is wanted, and prepare a slab that is uniform, soft, and still very extensible; in short, fit for undergoing the last treatment, by which it is made a fine and firm yarn.

As this part of the process differs from each of the former, merely by the degree of twist that is given to the yarn, and as this is given by means of a fly, not materially different from that of the spinning wheel for flax, we do not think it at all necessary to say any thing more about it.

The intelligent reader is surely sensible that the yarn produced in this way must be exceedingly uniform. The uniformity really produced even exceeds all expectation; for even although there be some small inequalities in the carded fleece, yet if these are not matted clots, which the card could not equalise, and only consist of a little more thickness of cotton in some places than in others, when such a piece of the stripe comes to the first roller, it will be rather more stretched by the second, and again by the bobin, after the first very slight twining. That this may be done with greater certainty, the weights of the first roving rollers are made very small, so that the middle part of the skin can be drawn through, while the outer parts remain full ball.

It is said that a pound of the finest Boulton cotton has been spun into a yarn extending a few yards beyond 110 miles!

These contrivances have in some parts of Scotland been applied to the spinning of flax.

SPINNING WHEEL. A very considerable improvement has been made by Mr Antis of Fulneck near Leeds of the common spinning wheel. It is well known, that hitherto much time has been lost by stopping the wheel in order to shift the thread from one stop on the fly to another; but in Mr Antis's wheel the bobbin is made to move backwards and forwards, so as to prevent the necessity of this perpetual interruption, as well as to ob-

viates the danger of breaking the thread and losing the end. This is effected by the axis of the great wheel being extended through the pillar next the pinner, and formed into a pinion of one leaf A, which takes into a wheel B, seven inches diameter, having on its periphery 97 teeth; so that 97 revolutions of the great wheel cause one of the lesser wheel. On this lesser wheel is fixed a ring of wire *cccj*, which, being supported on six legs, stands obliquely to the wheel itself, touching it at one part, and projecting nearly three quarters of an inch at the opposite one: near the side of this wheel is an upright lever C, about 15 inches long, moving on a centre, three inches from its lower extremity, and connected at the top to a sliding bar D; from which rises an upright piece of brass E, which working in the notch of a pulley drives the bobin F backward and forward, according as the oblique wire forces a pin G in or out, as the wheel moves round. To regulate and assist the alternate motion, a weight H hangs by a line to the sliding bar, and passing over a pulley I rises and falls as the bobin advances or recedes, and tends constantly to keep the pin in contact with the wire. It is evident, from this description, that one staple only is wanted to the flyer; which, being placed near the extremity K, the thread passing through it is by the motion of the bobin laid regularly thereon. For this invention the Society instituted at London for the Encouragement of Arts, &c. gave the author a premium of twenty guineas.

SPINOSUS CAMELIS, in *Botany*, a stem covered with strong woody prickles, whose roots are not superficial, but proceeding from the body of the stem. When applied to a leaf, *Spinosum folium*, it indicates the margin running out into rigid points or prickles, *quod margine exit in acumina duriora, rigida, pungentia*.

SPINOUS, in *botany*. See **SPINOSUS**.

SPINUS Fibra, such as have some of the rays of the back fins running out into thorns or prickles, as the perch, &c.

SPINOZA, BENEDICT, was born at Amsterdam the 24th November 1632. His father was a Jew of Portugal, by profession a merchant. After being taught Latin by a physician, he applied himself for many years to the study of theology, and afterwards devoted himself entirely to philosophy. He began very early to be dissatisfied with the Jewish religion; and as his temper was open, he did not conceal his doubts from the synagogue. The Jews, it is said, offered to tolerate his infidelity, and even promised him a pension of a thousand dollars per annum, if he would remain in their society, and continue outwardly to practise their ceremonies. But if this offer was really made, he rejected it, perhaps from his aversion to hypocrisy, or rather because he could not endure the restraint which it would have imposed. He also refused being constituted heir to an independent fortune, to the prejudice of the natural claimants; and he learned the art of polishing glass for spectacles, that he might subsist independently of every one.

He would probably have continued in the synagogue for some time longer, had it not been for an accident. As he was returning home one evening from the theatre, he was stabbed by a Jew: the wound was slight; but the attempt naturally led Spinoza to conclude that the Jews had formed the design of assassinating him. After leaving the synagogue, he became a Christian,

and frequented the churches of the Lutherans and Calvinists. He now devoted himself more than ever to his favourite philosophical speculations; and finding himself frequently interrupted by the visits of his friends, he left Amsterdam, and settled at the Hague, where he often continued for three months together without ever stirring from his lodging. During his residence in that city, his hostess, who was a Lutheran, asked him one day if he could be saved while he continued in her religion? "Yes (replied Spinoza), provided you join to your religion a peaceable and virtuous life." From this answer it has been concluded that he was a Christian in appearance only, while in reality he regarded all religions as indifferent. But this conclusion would be too severe, even if the woman had been a Mahometan. His *Traactatus Theologico-politicus*, which was published about that time, is a better proof of his sincerity than a thousand such conclusions; for this book contains all those doctrines in embryo which were afterwards unfolded in his *Opera Postuma*, and which are generally considered as a system of atheism.

His fame, which had now spread far and wide, obliged him sometimes to interrupt his philosophical reveries. Learned men visited him from all quarters. While the prince of Conde commanded the French army in Utrecht, he intreated Spinoza to visit him; and though he was absent when the philosopher arrived, he returned immediately, and spent a considerable time with him in conversation. The elector Palatine offered to make Spinoza professor of philosophy at Heidelberg; which, however, he declined.

He died of a consumption at the Hague on the 21st February 1677, at the age of 45. His life was a perpetual contradiction to his opinions. He was temperate, liberal, and remarkably disinterested; he was sociable, affable, and friendly. His conversation was agreeable and instructive, and never deviated from the strictest propriety.

The only edition of the works of Spinoza that we have seen is in two volumes small 4to; the former of which was printed at Hamburg in the year 1670, and the latter we know not where, in 1677, a few months after his death. In the *Traactatus Theologico-politicus*, already mentioned, he treats of *prophecy and prophets*; and of the *call of the Hebrews*, whom he affirms to have been distinguished from other nations only by the admirable form of their government, and the strictness of their laws for long preserving their political state. He is likewise of opinion, or at least pretends to be so, that God may, in what we call a *supernatural way*, give political institutes to other nations as well as to the Hebrews, who were, he says, at no time a peculiar people to the Supreme Lord of heaven and earth; for according to him, all history, sacred and profane, testifies that every nation was blessed with the light of prophecy. That light indeed, if his notions of it be just, was of very little value. He labours to prove, that the prophets were distinguished from other men only by their piety and virtue; that their revelations depended wholly on their imaginations and the dispositions of their minds; that they were often grossly ignorant and highly prejudiced; that the speculative opinions of one prophet are seldom in unison with those of another; and that their writings are valuable to us only for the excellent rules which he acknowledges they contain respecting the practice

Spinoza. tice of piety and virtue. He then proceeds to treat of the divine law and of miracles; and endeavours to prove that no miracle, in the proper sense of the word, can have been at any time performed; because every thing happens by a necessity of nature, the result of the divine decrees, which are from all eternity necessary themselves. He acknowledges, that in the Scriptures, which he professes to admit as true history, miracles are often mentioned; but he says that they were only singular events which the sacred historians *imagined* to be miraculous: and he then gives some very extraordinary rules for interpreting the books of the Old and New Testaments where they treat of miracles, or appear to foretel future events. See our articles MIRACLE and PROPHECY.

Having thus divested the Scriptures of every thing characteristic of a revelation from heaven, he next calls in question their authenticity. He affirms, in contradiction to the clearest internal evidence, that the Pentateuch and all the other historical books must have been written by one man; and that man, he thinks, could not have flourished at a period earlier than that of Ezra. The grounds of this opinion are unworthy of the talents of Spinoza; for that he had talents is incontrovertible. His principal objection to the authenticity of the Pentateuch is, that Moses is made to speak of himself in the third person, and to talk of the Canaanites being then in the land; and because he finds in his writings, as well as in the books of Joshua, Judges, Ruth, Samuel, &c. places designed by names which he supposes they had not in the early ages of which these books contain the history, he concludes that these writings must be one compilation from ancient records made at a very late period; more especially as the author often speaks of things of great antiquity remaining to this day. The books of Esther, Ezra, Nehemiah, and Chronicles, must have been compiled, he thinks, under the Maccabees; and he seems to consider as of equal value with them the story of Tobit, and the other two apocryphal treatises intitled the Wisdom of Solomon and Ecclesiasticus.

These senseless cavils, worthy only of one of those modern free-thinkers whose learning, in the opinion of Bishop Warburton, is not sufficient to carry them even to the confines of rational doubt, we have sufficiently obviated in another place (see SCRIPTURE, N^o 8—31.) Spinoza urges them against the other books of the Old Testament. The prophecies of Isaiah, Jeremiah, Ezekiel, Daniel, Hosea, and Jonah, are, as we have them, only fragments, he says, of the writings of those men compiled by the Pharisees under the second temple from ancient and voluminous records.

In the midst of this dogmatical scepticism, if we may use such a phrase, he bears such a testimony to the last chapters of the book of Daniel, as we should not have looked for in the writings either of a Jew or of a Deist. After detailing the various hypotheses which in his time were held respecting the author and the intention of the book of *Job*; in which, he says, MOWS is called SATAN, he proceeds in these words: "Transeo ad Danielis librum; hic sine dubio est cap. 8. ipius Danielis scripta continet. Undenam autem priora septem capitula descripta fuerint, nescio;" thus admitting the famous prophecy of the seventy weeks. The canon of the Old Testament, he says, was finally settled by rab-

bins of the Pharisaical sect, who wished to exclude from it the books of *Proverbs*, *Ecclesiastes*, and *Ezekiel*, as they had actually excluded others of equal value; but the three books in question were inserted by the influence of two of the rabbis of greater wisdom and integrity than the rest.

That so paradoxical a writer, who had been originally a Jew, and was now almost a Deist, should have treated the New Testament with as little ceremony as the Old, will not surprize the intelligent reader. He begins his remarks, however, with affirming, that no man can peruse the Christian Scriptures, and not acknowledge the apostles to have been prophets; but he thinks that their mode of prophesying was altogether different from that which prevailed under the Mosaic dispensation; and that the gift, whatever it was, was, forsooth them the instant that they left off *preaching*, as their *writings* have to him every appearance of human compositions. This distinction between Christian and Jewish prophecy is the more wonderful, that he founds it principally on the dissimilarity of *style* visible in the writings of the Old and New Testaments; though, in his second chapter, which treats of the works of the Jewish prophets, he says expressly, "Stylus deinde prophetie pro eloquentia cuiusque prophete variabat, prophetie enim Ezekielis et Amos non sunt, ut ille Eliae, Nachumi, eleganti, sed rudiore stylo scriptae." That the Hebrew scholar may be convinced of the truth of this remark, he recommends to him to study diligently the writings of these prophets, and to consider the occasions on which their prophecies were uttered: "Quae si omnia recte perpenditur (says he) facile ostendunt, Deum nullum, habere stylum peculiarem dicendi, sed tantum pro eruditione, et capacitate prophetae extensus esse elegantem, compendiosum, severum, rudem, prolixum, et obscurum." Another objection brought by Spinoza against the prophecies of the New Testament arises from the authors of them having been at all times masters of themselves. This, says he, was peculiarly the case of St Paul, who often confirms his doctrine by *reasoning*, which the Jewish prophets never condescended to do, as it would have submitted their dogmas to the examination of *private judgment*. Yet, with singular inconsistency, he affirms, that the Jewish prophets could not know that the impressions made on their imaginations proceeded from God, but by a sign given them, which by their own *reason* or *judgment* they knew would never be vouchsafed to an impious or a wicked man.

After these very free remarks on the Scriptures of the Old and New Testaments, he naturally enough expresses a suspicion, that by those who consider the Bible as the epistle of God sent from heaven to men, he will be thought to have aimed against the Holy Ghost by vilifying his dictates. This leads him to inquire in what sense the Scriptures are the word of God; and he gravely determines them to be so only as they *actually* contribute to make men more virtuous and holy. It is not enough that they are *calculated* to improve virtue and holiness: for should the words of the languages in which they are written acquire in process of time a signification different from what they had originally; should mankind lose all knowledge of these languages; or even should they agree to neglect the books, whether from ignorance or from wilfulness—those books would create

Spinoza.

to be the word of God, and become nothing better than waste paper and ink; just as the two tables, which Moses broke on observing the idolatry of his countrymen, were not the covenant between Jehovah and the Israelites, but merely two pieces of stone! The Scriptures, however, are the word of God, because they teach the true religion of which God is the author; and they have taught it in such a manner, he says, that it can never be lost or corrupted whatever become of the books of the Old and New Testaments, or of the languages in which they are written. The whole of religion, as the Scriptures themselves testify, consists in the love of God above all things, and of our neighbours as ourselves: whence it follows, that we must believe that God exists, and watcheth over all things by his providence; that he is omnipotent, and has decreed the pious to be ultimately happy, and the impious miserable; and that our final salvation depends solely on His grace or favour. These truths, with their necessary consequences, are the word of God: they are clearly taught in the Scriptures, and can never be corrupted; but every thing else in these volumes is vain, he says, and of no greater importance to us than facts related in any other ancient and authentic history.

Such are the opinions which were entertained of revelation by a man, whom a critic, writing in a Christian country, and professing to be a zealous Christian himself, has lately pronounced to have been a *chosen vessel*. For what purpose he was *chosen* it is not easy to conceive. His religion, as it appears in the *Traclatus*, is the worst kind of Deism; and his politics are such as our monthly critics are not wont to teach, and such as we trust shall never be seriously taught by any British subject. By the law of nature, he says, every man before the formation of civil government has an unquestionable right to whatever appears eligible either to his reason or to his appetites; and may get possession of it by *intraty*, by *violence*, by *fraud*, or by any other means attended with less trouble to himself (*sive vi, sive dolo, sive precibus, sive quocunque demum modo factus poterit*); and may treat as an enemy every person who shall attempt to obstruct his purpose. But when men agree to devolve this right upon others, and to constitute a political state, which both reason and appetite must persuade them to do, then are they in duty bound to obey every mandate of the government, however absurd it may be (*omnia mandata tamen a summo sunt*), as long as that government can enforce its edicts, and no longer; for, according to him, right and power are so inseparably united, that when a government loses its power, it has no longer the smallest claim to obedience. This doctrine, he says, is most *obviously* just when taught of democratical governments; but it is in fact equally true of monarchies and aristocracies: * Non quisquis summam habet potestatem, sive unus sit, sive pauci, sive denique omnes, certum est eis summam jus quicquid velit imperandi, competere: et præterea quisquis potestatem se defendendi, sive sponte, sive vi caeteris, in alium transfudit, cum suo jure naturali plane cessisse, et consequenter eum in ad omnia absolute parere decrevisse quod omnia præ late tenetur, quamvis rex, sive nobiles, sive populus summam, quam acceperunt, potestatem, que juris transferendi fundamentum fuit, conservat; nec his plura addere opus est.* We heartily agree with him,

that to this precious conclusion it is needless to add a Spinoza's single word.

Taking our leave therefore of his *Traclatus Theologico-politicus*, we shall now give our readers a short account of his *Opera Postuma*. These consist of, 1. ETHICA, more geometrico demonstrata; 2. POLITICA; 3. DE EMENDATIONE INTELLECTUS; 4. EPISTOLÆ, et ad eas RESPONSIONES; 5. COMPENDIUM GRAMMATICÆ LINGUÆ HEBRÆÆ.

The ETHICA are divided into five parts, which treat in order, de DEO; de natura et origine MENTIS; de origine et natura AFFECTUUM; de SERVITUTE humana, seu de AFFECTU VIRIBUS; de POTENTIA INTELLECTUS, seu de LIBERTATE humana. As the author professes to tread in the footsteps of the geometers, and to deduce all his conclusions by rigid demonstration from a few self-evident truths, he introduces his work, after the manner of Euclid, with a collection of definitions and axioms. These are couched in terms generally ambiguous; and therefore the reader will do well to consider attentively in what sense, if in any, they can be admitted; for it will not be found easy to grant his premises, and at the same time refuse his conclusions. His definition of substance, for instance, is so expressed as to admit of two senses; in one of which it is just, whilst in the other it is the parent of the most impious absurdity. We shall give it in his own words: "Per substantiam intelligi id, quod in se est, et per se concipitur: hoc est id, cujus conceptus non indiget conceptu alterius rei, à quo formari debeat." If by this be meant, that a substance is that which we can conceive by itself without attending to any thing else, or thinking of its formation, the definition, we believe, will be admitted by every reflecting mind as sufficiently distinguishing the thing defined from an attribute, which, he says, is that which we perceive of a substance, and which we certainly cannot conceive as existing by itself. Thus the writer of this article can shut his eyes and contemplate in idea the small 4to volume now before him, without attending to any thing else, or thinking of its paradoxical author, or even of the Great Being who created the matter both of him and of it; but he cannot for an instant contemplate the yellow colour of its vellum boards without thinking of triple extension, or, in other words, of body. The book therefore is a substance, because conceivable by itself; the colour is an attribute or quality, because it cannot be conceived by itself, but necessarily leads to the conception of something else. But if Spinoza's meaning be, that nothing is a substance but what is conceived as existing from eternity, independent of every thing as a cause, his definition cannot be admitted; for every man conceives that which in himself thinks, and wills, and is conscious, as a substance; at the same time that he has the best evidence possible that he existed not as a conscious, thinking, and active being, from eternity.

His fourth axiom is thus expressed: "Effectus cognitionis à cognitione cause dependet, et eandem involvit;" and his fifth, "Quæ nihil commune cum se invicem habent, etiam per se invicem intelligi non possunt, sive conceptus unius alterius conceptum non involvit." The former of these propositions, so far from being self-evident, is not even true; and the latter is capable of two senses very different from each other. That every effect

* Traclatus, p. 116.

Spinoz. feñt proceeds from a *caufe*, is indeed an axiom; but surely we may know the effect accurately, though we be ignorant of the particular cause from which it proceeds (see PHILOSOPHY, N^o 36; and PHYSICS, N^o 91, &c.); nor does the knowledge of the one by any means involve the knowledge of the other. If different things have nothing in common, it is indeed true that the knowledge of one of them will not give us an adequate conception of the other; but it will in many cases compel us to believe, that the other exists or has existed. A parcel of gunpowder lying at rest has nothing in common with the velocity of a cannon-ball; yet when we know that a ball has been driven with velocity from a cannon, we infer with certainty that there has been a parcel of powder at rest in the chamber of that cannon.

It is upon such ambiguous definitions and axioms as these that Spinoza has raised his pretended demonstrations, that one substance cannot produce another; that every substance must necessarily be infinite; that no substance exists or can be conceived besides God; and that extended substance or body is one of the infinite attributes of God. We shall not waste our own time or the readers with a formal confutation of these impious absurdities. We treat they are sufficiently confuted in other articles of this work (see METAPHYSICS, Part III. PROVIDENCE, and THEOLOGY, Part I.); and whoever wishes for a more particular examination of the author's principles, may find it in Dr. Clarke's Demonstration of the Being and Attributes of God. The truth, however, is, that no man will need the assistance of that eminent metaphysician to discover the fallacy of the reasoning by which they are attempted to be proved, if he affix any one precise meaning to the definitions and axioms, and adhere to that meaning steadily through the whole process of the pretended demonstrations.

By way of apology for this jargon, it has been lately said, that "Spinoza takes the word *substance* in its most simple and perfect sense; which is necessary, as he writes mathematically, and proposes a simple idea as the foundation of his theory. What is the proper signification of a substance? Is it not that which stands alone, which has the cause of its existence within itself? I wish that this simple meaning of the word could be universally admitted in philosophy. Strictly speaking, no worldly thing is a substance; since all mutually depend on each other, and finally on God, who, in this exalted sense, is the only substance. The word *modification* sounds harsh and improper, and therefore it cannot be expected to gain a place in philosophy; but if the school of Leibnitz may term matter the *appearance of substances*, why may not Spinoza be allowed a better term? Worldly substances are kept in union by divine power, as it was by divine power that they had existence. They represent also, if you please, modified appearances of divine power; each according to the station, the time, and the organs, in and with which it appears. The

phrase used by Spinoza is concise, and it gives an unity and simplicity to his whole system, however strange it may found in our ears."

From this account of Spinozism, one who had never looked into the works of the author would be led to suppose that his system is the same with that of Berkeley; which, denying the existence of material substance, attributes all our perceptions of what we call the qualities of body to the immediate agency of the Deity on our minds (see METAPHYSICS, Part II. chap. 3.). But Spinoza's doctrine is very different. According to him, bodies are either attributes or affections of God; and as he says there is but one extended substance, he affirms that substance to be indivisible, and employs a long scholium to prove that those are mistaken who suppose it finite and not essential to the Deity. That we do not misrepresent his sentiments, the learned reader will be convinced by the two following definitions, with which he introduces that part of his ethics which treats of the nature and origin of mind. 1. "Per corpus intelligo modum, qui Dei essentiam, quantum, ut res extensa consideratur, certo et determinato modo exprimit." 2. "Ad essentiam alicujus rei id pertinere dico, quo dato res necessario ponitur, et quo sublato res necessario tollitur; vel id, sine quo res, et vice versa quod sine re nec esse nec concipi potest."

In conformity with these definitions, he attempts to prove that God is an extended as well as a thinking substance; that as a thinking substance he is the cause of the idea of a circle, and as an extended substance or the circle itself; and that the minds of men are not substances, but certain modifications of the divine attributes; or, as he sometimes expresses it, "Quod humanæ mentis actualis constituit, est idea rei singularis actu existentis." Hence, he says, it follows that the human mind is a part of the intellect of the infinite God; so that when we speak of the human mind perceiving this or that, we can only mean that God, not as he is infinite, but as he appears in the human mind or constitutes its essence, has this or that idea; and when we speak of God's having this or that idea, we must conceive of Him not only as constituting the human mind, but as, together with it, having the idea of something else (A). In another place he tells us, that the human mind is nothing but the idea which God has of the human body as actually existing; that this idea of the body, and the body itself, are one and the same thing; and that thinking and extended substances are in reality but one and the same substance, which is sometimes comprehended under one attribute of the Deity, and sometimes under another.

If this impious jargon be not Atheism, or as it has been sometimes called Pantheism, we know not what it is (See PANTHEISM). According to Spinoza, there is but one substance, which is extended, infinite, and indivisible. That substance indeed he calls God; but he labours to prove that it is corporeal; that there is no difference between mind and matter; that both are attributes

(A) Hinc sequitur mentem humanam partem esse infiniti intellectus Dei; ac prout cum dicimus, mentem humanam hoc vel illud percipere, nihil aliud dicimus quam quod Deus, non quantum infinitus est, sed quantum per naturam humanæ mentis explicatur, sive quantum humanæ mentis essentiam constituit, hæc vel illam habere. Et cum dicimus Deum hanc vel illam ideam habere, non tantum, quantum naturam humanæ mentis constituit; sed quantum simul cum mente humana alterius rei etiam habet ideam. (Ethic. prop. vi. part. 2.)

Spinoza.

tributes of the Deity variously considered; that the human soul is a part of the intellect of God; that the same soul is nothing but the idea of the human body; that this idea of the body, and the body itself, are one and the same thing; that God could not exist, or be conceived, were the visible universe annihilated; and therefore that the visible universe is either the one substance, or at least an essential attribute or modification of that substance. He sometimes indeed speaks of the power of this substance; but when he comes to explain himself, we find that by power he means nothing but blind necessity; and though he frequently talks of the wisdom of God, he seems to make use of the word without meaning. This we think evident from the long appendix to his 26th proposition; in which he labours to prove that the notion of final causes is an idle figment of the imagination, since, according to him, nothing but the prejudices of education could have led men to fancy that there is any real distinction between good and evil, merit and demerit, praise and reproach, order and confusion; that eyes were given them that they might be enabled to see; teeth for the purpose of chewing their food; herbs and animals for the matter of that food; that the sun was formed to give light, or the ocean to nourish fishes. If this be true, it is impossible to discover wisdom in the operations of his one substance; since, in common apprehension, it is the very characteristic of folly to act without any end in view.

Such are the reveries of that writer, whose works a German philosopher of some name has lately recommended to the public, as calculated to convey to the mind more just and sublime conceptions of God than are to be found in most other systems. The recommendation has had its effect. A literary journal of our own, reviewing the volume in which it is given, feels a peculiar satisfaction from the discovery, that Spinoza, instead of a formidable enemy to the cause of virtue and religion, was indeed their warmest friend; and piously hopes that we shall become more cautious not to suffer ourselves to be deceived by empty names, which those who cannot reason (Sir Isaac Newton and Dr Clarke perhaps) give to those who can (Hobbes, we suppose, and Spinoza). But though we have the honour to think on this question with our illustrious countrymen, we have no desire to depict Spinoza as a reprobate, which the critic says has often been done by ignorance and enthusiasm. We admit that his conduct in active life was irreproachable; and for his speculative opinions, he must stand or fall to his own Master. His Ethics appear to us indeed a system shockingly impious; and in the tract intitled POLITICA, power and right are confounded as in the former volume; but in the treatise DE INTELLECTUS EMENDATIONE, are scattered many precepts of practical wisdom, as well as some judicious rules for conducting philosophical investigation; and we only regret, that the reader must wade to them through pages of fatalism, scepticism, and palpable contradictions. His *Compendium Grammatices Linguae Hebraeae*, though less imperfect, appears to have so much merit, that it is to be wished he had fulfilled his intention of writing a philosophical grammar of that language, instead of wasting his time on abstruse speculations, which though they seem not to have been injurious to his own virtue, are certainly not calculated to promote the vir-

tue of others, or to increase the sum of human happiness.

SPIRÆA, a genus of plants belonging to the class of icolandra, and to the order of pentagynia; and in the natural system arranged under the 26th order, *Pomaceae*. See BOTANY Index.

SPIRAL, in *Geometry*, a curve line of the circular kind, which in its progress recedes from its centre.

SPIRE, in *Architecture*, was used by the ancients for the base of a column, and sometimes for the stragal or tore; but among the moderns it denotes a steeple that continually diminishes as it ascends, whether conically or pyramidally.

SPIRIT, in *Metaphysics*, an incorporeal being or intelligence; in which sense God is said to be a spirit, as are angels and the human soul. See METAPHYSICS, Part III.

SPIRIT, in *Chemistry and Pharmacy*, a name applied to every volatile liquid which is not insipid like phlegm or water; and hence the distinction into acid, alkaline, and vinous spirits.

SPIRIT OF WINE. See ALCOHOL, CHEMISTRY Index; DISTILLATION, and MATERIA MEDICA Index.

SPIRITS, or ANIMAL SPIRITS. See ANATOMY, Part V. n^o 136.

SPIRITUAL, in general, something belonging to or partaking of the nature of spirit. See SPIRIT.

SPIRITUOUS LIQUORS have in all nations been considered as a proper subject of heavy taxation for the support of the state. This has naturally occasioned a nice examination of their strength. It having been at last found that this was intimately connected with the specific gravity, this has been examined with the most scrupulous attention to every circumstance which could affect it, so that the duties might be exactly proportioned to the quantity of spirit in any strong liquor, independent on every other circumstance of flavour or taste, or other valued quality. The chemist at last found that the basis of all strong liquors is the same, produced by the vinous fermentation of pure saccharine matter dissolved in water. He also found, that whether this vegetable salt be taken as it is spontaneously formed in the juices of plants and fruits, or as it may be formed or extracted from farinaceous fruits and roots by a certain part of the process of vegetation, it produces the same ardent spirit, which has always the same density in every mixture with water. The minute portions of aromatic oils, which are in some degree inseparable from it, and give it a different flavour according to the substance from which it was obtained, are not found to have any sensible effect on its density or specific gravity. This seems very completely established in consequence of the unwearied attempts of the manufacturers to lessen the duties payable on their goods by mixtures of other substances, which would increase their density without making them less palatable. The vigilance of the revenue officers was no less employed to detect every such contrivance. In short, it is now an acknowledged point, that the specific gravity is an accurate test of the strength.

But though this is true in general, we cannot derive much benefit from it, unless we know the precise relation between the strength and the density of a spirituous liquor. Do they increase *pari passu*, or by what law

* Prop.
xxxiii.
Part 4.

Spinoza
li
Spirituosus.

Spirituous law are they connected? It was natural to expect that equal additions of aident spirits or alcohol to a given quantity of water would produce equal diminutions of density. Arometers were accordingly made on this principle above 200 years ago, as may be seen in the works of Gaspar Scheuter, Sturmius, Agricola, and other old authors. But when mathematical physics became more generally known, this was easily discovered to be erroneous; and it was shown (we think first by Mr Boyle) that equal additions to the specific gravity would be produced by successively taking out of any vessel a certain measure of alcohol and replacing it with an equal measure of water. This was the most convenient discovery for all parties, because then the duties payable on a cask of spirits would be in the exact proportion of the diminution of its density. But it was soon found by those who were appointed guardians of the revenue that this conclusion was erroneous, and that a mixture which appeared by this rule to contain 35 gallons of alcohol, did really contain 351. This they found by actually making such a mixture: 18 gallons of alcohol mixed with 18 of water produced only 35 gallons of spirits. The revenue officers, finding that this condensation was most remarkable in mixtures of equal parts of water and the strongest spirits which could then be procured, determined to levy the duties by this mixture; because, whether the spirituous liquor was stronger or weaker than this, it would appear, by its specific gravity, rather stronger than it really was. This sagacious observation, and the simplicity of the composition, which could at all times be made for comparison, seem to be the reasons for our excise officers selecting this mode of estimating the strength and levying the duties. A mixture of nearly equal measures of water and alcohol is called **PROOF SPIRIT**, and pays a certain duty per gallon; and the strength of a spirituous liquor is estimated by the gallons, not of alcohol, but of proof spirit which the cask contains. But because it might be difficult to procure at all times this proof spirit for comparison, such a mixture was made by order of the board of excise: and it was found, that when six gallons

of it was mixed with one gallon of water, a wine gal-
Spirituous lon of the mixture weighed 7 pounds 13 ounces avoirdupois. The board therefore declared, that the spirituous liquor of which the gallon weighed 7 pounds 13 ounces should be reckoned 1 to 6 or 1 in 7 under proof. This is but an awkward and complex formula; and it was in order to suit matters to a mode of examination which had by time obtained the sanction of the board. Mr Clarke, an ingenious artist of that time, had made a hydrometer incomparably more exact than any other, and constructed on mathematical principles fit for computation. This had a few weights corresponding to the additions of water or proof spirit, and the mixture 1 to 6 or 1 in 7 was the only one which weighed an exact number of ounces per gallon without a fraction.

Thus stands the excise law; and Clarke's hydrometer is still the instrument of authority, although others have been since constructed by DICAS, QUIN, and others, which are much more ingenious and convenient. The mathematician who examines Dicax's hydrometer, with its sliding scale, by which it is adjusted to the different temperatures, and points out the condensations, will perceive a beautiful and ingenious combination of quantities, which he will find it difficult to bring under any analytical formula. Perhaps Quin's may have some pretence in respect of convenience; but *facile inventus est error*. Mr Dicax's was original (A).

As naturalists became more accustomed to exact observations in every topic of inquiry, the condensation which obtains in the mixture of different substances became more familiarly known. This evidently affects the present question; and both the excise and the distillers are interested in its accurate decision. This occasioned an application to the Royal Society; and a most scrupulous examination of the strength of spirituous liquors was made by Sir Charles Blagden and Mr Gilpin, of which they have given a very particular account in the Philosophical Transactions for 1799 and 1792.

We have taken notice of this in the article **SPIRITIC GALLERY**, mentioning such circumstances of the results as suited our purposes of physical discussion. At present

(A) Among the various contrivances which have been thought of, among manufacturers and dealers, as well as for the purposes of revenue, for ascertaining the specific gravity, and consequently the real strength and value of high-siced and light-siced liquors, we are persuaded there is none equal, in point of accuracy, simplicity, and facility of application, to the arithmetical heads lately announced to the public by Messrs Levi of Edinburgh, under the privilege of a patent: and with this persuasion we have no hesitations in recommending them to those to whom the use of a simple and accurate instrument is of great importance in determining the value of high-siced spirituous liquors. Our recommendation rests not solely on our own opinion, but is supported by that of others who are well acquainted with such judgments. We know, too, that the heads have been examined and compared by several intelligent manufacturers and dealers with some of the most accurate hydrometrical instruments, and after a fair trial, a decided preference has been given to the heads. The whole apparatus consists of 30 heads, a sliding rule, a thermometer, a glass jar and brass hook, which are packed in a neat small box; and it is accompanied with directions, which point out, 1. In what manner the real strength of spirits may be ascertained at any given temperature between 40° and 60°. 2. How much per cent. the spirit to be tried is over or under proof according to the practice of spirit dealers; and, 3. The proportion of water and the strongest spirits or alcohol, according to the views and language of excisemen. The advantages of these heads are, that being made of a substance which is little acted on by the acids and oils, they are less liable to be injured by use, than instruments composed of metal; and when a head happens to be broken, it can be easily replaced. They possess this further advantage, that with the application of the thermometer, and the regulation of the sliding rule, the real strength of the spirits may be taken at all temperatures. It has been forgotten, that these heads, from their being less liable to change than other instruments, might be usefully employed in checking the errors and variations of other hydrometers. And we prepared by Messrs Levi on the same principle for ascertaining the strength of weak acids. See

ment we give the general result in the table of specific gravity, as peculiarly belonging to spirituous liquors, affording the most exact account of their density in every state of dilution of alcohol with water. And as the relation between the proportion of ingredients and the density is peculiar to every substance, so that scarcely any inference can be made from one to another, the reader will consider the tables here given as characteristic with respect to alcohol. In all solutions of salts we found that the condensation increases continually with the dilution, whereas it is greatest when equal bulks of water and alcohol are mixed; yet we do not consider this as an exception; for it is certain, that in the strongest brine the saline ingredient bears but a small proportion to the water—and when we mix two solutions, the condensation is greatest when they are nearly equal in bulk. But we think ourselves entitled to infer, that alcohol is not a dilution of a substance in a quantity of water; but that water, in a certain proportion, not very distant from what we can produce by slow distillation, is an ingredient of alcohol, or is one of its component parts, and not merely a vehicle or menstruum. We therefore imagine that proof spirit contains nearly equal bulks of water and ardent spirits.

The great difficulty in this examination arose from the very dissimilar expansions of water and alcohol by heat. This determined Sir Charles Blagden to eliminate the proportions of ingredients by weight, and made it absolutely necessary to give a scale of specific gravity and strength for every temperature. For it must be remarked, that the question (whether in commerce or philology) always is, "How many gallons of alcohol and of water, taken just now and mixed together, will produce a hundred gallons of the spirit we are examining?" The proportion of these two will be different according to the temperature of both. As many mixtures therefore must have been made in each proportion as there were temperatures considered; but by taking the ingredients by weight, and examining the density of the compound in one temperature, it is then heated and cooled, and its change of density observed. Calculation then can tell us the change in the proportion of the bulks or numbers of gallons in the mixture, by means of a previous table showing the expansions of water and of alcohol.

The alcohol selected for this examination had the specific gravity 0.825. This is not the purest that can be procured; some was produced of 0.816, of 0.814, and 0.812, both obtained from rum, from brandy, and from malt spirit. We are informed that Dr. Black has obtained it of the specific gravity 0.8 by digesting alcohol with fixed ammoniac (muriatic acid united with lime) made very dry. It dephlegmated alcohol very powerfully without decomposing it, which always happens when we use caustic alkali. Alcohol of 0.825 was chosen because expressed by a number of easy management in computation.

The examination commenced by ascertaining the expansions of water and alcohol. The temperature 60° of Fahrenheit's scale was selected for the general temperature of comparison, being easily attainable even in cold weather, and allowing the examiner to operate at ease. The first and last compartments of the tables contain the weights and specific gravities of alcohol and water for every fifth degree of heat from 30° to 100°.

From these we have constructed the two following little tables of expansion. The bulk of 1000 ounces, pounds, or other weight of water and of alcohol of the temperature 60°, occupies the bulks expressed in the tables for every other temperature. Water could not be easily or usefully examined when of the temperature 30°, because it is with great difficulty kept fluid in that temperature. It is very remarkable, that when it can be kept, it expands instead of contracting; while cooling down from 35° or thereabouts, and as it approaches to 32°, it expands rapidly. We observe the same thing in the crystallization of Glauber salt, martial vitriol, and some others, which contain much water in their crystals. We observe, on the other hand, a remarkable contraction in the zeolite just before its beginning to swell into bubbles by a red heat.

Heat	Bulk of 1000 ounces.			
	Of Water		Of Alcohol	
		D. H.		D. H.
30°			119195	319
35	99910	— 4	119514	325
40	99966	+ 8	119839	332
45	99914	18	120172	342
50	99932	30	120514	348
55	99962	38	120868	353
60	100000	38	121122	357
65	100050	50	121565	363
70	100106	64	121919	369
75	100170	71	122279	376
80	100241	79	122645	372
85	100320	84	123017	376
90	100404	96	123393	376
95	100500	108	123773	380
100	100608	108	124157	384

This being premised, the examination was conducted in the following manner. It was determined to mix 100 parts by weight of pure alcohol with five, ten, fifteen, twenty, parts of distilled water, till they were compounded in equal quantities, and then to mix 100 parts of distilled water with, 95, 90, 85, 80, &c. parts of alcohol, till they were mixed in the proportion of 100 to 5. Thus a series of mixtures would be obtained, extending from pure alcohol to pure water. This series would be such, that the examinations would be most frequent in the cases most usual in the commerce of strong liquors. A set of phials, fitted with ground stoppers, were provided, of sizes fit to hold the intended mixtures. These mixtures were made by suspending the phial to the arm of a very nice balance, in the opposite scale of which (besides the counterpoise of the phial) there was placed the weight 100. Spirit was then poured into the phial till it exactly balanced the weight 100. The weight for the water to be added was then put into the opposite scale, and water was poured into the phial by means of a slender glass funnel, by small quantities at a time, and the phial frequently agitated to promote the mixture. When the additional weight was exactly balanced, the phial was taken off, its stopper put in, and leather tied over it, and it was set by, for at least a month, that the mixture and the whole process of condensation might be completed. The same method

Spirituos method was followed in the mixtures where the water Liquor. was predominant.

When the ingredients of these mixtures were judged to have completely incorporated, their specific gravity was examined by weighing with the most scrupulous precision the contents of a vessel which held 2925 troy grains of water, of the temperature 60°. The balance was so exceedingly sensible, that the 50th part of a grain greatly deranged its position when loaded with the scales and their contents. It was constructed by Mr Ramden, and some account of its exquisite sensibility may be seen in the *Journal de Physique*, vol. xxxiii. This quantity of materials was therefore thought abundantly sufficient for ascertaining the density of the liquor. It is needless to detail the precautions which were taken for having the contents of the weighing bottle brought to the precise temperature proper for the experiment. They were such as every person conversant with such things is accustomed to take.—The bottle had a slender neck, and being put on a lathe, a work was made round it with a diamond. The bottle was filled till the bottom of the hollow surface of the fluid was in the plane of this mark; and to judge of the accuracy attainable in filling the bottle, the operation was several times repeated and the contents weighed, without the difference of $\frac{1}{100}$ th of a grain in 2925. The only source of error which was to be guarded against was air-bubbles adhering to the inside of the bottle, or moisture condensing (in the experiments with low temperatures) on the outside. Both of these were attended to as much as possible.

This method of determining the specific gravity was preferred to the usual method, observing the weight lost by a lump of glass when suspended in water; for Mr Gilpin had been enabled, by means of this nice balance, to discover, even in pure water and in alcohol, a want of perfect fluidity. Something like viscosity rendered the motion of a lump of glass through the

liquor sensibly sluggish, so that when the balance was brought to a level, there was not a perfect equilibrium of weights: (See what we have said of this matter in SPECIFIC GRAVITY). Mr Gilpin also tried the ingenious instrument proposed for such experiments by Mr Ramden, and described by him in a pamphlet on this very subject; and he found the anomalies of experiment much greater than in this method by weighing.—Indeed the regular progression of weights to be seen in the annexed tables is an unquestionable proof of the sufficiency of the method; and it has the evident advantage of all other methods in point of simplicity and practicability without any uncommon apparatus. Any person possessed of a good ordinary balance and a set of exact weights may examine all questions of this kind, by weighing pure water and the liquor which he may have occasion to examine in a common 6 or 8 ounce phial. For this reason, it is recommended (in preference to all hydrometers) to the board of excise to provide this simple apparatus in every principal office.

Every experiment was made at least three times; and the mean result (which never differed one grain from the extreme) was taken.

From these experiments the annexed tables were constructed. The first is the simple abstract of the experiments, containing the weights of the contents of the bottle of every mixture. The second contains the specific gravities deduced from them.

We have said that the experiments appear surprisingly accurate. This we say on the authority of the regular progression of the specific gravity in any of the horizontal rows. In the series, for instance, for the temperature 60°, the greatest anomaly is in the mixture of 50 parts of spirit with 100 of water. The specific gravity is 93824, wanting 3 or 4 of the regular progression. This does not amount to 1 in 18000.

TABLE I. Weights at the different Degrees of Temperature.

Heat.	The pure Spirit.	100 grains of spirit to 5 grains of water.	100 grains of spirit to 10 grains of water.	100 grains of spirit to 15 grains of water.	100 grains of spirit to 20 grains of water.	100 grains of spirit to 25 grains of water.	100 grains of spirit to 30 grains of water.	100 grains of spirit to 35 grains of water.	100 grains of spirit to 40 grains of water.	100 grains of spirit to 45 grains of water.	100 grains of spirit to 50 grains of water.	100 grains of spirit to 55 grains of water.	100 grains of spirit to 60 grains of water.	100 grains of spirit to 65 grains of water.
		Grains.	Grains.	Grains.	Grains.	Grains.	Grains.	Grains.	Grains.	Grains.	Grains.	Grains.	Grains.	Grains.
30	2377.35	2519.92	2548.42	2573.82	2596.66	2617.30	2636.23	2653.73	2669.83	2684.74	2698.51	2711.14	2722.89	2733.87
35	2420.87	2513.43	2541.84	2567.26	2592.16	2610.87	2629.92	2647.47	2663.64	2678.60	2692.43	2705.14	2716.92	2727.81
40	2474.10	2506.75	2535.41	2560.74	2583.66	2602.50	2623.36	2641.08	2657.23	2672.30	2686.32	2699.44	2711.81	2721.83
45	2526.12	2500.14	2528.75	2554.09	2577.10	2597.98	2617.03	2634.64	2650.87	2666.04	2679.99	2692.77	2704.57	2715.62
50	2576.82	2493.33	2521.96	2547.17	2570.42	2591.38	2610.54	2628.21	2644.43	2659.55	2673.64	2686.54	2698.42	2709.48
55	2625.80	2486.37	2515.03	2540.26	2563.64	2584.65	2603.80	2621.50	2637.86	2653.04	2667.14	2679.98	2691.83	2702.98
60	2672.20	2479.36	2508.07	2533.33	2556.90	2577.95	2597.22	2615.03	2631.37	2646.53	2660.62	2673.55	2685.52	2696.73
65	2717.12	2472.35	2501.53	2526.99	2550.22	2571.24	2590.55	2608.37	2624.75	2640.01	2654.04	2667.77	2679.15	2690.32
70	2760.53	2465.32	2494.56	2520.03	2543.32	2564.47	2583.88	2601.67	2617.96	2633.32	2647.52	2660.63	2672.74	2684.02
75	2802.42	2458.28	2487.62	2513.08	2536.39	2557.61	2576.93	2594.85	2611.19	2626.55	2640.81	2653.99	2666.06	2677.34
80	2842.81	2451.27	2480.45	2506.28	2529.24	2550.50	2569.86	2587.93	2604.29	2619.72	2633.99	2647.12	2659.36	2670.69
85	2881.76	2444.63	2473.33	2499.01	2522.29	2543.54	2563.01	2580.93	2597.45	2613.02	2627.39	2640.60	2652.78	2664.16
90	2919.29	2437.62	2466.32	2491.99	2515.28	2536.63	2556.11	2574.22	2590.60	2606.16	2620.52	2633.74	2646.00	2657.41
95	2955.43	2430.33	2459.13	2484.74	2508.10	2529.46	2549.13	2567.93	2583.65	2599.24	2613.57	2626.94	2639.25	2650.63
100	2990.26	2423.22	2452.13	2477.64	2500.91	2522.30	2541.92	2559.96	2576.56	2592.14	2606.30	2619.75	2632.17	2643.75

Heat.	100 grain of spirit to 70 grains of water.	100 grain of spirit to 75 grains of water.	100 grain of spirit to 80 grains of water.	100 grain of spirit to 85 grains of water.	100 grain of spirit to 90 grains of water.	100 grain of spirit to 95 grains of water.	100 grain of spirit to 100 grains of water.	95 grains of spirit to 100 grains of water.	90 grains of spirit to 100 grains of water.	85 grains of spirit to 100 grains of water.	80 grains of spirit to 100 grains of water.	75 grains of spirit to 100 grains of water.	70 grains of spirit to 100 grains of water.	65 grains of spirit to 100 grains of water.
	Grains.	Grains.	Grains.	Grains.	Grains.	Grains.	Grains.	Grains.	Grains.	Grains.	Grains.	Grains.	Grains.	Grains.
30	2744.20	2753.75	2762.72	2771.08	2778.99	2786.36	2793.22	2799.35	2806.61	2813.85	2821.35	2828.90	2836.39	2844.16
35	2738.13	2747.74	2756.91	2765.32	2773.22	2780.59	2787.54	2794.19	2801.14	2808.52	2816.07	2823.68	2831.36	2839.26
40	2732.24	2741.86	2750.60	2759.50	2767.48	2774.90	2781.84	2788.69	2795.72	2803.17	2810.73	2818.36	2826.31	2834.40
45	2726.59	2735.77	2744.82	2753.36	2761.42	2768.85	2775.94	2782.99	2789.99	2797.45	2805.28	2813.93	2821.00	2829.28
50	2721.03	2729.61	2738.74	2747.27	2755.37	2762.95	2770.14	2777.10	2783.90	2790.72	2799.68	2807.56	2815.71	2824.12
55	2715.60	2723.51	2732.64	2741.24	2749.27	2756.83	2764.59	2771.29	2777.54	2783.56	2789.82	2800.19	2810.23	2818.80
60	2710.40	2717.30	2726.52	2735.11	2743.28	2750.93	2758.17	2765.40	2772.70	2780.26	2788.25	2796.45	2804.85	2813.65
65	2705.45	2712.06	2721.25	2729.88	2737.09	2744.86	2752.21	2759.47	2766.73	2774.13	2782.62	2790.81	2799.83	2808.31
70	2699.76	2706.41	2715.87	2724.75	2732.94	2740.33	2747.26	2753.41	2760.75	2768.43	2776.72	2785.06	2793.80	2802.88
75	2698.14	2698.57	2707.49	2716.35	2724.64	2732.39	2739.89	2747.23	2754.73	2762.58	2770.93	2779.26	2788.00	2797.21
80	2698.50	2699.15	2708.94	2717.12	2725.06	2732.33	2739.93	2747.93	2756.43	2764.31	2772.63	2781.47	2790.52	2799.52
85	2698.45	2698.98	2708.53	2716.33	2723.86	2731.74	2739.25	2746.80	2754.31	2762.31	2770.22	2778.58	2787.44	2795.81
90	2698.29	2698.49	2707.99	2716.01	2723.57	2731.32	2738.89	2746.80	2754.24	2762.24	2770.17	2778.51	2786.59	2794.81
95	2698.14	2698.12	2707.34	2715.33	2722.88	2730.88	2738.61	2746.11	2753.61	2761.59	2769.57	2777.57	2785.34	2793.25
100	2698.47	2698.49	2707.42	2715.63	2723.65	2731.25	2738.42	2745.73	2753.35	2761.33	2769.43	2777.48	2785.48	2793.43

Heat.	90 grains of spirit to 100 grains of water.	85 grains of spirit to 100 grains of water.	80 grains of spirit to 100 grains of water.	75 grains of spirit to 100 grains of water.	70 grains of spirit to 100 grains of water.	65 grains of spirit to 100 grains of water.	Water.
	Grains.	Grains.	Grains.	Grains.	Grains.	Grains.	Grains.
30	2852.23	2859.71	2867.12	2874.43	2881.34	2887.77	2894.22
35	2847.35	2855.32	2863.16	2870.87	2878.21	2885.26	2892.27
40	2842.62	2850.38	2858.06	2865.28	2872.81	2880.30	2887.98
45	2838.04	2846.11	2854.67	2862.24	2870.22	2878.22	2887.33
50	2833.76	2841.52	2850.20	2858.65	2867.52	2875.98	2884.57
55	2829.68	2837.66	2845.72	2854.75	2863.75	2872.67	2881.69
60	2825.65	2833.09	2841.31	2850.35	2859.57	2868.15	2877.72
65	2821.75	2829.05	2837.31	2845.97	2854.55	2863.45	2872.49
70	2818.16	2825.75	2834.51	2843.14	2851.53	2861.63	2872.26
75	2814.75	2822.63	2831.60	2840.82	2849.14	2859.79	2868.49
80	2811.28	2819.23	2828.35	2837.92	2847.56	2858.38	2866.54
85	2808.09	2816.23	2825.43	2835.12	2845.27	2855.28	2865.86
90	2805.13	2813.44	2822.75	2832.15	2842.38	2852.38	2862.80
95	2802.35	2810.91	2820.39	2830.58	2841.26	2851.47	2861.15
100	2798.64	2808.32	2817.55	2827.18	2837.30	2847.18	2860.12

TABLE II. Real Specific Gravities at the different Temperatures.

Heat.	The pure spirit.	100 grains of spirit to 5 grains of water.	100 grains of spirit to 10 grains of water.	100 grains of spirit to 15 grains of water.	100 grains of spirit to 20 grains of water.	100 grains of spirit to 25 grains of water.	100 grains of spirit to 30 grains of water.	100 grains of spirit to 35 grains of water.	100 grains of spirit to 40 grains of water.	100 grains of spirit to 45 grains of water.	100 grains of spirit to 50 grains of water.	100 grains of spirit to 55 grains of water.	100 grains of spirit to 60 grains of water.	100 grains of spirit to 65 grains of water.	
30	.83896	.84095	.83977	.86828	.87585	.88282	.88921	.89511	.89954	.90358	.90723	.91023	.91449	.91847	.92217
35	.83672	.84769	.83729	.86587	.87357	.88059	.88721	.89294	.89839	.90235	.90611	.90911	.91241	.91640	.92029
40	.83445	.84539	.83507	.86365	.87134	.87838	.88481	.89073	.89617	.90012	.90388	.90718	.91026	.91428	.91799
45	.83214	.84310	.83277	.86131	.86907	.87613	.88255	.88849	.89393	.89789	.90165	.90495	.90821	.91211	.91584
50	.82977	.84076	.83042	.85902	.86676	.87384	.88030	.88626	.89174	.89570	.89946	.90276	.90597	.90977	.91370
55	.82735	.83834	.82802	.85666	.86441	.87151	.87796	.88393	.88941	.89337	.89713	.90043	.90364	.90739	.91144
60	.82490	.83589	.82566	.85430	.86205	.86915	.87560	.88156	.88704	.89100	.89476	.89806	.90127	.90497	.90922
65	.82262	.83362	.82334	.85198	.85976	.86686	.87337	.87938	.88489	.88886	.89262	.89592	.89913	.90278	.90697
70	.82023	.83124	.82099	.84963	.85741	.86451	.87105	.87705	.88256	.88653	.89029	.89359	.89680	.90045	.90464
75	.81782	.82882	.81851	.84715	.85493	.86203	.86857	.87458	.88009	.88406	.88782	.89112	.89433	.89798	.90217
80	.81530	.82630	.81699	.84563	.85341	.86051	.86705	.87306	.87857	.88254	.88630	.88960	.89281	.89646	.90064
85	.81283	.82383	.81352	.84216	.85000	.85710	.86364	.86965	.87516	.87913	.88289	.88619	.88940	.89305	.89724
90	.81030	.82130	.81101	.83977	.84776	.85486	.86140	.86741	.87292	.87689	.88065	.88395	.88716	.89081	.89500
95	.80783	.81883	.80854	.83741	.84540	.85250	.85904	.86505	.87056	.87453	.87829	.88159	.88480	.88845	.89264
100	.80543	.81643	.80614	.83478	.84277	.84987	.85641	.86242	.86793	.87190	.87566	.87896	.88217	.88582	.89001

Heat.	100 grains of spirit to 75 grains of water.	100 grains of spirit to 75 grains of water.	100 grains of spirit to 75 grains of water.	100 grains of spirit to 75 grains of water.	100 grains of spirit to 75 grains of water.	100 grains of spirit to 75 grains of water.	100 grains of spirit to 75 grains of water.	100 grains of spirit to 75 grains of water.	100 grains of spirit to 75 grains of water.	100 grains of spirit to 75 grains of water.	100 grains of spirit to 75 grains of water.	100 grains of spirit to 75 grains of water.	100 grains of spirit to 75 grains of water.	100 grains of spirit to 75 grains of water.	100 grains of spirit to 75 grains of water.
30	.92363	.92859	.93191	.93474	.93741	.93991	.94222	.94447	.94675	.94920	.95173	.95429	.95681	.95944	.96214
35	.92355	.92851	.93183	.93466	.93733	.93983	.94214	.94439	.94667	.94911	.95164	.95416	.95670	.95933	.96203
40	.92347	.92843	.93175	.93458	.93725	.93975	.94206	.94431	.94659	.94903	.95156	.95408	.95662	.95925	.96195
45	.92339	.92835	.93167	.93450	.93717	.93967	.94198	.94423	.94651	.94895	.95148	.95400	.95654	.95917	.96187
50	.92331	.92827	.93159	.93442	.93709	.93959	.94190	.94415	.94643	.94887	.95140	.95392	.95646	.95909	.96179
55	.92323	.92819	.93151	.93434	.93701	.93951	.94182	.94407	.94635	.94879	.95132	.95384	.95638	.95901	.96171
60	.92315	.92811	.93143	.93426	.93693	.93943	.94174	.94399	.94627	.94871	.95124	.95376	.95630	.95893	.96163
65	.92307	.92803	.93135	.93418	.93685	.93935	.94166	.94391	.94619	.94863	.95116	.95368	.95622	.95885	.96155
70	.92299	.92795	.93127	.93410	.93677	.93927	.94158	.94383	.94611	.94855	.95108	.95360	.95614	.95877	.96147
75	.92291	.92787	.93119	.93402	.93669	.93919	.94150	.94375	.94603	.94847	.95100	.95352	.95606	.95869	.96139
80	.92283	.92779	.93111	.93394	.93661	.93911	.94142	.94367	.94595	.94839	.95092	.95344	.95598	.95861	.96131
85	.92275	.92771	.93099	.93382	.93649	.93899	.94130	.94355	.94583	.94827	.95080	.95332	.95586	.95849	.96119
90	.92267	.92763	.93091	.93374	.93641	.93891	.94122	.94347	.94575	.94819	.95072	.95324	.95578	.95841	.96111
95	.92259	.92755	.93079	.93362	.93629	.93879	.94110	.94335	.94563	.94807	.95060	.95312	.95566	.95829	.96099
100	.92251	.92747	.93071	.93354	.93621	.93871	.94102	.94327	.94555	.94799	.95052	.95304	.95558	.95821	.96091

Heat.	60 grains of spirit to 100 grains of water.	55 grains of spirit to 100 grains of water.	50 grains of spirit to 100 grains of water.	45 grains of spirit to 100 grains of water.	40 grains of spirit to 100 grains of water.	35 grains of spirit to 100 grains of water.	30 grains of spirit to 100 grains of water.	25 grains of spirit to 100 grains of water.	20 grains of spirit to 100 grains of water.	15 grains of spirit to 100 grains of water.	10 grains of spirit to 100 grains of water.	5 grains of spirit to 100 grains of water.	Water.
30	.96229	.96472	.96719	.96967	.97222	.97488	.97763	.98048	.98343	.98648	.98963	.99288	1.00000
35	.96245	.96488	.96735	.96983	.97238	.97513	.97798	.98093	.98398	.98713	.99038	.99373	1.00000
40	.96261	.96504	.96751	.97000	.97255	.97530	.97815	.98110	.98415	.98730	.99055	.99390	1.00000
45	.96277	.96520	.96767	.97016	.97271	.97546	.97831	.98136	.98451	.98776	.99101	.99446	1.00000
50	.96293	.96536	.96783	.97032	.97287	.97562	.97847	.98152	.98467	.98792	.99117	.99472	1.00000
55	.96309	.96552	.96799	.97048	.97303	.97578	.97863	.98168	.98483	.98808	.99133	.99498	1.00000
60	.96325	.96568	.96815	.97064	.97319	.97594	.97879	.98184	.98499	.98824	.99149	.99514	1.00000
65	.96341	.96584	.96831	.97080	.97335	.97610	.97895	.98200	.98515	.98840	.99165	.99530	1.00000
70	.96357	.96600	.96847	.97096	.97351	.97626	.97911	.98216	.98531	.98856	.99181	.99546	1.00000
75	.96373	.96616	.96863	.97112	.97367	.97642	.97927	.98232	.98547	.98872	.99197	.99562	1.00000
80	.96389	.96632	.96879	.97128	.97383	.97658	.97943	.98248	.98563	.98888	.99213	.99578	1.00000
85	.96405	.96648	.96895	.97144	.97399	.97674	.97959	.98264	.98579	.98904	.99229	.99594	1.00000
90	.96421	.96664	.96911	.97160	.97415	.97690	.97975	.98280	.98595	.98920	.99245	.99610	1.00000
95	.96437	.96680	.96927	.97176	.97431	.97706	.97991	.98296	.98611	.98936	.99261	.99626	1.00000
100	.96453	.96696	.96943	.97192	.97447	.97722	.98007	.98312	.98627	.98952	.99277	.99642	1.00000

Spirits
Liquors

We formerly observed, that the series of mixtures chosen by Sir Charles Blagden, for the advantages attending it in making the experiment, was not suited for solving the questions which commonly occur in the spirit business. He accordingly suggests the propriety of forming tables in a convenient series from the data furnished by these experiments, indicating the proportion of ingredients contained in some constant weight or bulk.

To facilitate the construction of such tables, it is necessary to consider the subject in the most general manner. Therefore let a represent the constant number 100. Let w and s represent the quantities of water and spirit by weight in any mixture; that is, the pounds, ounces, or grains of each. Let x represent the quantity per cent. of spirits alloy by weight; that is, the number of pounds of spirits contained in 100 pounds of the mixture; and let y be its quantity per cent. in gallons, or the number of gallons contained in 100 gallons of the unmixed ingredients. Let m be the bulk of a pound of spirit of any given temperature, the bulk of a pound of water of the same temperature being accounted 1.

Then $w+s$ is the weight of any mixture, and $w+ms$ is its bulk.

We have the following proportions: 1. $w+s:s=a:x$, and $x=\frac{as}{w+s}$ (Equation 1st); and hence s may be found when x the per centage in weight is given, for $s=\frac{wx}{a-x}$ (Equation 2.)

2. $w+ms:m:s=a:y$, and $y=a\frac{ms}{w+ms}$ (Equation 3d); and s may be found when y , the per centage in gallons, is given; for $s=\frac{my}{a-y}$ (Equation 4th).

The usual questions which can be solved from these experiments are,

1. To ascertain the quantity of spirits per cent. in bulk from observation of the specific gravity, or to tell how many gallons of spirit are in 100 gallons of mixture.

Look for the specific gravity in the table, and at the head of the column will be found the w and s corresponding. If the precise specific gravity observed is not in the tables, the s must be found by interpolation. And here it is proper to remark, that taking the simple proportional parts of specific gravity will not be sufficiently exact, especially near the beginning or the end of the table, because the densities corresponding to the series of mixtures do not change uniformly. We must have recourse to the general rules of interpolation, by means of first and second differences, or be provided with a subsidiary table of differences. A good deal of practice in computations of this kind suggested the following method of making such interpolations with great dispatch and abundant accuracy. On a plate of wood or metal, or stiff card-paper, draw a line EF (fig. 1.), as a scale of equal parts, representing the leading or equable arithmetical series of any table. (In the present case EF is the scale on which s is computed.)—Through every point of division draw the perpendiculars BA, EC, FD, &c. Make one of them AB more conspicuous than the rest, and distinguish the others also in such sort, that the eye shall readily catch their distance from the prin-

cipal line AB. Let GPL be a thin slip of whalebone, of uniform breadth and thickness, also divided into equal parts properly distinguishable. Lastly, let there be a pin P fixed near the middle of the principal line AB.

Spirits
Liquors

Now suppose that a value of s is to be interpolated by means of an observed specific gravity not in the table. Look for the nearest to it, and note its distance from the preceding and the following. Let these be PH and PK on the flexible scale. Also take notice of the lines K 10 and H 10, whose distances from AB are equal to the constant difference between the successive values of S , or to any easily estimated multiple of it (as in the present case we have taken 10 and 10, instead of 5 and 5, the running difference of Sir Charles Blagden's table). Then, leaning the middle point P of the whalebone on the pin P in the board, bend it, and place it slantwise till the points K and H fall somewhere on the two parallels K 10 and H 10. No matter how oblique the position of the whalebone is. It will bend in such a manner that its different points of division (representing different specific gravities) will fall on the parallels which represent the corresponding values of s . We can say that all this may be done in less than half a minute, and less time than is necessary for inspecting a table of proportional parts, and not the tenth part of that necessary for interpolating by second differences. Yet it is exact enough (if of the size of a duodecimo page) for interpolating three decimal places. This is ten times more exact than the present case requires. To return from this digression.

Having thus found s in the table, we get x or y by the equations $\frac{as}{w+s}=x$, and $a-\frac{ms}{w+ms}=y$.

But here a material circumstance occurs. The weight of alcohol s , and its per centage x , was rightly determined by the specific gravity, because it was interpolated between two values, which were experimentally connected with this specific gravity. But in making the transition from x to y , we only give the per centage in gallons before mixture, but not the number of gallons of alcohol contained in an hundred gallons of mixed liquor. For when we have taken $a-y$ and y instead of w and s , they will indeed make a similar compound when mixed, because the proportion of their ingredients is the same. But they will not make 100 gallons of this compound, because there is a shrinking or condensation by mixture, and the specific gravity by which we interpolated s is the physical or real specific gravity corresponding to w and s ; while $\frac{w+s}{w \times m s}$, the specific gravity implied in the value of y , is the mathematical density independent on this condensation. Since therefore y , together with $a-y$, make less than 100 gallons of the compound, there must in 100 gallons of it be more alcohol than is expressed by y .

Let G be the mathematical specific gravity ($=\frac{w+s}{w+ms}$), and g the physical or real observed specific gravity (which we cannot express algebraically); and let π be the gallons of alcohol really contained in 100 gallons of the compound. The bulk being inversely as the density or specific gravity, it is evident that the bulk of the compound must be to 100 gallons as g

FIGURE
CCCCXCIX
Fig. 1.

Spirituous Liquors. to G. And since we want to make it fill up to 100 gallons, we must increase it in the proportion of G to g. And because this augmentation must be of the same strength with this contracted liquor, both ingredients must be increased in the proportion of G to g, and we must have $G : g :: y : z$, and $z = y \times \frac{y}{G}$. Now,

instead of y, write $a \frac{m s}{w + m s}$, and instead of $\frac{r}{G}$ write $\frac{w + m s}{w + s}$, which are respectively equal to them. This

$$\text{gives us } z = g \times \frac{w + m s}{w + s} \times \frac{m s}{w + s} = g \times \frac{m s}{w + s}.$$

All this will be illustrated by an example.

Suppose that we have observed the specific gravity of a spirituous liquor of the temperature 60° to be 0.94128. Looking into Sir Charles Blagden's table, we find the gravities 0.94218 and 0.94296, and the s corresponding to them is 80 and 75, the water in each mixture being 100. By interpolation we obtain the s corresponding to 0.94128, viz. 78. At this temperature $m = \frac{1}{0.825} = 1.21212$, and $m s = 94.54545$. Therefore $z = 0.94128 \times 100 \times \frac{94.54545}{194.54545} = 49.997$, or very nearly 50.

We have seen even persons not unacquainted with subjects of this kind puzzled by this sort of paradox. z is said to be the per centage of spirit in the compound. The compound has the same proportion of ingredients when made up to 100 gallons as before, when y was said to be its per centage, and yet y and z are not the same. The fact is, that although z is the number of gallons of alcohol really contained in 100 gallons of the compound, and this alcohol is in the same proportion as before to the water, this proportion is not that of 50 to 50: for if the ingredients were separated again, there would be 50 gallons of alcohol and 52.876 of water.

The proportion of the ingredients in their separate state is had by the 3d equation $y = a \frac{m s}{w + m s}$, which

is equivalent to $G a \frac{m s}{w + s}$. For the present example y will be found 48.599, and $a - y$, or the water per cent, 51.401, making 100 gallons of unmixed ingredients. We see then that there has been added 1.398 gallons of alcohol; and since both ingredients are augmented in the proportion of G to g, there have also been added 1.478 of water, and the whole addition for making up the 100 gallons of compound is 2.876 gallons; and if the ingredients of the compound were separate, they would amount to 102.876 gallons. This might have been found at the first, by the proportion, $G : g :: G - G : (The addition)$.

The next question which usually occurs in business is to find what density will result from any proposed mixture per gallon. This question is solved by means of the equation $\frac{w y}{m(a-y)} = r$. In this examination it will be most convenient to make $w = a$. If the value of r found in this manner falls on a value in the tables, we

have the specific gravity by inspection. If not, we must interpolate.

N. B. The value of m, which is employed in these reductions, varies with the temperature. It is always obtained by dividing the specific gravity of alcohol of that temperature by the specific gravity of water of the same temperature. The quotient is the real specific gravity of alcohol for that temperature. Both of these are to be had in the first and last compartments of Sir Charles Blagden's table.

These operations for particular cases give the answers to particular occasional questions. By applying them to all the numbers in the table, tables may be constructed for solving every question by inspection.

There is another question which occurs most frequently in the excise transactions, and also in all compositions of spirituous liquors, viz. What strength will result from a mixture of two compounds of known strength, or mixing any compound with water? To solve questions of this kind by the table is often quoted, we must add into one sum the water per gallon of the different liquors. In like manner, take the sum of the spirits, and say, as the sum of the waters is to that of the alcohols, so is a to s; and operate with a and s as before.

Analogous to this is the question of the duties. These are levied on proof spirit; that is, a certain duty is charged on a gallon of proof spirit; and the gauger's business is to discover how many gallons of proof spirit there is in any compound. The specification of proof spirit in our excise laws is exceedingly obscure and complex. A gallon weighing 7 pounds 13 ounces (at 55°) is accounted 1 to 6 under proof. The gallon of water contains 58476 grains, and this spirit is 54688. Its density therefore is 0.93523 at 55°, or (as may be inferred from the table) 0.9335 at 60°. This density corresponds to a mixture of 100 grains of water with 93.457 of alcohol. If this be supposed to result from the mixture of 6 gallons of alcohol with 1 of water (as is supposed by the designation of 1 to 6 under proof), the gallon of proof spirits consists of 100 parts of spirits by weight, mixed with 75 parts of water. Such a spirit will have the density 0.9162 nearly.

This being premised, in order to find the gallons of proof spirits in any mixture, find the quantity of alcohol by weight, and then say, as 100 to 175, so is the alcohol in the compound to the proof spirit that may be made of it, and for which the duties must be paid.

We have considered this subject at some length, because it is of great importance in the spirit-trade to have these circumstances ascertained with precision; and because the specific gravity is the only sure criterion that can be had of the strength. Firing of gunpowder, or producing a certain bubble by shaking, are very vague tells; whereas, by the specific gravity, we can very securely ascertain the strength within one part in 500, as will presently appear.

Sir Charles Blagden, or Mr Gilpin, has published * a most copious set of tables, calculated from these valuable experiments. In these, computations are made for every unit of the hundred, and for every degree of the thermometer. But these tables are still not in the most commodious form for business. Mr John Wilton, an ingenious gentleman residing at Dundee, has just published

Spir. per cent.	Specific Gravity.	Contr.	Spir. per cent.	Specific Gravity.	Contr.	Spir. per cent.	Specific Gravity.	Contr.
100	0.82500		66	0.91095	2.59	33	0.96481	2.27
90	0.82629	0.18	65	0.91306	2.62	32	0.96587	2.21
98	0.83142	0.34	64	0.91511	2.64	31	0.96691	2.15
97	0.83449	0.46	63	0.91714	2.66	30	0.96793	2.08
96	0.83750	0.57	62	0.91914	2.68	29	0.96894	2.00
95	0.84048	0.68	61	0.92112	2.70	28	0.96992	1.93
94	0.84339	0.8	60	0.92308	2.72	27	0.97089	1.86
93	0.84621	0.9	59	0.92501	2.74	26	0.97185	1.79
92	0.84900	1.01	58	0.92692	2.76	25	0.97280	1.71
91	0.85172	1.11	57	0.92883	2.77	24	0.97374	1.63
90	0.85443	1.21	56	0.93072	2.78	23	0.97468	1.56
89	0.85704	1.31	55	0.93258	2.80	22	0.97561	1.48
88	0.85971	1.39	54	0.93436	2.81	21	0.97654	1.4
87	0.86228	1.47	53	0.93612	2.81	20	0.97747	1.32
86	0.86483	1.54	52	0.93786	2.82	19	0.97841	1.24
85	0.86737	1.61	51	0.93958	2.81	18	0.97936	1.17
84	0.86987	1.67	50	0.94128	2.79	17	0.98032	1.08
83	0.87235	1.74	49	0.94293	2.78	16	0.98129	1.00
82	0.87481	1.81	48	0.94455	2.76	15	0.98228	.93
81	0.87726	1.88	47	0.94610	2.73	14	0.98328	.85
80	0.87969	1.94	46	0.94768	2.71	13	0.98430	.78
79	0.88207	2.	45	0.94923	2.70	12	0.98534	.71
78	0.88445	2.05	44	0.95074	2.68	11	0.98640	.66
77	0.88676	2.11	43	0.95219	2.66	10	0.98748	.61
76	0.88909	2.17	42	0.95364	2.63	9	0.98858	.51
75	0.89140	2.22	41	0.95502	2.60	8	0.98973	.43
74	0.89367	2.26	40	0.95636	2.58	7	0.99091	.34
73	0.89593	2.31	39	0.95766	2.54	6	0.99211	.25
72	0.89815	2.36	38	0.95894	2.49	5	0.99334	.18
71	0.90035	2.41	37	0.96019	2.46	4	0.99461	.12
70	0.90251	2.49	36	0.96141	2.43	3	0.99591	.7
69	0.90464	2.47	35	0.96258	2.38	2	0.99725	.3
68	0.90675	2.51	34	0.96371	2.33	1	0.99861	.1
67	0.90885	2.55	33	0.96481	2.27	0	1.00000	.0
66	0.91095	2.59						

" In the first table, of which the sole intention is to point out the proportion of ingredients, the specific gravities are computed only to four places, which will always give the answer true to $\frac{1}{10000}$ th part. In the last, which is more immediately interesting to the merchant in his transactions with the excise office, the computation is carried one place farther."

The consideration of the first of these two tables will furnish some useful information to the reader who is interested in the philosophy of chemical mixture, and who endeavours to investigate the nature of those forces which connect the particles of tangible matter. These vary with the distance of the particle; and therefore the law of their action, like that of universal gravitation, is to be discovered by measuring their sensible effects at their various distances. Their change of distance is seen in the change of density or specific gravity.

Did the individual densities of the water and spirit remain unchanged by mixture, the specific gravity would change by equal differences in the series of mixtures on which this table is constructed; for the bulk being always the same, the change of specific gravity must be the difference between the weight of the gallon of water which is added and that of the gallon of spirit which

is taken out. The whole difference of the specific gravities of spirits and water being 1.750 parts in 10,000, the augmentation by each successive change of a measure of spirit for a measure of water would be the 100th part of this, or 17.5. But, by taking the successive differences of density as they occur in the table, we see that they are vastly greater in the first additions of water, being then about 10; after which they gradually diminish to the medium quantity 17.5, when water and spirits are mixed in nearly equal bulks. The differences of specific gravity still diminish, and are reduced to 3, when about 75 parts of water are mixed with 25 of spirit. The differences now increase again; and the last, when 99 parts of water are mixed with one part of spirit, the difference from the specific gravity of pure water is above 14.

The mechanical effect, therefore, of the addition of a measure of water to a great quantity of spirit is greater than the similar effect of the addition of a measure of spirits to a great quantity of water. What we call mechanical effect is the local motion, the change of distance of the particles, that the corporeal forces may again be in equilibrio. Observe, too, that this change is greater than in the proportion of the distance of the particles:

Spiritus
Liquors

particles; for the density of water is to that of spirits nearly as 6 to 5, and the changes of specific gravity are nearly as 6 to 3.

We also see that the changing cause, which produces the absolute condensation of each ingredient, ceases to operate when 75 parts of water have been mixed with 25 of alcohol: for the variation of specific gravity, from diminishing comes now to increase; and therefore, in this particular state of composition, is equable. Things are now in the same state as if we were mixing two fluids which did not act on each other, but were mutually diffused, and whose specific gravities are nearly as 9 to 10; for the variation 9 of specific gravity may be considered as the 120th part of the whole difference, in the same manner as 17.7 would have been had water and alcohol contained no contraction.

The imagination is greatly assisted in the contemplation of geometrical quantity by exhibiting it in its own form. Specific gravity, being an expression of density (a notion purely geometrical), admits of this illustration.

Plat.
124

Therefore let AB (fig. 2.) represent the bulk of any mixture of water and alcohol. The specific gravity of water may be represented by a line of such a length, that AB shall be the difference between the gravities of alcohol and water. Suppose it extended upwards, towards *a*, till Ba is to Aa as 10,000 to 8250. It will suit our purpose better to represent it by a parallelogram aBFe, of any breadth BF. In this case the difference of the specific gravities of alcohol and water will be expressed by the parallelogram ABFE. If there were no change produced in the density of one or both ingredients, the specific gravity of the compound would increase as this parallelogram does, and AGHE would be the augmentation corresponding to the mixture of the quantity AG of alcohol with the quantity GB of water, and to of other mixtures. But, to express the augmentation of density as it really obtains, we must do it by some curvilinear area DABCHD, which varies at the rate determined by Sir Charles Blagden's experiments. This area must be precisely equal to the rectangle ABFE. It must therefore fall without it in some places, and be deficient in others. Let DMHKC be the curve which corresponds with these experiments. It is evident to the mathematical reader, that the ordinates LM, GH, IK, &c. of this curve are in the ultimate ratio of the differences of the observed specific gravities. If Aa, aB, &c. are each = 1, the little spaces AaB, D, aBb, &c. will be precisely equal to the differences of the specific gravities 0.8250; 0.8597; 0.8516; &c. corresponding to the different mixtures of water and alcohol. The curve cuts the side of the parallelogram in K, where the ordinate GK expresses the mean variation of density 0.00175. IK is the smallest variation. The condensation may be expressed by drawing a curve dmGfb parallel to DMGKE, making Dd=AE. The condensation is now represented by the spaces comprehended between this last curve and the abscissa AGB, reckoning those negative which lie on the other side of it. This shows, not only that the condensation is greatest in the mixture AG x GB, but also that in mixing such a compound with another A1 x 1B, there is a rarefaction. Another curve ANOPB may be drawn, of which the ordinates LN, GP, IO, &c. are proportional to the

Spiritus
Liquors
||
Spirits.

areas ALmd, AGmD, A1Gmd (=AGmd—G1E), &c. This curve shows the whole condensation.

This manner of representing the specific gravities of mixtures will suggest many curious inferences to such as will consider them in the manner of Boëcovich, with a view to ascertain the nature of the forces of cohesion and chemical affinities: And this manner of viewing the subject becomes every day more promising, in consequence of our improvements in chemical knowledge; for we now see, that mechanism, or motive forces, are the causes of chemical action. We see in almost every case, that chemical affinities are comparable with mechanical pressures; because the conversion of a liquid into a vapour or gas is prevented by atmospheric pressure, and produced by the great chemical agent heat. The action of heat, therefore, or of the cause of heat, is a mechanical action, and the forces are common mechanical forces, with which we are familiarly acquainted.

It may be also remarked in the column of contractions, that in the beginning the contractions augment nearly in the proportion of the quantity of spirits (but more slowly); whereas, in the end, the contractions are nearly in the duplicate proportion of the quantity of water. This circumstance deserves the consideration of the philosopher. We have represented it to the eye by the curve *aghd*."

We should here take some notice of the attempt made to elude some part of the duties, by adding some ingredient to the spirits. But our information on this subject is not very exact; and besides it would be doing no service to the trader to put fraud more in his power. There are some salts which make a very great augmentation of density, but they render the liquor unpalatable. Sugar is frequently used with this view; 16 grains of refined sugar dissolved in 1000 grains of proof spirits gave it no suspicious taste, and increased its specific gravity from 0.920 to 0.925, which is a very great change, equivalent to the addition of 9 grains of water to a mixture of 100 grains of alcohol and 80 of water.

SPIRLING, a species of fish. See SALMO, ICHTHYOLOGY, p. 99.

SPITHEAD, a road between Portsmouth and the isle of Wight, where the royal navy of Great Britain frequently rendezvous.

SPITTLE, in *Physiology*. See SALIVA.

SPITZBERGEN. See GREENLAND, N° 10.

SPLACHNUM, a genus of plants belonging to the class of cryptogamia, and order of musci. See BOTANY Index.

SPLEEN. See ANATOMY Index.

SPLEEN-WORD. See ASPLENIUM, BOTANY Index.

SPLENETIC, a person afflicted with an obstruction of the spleen.

SPLINT, or SPLINT, among farriers, a callous inflexible excrescence, breeding on the flank-bone of horses. See FARRIERY.

SPLICING, in the sea-language, is the untwisting the ends of two cables or ropes, and working the several strands into one another by a fidd, so that they become as strong as if they were but one rope.

SPOILS, whatever is taken from the enemy in time of war. Among the ancient Greeks, the spoils were divided among the whole army; only the general's share

was

Spoletto was largest: but among the Romans, the spoils belonged to the republic.

SPOLEFFO, a duchy of Italy, bounded on the north by the marquise of Ancona and duchy of Urbino, on the east by Farther Abruzzo, on the south by Sabina and the patrimony of St Peter, and on the west by Orvieto and Perugia. It is about 55 miles in length and 40 in breadth. It was anciently a part of Umbria, and now belongs to the pope.—The name of the capital city is also *Spoletto*. It was formerly a large place, but in 1793 was ruined by an earthquake; from whence it has never recovered itself.

SPOILIATION, in ecclesiastical law, is an injury done by one clerk or incumbent to another, in taking the fruits of his benefice without any right thereunto, but under a pretended title. It is remedied by a decree to account for the profits so taken. This injury, when the *jus patronatus*, or right of advowson, doth not come in debate, is cognizable in the spiritual court: as if a patron first presents A to a benefice, who is instituted and inducted thereto; and then, upon pretence of a vacancy, the same patron presents B to the same living, and he also obtains institution and induction. Now if A disputes the fact of the vacancy, then that clerk who is kept out of the profits of the living, whichever it be, may sue the other in the spiritual court for the spoilation, or taking the profits of his benefice. And it shall there be tried, whether the living were or were not vacant; upon which the validity of the second clerk's pretensions must depend. But if the right of patronage comes at all into dispute, as if one patron presented A, and another patron presented B, there the ecclesiastical court hath no cognizance, provided the tithes sued for amount to a fourth part of the value of the living, but may be prohibited at the instance of the patron by the king's writ of *indicavit*. So also if a clerk, without any colour of title, ejects another from his parsonage, this injury must be redressed in the temporal courts: for it depends upon no question determinable by the spiritual law (as plurality of benefices or no plurality, vacancy or no vacancy), but is merely a civil injury.

SPONDEE, in ancient poetry, a foot consisting of two long syllables, as *omnes*.

SPONDIAS, **BRASILIAN** or **JAMAICA PLUM**, a genus of plants belonging to the class of decandria. See **BOTANY Index**.

SPONGIA, **SPONGE**; a genus of animals belonging to the class of vermes, and order of zoophyta. It is fixed, flexible, and very torpid, growing in a variety of forms, composed either of reticulated fibres, or masses of small spines interwoven together, and clothed with a living gelatinous flesh, full of small mouths or holes on its surface, by which it sucks in and throws out the water. Fifty species have already been discovered, of which 10 belong to the British coasts. See **HELMINTHOLOGY Index**.

So early as the days of Aristotle sponges were supposed to possess animal life: the persons employed in collecting them having observed them shrink when torn from the rocks, thus exhibiting symptoms of sensation. The same opinion prevailed in the time of Pliny: but no attention was paid to this subject till Count Marssili examined them, and declared them vegetables. Dr Peyssonell, in a paper which he sent to the Royal Society in the year 1752, and in a second in 1755, affirmed they

were not vegetables, but the production of animals; and has accordingly described the animals, and the process which they performed in making the sponges. Mr Ellis, in the year 1762, was at great pains to discover these animals. For this purpose he dissected the *spongia urens*, and was surprised to find a great number of small worms of the genus of *nerets* or sea polychaenda, which had pierced their way through the soft substance of the sponge in quest of a safe retreat. That this was really the case, he was fully assured of, by inspecting a number of specimens of the same sort of sponge, just fresh from the sea. He put them into a glass filled with sea-water; and then, instead of seeing any of the little animals which Dr Peyssonell described, he observed the papillae or small holes with which the papillae are surrounded contract and dilate themselves. He examined another variety of the same species of sponge, and plainly perceived the small tubes inspire and expire the water. He therefore concluded, that the sponge is an animal, and that the ends or openings of the branched tubes are the mouths by which it receives its nourishment, and discharges its excrements.

SPONSORS, among Christians, are those persons who, in the office of baptism, answer or are sureties for the persons baptized.

SPONTANEOUS, a term applied to such motions of the body and operations of the mind as we perform of ourselves without any constraint.

SPOON-BILL. See **PLATALIA**, **ORNITHOLOGY Index**.

SPOONING, in the sea-language, is said of a ship, which being under sail in a storm at sea, is unable to bear it, and consequently forced to go right before the wind.

SPORADES, among ancient astronomers, a name given to such stars as were not included in any constellation.

SPORADIC DISEASES, among physicians, are such as seize particular persons at any time or season, and in any place; in which sense they are distinguished from epidemic and endemical diseases.

SPOTS, in *Astronomy*, certain places of the sun's or moon's disk, observed to be either more bright or dark than the rest; and accordingly called *faculae* et *maculae*. See **ASTRONOMY Index**.

SPOTSWOOD, **JOHN**, archbishop of St Andrew's in Scotland, was descended from the lairds of Spotswood in the Merse, and was born in the year 1565. He was educated in the university of Glasgow, and succeeded his father in the parsonage of Calder when but 18 years of age. In 1601 he attended Lodowick duke of Lennox as his chaplain, in an embassy to the court of France for confirming the ancient amity between the two nations, and returned in the ambassador's retinue through England. When he entered into the archbishopric of Glasgow, he found there was not 1000 sterling of yearly revenue left; yet such was his care for his successors, that he greatly improved it, and much to the satisfaction of his diocese. After having filled this see 11 years, he was raised to that of St Andrew's in 1613, and made primate and metropolitan of all Scotland. He presided in several assemblies for rejoining the ancient discipline, and bringing the church of Scotland to some degree of uniformity with that of England. He continued in high esteem with King James I. nor was he less valued by

Spot v.
||
Spray.

King Charles I. who was crowned by him in 1633, in the abbey-church of Holyroodhouse. In 1635, upon the death of the earl of Kinnoul chancellor of Scotland, our primate was advanced to that post; but had scarcely held it four years, when the confusions beginning in Scotland, he was obliged to retire into England; and being broken with age, grief, and sickness, died at London in 1639, and was interred in Westminster-abbey. He wrote *A History of the Church of Scotland* from the year 203 to the reign of King James VI. in folio.

SPOUT, or *Water-Spout*. See *WATER-Spout*.

SPOUT-fish. See *SOLES*, *CONCHOLOGY*. *Index*.

SPRAT, Dr THOMAS, bishop of Rochester, was born in 1636. He had his education at Oxford, and after the Restoration entered into holy orders. He became fellow of the Royal Society, chaplain to George duke of Buckingham, and chaplain in ordinary to King Charles II. In 1667 he published the *History of the Royal Society*, and a *Life of Mr Cowley*; who, by his last will, left to his care his printed works and *MISS*, which were accordingly published by him. In 1668 he was installed prebendary of Westminster; and in 1680, was appointed canon of Windsor; in 1683, dean of Westminster; and in 1684, consecrated to the bishopric of Rochester. He was clerk of the closet to King Jas. II.; in 1685, was made dean of the chapel royal; and the year following, was appointed one of the commissioners for ecclesiastical affairs. In 1692 his lordship, with several other persons, was charged with treason by two men, who drew up an accusation, in which they whose names were subscribed declared their resolution to restore King James; to seize the prince of Orange, dead or alive; and to be ready with 30,000 men to meet King James when he should land. To this they put the names of Sincroft, Sprat, Marlborough, Salisbury, and others. The bishop was arrested, and kept at a messenger's, under a strict guard, for eleven days. His house was searched, and his papers seized, among which nothing was found of treasonable appearance, except one memorandum, in the following words: *Thorough-paced doctrine*. Being asked at his examination the meaning of the words, he said that, about 20 years before, curiosity had led him to hear Daniel Burgess preach; and that being struck with his account of a certain kind of doctrine, which he said *entered at one ear, and pacing through the head went out at the other*, he had inserted the memorandum in his table-book, that he might not lose the substance of so strange a sermon. His innocence being proved, he was set at liberty, when he published an account of his examination and deliverance; which made such an impression upon him, that he commemorated it through life by an yearly day of thanksgiving. He lived to the 79th year of his age, and died May 20. 1713. His works, besides a few poems of little value, are, "The History of the Royal Society;" "The Life of Cowley;" "The Answer to Sorbiere;" "The History of the Rye-house Plot;" "The Relation of his own Examination;" and a volume of "Sermons." Dr Johnson says, "I have heard it observed with great justice, that every book is of a different kind, and that each has its distinct and characteristic excellence."

SPRAT. See *CLUPEA*, *ICHTHYOLOGY*. *Index*.

SPRAY, the sprinkling of the sea, which is driven from the top of a wave in stormy weather. It differs from spout-dropt, as being only blown occasionally from

the broken surface of a high wave; whereas the latter continues to fly horizontally along the sea, without intermission, during the excess of a tempest or hurricane.

Spray,
Spring.

SPRING, in *Natural History*, a fountain or source of water rising out of the ground.

Many have been the conjectures of philosophers concerning the origin of fountains, and great pains have been taken both by the members of the Royal Society and those of the Academy of Sciences at Paris, in order to ascertain the true cause of it. It was Aristotle's opinion, and held by most of the ancient philosophers after him, that the air contained in the caverns of the earth, being condensed by cold near its surface, was thereby changed into water; and that it made its way through, where it could find a passage. But we have no experience of any such transmutation of air into water.

Those who imagine that fountains owe their origin to waters brought from the sea by subterraneous ducts, give a tolerable account how they lose their saltness by percolation as they pass through the earth: but they find great difficulty in explaining by what power the water rises above the level of the sea to near the tops of mountains, where springs generally abound; it being contrary to the laws of hydrostatics, that a fluid should rise in a tube above the level of its source. However, they have found two ways whereby they endeavour to extricate themselves from this difficulty. The one is that of Des Cartes, who imagines, that after the water is become fresh by percolation, it is raised out of the caverns of the earth in vapour towards its surface; where meeting with rocks near the tops of mountains in the form of arches or vaults, it sticks to them, and runs down their sides, (like water in an alembic), till it meets with proper receptacles, from which it supplies the fountains. Now this is a mere hypothesis, without foundation or probability: for, in the first place, we know of no internal heat of the earth to cause such evaporation; or if that were allowed, yet it is quite incredible that there should be any caverns so smooth and void of protuberances as to answer the ends of an alembic, in collecting and condensing the vapours together in every place where fountains arise. There are others (as Varenus, &c.) who suppose that the water may rise through the pores of the earth, as through capillary tubes by attraction. But hereby they show, that they are quite unacquainted with what relates to the motion of a fluid through such tubes: for when a capillary tube opens into a cavity at its upper end, or grows larger and larger, so as to cease to be capillary at that end, the water will not ascend through that tube into the cavity, or beyond where the tube is capillary; because that part of the periphery of the cavity, which is partly above the surface of the water and partly below it, is not of the capillary kind. Nay, if the cavity is continually supplied with water, it will be attracted into the capillary tube, and run down it as through a funnel, if the lower end is immersed in the same fluid, as in this case it is supposed to be.

It has been a generally received opinion, and much espoused by Mariotte (a diligent observer of nature), that the rise of springs is owing to the rains and melted snow. According to him, the rain-water which falls upon the hills and mountains, penetrating the surface,

meets

meets with clay or rocks contiguous to each other; along which it runs, being unable to penetrate them, till, being got to the bottom of the mountain, or to a considerable distance from the top, it breaks out of the ground, and forms springs.

In order to examine this opinion, Mr Perrault, De la Hire, and D. Sideléau, endeavoured to make an estimate of the quantity of rain and snow that falls in the space of a year, to see whether it would be sufficient to afford a quantity of water equal to that which is annually discharged into the sea by the rivers. The result of their inquiries was, that the quantity of rain and snow which fell in a year into a cylindrical vessel would fill it (if secured from evaporating) to the height of about nineteen inches. Which quantity D. Sideléau showed, was not sufficient to supply the rivers; for that those of England, Ireland, and Spain, discharge a greater quantity of water annually, than the rain, according to that experiment, is able to supply. Besides which, another observation was made by them at the same time, viz. that the quantity of water raised in vapour, one year with another, amounted to about thirty-two inches, which is thirteen more than falls in rain: a plain indication that the water of fountains is not supplied by rain and melted snow.

Thus the true cause of the origin of fountains remained undiscovered, till Dr Halley, in making his celestial observations upon the tops of the mountains at St Helena, about 800 yards above the level of the sea, found, that the quantity of vapour which fell there (even when the sky was clear) was so great, that it very much impeded his observations, by covering his glasses with water every half quarter of an hour; and upon that he attempted to determine by experiment the quantity of vapour exhaled from the surface of the sea, as far as it rises from heat, in order to try whether that might be a sufficient supply for the water continually discharged by fountains. The process of his experiment was as follows: He took a vessel of water salted to the same degree with that of sea water, in which he placed a thermometer; and by means of a pan of coals brought the water to the same degree of heat, which is observed to be that of the air in our hottest summer; this done, he fixed the vessel of water with the thermometer in it to one end of a pair of scales, and exactly counterpoised it with weights on the other; then, at the end of two hours, he found, by the alteration made in the weight of the vessel, that about a sixtieth part of an inch of the depth of the water was gone off in vapour; and therefore, in twelve hours, one tenth of an inch would have gone off. Now this accurate observer allows the Mediterranean sea to be forty degrees long; and four broad, (the broader parts compensating for the narrower, so that its whole surface is 160 square degrees); which, according to the experiment, must yield at least 5,280,000,000 tons of water: In which account no regard is had to the wind and the agitation of the surface of the sea, both which undoubtedly promote the evaporation.

It remained now to compare this quantity of water with that which is daily conveyed into the same sea by the rivers. The only way to do which was to compare them with some known river; and accordingly he takes his computation from the river Thames; and, to avoid

all objections, makes allowances, probably greater than what were absolutely necessary.

The Mediterranean receives the following considerable rivers, viz. the Iberus, the Rhone, the Tyber, the Po, the Danube, the Neiter, the Borythenes, the Tanais, and the Nile. Each of these he supposes to bring down ten times as much water as the Thames, whereby he allows for smaller rivers which fall into the same sea. The Thames, then, he finds by measurement to discharge about 20,300,000 tons of water a-day. If therefore the above-mentioned rivers yield ten times as much water as the Thames doth, it will follow, that all of them together yield but 182 millions of tons in a day, which is but little more than one-third of what is proved to be raised in vapour out of the Mediterranean in the same time. We have therefore from hence a source abundantly sufficient for the supply of fountains.

Now having found that the vapour exhaled from the sea is a sufficient supply for the fountains, he proceeds in the next place to consider the manner in which they are raised; and how they are condensed into water again, and conveyed to the sources of springs.

In order to this he considers, that if an atom of water was expanded into a shell or bubble, so as to be ten times as big in diameter as when it was water, that atom would become specifically lighter than air; and therefore would rise so long as the warmth which first separated it from the surface of the water should continue to distend it to the same degree; and consequently, that vapours may be raised from the surface of the sea in that manner, till they arrive at a certain height in the atmosphere, at which they find air of equal specific gravity with themselves. Here they will float till, being condensed by cold, they become specifically heavier than the air, and fall down in dew; or being driven by the winds against the sides of mountains (many of which far surpass the usual height to which the vapours would of themselves ascend), are compelled by the stream of the air to mount up with it to the tops of them; where being condensed into water, they presently precipitate, and gleeing down by the crannies of the stones, part of them enters into the caverns of the hills; which being once filled, all the overplus of water that comes thither runs over by the lowest place, and breaking out by the sides of the hills forms single springs. Many of these running down by the valleys between the ridges of the hills, and coming to unite, form little rivulets or brooks: many of these again meeting in one common valley, and gaining the plain ground, being grown less rapid, become a river; and many of these being united in one common channel, make such streams as the Rhine and the Danube; which latter, he observes, one would hardly think to be a collection of water condensed out of vapour, unless we consider how vast a tract of ground that river drains, and that it is the sum of all those springs which break out on the south side of the Carpathian mountains, and on the north side of the immense ridge of the Alps, which is one continued chain of mountains from Switzerland to the Black sea.

Thus one part of the vapours which are blown on the land is returned by the rivers into the sea from whence it came. Another part falls into the sea before it reaches the land; and this is the reason why the rivers do not return so much water into the Mediter-

Spring.

near as is raised in vapour. A third part falls on the low lands, where it affords nourishment to plants; yet it does not rest there, but is again exhaled in vapour by the action of the sun, and is either carried by the winds to the sea to fall in rain or dew there, or else to the mountains to become the sources of springs.

However, it is not to be supposed that all fountains are owing to one and the same cause; but that some proceed from rain and melted snow, which, subsiding through the surface of the earth, makes its way into certain cavities, and thence issues out in the form of springs; because the waters of several are found to increase and diminish in proportion to the rain which falls: that others again, especially such as are salt, and spring near the sea-shore, owe their origin to sea-water percolated through the earth; and some to both these causes: though without doubt most of them, and especially such as spring near the tops of high mountains, receive their waters from vapours, as before explained.

This reasoning of Dr Halley's is confirmed by more recent observations and discoveries. It is now found, that though water is a tolerable conductor of the electric fluid, dry earth is an electric *per se*, consequently the dry land must always be in an electrified state compared with the ocean, unless in such particular cases as are mentioned under the article EARTHQUAKE, N^o 82. It is also well known, that such bodies as are in an electrified state, whether *plus* or *minus*, will attract vapour, or other light substances that come near them. Hence the vapours that are raised from the ocean must necessarily have a tendency to approach the land in great quantity, even without the assistance of the wind, though this last must undoubtedly contribute greatly towards the same purpose, as Dr Halley justly observes. In like manner, the higher grounds are always in a more electrified state than the lower ones: and hence the vapours having once left the ocean and approached the shore, are attracted by the high mountains; of which Mr Pennant gives an instance in Snowdon. Hence we may see the reason why springs are so common in the neighbourhood of mountains, they being so advantageously formed in every respect for collecting and condensing the vapours into water.

The heat of springs is generally the same with the mean temperature of the atmosphere. The mean temperature of the south of England is 48°; in Scotland, near Edinburgh, it is 45°; in the north of Ireland it is 48°, and on the south coast about 51°. At Upsal, in Sweden, it is 43°, and in Paris 53°. According to accurate experiments made by eminent philosophers, the heat of the springs in these different countries corresponds with the medium temperature. We have not heard that similar experiments have been made in other countries, or we should have been careful to collect them. We do not, however, doubt but they have been made in most countries of Europe; yet we suspect little attention has been paid to this subject within the tropical regions.

Though this coincidence of the heat of springs with the mean temperature of the climate where they flow, seems to be a general fact, yet it admits of many exceptions. In many parts of the world there are springs which not only exceed the mean temperature, but even the strongest meridian heat ever known in the torrid regions. The following table will give a distinct notion

of the degrees of heat which different springs have been found to possess, according to the experiments of philosophers. It is necessary to remark, that experiments made upon the same springs, made by different persons, vary a little from one another, which may be owing to many accidents easily accounted for. Where this is the case, we shall mention both the lowest and highest degree of heat which has been ascribed to the same spring, according to Fahrenheit's thermometer.

Spring.

Places.	Springs.	Highest degree of heat.	Lowest degree of heat.
Bristol,	St Vincent's or the hot well,	84	76
Buxton,	Gentleman's bath,	82	
Matlock,		69	
Bath,	King's bath,	119	113
Aix-la-Chapelle,		146	136
Barege,		122	
Pisa,		124	
Caroline baths in Prudel or fur-			
Bohemian,	ous,	165	
Iceland,	Geyzer,	212	

In cold countries, where congelation takes place, the heat of the earth is considerably above the freezing point, and continues so through the whole year. From experiments that have been made in mines and deep pits, it appears that this heat is uniform and stationary at a certain depth. But as the heat of these springs far exceeds the common heat of the internal parts of the earth, it must be occasioned by causes peculiar to certain places; but what these causes are it is no easy matter to determine. We are certain, indeed, that hot springs receive their heat from some subterranean cause; but it is a matter of difficulty to investigate how this heat is produced and preserved. Theories, however, have been formed on this subject. The subterranean heat has been ascribed to the electrical fluid, and to a great body of fire in the centre of the earth: But we suspect that the nature of the electrical fluid and its effects are not sufficiently understood. As to the supposition that the heat of springs is owing to a central fire, it is too hypothetical to require any refutation. From what then does this heat originate, and whence is the fuel which has produced it for so many ages? To enable us to answer these questions with precision, more information is necessary than we have hitherto obtained respecting the structure of the internal parts of the earth. It is peculiarly requisite that we should be made acquainted with the fossils which are most common in those places where hot springs abound. We should then perhaps discover that hot springs always pass through bodies of a combustible nature. It is well known to chemists, that when water is mixed with the vitriolic acid, a degree of heat is produced superior to that of boiling water. It is also an established fact, that when water meets with pyrites, that is, a mixture of sulphur and iron, a violent inflammation takes place. If, therefore, we could prove that these materials exist in the strata from which hot springs are derived, we should be enabled to give a satisfactory account of this curious phenomenon. As some apology for this supposition, we may add, that most of the hot springs mentioned above have been found by analysis to be impregnated with sulphur, and some of them with iron.

Spring
of
Spruce-
Beer.Gray's Let-
ters from
Germany
and Swit-
zerland.

iron. It may, however, be acknowledged, that the hot springs of Iceland, which are 212°, the heat of boiling water, according to an accurate analysis of their contents by the ingenious Dr Black, were neither found to contain iron nor sulphur. It will therefore, perhaps, be necessary that we should wait with patience, and continue to collect facts, till the sciences of chemistry and mineralogy shall be so far advanced as to enable us to form a permanent theory on this subject.

Springs are of different kinds. Some are perennial, or continue to flow during the whole year; others flow only during the rainy season; some ebb and flow. At Torbay there is one of this kind, which ebbs and flows five or six inches every hour. There is another near Carrio in Italy, which ebbed and flowed three times a-day in the time of Ptolemy, and continues to do so still. A spring near Henly sometimes flows for two years together, and then dries up for an equal period. For the ingredients found in springs, see *MINERAL-WATERS*.

SPRING, in *Mechanics*, denotes a thin piece of tempered steel, or other elastic substance, which being wound up serves to put machines in motion by its elasticity, or endeavours to unbend itself; such is the spring of a watch, clock, or the like.

SPRING, *Ver*, in cosmography, denotes one of the seasons of the year; commencing, in the northern parts of the world, on the day the sun enters the first degree of Aries, which is about the 12th day of March, and ending when the sun leaves Gemini; or, more strictly and generally, the spring begins on the day when the distance of the sun's meridian altitude from the zenith, being on the increase, is at a medium between the greatest and least. The end of the spring coincides with the beginning of summer. See *SUMMER*.

ELATER SPRING, in *Physic*, denotes a natural faculty or endeavour of certain bodies, to return to their first state, after having been violently put out of it by compressing, or bending them. This faculty is, by philosophers, usually denominated *elastic force*, or *elasticity*.

SPRING-TIDE. See *ASTRONOMY INDEX*, and *TIDE*.

BURNING SPRINGS. See *BURNING-SPRINGS*.

SPRINGER, or *SPRING-BIRD*. See *CAPRA*, *MAMMALIA INDEX*.

SPRIT, a small boom or pole which crosses the tail of a boat diagonally, from the mast to the upper hindmost corner of the sail, which it is used to extend and elevate; the lower end of the spirit rests in a sort of wreath or collar called the *smotter*, which encircles the mast in that place.

SPRITSAIL. See *SAIL* and *SHIP*.

SPRITSAIL-Topfail. See *SAIL* and *SHIP*.

SPRUCE-TREE. See *PINUS*, *BOTANY INDEX*.

SPRUCE-Beer, a cheap and wholesome liquor, which is thus made: Take of water 16 gallons, and boil the half of it. Put the water thus boiled, while in full heat, to the reserved cold part, which should be previously put into a barrel or other vessel; then add 16 pounds of treacle or molasses, with a few table spoonsful of the essence of sorrel, stirring the whole well together; add half a pint of yeast, and keep it in a moderate situation, with the bung hole open, for two days, till the fermentation be abated. Then close it up or bottle it off, and it will be fit for being drunk in a few days afterwards. In North America, and perhaps in other

countries, where the black and white spruce firs abound, instead of adding the *essence* of the spruce at the same time with the molasses, they make a decoction of the leaves and small branches of these trees, and find the liquor equally good. It is a powerful antifebrile, and may prove very useful in long sea voyages.

SPUNGE, or *SPONGE*. See *SPONGIA*.

SPUNGING, in *Gunnery*, the cleaning of the inside of a gun with a sponge, in order to prevent any sparks of fire from remaining in it, which would endanger the life of him that should load it again.

SPUN-YARN, among sailors, is a kind of line made from rope yarn, and used for seizing or fastening things together.

SPUNK. See *BOLETUS*, *BOTANY INDEX*.

SPUR, a piece of metal consisting of two branches encompassing a horse's heel, and a rowel in form of a star, advancing out behind to prick the horse.

SPUR-Winged Water-Ilen. See *PARRA*, *ORNITHOLOGY INDEX*.

SPURGE. See *EUPHORBIA*.

SPURGE-Laurel. See *DAPHNE*.

SPURREY. See *SERGULA*.

} *BOTANY INDEX*.

SPY, a person hired to watch the actions, motions, &c. of another; particularly what passes in a camp. When a spy is discovered, he is hanged immediately.

SQUADRON, in military affairs, denotes a body of horse whose number of men is not fixed; but is usually from 100 to 200.

SQUADRON of Ships, either implies a detachment of ships employed on any particular expedition, or the third part of a naval armament.

SQUADS, in a military sense, are certain divisions of a company into so many squads, generally into three or four. The use of forming companies into as many squads of inspection as it has sergeants and corporals, is proved by those regiments who have practised that method; as by it the irregularity of the soldiers is considerably restrained, their dress improved, and the discipline of the regiment in general most remarkably forwarded. Every officer should have a roll of his company by squads.

SQUALL, a sudden and violent blast of wind, usually occasioned by the interruption and reverberation of the wind from high mountains. These are very frequent in the Mediterranean, particularly that part of it which is known by the name of the *Levant*, as produced by the repulsion and new direction which the wind receives in its passage between the various islands of the Archipelago.

SQUALUS, the *SHARK*; a genus of fish arranged by Linnæus under the class of amphibia, and the order of mantes, but by Gmelin referred to the class of fishes, and order of chondropterygii. See *ICHTHYOLOGY INDEX*.

SQUAMARIA. See *LATHRÆA*, *BOTANY INDEX*.

SQUAMOUS, in *Anatomy*, a name given to the scurfous or scaly fibres of the skull, because composed of squame or scales like those of fishes.

SQUARE, in *Geometry*, a quadrilateral figure both equilateral and equiangular. See *GEOMETRY*.

SQUARE-Root. See *ALGEBRA* and *ARITHMETIC*, N° 27, and 34.

Hollow SQUARE, in the military art, a body of foot drawn

Spruce-
Beer
||
SQUIRE.

Squaring
Squaring

drawn up with an empty space in the middle, for the colours, drums, and baggage, faced and covered by the pikes every way to keep off the horse.

SQUARE, among *Mechanics*, an instrument consisting of two rules or branches, fastened perpendicularly at one end of their extremities, so as to form a right angle. It is of great use in the description and mensuration of right angles, and laying down perpendiculars.

T SQUARE, or *Tee Square*, an instrument used in drawing, so called from its resemblance to the capital letter T.

SQUARE-RIGGED, an epithet applied to a ship whose yards are very long. It is also used in contradistinction to all vessels whose sails are extended by stays or lateen-yards, or by booms and gaffs; the usual situation of which is nearly in the plane of the keel; and hence,

SQUARE-SAIL, is a sail extended to a yard which hangs parallel to the horizon, as distinguished from the other sails which are extended by booms and stays placed obliquely. This sail is only used in fair winds, or to leeward under in a tempest. In the former case, it is furnished with a large additional part called the *bonnet*, which is then attached to its bottom, and removed when it is necessary to *SCUD*. See *SCUDDING*.

SQUARING, or *QUADRATURE* of the Circle, signifies the finding a square exactly equal to the area of a given circle. This problem however has not been, and probably cannot be, strictly resolved by the commonly admitted principles of geometry; mathematicians having hitherto been unable to do more than to find a square that shall differ from the area of any proposed circle by as small a quantity as they please. The quadrature of the circle is a problem of the same degree of difficulty, and indeed may be regarded as identical with another geometrical problem, namely, the *Rectification of the circle*, or the finding a straight line equal to its circumference; for the area of a circle is equal to that of a rectangle contained by the radius and a straight line equal to half the circumference (GEOMETRY, Sect. VI. Prop. 3.): therefore, if a straight line exactly equal to the circumference could be found, a rectilinear space precisely equal to the area might also be found, and the contrary. But although no perfectly accurate resolution of the problem has been obtained under either form, we can always find approximate values of the area and circumference; and therefore it is now customary to apply the terms *quadrature* and *rectification* of the circle also to these.

The problem of the quadrature of the circle appears to have engaged the attention of geometers at a very early period; for we are told that Anaxagoras, who lived about 500 years before Christ, attempted its solution while confined in prison on account of his philosophical opinions. We are ignorant of the result of his researches; but although we cannot suppose they were attended with any success, we may reasonably conclude that we are indebted to them for the discovery of some of the properties of the figure, which are now known as elementary propositions in geometry.

Hippocrates of Chios was likewise engaged in trying to resolve the same problem, and it was no doubt in the course of his inquiries into this subject that he discovered the quadrature of the curvilinear space, which is now known by the name of the *Lune* of Hippocrates. The

nature of this discovery may be briefly explained as follows. Let ABCD be a circle (Plate D. fig. 1.), H its centre, AC its diameter, ADC a triangle inscribed in the femicircle, having its sides AD, DC equal to one another. On D as a centre, with DA or DC as a radius, let the quadrantal arch AEC be described, then shall the curvilinear space bounded by the femicircle ABC and the quadrantal arch AEC (which is the *Lune* of Hippocrates) be equal to the rectilinear triangle ADC. For because circles are to one another as the squares of the radii (GEOMETRY, Sect. VI. Prop. 4.); the circle having DA for its radius will be to the circle having HA for its radius as the square of DA to the square of HA, that is, as 2 to 1; hence the former of these circles will be double the latter, and consequently one fourth of the former will be equal to one half of the latter; that is, the quadrant AEC will be equal to the femicircle ABC; from these equals take away the common space bounded by the diameter AC and the arch AEC, and there will remain the triangle ADC equal to the lunular space AECBA.

Although Hippocrates's discovery has led to no important conclusion either relating to the quadrature of the circle or that of any other curve, yet at the time it was made it might be regarded as of some consequence, chiefly because it shewed the possibility of exhibiting a rectilinear figure equal to a space bounded by curve lines, a thing which we have reason to suppose was then done for the first time, and might have been fairly doubted, considering the insuperable difficulty that was found to attend the quadrature of the circle or its rectification.

Aristotle speaks of two persons, viz. Bryson and Antiphon, who about his time, or a little earlier, were occupied with the quadrature of the circle. The former appears, according to the testimony of Alexander Aropeides, to have erred most egregiously; he having concluded that the circumference was exactly $3\frac{1}{2}$ times the diameter. And the latter seems to have proceeded pretty much in the same manner as Archimedes afterwards did in squaring the parabola, that is, by first inscribing a square in the circle, then an isosceles triangle in each of the segments of the curve, having for its base a side of the square; and next again a series of triangles in the segments, having for their bases the sides of the former series, and so on: this mode of procedure however, could not be attended with any success, as it is well known that the spaces thus formed do not, as in the case of the parabola, admit of being absolutely summed.

It may naturally be supposed that Archimedes exerted his utmost efforts to resolve this problem; and probably it was only after long meditation on the subject that he lost all hopes of success, and contented himself with that approximation to the ratio of the diameter to the circumference which is contained in his treatise *De Circuli Dimensione*, which has been preserved from the period in which he wrote, about 250 years before Christ, to the present times. He found his approximation to the ratio, by supposing a regular polygon of 96 sides to be described about the circle, and another of the same number of sides to be inscribed in it, and by shewing that the perimeter of the circumscribing polygon was less than $3\frac{1}{7}$, or $3\frac{1}{2}$ times the diameter, but that the perimeter of the inscribed figure was greater than $3\frac{1}{7}$ times the

Squaring

Plate
D.
Fig. 1.

SQUARING or Quadrature of the Circle

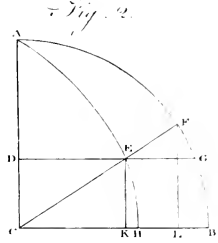
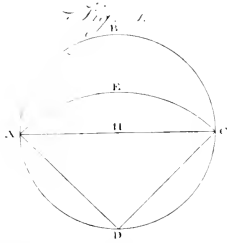

STARCH manufacture of.

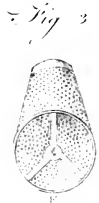
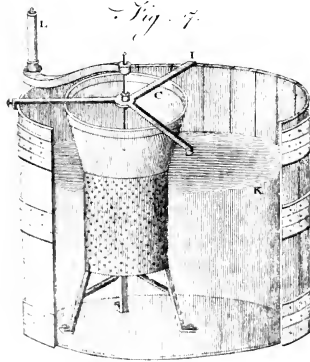
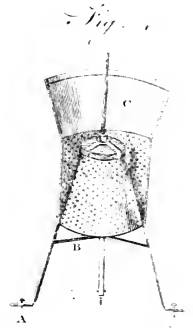
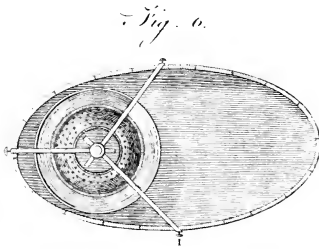

Squaring. the diameter; now the circumference of the circle being 1½ times than the perimeter of the one polygon but greater than that of the other, it follows that the circumference must be less than 3½ times the diameter, but greater than 3¼ times; so that, taking the first of these limits as being expressed by the smallest numbers, the circumference will be to the diameter as 3½ to 1, or as 22 to 7 nearly.

Although the approximate ratio investigated by Archimedes be the oldest known to have been found in the western world, yet one more accurate seems to have been known at a much earlier period in India. This we learn from the *Institutes of Akbar* (*Ayzen Sibbery*) where it is said that the Hindoos suppose the diameter of a circle to be to its circumference as 1252 to 3927. Now this ratio, which is the same as that of 1 to 3 1416, when found in the simplest and most elementary manner must have required the inscription of a polygon of 768 sides in the circle, and must have been attended with nine extractions of the square root, each carried as far as ten places of figures.

We learn from Simplicius that Nicomedes and Apollonius both attempted to square the circle, the former by means of a curve which he called the *Quadratrix*; the invention of which, however, is ascribed to Dinostratus, and the latter also by the help of a curve denominated the *sister* to the tortuous line or *spiral*, and which was probably no other than the *quadratrix* of Dinostratus; the nature of which, and the manner of its application to the subject in question, we shall briefly explain.

Let AFB be a quadrant of a circle (fig. 2.) and C its centre; and conceive the radius CF to revolve uniformly about C from the position CA until at last it coincide with CB; while at the same time a line DG is carried with an uniform motion from A towards CB; the former line continuing always parallel to the latter, until at last they coincide; both motions being supposed to begin and end at the same instant. Then the point E in which the revolving radius CF and the moveable line DG intersect one another will generate a certain curve line AEH, which is the *Quadratrix* of Dinostratus.

Draw EK, FL both perpendicular to CB; then because the radius AC and the quadrantal arch AFB are uniformly generated in the same time by the points D and F, the contemporaneous spaces described will have to one another the same ratio as the whole spaces; that is, AD : AF :: AC : AB; hence we have AC : AB :: DC, or EK : FB. Now as the moveable point F approaches to B, the ratio of the straight line EK to the arch FB will approach to, and will manifestly be ultimately the same as the ratio of the straight line EK to the straight line FL, which again is equal to the ratio of CE to CF; therefore the ratio of the radius AC to the quadrantal arch AFB is the limit of the ratio of CE to CF, and consequently equal to the ratio of CH to CB, H being the point in which the *quadratrix* meets CB. Since therefore CH : CB :: CA or CB : quad. arch AFB, if by any means we could determine the point H, we might then find a straight line equal to the quadrantal arch, (by finding a third proportional to CH and CB) and consequently a straight line equal to the circumference. The point H, however, cannot be determined by a geometrical construction, and therefore

all the ingenuity evinced by the person who first thought of this method of rectifying the circle (which certainly is considerable) has been unavailing.

The Arabs, who succeeded the Greeks in the cultivation of the sciences, would no doubt have their pretended squares of the circle. We however know nothing more than that some one of them believed he had discovered that the diameter being unity, the circumference was the square root of 10; a very gross mistake; for the square root of 10 exceeds 3.162; but Archimedes had demonstrated that the circumference was less than 3.143.

It appears that, even during the dark ages, some attempts were made at the resolution of this famous problem, which however have always remained in manuscripts buried in the dust of old libraries. But upon the revival of learning the problem was again agitated by different writers, and particularly by the celebrated Cardinal De Cusa, who distinguished himself by his unfortunate attempt to resolve it. His mode of investigation, which had no solid foundation in geometry, led him to conclude, that if a line equal to the sum of the radius of a circle and the side of its inscribed square were made the diameter of another circle, and an equilateral triangle were inscribed in this last, the perimeter of this triangle would be equal to the circumference of the other circle. This pretended quadrature of the cardinal's was refuted by Regiomontanus; and indeed the talk was not difficult; for, according to his construction, the diameter being 1, the circumference was greater than 3½; a conclusion which must be absurd, seeing that Archimedes had demonstrated that it must be less than that number.

It would be trespassing too much upon the patience of our readers, were we to mention all the absurd and erroneous attempts which have been made during the last three centuries to square the circle. In a supplement to Montucla's excellent work, *Histoire des Mathematiques*, we find upwards of forty pretenders to the honour of this discovery enumerated. These were almost all very ignorant of geometry; and many of them were wild visionaries, pretending to discover inexplicable relations between the plain truths of mathematics and the most mysterious doctrines of religion. If those who have sought the quadrature of the circle had been previously initiated in the doctrines of geometry, although they missed attaining the object they had in view, yet they could not have failed to have extended the boundaries of the science by the discovery of many new propositions. From such persons, however, as have generally pursued this inquiry, no improvement whatever of the science was to be expected; although, indeed, in some instances, it has derived advantage from the labours of such as have undertaken to expose the absurdity of their conclusions; as in the case of Metius, who in refuting the quadrature of one *Simon à Quercu*, found a much nearer approximation to the ratio of the diameter to the circumference than had been previously known, at least in Europe, viz. that of 113 to 355, which reduced to decimals is the same as the ratio of 1 to 3.1415929, differing from the truth only in the seventh place of decimals.

Among the most remarkable of those who have recorded their own folly by publishing erroneous resolutions of the problem, we may reckon the celebrated Joseph Scaliger. Full of self conceit; he believed that, entering

Squaring—tering upon the study of geometry, he could not fail to surmount by the force of his genius those obstacles which had completely stopp'd the progress of all preceding inquirers. He gave the result of his meditations to the world in 1592, under the title *Nova Cylometria*; but he was refuted by Clavius, by Vieta, and others, who shewed that the magnitude he had assigned to the circumference was a little *less* than the perimeter of the inscribed polygon of 192 sides, which proved beyond a doubt that he was wrong. Scaliger, however, was not to be convinced of the absurdity of his conclusion; and indeed, in almost every instance, pretenders to this discovery have not been more remarkable for their folly in committing absurd blunders, than for their obstinacy in maintaining that they were in the right, and all who held a contrary opinion in an error.

The famous Hobbes came also upon the field about the year 1652, with pretensions not only to the quadrature of the circle, but also to the trisection of an angle, the rectification of the parabola, &c.; but his pretended solutions were refuted by Dr Wallis. And this circumstance afforded him occasion to write not only against geometers, but even against the science of geometry itself.

We find it recorded by *Montucla*, as a sort of phenomenon, that one Richard White, an English Jesuit, having happened upon what he conceived to be a quadrature of the circle, which he published under the title, *Chrysaëpis seu Quadratura Circuli*, suffered himself at last to be convinced by some of his friends that he was wrong both in his quadrature of the circle, and in his rectification of the spiral. But a solution of the same problem found out by one Mathulem de Lyons, did not produce in the end so much advantage to its author. This man in 1728 announced to the learned world that he had discovered both the quadrature of the circle and a perpetual motion; and he was so certain of the truth of these discoveries, that he assigned 1000 *écus* (about 125*l.*) to be paid to any one who should demonstrate that he was deceived in either. The task was not difficult. Nicole of the Academy of Sciences demonstrated that he was wrong, and he himself allowed it; but he hesitated to pay the money, which Nicole had relinquished in favour of the *Hôtel Dieu* of Lyons. The affair went before a court of justice, which adjudged the money to be paid, as Nicole had destined it, to the poor. At a later period, viz. in 1753, the Chevalier de Causans, a French officer, and a man who was never expected to be a mathematician, suddenly found a quadrature of the circle in procuring a circular piece of turf to be cut; and rising from one truth to another, he explained by his quadrature the doctrine of original sin, and the Trinity. He engaged himself by a public writing to deposit with a notary the sum of 300,000 francs, to be wagered against such as should oppose him, and he actually lodged 100,000, which were to devolve to him who should demonstrate his error. This was easily done, as it resulted from his discovery that a circle was equal to its circumscribing square, that is, a part to the whole! Some persons came forward to answer his challenge, and in particular a young lady sued him at one of the courts of law; but the French king judged that the Chevalier's fortune ought not to suffer on account of his whim; for, setting aside this piece of folly, in every other respect he was a worthy man. The pro-

cedure was therefore stopp'd, and the wager declared void.

We shall not enter farther into the history of these vain and absurd attempts to resolve this important problem, but proceed to state what has actually been done by men of sound minds and real mathematical acquirements towards its solution. And in the first place it may be observed that the problem admits of being proposed under two different forms: for it may be required to find either the area of the whole circle, or, which is the same thing, the length of the whole circumference; or else to find the area of any proposed sector or segment, or, which is equivalent, the length of the arch of the sector or segment. The former is termed the *definite* and the latter the *indefinite* quadrature of the circle. The latter evidently is more general than the former, and includes it as a particular case. Now if we could find by any means a finite algebraic equation that should express the relation between any proposed arch of a circle, and some known straight line, or lines, the magnitude of one or more of which depended on that arch, then we would have an absolute rectification of the arch, and consequently a rectification or quadrature also of the whole circle. We here speak of an analytical solution of the problem; and the ancients, however, who were almost entirely ignorant of this branch of mathematical science, must have endeavoured to treat it entirely upon geometrical principles. It is now well known, however, that all geometrical problems may be subjected to analysis; and that it is only by such a mode of proceeding they have in many cases been resolved.

With respect to the *definite* quadrature of the circle, it is commonly understood that no unexceptionable demonstration of its impossibility has hitherto been published. It is true that James Gregory, in his *vera circuli et Hyperbolæ quadratura*, has given what he considered as such a demonstration; but it has been objected to, particularly by Huygens, one of the best geometers of his time. We are, however, certain that the ratio of the diameter to the circumference, as also, that the ratio of the square of the diameter to the square of a straight line equal to the circumference, cannot be expressed by rational numbers, for this has been strictly demonstrated by Lambert in the Berlin Memoirs for 1761. A demonstration is also given in Legendre's *Geometrie*. As to the *indefinite* quadrature, if Newton's demonstration of the 29th lemma of the first book of his *Principia* be correct, the thing ought to be absolutely impossible. For the object of that proposition is to prove that in no oval figure whatever, that returns into itself, can the area cut off by straight lines at pleasure be universally found by an equation of a finite dimension, and composed of a finite number of terms. If this be true, then it will be impossible to express any sector of a circle taken at pleasure in finite terms. It is however to be remarked, that the accuracy of the reasoning by which Newton has attempted to establish the truth of the general proposition has been questioned by no less a geometer than D'Alembert; and indeed we know one oval curve, which returns into itself, and which according to Newton's proposition ought therefore not to admit of an indefinite quadrature; yet this is by no means the case, for it does really admit of such a quadrature. The curve we mean is the *lemniscata*, the equation of which is $(x^2 + y^2)^2 = a^2(x^2 - y^2)$, where x and y denote its coordinates,

Squaring ordinates, and s is put for a given line. The figure of the curve is nearly that of the numeral character 8. Upon the whole then we may infer that an unexpected demonstration of the impossibility of expressing either the whole circle, or any proposed sector of it, by a finite equation, is still among the *diffiderata* of mathematics.

We come now to speak of the different methods which have been found for approximating to the area or to the circumference. We have already noticed the approximation to the ratio of the diameter to the circumference found by Archimedes, and the earlier and more accurate approximation of the Indian mathematicians. Archimedes's ratio is the only one found by the ancients in the western world that has descended to modern times, and it appears to have been the most accurate known, until about the year 1535, when Metius, in refuting a pretended quadrature, found the more accurate ratio of 113 to 355, as we have already noticed. About the same time Vieta, and Adrianus Romanus published their ratios expressed in decimals, the former carrying the approximation to ten decimals instead of six, (n which was the number of accurate figures expressed by Metius's ratio), and the latter extending it to 17 figures. Vieta also gave a kind of series, which being continued to infinity, gave the value of the circle.

These approximations, however, were far exceeded by that of Ludolph Van Ceulen, who in a work published in Dutch in 1610, carried it as far as 36 figures, showing that if the diameter were unity, the circumference would be greater than 3.141592653589793, 23846,26433,83279,50258, but less than the same number with the last figure increased by an unit. This work was translated into Latin by Snellius, and published under the title, *De Circuli et Sphaeræ*. In finding this approximation, Van Ceulen followed the method of Archimedes, doubling continually the number of sides of the inscribed and circumscribed polygons, until at length he found two which differed only by an unit in the 36th place of decimals in the numbers expressing their perimeters. This, however, must have been rather a work of patience than of genius; and indeed the labour must have been prodigious. He seems to have valued highly this singular effort, for in imitation of Archimedes, whose tomb was adorned with a sphere and cylinder, in commemoration of his discovery of the proportion which these solids bear to one another, he requested that the ratio he had found might be inscribed on his tomb, which was accordingly done.

Snellius found means to abridge greatly the labour of calculation by some very ingenious theorems; and although he did not go beyond Van Ceulen, yet he verified his result. His discoveries on this subject are contained in a work called *Willebrordus Snellii Cyclo-metricus de Circuli Dimensione, &c.* *Angl. Bet.* 1621.

Descartes found also a geometrical construction, which being repeated continually, gave the circumference, and from which he might easily have deduced an expression in the form of a series.

Gregory of St Vincent distinguished himself also on this subject. It is true he committed a great error in supposing he had discovered the quadrature of both the circle and hyperbola; but he had previously made for many beautiful geometrical discoveries, deduced with

much elegance after the manner of the ancients, that it would be wrong to number him with those absurd pretenders which we have already noticed. Gregory's mistake was the cause of a sharp controversy carried on between his disciples on the one side, and by Huygens, Merseus and Leibniz on the other; and it was this that gave Huygens occasion to consider particularly the quadrature of the circle, and to investigate various new and curious theorems relating to it, which are contained in his *Theorematum de Quadratura Hyperbolæ, Ellipsos et Circuli*, 1644; and in his work *De Circuli Magnitudine Inventa*, 1654. In particular he showed, that if c denote the chord of an arch, and s its sine, then the arch itself will be greater than $c + \frac{1}{3}(c-s)$, but less

than $c + \frac{4c+s}{2c+3s} \times \frac{1}{3}(c-s)$; he also showed that the arch is less than the sum of $\frac{1}{3}$ of its sine and $\frac{1}{3}$ of its tangent. These theorems greatly lighten the labour of approximating to the ratio of the diameter to the circumference, by means of inscribed and circumscribed figures, in such that by the inscribed polygons of 6 and 12 sides, we may obtain it to the same degree of accuracy as Archimedes did by the inscribed and circumscribed polygons of 96 sides.

James Gregory, in his *Vera Circuli et Hyperbolæ Quadratura*, gave several curious theorems upon the relation of the circle to its inscribed and circumscribed polygons, and their ratios to one another; and by means of these he found with infinitely less trouble than by the ordinary methods, and even by those of Snellius, the measure of the circle as far as 25 places of figures. He gave also, after the example of Huygens, constructions for finding straight lines nearly equal to arches of a circle, and of which the degree of accuracy was greater. For example, he found that if A be put for the chord of an arch of a circle, and B for twice the chord of half the arch, and C be taken such that $A+B : B : 2B : C$, then the arch itself is nearly equal to $\frac{8C+8B-A}{15}$, but a little less, the error in the case of

a complete semicircle being less than its $\frac{1}{15380}$ part; and when the arch does not exceed 120° , it is less than its $\frac{1}{20000}$ part; and finally, for a quadrant the error is not greater than its $\frac{1}{200000}$ part. And farther, that if D be such that $A : B : B : D$, then the arch is

nearly equal to $\frac{12C+4B-D}{15}$, but a little greater, the error in the semicircle being less than its $\frac{1}{16300}$ part, and in a quadrant less than its $\frac{1}{200000}$ part.

The discoveries of De Wallis, delivered in his *Arithmetica Infinitorum* published in 1655, led him to a singular expression for the ratio of the circle to the square of its diameter. He found that the former was to the latter as 1 to the product

$$\frac{3 \times 3 \times 5 \times 5 \times 7 \times 7 \times 9 \times 9 \times 11 \times 11 \times \&c.}{2 \times 4 \times 4 \times 6 \times 6 \times 8 \times 8 \times 10 \times 10 \times 12}$$

the fractions $\frac{1}{2}, \frac{3}{4}, \frac{5}{6}, \&c.$ being supposed infinite in number. The products being supposed continued to infinity, we have the ratio exactly; but if we stop at any finite number of terms, as must necessarily be the case in its application, the result will be alternately too great and too small, according as we take an odd or an even number of terms of the numerator and denominator.

Squaring. 128 figures. But he has also been outdone; for in Radcliffe's library at Oxford, there is a manuscript in which it is carried as far as 152 figures!

Although this last series, which was first proposed by Dr Halley, gives the ratio of the diameter to the circumference with wonderful facility when compared with the operative method employed by Van Ceulen, yet others have been since found which accomplish it with still greater ease. In Halley's series we have to compute the irrational quantity $\sqrt{12}$, because of the irrational value which it was necessary to give to t in order to render it sufficiently small, and at the same time an exact part of the whole circumference; but Mr Machin contrived, by a very ingenious artifice, to reduce the computation of an arch of 45° , and consequently the length of the whole circumference, to two series which contain only rational quantities, and which at the same time converge with great rapidity. The nature of this artifice, and the manner in which it occurred to its author, is explained by Dr Hutton in his very excellent treatise on Mensuration, as follows: "Since the chief advantage (in the application of Gregory's series to the rectification of the circle) consists in taking small arches, whose tangents shall be numbers easy to manage, Mr Machin very properly considered, that since the tangent of 45° is 1, and that the tangent of any arch being given, the tangent of the double of that arch can easily be had; if there be assumed some small simple number as the tangent of an arch, and then the tangent of the double arch be continually taken, until a tangent be found nearly equal to 1, which is the tangent of 45° , by taking the tangent answering to the small difference of 45° and this multiple, there would be found two very small tangents, viz. the tangent first assumed, and the tangent of the difference between 45° and the multiple arch; and that therefore the lengths of the arches corresponding to these two tangents being calculated, and the arch belonging to the tangent first assumed being so often doubled as the multiple directs, the result, increased or diminished by the other arch, according as the multiple should be below or above it, would be the arch of 45° ."

"Having thus thought of his method, by a few trials he was lucky enough to find a number (and perhaps the only one) proper for his purpose; viz. knowing that the tangent of $\frac{1}{2}$ of 45° is nearly $\frac{1}{2}$, he assumed $\frac{1}{4}$ as the tangent of an arch. Then, since if t be the tangent of an arch, the tangent of the double arch will be $\frac{2t}{1-t^2}$, the radius being 1; the tangent of the double arch to that of which $\frac{1}{4}$ is the tangent will $\frac{1}{2}$, and the tangent of the double of this arch will be $\frac{1}{3}$, which being very nearly equal to 1, shews, that the arch which is equal to four times the first arch is very near 45° . Then, since the tangent of the difference between an arch of 45° , and an arch greater than 45° , whose tangent is T , is $\frac{T-1}{T+1}$, we shall have the tangent of the difference between 45° , and the arch whose tangent is $\frac{1}{3}$ equal to $\frac{1}{4}$. Now, by calculating from the general series the arches whose tangents are $\frac{1}{4}$ and $\frac{1}{3}$, (which may be quickly done by reason of the smallness and simplicity of the numbers), and taking the latter arch from four

times the former, the remainder will be the arch of 45° ."

If we substitute $\frac{1}{4}$ instead of t in the general series, we shall have the arch whose tangent is $\frac{1}{4}$ expressed by the series $\frac{1}{5} - \frac{1}{3 \cdot 5^3} + \frac{1}{5 \cdot 5^5} - \frac{1}{7 \cdot 5^7} +$, &c.; and, in like manner, by substituting $\frac{1}{3}$ for t , we get the arch

whose tangent is $\frac{1}{3}$ expressed by the series $\frac{1}{2 \cdot 3} - \frac{1}{3 \cdot 239^3} + \frac{1}{5 \cdot 239^5} - \frac{1}{7 \cdot 239^7} +$, &c. Now, since four times the arch to $\tan. \frac{1}{4}$ diminished by the arch to $\tan. \frac{1}{3}$ is equal to the arch to $\tan. 1$, that is, to the arch of 45° , or $\frac{1}{2}$ of the semicircumference; therefore, half the circumference of a circle to rad. = 1, or the whole circumference, the diameter being 1, is equal to

$$16 \left(\frac{1}{5} - \frac{1}{3 \cdot 5^3} + \frac{1}{5 \cdot 5^5} - \frac{1}{7 \cdot 5^7} + \frac{1}{9 \cdot 5^9} - \dots \right) - 4 \left(\frac{1}{2 \cdot 3} - \frac{1}{3 \cdot 239^3} + \frac{1}{5 \cdot 239^5} - \frac{1}{7 \cdot 239^7} + \frac{1}{9 \cdot 239^9} - \dots \right)$$

and this is Machin's series for the rectification of the circle.

The happy idea which Machin had conceived of reducing the rectification of the arch whose tangent is unity to that of two arches whose tangents are small rational fractions, having each unity for a numerator, appears also to have occurred to Euler; and the same thought has, since his time, been pursued by other mathematicians, who have contrived to resolve an arch of 45° into three or more such arches. We shall shew how this may be done, beginning with the investigation of the following problem.

PROBLEM. Supposing n , x , and y , to denote three whole numbers, such, that the arch whose tangent is $\frac{1}{n}$ is equal to the sum of two arches whose tangents are $\frac{1}{x}$ and $\frac{1}{y}$, radius being unity, it is required to determine all possible values of the numbers x and y in terms of the number n .

Solution. It is manifest from the formula for the tangent of the sum of two arches (ALGEBRA, § 368.) that

$$\frac{1}{n} = \frac{\frac{1}{x} + \frac{1}{y}}{1 - \frac{1}{xy}}$$

hence we have $\frac{1}{n} = \frac{x+y}{xy-1}$, and $nx + ny$

$= xy - 1$, and $y(x-n) = nx + 1$; and, lastly, $y = \frac{nx+1}{x-n} = n + \frac{n^2+1}{x-n}$. Now, as by hypothesis, y is a whole number, it is manifest that $\frac{n^2+1}{x-n}$ must be a whole number; therefore, $x-n$ must be a divisor of n^2+1 .

Let p be any divisor of n^2+1 , and q the quotient, that is, let $p \cdot q = n^2+1$, then $x-n = p$, and $y = n+p$: And since $\frac{n^2+1}{x-n} = p \cdot q = q$, therefore $y = n+q$; thus the values of x and y are determined in terms of n as required; and by giving to p and q all possible values, we shall

Squaring: have all the values of y and γ that can exist. This solution affords us the following theorem.

THEOREM. Let n denote any whole number, and let n^2+1 be resolved into any two factors p and q , (one of which may be unity), that is, let $p \cdot q = n^2+1$; the arch whose tangent is $\frac{1}{n}$ is equal to the sum of the arches whose tangents are $\frac{1}{n+p}$ and $\frac{1}{n+q}$ respectively.

For the sake of brevity, let $\Lambda \frac{1}{n}$ be put to denote the arch, having for its tangent $\frac{1}{n}$; then, according to this notation, our theorem will be expressed thus, $\Lambda \frac{1}{n} =$

$\Lambda \frac{1}{n+p} + \Lambda \frac{1}{n+q}$. Let us now suppose $n=1$, then $n^2+1=2=1 \times 2$, therefore, the only values which we can give in this case to p and q are $p=1, q=2$, and these being substituted, we have

$$\Lambda 1 = \Lambda 1 + \Lambda \frac{1}{2}.$$

From which it appears, that the arch whose tangent is unity (that is, $\frac{1}{2}$ of the circumference), is the sum of the arches whose tangents are $\frac{1}{2}$ and $\frac{1}{3}$. This is Euler's theorem, and by means of it, putting $\frac{1}{2}$ and $\frac{1}{3}$ for t in the general series $t - \frac{1}{3}t^3 + \frac{1}{5}t^5 - \frac{1}{7}t^7 + \dots$ we get half the circumference to radius 1 equal to

$$4 \left\{ \begin{array}{l} \frac{1}{2} - \frac{1}{3 \cdot 2^3} + \frac{1}{5 \cdot 2^5} - \frac{1}{7 \cdot 2^7} + \frac{1}{9 \cdot 2^9} - \dots \\ + \frac{1}{3} - \frac{1}{3 \cdot 3^3} + \frac{1}{5 \cdot 3^5} - \frac{1}{7 \cdot 3^7} + \frac{1}{9 \cdot 3^9} - \dots \end{array} \right\}$$

Let us now suppose $n=2$, then $n^2+1=5=1 \times 5$, hence the only values which p and q can have are 1 and 5; and in this case our general formula gives $\Lambda \frac{1}{2} = \Lambda \frac{1}{2} + \Lambda \frac{1}{5}$.

If now from the two equations

$$\Lambda 1 = \Lambda \frac{1}{2} + \Lambda \frac{1}{5}; \quad \Lambda \frac{1}{2} = \Lambda \frac{1}{2} + \Lambda \frac{1}{5},$$

we eliminate successively $\Lambda \frac{1}{2}$ and $\Lambda \frac{1}{5}$, we shall obtain the two following:

$$\Lambda 1 = 2 \Lambda \frac{1}{5} + \Lambda \frac{1}{5}; \quad \Lambda 1 = 2 \Lambda \frac{1}{5} - \Lambda \frac{1}{5}.$$

From the first of these it appears that $\frac{1}{5}$ of the circumference is equal to the sum of twice the arch to tan. $\frac{1}{5}$, and once the arch to tan. $\frac{1}{5}$; and from the second, that the same quantity is equal to the excess of twice the arch to tan. $\frac{1}{5}$ above the arch to tan. $\frac{1}{5}$; and from each of these, an expression for the whole circumference may be obtained analogous to that which we have found above from Euler's formula, but which will converge faster, and therefore is better.

The resolution of an arch of 45° into three other arches, may be effected by means of our general formula, as follows: Put $n=3$, then $n^2+1=10=1 \times 10=2 \times 5$, hence we have $p=1$, and $q=10$, and also $p=2$, and $q=5$; therefore, substituting, we get two different values of $\Lambda \frac{1}{3}$, viz.

$$\Lambda \frac{1}{3} = \Lambda \frac{1}{3} + \Lambda \frac{1}{10}; \quad \Lambda \frac{1}{3} = \Lambda \frac{1}{3} + \Lambda \frac{1}{5}.$$

From these, and the equation $\Lambda 1 = 2 \Lambda \frac{1}{3} + \Lambda \frac{1}{5}$, we

get, by extending $\Lambda \frac{1}{3}$, the two following expressions for $\Lambda 1$, an arch of 45° .

$$\Lambda 1 = 2 \Lambda \frac{1}{3} + \Lambda \frac{1}{5} + 2 \Lambda \frac{1}{10}; \quad \Lambda 1 = 2 \Lambda \frac{1}{3} + \Lambda \frac{1}{5} + 2 \Lambda \frac{1}{5}.$$

These give each an expression for the circumference composed of three series. The labour, however, of computing by either of them, particularly the latter, will probably be less than by any of the formulas composed of two series, on account of the greater degree of quickness with which the series will converge. All the preceding formulas have been investigated in different ways by different mathematicians. That, however, which we are about to investigate, we believe is new. Let n in the general formula be taken equal to 5; then $n^2+1=26=1 \times 26=2 \times 13$, therefore $p=1, q=26$, also $p=2, q=13$, hence we find $\Lambda \frac{1}{5} = \Lambda \frac{1}{5} + \Lambda \frac{1}{26}$, and also $\Lambda \frac{1}{5} = \Lambda \frac{1}{5} + \Lambda \frac{1}{13}$. From this last equation, and the equation $\Lambda 1 = 2 \Lambda \frac{1}{5} + \Lambda \frac{1}{26} + 2 \Lambda \frac{1}{26}$, let $\Lambda \frac{1}{26}$ be eliminated, and the result is

$$\Lambda 1 = 3 \Lambda \frac{1}{5} + 2 \Lambda \frac{1}{13} + 2 \Lambda \frac{1}{26}.$$

This appears to be the most convenient expression of any we have yet found, because the fractions are smaller, while at the same time two of the denominators consist of only one figure, and the third, which consists of two, admits of being resolved into factors. By the same mode of reasoning we have found this expression

$$\Lambda 1 = 2 \Lambda \frac{1}{3} + 3 \Lambda \frac{1}{9} + 2 \Lambda \frac{1}{18} + 3 \Lambda \frac{1}{27},$$

which consists of four terms; but for the sake of brevity we omit its investigation.

We shall now apply the formula $\Lambda 1 = 3 \Lambda \frac{1}{5} + 2 \Lambda \frac{1}{13} + 2 \Lambda \frac{1}{26}$ to the actual calculation of the arch of 45° , the radius of the circle being unity.

I. Calculation of the length of the arch whose tangent is $\frac{1}{5}$.

In this case, because $t = \frac{1}{5}$, we have

$$\Lambda \frac{1}{5} = \frac{1}{5} - \frac{1}{3 \cdot 5^3} + \frac{1}{5 \cdot 5^5} - \frac{1}{7 \cdot 5^7} + \frac{1}{9 \cdot 5^9} - \dots$$

$$\begin{array}{r} \frac{1}{5} = .1428571428571 \\ \frac{1}{3 \cdot 5^3} = .0009718172983 \\ \frac{1}{5 \cdot 5^5} = .0000118998037 \\ \frac{1}{7 \cdot 5^7} = .0000001734665 \\ \frac{1}{9 \cdot 5^9} = .000000027534 \\ \frac{1}{11 \cdot 5^{11}} = .000000000460 \\ \frac{1}{13 \cdot 5^{13}} = .000000000008 \end{array} \quad \begin{array}{r} \frac{1}{3 \cdot 7^3} = .0009718172983 \\ \frac{1}{7 \cdot 7^5} = .0000001734665 \\ \frac{1}{11 \cdot 7^{11}} = .000000000460 \\ \dots = .0009719928108 \end{array}$$

$$\begin{array}{r} + .142869454150 \text{ amount of positive terms.} \\ - .0009719928108 \text{ amount of negative terms.} \end{array}$$

$$\Lambda \frac{1}{5} = .1418970546042$$

II. Calculation of the length of the arch whose tangent is $\frac{1}{3}$.

Here $t = \frac{1}{3}$, therefore,

$$\Lambda \frac{1}{3} = \frac{1}{3} - \frac{1}{3 \cdot 3^3} + \frac{1}{5 \cdot 3^5} - \frac{1}{7 \cdot 3^7} + \dots$$

Squaring.

$$\frac{1}{8} = .125000000000 \quad \frac{1}{3\sqrt{3}} = .0006510416667$$

$$\frac{1}{5\sqrt{5}} = .00000610335156 \quad \frac{1}{7\sqrt{7}} = .000000681196$$

$$\frac{1}{9\sqrt{9}} = .000000008279 \quad \frac{1}{11\sqrt{11}} = .000000000106$$

$$\frac{1}{13\sqrt{13}} = .000000000001 \quad .000651109799$$

$$+.125006104335$$

$$-.000651109799$$

$$A \frac{1}{8} = .1243549945466$$

III. Calculation of the arch whose tangent is $\frac{1}{\sqrt{3}}$.

Here $t = \frac{1}{\sqrt{3}}$, therefore,

$$A \frac{1}{13} = \frac{1}{13} - \frac{1}{3 \cdot 13^3} + \frac{1}{5 \cdot 13^5} - \frac{1}{7 \cdot 13^7} + \text{&c.}$$

$$\frac{1}{13} = .05555555555556 \quad \frac{1}{3 \cdot 13^3} = .0000571559214$$

$$\frac{1}{5 \cdot 13^5} = .0000001058443 \quad \frac{1}{7 \cdot 13^7} = .000000002333$$

$$\frac{1}{9 \cdot 13^9} = .000000000006 \quad .0000571561547$$

$$+.05555556614005$$

$$-.0000571561547$$

$$A \frac{1}{13} = .0554985032453$$

$$3A \frac{1}{8} = .4236911638126$$

$$2A \frac{1}{4} = .248709980932$$

$$2A \frac{1}{8} = .1109970104916$$

$$\frac{1}{8} \text{ of the circum. or } A1 = .783598163397$$

Thus by a very easy calculation we have obtained one-fourth of the circumference true to 12 decimal places; and indeed by this method we may find an approximate value of the ratio of the diameter to the circumference to 200 places of figures with, perhaps, as much ease as Vieta or Romanus found it to 10 or 15 figures. We have already observed that Van Ceulen desired that his quadrature, which extended only to 35 decimals, might be inscribed on his tomb; from which we may reasonably infer that the time and labour he had bestowed in the calculation must have been very great; but by an artifice of the kind we have been explaining, Euler in 18 hours verified Lagry's quadrature of 128 figures.

In concluding this article we shall briefly notice some series for the indefinite re-division of the circle, which have just appeared in the sixth volume of the Edinburgh Philosophical Transactions. They are given by Mr W. Wallace of the Royal Military College, in a paper entitled, *New Series for the Quadrature of the Conic Sections, and the Computation of Logarithms*. These series do not give the arch directly, but only its

reciprocal, or the powers of that reciprocal; it is however evident, that any one of these being known, the arch itself becomes immediately known. The first series is as follows. Let a denote any arch of a circle, and let its tangent, the tangents of its half, &c. be briefly denoted by $\tan. a, \tan \frac{1}{2} a, \text{&c.}$ Then shall

$$\frac{1}{a} = \frac{1}{\tan. a} + \frac{1}{2} \tan. \frac{1}{2} a + \frac{1}{4} \tan. \frac{1}{4} a + \frac{1}{8} \tan. \frac{1}{8} a + \dots + T + T' + S.$$

Here the arches $a, \frac{1}{2} a, \frac{1}{4} a, \frac{1}{8} a, \text{&c.}$ constitute a geometrical progression, having the number of its terms infinite, and their common ratio $\frac{1}{2}$. The letters T and T' are put for any two adjoining terms (after the first) of the series, and S is put for the sum of all the terms following these; and this sum is always contained between two limits, one of which is $\frac{1}{2}$ of the latter of the two terms T, T' , and the other is a third proportional to their difference; and the last of the two being always less than the first of these limits, but greater than the second. As a specimen of the way of applying this series, we shall give the calculation of the length of an arch of 90° to six decimal places. In this case $\frac{1}{\tan. a} = \cotan. a = 0, \tan. \frac{1}{2} a = 1$, the remaining quantities $\tan. \frac{1}{4} a, \tan. \frac{1}{8} a, \text{&c.}$ are to be computed from $\tan. \frac{1}{2} a$ by this formula, $\tan. \frac{1}{2} A = \sqrt{\left(\frac{1}{\tan^2 A} + 1\right)} - \frac{1}{\tan. A}$.

Accordingly we find

$$\tan. \frac{1}{8} a = 1. \quad \tan. \frac{1}{8} a = .0954914$$

$$\tan. \frac{1}{4} a = .4142136 \quad \tan. \frac{1}{4} a = .2491268$$

$$\tan. \frac{1}{2} a = .1980123 \quad \tan. \frac{1}{2} a = .245486$$

$$\frac{1}{2} \tan. \frac{1}{8} a = .5000000$$

$$\frac{1}{4} \tan. \frac{1}{4} a = .1035534$$

$$\frac{1}{8} \tan. \frac{1}{2} a = .2486632$$

$$\frac{1}{16} \tan. \frac{1}{4} a = .004557$$

$$T = \frac{1}{8} \tan. \frac{1}{8} a = .0015352$$

$$T' = \frac{1}{16} \tan. \frac{1}{4} a = .0003856$$

$$S \leq .0001278.7 \quad \text{Hence } S = .0001278$$

$$S > .0001277.7$$

$$\frac{1}{a} = .6366197$$

Arch of $90^\circ = a = 1.570796.$

The second series given in this paper is expressed as follows. Let $\text{col. } a, \text{ col. } \frac{1}{2} a, \text{&c.}$ denote the cosine of the arch, the cosine of its half, &c. Then

$$\frac{1}{a^2} = \frac{1}{4} \frac{1 + \text{col. } a}{1 - \text{col. } a} + \frac{1}{6}$$

$$- \left(\frac{1}{3} \frac{1 - \text{col. } \frac{1}{2} a}{1 + \text{col. } \frac{1}{2} a} + \frac{1}{4^3} \frac{1 - \text{col. } \frac{1}{4} a}{1 + \text{col. } \frac{1}{4} a} \right)$$

$$+ \frac{1}{4^4} \frac{1 - \text{col. } \frac{1}{4} a}{1 + \text{col. } \frac{1}{4} a} \dots + T + T' + S$$

Here, as before, the letters T, T' denote any two adjacent terms of the series in the parenthesis, and S is put for the sum of all the following terms, which in this case is always less than $\frac{1}{2} T'$, but greater than a third proportional to $T - T'$ and T' . This second series converges.

Squaring
||
Stabbing.

verges quicker than the first, and is besides better adapted to calculation, because the sines of the series of arches $\frac{1}{2}a, \frac{1}{4}a, &c.$ are more easily deduced from the cosine of a and one another than the tangents. The formula in this case being $\cos. \frac{1}{2}A = \sqrt{\frac{1 + \cos. A}{2}}$.

There are various other series for the rectification of any arch of a circle given in the same paper, some of which converge faster than either of the two we have here specified, and all have the property of being applicable to every possible case, and of having very simple limits, between which the sum of all their terms following any proposed term are always contained. It may also be observed that the principles from which they are deduced are of the most simple and elementary kind, inasmuch that the author has stated it as his opinion, that their investigation might ever be admitted into and form a part of the elements of geometry.

SQUATINA. See SQUALUS, ICHTHYOLOGY Index.

SQUILL. See SCILLA, BOTANY and MATERIA MEDICA Index.

SQUILLA. the name of a species of cancer. See CANCER, ENTOMOLOGY Index.

SQUINNING. See MEDICINE, N° 583.

SQUIRREL. See SCURUS, MAMMALIA Index.

STABBING, in Law. The offence of mortally stabbing another, though done upon sudden provocation, is punished as murder; the benefit of clergy being taken away from it by statute. (See MURDER). For by Ja. I. c. 8. when one thrusts or stabs another, not then having a weapon drawn, or who hath not then first stricken the party stabbing, so that he dies thereof within six months after, the offender shall not have the benefit of clergy, though he did it not of malice aforethought. This statute was made on account of the frequent quarrels and stabbings with short daggers between the Scotch and the English, at the accession of James I.; and being therefore of a temporary nature, ought to have expired with the mischief which it meant to remedy. For, in point of solid and substantial justice, it cannot be said that the mode of killing, whether by stabbing, strangling, or shooting, can either extenuate or enhance the guilt; unless where, as in the case of poisoning, it carries with it internal evidence of cool and deliberate malice. But the benignity of the law hath construed the statute so favourably in behalf of the subject, and so strictly when against him, that the offence of stabbing now stands almost upon the same footing as it did at the common law. Thus, (not to repeat the cases mentioned under MANSLAUGHTER, of stabbing an adulterer, &c. which are barely manslaughter, as at common law), in the construction of this statute it hath been doubted, whether, if the deceased had struck at all before the mortal blow given, this does not take it out of the statute, though in the preceding quarrel the stabber had given the first blow; and it seems to be the better opinion, that this is not within the statute. Also it hath been resolved, that the killing a man, by throwing a hammer or other weapon, is not within the statute; and whether a shot with a pistol be so or not is doubted. But if the party slain had a cudgel in his hand, or had thrown a pot or a bottle, or discharged a pistol at the party stabbing, this is a sufficient reason for having a

weapon drawn on his side within the words of the statute.

STACHYS, HEDGE-NETTLE, or ALL-HEAL, a genus of plants belonging to the class of didymnia, and order of gymnospermia; and in the natural system arranged under the 42d order, *Verticillate*. See BOTANY Index.

STADIUM, an ancient Greek long measure, containing 125 geometrical paces, or 625 Roman feet, corresponding to our furlong. The word is said to be formed from the Greek word *σταθις* "a station," or *στασις* "to stand," because it is reported that Hercules having run a stadium at one breath, stood still at the end of it. The Greeks usually measured distances by stadia, which they called *stadia*. Stadium also signified the course on which their races were run.

STADTHOLDER, formerly the principal magistrate or governor of the Seven United Provinces. Although this office is now abolished by the usurped influence of France, our readers will probably not be ill pleased with a short account of the several powers and claims connected with it. To render that account the more intelligible, we shall trace the office of a stadtholder from its origin.

The Seven Provinces of the Low Countries were long governed by princes invested with the sovereignty, though limited in their powers, and under various titles; as *Counts of Holland, Dukes of Guelder, Bishop of Utrecht, &c.* When these countries fell to the princes of the house of Burgundy, and afterwards to those of Austria, who had many other dominions, the absence of the sovereign was supplied by a stadtholder or governor, vested with very ample powers. These stadtholders or lieutenants had the administration of the government, and presided in the courts of justice, whose jurisdiction was not at that time confined merely to the trial of causes, but extended to affairs of state. The stadtholders swore allegiance to the princes at their inauguration, jointly with the states of the provinces they governed. They likewise took an oath to the states, by which they promised to maintain their fundamental laws and privileges.

It was upon this footing that William the First, prince of Orange, was made governor and lieutenant-general of Holland, Zealand, and Utrecht, by Philip the Second, upon his leaving the Low Countries to go into Spain. The troubles beginning soon after, this prince found means to bring about an union, in 1576, between Holland and Zealand; the states of which two provinces put into his hands, as far as was in their power, the sovereign authority (for so long time as they should remain in war and under arms), upon the same footing as Holland had intrusted him with it the year before. In 1581 the same authority was again renewed to him by Holland, as it was soon after by Zealand likewise; and in 1584, being already elected count of Holland, upon certain conditions he would have been formally invested with the sovereignty, had not a wretch, hired and employed by the court of Spain, put an end to his life by a horrid assassination.

In the preamble of the instruments by which the states in 1581 conferred the sovereign authority upon Prince William the First, we find these remarkable words, which are there set down as fundamental rules: "That all republics and communities ought to pre-

St. Lys.
||
Stadthold.
ct.

Blackf.
Comment.
Ar. v.
P. 102.

Stadtholder, er.
 ferre, maintain, and fortify themselves by unanimity; which being impossible to be kept up always among so many members, often differing in inclinations and sentiments, it is consequently necessary that the government should be placed in the hands of one single chief magistrate." Many good politicians, and the greatest part of the inhabitants of these provinces, since the establishment of the republic, looked upon the stadtholderian government as an essential part of her constitution; nor has the been without a stadtholder but twice, that is to say, from the end of 1650 to 1672, and again from March 1722 till April 1747. The provinces of Friesland and Groningen, with Ommelands, had always a stadtholder without interruption: their instructions may be seen in Aitzema; but formerly the powers of the stadtholder of these provinces were confined within narrower bounds, and till William the Fourth there was no stadtholder of the seven provinces together.

The stadtholder could not declare war or make peace, but he had, in quality of captain general of the union, the command in chief of all the forces of the state (A); and military persons were obliged to obey him in every thing that concerned the service. He was not limited by instructions; but he had the important power of giving out orders for the march of troops, and the disposition of all matters relative to them. He not only directed their marches, but provided for the garrisons, and changed them at pleasure. All military edicts and regulations came from him alone; he constituted and authorized the high council of war of the United Provinces, and, as captain general of every province, disposed of all military offices, as far as the rank of colonel inclusively. The higher posts, such as those of velt-marshals, generals, lieutenant-generals, major-generals, were given by the states general, who chose the persons recommended by his highness. He made the governors, commandants, &c. of towns and strong places of the republic, and of the barrier. The persons nominated presented their instruments of appointment to their high mightinesses, who provided them with commissions. The states-general had likewise great regard to the recommendation of the prince stadtholder in the disposition of those civil employments which were in their gift.

The power of the stadtholder as high-admiral, extended to every thing that concerned the naval force of the republic, and to all the other affairs that were here within the jurisdiction of the admiralty. He presided at these boards either in person or by his representatives; and as chief of them all in general, and of every one in particular, he had power to make their orders and instructions be observed by themselves and others. He bestowed the posts of lieutenant-admiral, vice-admiral, and rear admiral, who commanded under him; and he made likewise post-captains.

The stadtholder granted likewise letters of grace, par-

don, and abolition, as well for the crimes called *Communia Delicta*, as for military offences. In Holland and Zealand these letters were made out for crimes of the first sort, in the name of the states, with the advice of his highness. In military offences he consulted the high council of war; and upon the *communia delicta* he took the advice of the courts of justice, of the councilers, committees of the provinces, of the council of state, and the tribunals of justice in the respective towns, according to the nature of the case.

In the provinces of Holland and Zealand, the stadtholder elected the magistrates of the towns annually, out of a double number that were returned to him by the towns themselves.

When any of these offices became vacant, which, at the time there was no governor, were in the disposal of the States of Holland, or as formerly in that of the chamber of accounts, the stadtholder had his choice of two, or, in some cases, of three candidates, named by their noble and great mightinesses. He chose likewise the countessors, inspectors of the dykes of Rymland, Deliland, and Scheeland, out of three persons presented to him by the boards of the countessors inspectors; which boards were of very ancient establishment in Holland.

His highness presided in the courts of Holland, and in the courts of justice of the other provinces; and his name was placed at the head of the proclamations and acts, called in Dutch *Mandementen*, or *Procyon van Justitie*. In Overysel and in the province of Utrecht the possessors of fiefs held of the prince stadtholder. He was supreme curator of the universities of Guelder, Friesland, and Groningen; grand forester and grand veneur in Guelder, in Holland, and other places. In the province of Utrecht, his highness, by virtue of the regulation of 1674, disposed of the provostships and other benefices which remained to the chapters, as also of the canonical prebends that fell in the months which were formerly the papal months.

By the first article of the council of state of the United Provinces, the stadtholder was the first member of it, and had a right of voting there, with an appointment of 25,000 guilders a-year. He assisted also, as often as he thought it for the service of the state, at the deliberations of the states general, to make propositions to them, and sometimes also at the conferences which the deputies of their high mightinesses held in their different committees, in consequence of their standing orders. He likewise assisted at the assemblies of the states of each particular province, and at that of the councilors committees. In Guelder, Holland, and Utrecht, his highness had a share of the sovereignty, as chief or president of the body of nobles; and in Zealand, where he possessed the marquise of Veer and Flushing, as first noble, and representing the whole nobility. In his absence he had

(A) In times of war, however, the states had always named deputies for the army, to accompany the stadtholders in the field, and to serve them as counsellors in all their enterprises, particularly in the most important affairs, such as giving battle, or undertaking a siege, &c. This was always practised till the accession of King William the Third to the crown of Great Britain, and after his death was continued with regard to the general in chief of the army of the republic. In 1747 and 1748 there were likewise deputies with the army, but with more limited power.

Staff ^{of Staffs} is in Zealand his representatives, who had the first place and the first voice in all the councils, and the first of whom was always first deputy from the province to the assembly of their high mightinesses.

In 1749 the prince stadtholder was created by the states-general, governor-general and supreme director of the East and West India companies; dignities which gave him a great deal of authority and power, and which had never been conferred upon any of his predecessors, nor had they hitherto been made hereditary. He had his representatives in the several chambers of the company, and chose their directors out of a nomination of three qualified persons. The prince enjoyed this prerogative in Zealand from the time of his elevation to the stadtholderate.

The revenues of the stadtholderate of the seven United Provinces were reckoned (including the 25,000 guilders which the prince enjoyed annually as the first member of the council of state, and what he had from the India company's dividends) to amount to 300,000 guilders a-year. As captain-general of the union, his serene highness had 120,000 guilders per annum; besides 24,000 from Friesland, and 12,000 from Groningen, in quality of captain-general of these provinces. In times of war the state allowed extraordinary sums to the captain-general for the expence of every campaign.

All these powers and privileges were held by the prince of Orange previous to the revolutionary war of France. The influence of the usurper of that kingdom has extended to the states of Holland, and attacked them as a province to France under the name of a kingdom, at the head of which is a brother of Bonaparte.

STÆHELINA, a genus of plants belonging to the class of Syngenesia, and order of polygamia aequalis; and in the natural system arranged under the 49th order, *Compositæ*. See **BOTANY Index**.

STAFF, an instrument ordinarily used to rest on in walking. The staff is also frequently used as a kind of natural weapon both of offence and defence; and for several other purposes.

STAFF, a light pole erected in different parts of a ship, whereon to hoist and display the colours.

The principal of these is reared immediately over the stern, to display the ensign; another is fixed on the low-pit, to extend the juck; three more are erected at the three mast heads, or formed by their upper ends, to show the flag or pendant of the respective squadron or division to which the ship is appropriated. See **ENSIGNS, MAST, JACK, and PENDANT**.

STAFF, in military matters, consists of a quartermaster-general, adjutant-general, and majors of brigade. The staff properly exists only in time of war. See **QUARTER-MASTER General, &c.**

Regimental STAFF, consists in the adjutant, quartermaster, chaplain, surgeon, &c.

STAFF, in music, five lines, on which, with the intermediate spaces, the notes of a long or piece of music are marked.

Fore STAFF. See **FORE Staff**.

STAFFA, one of the Hebrides or Western Islands of Scotland, remarkable for its basaltic pillars. It was visited by Sir Joseph Banks, who communicated the following account of it to Mr Pennant.

"The little island of Staffa lies on the west coast of Mull, about three leagues north-east from Iona, or Ico-

lunkill: its greatest length is about an English mile, and its breadth about half a one. On the east side of the island is a small bay where boats generally land; a little to the southward of which the first appearance of pillars is to be observed; they are small; and instead of being placed upright, lie down on their sides, each forming a segment of a circle. From thence you pass a small cave, above which the pillars, now grown a little larger, are inclining in all directions: in one place in particular, a small mass of them very much resembles the ribs of a ship. From hence having passed the cave, which, if it is not low-water, you must do in a boat, you come to the first ranges of pillars, which are still not above half as large as those a little beyond. Over against this place is a small island, called in Erse *Boo-sha-la*, separated from the main by a channel not many fathoms wide. This whole island is composed of pillars without any stratum above them; they are still small, but by much the neatest formed of any about the place.

"The first division of the island, for at high water it is divided into two, makes a kind of a cone, the pillars converging together towards the centre: on the other they are in general laid down flat: and in the front next to the main, you see how beautifully they are packed together, their ends coming out square with the bank which they form. All these have their transverse sections exact, and their surfaces smooth; which is by no means the case with the large ones, which are cracked in all directions. I must mention, however, if any part of this whole island of Boo-sha-la is two feet in diameter.

"The main island opposite to Boo-sha-la, and farther towards the north-west, is supported by ranges of pillars pretty erect, and, though not tall (as they are not uncovered to the base), of large diameters; and at their feet is an irregular pavement, made by the upper sides of such as have been broken off, which extends as far under water as the eye can reach. Here the forms of the pillars are apparent; these are of three, four, five, six, and seven sides; but the numbers of five and six are by much the most prevalent. The largest I measured was of seven; it was four feet five inches in diameter.

"The surfaces of these large pillars, in general, are rough and uneven, full of cracks in all directions; the transverse figures in the upright ones never fail to run in their true directions. The surfaces upon which we walked were often flat, having neither concavity nor convexity; the larger number, however, was concave, though some were very evidently convex. In some places, the interstices within the perpendicular figures were filled up with a yellow spar: in one place, a vein passed in among the mass of pillars, carrying here and there small threads of spar. Though they were broken and cracked through in all directions, yet their perpendicular figures might easily be traced: from whence it is easy to infer, that whatever the accident might have been that caused the dislocation, it happened after the formation of the pillars.

"From hence proceeding along shore, you arrive at Fingal's cave. Its dimensions I have given in the form of a table:

	Feet. In.
Length of the cave from the rock without,	371 6
From the pitch of the arch,	250-00
	Breadth

Staff.	Breadth of ditto at the mouth,	-	53	7
	At the farther end,	-	20	0
	Height of the arch at the mouth,	-	117	6
	At the end,	-	70	0
	Height of an outside pillar,	-	39	6
	Of one at the north-west corner,	-	54	0
	Depth of water at the mouth,	-	18	0
	At the bottom,	-	9	0

	Stratum below the pillar of lava-like matter,	11	0
	Length of pillar,	54	0
	Stratum above the pillar,	61	6
	" N ^o 4. Another part to the westward.		
	Stratum below the pillar,	17	1
	Height of the pillar,	50	0
	Stratum above,	54	1

Staffs
||
Staffed
||
i. e.

" The cave runs into the rock in the direction of north-east by east by the compass.

" Proceeding farther to the north-west, you meet with the highest ranges of pillars; the magnificent appearance of which is still all description. Here they are bare to their very basis, and the stratum below them is also visible: in a short time, it rises many feet above the water, and gives an opportunity of examining its quality. Its surface is rough, and has often large lumps of stone sticking in it as if half immerged: itself, when broken, is composed of a thousand heterogeneous parts, which together have very much the appearance of a lava; and the more so, as many of the lumps appear to be of the very same stone of which the pillars are formed. This whole stratum lies in an inclined position, dipping gradually towards the south-east. As hereabouts is the situation of the highest pillars, I shall mention my measurements of them, and the different strata in this place, premising, that the measurements were made with a line, held in the hand of a person who stood at the top of the cliff, and reaching to the bottom; to the lower end of which was tied a white mark, which was observed by one who staid below for the purpose: when this mark was set off from the water, the person below noted it down, and made signal to him above, who made then a mark in his rope: whenever this mark passed a notable place, the same signal was made, and the name of the place noted down as before: the line being all hauled up, and the distances between the marks measured and noted down, gave, when compared with the book kept below, the distances, as for instance in the cave:

" N^o 1. in the book below, was called from the water to the foot of the first pillar in the book above; N^o 1. gave 36 feet eight inches, the highest of that ascent, which was composed of broken pillars.

" N^o 1. Pillar at the west corner of Fingal's cave.

	Feet. In.
1 From the water to the foot of the pillar,	12 10
2 Height of the pillar,	37 3
3 Stratum above the pillar,	66 9

" N^o 2. Fingal's cave.

1 From the water to the foot of the pillar,	36 8
2 Height of the pillar	39 6
3 From the top of the pillar to the top of the arch,	31 4
4 Thickness of the stratum above,	34 4
By adding together the three first measurements, we got the height of the arch from the water,	117 6

" N^o 3. Corner pillar to the westward of Fingal's cave.

Vol. XIX. Part II.

" N^o 5. Another pillar farther to the westward.

Stratum below the pillar,	19	8
Height of the pillar,	55	1
Stratum above,	54	7

" The stratum above the pillars, which is here mentioned, is uniformly the same, consisting of numberless small pillars, bending and inclining in all directions, sometimes so irregularly that the stones can only be said to have an inclination to assume a columnar form; in others more regular, but never breaking into or disturbing the stratum of large pillars, whose tops everywhere keep an uniform and regular line.

" Proceeding now along the shore round the north end of the island, you arrive at *Oua na scarve*, or the Corvorant's Cave. Here the stratum under the pillars is lifted up very high; the pillars above it are considerably less than those at the north-west end of the island, but still very considerable. Beyond is a bay, which cuts deep into the island, rendering it in that place not more than a quarter of a mile over. On the sides of this bay, especially beyond a little valley, which almost cuts the island into two, are two stages of pillars, but small; however, having a stratum between them exactly the same as that above them, formed of innumerable little pillars, shaken out of their places, and leaning in all directions.

" Having passed this bay, the pillars totally cease; the rock is of a dark brown stone, and no signs of regularity occur till you have passed round the south-east end of the island (a space almost as large as that occupied by the pillars), which you meet again on the west side, beginning to form themselves irregularly, as if the stratum had an inclination to that form, and soon arrive at the bending pillars where I began.

" The stone of which the pillars are formed, is a coarse kind of basalt, very much resembling the Giant's Caulfeway in Ireland, though none of them are near so neat as the specimens of the latter which I have seen at the British Museum; owing chiefly to the colour, which in ours is a dirty brown, in the Irish a fine black; indeed the whole production seems very much to resemble the Giant's Caulfeway."

STAFFORD, the county town of Staffordshire, in W. Long. 2. 0. N. Lat. 53. 0. It stands on the river Sow, has two parish-churches, a fine square market-place, and a flourishing cloth-manufacture. It sends two members to parliament, and is 135 miles from London.

STAFFORDSHIRE, a county of England, bounded on the south by Worcestershire, by Cheshire and Derbyshire on the north, by Warwickshire and Derbyshire on the east, and Shropshire and Cheshire on the west. The length is reckoned 62 miles, the breadth 33, and the circumference 180. It contains five hundred, 150 parishes, 810,000 acres, 18 market-towns, and

Stafford-shire.
Stag.

230,153 inhabitants. The air, except in these parts that are called the Moorlands and Woodlands, and about the mines, is good, especially upon the hills, where it is accounted very fine. The soil in the northern mountainous parts is not fertile; but in the middle, where it is watered by the Trent, the third river in England, it is both fruitful and pleasant, being a mixture of arable and meadow grounds. In the fourth, it abounds not only with corn, but with mines of iron and pits of coal. The principal rivers of this county, besides the Trent, which runs almost through the middle of it, and abounds with salmon, are the Dove and Tame, both of which are well stored with fish. In this county are also a great many lakes, and meres or pools, as they are called; which, having streams either running into them or from them, cannot be supposed to be of any great prejudice to the air; they yield plenty of fish. In divers parts of the county are medicinal waters, impregnated with different sorts of minerals, and consequently of different qualities and virtues; as those at Hints and Brefsford-louie, which are mixed with bitumen; those at Ingetre, Codfalwood, and Willoughbridge park, which are sulphureous. Of the saline kind are the Brine-pits at Chertley, Epfom, Penfnet-clofe, of which very good fait is made. There is a well at Newealle-under-Line that is said to cure the king's evil; another called *Elderwell* near Blehill, said to be good for sore eyes; and a third called the *Spa*, near Wolverhampton.

Great flocks of these are bred in this county, especially in the moorlands, or mountains of the northern part of it; but the wool is said to be somewhat coarser than that of many other counties. Of this wool, however, they make a variety of manufactures, particularly felts. In the low grounds along the rivers are rich pastures for black cattle; and vast quantities of butter and cheese are made. In the middle and southern parts not only grain of all kinds, but a great deal of hemp and flax are raised. This country produces also lead, copper, iron; marble, alabaster, millstones, limestone; coal, salt, and marles of several sorts and colours; brick-earth, fullers earth, and potters clay, particularly a sort used in the glass manufacture at Amblecot, and sold at seven-pence a bushel; tobacco-pipe clay; a sort of reddish earth called *slip*, used in painting divers vessels; red and yellow ochres; fire-stones for hearths of iron furnaces, ovens, &c.; iron-stones of several sorts; bloodstones, or haematites, found in the brook Tent, which, when wet a little, will draw red lines like ruddle; quarry-stones, and grind-stones. For fuel the country is well supplied with turf, peat, and coal of several sorts, as eannel-coal, peacock-coal, and pit-coal. The peacock-coal is so called, because, when turned to the light, it displays all the colours of the peacock's tail; but it is fitter for the forge than the kitchen. Of the pit-coal there is an inexhaustible store: it burns into white ashes, and leaves no such cinder as that of the Newcastle coal. It is not used for melting till it is charred, and in that state it makes admirable winter-fuel for a chamber.

This county is in the diocese of Litchfield and Coventry, and the Oxford circuit. It sends ten members to parliament; namely, two for the county, two for the city of Litchfield, two for Stafford, two for Newealle-under-Line, and two for Tamworth.

STAG. See CERVUS, MAMMALIA *Ind.*

STAG-Beetle. See LUCANUS, ENTOMOLOGY *Ind.*

STAGE, in the modern drama, the place of action and representation, included between the pit and the scenes, and answering to the proscenium or pulpitum of the ancients. See PLAYHOUSE and THEATRE.

STAGGERS. See FARRIERY *Ind.*

STAHL, GEORGE ERNEST, an eminent German chemist, was born in Franconia in 1669, and chosen professor of medicine at Hall, when a university was founded in that city in 1694. The excellency of his lectures while he filled that chair, the importance of his various publications, and his extensive practice, soon raised his reputation to a very great height. He received an invitation to Berlin in 1716, which having accepted, he was made counsellor of state and physician to the king. He died in 1734, in the 75th year of his age. Stahl is without doubt one of the greatest men of which the annals of medicine can boast: his name marks the commencement of a new and more illustrious era in chemistry. He was the author of the doctrine of phlogiton, which, though now completely overturned by the discoveries of Lavoisier and others, was not without its use; as it served to combine the scattered fragments of former chemists into a system, and as it gave rise to more accurate experiments and a more scientific view of the subject, to which many of the subsequent discoveries were owing. This theory maintained its ground for more than half a century, and was received and supported by some of the most eminent men which Europe has produced; a sufficient proof of the ingenuity and the abilities of its author. He was the author also of *A Theory of Medicine*, founded upon the notions which he entertained of the absolute dominion of mind over body; in consequence of which, he affirmed, that every muscular action is a voluntary act of the mind, whether attended with consciousness or not. This theory he and his followers carried a great deal too far, but the advices at least which he gives to attend to the state of the mind of the patient are worthy of the attention of physicians.

His principal works are, 1. *Experimenta et Observationes Chemicae et Physicae*, Berlin, 1731, 8vo. 2. *Differentiones Medicae*, Hall, 2 vols 4to. This is a collection of theses. 3. *Theoria Medica vera*, 1737, 4to. 4. *Opusculum Chymico-physico-medicum*, 1740, 4to. 5. *A Treatise on Sulphur, both Inflammable and Fixed*, written in German. 6. *Negotium Otiolum*, Hall, 1720, 4to. It is in this treatise chiefly that he establishes his system concerning the action of the soul upon the body. 7. *Fundamenta Chymica Dogmatica et Experimentalis*, Nuremberg, 1747, 3 vols 4to. 8. *A treatise on Salts*, written in German. 9. *Commentarium in Metallurgiam Beccheri*, 1723.

STAINING or COLOURING of BONE, HORN, MARBLE, PAPER, WOOD, &c. See these articles.

STAIRCASE, in *Architecture*, an ascent inclosed between walls, or a balustrade consisting of stairs or steps, with landing places and rails, serving to make a communication between the several stories of a house. See ARCHITECTURE, N^o 89, &c.

STALACTITES, in *Mineralogy*, crystalline spars composed into oblong, conical, round, or irregular bodies, formed of various crusts, and usually found hanging in form of icicles from the roofs of grottoes, &c.

STALAGMITIS, a genus of the moræcia order, belonging

Stag
h
Stalagmitis

Stale belonging to the polygamia class of plants; and in the natural method ranking under the 38th order, *Triceceae*. See BOTANY and MATERIA MEDICA *Index*.

STALE, among sportsmen, a living fowl put in a place to allure and bring others where they may be taken. For want of these, a bird thot, his entrails taken out, and dried in an oven in his feathers, with a flick thrust through to keep it in a convenient posture, may serve as well as a live one.

STALE is also a name for the urine of cattle.

ANIMATED STALK. This remarkable animal was found by Mr Ives at Cuddalore; and he mentions several kinds of it; some appearing like dry straws tied together, others like grass; some have bodies much larger than others, with the addition of two scaly imperfect wings; their neck is no bigger than a pin, but twice as long as their bodies; their heads are like those of an hare, and their eyes vertical and very brisk. They live upon flies, and catch these insects very dexterously with the two fore-feet, which they keep doubled up in three parts close to their head, and dart out very quick on the approach of their prey; and when they have caught it, they eat it very voraciously, holding it in the same manner as a squirrel does its food. On the outer joints of the fore-feet are several very sharp hooks for the easier catching and holding of their prey; while, with the other feet, which are four in number, they take hold of trees or any other thing, the better to surprize whatever they lie in wait for. They drink like a horse, putting their mouths into the water. Their excrements, which are very white, are almost as large as the body of the animal, and as the natives say, dangerous to the eyes.

STALLION, or **STONE-HORSE**, in the manege, a horse designed for the covering of mares, in order to propagate the species. See EQUUS, MAMMALIA *Index*.

STAMFORD, an ancient town of Lincolnshire in England; seated on the river Welland, on the edge of Northamptonshire. It is a large handsome place, containing six parish-churches, several good streets, and fine buildings. It had formerly a college, the students of which removed to Brazen Nose college in Oxford. It has no considerable manufactures, but deals chiefly in malt. W. Long, c. 31. N. Lat. 54. 42.

STAMINA, in *Botany*, are those upright filaments which, on opening a flower, we find within the corolla surrounding the pistillum. According to Linnæus, they are the male organs of generation, whose office it is to prepare the pollen. Each stamen consists of two distinct parts, viz. the FILAMENTUM and the ANTHERA.

STAMINA, in the animal body, are defined to be those simple original parts which existed first in the embryo or even in the seed; and by whose distinction, augmentation, and accretion by additional juices, the animal body at its utmost bulk is supposed to be formed.

STAMP-DUTIES, a branch of the perpetual revenue. See REVENUE.

In Great Britain there is a tax imposed upon all parchment and paper, whereon any legal proceedings or private instruments of almost any nature whatsoever are written; and also upon licences for retailing wines, of all denominations; upon all almanacs, newspapers, advertisements, cards, dice, &c. These imposts are very various; being higher or lower, not so much according to the value of the property transferred, as according to the nature of the deed. The highest do not exceed

six pounds upon every sheet of paper or skin of parchment; and these high duties fall chiefly upon grants from the crown, and upon certain law proceedings, without any regard to the value of the subject. There are in Great Britain no duties on the registration of deeds or writings, except the fees of the officers who keep the register; and these are seldom more than a reasonable recompense for their labour. The crown derives no revenue from them.

The stamp-duties constitute a tax which, though in some instances it may be heavily felt, by greatly increasing the expence of all mercantile as well as legal proceedings, yet (if moderately imposed) is of service to the public in general, by authenticating instruments, and rendering it much more difficult than formerly to forge deeds of any standing; since, as the officers of this branch of the revenue vary their stamps frequently, by marks perceptible to none but themselves, a man that would forge a deed of King William's time, must know and be able to counterfeit the stamp of that date also. In France and some other countries the duty is laid on the contract itself, not on the instrument in which it is contained; as, with us too in England (besides the stamps on the indentures), a tax is laid, by statute 8 Ann. c. 9. on every apprentice-fee; of 6d. in the pound if it be 50l. or under, and 1s. in the pound if a greater sum; but this tends to draw the subject into a thousand nice distinctions and disputes concerning the nature of his contract, and whether taxable or not; in which the farmers of the revenue are sure to have the advantage. Our general method answers the purposes of the state as well, and consults the ease of the subject much better. The first institution of the stamp duties was by statute 5 and 6 W. and M. c. 21. and they have since, in many instances, been increased to five times their original amount.

STANCHION, or **STANCHIONS**, a sort of small pillars of wood or iron used for various purposes in a ship; as to support the decks, the quarter-rails, the nettings, the awnings, &c. The first of these are two ranges of small columns fixed under the beams, throughout the ship's length between decks; one range being on the starboard and the other on the larboard side of the hatchways. They are chiefly intended to support the weight of the artillery.

STAND, in commerce, a weight from two hundred and an half to three hundred of pich.

STANDARD, in *War*, a sort of banner or flag borne as a signal for the joining together of the several troops belonging to the same body.

STANDARD, in *Commerce*, the original of a weight, measure, or coin, committed to the keeping of a magistrate, or deposited in some public place, to regulate, adjust, and try the weights used by particular persons in traffic. See MONEY.

STANHOPE PHILIP DORMER, EARL OF CHESTERFIELD, was born in 1695, and educated in Trinity-hall, Cambridge; which place he left in 1714, when, by his own account, he was an absolute pedant. In this character he went abroad, where a familiarity with good company soon convinced him he was totally mistaken in almost all his notions; and an attentive study of the air, manner, and address of people of fashion, soon polished a man whose predominant desire was to please; and who, as it afterwards appeared, valued exterior accomplish-

ments beyond any other human acquirement. While Lord Stanhope, he got an early seat in parliament; and in 1722, succeeded to his father's estate and titles. In 1728, and in 1745, he was appointed ambassador extraordinary and plenipotentiary to Holland: which high character he supported with the greatest dignity; serving his own country, and gaining the esteem of the states general. Upon his return from Holland, he was sent lord-lieutenant of Ireland; and during his administration there, gave general satisfaction to all parties. He left Dublin in 1746, and in October succeeded the earl of Harrington as secretary of state, in which post he officiated until February 6th 1748. Being seized with a deafness in 1752 that incapacitated him for the pleasures of society, he from that time led a private and retired life, amusing himself with books and his pen; in particular, he engaged largely as a volunteer in a periodical miscellaneous paper called *The World*, in which his contributions have a distinguished degree of excellence. He died in 1773, leaving a character for wit and abilities that had few equals. He distinguished himself by his eloquence in parliament on many important occasions; of which we have a characteristic instance, of his own relating. He was an active promoter of the bill for altering the style; on which occasion, as he himself writes in one of his letters to his son, he made so eloquent a speech in the house, that every one was pleased, and said he had made the whole very clear to them; "when (says he), God knows, I had not even attempted it. I could just as soon have talked Celtic or Sclavonian to them, as astronomy; and they would have understood me full as well." Lord Maclesfield, one of the greatest mathematicians in Europe, and who had a principal hand in framing the bill, spoke afterwards, with all the clearness that a thorough knowledge of the subject could dictate; but not having a flow of words equal to Lord Chesterfield, the latter gained the applause from the former, to the equal credit of the speaker and the auditors. The high character Lord Chesterfield supported during life, received no small injury soon after his death, from a fuller display of it by his own hand. He left no issue by his lady, but had a natural son, Philip Stanhope, Esq. whose education was for many years a close object of his attention, and who was afterward envoy extraordinary at the court of Dresden, but died before him. When Lord Chesterfield died, Mr Stanhope's widow published a course of letters, written by the father to the son, filled with instructions suitable to the different gradations of the young man's life to whom they were addressed. These letters contain many fine observations on mankind, and rules of conduct: but it is observable that he lays a greater stress on exterior accomplishments and address, than on intellectual qualifications and sincerity; and allows greater latitude to fashionable pleasures than good morals will justify, especially in paternal instructions. Hence it is that a celebrated writer §, and of manners somewhat different from those of the polite earl of Chesterfield, is said to have observed of these letters, that "they inculcate only the morals of a whore, with the manners of a dancing-master."

STANHOPE, Dr George, an eminent divine, was born at Hertford in Derbyshire, in the year 1660. His father was rector of that place, vicar of St Margaret's church in Leicester, and chaplain to the earls of Ches-

terfield and Clare. His grandfather, Dr George Stanhope, was chaplain to James I. and Charles I.; had the chancellorship of York, where he was also a canon-residentary, held a prebend, and was rector of Weldrake in that county. He was for his loyalty driven from his home with eleven children; and died in 1644. Our author was sent to school, first at Uppingham in Rutland, then at Leicester; afterwards removed to Eaton; and thence chosen to King's college in Cambridge, in the place of W. Cleaver. He took the degree of B. A. in 1681; M. A. 1685; was elected one of the syndics for the university of Cambridge, in the business of Alban Francis, 1687; minister of Quoi near Cambridge, and vice-rector, 1688; was that year preferred to the rectory of Tring in Hertfordshire, which after some time he quitted. He was in 1689 presented to the vicarage of Lewisham in Kent by Lord Dartmouth, to whom he had been chaplain, and tutor to his son. He was also appointed chaplain to King William and Queen Mary, and continued to enjoy that honour under Queen Anne. He commenced D. D. July 3th 1697, performing all the offices required to that degree publicly and with great applause. He was made vicar of Deptford in 1703; succeeded Dr Hooper as dean of Canterbury the same year; and was thence chosen prolocutor of the lower house of convocation. His uncommon diligence and industry, assisted by his excellent parts, enriched him with a large stock of polite, solid, and useful learning. His discourses from the pulpit were equally pleasing and profitable; a beautiful intermixture of the clearest reasoning with the purest diction, attended with all the graces of a just elocution. The good Christian, the solid divine, and the fine gentleman, in him were happily united. His conversation was polite and delicate, grave without pretensions, facetious without levity. His piety was real and rational, his charity great and universal, fruitful in acts of mercy, and in all good works. He died March 18th 1728, aged 68 years; and was buried in the chancel of the church at Lewisham. The dean was twice married: first to Olivia Cotton, by whom he had one son and four daughters. His second lady, who was sister to Sir Charles Wager, survived him, dying October 1st 1730, aged about 54. One of the dean's daughters was married to a son of Bishop Burnet. Bishop Moore of Ely died the day before Queen Anne; who, it has been said, designed our dean for that see when it should become vacant. Dr Felton says, "The late dean of Canterbury is excellent in the whole. His thoughts and reasoning are bright and solid. His style is just, both for the purity of the language and for the strength and beauty of expression; but the periods are formed in so peculiar an order of the words, that it was an observation, nobody could pronounce them with the same grace and advantage as himself." His writings, which are an inestimable treasure of piety and devotion are, A Paraphrase and Comment upon the Epistles and Gospels, 4 vols, 1725, 8vo. Sermons at Boyle's Lectures, 1706, 4to. Fifteen Sermons, 1720, 8vo. Twelve Sermons on several Occasions, 1727, 8vo. Thomas à Kempis, 1666, 8vo. Epictetus's Morals, with Simplicius's Comment, and the Life of Epictetus, 1720, 8vo. Parson's Christian Directory, 1716, 8vo. Rochefoucault's Maxims, 1706, 8vo. A Funeral Sermon on Mr Richard Sme book-keeper, 1724; two editions 4to. Twenty Sermons, published singly between

§ Dr Johnson.

Stanhope, between the years 1692 and 1724. Private Prayers for every Day in the Week, and for the several Parts of each Day; translated from the Greek Devotions of Bishop Andrews, with Additions, 1730. In his translations, it is well known, Dr Stanhope did not confine himself to a strict and literal version: he took the liberty of paraphrasing, explaining, and improving upon his author; as will evidently appear (not to mention any other work) by the slightest perusal of St Augustine's Meditations, and the Devotions of Bishop Andrews.

STANISLAUS LEZINSKI, king of Poland, was born at Leopold the 20th of October 1677. His father was a Polish noblemen, distinguished by his rank and the important offices which he held, but still more by his firmness and courage. Stanislaus was sent ambassador in 1704 by the assembly of Warsaw to Charles XII. of Sweden, who had conquered Poland. He was at that time 27 years old, was general of Great Poland, and had been ambassador extraordinary to the Grand Signior in 1699. Charles was so delighted with the frankness and sincerity of his deportment, and with the firmness and sweetness which appeared in his countenance, that he offered him the crown of Poland, and ordered him to be crowned at Warsaw in 1705. He accompanied Charles XII. into Saxony, where a treaty was concluded with King Augustus in 1705, by which that prince resigned the crown, and acknowledged Stanislaus king of Poland. The new monarch remained in Saxony with Charles till 1707, when they returned into Poland and attacked the Russians, who were obliged to evacuate that kingdom in 1708. But Charles being defeated by Peter the Great in 1709, Augustus returned into Poland, and being assisted by a Russian army, obliged Stanislaus to retire first into Sweden, and afterwards into Turkey. Soon after he took up his residence at Weissenburg, a town in Alsace. Augustus dispatched Sam his envoy to France to complain of this; but the duke of Orleans, who was then regent, returned this answer: "Tell your king, that France has always been the asylum of unhappy princes." Stanislaus lived in obscurity till 1725, when Louis XV. espoused the princess Mary his daughter. Upon the death of King Augustus in 1733, he returned to Poland in hopes of remounting the throne of that kingdom. A large party declared for him; but his competitor the young elector of Saxony, being supported by the emperor Charles VI. and the empress of Russia, was chosen king, though the majority was against him. Dantzic, to which Stanislaus had retired, was quickly taken, and the unfortunate prince made his escape in disguise with great difficulty, after hearing that a price was set upon his head by the Russians. When peace was concluded in 1746 between the emperor and France, it was agreed that Stanislaus should abdicate the throne, but that he should be acknowledged king of Poland and grand duke of Lithuania, and continue to bear these titles during life; that all his effects and those of the queen his spouse should be restored; that an amnesty should be declared in Poland for all that was past, and that every person should be restored to his possessions, rights, and privileges; that the elector of Saxony should be acknowledged King of Poland by all the powers who acceded to the treaty; that Stanislaus should be put in peaceable possession of the duchies of Lorraine and Bar; but that immediately after his death these duchies should be united for ever to

the crown of France. Stanislaus succeeded a race of Stanislaus princes in Lorraine, who were beloved and regretted; and his subjects found their ancient sovereigns revived in him. He tasted then the pleasure which he had so long desired, the pleasure of making men happy. He assisted his new subjects; he embellished Nancy and Lunéville; he made useful establishments; he founded colleges and built hospitals. He was engaged in these noble employments, when an accident occasioned his death. His night-gown caught fire, and burnt him so severely before it could be extinguished, that he was seized with a fever, and died the 23d of February 1766. His death occasioned a public mourning: the tears of his subjects indeed are the best eulogium upon this prince. In his youth he had accustomed himself to fatigue, and had thereby strengthened his mind as well as his constitution. He lay always upon a kind of mattress, and seldom required any service from his domestics. He was temperate, liberal, adored by his vassals, and perhaps the only nobleman in Poland who had any friends. He was in Lorraine what he had been in his own country, gentle, affable, compassionate, treating his subjects like equals, participating their sorrows and alleviating their misfortunes. He resembled completely the picture of a philosopher which himself has drawn. "The true philosopher (said he) ought to be free from prejudices, and to know the value of reason: he ought neither to think the higher ranks of life of more value than they are, nor to treat the lower orders of mankind with greater contempt than they deserve: he ought to enjoy pleasures without being a slave to them, riches without being attached to them, honours without pride or vanity: he ought to support disgraces without either fearing or courting them: he ought to reckon what he possesses sufficient for him, and to regard what he has not as useless: he ought to be equal in every fortune, always tranquil, always gay: he ought to love order, and to observe it in all his actions: he ought to be severe to himself, but indulgent to others: he ought to be frank and ingenuous without rudeness, polite without falsehood, complaisant without baseness: he ought to have the courage to disregard every kind of glory, and to reckon as nothing even philosophy itself." Such was Stanislaus in every situation. His temper was affectionate. He told his treasurer one day to put a certain officer on his list, to whom he was very much attached: "In what quality (said the treasurer) shall I mark him down?" "As my friend" (replied the monarch). A young painter conceiving hopes of making his fortune if his talents were made known to Stanislaus, presented him with a picture, which the courtiers criticised severely. The prince praised the performance, and paid the painter very generously: then turning to his courtiers, he said, "Do ye not see, gentlemen, that this poor man must provide for his family by his abilities? if you discourage him by your censures, he is undone. We ought always to assist men; we never gain any thing by hurting them." His revenues were small; but were we to judge of him by what he did, we should probably reckon him the richest potentate in Europe. A single instance will be sufficient to show the well-judged economy with which his benevolent plans were conducted. He gave 18,000 crowns to the magistrates of Bar to be employed in purchasing grain, when at a low price, to be sold out again to the people at a moderate rate when

Stanilaus

Stapelia

the price should rise above a certain sum. By this arrangement (say the authors of *Dictionnaire Historique*), the money increases continually, and its good effects may in a short time be extended over the whole province.

He was a protector of the arts and sciences: he wrote several works of philosophy, politics, and morality, which were collected and published in France in 1763, in 4 vols, 8vo, under the title of *Oeuvres de Philosophie Bien-faisant*, "the works of the Benevolent Philosopher."

STANTZAS, villages or small districts of the banks of the Don, inhabited by Cossacs.

STANLEY, THOMAS, a learned English writer in the 17th century, was the son of Sir Thomas Stanley of Cumberlow-Green in Herefordshire, knight. He was born at Cumberlow about 1644, and educated in his father's house, whence he removed to the university of Cambridge. He afterwards travelled; and, upon his return to England, prosecuted his studies in the Middle Temple. He married, when young, Dorothy, the eldest daughter of Sir James Engan of Flower, in Northamptonshire. He wrote, 1. A volume of Poems. 2. History of Philosophy, and Lives of the Philosophers. 3. A Translation of Ezechylus, with a Commentary; and several other works. He died in 1678.

STANNARIES, the mines and works where tin is dug and purified; as in Cornwall, Devonshire, &c.

STANNARY COURTS, in Devonshire and Cornwall, for the administration of justice among the tinners therein. They are held before the lord-warden and his substitutes, in virtue of a privilege granted to the workers in the tin-mines there, to sue and be sued only in their own courts, that they may not be drawn from their business, which is highly profitable to the public, by attending their law-suits in other courts. The privileges of the tinners are confirmed by a charter, 33 Edw. I. and fully expounded by a private statute, 50 Edw. III. which has since been explained by a public act, 16 Car. I.

c. 15. What relates to our present purpose is only this: That all tinners and labourers in and about the stannaries shall, during the time of their working therein, *bona fide*, be privileged from suits of other courts, and be only pleaded in the stannary court in all matters, excepting pleas of land, life, and member. No writ of error lies from hence to any court in Westminster-hall; as was agreed by all the judges, in 4 Jac. I. But an appeal lies from the steward of the court to the under-warden; and from him to the lord-warden; and thence to the privy-council of the prince of Wales, as duke of Cornwall, when he hath had livery or investiture of the same. And from thence the appeal lies to the king himself, in the last resort.

STANNUM, TIN. See TIN, CHEMISTRY and MINERALOGY Index.

STANZA, in Poetry, a number of lines regularly adjusted to each other; so much of a poem as contains every variation of measure or relation of rhyme used in that poem.

STAPELIA, a genus of plants belonging to the class pentandria and order digynia, and in the natural orders arranged under the *Succulente*. See BOTANY Index.—This singular tribe of plants is peculiar to the sandy deserts of Africa and Arabia. They are extremely succulent. From this peculiarity of structure, the power of retaining water to support and nourish them,

they are enabled to live during the prevalent droughts of those arid regions. On this account the stapelia has been compared to the camel; and we are told that, by a very apt similitude, it has been denominated "the camel of the vegetable kingdom." We must confess ourselves quite at a loss to see the propriety or aptitude of this comparison. In many parts of the animal and vegetable economy there is doubtless a very obvious and striking analogy; but this analogy has been often carried too far; much farther than fair experiment and accurate observation will in any degree support. It is perhaps owing to this inaccuracy in observing the peculiarity of structure and diversity of functions, that a resemblance is supposed to exist, as in the present case, where in reality there is none. The camel is provided with a bag or fifth stomach, in addition to the four with which ruminant animals are furnished. This fifth stomach is defined as a reservoir to contain water; and it is sufficiently capacious to receive a quantity of that necessary fluid, equal to the wants of the animal, for many days; and this water, as long as it remains in the fifth stomach, is said to be perfectly pure and unchanged. The *Stapelia*, and other succulent plants, have no such reservoir. The water is equally, or nearly so, diffused through the whole plant. Every vessel and every cell is fully distended. But besides, this water, whether it be received by the roots, or absorbed from the atmosphere, has probably undergone a complete change, and become, after it has been a short time within the plant, a fluid possessed of very different qualities.

The peculiar economy in the stapelia, and other succulent plants, seems to exist in the absorbent and exhalant systems. The power of absorption is as much increased as the power of the exhalant or perspiratory vessels is diminished. In these plants, a small quantity of nourishment is required. There is no solid part to be formed, no large fruit to be produced. They generally have very small leaves, often are entirely naked; so that taking the whole plant, a small surface only is exposed to the action of light and heat, and consequently a much smaller proportion of water is decomposed than in plants which are much branched and furnished with leaves.

Two species of stapelia only were known at the beginning of the century. The unfortunate Forkal, the companion of Niebhur, who was sent out by the king of Denmark to explore the interior of Arabia, and who fell a sacrifice to the pestilential diseases of those inhospitable regions, discovered two new species. Thunberg, in his *Prodromus*, has mentioned five more. Forty new species have been discovered by Mr Masson of Kew Gardens, who was sent out by his present Majesty for the purpose of collecting plants round the Cape of Good Hope. Descriptions of these, with elegant and highly finished coloured engravings, have lately been published. They are chiefly natives of the extensive deserts called *Karro*, on the western side of the Cape.

STAPHYLEA, BLADDER-NUT, a genus of plants belonging to the class of pentandria and order of trigynia; and in the natural system arranged under the 23d order, *Tribilata*. See BOTANY Index.

STAPHYLINUS, a genus of insects belonging to the order of coleoptera. See ENTOMOLOGY Index.

STAPLE,

Stapelia

Staphylinus

Blackstone's
Commentaries
vol. vii.
p. 79 and
80.

Staple
or
Star.

STAPLE, primarily signifies a public place or market, whither merchants, &c. are obliged to bring their goods to be bought by the people; as the Greve, or the places along the Seine, for sale of wines and corn, at Paris, whither the merchants of other parts are obliged to bring those commodities.

Formerly, the merchants of England were obliged to carry their wool, cloth, lead, and other like staple commodities of this realm, in order to expose them by wholesale; and these staples were appointed to be constantly kept at York, Lincoln, Newcastle-upon-Tyne, Norwich, Westminster, Canterbury, Chichester, Winchester, Exeter, and Bristol; in each where a public mart was appointed to be kept, and each of them had a court of the mayor of the staple, for deciding differences, held according to the law-merchant, in a summary way.

STAR, in *Astronomy*, a general name for all the heavenly bodies, which, like so many brilliant studs, are dispersed throughout the whole heavens. The stars are distinguished, from the phenomena of their motion, &c. into fixed, and erratic or wandering stars: these last are again distinguished into the greater luminaries, viz. the sun and moon; the planets, or wandering stars, properly so called, and the comets; which have been all fully considered and explained under the article *ASTRONOMY*. As to the fixed stars, they are so called, because they seem to be fixed, or perfectly at rest, and consequently appear always at the same distance from each other.

Falling STARS, in *Meteorology*, fiery meteors which dart through the sky in form of a star. See *METEOR*.

Twinkling of the STARS. See *OPTICS*.

STAR, is also a badge of honour, worn by the knights of the garter, bath, and thistle. See *GARTER*.

STAR of Bethlehem. See *ORNITHOGALUM*, *BOTANY Index*.

STAR, in *Fortification*, denotes a small fort, having five or more points, or salient and re-entering angles, flanking one another, and their faces 90 or 100 feet long.

Court of STAR-CHAMBER, (*camera stellata*), a famous, or rather infamous, English tribunal, said to have been so called either from a Saxon word signifying to steer or govern; or from its punishing the *crimen stellinatus*, or colerage; or because the room wherein it sat, the old council-chamber of the palace of Westminster, (Lamb. 148.) which is now converted into the lottery-office, and forms the eastern side of New-Palace yard, was full of windows; or, (to which Sir Edward Coke, 4 Inst. 66. accedes,) because *lumpy* the roof thereof was at the first garnished with gilded stars. As all these are merely conjectures, (for no stars are now in the roof, nor are any said to have remained there so late as the reign of Queen Elizabeth), it may be allowable to propose another conjectural etymology, as plausible perhaps as any of them. It is well known, that, before the banishment of the Jews under Edward I. their contracts and obligations were denominated in our ancient records *starras* or *starrs*, from a corruption of the Hebrew word, *stetar*, a covenant. (Tovey's *Angl. Judaic.* 32. Selden. tit. of hon. ii. 34. *Uxor Hebraic.* i. 13.) These starrs, by an ordinance of Richard I. preserved by Hoveden, were commanded to be enrolled and deposited in chests

under three keys in certain places; one, and the most considerable, of which was in the king's exchequer at Westminster: and no starr was allowed to be valid, unless it were found in some of the said repositories. (*Memorand. in Scac' P.* 6. *Edw. I.* prefixed to Maynard's year-book of Edw. II. fol. 8. Madox hist. exch. c. vii. §. 4, 5, 6.) The room at the exchequer, where the chests containing these starrs were kept, was probably called the *star-chamber*; and, when the Jews were expelled the kingdom, was applied to the use of the king's council, sitting in their judicial capacity. To confirm this, the first time the star-chamber is mentioned in any record, it is said to have been situated near the receipt of the exchequer at Westminster: (the king's council, his chancellor, treasurer, justices, and other judges, were assembled *en la chambre des estelles pres la receipt at Westminster.* *Clauf.* 41 *Edw. III. m. 13.*) For in process of time, when the meaning of the Jewish starrs were forgotten, the word *star-chamber* was naturally rendered in law French, *la chambre des estelles*, and in law Latin *camera stellata*; which continued to be the style in Latin till the dissolution of that court.

This was a court of very ancient original; but remodelled by statutes 3 Hen. VII. c. 1. and 21 Henry VIII. c. 20. consisting of divers lords spiritual and temporal, being privy-counsellors, together with two judges of the courts of common law, without the intervention of any jury. Their jurisdiction extended legally over riots, perjury, misbehaviour of sheriffs, and other notorious misdemeanors, contrary to the laws of the land. Yet this was afterwards (as Lord Clarendon informs us) stretched to the asserting of all proclamations and orders of state; to the vindicating of illegal commissions and grants of monopolies; holding for honourable that which pleased, and for just that which profited; and becoming both a court of law to determine civil rights, and a court of revenue to enrich the treasury: the council-table by proclamations enjoining to the people that which was not enjoined by the laws, and prohibiting that which was not prohibited; and the star-chamber, which consisted of the same persons in different rooms, censuring the breach and disobedience to those proclamations by very great fines, imprisonments, and corporal severities: so that any disrespect to any acts of state, or to the persons of state-men, was in no time more penal, and the foundations of right never more in danger to be destroyed. For which reasons, it was finally abolished by statute 16 Car. I. c. 10. to the general joy of the whole nation. See *KING'S BENCH*. There is in the British Museum (Harl. MSS. vol. I. N^o 126.) a very full, methodical, and accurate account of the constitution and course of this court, compiled by William Hudson of Gray's Inn, an eminent practitioner therein. A short account of the same, with copies of all its precepts, may also be found in 18 Hym. Foed. 192, &c.

STAR-BARD, the right side of the ship when the eye of the spectator is directed forward.

STAR-FIB. See *ASTERIAS*, *HELMINTHOLOGY Index*.

STAR-SHOT, a gelatinous substance frequently found in fields, and supposed by the vulgar to have been produced from the meteor called a *falling star*: but, in reality, is the half-digested food of herons, sea-mews, and

Star.

Star.
Starch.

and the like birds; for these birds have been found when newly shot, to disgorge a substance of the same kind.

Star-Stone, in *Natural History*, a name given to certain extraneous fossil stones, in form of short, and commonly somewhat crooked columns, composed of several joints, each resembling the figure of a radiated star, with a greater or smaller number of rays in the different species: they are usually found of about an inch in length, and of the thickness of a goose-quill. Some of them have five angles or rays, and others only four; and in some the angles are equidistant, while in others they are irregularly so: in some also they are short and blunt, while in others they are long, narrow, and pointed; and some have their angles very short and obtuse. The several joints in the same specimen are usually all of the same thickness; this, however, is not always the case: but in some they are larger at one end, and in others at the middle, than in any other part of the body; and some species have one of the rays bifid, so as to emulate the appearance of a six-rayed kind.

Star-Thistle. See CENTAUREA, } **BOTANY** Index.
Star-Wort. See ASTER, }

STARCH, a fecula or sediment, found at the bottom of vessels wherein wheat has been steeped in water, of which fecula, after separating the bran from it, by passing it through sieves, they form a kind of loaves, which being dried in the sun or an oven, is afterwards cut into little pieces, and so sold. The best starch is white, soft, and friable, and easily broken into powder. Such as require fine starch, do not content themselves, like the starchmen, with refuse wheat, but use the finest grain. The process is as follows: The grain, being well cleaned, is put to ferment in vessels full of water, which they expose to the sun while in its greatest heat; changing the water twice a-day, for the space of eight or twelve days, according to the season. When the grain bursts easily under the finger, they judge it sufficiently fermented. The fermentation perfected, and the grain thus softened, it is put, handul by handul, into a canvas-bag, to separate the flour from the hulks; which is done by rubbing and setting it on a plank laid across the mouth of an empty vessel that is to receive the flour.

As the vessels are filled with this liquid flour, there is seen swimming at top a reddish water, which is to be carefully skimmed off from time to time, and clean water is to be put in its place, which, after stirring the whole together, is also to be strained through a cloth or sieve, and what is left behind put into the vessel with new water, and exposed to the sun for some time. As the sediment thickens at the bottom, they drain off the water four or five times, by inclining the vessel, but without passing it through the sieve. What remains at bottom is the starch, which is cut in pieces to get out, and left to dry in the sun. When dry, it is laid up for use.

The following mill, was invented by M. Baumé for grinding potatoes, with a view to extract starch from them.

He had a grater made of plate iron, in a cylindrical form (fig. 1.) about seven inches in diameter, and about eight inches high; the bars made by slumping the holes are on the inside. This grater is supported upon three feet A A A, made of flat iron bars, seven feet high,

Starch.

strongly rivetted to the grater; the bottom of each foot is bent horizontally, and has a hole in it which receives a screw, as at A, fig. 4. A little below the upper end of the three feet is fixed a cross piece B (fig. 1. and 4.), divided into three branches, and rivetted to the feet. This cross piece not only serves to keep the feet at a proper distance from each other, and to prevent their bending; but the centre of it having a hole cut in it, serves to support an axis or spindle of iron, to be presently described.

The upper end of this cylindrical grater has a diverging border of iron C (fig. 1. 4. and 7.), about 10 inches in diameter at the top, and five inches in height.

Within this cylindrical grater is placed a second grater (fig. 2. and 3.), in the form of a cone, the point of which is cut off. The latter is made of thick plate iron, and the bars of the holes are on the outside; it is fixed, with the broad end at the bottom, as in fig. 4. At the upper end of the cone is rivetted a small triangle, or cross piece of iron, consisting of three branches D (fig. 2.), in the middle of which is made a square hole, to receive an axis or spindle; to give more resistance to this part of the cone, it is strengthened by means of a cap of iron E, which is fixed to the grater by means of rivets, and has also a square hole made in it, to let the axis pass through.

Fig. 3. represents the same cone seen in front; the base F has also a cross piece of three branches, rivetted to a hoop of iron, which is fixed to the inner surface of the cone; the centre of this cross piece has also a square hole for the passage of the axis.

Fig. 5. is a spindle or axis itself; it is a square bar of iron about 16 inches long, and more than half an inch thick; round at the bottom, and also towards the top, where it fits into the cross piece I, fig. 7. and B, fig. 1. and 4.; in these pieces it turns round, and by them it is kept in its place. It must be square at its upper extremity, that it may have a handle, about nine inches long, fixed to it, by means of which the conical grater is turned round. At G, (fig. 5.), a small hole is made through the axis, to receive a pin H, by means of which the conical grater is kept at its proper height within the cylindrical one.

Fig. 6. is a bird's-eye view, in which the mill is represented placed in an oval tub, like a bathing-tub. I is the fore-mentioned triangular iron cross, fixed with screws to the side of the tub; the centre of it has a round hole, for the axis of the mill to move in when it is used.

Fig. 7. represents the mill in the oval tub; it is placed at one end of it, that the other end may be left free for any operation to be performed in it which may be necessary. A part of the tub is cut off, that the inside of it, and the manner of fixing the mill, may be seen. That the bottom of the tub may not be worn by the screws which pass through the feet of the mill, a deal board, about an inch thick, and properly shaped, is placed under the mill.

When we wish to make use of this mill, it is to be fixed by the feet, in the manner already described; it is also fixed at the top, by means of the cross piece I, fig. 6. and 7. The tub is then to have water poured into it as high as K, and the top of the mill is to be filled with potatoes, properly washed and cut; the handle L is to be turned round, and the potatoes, after being ground between

D.
E.

Starch. between the two graters, go out gradually at the lower part, being assisted by the motion produced in the water by the action of the mill.

To prepare starch from potatoes, says M. Baumé, any quantity of these roots may be taken, and soaked in a tub of water for about an hour; they are afterwards to have their fibres and shoots taken off, and then to be rubbed with a pretty strong brush, that the earth, which is apt to lodge in the inequalities of their surface, may be entirely removed; as this is done, they are to be washed, and thrown into another tub full of clean water. When the quantity which we mean to make use of has been thus treated, those which are too large are to be cut into pieces about the size of eggs, and thrown into the mill; that being already fixed in the oval tub, with the proper quantity of water: the handle is then turned round, and as the potatoes are grated they pass out at the bottom of the mill. The pulp which collects about the mill must be taken off from time to time with a wooden spoon, and put aside in water.

When all the potatoes are ground, the whole of the pulp is to be collected in a tub, and mixed up with a great quantity of clean water. At the same time, another tub, very clean, is to be prepared, on the binn of which are to be placed two wooden rails, to support a hair sieve, which must not be too fine. The pulp and water are to be thrown into the sieve; the flour passes through with the water, and fresh quantities of water are successively to be poured on the remaining pulp, till the water runs through as clear as it is poured in. In this way we are to proceed till all the potatoes that were ground are used.

The pulp is commonly thrown away as useless; but it should be boiled in water, and used as food for animals; for it is very nourishing, and is about $\frac{1}{10}$ th of the whole quantity of potatoes used.

It is farther to be observed that the liquor which has passed through the sieve is turbid, and of a brownish colour, on account of the extractive matter which is dissolved in it; it deposits, in the space of five or six hours, the flour which was suspended in it. When all the flour is settled to the bottom, the liquor is to be poured off and thrown away, being useless; a great quantity of very clean water is then to be poured upon the flour remaining at the bottom of the tub, which is to be stirred up in the water, that it may be washed, and the whole is to stand quiet till the day following. The flour will then be found to have settled at the bottom of the tub; the water is again to be poured off as useless, the flour washed in a fresh quantity of pure water, and the mixture passed through a silk sieve pretty fine, which will retain any small quantity of pulp which may have passed through the hair sieve. The whole must once more be suffered to stand quiet till the flour is entirely settled; if the water above it is perfectly clear and colourless, the flour has been sufficiently washed; but if the water has any sensible appearance either of colour or of taste, the flour must be again washed, as it is absolutely necessary that none of the extractive matter be suffered to remain.

When the flour is sufficiently washed, it may be taken out of the tub with a wooden spoon; it is to be placed upon wicker frames covered with paper, and dried, properly defended from dust. When it is thoroughly dry, it is to be passed through a silk sieve, that

if any clotted lumps should have been formed they may be divided. It is to be kept in glass-vessels stopp'd with paper only.

A patent was granted in 1796 to Lord William Murray for his discovery of a method by which starch may be extracted from horse-chestnuts. It is as follows:

Take the horse-chestnuts out of the outward green prickly hulks; and either by hand, with a knife, or other tool, or else with a mill adapted for that purpose, very carefully pare off the brown rind, being particular not to leave the smallest speck, and to entirely eradicate the sprout or growth. Next take the nuts, and rasp, grate, or grind them fine into water, either by hand, or by a mill adapted for that purpose. Wash the pulp, which is thereby formed in this water, as clean as possible, through a coarse horse-hair sieve; this again wash through a finer sieve, and then again through a still finer, constantly adding clean water, to prevent any starch from adhering to the pulp. The last process is, to put it with a large quantity of water (about four gallons to a pound of starch) through a fine gauze, muslin, or lawn, so as entirely to clear it of all bran or other impurities. As soon as it settles, pour off the water; then mix it up with clean water, repeating this operation till it no longer imparts any green, yellow, or other colour to the water. Then drain it off till nearly dry, and set it to bake, either in the usual mode of baking starch, or else spread out before a brisk fire; being very attentive to stir it frequently to prevent its burning, that is to say, turning to a pale or jelly, which, on being dried, turns hard like horn. The whole process should be conducted as quickly as possible.

Mention is here made of a mill which may be employed to grind the horse-chestnuts; but it is not described; perhaps the one described above for grinding potatoes might answer the purpose.

STARK, DR WILLIAM, known to the public by a volume containing Clinical and Anatomical Observations, with some curious Experiments on Diet, was born at Manchester in the month of July 1745; but the family from which he sprang were Scotch, and respectable for its antiquity. His grandfather John Stark of Killermont was a covenanter; and having appeared in arms against his sovereign at the battle of Bothwell bridge in the year 1679, became obnoxious to the government, and, to conceal himself, withdrew into Ireland. There is reason to believe that he had not imbibed either the extravagant zeal or the savage manners of the political and religious party to which he adhered; for after residing a few years in the country which he had chosen for the scene of his banishment, he married Elizabeth daughter of Thomas Stewart, Esq. of Ballydrone in the north of Ireland; who, being descended of the noble family of Galloway, would not probably have matched his daughter to such an exile as a ruthless fanatic of the last century. By this lady Mr Stark had several children; and his second son Thomas, who settled at Manchester as a wholesale linen-draper, and married Margaret Stirling, daughter of William Stirling, Esq. of Northwoodside, in the neighbourhood of Glasgow, was the father of the subject of this article. Another of his sons, the reverend John Stark, was minister of Lerocroft in Perthshire; and it was under the care of this gentleman that our author received the rudiments of his education, which, when we consider the character of the master,

and reflect on the relation between him and his pupil, we may presume was calculated to bore the mind of Dr Stark with those virtuous principles which influenced his conduct through life.

From Lectrop young Stark went to the university of Glasgow, where, under the tuition of the doctors Smith and Black, with other eminent masters, he learned the rudiments of science, and acquired that mathematical accuracy, that logical precision, and that contempt of hypotheses, with which he prosecuted all his future studies. Having chosen physic for his profession, he removed from the university of Glasgow to that of Edinburgh, where he was soon distinguished, and honoured with the friendship of the late Dr Cullen; a man who was not more eminently conspicuous for the superiority of his own genius, than quick-sighted in perceiving, and liberal in encouraging, genius in his pupils. Having finished his studies at Edinburgh, though he took there no degree, Mr Stark, in the year 1765, went to London, and devoted himself entirely to the study of physic and the elements of surgery; and looking upon anatomy as one of the principal pillars of both these arts, he endeavoured to complete with Dr Hunter what he had begun with Dr Monro; and under these two eminent professors he appears to have acquired a high degree of anatomical knowledge. He likewise entered himself about this time a pupil at St George's hospital; for being disgusted, as he often confessed, with the inaccuracy or want of candour observable in the generality of practical writers, he determined to obtain an acquaintance with diseases at a better school and from an able master; and to have from his own experience a standard, by which he might judge of the experience of others. With what industry he prosecuted this plan, and with what success his labours were crowned, may be seen in a series of Clinical and Anatomical Observations, which were made by him during his attendance at the hospital, and were published after his death by his friend Dr Carmichael Smyth. These observations give the public no cause to complain of want of candour in their author; for whatever delicacy he may have observed, when relating the cases of patients treated by other physicians, he has related those treated by himself with the utmost impartiality. Whilst attending the hospital, he likewise employed himself in making experiments on the blood, and other animal fluids; and also in a course of experiments in chemical pharmacy; but though accounts of these experiments were left behind him, we believe they have not yet been given to the public.

In the year 1767 Mr Stark went abroad, and obtained the degree of M. D. in the university of Leyden, publishing an inaugural dissertation on the dysentery. On his return to London, he recommenced his studies at the hospital; and when Dr Black was called to the chemical chair in Edinburgh, which he has long filled with so much honour to himself and credit to the university, Dr Stark was solicited by several members of the university of Glasgow to stand a candidate for their professorship of the theory and practice of physic, rendered vacant by Dr Black's removal to Edinburgh. This however Dr Stark declined, being influenced by the advice of his English friends, who wished to detain him in London, and having likewise some prospects of an appointment in the hospital.

In the mean time he continued (1769) a series

of experiments on diet, which he was encouraged to undertake by Sir John Pringle and Dr Franklin, whose friendship he enjoyed, and from whom he received many hints respecting both the plan and its execution. These experiments, or rather the imprudent zeal with which he prosecuted them, proved, in the opinion of his friends, fatal to himself; for he began them on the 12th of July 1769 in perfect health and vigour, and from that day, though his health varied, it was seldom if ever good, till the 23d of February 1770, when he died, after suffering much uneasiness. His friend and biographer Dr Smyth thinks, that other causes, particularly chagrin and disappointment, had no small share in hastening his death; and as the Doctor was intimately acquainted with his character and disposition, his opinion is probably well-founded, though the pernicious effects of the experiments are visible in Dr Stark's own journal. When he entered upon them, the weight of his body was 12 stone 3 lb. avoirdupois, which in a very few days was reduced to 11 stone 10 lb. 8 oz.; and though some kinds of food increased it, by much the greater part of what he used had a contrary effect, and it continued on the whole to decrease till the day of his death. This indeed can excite no wonder. Though the professed object of his experiments was to prove that a *pleasant* and varied diet is equally conducive to health with a more strict and simple one, most of the dishes which he ate during these experiments were neither pleasant nor simple, but compounds, such as every stomach must nauseate. He began with *bread and water*; from which he proceeded to *bread, water, and sugar*; then to *bread, water, and oil of olives*; then to *bread and water with milk*; afterwards he tried *bread and water with roasted geese*; *bread and water with boiled beef*; *steved lean of beef with the gravy and water without bread*; *steved lean of beef with the gravy, oil of fat or salt and water*; *flour, oil of lard, water and salt*; *flour, water, and salt*; and a number of others infinitely more disagreeable to the stomach than even these, such as *bread, fat of becco ham, infusion of tea with sugar*; and *bread or flour with honey* and the infusion of *rosinmary*. But though we consider Dr Stark's experiments as whimsical, it cannot be denied that they indicate eccentricity of genius in the person who made them; and such of our readers as think genius hereditary, may perhaps be of opinion, that he derived a ray from the celebrated NAPIER the inventor of the logarithms, who was his ancestor by both parents. At any rate, these experiments, of which a full account is given in the same volume with his clinical and anatomical observations, display an uncommon degree of fortitude, perseverance, self-denial, and zeal for the promoting of useful knowledge in their author; and with respect to his moral character, we believe it is with great justice that Dr Smyth compares him to Cato, by applying to him what was said of that virtuous Roman by Salustius—*Non divitiis cum divite, neque factione cum factionis; sed cum strenuo virtute, cum modesto pudore, cum innocente abstinentia certabat; esse, quam videri, bonus malebat* *.

STARLING. See STURNUS, ORNITHOLOGY *Int. Cautation. Int. m.*

STARLINGS, or STIRLINGS, the name given to the strong pieces of timber which were driven into the bed of the river to protect the piles, on the top of which were laid the flat beams upon which were built the

Stairing or **Stairing** the bases of the stone piers that support the arches of London bridge. In general, stairings are large piles placed on the outside of the foundation of the piers of bridges, to break the force of the water, and to protect the stone work from injury by floating ice. They are otherwise called *Antæ*, and their place is often supplied by large stones thrown at random round the piers of bridges, as may be seen at Stirling bridge when the river is low; and as was done by Mr Smeaton's direction round the piers of the centre arch of London bridge, when it was thought in danger of being undermined by the current.

STATE OF A CONTROVERSY. See ORATORY, Part I. N. 14.

STATES, or ESTATES, a term applied to several orders or classes of people assembled to consult of matters for the public good.

Thus states-generals, in the old government of Holland, is the name of an assembly consisting of the deputies of the seven United Provinces. There were usually 30 in number, some provinces sending two, others more; and whatever resolution the states-general took was confirmed by every province, and by every city and republic in that province, before it had the force of a law. The deputies of each province, of what number soever they were, had only one voice, and were esteemed as but one person, the votes being given by provinces. Each province presided in the assembly in its turn, according to the order fixed among them. Guelderland presided first, then Holland, &c.

States of Holland were the deputies of eighteen cities, and one representative of the nobility, constituting the states of the province of Holland: the other provinces had likewise their states, representing their sovereignty; deputies from which made what was called the states-general. In an assembly of the states of a particular province, one dissenting voice prevented their coming to any resolution.

STATICE, TRIFOLI, a genus of plants belonging to the class of pentandria, and order of pentagynia; and in the natural system ranging under the 45th order, *Aggregatae*. See **BOLENA Indes**.

STATICS, a term which the modern improvements in knowledge have made it necessary to introduce into physico-mathematical science. It was found convenient to distribute the doctrines of universal mechanics into two classes, which required both a different mode of consideration and different principles of reasoning.

Till the time of Archimedes little science of this kind was possessed by the ancients, from whom we have received the first rudiments. His investigation of the centre of gravity, and his theory of the lever, are the foundations of our knowledge of common mechanics; and his theory of the equilibrium of floating bodies contains the greatest part of our hydrostatical knowledge. But it was as yet limited to the simplest cases; and there was none in which Archimedes was ignorant, or was not keen. The marquis Guido Dondi, in 1376, published his theory of mechanics, in which the doctrines of Archimedes were well explained and considerably augmented. Giovanni, the celebrated D. in physics, published about 20 years after an excellent system of mechanics, containing the chief principles which now form the science of equilibrium among solid bodies. In particular, he gave the theory of inclined

planes, which was unknown to the ancients, though it is of the very first importance in almost every machine. He even uses in the most express terms the principle afterwards made the foundation of the whole of mechanics, and published as a valuable discovery by Vaughton, viz. that three forces, whose directions and intensities are as the sides of a triangle, balance each other. His theory of the pressure of fluids, or hydrostatics, is no less estimable, including every thing that is now received as a leading principle in the science. When we consider the ignorance, even of the most learned, of that age, in mechanical or physico-mathematical knowledge, we must consider these performances as the works of a great genius; and we regret that they are so little known, being lost in a crowd of good writings on these subjects which appeared soon after.

Hitherto the attention had been turned entirely to equilibrium, and the circumstances necessary for producing it. Mechanicians indeed saw, that the energy of a machine might be somehow measured by the force which could be opposed or overcome by its intervention; but they did not remark, that the force which prevented its motion, but did no more than prevent it, was an exact measure of its energy, because it was in immediate equilibrium with the pressure exerted by that part of the machine with which it was connected. If this opposed force was less, or the force acting at the other extremity of the machine was greater, the mechanicians knew that the machine would move, and that work would be performed; but what would be the rate of its motion or its performance, they hardly pretended to conjecture. They had not studied the notion of moving forces, nor conceived what was done when motion was communicated.

The great Galileo opened a new field of speculation in his work on Local Motion. He there considers a change of motion as the indication and exact and adequate measure of a moving force; and he considers every kind of pressure as competent to the production of such changes.—He contented himself with the application of this principle to the motion of bodies by the action of gravity, and gave the theory of projectiles, which remains to this day without change, and only improved by considering the changes which are produced in it by the resistance of the air.

Sir Isaac Newton took up this subject nearly as Galileo had left it. For, if we except the theory of the centrifugal forces arising from rotation, and the theory of pendulums, published by Huygens, hardly any thing had been added to the science of motion. Newton considered the subject in its utmost extent; and in his mathematical principles of natural philosophy he considered every conceivable variation of moving force, and determined the motion resulting from its action.—His first application of these doctrines was to explain the celestial motions; and the magnificence of this subject caused it to engage for a while the whole attention of the mathematicians. But the fine work contained propositions equally conducive to the improvement of common mechanics, and to the complete understanding of the mechanical relations of bodies. Philosophers began to make these applications also. They saw that every kind of work which is to be performed by a machine may be considered abstractedly as a retarding force; that the impulse of water or wind, which are employed as moving powers,

ad by means of pressures which they exert on the impelled point of the machine; and that the machine itself may be considered as an assemblage of bodies movable in certain limited circumstances, with determined directions and proportions of velocity. From all these considerations resulted a general abstract condition of a body acted on by known powers. And they found, that after all conditions of equilibrium were satisfied, there remains a surplus of moving force. They could now state the motion which will ensue, the new resistance which this will excite, the additional power which this will absorb; and they at last determined a new kind of equilibrium, not thought of by the ancient mechanicians, between the resistance to the machine performing work and the moving power, which exactly balance each other, and is indicated, not by the *ress*, but by the *efflux motion* of the machine.—In like manner, the mathematician was enabled to calculate that precise quantity of water which would completely absorb, or, in the new language, balance the superiority of pressure by which water is forced through a sluice, a pipe, or canal, with a constant velocity.

Thus the general doctrines of motion came to be considered in two points of view, according as they balanced each other in a state of rest or of uniform motion. These two ways of considering the same subject required both different principles and a different manner of reasoning. The first has been named *statics*, as expressing that rest which is the test of this kind of equilibrium. The second has been called *DYNAMICS* or *UNIVERSAL MECHANICS*, because the different kinds of motion are characteristic of the powers or forces which produce them. A knowledge of both is indispensably necessary for acquiring any useful practical knowledge of machines; and it was ignorance of the doctrines of accelerated and retarded motions which made the progress of practical mechanical knowledge so very slow and imperfect. The mechanics, even of the moderns, before Galileo, went no further than to state the proportion of the power and resistance which would be balanced by the intervention of a given machine, or the proportion of the parts of a machine by which two known forces may balance each other. This view of the matter introduced a principle, which even Galileo considered as a mechanical axiom, viz. that *what is gained in force by means of a machine is exactly compensated by the additional time which it obliges us to employ*. This is false in every instance, and not only prevents improvement in the construction of machines, but leads us into erroneous maxims of construction. The true principles of dynamics teach us, that there is a certain proportion of the machine, dependent on the kind and proportion of the power and resistance, which enables the machine to perform the greatest possible work.

It is highly proper therefore to keep separate these two ways of considering machines, that both may be improved to the utmost, and then to blend them together in every practical discussion.

Statics therefore is preparatory to the proper study of mechanics; but it does not hence derive all its importance. It is the sole foundation of many useful parts of knowledge. This will be best seen by a brief enumeration.

1. It comprehends all the doctrines of the excitement

and propagation of pressure through the parts of solid bodies, by which the energies of machines are produced. A pressure is exerted on the impelled point of a machine, such as the float-boards or buckets of a mill-wheel. This excites a pressure at the pivots of its axle, which act on the points of support. This must be understood, both as to direction and intensity, that it may be effectually resisted. A pressure is also excited at the acting tooth of the cog-wheel on the same axle, by which it urges round another wheel, exciting similar pressures on its pivots and on the acting tooth perhaps of a third wheel.—Thus a pressure is ultimately excited in the working point of the machine, perhaps a wiper, which lifts a heavy stamp, to let it fall again on some matter to be pounded. Now statics teaches us the intensities and direction of all those pressures, and therefore how much remains at the working point of the machine unbalanced by resistance.

2. It comprehends every circumstance which influences the stability of heavy bodies; the investigation and properties of the centre of gravity; the theory of the construction of arches, vaults, and domes; the attitudes of animals.

3. The strength of materials, and the principles of construction, so as to make the proper adjustment of strength and strain in every part of a machine, edifice, or structure of any kind. Statics therefore furnishes us with what may be called a *theory of carpentry*, and gives us proper instructions for framing floors, roofs, centres, &c.

4. Statics comprehends the whole doctrine of the pressure of fluids, whether liquid or ærial, whether arising from their weight or from any external action. Hence therefore we derive our knowledge of the stability of ships, or their power of maintaining themselves in a position nearly upright, in opposition to the action of the wind on their sails. We learn on what circumstances of figure and flowage this quality depends, and what will augment or diminish it.

Very complete examples will be given in the remaining part of this work of the advantages of this separate consideration of the condition of a machine at rest and in working motion; and in what yet remains to be delivered of the hydraulic doctrines in our account of *HYDRO-Works* in general, will be perceived the propriety of stating apart the equilibrium which is indicated by the uniform motion of the fluid. The observations too which we have to make on the strength of the materials employed in our edifices or mechanical structures, will be examples of the investigation of those powers, pressures, or strains, which are excited in all their parts.

STATIONARY, in *Astronomy*, the state of a planet when, to an observer on the earth, it appears for some time to stand still, or remain immovable in the same place in the heavens. For as the planets, to such an observer, have sometimes a progressive motion, and sometimes a retrograde one, there must be some point between the two where they must appear stationary.

STATISTICS, a word lately introduced to express a view or survey of any kingdom, county, or parish.

A Statistical view of Germany was published in 1790 by Mr. B. Clarke: giving an account of the imperial and territorial constitutions, forms of government, legislation, administration of justice, and of the ecclesiastical state;

Statist.

state; with a sketch of the character and genius of the Germans; a short inquiry into the state of their trade and commerce; and giving a distinct view of the dominions, extent, number of inhabitants to a square mile; chief towns, with their size and population; revenues, expences, debts, and military strength of each state. In Prussia, in Saxony, Sardinia, and Tuscany, attempts have also been made to draw up statistical accounts; but they were done rather with a view of ascertaining the present state of these countries, than as the means of future improvement.

A grand and extensive work of this kind, founded on a judicious plan, conducted by the most patriotic and enlightened motives, and drawn up from the communications of the whole body of the clergy, was undertaken in Scotland in the year 1790 by Sir John Sinclair of Ulbster, one of the most useful members of his country. Many praises are heaped upon genius and learning; but to genius and learning no applause is due, except when excited for the benefit of mankind; but gratitude and praise is due to him whose talents shine only in great undertakings, whose happiness seems to consist in patriotic exertions, and whose judgement is uniformly approved by his success. A work of this kind, so important in its object, so comprehensive in its range, so judicious in its plan, and drawn up by more than 900 men of literary education, many of them men of great genius and learning, must be of immense value. It was completed about 1799, in 21 volumes 8vo.

The great object of this work is to give an accurate view of the state of the country, its agriculture, its manufactures, and its commerce; the means of improvement, of which they are respectively capable; the amount of the population of a state, and the causes of its increase or decrease; the manner in which the territory of a country is possessed and cultivated; the nature and amount of the various productions of the soil; the value of the personal wealth or stock of the inhabitants, and how it can be augmented; the diseases to which the people are subject, their causes and their cure; the occupations of the people; where they are entitled to encouragement, and where they ought to be suppressed; the condition of the poor, the best mode of maintaining them, and of giving them employment; the state of schools, and other institutions, formed for purposes of public utility; the state of the villages and towns, and the regulations best calculated for their police and good government; the state of the manners, the morals, and the religious principles of the people, and the means by which their temporal and eternal interests can best be promoted.

To such of our readers as have not an opportunity of perusing this national work, or of examining its plan, we will present the scheme for the statistical account of a parochial district which Sir John Sinclair published for the consideration of the clergy, and which has been generally followed by them, though often with great improvements.

The name of the parish and its origin; situation and extent of the parish; number of acres; description of the soil and surface; nature and extent of the sea coast; lakes, rivers, islands, hills, rocks, caves, wood, orchards, &c.; climate and diseases; instances of longevity; state of property; number of proprietors; number of residing proprietors; mode of cultivation; implements of husbandry; manures; feedtime and harvest; remarkable in-

stances of good and bad seasons; quantity and value of each species of crop; total value of the whole produce of the district; total quantity of grain and other articles consumed in the parish; wages and price of labour; services, whether exacted or abolished; commerce; manufactures; manufacture of kelp, its amount, and the number of people employed in it; fisheries; towns and villages; police; fairs and alehouses; roads and bridges; harbours, ferries, and their state; number of ships and vessels; number of fairs; state of the church; stipend, manse, glebe, and patron; number of parishes; parochial funds, and the management of them; state of the schools, and number of scholars; ancient state of population; causes of its increase or decrease; number of families; exact amount of the number of souls now living; division of the inhabitants; 1. By the place of their birth; 2. By their ages; 3. By their religious persuasions; 4. By their occupations and situation in life; 5. By their residence, whether in town, village, or in the country; number of houses; number of uninhabited houses; number of dove-cots, and to what extent they are destructive to the crops; number of horses, their nature and value; number of cattle, their nature and value; number of sheep, their nature and value; number of swine, their nature and value; minerals in general; mineral springs; coal and fuel; eminent men; antiquities; parochial records; miscellaneous observations; character of the people; their manners, customs, stature, &c.; advantages and disadvantages; means by which their situation could be meliorated.

If similar surveys (says the public-spirited editor of this work) were instituted in the other kingdoms of Europe, it might be the means of establishing, on sure foundations, the principles of that most important of all sciences, viz. political or statistical philosophy; that is, the science, which, in preference to every other, ought to be held in reverence. No science can furnish, to any mind capable of receiving useful information, so much real entertainment, none can yield such important hints for the improvement of agriculture, for the extension of commercial industry, for regulating the conduct of individuals, or for extending the prosperity of the state; none can tend so much to promote the general happiness of the species.

STATIUS, PUBLIUS PAPINIUS, a celebrated Latin poet of the first century, was born at Naples, and was the son of Statius, a native of Epirus, who went to Rome to teach poetry and eloquence, and had Domitian for his scholar. Statius the poet also obtained the favour and friendship of that prince; and dedicated to him his *Thebais* and *Achilleis*; the first in twelve books, and the last in two. He died at Naples about the year 100. Besides the above poems, there are also still extant his *Sylvarum*, in five books; the style of which is purer, more agreeable, and more natural, than that of his *Thebais* and *Achilleis*.

STATUARY, a branch of sculpture, employed in the making of statues. See SCULPTURE and the next article.

Statuary is one of those arts wherein the ancients surpassed the moderns; and indeed it was much more popular, and more cultivated, among the former than the latter. It is disputed between statuary and painting, which of the two is the most difficult and the most useful.

Statist.

Statuary.

Statue.

Statuary is also used for the artificer who makes statues. Phidias was the greatest statuary among the ancients, and Michael Angelo among the moderns.

STATUE, is defined to be a piece of sculpture in full relief, representing a human figure. Daviler more scientifically defines statue a representation, in high relief and in bas-relief, of some person distinguished by his birth, merit, or great actions, placed as an ornament in a fine building, or exposed in a public place, to preserve the memory of his worth. In Greece one of the highest honours to which a citizen could aspire was to obtain a statue.

Statues are formed with the chisel, of several matters, as stone, marble, plaster, &c. They are also cast of various kinds of metal, particularly gold, silver, brass, and lead. For the method of casting statues, see the article *FOUNDERY of Statues*.

Statues are usually distinguished into four general kinds. The first are those less than the life; of which kind we have several statues of great men, of kings, and of gods themselves. The second are those equal to the life; in which manner it was that the ancients, at the public expence, used to make statues of persons eminent for virtue, learning, or the services they had done. The third are those that exceed the life; among which those that surpassed the life once and a half were for kings and emperors; and those double the life, for heroes. The fourth kind were those that exceeded the life twice, thrice, and even more, and were called *colossal statues*. See *Colossus*.

Every statue resembling the person whom it is intended to represent, is called *Naturalistick*. Statues acquire various other denominations. 1. Thus, allegorical statue is that which, under a human figure, or other symbol, represents something of another kind; as a part of the earth, a season, age, element, temperament, hour, &c. 2. Carule statues, are those which are represented in chariots drawn by tigre or quadrigæ, that is, by two or four horses; of which kind there were several in the circuses, hippodromes, &c. or in cars, as we see some, with triumphal arches on antique medals. 3. Equestrick statue, that which represents some illustrious person on horseback, as that famous one of Marcus Aurelius at Rome; that of King Charles I. at Charing-cross; King George II. in Leicester Square, &c. 4. Greek statue, denotes a figure that is naked and antique; it being in this manner the Greeks represented their deities, those of the olympic games, and heroes; the statues of heroes were particularly called *Achilleian statues*, by reason of the great number of figures of Achilles in most of the cities of Greece. 5. Hydraulic statue, is a figure placed as an ornament of a fountain or grotto, or that does the office of a *jet d'eau*, a cock, spout, or the like, by any of its parts, or by any attribute it holds; the like is to be understood of any animal serving for the same use. 6. Pedestrick statue, a statue standing on foot; as that of King Charles II. in the Royal Exchange, and of King James II. in the Privy-Garden. 7. Roman statue, is an appellation given to such as we clothed, and which receive various names from their various dresses. Those of emperors, with long gowns over their armour, were called *statue patulata*; those of captains and cavaliers, with coats of arms, *thoracate*; those of soldiers with cuirasses, *bracate*; those of senators and magistrates, *trabeate*; those of

magistrates with long robes, *togate*; and those of the people with a plain tunic, *unicate*; and, lastly, those of women with long trains, *fulcate*.

Statue
Stream.

In requiring a statue cast in a mould, they touch it up with a chisel, graver, or other instrument, to finish the places which have not come well off: they also clear off the burrs, and what is redundant in the joints and projections.

STATURE. See *DWARF* and *GIANT*.

STATUTE, in its general sense, signifies a law, ordinance, decree, &c. See *LAW*, &c.

STATUTE, in our laws and customs, more immediately signifies an act of parliament made by the three estates of the realm; and such statutes are either general, of which the courts at Westminster must take notice without pleading them; or they are special and private, which last must be pleaded.

STAVESACRE, a species of *DELPHINIUM*, which see. *BOTANY INDEX*.

STAY, a large strong rope employed to support the mast on the fore part, by extending from its upper end towards the fore part of the ship, as the shrouds are extended to the right and left, and behind it. See *MAST*, *RIGGING*, and *SHROUD*.

The *stay* of the fore-mast, which is called the *fore-stay*, reaches from the mast-head towards the bowsprit end; the main stay extends over the bowsprit to the ship's stem; and the mizen-stay is stretched down to that part of the main-mast which lies immediately above the quarter-deck: the fore-top-mast stay comes also to the end of the bowsprit, a little beyond the fore-stay; the main-top-mast stay is attached to the head or hounds of the fore-mast; and the mizen-top-mast stay comes also to the hounds of the main-mast: the fore-top-gallant stay comes to the outer end of the jib-boom; and the main-top-gallant stay is extended to the head of the fore-top-mast.

STAY-SAIL, a sort of triangular sail extended upon a stay. See *SAIL*.

STEAM, is the name given in our language to the Definition. visible moist vapour which arises from all bodies which contain juices easily expelled from them by heats not sufficient for their combustion. Thus we say, the steam of boiling water, of malt, of a tan-bed, &c. It is distinguished from smoke by its not having been produced by combustion, by not containing any soot, and by its being condensible by cold into water, oil, inflammable spirits, or liquids composed of these.

We see it rise in great abundance from bodies when they are heated, forming a white cloud, which diffuses itself and disappears at no very great distance from the body from which it was produced. In this case the surrounding air is found loaded with the water or other juices which seem to have produced it, and the steam seems to be completely soluble in air, as salt is in water, composing while thus united a transparent elastic fluid.

Put in order to its appearance in the form of an opaque white cloud, the mixture with or dissemination in air seems absolutely necessary. If a tea-kettle boils violently, so that the steam is formed at the spout in great abundance, it may be observed, that the visible cloud is not formed at the very mouth of the spout, but at a small distance before it, and that the vapour is perfectly transparent at its first emission. This is rendered still more evident by fitting to the spout of the tea-kettle

Appara
like a
white
cloud

in air.

ten-kettle a glass pipe of any length, and of as large a diameter as we please. The steam is produced as copiously as without this pipe, but the vapour is transparent through the whole length of the pipe. Nay, if this pipe communicate with a glass vessel terminating in another pipe, and if the vessel be kept sufficiently hot, the steam will be as abundantly produced at the mouth of this second pipe as before, and the vessel will be quite transparent. The viscosity therefore of the matter which constitutes the steam is an accidental or extraneous circumstance, and requires the admixture with air; yet this quality again leaves it when united with air by solution. It appears therefore to require a *dissipation* in the air. The appearances are quite agreeable to this notion: for we know that one perfectly transparent body, when minutely divided and diffused among the parts of another transparent body, but not dissolved in it, makes a mists which is visible. Thus oil beaten up with water makes a white opaque mass.

In the mean time, as steam is produced, the water gradually wastes in the tea kettle, and will soon be totally expended, if we continue it on the fire. It is reasonable therefore to suppose, that this steam is nothing but water changed by heat into an aerial or elastic form. If so, we should expect that the privation of this heat would leave it in the form of water again. Accordingly this is fully verified by experiment; for if the pipe fitted to the spout of the tea kettle be surrounded with cold water, no steam will issue, but water will continually trickle from it in drops; and if the process be conducted with the proper precautions, the water which we thus obtain from the pipe will be found equal in quantity to that which disappears from the tea-kettle.

This is evidently the common process for distilling; and the whole appearances may be explained by saying, that the water is converted by heat into an elastic vapour, and that this, meeting with colder air, imparts to it the heat which it carried off as it rose from the heated water, and being deprived of its heat it is again water. The particles of this water being vastly more remote from each other than when they were in the tea-kettle, and thus being diffused in the air, become visible, by reflecting light from their anterior and posterior surfaces, in the same manner as a transparent salt becomes visible when reduced to a fine powder. This diffused water being presented to the air in a very extended surface, is quickly dissolved by it, as powdered salt is in water, and again becomes a transparent fluid, but of a different nature from what it was before, being no longer convertible into water by depositing it of its heat.

Accordingly this opinion, or something very like it, has been long entertained. Muschenbroeck expressly says, that the water in the form of vapour carries off with it all the heat which is continually thrown in by the fuel. But Dr Black was the first who attended minutely to the whole phenomena, and enabled us to form distinct notions of the subject. He had discovered that it was not sufficient for converting ice into water that it be raised to that temperature in which it can no longer remain in the form of ice. A piece of ice of the temperature 32° of Fahrenheit's thermometer will remain a very long while in air of the temperature 35°

before it be all melted, remaining all the while of the temperature 32° , and therefore continually absorbing heat from the surrounding air. By comparing the time in which the ice had its temperature changed from 28° to 32° with the subsequent time of its complete liquefaction, he found that it absorbed about 1.5 or 1.6 times as much heat as would raise its temperature one degree; and he found that one pound of ice, when mixed with one pound of water 1.40 degrees warmer, was just melted, but without rising in its temperature above 32° . Hence he justly concluded, that water differed from ice of the same temperature by containing, as a constituent ingredient, a great quantity of fire, or of the cause of heat, united with it in such a way as not to quit it for another colder body, and therefore so as not to go into the liquor of the thermometer and expand it. Considered therefore as the possible cause of heat, it was latent, which Dr Black expressed by the abbreviated term *LATENT HEAT*. If any more heat was added to the water it was not latent, but would readily quit it for the thermometer, and, by expanding the thermometer, would show what is the degree of this *residual* heat, while fluidity alone is the indication of the *combined* and latent heat.

Dr Black, in like manner, concluded, that in order to convert water into an elastic vapour, it was necessary, not only to increase its uncombined heat till its temperature is 212° , in which state it is just ready to become elastic; but also to pour into it a great quantity of fire, or the cause of heat, which combines with every particle of it, so as to make it repel, or to recede from, its adjoining particles, and thus to make it a particle of an elastic fluid. He supposed that this additional heat might be combined with it so as not to quit it for the thermometer; and therefore so as to be in a latent state, having elastic fluidity for its sole indication.

This opinion was very consistent with the phenomenon of boiling off a quantity of water. The application of heat to it causes it gradually to rise in its temperature till it reaches the temperature 212° . It then begins to send off elastic vapour, and is slowly expended in this way, continuing all the while of the same temperature. The steam also is of no higher temperature, as appears by holding a thermometer in it. We must conclude that this steam contains all the heat which is expended in its formation. Accordingly the heating power of steam is well known; but it is extremely difficult to obtain precise measures of the quantity of heat absorbed by water during its conversion into steam. Dr Black endeavoured to ascertain this point, by comparing the time of raising its temperature a certain number of degrees with the time of boiling it off by the same external heat; and he found that the heat latent in steam, which balanced the pressure of the atmosphere, was not less than 800 degrees. He also directed Dr Irvine of Glasgow to the form of an experiment for measuring the heat actually extricated from such steam during its condensation in the refrigeratory of a still, which was found to be not less than 774 degrees. Dr Black was afterwards informed by Mr Watt, that a course of experiments, which he had made in each of these ways with great precision, determined the latent heat of steam under the ordinary pressure of the atmosphere to be about 948 or 950 degrees. Mr Watt also found that water would distil with great ease

Steam.

Steam.

4.
It is again
converted
into water
by cold.

5
Its appear-
ances ex-
plained.

6
and the
cause of its
conversion,
by Dr
Black's dis-
covery of
latent heat.

7
The tem-
perature at
which it is
produced,
and the
quantity of
heat which
it absorbs.

in which of the temperature 72° ; and that in this case the latent heat of the steam is not less than 1200 or 1300 degrees: and a train of experiments, which he had made by distilling in different temperatures, made him conclude that the sum of the sensible and latent heats is a constant quantity. This is a curious and not an improbable circumstance; but we have no information of the particulars of these experiments. The conclusion evidently presupposes a knowledge of that particular temperature in which the water has no heat; but this is a point which is still *sub judice*.

This conversion of liquids (or it is not confined to water, but obtains also in ardent spirits, oils, mercury, &c.) is the cause of their boiling. The heat is applied to the bottom and sides of the vessel, and gradually accumulates in the fluid, in a sensible state, uncombined, and ready to quit it and to enter into any body that is colder, and to diffuse itself between them. Thus it enters into the fluid of a thermometer, expands it, and thus gives us the indication of the degree in which it has been accumulated in the water; for the thermometer swells as long as it continues to absorb sensible heat from the water: and when the sensible heat in both is in equilibrium, in a proportion depending on the nature of the two fluids, the thermometer rises no more, because it absorbs no more heat or fire from the water; for the particles of water which are in immediate contact with the bottom, are now (by this gradual expansion of liquidity) at such distance from each other, that their laws of attraction for each other and for heat are totally changed. Each particle either no longer attracts, or perhaps it repels its adjoining particle, and now accumulates round itself a great number of the particles of heat, and forms a particle of elastic fluid, so related to the adjoining new formed particles, as to repel them to a distance at least a hundred times greater than their distances in the state of water. Thus a mass of elastic vapour of sensible magnitude is formed. Being at least ten thousand times lighter than an equal bulk of water, it must rise up through it, as a cork would do, in form of a transparent ball or bubble, and getting to the top, it dissipates, filling the upper part of the vessel with vapour or steam. Thus, by tossing the liquid into bubbles, which are produced all over the bottom and sides of the vessel, it produces the phenomenon of ebullition or boiling. Observe, that during its passage up through the water, it is not changed or condensed; for the surrounding water is already so hot that the sensible or uncombined heat in it, is in equilibrium with that in the vapour, and therefore it is not disposed to absorb any of that heat which is combined as an ingredient of this vapour, and gives it its elasticity. For this reason, it

happens that water will not boil till its whole mass be heated up to 212° ; for if the upper part be colder, it robs the rising bubble of that heat which is necessary for its elasticity, so that it immediately collapses again, and the surface of the water remains still. This may be perceived by holding water in a Florence flask over a lamp or choffer. It will be observed, some time before the real ebullition, that some bubbles are formed at the bottom, and get up a very little way, and then disappear. The distances which they reach before collapsing increase as the water continues to warm further up the mass, till at last it breaks out into boiling. If the handle of a tea-kettle be grasped with the hand, a tremor will be felt for some little time before boiling, arising from the little succussions which are produced by the collapsing of the bubbles of vapour. This is much more violent, and is really a remarkable phenomenon, if we suddenly plunge a lump of red hot iron into a vessel of cold water, taking care that no red part be near the surface. If the hand be now applied to the side of the vessel, a most violent tremor is felt, and sometimes strong thumps: these arise from the collapsing of very large bubbles. If the upper part of the iron be too hot, it warms the surrounding water so much, that the bubbles from below come up through it uncondensed, and produce ebullition without this succussion. The great resemblance of this tremor to the feeling which we have during the shock of an earthquake has led many to suppose that these last are produced in the same way, and their hypothesis, notwithstanding the objections which we have elsewhere stated to it, is by no means unfeasible.

It is owing to a similar cause that violent thumps are sometimes felt on the bottom of a tea-kettle, especially one which has been long in use. Such are frequently cruised on the bottom with a stony concretion. This sometimes is detached in little scales. When one of these is adhering by one end to the bottom, the water gets between them in a thin film. Hence it may be heated considerably above the boiling temperature, and it suddenly rises up in a large bubble, which collapses immediately. A smooth shilling lying on the bottom will produce this appearance very violently, or a thimble with the mouth down.

In order to make water boil, the fire must be applied to the bottom or sides of the vessel. If the heat be applied at the top of the water, it will waste away without boiling; for the very superficial particles are first supplied with the heat necessary for rendering them elastic, and they fly off without agitating the rest (A).

Since this disengagement of vapour is the effect of its

(A) We explained the opaque and cloudy appearance of steam, by saying that the vapour is condensed by coming into contact with the cooler air. There is something in the form of this cloud which is very inexplicable. The particles of it are sometimes very distinguishable by the eye; but they have not the smart star-like brilliancy of very small drops of water, but give the fainter reflection of a very thin film or vesicle like a soap bubble. If we attend also to their motion, we see them descending very slowly in comparison with the descent of a solid drop; and this vesicular constitution is established beyond a doubt by looking at a candle through a cloud of steam. It is seen surrounded by a faint halo with prismatic colours, precisely such as we can demoustrate by optical laws to belong to a collection of vesicles, but totally different from the halo which would be produced by a collection of solid drops. It is very difficult to conceive how these vesicles can be formed of watery particles, each of which was sur-

its elasticity, and since this elasticity is a determined force when the temperature is given, it follows, that fluids cannot boil till the elasticity of the vapour overcomes the pressure of the incumbent fluid and of the atmosphere. Therefore, when this pressure is removed or diminished, the fluids must sooner overcome what remains, and boil at a lower temperature. Accordingly it is observed that water will boil in an exhausted receiver when of the heat of the human body. If two glass balls A and B (fig. 1.) be connected by a slender tube, and one of them A be filled with water (a small opening or pipe *b* being left at top of the other), and this be made to boil, the vapour produced from it will drive all the air out of the other, and will at last come out itself, producing steam at the mouth of the pipe. When the ball B is observed to be occupied by transparent vapour, we may conclude that the air is completely expelled. Now that the pipe by sticking it into a piece of tallow or bees-wax; the vapour in B will soon condense, and there will be a vacuum. The flame of a lamp and blow-pipe being directed to the little pipe, will cause it immediately to close and seal hermetically. We now have a pretty instrument or toy called a PNEUMATIC GLASS. Grasp the ball A in the hollow of the hand; the heat of the hand will immediately expand the bubble of vapour which may be in it, and this vapour will drive the water into B, and then will blow up through it for a long while, keeping it in a state of violent ebullition, as long as there remains a drop or film of water in A. But care must be taken that B is all the while kept cold, that it may condense the vapour as fast as it rises through the water. Touching B with the hand, or breathing warm on it, will immediately stop the ebullition in it. When the water in A has thus been dissipated, grasp B in the hand; the water will be driven into A, and the ebullition will take place there as it did in B. Putting one of the balls into the mouth will make the ebullition more violent in the other, and the one in the mouth will feel very cold. This is a pretty illustration of the rapid absorption of the heat by the particles of water which are thus converted into elastic vapour. We have seen this little toy suspended by the middle of the tube like a balance, and thus placed in the inside of a window, having two holes *a* and *b* cut in the pane, in such a situation that when A is full of water and preponderates, B is opposite to the hole *b*. Whenever the room became sufficiently warm, the vapour *v* as formed in A, and immediately drove the water into B, which was kept cool by the air coming into the room through the hole *b*. By this means B was made to preponderate in its turn, and A was then opposite to the hole *a*, and the process was now repeated in the opposite direction; and this amusement continued as long as the room was warm enough.

We know that liquors differ exceedingly in the temperatures necessary for their ebullition. This forms the

Vol. XIX. Part II.

great chemical distinction between volatile and fixed bodies. But the difference of temperature in which they boil, or are converted into permanently elastic vapour, under the pressure of the atmosphere, is not a certain measure of their differences of volatility. The natural boiling point of a body is that in which it will be converted into elastic vapour under no pressure, or *in vacuo*. The boiling point in the open air depends on the law of the elasticity of the vapour in relation to its heat. A fluid A may be less volatile, that is, may require more heat to make it boil *in vacuo*, than a fluid B: But if the elasticity of the vapour of A be more increased by an increase of temperature than that of the vapour of B, A may boil at as low, or even at a lower temperature, in the open air, than B does; for the increased elasticity of the vapour of A may sooner overcome the pressure of the atmosphere. Few experiments have been made on the relation between the temperature and the elasticity of different vapours. So long ago as the year 1765, we had occasion to examine the boiling points of all such liquors as we could manage in an air-pump; that is, such as did not produce vapours which destroyed the valves and the leathers of the pistons: and we thought that the experiments gave us reason to conclude, that the elasticity of all the vapours was affected by heat nearly in the same degree. For we found that the difference between their boiling points in the air and *in vacuo* was nearly the same in all, namely, about 125 degrees of Fahrenheit's thermometer. It is exceedingly difficult to make experiments of this kind: The vapours are so condensible, and change their elasticity so prodigiously by a trifling change of temperature, that it is almost impossible to examine this point with precision. It is, however, as we shall see by and bye, a subject of considerable practical importance in the mechanic arts; and an accurate knowledge of the relation would be of great use also to the distiller: and it would be no less important to discover the relation of their elasticity and density, by examining their compressibility, in the same manner as we have ascertained the relation in the case of what we call *aerial fluids*, that is, such as we have never observed in the form of liquids or solids, except in consequence of their union with each other or with other bodies. In the article PNEUMATICS we took notice of it as something like a natural law, that all these airs, or gases as they are now called, had their elasticity very nearly, if not exactly proportional to their density. This appears from the experiments of Acharde, of Fontana, and others, on vital air, inflammable air, fixed air, and some others. It gives us some presumption to suppose that it holds in all elastic vapours whatever, and that it is connected with their elasticity; and it renders it somewhat probable that they are all elastic, only because the cause of heat (the matter of fire if you will) is elastic, and that their law of elasticity, in respect of density, is the same with that of fire. But it must

4 M

be

rounded with many particles of fire, now communicated to the air, and how each of these vesicles shall include within it a ball of air; but we cannot refuse the fact. We know, that if, while linseed oil is boiling or nearly boiling, the surface be obliquely struck with the ladle, it will be dashed into a prodigious number of exceedingly small vesicles, which will float about in the air for a long while. Mr Sausure was (we think) the first who distinctly observed this vesicular form of mists and clouds; and he makes considerable use of it in explaining several phenomena of the atmosphere.

Steam.
12
No fluid can boil till the elasticity of the vapour overcome the pressure of the incumbent bodies.
Plate
DL
Fig. 1.

Steam.

14
Difference between their boiling points in air and *in vacuo*.

13
Liquors differ much in the temperature necessary for their ebullition.

Stream.
To what
the elasti-
city of fluids
is owing.

be observed, that although we thus assign the elasticity of fire as the immediate cause of the elasticity of vapour, in the same way, and on the same grounds, that we ascribe the fluidity of brine to the fluidity of the water which holds the solid salt in solution, it does not follow that this is owing, as is commonly supposed, to a repulsion or tendency to recede from each other exerted by the particles of fire. We are as much entitled to infer a repulsion of unlimited extent between the particles of water; for we see that by its means a single particle of sea-salt becomes disseminated through the whole of a very large vessel. If water had not been a visible and palpable substance, and the salt only had been visible and palpable, we might have formed a similar notion of chemical solution. But we, on the contrary, have considered the *quaqueversum* motion or expansion of the salt as a dissemination among the particles of water; and we have ascribed it to the strong attraction of the atoms of salt for the atoms of water, and the attraction of these last for each other, thinking that each atom of salt accumulates round itself a multitude of watery atoms, and by so doing must recede from the other saline atoms. Nay, we farther see, that by forces which we naturally consider as attractions, an expansion may be produced of the whole mass, which will act against external mechanical forces. It is thus that wood swells with almost insuperable force by imbibing moisture; it is thus that a sponge immersed in water becomes really an elastic compressible body; resembling a blown bladder; and there are appearances which warrant us to apply this mode of conception to elastic fluids.—When air is suddenly compressed, a thermometer included in it shows a rise of temperature; that is, an appearance of heat now redundant which was formerly combined. The heat seems to be squeezed out as the water from the sponge.

Accordingly this opinion, that the elasticity of steam and other vapours is owing merely to the attraction for fire, and the consequent dissemination of their particles through the whole mass of fire, has been entertained by many naturalists, and it has been ascribed entirely to attraction. We by no means pretend to decide; but we think the analogy by far too slight to found any confident opinion on it. The aim is to solve phenomena by attraction only, as if it were of more early conception than repulsion. Considered merely as facts, they are quite on a par. The appearances of nature in which we observe actual recesses of the parts of body from each other, are as distinct, and as frequent and familiar, as the appearances of actual approach. And if we attempt to go farther in our contemplation, and to conceive the way and the forces by which either the approximation or recesses of the atoms are produced, we must acknowledge that we have no conception of the matter; and we can only say, that there is a cause of these motions, and we call it a force, as in every case of the production of motion. We call it attraction or repulsion just as we happen to contemplate an access or a recess. But the analogy here is not only slight, but imperfect, and fails most in those cases which are most simple, and where we should expect it to be most complete. We can squeeze water out of a sponge, it is true, or out of a piece of green wood; but when the white of an egg, the tremella, or some gums, swell to a hundred times their dry dimensions by imbibing water, we cannot squeeze out a particle. If fluidity (for the

reasoning must equally apply to this as to vapourousness) be owing to an accumulation of the extended matter of fire, which gradually expanded the solid by its very minute additions; and if the accumulation round a particle of ice, which is necessary for making it a particle of water, be so great in comparison of what gives it the expansion of one degree, as experiment obliges us to conclude—it seems an inevitable consequence that all fluids should be many times rarer than the solids from which they are produced. But we know that the difference is trifling in all cases, and in some (water, for instance, and iron) the solid is rarer than the fluid. Many other arguments, (each of them perhaps of little weight when taken alone, but which are all systematically connected) concur in rendering it much more probable that the matter of fire, in causing elasticity, acts immediately by its own elasticity, which we cannot conceive in any other way than as a mutual tendency in its particles to receive from each other; and we doubt not but that, if it could be obtained alone, we should find it an elastic fluid like air. We even think that there are cases in which it is observed in this state. The elastic force of gunpowder is very much beyond the elasticity of all the vapours which are produced in its disintegration, each of them being expanded as much as we can reasonably suppose by the great heat to which they are exposed. The writer of this article exploded some gunpowder mixed with a considerable portion of finely powdered quartz, and another parcel mixed with fine filings of copper. The elasticity was measured by the penetration of the ball which was discharged, and was great in the degree now mentioned. The experiment was so conducted, that much of the quartz and copper was collected; none of the quartz had been melted, and some of the copper was not melted. The heat, therefore, could not be such as to explain the elasticity by expansion of the vapours; and it became not improbable that fire was acting here as a detached chemical fluid by its own elasticity. But to return to our subject.

There is one circumstance in which we think our own experiments show a remarkable difference (at least in degree) between the condensible and incondensibles vapours. It is well known, that when air is very suddenly expanded, cold is produced, and heat when it is suddenly condensed. When making experiments with the hopes of discovering the connection between the elasticity and density of the vapours of boiling water, and also of boiling spirits of turpentine, we found the change of density accompanied by a change of temperature vastly greater than in the case of incoercible gases. When the vapour of boiling water was suddenly allowed to expand into five times its bulk, we observed the depression of a large and sensible air thermometer to be at least four or five times greater than in a similar expansion of common air of the same temperature. The chemical reader will readily see reasons for expecting, on the contrary, a smaller alteration of temperature, both on account of the much greater rarity of the fluid, and on account of a partial condensation of its water and the consequent disengagement of combined heat.

This difference in the quantity of fire which is combined in vapours and gases is so considerable, as to authorize us to suppose that there is some difference in the chemical constitution of vapours and gases, and that the connection

Stream.
17
More probably owing to a mutual repulsion between the particles of fire.

18
Probably a great difference between condensibles and incondensibles vapours;
19
and also some difference in the chemical constitution of vapours.

connection between the specific bases of the vapour and the fire which it contains is not the same in air, for instance, as in the vapour of boiling water; and this difference may be the reason why the one is easily condensible by cold, while the other has never been exhibited in a liquid or solid form, except by means of its chemical union with other substances. In this particular instance we know that there is an essential difference—that in vital or atmospheric air there is not only a prodigious quantity of fire which is not in the vapour of water, but that it also contains light, or the cause of light, in a combined state. This is fully evinced by the great discovery of Mr Cavendish of the composition of water. Here we are taught that water (and consequently its vapour) consists of air from which the light and greatest part of the fire have been separated. And the subsequent discoveries of the celebrated Lavoisier show that almost all the condensible gases with which we are acquainted consist either of airs which have already lost much of their fire (and perhaps light too), or of matters in which we have no evidence of fire or light being combined in this manner.

This consideration may go far in explaining this difference in the condensibility of these different species of aerial fluids, the gases and the vapours; and it is with this qualification only that we are disposed to allow that all bodies are condensable into liquids or solids by abstracting the heat. In order that vital air may become liquid or solid, we hold that it is not sufficient that a body be presented to it which shall simply abstract its heat. This would only abstract its uncombined fire. But another and much larger portion remains chemically combined by means of light. A chemical affinity must be brought into action which may abstract, not the fire from the oxygen (to speak the language of Mr Lavoisier), but the oxygen from the fire and light. And our production is not the detached basis of air, but detached heat and light, and the formation of an oxide of some kind.

To prosecute the chemical consideration of STEAMS further than these general observations, which are applicable to all, would be almost to write a treatise of chemistry, and would be a repetition of many things which have been treated of in sufficient detail in other articles of this work. We shall therefore conclude this article with some other observations, which are also general, with respect to the different kinds of coercible vapours, but which have a particular relation to the following article.

Steam or vapour is an elastic fluid, whose elasticity balances the pressure of the atmosphere; and it has been produced from a solid or liquid body raised to a sufficient temperature for giving it this elasticity; that is, for causing the fluid to boil. This temperature must vary with the pressure of the air. Accordingly it is found, that when the air is light (indicated by the barometer being low), the fluid will boil sooner. When the barometer stands at 25 inches, water boils at the temperature 212°. If it stands so low as 23 inches, water will boil at 208°. In the plains of Quito, or at Genoa in Abyssinia, where the barometer stands at about 21 inches, water will boil at 195°. Highly rectified alcohol will boil at 175°, and vitriolic ether will boil at 88° or 89°. This is a temperature by 10 means uncommon in these places; nay, the air is frequently

warmer. Vitriolic ether, therefore, is a liquor which can hardly be known in those countries. It is hardly possible to preserve it in that form. If a phial have not its stopper firmly tied down, it will be blown out, and the liquor will boil and be dissipated in steam. On the top of Chimborazo, the human blood must be disposed to give out air-bubbles.

We said some time ago, that we had concluded, from some experiments made in the receiver of an air pump, that fluids boil *in vacuo* at a temperature nearly 120 degrees lower than that necessary for their boiling in the open air. But we now see that this must have been but a gross approximation; for in these experiments, the fluids were boiling under the pressure of the vapour which they produced, and which could not be abstracted by working the pump. It appears in the experiments of Lord Charles Cavendish, mentioned in the article PNEUMATICS, that water of the temperature 72° was converted into elastic vapour, which balanced a pressure of 4ths of an inch of mercury, and in this state it occupied the receiver, and did not allow the mercury in the gauge to sink to the level. As fast as this was abstracted by working the air-pump, more of it was produced from the surface of the water, so that the pressure continued the same, and the water did not boil. Had it been possible to produce a vacuum above this water, it would have boiled for a moment, and would even have continued to boil, if the receiver could have been kept very cold.

Upon reading these experiments, and some very curious ones of Mr Nairne, in the Phil. Trans. vol. lxxvii, the writer of this article was induced to examine more particularly the relation between the temperature of the vapour and its elasticity, in the following manner:

ABCD (fig. 2.) is the section of a small digester made of copper. Its lid, which is fastened to the body with screws, is pierced with three holes, each of which had a small pipe soldered into it. The first hole was furnished with a brass safety-valve V, nicely fitted to it by grinding. The area of this valve was exactly 4th of an inch. There rested on the stalk at top of this valve the arm of a steelyard carrying a sliding weight. This arm had a scale of equal parts, so adjusted to the weight that the number on the scale corresponded to the inches of mercury, whose pressure on the under surface of the valve is equal to that of the steelyard on its top; so that when the weight was at the division 10, the pressure of the steelyard on the valve was just equal to that of a column of mercury 10 inches high, and 4th of an inch base. The middle hole contained a thermometer T firmly fixed into it, so that no vapour could escape by its sides. The ball of this thermometer was but a little way below the lid. The third hole received occasionally the end of a glass pipe EGF, whose descending leg was about 26 inches long. When this syphon was not used, the hole was properly shut with a plug.

The vessel was half filled with distilled water which had been purged of air by boiling. The lid was then fixed on, having the third hole S plugged up. A lamp being placed under the vessel, the water boiled, and the steam issued copiously by the safety-valve. The thermometer stood at 213, and a barometer in the room at 29.6 inches. The weight was then put on the fifth division. The thermometer immediately began to rise; and when it was at 225, the steam issued by the sides

Steam.

As fluids under the pressure of the vapour which is in them, the elasticity of the vapour is a gross approximation.

As the temperature of the vapour and its elasticity are related to each other.

GENERAL OBSERVATIONS.

22
Steam rises at different temperatures, according as the air is heavy or light.

of the valve. The weight was removed to the 10th division; but before the thermometer could be distinctly observed, the steam was issuing at the valve. The lamp was removed farther from the bottom of the vessel, that the progress of heating might be more moderate; and when the steam ceased to issue from the valve, the thermometer was at 227°. The weight was now shifted to 15; and by gradually approaching the lamp, the steam again issued, and the thermometer was at 132½°. This mode of trial was continued all the way to the 75th division of the scale. The experiments were then repeated in the contrary order; that is, the weight being suspended at the 75th division, and the steam issuing strongly at the valve, the lamp was withdrawn, and the moment the steam ceased to come out, the thermometer was observed. The same was done at the 70th, 65th, division, &c. These experiments were several times repeated both ways; and the means of all the results for each division are expressed in the following table, where column 1st expresses the elasticity of the steam, being the sum of 29.9, and the division of the steelyard; column 2d expresses the temperature of the steam corresponding to this elasticity.

I.	II.
35 inches.	219°
40	226
45	232
50	237
55	242
60	247
65	251
70	255
75	259
80	263
85	267
90	270½
95	274½
100	278
105	281

A very different process was necessary for ascertaining the elasticity of the steam in lower temperatures, and consequently under smaller pressures than that of the atmosphere. The glass syphon SGF was now fixed into its hole in the lid of the digester. The water was made to boil faintly for some time, and the steam issued copiously both at the valve and at the syphon. The lower end of the syphon was now immersed into a broad saucer of mercury, and the lamp instantly removed, and every thing was allowed to grow cold. By this the steam was gradually condensed, and the mercury rose in the syphon, without sensibly sinking in the saucer. The valve and all the joints were smeared with a thick clammy cement, composed of oil, tallow, and rosin, which effectually prevented all ingress of air. The weather was clear and frosty, and the barometer standing at 29.84, and the thermometer in the vessel at 42°. The mercury in the syphon stood at 29.7, or somewhat higher, thus showing a very complete condensation. The whole vessel was surrounded with pounded ice, of the temperature 32°. This made no sensible change in the height of the mercury. A mark was now made at the surface of the mercury. One observer was stationed at the thermometer, with instructions to call out as the thermometer reached the divisions 42, 47, 52,

57, and so on by every five degrees till it should attain the boiling heat. Another observer noted the corresponding descents of the mercury by a scale of inches, which had its beginning placed at 29.84 from the surface of the mercury in the saucer.

The pounded ice was now removed, and the lamp placed at a considerable distance below the vessel, so as to warm its contents very slowly. These observations being very easily made, were several times repeated, and their mean results are set down in the following table: Only observe, that it was found difficult to note down the descents for every fifth degree, because they succeeded each other so fast. Every 10th was judged sufficient for establishing the law of variation. The first column of the table contains the temperature, and the second the descent (in inches) of the mercury from the mark 29.84.

32°	8
40	0.1
50	0.2
60	0.35
70	0.55
80	0.82
90	1.18
100	1.61
110	2.25
120	3.00
130	3.95
140	5.15
150	6.72
160	8.65
170	11.05
180	14.05
190	17.85
200	22.62
210	28.65

Four or five numbers at the top of the column of elasticities are not so accurate as the others, because the mercury passed pretty quickly through these points. But the progress was extremely regular through the remaining points; so that the elasticities corresponding to temperatures above 70° may be considered as very accurately ascertained.

Not being altogether satisfied with the method employed for measuring the elasticity in temperatures above that of boiling water, a better form of experiment was adopted. (Indeed it was the want of other apparatus which made it necessary to employ the former). A glass tube was procured of the form represented in fig. 3, having a little cistern L, from the top and bottom of which proceeded the syphons K and MN. The cistern contained mercury, and the tube MN was of a slender bore, and was about six feet two inches long. The end K was firmly fixed in the third hole of the lid, and the long leg of the syphon was furnished with a scale of inches, and firmly fastened to an upright post.

The lamp was now applied at such a distance from the vessel as to warm it slowly, and make the water boil, the steam escaping for some time through the safety-valve. A heavy weight was then suspended on the steelyard; such as it was known that the vessel would support, and at the same time, such as would not allow the steam to force the mercury out of the long tube. The thermometer began immediately to rise, as also the mercury

mercury in the tube MN. Their corresponding stations are marked in the following table :

Temperature.	Elasticity.
212°	0.0
220	5.9
230	14.6
240	25.0
250	36.9
260	50.4
270	64.2
280	106.0

This form of the experiment is much more susceptible of accuracy than the other, and the measures of elasticity are more to be depended on. In repeating the experiment, they were found much more constant; whereas, in the former method, differences occurred of two inches and upwards.

We may now connect the two sets of experiments into one table, by adding to the numbers in this last table the constant height 29.9, which was the height of the mercury in the barometer during the last set of observations.

Temperature.	Elasticity.
32°	0.0
40	0.1
50	0.3
60	0.35
70	0.55
80	0.82
90	1.25
100	1.6
110	2.25
120	3.0
130	3.95
140	5.15
150	6.72
160	8.65
170	11.05
180	14.05
190	17.85
200	22.62
210	28.65
220	35.8
230	44.7
240	54.9
250	66.8
260	80.3
270	94.1
280	105.9

In the memoirs of the Royal Academy of Berlin for 1782, there is an account of some experiments made by Mr Achard on the elastic force of steam, from the temperature 32° to 212°. They agree extremely well with those mentioned here, rarely differing more than two or three tenths of an inch. He also examined the elasticity of the vapour produced from alcohol, and found, that when the elasticity was equal to that of the vapour of water, the temperature was about 35° lower. Thus, when the elasticity of both was measured by 28.1 inches of mercury, the temperature of the watery vapour was 209°, and that of the spirituous vapour was 173°. When the elasticity was 18.5, the temperature of the water was 189.5, and that of the alcohol 151.6. When the

elasticity was 11.05, the water was 168°, and the alcohol 134°.4. Observing the difference between the temperatures of equally elastic vapours of water and alcohol not to be constant, but gradually to diminish, in Mr Achard's experiments, along with the elasticity, it became interesting to discover whether and at what temperature this difference would vanish altogether. Experiments were accordingly made by the writer of this article, similar to those made with water. They were not made with the same scrupulous care, nor repeated as they deserved, but they furnished rather an unexpected result. The following table will give the reader a distinct notion of them :

Temperature.	Elasticity.
32°	0.0
40	0.1
60	0.8
80	0.8
100	3.9
120	6.9
140	12.3
160	21.5
180	54.
200	52.1
220	78.5
240	115.

We say that the result was unexpected; for as the natural boiling point seemed by former experiments to be in all fluids about 120° or more below their boiling point in the ordinary pressure of the atmosphere, it was reasonable to expect that the temperature at which it ceased to emit sensibly elastic steam would have some relation to their temperatures when emitting steam of any determinate elasticity. Now as the vapour of alcohol of elasticity 30 has its temperature about 36° lower than the temperature of water equally elastic, it was to be expected that the temperature at which it ceased to be sensibly affected would be several degrees lower than 32°. It is evident, however, that this is not the case. But this is a point that deserves more attention, because it is closely connected with the chemical relation between the element (if such there be) of fire and the bodies into whose composition it seems to enter as a constituent part. What is the temperature 32°, to make it peculiarly connected with elasticity? It is a temperature assumed by us for our own convenience, on account of the familiarity of water in our experiments. Ether, we know, boils in a temperature far below this, as appears from Dr Cullen's experiments narrated in the *Essays Physical and Literary of Edinburgh*. On the faith of former experiments, we may be pretty certain that it will boil in vacuo at the temperature -14°, because in the air it boils at +106°. Therefore we may be certain, that the steam or vapour of ether, when of the temperature 32°, will be very sensibly elastic. Indeed Mr Lavoisier says, that if it be expelled in an exhausted receiver in winter, its vapour will support mercury at the height of 10 inches. A series of experiments on this vapour similar to the above would be very instructive. We even wish that those on alcohol were more carefully repeated. If we draw a curve line, of which the abscissa is the line of temperatures, and the ordinates are the corresponding heights of the mercury in these experiments on water and alcohol,

33
Which a tree we l with th. de of Mr A- hard.

we shall observe, that although they both sensibly coincide at 32° , and have the abscissa for their common tangent, a very small error of observation may be the cause of this, and the curve which expresses the elasticity of spirituous vapour may really intersect the other, and go backwards considerably beyond 32° .

This range of experiments gives rise to some curious and important reflections. We now see that no particular temperature is necessary for water assuming the form of permanently elastic vapour; and that it is highly probable that it assumes this form even at the temperature 32° ; only its elasticity is too small to afford us any sensible measure. It is well known that even ice evaporates (see experiments to this purpose by Mr Wilson in the Philosophical Transactions, when a piece of polished metal covered with hoar-frost became perfectly clear by exposing it to a dry frosty wind).

Even mercury evaporates, or is converted into elastic vapour, when all external pressure is removed. The dim film which may frequently be observed in the upper part of a barometer which stands near a stream of air, is found to be small globules of mercury sticking to the inside of the tube. They may be felt by the help of a magnifying glass, and are the best test of a well made barometer. They will be entirely removed by causing the mercury to rise along the tube. It will stick them all up. They consist of mercury which had evaporated in the void space, and was afterwards condensed by the cold glass. But the elasticity is too small to occasion a sensible depression of the column, even when considerably warmed by a candle.

Many philosophers accordingly imagine, that spontaneous evaporation in low temperatures is produced in this way. But we cannot be of this opinion, and must still think that this kind of evaporation is produced by the dissolving power of the air. When moist air is suddenly rarefied, there is always a precipitation of water. This is most distinctly seen when we walk an air-pump briskly. A mist is produced, which we see plainly fall to the bottom of the receiver. But by this new doctrine the very contrary should happen, because the tendency of water to appear in the elastic form is promoted by removing the external pressure; and we really imagine that more of it now actually becomes simple elastic watery vapour. But the mist or precipitation shows incontrovertibly, that there had been a previous solution. Solution is performed by forces which act in the way of attraction; or, to express it more safely, solutions are accompanied by the mutual approaches of the particles of the menstruum and solved: all such tendencies are observed to increase by a diminution of distance. Hence it must follow, that air of double density will dissolve more than twice as much water. Therefore when we suddenly rarefy saturated air (even though its heat should not diminish) some water must be let go. What may be its quantity we know not; but it may be more than what would now become elastic by this diminution of surrounding pressure; and it is not unlikely but this may have some effect in producing the vesicles which we found so difficult to explain. These may be filled with pure watery vapour, and be floating in a fluid composed of water dissolved in air. An experiment of Fontana's seems to put this matter out of doubt. A distilling apparatus AB (fig. 4.)

was so contrived, that the heat was applied above the surface of the water in the alembic A. This was done by inclosing it in another vessel CC, filled with hot water. In the receiver B there was a sort of barometer D, with an open cistern, in order to see what pressure there was on the surface of the fluid. While the receiver and alembic contained air, the heat applied at A produced no sensible distillation during several hours: But on opening a cock E in the receiver at its bottom, and making the water in the alembic to boil, steam was produced which soon expelled all the air, and followed it through the cock. The cock was now shut, and the whole allowed to grow cold by removing the fire, and applying cold water to the alembic. The barometer fell to a level nearly. Then warm water was allowed to get into the outer vessel CC. The barometer rose a little, and the distillation went on briskly without the smallest ebullition in the alembic. The conclusion is obvious: while there was air in the receiver and communicating pipe, the distillation proceeded entirely by the dissolving power of this air. Above the water in the alembic it was quickly saturated; and this saturation proceeded slowly along the still air in the communicating pipe, and at last might take place through the whole of the receiver. The sides of the receiver being kept cold, should condense part of the water dissolved in the air in contact with them, and this should trickle down the sides and be collected. But any person who has observed how long a crystal of blue vitriol will lie at the bottom of a glass of still water before the tinge will reach the surface, will see that it must be next to impossible for distillation to go on in these circumstances; and accordingly none was observed. But when the upper part of the apparatus was filled with pure watery vapour, it was supplied from the alembic as fast as it was condensed in the receiver, just as in the pulse glass.

Another inference which may be drawn from these experiments is, that Nature seems to affect a certain law in the dilatation of aeriform fluids by heat. They seem to be dilatable nearly in proportion of their present dilatation. For if we suppose that the vapours resemble air, in having their elasticity in any given temperature proportional to their density, we must suppose that if steam of the elasticity 60, that is, supporting 60 inches of mercury, were subjected to a pressure of 30 inches, it would expand into twice its present bulk. The augmentation of elasticity therefore is the measure of the bulk into which it would expand in order to acquire its former elasticity. Taking the increase of elasticity therefore as a measure of the bulk into which it would expand under one constant pressure, we see that equal increments of temperature produce nearly equal multiplications of bulk. Thus if a certain diminution of temperature diminishes its bulk 1th, another equal diminution of temperature will diminish this new bulk 1th very nearly. Thus, in our experiments, the temperatures 112° , 140° , 170° , 200° , 230° , are in arithmetical progression, having equal differences; and we see that the corresponding elasticities 2.25, 5.15, 11.05, 22.62, 44.7, are very nearly in the continued proportion of 1 to 2. The elasticity corresponding to the temperature 260 deviates considerably from this law, which would give 88 or 89 instead of 80; and the deviation

320.
These experiments give rise to important reflections.

Vcl. lxx.

26
Spontaneous evaporation produced by the dissolving power of the air.

Fig. 4.

27
A certain law in the dilatation of aeriform fluids by heat.

Steam. deviation increases in the higher temperatures. But will we see that there is a considerable approximation to this law; and it will frequently afford us to recollect, that whatever be the present temperature, an increase of 32 degrees doubles the elasticity and the bulk of watery vapour.

That $\frac{1}{2}^{\circ}$ will increase the elasticity from 1 to $1\frac{1}{2}$

10	-	-	1 to $1\frac{1}{2}$
15	-	-	1 to $1\frac{1}{4}$
12 $\frac{1}{2}$	-	-	1 to $1\frac{1}{3}$
18	-	-	1 to $1\frac{1}{2}$
22	-	-	1 to $1\frac{1}{3}$
24	-	-	1 to $1\frac{1}{4}$
26	-	-	1 to $1\frac{1}{3}$

This is sufficiently exact for most practical purposes. Thus an engineer finds that the injection cools the cylinder of a steam-engine to 192° . It therefore leaves a steam whose elasticity is three-fifths of its full elasticity, ≈ 18 inches $\bar{8}$. But it is better at all times to have recourse to the table. Observe, too, that in the lower temperatures, i. e. below 110° , this increment of temperature does more than double the elasticity.

This law obtains more remarkably in the incoercible vapours; such as vital air, atmospheric air, fixed air, &c. all of which have also their elasticity proportional to their bulk inversely: and perhaps the deviation from the law in steams is connected with their chemical difference of constitution. If the bulk were always augmented in the same proportion by equal augmentations of temperature, the elasticities would be accurately represented by the ordinates of a logarithmic curve, of which the temperatures are the corresponding abscissæ; and we might contrive such a scale for our thermometer, that the temperatures would be the common logarithms of the elasticities, or of the bulks having equal elasticity; or, with our present scale, we may find such a multiplier m for the number x of degrees of our thermometer (above that temperature where the elasticity is equal to unity), that this multiple shall be the common logarithm of the elasticity y ; so that $m \cdot x = \log. y$.

But our experiments are not sufficiently accurate for determining the temperature where the elasticity is measured by 1 inch; because in these temperatures the elasticities vary by exceedingly small quantities. But if we take 11.04 for the unit of elasticity, and number our temperature from 170° , and make $m = 0.010035$, we shall find the product $m \cdot x$ to be very nearly the logarithm of the elasticity. The deviations, however, from this law, are too great to make this equation of any use. But it is very practicable to frame an equation which shall correspond with the experiments to any degree of accuracy; and it has been done for air in a translation of General Roy's Measurement of the Bale at Hounslow Heath into French by Mr Prony. It is as follows: Let x be the degrees of Reaumur's thermometer; let y be the expansion of 10,000 parts of air; let e be ≈ 10 , $m = 2.7979$, $n = 0.1768$: then $y = e^{m \cdot x} - 627.5$. Now e being ≈ 10 , it is plain that $e^{m \cdot x}$ is the number, of which $m \cdot x$ is the common logarithm. This formula is very exact as far as

the temperature 62° : but beyond this it needs a correction; because air, like the vapour of water, does not expand in the exact proportion of its bulk.

We observe this law considerably approximated to in the augmentation of the bulk or elasticity of elastic vapours; that is, it is a fact that a given increment of temperature makes very nearly the same proportional augmentation of bulk and elasticity. This gives us some notion of the manner in which the supposed expanding cause produces the effect. When vapour of the bulk 4 is expanded into a bulk 5 by an addition of 10 degrees of sensible heat, a certain quantity of fire goes into it, and is accumulated round each particle, in such a manner that the temperature of each, which formerly was m , is now $m + 10$. Let it now receive another equal augmentation of temperature. This is now $m + 20$, and

the bulk is $\frac{5 \times 5}{4}$ or $6\frac{1}{4}$, and the arithmetical increase of bulk is $1\frac{1}{4}$.

The absolute quantity of fire which has entered it is greater than the former, both on account of the greater augmentation of space and the greater temperature. Consequently if this vapour be compressed into the bulk 5 , there must be heat or fire in it which is not necessary for the temperature $m + 20$, far less for the temperature $m + 10$. It must therefore emerge, and be disposed to enter a thermometer which has already the temperature $m + 20$: that is, the vapour must grow hotter by compression; not by squeezing out the heat, like water out of a sponge, but because the law of attraction for heat is deranged. It would be a very valuable acquisition to our knowledge to learn with precision the quantity of sensible heat produced in this way; but no satisfactory experiments have yet been made.

M. Lavoisier, with his chemical friends and colleagues, were lately employed in this inquiry: but the wickedness of their countrymen deprived the world of this and many other important additions which we might have expected from this celebrated and unfortunate philosopher. He had made, in conjunction with M. de la Place, a numerous train of accurate and expensive experiments for measuring the quantity of latent or combined heat in elastic vapours. This is evidently a very important point to the distiller and practical chemist. This heat must all come from the fuel; and it is greatly worth while to know whether any saving may be made on this article. Thus we know that distillation will go on either under the pressure of the air, or in an alembic and receiver from which the air has been expelled by steam; and we know that this last may be conducted in a very low temperature, even not exceeding that of the human body. But it is uncertain whether this may not employ even a greater quantity of fuel, as well as occasion a great expense of time. We are disposed to think, that when there is no air in the apparatus, and when the condensation can be speedily performed, the proportion of fuel expended to the fluid which comes over will diminish continually as the heat, and consequently the density of the steam, is augmented; because in this case the quantity of combined heat must be less. In the mean time, we earnestly recommend the trial of this mode of distillation in vessels cleared of air. It is undoubtedly of great advantage to be able to work with smaller fires, and it would secure us against all accidents of blowing off the

29
And is con- siderably pro- portional to the aug- mentation of the bulk or elasticity of elastic vapours.

33
Obtains more remarkably in the incoercible vapours.

the head of the fill, often attended with terrible consequences (B).

We must not conclude this article without taking notice of some natural phenomena which seem to owe their origin to the action of elastic steam.

We have already taken notice of the resemblance of the tremor and succussions observed in the shocks of many earthquakes to those which may be felt in a vessel where water is made to boil internally, while the breaking out of the ebullition is stifled by the cold of the upper parts; and we have likewise stated the objections which are usually made to this theory of earthquakes. We may perhaps resume the subject under the article VOLCANO; but in the mean time we do not hesitate to say, that the wonderful appearances of the Geyzer spring in Iceland (see HUER; and ICELAND, N^o 3—5.) are undoubtedly produced by the expansion of steam in ignited caverns. Of these appearances we suppose the whole train to be produced as follows.

A cavern may be supposed of a shape analogous to CBDEF (fig. 5.), having a perpendicular funnel AB issuing from a depressed part of the roof. The part F may be lower than the rest, remote, and red-hot. Such places we know to be frequent in Iceland. Water may be continually trickling into the part CD. It will fill it up to B, and even up to E, e, and then trickle slowly along into F. As soon as any gets into contact with an ignited part, it expands into elastic steam, and is partly condensed by the cold sides of the cavern, which it gradually warms, till it condenses no more. This production of steam hinders not in the smallest degree the trickling of more water into F, and the continual production of more steam. This now presses on the surface of the water in CD, and causes it to rise gradually in the funnel BA; but slowly, because its cold surface is condensing an immense quantity of steam. We may easily suppose that the water trickles faster into F than it is expended in the production of steam; so that it reaches farther into the ignited part, and may even fall in a stream into some deeper pit highly ignited. It will now produce steam in vast abundance, and of prodigious elasticity; and at once push up the water through the funnel in a foetid jet, and to a great height. This must continue till the surface of the water sinks to BD. If the lower end of the funnel have any inequalities or notches, as is most likely, the steam will get admission

along with the water, which in this particular place is boiling hot, being superficial, and will get to the mouth of the funnel, while water is still pressed in below. At last the steam gets in at B on all sides; and as it is converging to B, along the surface of the water, with prodigious velocity it sweeps along with it much water, and blows it up through the funnel with great force. When this is over, the remaining steam blows out unmixed with water, growing weaker as it is expended, till the bottom of the funnel is again stopped by the water increasing in the cavern CBD. All the phenomena above ground are perfectly conformable to the necessary consequences of this very probable construction of the cavern. The feeling of being lifted up, immediately before the jet, in all probability is owing to a real heaving up of the whole roof of the cavern by the first expansion of the great body of steam. We had an accurate description of the phenomena from persons well qualified to judge of these matters who visited these celebrated springs in 1789.

STEAM-Engine, is the name of a machine which derives its moving power from the elasticity and condensibility of the steam of boiling water. It is the most valuable present which the arts of life have ever received from the philosopher. The mariner's compass, the telescope, gunpowder, and other most useful servants to human weakness and ingenuity, were the productions of chance, and we do not exactly know to whom we are indebted for them; but the steam-engine was, in the very beginning, the result of reflection, and the production of a very ingenious mind; and every improvement it has received, and every alteration in its construction and principles, were also the results of philosophical study.

The steam-engine was beyond all doubt invented by the marquis of Worcester during the reign of Charles II. This nobleman published in 1663 a small book entitled A CENTURY OF INVENTIONS; giving some obscure and enigmatical account of an hundred discoveries or contrivances of his own, which he extols as of great importance to the public. He appears to have been a person of much knowledge and great ingenuity; but his description or accounts of these inventions seem not so much intended to instruct the public, as to raise wonder; and his encomiums on their utility and importance

(B) We earnestly recommend this subject to the consideration of the philosopher. The laws which regulate the formation of elastic vapour, or the general phenomena which it exhibits, give us that link which connects chemistry with mechanical philosophy. Here we see chemical affinities and mechanical forces set in immediate opposition to each other, and the one made the indication, characteristic, and measure of the other. We have not the least doubt that they make but one science, the Science of Universal Mechanics; nor do we despair of seeing the phenomena of solution, precipitation, crystallization, fermentation, nay animal and vegetable secretion and assimilation, successfully investigated, as cases of local motion, and explained by the agency of central forces. Some thing of this kind, and that not inconsiderable, was done when Dr Cullen first showed how the double affinities might be illustrated by the assistance of numbers. Dr Black gave to this hint (for it was little more) that elegant precision which characterizes all his views. Mr Kirwan has greatly promoted this study by his numerous and ingenious examples of its application; and the most valuable passages of the writings of Mr Lavoisier, are those where he traces with logical precision the balancing of force which appear in the chemical phenomena. It is from the similar balancings and consequent measurements, which may be observed and obtained in the present case, that we are to hope for admission into this almost unbounded science of contemplation. We have another link equally interesting and promising, viz. the production of heat by friction. This also highly deserves the consideration of the mathematical philosopher.

Steam-Engine.

ance are to a great degree extravagant, resembling more the puff of an advertising tradesman than the patriotic communications of a gentleman. The marquis of Worcester was indeed a projector, and very importunate and mysterious withal in his applications for public encouragement. His account, however, of the steam-engine, although by no means fit to give us any distinct notions of its structure and operation, is exact as far as it goes, agreeing precisely with what we now know of the subject. It is N^o 68. of his inventions. His words are as follow: "This admirable method which I propose of raising water by the force of fire has no bounds if the vessels be strong enough: for I have taken a cannon, and having filled it three-fourths full of water, and shut up its muzzle and touch-hole, and exposed it to the fire for 24 hours, it burst with a great explosion. Having afterwards discovered a method of fortifying vessels internally, and combined them in such a way that they filled and acted alternately, I have made the water spout in an uninterrupted stream 40 feet high; and one vessel of rarified water raised 40 of cold water. The person who conducted the operation had nothing to do but turn two cocks; so that one vessel of water being consumed, another begins to force, and then to fill itself with cold water, and so on in succession."

But first reduced to practice by Captain Savary.

It does not appear that the noble inventor could ever interest the public by these accounts. His character as a projector, and the many failures which persons of this turn of mind daily experience, probably prejudiced people against him, and prevented all attention to his projects. It was not till towards the end of the century, when experimental philosophy was prosecuted all over Europe with uncommon ardour, that these notions again engaged attention. Captain Savary, a person also of great ingenuity and ardent mind, saw the reality and practicability of the marquis of Worcester's project. He knew the great expansive power of steam, and had discovered the inconceivable rapidity with which it is reconverted into water by cold; and he soon contrived a machine for raising water, in which both of these properties were employed. He says, that it was entirely his own invention. Dr Desaguliers insists that he only copied the marquis's invention, and charges him with gross plagiarism, and with having bought up and burned the copies of the marquis's book, in order to secure the honour of the discovery to himself. This is a very grievous charge, and should have been substantiated by very distinct evidence. Desaguliers produces none such; and he was much too late to know what happened at that time. The argument which he gives is a very foolish one, and gave him no title to consider Savary's experiment as a falsehood; for it might have happened precisely as Savary relates, and not as it happened to Desaguliers. The fact is, that Savary obtained his patent of invention after a hearing of objections, among which the discovery of the marquis of Worcester was not mentioned: and it is certain that the account given in the Century of Inventions could instruct no person who was not sufficiently acquainted with the properties of steam to be able to invent the machine himself.

3
Papin has no claim to the invention as the French pretend.

3
Captain Savary obtained his patent *after having actually erected several machines*, of which he gave a description in a book intitled *THE MINER'S FRIEND*, published in 1696, and in another work published in 1699. Much about this time Dr Papin, a Frenchman and fel-

Steam-Engine.

low of the Royal Society, invented a method of dissolving bones and other animal solids in water, by confining them in close vessels, which he called *DIGESTERS*, so as to acquire a great degree of heat. For it must be observed in this place, that it had been discovered long before (in 1684) by Dr Hooke, the most inquisitive experimental philosopher of that inquisitive age, that water could not be made to acquire above a certain temperature in the open air; and that as soon as it begins to boil, its temperature remains fix'd, and an increase of heat only produces a more violent ebullition, and a more rapid waste. But Papin's experiments made the elastic power of steam very familiar to him: and when he left England and settled as professor of mathematics at Marburgh, he made many awkward attempts to employ this force in mechanics, and even for raising water. It appears that he had made experiments with this view in 1698, by order of Charles, landgrave of Hesse. For this reason the French affect to consider him as the inventor of the steam-engine. He indeed published some account of his invention in 1707; but he acknowledges that Captain Savary had also, and without any communication with him, invented the same thing. Whoever will take the trouble of looking at the description which he has given of their inventions, which are to be seen in the *Acta Eruditorum Lipsie*, and in Leupold's *Theatrum Mechanarum*, will see that they are most awkward, absurd, and impracticable. His conceptions of natural operations were always vague and imperfect, and he was neither philosopher nor mechanic.

We are thus anxious about the claim of those gentlemen, because a most respectable French author, Mr Boswell, says in his *Hydrodynamique*, that the first notion of the steam-engine was *certainly* owing to Dr Papin, who had not only invented the digester, but had in 1695 published a little performance describing a machine for raising water, in which the pistons are moved by the vapour of boiling water alternately dilated and condensed. Now the fact is, that Papin's first publication was in 1707, and his piston is nothing more than a floater on the surface of the water, to prevent the waste of steam by condensation; and the return of the piston is not produced, as in the steam-engine, by the condensation of the steam, but by admitting the air and a column of water to press it back into its place. The whole contrivance is so awkward, and so unlike any distinct notions of the subject, that it cannot do credit to any person. We may add, that much about the same time Mr Amontons contrived a very ingenious but intricate machine, which he called a *fire-wheel*. It consisted of a number of buckets placed in the circumference of a wheel, and communicating with each other by very intricate circuitous passages. One part of this circumference was exposed to the heat of a furnace, and another to a stream or column of cold water. The communications were so disposed, that the steam produced in the buckets on one side of the wheel drove the water into buckets on the other side, so that one side of the wheel was always much heavier than the other; and it must therefore turn round, and may execute some work. The death of the inventor, and the intricacy of the machine, caused it to be neglected. Another member of the Parisian academy of sciences (Mr Deslandes) also presented to the academy a project of a steam-wheel, where the impulsive force of the va-

4
Mr Amontons's fire-wheel.

Steam-Engine.

pour was employed; but it met with no encouragement. The English engineers had by this time so much improved Savary's first invention, that it supplanted all others. We have therefore no hesitation in giving the honour of the first and complete invention to the marquis of Worcester; and we are not disposed to refuse Captain Savary's claim to originality as to the construction of the machine, and even think it probable that his own experiments made him see the whole, independent of the marquis's account.

Captain Savary's engine, as improved and simplified by himself, is as follows.

Fig. 6.
Captain Savary's Steam-engine described.

A (fig. 6.) represents a strong copper boiler properly built up in a furnace. There proceeds from its top a large steam-pipe B, which enters into the top of another through vessel R called the RECEIVER. This pipe has a cock at C called the STEAM-COCK. In the bottom of the receiver is a pipe F, which communicates sidewise with the rising pipe KGH. The lower end H of this pipe is immersed in the water of the pit or well, and its upper part K opens into the cistern into which the water is to be delivered. Immediately below the pipe of communication F there is a valve G, opening when pressed from below, and shutting when pressed downwards. A similar valve is placed at I, immediately above the pipe of communication. Lastly, there is a pipe ED which branches off from the rising pipe, and enters into the top of the receiver. This pipe has a cock D called the INJECTION-COCK. The mouth of the pipe ED has a nozzle *f* pierced with small holes, pointing from a centre in every direction. The keys of the two cocks C and D are united, and the handle *g h* is called the REGULATOR.

Let the regulator be so placed that the steam-cock C is open and the injection-cock D is shut: put water into the boiler A, and make it boil strongly. The steam coming from it will enter the receiver, and gradually warm it, much steam being condensed in producing this effect. When it has been warmed so as to condense no more, the steam proceeds into the rising pipe; the valve G remains shut by its weight; the steam lifts the valve I, and gets into the rising pipe, and gradually warms it. When the workman feels this to be the case, or hears the rattling of the valve I, he immediately turns the steam-cock so as to shut it, the injection-cock still remaining flat (at least we may suppose this for the present). The apparatus must now cool, and the steam in the receiver collapses into water. There is nothing now to balance the pressure of the atmosphere; the valve I remains shut by its weight; but the air incumbent on the water in the pit presses up this water through the suction-pipe HG, and causes it to lift the valve G, and flow into the receiver R, and fill it to the top, if not more than 20 or 25 feet above the surface of the pit water.

The steam-cock is now opened. The steam which, during the cooling of the receiver, has been accumulating in the boiler, and acquiring a great elasticity by the action of the fire, now rushes in with great violence, and, pressing on the surface of the water in the receiver, causes it to shut the valve G and open the valve I by its weight alone, and it now flows into the rising pipe, and would stand on a level if the elasticity of the steam were no more than what would balance the atmospheric pressure. But it is much more than this, and therefore

it presses the water out of the receiver into the rising pipe, and will even cause it to come out at K, if the elasticity of the steam is sufficiently great. In order to ensure this, the boiler has another pipe in its top, covered with a safety-valve V, which is kept down by a weight W suspended on a steelyard LM. This weight is so adjusted that its pressure on the safety-valve is somewhat greater than the pressure of a column of water V *h* as high as the point of discharge K. The fire is so regulated that the steam is always issuing a little by the loaded valve V. The workman keeps the steam-valve open till he hears the valve I rattle. This tells him that the water is all forced out of the receiver, and that the steam is now following it. He immediately turns the regulator which shuts the steam-cock, and now, for the first time, opens the injection-cock. The cold water trickles at first through the holes of the nozzle *f*, and falling down through the steam, begins to condense it; and then its elasticity being less than the pressure of the water in the pipe KED, the cold water spouts in all directions through the nozzle, and, quick as thought, produces a complete condensation. The valve G now opens again by the pressure of the atmosphere on the water of the pit, and the receiver is soon filled with cold water. The injection-cock is now shut, and the steam-cock opened, and the whole operation is now repeated; and so on continually.

This is the simple account of the process, and will serve to give the reader an introductory notion of the operation; but a more minute attention must be paid to many particulars before we can see the properties and defects of this ingenious machine.

The water is driven along the rising pipe by the ⁶elasticity of the steam. This must in the boiler, and this machine such, every part of the machine, exert a pressure on every square inch of the vessels equal to that of the upright column of water. Suppose the water to be raised 100 feet, about 25 of this may be done in the suction-pipe; that is, the upper part of the receiver may be about 25 feet above the surface of the pit-water. The remaining 75 must be done by forcing, and every square inch of the boiler will be squeezed out by a pressure of more than 30 pounds. This very moderate height therefore requires very strong vessels; and the marquis of Worcester was well aware of the danger of their bursting. A copper boiler of six feet diameter must be nine-tenths of an inch thick to be just in equilibrio with this pressure; and the soldered joint will not be able to withstand it, especially in the high temperature to which the water must be heated in order to produce steam of sufficient elasticity. By consulting the table of the elasticity of steam deduced from our experiments mentioned in the preceding article, we see that this temperature must be at least 285° of Fahrenheit's thermometer. In this heat soft solder is just ready to melt, and has no tenacity; even spelter solder is considerably weakened by it. Accordingly, in a machine erected by Dr Desaguliers, the workman having loaded the safety-valve a little more than usual to make the engine work more briskly, the boiler burst with a dreadful explosion, and blew up the furnace and adjoining parts of the building as if it had been gunpowder. Mr Savary succeeded pretty well in raising moderate quantities of water to small heights, but could make nothing of deep mines. Many attempts were made, on the marquis's

Steam-Engine.

Steam-Engine.

quib's principle, to strengthen the vessels from within by radiated bars and by hoops, but in vain. Very small boilers or evaporators were then tried, kept red hot, or nearly so, and supplied with a slender stream of water trickling into them; but this afforded no opportunity of making a collection of steam during the refrigeration of the receiver, so as to have a magazine of steam in readiness for the next forcing operation; and the working of such machines was always an employment of great danger and anxiety.

The only situation in which this machine could be employed with perfect safety, and with some effect, was where the whole lift did not exceed 30 or 35 feet. In this case the greatest part of it was performed by the suction-pipe, and a very manageable pressure was sufficient for the rest. Several machines of this kind were erected in England about the beginning of this century. A very large one was erected at a salt-work in the south of France. Here the water was to be raised no more than 18 feet. The receiver was capacious, and was occasionally supplied with steam from a small salt-pan constructed on purpose with a cover. The entry of the steam into the receiver merely allowed the water to run out of it by a large valve, which was opened by the hand, and the condensation was produced by the help of a small forcing pump also worked by the hand. In so particular a situation as this (and many such may occur in the endless variety of human wants), this is a very powerful engine; and having few moving and rubbing parts, it must be of great durability. This circumstance has occasioned much attention to be given to this first part of the engine, even long after it was supplanted by what is a much better construction. A very ingenious attempt was made very lately to adapt this construction to the uses of the miners. The whole depth of the pit was divided into lifts of 15 feet, in the same manner as is frequently done in pump-machines. In each of these was a suction-pipe 14 feet long, having above it a small receiver like R, about a foot high, and its capacity somewhat greater than that of the pipe. This receiver had a valve at the head of the suction-pipe, and another opening outwards into the little cistern, into which the next suction-pipe above dipped to take in water. Each of these receivers sent up a pipe from its top, which all met in the cover of a large vessel above ground, which was of double the capacity of all the receivers and pipes. This vessel was close on all sides. Another vessel of equal capacity was placed immediately above it, with a pipe from its bottom passing through the cover of the lower vessel and reaching near to its bottom. This upper vessel communicates with the boiler, and constitutes the receiver of the steam-engine. The operation is as follows: The lower vessel is full of water. Steam is admitted into the upper vessel, which expels the air by a valve, and fills the vessel. It is then condensed by cold water. The pressure of the atmosphere would cause it to enter by all the suction-pipes of the different lifts, and press on the surface of the water in the lower receiver, and force it into the upper one. But because each suction-pipe dips in a cistern of water, the air presses this water before it, raises it into each of the little receivers which it fills, and allows the spring of the air (which was formerly in them, but which now presses up into the lower receiver) to force the water out of the lower receiver into the

upper one. When this has been completed, the steam is again admitted into the upper receiver. This allows the water to run back into the lower receiver, and the air returns into the small receivers in the pit, and allows the water to run out of each into its proper cistern. By this means the water of each pipe has been raised 15 feet. The operation may thus be repeated continually.

The contrivance is ingenious, and similar to those which are to be met with in the hydraulics of Schottus, Sturmias, and other German writers. But the operation must be exceedingly slow; and we imagine that the expense of steam must be great, because it must fill a very large and very cold vessel, which must waste a great portion of it by condensation. We see by some late publications of the very ingenious Mr. Blackey, that he is still attempting to maintain the reputation of this machine by some contrivances of this kind; but we imagine that they will be ineffectual, except in some very particular situations.

For the great defect of the machine, even when we can secure it against all risk of bursting, is the prodigious waste of steam, and consequently of fuel. Daily experience shows, that a few scattered drops of cold water are sufficient for producing an almost instantaneous condensation of a great quantity of steam. Therefore when the steam is admitted into the receiver of Savary's engine, and comes into contact with the cold top and cold water, it is condensed with great rapidity; and the water does not begin to bubble till its surface has become so hot that it condenses no more steam. It may now begin to yield to the pressure of the incumbent steam; but as soon as it descends a little, more of the cold surface of the receiver comes into contact with the steam, and condenses more of it, and the water can descend no farther till this addition of cold surface is heated up to the state of evaporation. This rapid condensation goes on all the while the water is descending. By some experiments frequently repeated by the writer of this article, it appears that no less than $\frac{3}{4}$ ths of the whole steam is uselessly condensed in this manner, and not more than $\frac{1}{4}$ th is employed in allowing the water to descend by its own weight; and he has reason to think that the portion thus wasted will be considerably greater, if the steam be employed to force the water out of the receiver to any considerable height.

Observe, too, that all this waste must be repeated in every succeeding stroke; for the whole receiver must be cooled again in order to fill itself with water.

Many attempts have been made to diminish this waste: but all to little purpose, because the very filling of the receiver with cold water occasions its sides to condense a prodigious quantity of steam in the succeeding stroke. Mr. Blackey has attempted to lessen this by using two receivers. In the first was oil; and in this only the steam was admitted. This oil passed to and fro between the two receivers, and never touched the water except in a small surface. But this hardly produced a sensible diminution of the waste: for it must not be observed, that there is a necessity for the first cylinder being cooled to a considerable degree below the boiling point of the water, though it will cool the steam, and allow the water to rise into the receiver, there will be a great diminution of the height of action, unless the vessel be much cooled. This appears plainly

Steam-Engine.

8
 Occasions
 can secure it
 against all
 risk of burst-
 ing. Prodigious
 waste of steam,
 and consequent-
 ly of fuel.

9
 Attempts
 made to
 diminish
 this waste
 have been
 all to little
 purpose.

7
 hat it can
 be employ-
 ed with
 advantage
 only in cer-
 tain situa-
 tions.

by inspecting the table of elasticity. Thus, if the vessel be cooled no lower than 180° , we should lose one half of the pressure of the atmosphere; if cooled to 120, we should still lose $\frac{1}{2}$ th. The inspection of this table is of great use for understanding and improving this noble machine; and without a constant recollection of the elasticity of steam corresponding to its actual heat, we shall never have a notion of the niceties of its operation.

The rapidity with which the steam is condensed is really astonishing. Experiments have been made on steam-vessels of six feet in diameter and seven feet high; and it has been found, that about four ounces of water, as warm as the human blood, will produce a complete condensation in less than a second; that is, will produce all the condensation that it is capable of producing, leaving an elasticity about one-fifth of the elasticity of the air. In another experiment with the same steam-vessel, no cold water was allowed to get into it, but it was made to communicate by a long pipe four inches in diameter with another vessel immersed in cold water. The condensation was so rapid that the time could not be measured: it certainly did not exceed half a second. Now this condensation was performed by a very trifling surface of contact. Perhaps we may explain it a little in this way: When a mass of steam, in immediate contact with the cold water, is condensed, it leaves a void, into which the adjoining steam instantly expands; and by this very expansion its capacity for heat is increased, or it grows cold, that is, abstracts the heat from the steam situated immediately beyond it. And in this expansion and refrigeration it is itself partly condensed or converted into water, and leaves a void, into which the circumjacent steam immediately expands, and produces the same effect on the steam beyond it. And thus it may happen that the abstraction of a small quantity of heat from an inconsiderable mass of steam may produce a condensation which may be very extensive. Did we know the change made in the capacity of steam for heat by a given change of bulk, we should be able to tell exactly what would be the effect of this local actual condensation. But experiment has not as yet given us any precise notions on this subject. We think that this rapid condensation to a great distance by a very moderate actual abstraction of heat is a proof that the capacity of steam for heat is prodigiously increased by expansion. We say a very moderate actual abstraction of heat, because very little heat is necessary to raise four ounces of blood-warm water to a boiling temperature, which will unfit it for condensing steam. The remarkable phenomenon of snow and ice produced in the Hungarian machine, when the air condensed in the receiver is allowed to blow through the cock (see PNEUMATICS), shows this to be the case in moist air, that is, in air holding water in a state of chemical solution. We see something very like it in a thunder-storm. A small black cloud sometimes appears in a particular spot, and in a very few seconds spreads over many hundred acres of sky, that is, a precipitation of water goes on with that rapid diffusion. We imagine that this increase of capacity or de-

mand for heat, and the condensation that must ensue if this demand is not supplied, is much more remarkable in pure watery vapours, and that this is a capital distinction of their constitution from vapours dissolved in air (A).

The reader must now be so well acquainted with what passes in the steam-vessel, and with the exterior results from it, as readily to comprehend the propriety of the changes which we shall now describe as having been made in the construction and principle of the steam engine.

Of all places in England the tin-mines of Cornwall stood most in need of hydraulic assistance; and Mr Savary was much engaged in projects for draining them by his steam-engine. This made its construction and principles well known among the machinists and engineers of that neighbourhood. Among these were a Mr Newcomen, an ironmonger or blacksmith, and Mr Cawley a glazier at Dartmouth in Devonshire, who had dabbled much with this machine. Newcomen was a person of some reading, and was in particular acquainted with the perlon, writings, and projects of his countryman Dr Hooke. There are to be found among Hooke's papers, in the possession of the Royal Society, some notes of observations, for the use of Newcomen his countryman, on Papin's boasted method of transmitting to a great distance the action of a mill by means of pipes. Papin's project was to employ the mill to work two air-pumps of great diameter. The cylinders of these pumps were to communicate by means of pipes with equal cylinders furnished with pistons, in the neighbourhood of a distant mine. These pistons were to be connected, by means of levers, with the piston-rods of the mine. Therefore, when the piston of the air-pump at the mill was drawn up by the mill, the corresponding piston at the side of the mine would be pressed down by the atmosphere, and thus would raise the piston-rod in the mine, and draw the water. It would appear from these notes, that Dr Hooke had dissuaded Mr Newcomen from erecting a machine on this principle, of which he had exposed the fallacy in several discourses before the Royal Society. One passage is remarkable. "Could he (meaning Papin) make a speedy vacuum under your second piston, your work is done."

It is highly probable that, in the course of this speculation, it occurred to Mr Newcomen that the vacuum he so much wanted might be produced by steam, and that this gave rise to his new principle and construction of the steam-engine. The specific desideratum was in Newcomen's mind; and therefore, when Savary's engine appeared, and became known in his neighbourhood many years after, he would readily catch at the help which it promised.

Savary, however, claims the invention as his own; but Switzer, who was personally acquainted with both, is positive that Newcomen was the inventor. By his principles (as a quaker) being averse from contention, he was contented to share the honour and the profits with Savary, whose acquaintance at court enabled him to procure the patent in 1705, in which all the three were associated. Posterity has done justice to the modest inventor, and the machine is universally called NEWCOMEN'S

(A) But if it has been found that the condensation requires more cold water than what is allowed above, and it is suspected that the rapidity of condensing a large volume of steam by the cold surface of a vessel is overrated.

Steam-Engine.

MEN'S ENGINE. Its principle and mode of operation may be clearly conceived as follows.

Let A (fig. 7.) represent a great boiler properly built in a furnace. At a small height above it is a cylinder CBBC of metal, bored very truly and smoothly. The boiler communicates with this cylinder by means of the throat or steam-pipe NQ. The lower aperture of this pipe is shut by the plate N, which is ground very flat, so as to apply very accurately to the whole circumference of the orifice. This plate is called the regulator or steam-cock, and it turns horizontally round an axis *l a* which passes through the top of the boiler, and is nicely fitted to the socket, like the key of a cock, by grinding. The upper end of this axis is furnished with a handle *B T*.

A piston P is suspended in this cylinder, and made air-tight by a packing of leather or bit rope, well filled with tallow; and, for greater security, a small quantity of water is kept above the piston. The piston-rod PD is suspended by a chain which is fixed to the upper extremity F of the arched head FD of the great lever or WORKING BEAM HK, which turns on the gudgeon O. There is a similar arched head EG at the other end of the beam. To its upper extremity E is fixed a chain carrying the pump-rod XL, which raises the water from the mine. The load on this end of the beam is made to exceed considerably the weight of the piston P at the other extremity.

At some small height above the top of the cylinder is a cistern W called the INJECTION CISTERN. From this descends the INJECTION PIPE ZSH, which enters the cylinder through its bottom, and terminates in a small hole R, or sometimes in a nozzle pierced with many smaller holes diverging from a centre in all directions. This pipe has at S a cock called the INJECTION COCK, fitted with a handle V.

At the opposite side of the cylinder, a little above its bottom, there is a lateral pipe, turning upwards at the extremity, and there covered by a check-valve *f*, called the SNIFFING VALVE, which has a little dish round it to hold water for keeping it air-tight.

There proceeds also from the bottom of the cylinder a pipe *d e g h* (passing behind the boiler), of which the lower end is turned upwards, and is covered with a valve *h*. This part is immersed in a cistern of water Y, called the HOT WELL, and the pipe itself is called the EDUCTION PIPE. Lastly, the boiler is furnished with a safety-valve called the POPPET CLACK (which is not represented in this sketch for want of room), in the same manner as Savary's engine. This valve is generally loaded with one or two pounds, on the square inch, so that it allows the steam to escape when its elasticity is one tenth greater than that of common air. Thus all risk of bursting the boiler is avoided, and the pressure outwards is very moderate; so also is the heat. For, by inspecting the table of vaporous elasticity, we see that the heat corresponding to 32 inches of elasticity is only about 216° of Fahrenheit's thermometer.

These are all the essential parts of the engine, and are here drawn in the most simple form, till our knowledge of their particular offices shall show the propriety of the peculiar forms which are given to them. Let us now see how the machine is put in motion, and what is the nature of its work.

Steam-Engine.

The water in the boiler being supposed to be in a state of strong ebullition, and the steam issuing by the safety-valve, let us consider the machine in a state of rest, having both the steam-cock and injection-cock shut. The rising position or attitude of the machine must be such as appears in sketch, the pump rods preponderating, and the great piston being drawn up to the top of the cylinder. Now open the steam-cock by turning the handle T of the regulator. The steam from the boiler will immediately rush in, and flying all over the cylinder, will mix with the air. Much of it will be condensed by the cold surface of the cylinder and piston, and the water produced from it will trickle down the sides, and run off by the eduction-pipe. This condensation and waste of steam will continue till the whole cylinder and piston are made as hot as boiling water. When this happens, the steam will begin to open the sniffling valve *f*, and issue through the pipe; slowly at first and very cloudy, being mixed with much air. The blast at *f* will grow stronger by degrees, and more transparent, having already carried off the greatest part of the common air which filled the cylinder. We supposed that the water was boiling briskly, so that the steam was issuing by the safety-valve which is in the top of the boiler, and through every crevice. The opening of the steam-cock puts an end to this at once, and it has sometimes happened that the cold cylinder abstracts the steam from the boiler with such astonishing rapidity, that the pressure of the atmosphere has burst up the bottom of the boiler. We may here mention an accident of which we were witnesses, which also shows the immense rapidity of the condensation. The boiler was in a frail shed at the side of the engine-house; a sheet of snow from the top of the house fell down and broke through the roof of the shed, and was scattered over the head of the boiler, which was of an oblong or oval shape. In an instant the sides of it were squeezed together by the pressure of the atmosphere.

When the manager of the engine perceives that not only the blast at the sniffling valve is strong and steady, but that the boiler is now fully supplied with steam of a proper strength, appearing by the renewal of the discharge at the safety-valve, he shuts the steam-cock, and opens the injection-cock S by turning its handle V. The pressure of the column of water in the injection-pipe ZS immediately forces some water through the spout R. This coming in contact with the pure vapour which now fills the cylinder, condenses it, and thus makes a partial void, into which the more distant steam immediately expands, and by expanding collapses (as has been already observed). What remains in the cylinder no longer balances the atmospheric pressure on the surface of the water in the injection-cistern, and therefore the water spouts rapidly through the hole R by the joint action of the column ZS, and the unbalanced pressure of the atmosphere; at the same time the sniffling-valve *f*, and the eduction-valve *h*, are shut by the unbalanced pressure of the atmosphere. The velocity of the injection water must therefore rapidly increase, and the jet will dash (if single) against the bottom of the piston, and be scattered through the whole capacity of the cylinder. In a very short space of time, therefore, the condensation of the steam becomes universal, and the elasticity of what remains is almost nothing. The whole pressure

13
How the machine is put in motion, and the nature of the work.

Steam-Engine.

pressure of the atmosphere is exerted in the upper surface of the piston, while there is hardly any on its under side. Therefore, if the load on the outer end E of the working beam is inferior to this pressure, it must yield to it. The piston P must descend, and the pump piston L must ascend, bringing along with it the water of the mine, and the motion must continue till the great piston reaches the bottom of the cylinder; for it is not like the motion which would take place in a cylinder of air rarefied to the same degree. In this last case, the impelling force would be continually diminished, because the capacity of the cylinder is diminished by the descent of the piston, and the air in it is continually becoming more dense and elastic. The piston would stop at a certain height, where the elasticity of the included air, together with the load at E, would balance the atmospheric pressure on the piston. But when the contents of the cylinder are pure vapour, and the continued stream of injected cold water keeps down its temperature to the same pitch as at the beginning, the elasticity of the remaining steam can never increase by the descent of the piston, nor exceed what corresponds to this temperature. The impelling or accelerating force therefore remains the same, and the descent of the piston will be uniformly accelerated, if there is not an increase of resistance arising from the nature of the work performed by the other end of the beam. This circumstance will come under consideration afterwards, and we need not attend to it at present. It is enough for our present purpose to see, that if the cylinder has been completely purged of common air before the steam-cock was shut, and if none has entered since, the piston will descend to the very bottom of the cylinder. And this may be frequently observed in a good steam-engine, where every part is air-tight. It sometimes happens, by the pit-pump drawing air, or some part of the communication between the two drains giving way, that the piston comes down with such violence as to knock out the bottom of the cylinder with the blow.

14
The piston does not begin to descend till the moment the injection is made.

The only observation which remains to be made on the motion of the piston in descending is, that it does not begin at the instant the injection is made. The piston was kept at the top by the preponderancy of the outer end of the working beam, and it must remain there till the difference between the elasticity of the steam below it and the pressure of the atmosphere exceeds this preponderancy. There must therefore be a small space of time between the beginning of the condensation and the beginning of the motion. This is very small, not exceeding the third or the fourth part of a second; but it may be very distinctly observed by an attentive spectator. He will see, that the instant the injection-cock is opened, the cylinder will sensibly rise upwards a little by the pressure of the air on its bottom. As the weight is not nearly equal to this pressure; and instead of its being necessary to support it by a strong floor, we must keep it down by strong bolts loaded by heavy balls. It is usual to frame these joints into the posts which carry the axis of the working-beam, and are therefore loaded with the whole strain of the machine. The rising of the cylinder shows the instantaneous commencement of the condensation; and it is not till after this has been distinctly observed that the piston is seen to stir, and begin to descend.

When the manager sees the piston as low as he thinks

proper, he shuts the injection-cock, and opens the steam-cock. The steam has been accumulating above the water in the boiler during the whole time of the piston's descent, and is now rushing violently through the puppet-clack. The moment, therefore, that the steam-cock is opened, it rushes violently into the cylinder, having an elasticity greater than that of the air. It therefore immediately blows open the snifting valve, and allows (at least) the water which had come in by the former injection, and what arose from the condensed steam, to descend by its own weight through the eduction pipe *d e g h* to open the valve *h*, and to run out into the hot well. And we must easily see that this water is boiling-hot; for while lying in the bottom of the cylinder, it will condense steam till it acquires this temperature, and therefore cannot run down till it condenses no more. There is still a waste of steam at its first admission, in order to heat the inside of the cylinder and the injected water to the boiling temperature: but the space being small, and the whole being already very warm, this is very soon done; and when things are properly contrived, little more steam is wanted than what will warm the cylinder; for the eduction pipe receives the injection water even during the descent of the piston, and it is therefore removed pretty much out of the way of the steam.

This first puff of the entering steam is of great service; it drives out of the cylinder the vapour which it finds there. This is seldom pure watery vapour: all water contains a quantity of air in a state of chemical union. The union is but feeble, and a boiling heat is sufficient for disengaging the greater part of it by increasing its elasticity. It may also be disengaged by simply removing the external pressure of the atmosphere. This is clearly seen when we expose a glass of water in an exhausted receiver. Therefore the small space below the piston contains watery vapour mixed with all the air which had been disengaged from the water in the boiler by ebullition, and all that was separated from the injection water by the diminution of external pressures. All this is blown out of the cylinder by the first puff of steam. We may observe in this place, that waters differ exceedingly in the quantity of air which they hold in a state of solution. All spring water contains much of it: and water newly brought up from deep mines contains a great deal more, because the solution was aided in these situations by great pressures. Such waters sparkle when poured into a glass. It is therefore of great consequence to the good performance of a steam-engine to use water containing little air, both in the boiler and in the injection-cistern. The water of running brooks is preferable to all others, and the freest it is from any saline impregnation it generally contains little air. Such engines as are so unfortunately situated that they are obliged to employ the very water which they have brought up from great depths, are found greatly inferior in their performance to others. The little air collected below the piston greatly diminishes the accelerating force, and the expulsion of such a quantity requires a long-continued blast of the best steam at the beginning of every stroke. It is advisable to keep such water in a large shallow pond for a long while before using it.

Let us now consider the state of the piston. It is now evident that it will start or begin to rise the moment

Steam-Engine.

15
The circumstance that succeeds the descent of the piston.

16
The first puff of steam.

17
The great consequence to the good performance of a steam-engine, that the water employed contains little air.

18
The piston rises.

Steam-Engine.

the steam-cock is opened; for at that instant the excess of atmospheric pressure, by which it was kept down in opposition to the preponderancy of the outer end of the beam, is diminished. The piston is therefore dragged upwards, and it will rise even although the steam which is admitted be not so elastic as common air. Suppose the mercury in the barometer to stand at 30 inches, and that the preponderancy at the outer end of the beam is $\frac{1}{4}$ th of the pressure of the air on the piston, the piston will not rise if the elasticity of the steam is not equal to $30 - \frac{1}{4}$, that is, to 26.7 inches nearly; but if it is just this quantity, the piston will rise as full as this steam can be supplied through the steam-pipe, and the velocity of its ascent depends entirely on the velocity of this supply. This observation is of great importance; and it does not seem to have occurred to the mathematicians, who have paid most attention to the mechanism of the motion of this engine. In the mean time, we may clearly see that the entry of the steam depends chiefly on the counter weight at E: for suppose there was none, steam no stronger than air would not enter the cylinder at all; and if the steam be stronger, it will enter only by the excess of its strength. Writers on the steam-engine (and even some of great reputation) familiarly speak of the steam giving the piston a push: But this is scarcely possible. During the rise of the piston the sucking valve is never observed to blow; and we have not heard any well-attested accounts of the piston-chains ever being slackened by the upward pressure of the steam, even at the very beginning of the stroke. During the rising of the piston the steam is (according to the common conception and manner of speaking) sucked in, in the same way that air is sucked into a common syringe or pump when we draw up the piston; for in the steam-engine the piston is really drawn up by the counter weight. But it is still more sucked in, and requires a more copious supply, for another reason. As the piston descended only in consequence of the inside of the cylinder's being sufficiently cooled to condense the steam, this cooled surface must again be presented to the steam during the rise of the piston, and must condense steam a second time. The piston cannot rise another inch till the part of the cylinder which the piston has already quitted has been warmed up to the boiling point, and steam must be expended in this warming. The inner surface of the cylinder is not only of the heat of boiling water while the piston rises, but is also perfectly dry; for the film of water left on it by the ascending piston must be completely evaporated, otherwise it will be condensing steam. That the quantity thus wasted is considerable, appears by the experiments of Mr Beighton. He found that five pistons of water were boiled off in a minute, and produced 16 strokes of an engine whose cylinder contained 113 gallons of 282 inches each; and he thence concluded that steam was 2586 times rarer than water. But in no experiment made with scrupulous care on the expansion of boiling water does it appear that the density of steam exceeds

$\frac{1}{10,000}$ th of the density of water. DeGouliers says that

it is above 14,000 times rarer than water. We have frequently attempted to measure the weight of steam which filled a very light vessel, which held 12,600 grains of water, and found it always less than one grain; so that we have no doubt of its being much more than

10,000 times rarer than water. This being the case, we may safely suppose that the number of gallons of steam, instead of being 16 times 113, were nearly five times as much; and that only $\frac{1}{4}$ th was employed in allowing the piston to rise, and the remaining $\frac{3}{4}$ ths were employed to warm the cylinder. But no distinct experiment shews so great an expansion of water when converted into steam at 212°. Mr Watt never found it under the pressure of the air more than 1800 times rarer than water.

The moving force during the ascent of the piston must be considered as remaining chiefly, if not solely, chiefly owing to the preponderating weight of the pit piston-rods. The office of this is to return the steam-piston to the top of the cylinder, where it may again be pressed down by the air, and make another working stroke by raising the pump rods. But the counter-weight at E has another service to perform in this use of the engine; namely, to return the pump pistons into their places at the bottom of their respective working barrels, in order that they also may make a working stroke. This requires force independent of the friction and inertia of the moving parts; for each piston must be pulled down through the water in the barrel, which must rise through the piston with a velocity whose proportion to the velocity of the piston is the same with that of the bulk of the piston to the bulk of the perforation through which the water rises through the piston. It is enough at present to mention this in general terms: we shall consider it more particularly afterwards, when we come to calculate the performance of the engine, and to deduce from our acquired knowledge maxims of construction and improvement.

From this general consideration of the ascent of the piston, we may see that the motion differs greatly from the descent. It can hardly be supposed to accelerate, even if the steam in the cylinder were in a moment annihilated. For the resistance to the descent of the piston is the same with the weight of the column of water, which would cause it to flow through the box of the pump piston with the velocity with which it really rises through it, and must therefore increase as the square of that velocity increases; that is, as the square of the velocity of the piston increases. Independent of friction, therefore, the velocity of descent through the water must soon become a maximum, and the motion become uniform. We shall see by and by, that in such a pump as is generally used this will happen in less than the 10th part of a second. The friction of the pump will diminish this velocity a little, and retard the time of its attaining uniformity. But, on the other hand, the supply of steam which is necessary for this motion, being susceptible of no acceleration from its previous motion, and depending entirely on the briskness of the equilibrium, an almost instantaneous stop is put to acceleration.

Accordingly, any person who observes with attention the working of a steam-engine, will see that the rise of the piston and descent of the pump-rods is extremely uniform, whereas the working stroke is very sensibly accelerated. Before quitting this part of the subject, and before we should afterwards elude our recollection, we may be observed, that the counter-weight is different during the motions of the pump-rods. While the machine is making a working stroke, it is lifting not only the counter-weight of the pump-rods, but

Steam-Engine.

lumn of water in the pump, but the absolute weight of the pistons and piston-rods also: but while the pump-rods are descending, there is a diminution of the counter-weight by the whole weight lost by the immersion of the rod in water. The wooden rods which are generally used, soaked in water, and joined by iron flaps, are heavier, and but a little heavier, than water, and they are generally about one-third of the bulk of the water in the pumps.

These two motions complete the period of the operation; and the whole may be repeated by shutting the steam-cock and opening the injection-cock whenever the piston has attained the proper height. We have been very minute in our attention to the different circumstances, that the reader may have a distinct notion of the state of the moving forces in every period of the operation. It is by no means sufficient that we know in general that the injection of cold water makes a void which allows the air to press down the piston, and that the readmission of the steam allows the piston to rise again. This lumping and slovenly way of viewing it has long prevented even the philosopher from seeing the defects of the construction, and the methods of removing them.

²² D. Reference between Savary's and Newcomen's machines.

We now see the great difference between Savary's and Newcomen's engine in respect to principle. Savary's was really an engine which raised water by the force of steam; but Newcomen's raised water entirely by the pressure of the atmosphere, and steam is employed merely as the most expeditious method of producing a void, into which the atmospheric pressure may impel the *first mover* of his machine. The elasticity of the steam is not the first mover.

²³ Superiority of Newcomen's.

We see also the great superiority of this new machine. We have no need of steam of great and dangerous elasticity; and we operate by means of very moderate heats, and consequently with much smaller quantities of fuel; and there is no bounds to the power of this machine. How deep soever a mine may be, a cylinder may be employed of such dimensions that the pressure of the air on its piston may exceed in any degree the weight of the column of water to be raised. And lastly, this form of the machine renders it applicable to almost every mechanical purpose; because a skilful mechanic can readily find a method of converting the reciprocating motion of the working beam into a motion of any kind which may suit his purpose. Savary's engine could hardly admit of such an immediate application, and seems almost restricted to raising water.

²⁴ Gradually improved.

Inventions improve by degrees. This engine was first offered to the public in 1705. But many difficulties occurred in the execution, which were removed one by one; and it was not till 1712 that the engine seemed to give confidence in its efficacy. The most exact and unremitting attention of the manager was required to the precise moment of opening and shutting the cocks; and neglect might frequently be ruinous, by beating out the bottom of the cylinder, or allowing the piston to be wholly drawn out of it. Stops were contrived to prevent both of these accidents; then strings were used to connect the handles of the cocks with the beam, so that they should be turned whenever it was in certain positions. These were gradually changed and improved into detents and catches of different shapes; at last, in 1717, Mr Beighton, a very ingenious and

²⁵ and improved.

well-informed artist, simplified the whole of these subordinate movements, and brought the machine into the form in which it has continued, without the smallest material change, to the present day. We shall now describe one of these improved engines, copying almost exactly the drawings and description given by Boffut in his *Hydrodynamique*; these being by far the most accurate and perspicuous of any that have been published.

Steam-Engine.

Fig. 8. N^o 1. is a perspective view of the boiler cylinder, and all the parts necessary for turning the cocks. Fig. 8. N^o 2. is a vertical section of the same; and the same pieces of both are marked with the same letters of reference.

²⁶ Description of Beighton's steam-engine. Plate DII. Fig. 8.

The rod X of the piston P is suspended from the arch of the working beam, as was represented in the preceding sketch (fig. 7.). An upright bar of timber FG is also seen hanging by a chain. This is suspended from a concentric arch of the beam, as may be seen also in the sketch at \S 2. The bar is called the *plug-beam*; and it must rise and fall with the piston, but with a slower motion. The use of this plug-beam is to give motion to the different pieces which turn the cocks.

The steam-pipe K is of one piece with the bottom of the cylinder, and rises within it an inch or two, to prevent any of the cold injection water from falling into the boiler. The lower extremity Z of the steam-pipe penetrates the head of the boiler, projecting a little way. A flat plate of brass, in shape resembling a racket or battle-axe, called the *regulator*, applies itself exactly to the whole circumference of the steam-pipe, and completely excludes the steam from the cylinder. Being moveable round an upright axis, which is represented by the dotted lines at the side of the steam-pipe in the profile, it may be turned aside by the handle γ , ν^o 1. The profile shows in the section of this plate a protuberance in the middle. This rests on a strong flat spring, which is fixed below it athwart the mouth of the steam-pipe. This spring presses it strongly towards the steam-pipe, causing it to apply very close; and this knob slides along the spring, while the regulator turns to the right or left.

We have said that the injection-water is furnished from a cistern placed above the cylinder. When the cistern cannot be supplied by pipes from some more elevated source, its water is raised by the machine itself. A small lifting pump i k (fig. 7.), called the *jack-head* or *jaquette*, is worked by a rod γ ν , suspended from a concentric arch ν near the outer end of the working beam. This forces a small portion of the pit water along the rising pipe i LM into the injection cistern.

In figure 8. N^o 1. and 2. the letters QM γ represent the pipe which brings down the water from the injection cistern. This pipe has a cock at R to open or shut the passage of this water. It spouts through the jet γ , and dashing against the bottom of the piston, it is dispersed into drops, and scattered through the whole capacity of the cylinder, so as to produce a rapid condensation of the steam.

An upright post A may be observed in the perspective view of the cylinder, &c. This supports one end B of a horizontal iron axis BC. The end C is supported by a similar post, of which the place only is marked by the dotted lines A, that the pieces connected

ted with this axis may not be hid by it. A kind of stirrup *abcd* hangs from this axis, supported by the hooks *a* and *d*. This stirrup is crossed near the bottom by a round bolt or bar *e*, which passes through the eyes or rings that are at the ends of the horizontal fork *hfg*, whose long tail *h* is double, receiving between its branches the handle *i* of the regulator. It is plain from this construction, that when the stirrup is made to vibrate round the horizontal axis *BC*, on which it hangs freely by its hooks, the bolt *e* must pull or push the long fork *hfg* backwards and forwards horizontally, and by so doing will move the regulator round its axis by means of the handle *i*. Both the tail of the fork and the handle of the regulator are pierced with several holes, and a pin is put through them which unites them by a joint. The motion of the handle may be increased or diminished by choofing for the joint a hole near to the axis or remote from it; and the exact position at which the regulator is to stop on both sides is determined by pins stuck in the horizontal bar on which the end of the handle appears to rest.

This alternate motion of the regulator to the right and left is produced as follows: There is fixed to the axis *BC* a piece of iron *okl*, called the *Y*, on account of its resemblance to that letter of the alphabet inverted. The stalk *c* carries a heavy lump *p* of lead or iron; and a long leather strap *qpr* is fastened to *p* by the middle, and the two ends are fastened to the beam above it, in such a manner that the lump may be alternately caught and held up to the right and left of the perpendicular. By adjusting the length of the two parts of the strap, the *Y* may be stopped in any desired position. The two claws *k* and *l* spread out from each other, and from the line of the stalk, and they are of such length as to reach the horizontal bolt *e*, which crosses the stirrup below, but not to reach the bottom of the fork *hfg*. Now suppose the stirrup hanging perpendicularly, and the stalk of the *Y* also held perpendicular; carry it a little outward from the cylinder, and then let it go. It will tumble farther out by its weight, without affecting the stirrup till the claw *l* strikes on the horizontal bolt *e*, and then it pushes the stirrup and the fork towards the cylinder, and opens the regulator. It sets it in motion with a smart jerk, which is an effectual way of overcoming the cohesion and friction of the regulator with the mouth of the steam-pipe. This push is adjusted to a proper length by the strap *qp*, which stops the *Y* when it has gone far enough. If we now take hold of the stalk of the *Y*, and move it up to the perpendicular, the width between its claws is such as to permit this motion, and something more, without affecting the stirrup. But when pushed still nearer to the cylinder, it tumbles towards it by its own weight, and then the claw *k* strikes the bolt *e*, and drives the stirrup and fork in the opposite direction, till the lump *p* is caught by the strap *rp*, now stretched to its full length, while *qp* hangs slack. Thus by the motion of the *Y* the regulator is opened and shut. Let us now see how the motion of the *Y* is produced by the machine itself. To the horizontal axis *BC* are attached two spanners or handles *m* and *n*. The spanner *m* passes through a long slit in the plug-beam, and is at liberty to move upwards or downwards by its motion round the axis *BC*. A pin *π* which goes through the plug-beam catches hold of *m*

when the beam rises along with the piston; and the pin is so placed, that when the beam is within an inch or two of its highest rise, the pin has lifted *m* and thrown the stalk of the *Y* past the perpendicular. It therefore tumbles over with great force, and gives a smart blow to the fork, and immediately shuts the regulator. By this motion the spanner *m* is removed out of the neighbourhood of the plug-beam. But the spanner *n*, moving along with it in the same direction, now comes into the way of the pins of the plug-beam. Therefore, when the piston descends again by the condensation of the steam in the cylinder, a pin marked *σ* in the side of the plug-beam catches hold of the tail of the spanner *n*, and by pressing it down raises the lump on the stalk of the *Y* till it passes the perpendicular, and it then falls down, outwards from the cylinder, and the claw *l* again drives the fork in the direction *h i*, and opens the steam valve. This opening and shutting of the steam valve is executed in the precise moment that is proper, by placing the pins *π* and *σ* at a proper height of the plug-beam. For this reason, it is pierced through with a great number of holes, that the places of these pins may be varied at pleasure. This, and a proper curvature of the spinnets *m* and *n*, make the adjustment as nice as we please.

The injection-cock *R* is managed in a similar manner. On its key may be observed a forked arm *st*, like a crab's claw; at a little distance above it is the gudgeon or axis *u* of a piece *yuz*, called the hammer or the *F*, from its resemblance to that letter. It has a lump of metal *y* at one end, and a spear *us* projects from its middle, and passes between the claws *s* and *t* of the arm of the injection-cock. The hammer *y* is held up by a notch in the under side of a wooden lever *DE*, moveable round the center *D*, and supported at a proper height by a spring *rE*, made fast to the joint above it.

Suppose the injection-cock shut, and the hammer in the position represented in the figure. A pin *β* of the plug-frame rises along with the piston, and catching hold of the detent *DE*, raises it, and disengages the hammer *y* from its notch. This immediately falls down, and strikes a board *L* put in the way to stop it. The spear *us* takes hold of the claw *t*, and forces it aside towards *x*, and opens the injection-cock. The piston immediately descends, and along with it the plug-frame. During its descent the pin *β* meets with the tail *uz* of the hammer, which is now raised considerably above the level, and brings it down along with it, raising the lump *y*, and gradually shutting the injection-cock, because the spear takes hold of the claw *s* of its arm. When the beam has come to its lowest situation, the hammer is again engaged in the notch of the detent *DE*, and supported by it till the piston again reaches the top of the cylinder.

In this manner the motions of the injection-cock are also adjusted to the precise moment that is proper for them. The different pins are so placed in the plug-frame, that the steam-cock may be completely shut before the injection-cock is opened. The inherent motion of the machine will give a small addition to the ascent of the piston without expending steam all the while; and by leaving the steam rather less elastic than before, the subsequent descent of the piston is promoted. There was a considerable propriety in the gradual shut-

Steam-Engine.

ting of the injection-cock. For after the first dash of the cold water against the bottom of the piston, the condensation is nearly complete, and very little more water is needed; but a continual accession of some is absolutely necessary for completing the condensation, as the capacity of the cylinder diminishes, and the water warms which is already injected.

In this manner the motion of the machine will be repeated as long as there is a supply of steam from the boiler, and of water from the injection cistern, and a discharge procured for what has been injected. We proceed to consider how far these conditions also are provided by the machine itself.

The injection cistern is supplied with water by the jackhead pump, as we have already observed. From this source all the parts of the machine receive their respective supplies. In the first place, a small branch 13, 13, is taken off from the injection-pipe immediately below the cistern, and conducted to the top of the cylinder, where it is furnished with a cock. The spout is so adjusted, that no more runs from it than what will keep a constant supply of a foot of water above the piston to keep it tight. Every time the piston comes to the top of the cylinder, it brings this water along with it, and the surplus of its evaporation and leakage runs off by a waste-pipe 14, 14. This water necessarily becomes almost boiling hot, and it was thought proper to employ its overplus for supplying the waste of the boiler. This was accordingly practised for some time. But Mr Beighton improved this economical thought, by supplying the boiler from the eduction-pipe, 2, 2, the water of which must be still hotter than that above the piston. This contrivance required attention to many circumstances, which the reader will understand by considering the perspective and profile. The eduction-pipe comes out of the bottom of the cylinder at 1 with a perpendicular part, which bends sidewise below, and is that at the extremity 1. A deep cup 5 communicates with it, holding a metal valve nicely fitted to it by grinding, like the key of a cock. To secure its being always air-tight, a slender stream of water trickles into it from a branch 6 of the waste-pipe from the top of the cylinder. The eduction pipe branches off at 2, and goes down to the hot well, where it turns up, and is covered with a valve. In the perspective view may be observed an upright pipe 4, 4, which goes through the head of the boiler, and reaches to within a few inches of its bottom. This pipe is called the *feeder*, and rises about three or four feet above the boiler. It is open at both ends, and has a branch 3, 3, communicating with the bottom of the cup 5, immediately above the metal valve, and also a few inches below the level of the entry 2 of the eduction-pipe. This communicating branch has a cock by which its passage may be diminished at pleasure. Now suppose the steam in the boiler to be very strong, it will cause the boiling water to rise in the feeding pipe above 3, and coming along this branch, to rise also in the cup 5, and run over. But the height of this cup above the surface of the water in the boiler is such, that the steam is never strong enough to produce this effect. Therefore, on the contrary, any water that may be in the cup 5 will run off by the branch 3, 3, and go down into the boiler by the feeding pipe.

These things being understood, let us suppose a

quantity of injected water lying at the bottom of the cylinder. It will run into the eduction-pipe, fill the crooked branch 1, 1, and open the valve in the bottom of the cup (its weight being supported by a wire hanging from a slender spring), and it will fill the cup to the level of the entry 2 of the eduction-pipe, and will then flow along 3, 3, and supply the boiler by the feeder 4, 4. What more water runs in at 1 will now go along the eduction pipe 2, 2, to the hot well. By properly adjusting the cock on the branch 3, 3, the boiler may be supplied as fast as the waste in steam requires. This is a most ingenious contrivance, and does great honour to Mr Beighton. It is not, however, of much importance. The small quantity which the boiler requires may be immediately taken even from a cold cistern, without sensibly diminishing the production of steam: for the quantity of heat necessary for raising the sensible heat of cold water to the boiling temperature is small, when compared with the quantity of heat which must then be combined with it in order to convert the water into steam. For the heat expended in boiling off a cubic foot of water is about six times as much as would bring it to a boiling heat from the temperature of 55°. No difference can be observed in the performance of such engines, and of those which have their boilers supplied from a brook. It has, however, the advantage of being purged of air; and when an engine must derive all its supplies from pit water, the water from the eduction-pipe is vastly preferable to that from the top of the cylinder.

We may here observe, that many writers (among them the Abbé Buisson), in their descriptions of the steam-engine, have drawn the branch of communication 3, 3, from the feeding-pipe to a part of the crooked pipe 1, 1, lying below the valve in the cup 5. But this is quite erroneous; for, in this case, when the injection is made into the cylinder, and a vacuum produced, the water from the boiler would immediately rush up through the pipes 4, 3, and spout up into the cylinder: so would the external air coming in at the top of the feeder.

This contrivance has also enabled us to form some judgment of the internal state of the engine during its performance. Mr Beighton paid a minute attention to the situation of the water in the feeders and eduction-pipe of an engine, which seems to have been one of the best which has yet been erected. It was lifting a column of water whose weight was four-sevenths of the pressure of the air on its piston, and made 16 strokes, of six feet each, in a minute. This is acknowledged by all to be a very great performance of an engine of this form. He concluded that the elasticity of the steam in the cylinder was never more than one-tenth greater or less than the elasticity of the air. The water in the feeder never rose more than three feet and a half above the surface of the boiling water, even though it was now lighter by $\frac{1}{7}$ th than cold water. The eduction-pipe was only four feet and a half long (vertically), and yet it always discharged the injection water completely, and allowed some to pass into the feeder. This could not be if the steam was much more than one-tenth weaker than air. By grasping this pipe in his hand during the rise of the piston, he could guess very well whereabouts the surface of the hot water in it rested during the motion, and he never found it supported so high as four feet. Therefore the steam in the cylinder had at least eight-ninths

Steam-Engine.

27
An ingenious contrivance.28
Which enables us to form some judgment of the internal state of the engine during its performance.

of

Steam-Engine.

of the elasticity of the air. Mr. Buat, in his examination of an engine which is erected at Montrelais, in France, by an English engineer, and has always been considered as the pattern in that country, finds it necessary to suppose a much greater variation in the strength of the steam, and says, that it must have been one-fifth stronger and one-fifth weaker than common air. But this engine has not been nearly so perfect. Its lift was not more than one-half of the pressure of the atmosphere, and it made but nine strokes in a minute.—At W is a valve covering the mouth of a small pipe, and surrounded with a cup containing water to keep it air-tight. This allows the air to escape which had been extricated from the water of last injection. It is driven out by the first strong puff of steam which is admitted into the cylinder, and makes a noise in its exit. The valve is therefore called the *sifting-valve*.

To finish our description, we observe, that besides the safety valve 9 (called the *PUPPET CLACK*), which is loaded with about 2 pounds on the square inch (though the engine will work very well with a load of 1 or 2 pounds), there is another *DISCHARGER* 10, 10, having a clack at its extremity supported by a cord. Its use is to discharge the steam without doors, when the machine gives over working. There is also a pipe SI near the bottom of the boiler, by which it may be emptied when it needs repairs or cleansing.

There are two small pipes 11, 11, and 12, 12, with cocks called *GAGE-PIPES*. The first descends to within two inches of the surface of the water in the boiler, and the second goes about 2 inches below that surface. If both cocks emit steam, the water is too low, and requires a recruit. If neither give steam, it is too high, and there is not sufficient room above it for a collection of steam. Lastly, there is a filling pipe Q, by which the boiler may be filled when the machine is to be set to work.

The engine has continued in this form for many years. The only remarkable change introduced has been the manner of placing the boiler. It is no longer placed below the cylinder, but at one side, and the steam is introduced by a pipe from the top of the boiler into a flat box immediately below the cylinder. The use of this box is merely to lodge the regulator, and give room for its motions. This has been a very considerable improvement. It has greatly reduced the height of the building. This was formerly a tower. The wall which supported the beam could hardly be built with sufficient strength for withstanding the violent shocks which were repeated without ceasing; and the buildings seldom lasted more than a very few years. But the boiler is now set up in an adjoining shed, and the gudgeons of the main beam rest on the top of upright posts, which are framed into the joists which support the cylinder. Thus the whole moving parts of the machine are contained in one compact frame of carpentry, and have little or no connection with the slight walls of the building, which is merely a case to hold the machine, and protect it from the weather.

It is now time to inquire what is to be expected from this machine, and to ascertain the most advantageous proportion between the moving power and the load that is to be laid on the machine.

It may be considered as a great pulley, and is indeed

sometimes so constructed, the arches at the ends of the working beam being completed to a circle. It must be unequally loaded that it may move. It is loaded, during the working stroke, by the pressure of the atmosphere on the piston side, and by the column of water to be raised and the pump-gear on the pump side.—During the returning stroke it is loaded, on the piston side, by a small part of the atmospheric pressure, and on the pump side by the pump gear acting as a counter weight. The load during the working stroke must therefore consist of the column of water to be raised and this counter weight. The performance of the machine is to be measured only by the quantity of water raised in a given time to a given height. It varies, therefore, in the joint proportion of the weight of the column of water in the pumps, and the number of strokes made by the machine in a minute. Each stroke consists of two parts, which we have called the working and the returning stroke. It does not, therefore, depend simply on the velocity of the working stroke and the quantity of water raised by it. If this were all that is to be attended to, we know that the weight of the column of water should be nearly $\frac{3}{4}$ ths of the pressure of the atmosphere, this being the proportion which gives the maximum in the common pulley. But the time of the returning stroke is a necessary part of the whole time elapsed, and therefore the velocity of the returning stroke equally merits attention. This is regulated by the counter weight. The number of strokes per minute does not give an immediate proof of the goodness of the engine. A small load of water and a great counter weight will ensure this, because these conditions will produce a brisk motion in both directions.—The proper adjustment of the pressure of the atmosphere on the piston, the column of water to be raised, and the counter weight, is a problem of very great difficulty; and mathematicians have not turned much of their attention to the subject, although it is certainly the most interesting question that practical mechanics affords them.

Mr. Boffut has solved it very shortly and simply, upon this supposition, that the working and returning stroke should be made in equal times. This, indeed, is generally aimed at in the erection of these machines, and they are not reckoned to be well arranged if it be otherwise. We doubt of the propriety of the maxim. Supposing, however, this condition for the present, we may compute the loadings of the two ends of the beam as follows. Let a be the length of the inner arm of the working beam, or that by which the great piston is supported. Let b be the outer arm carrying the pump rods, and let W be a weight equivalent to all the load which is laid on the machine. Let c^2 be the area of the piston; let H be the height of a column of water having c^2 for its base, and being equal in weight to the pressure exerted by the steam on the under side of the piston; and let h be the pressure of the atmosphere on the same area, or the height of a column of water of equal weight. It is evident that both strokes will be performed in equal times, if $h c^2 a - W b$ be equal to $(h - H) c^2 a + W b$. The first of these quantities is the energy of the machine during the working stroke, and the second expresses the similar energy during the returning stroke. This equation gives us $W = \frac{2 h c^2 a - H c^2 a}{2 b} = \frac{(2 h - H) c^2 a}{2 b}$. If

Steam-Engine.

29
This form of the engine has been continued for many years, the only change being the position of the boiler.

30
How to ascertain the most advantageous proportion between the moving power and the load.

31
Mr. Boffut's solution.

Steam-Engine.

we suppose the arms of the lever equal and $H = h$, we have $W = c^2 \frac{h}{2}$; that is, the whole weight of the outer

end of the beam should be half the pressure of the air on the great piston. This is nearly the usual practice; and the engineers express it by saying, that the engine is loaded with seven or eight pounds on the square inch. This has been found to be nearly the most advantageous load. This way of expressing the matter would do well enough, if the maxim were not founded on erroneous notions, which hinder us from seeing the state of the machine, and the circumstances on which its improvement depends. The piston bears a pressure of 15 pounds, it is said, on the square inch, if the vacuum below it be perfect; but as this is far from being the case, we must not load it above the power of its vacuum, which very little exceeds eight pounds. But this is very far from the truth. When the cylinder is tight, the vacuum is not more than $\frac{1}{25}$ th deficient, when the cylinder is cooled by the injection to the degree that is every day practicable, and the piston really bears during its descent a pressure very near to 14 pounds on the inch. The load must be diminished, not on account of the imperfect vacuum, but to give the machine a reasonable motion. We must consider not only the moving force, but also the quantity of matter to be put in motion. This is so great in the steam-engine, that even if it were balanced, that is, if there were suspended on the piston arm a weight equal to the whole column of water and the counter weight, the full pressure of the atmosphere on the steam piston would not make it move twice as fast as it does.

32
founded on an erroneous maxim.

33
and fault to be in respect.

This equation by Mr. Boffat is moreover essentially faulty in another respect. The W in the first member is not the same with the W in the second. In the first it is the column of water to be raised, together with the counter weight. In the second it is the counter weight only. Nor is the quantity H the same in both cases, as is most evident. The proper equation for ensuring the equal duration of the two strokes may be had in the following manner. Let it be determined by experiment what portion of the atmospheric pressure is exerted on the great piston during its descent. This depends on the remaining elasticity of the steam. Suppose it $\frac{2}{3}$ ths: this we may express by $a h$, a being $\frac{2}{3}$ ths. Let it also be determined by experiment what portion of the atmospheric pressure on the piston remains unbalanced by the steam below it during its ascent. Suppose this $\frac{1}{2}$ th, we may express this by $b h$. Then let W be the weight of the column of water to be raised, and c the counter weight. Then, if the arms of the beam are equal, we have the energy during the working stroke $= a h W - c$, and during the returning stroke it is $= c - b h$. Therefore $c - b h = a h W - c$; and $c = \frac{h(a+h)W}{2}$; which, on the above supposition of

the values of a and b , gives us $c = \frac{h-W}{2}$. We shall make some use of this equation afterwards; but it affords us no information concerning the most advantageous proportion of h and W , which is the material point.

34
we must consider the matter in another way: And that we may not involve ourselves in unnecessary difficulties.

culties, let us make the case as simple as possible, and suppose the arms of the working-beam to be of equal length.

Steam-Engine.

We shall first consider the adjustment of things at the outer end of the beam.

Since the sole use of the steam is to give room for the action of the atmospheric pressure by its rapid condensibility, it is admitted into the cylinder only to allow the piston to rise again, but without giving it any impulsion. The pump-rods must therefore be returned to the bottom of the working barrels by means of a preponderancy at the outer end of the beam. It may be the weight of the pump-rods themselves, or may be considered as making part of this weight. A weight at the end of the beam will not operate on the rods which are suspended there by chains, and it must therefore be attached to the rods themselves, but above their respective pump-barrels, so that it may not lose part of its efficacy by immersion in the water. We may consider the whole under the notion of the pump-gear, and call it p . Its office is to depress the pump-rods with sufficient velocity, by overcoming the resistances arising from the following causes.

35
Adjustment of things at the outer end of the beam considered.

1. From the inertia of the beams and all the parts of the apparatus which are in motion during the descent of the pump-rods.

2. From the loss of weight sustained by the immersion of the pump-rods in water.

3. From the friction of all the pistons and the weight of the plug-frame.

4. From the resistance to the piston's motion, arising from the velocity which must be generated in the water in passing through the descending pistons.

The sum of all these resistances is equal to the pressure of some weight (as yet unknown), which we may call m .

When the pump-rods are brought up again, they bring along with them a column of water, whose weight we may call w .

It is evident that the load which must be overcome by the pressure of the atmosphere on the steam piston consists of w and p . Let this load be called L , and the pressure of the air be called P .

If p be $= L$, no water will be raised; if p be $= 0$, the rods will not descend: therefore there is some intermediate value of p which will produce the greatest effect.

In order to discover this, let g be the fall of a heavy body in a second.

The descending mass is p : but it does not descend with its full weight; because it is overcoming a set of resistances which are equivalent to a weight m , and the moving force is $p - m$. In order to discover the space through which the rods will descend in a second, when urged by the force $p - m$ (supposed constant, notwithstanding the increase of velocity, and consequently of m), we must substitute this proportion $p : p - m :: g : g(p - m)$.

The fourth term of this analogy is the space required.

Let t be the whole time of the descent in seconds. Then $t^2 : t^2 = \frac{g(p - m)}{p} : \frac{t^2 g(p - m)}{p}$. This last term

is the whole defect or length of the stroke accomplished in the time t .

The weight of the column of water, which has now got above the piston, is $w = L - \rho$. This must be lifted in the next working stroke through the space $\frac{t^2 \xi (\rho - m)}{\rho}$. Therefore the performance of the engine must be $\frac{t^2 \xi (\rho - m) (L - \rho)}{\rho}$.

That this may be the greatest possible, we must consider ρ as the variable quantity, and make the fluxion of the fraction $\frac{\rho - m \times L - \rho}{\rho} = 0$.

This will be found to give us $\rho = \sqrt{Lm}$; that is, the counter weight or preponderancy of the outer end of the beam is $= \sqrt{Lm}$.

This gives us a method of determining m experimentally. We can discover by actual measurement the quantity L in any engine, it being equal to the unbalanced weights on the beam and the weight of the water in the pumps. Then $m = \frac{\rho^2}{L}$.

Also we have the weight of the column of water $= L - \rho$, $= L - \sqrt{Lm}$.

When therefore we have determined the load which is to be on the outer end of the beam during the working stroke, it must be distributed into two parts, which have the proportion of \sqrt{Lm} to $L - \sqrt{Lm}$. The first is the counter weight, and the second is the weight of the column of water.

If m is a fraction of L , such as an aliquot part of it; that is, if

$$m = \frac{L}{1}, \frac{L}{4}, \frac{L}{9}, \frac{L}{16}, \frac{L}{25}, \&c.$$

$$\rho = \frac{L}{1}, \frac{L}{2}, \frac{L}{3}, \frac{L}{4}, \frac{L}{5}, \&c.$$

The circumstance which is commonly obtruded on us by local considerations is the quantity of water, and the depth from which it is to be raised; that is, w ; and it will be convenient to determine every thing in conformity to this.

We saw that $w = L - \sqrt{Lm}$. This gives us $L = \sqrt{wm + \frac{m^2}{4}} + \frac{m}{2} + w$, and the counter weight $\rho = \sqrt{wm + \frac{m^2}{4}} + \frac{m}{4}$.

Having thus ascertained that distribution of the load on the outer end of the beam which produces the greatest effect, we come now to consider what proportion of moving force we must apply, so that it may be employed to the best advantage, or so that any expence of power may produce the greatest performance. It will be so much the greater as the work done is greater, and the power employed is less; and will therefore be properly measured by the quotient of the work done divided by the power employed.

The work immediately done is the lifting up the weight L . In order to accomplish this, we must employ a pressure P , which is greater than L . Let it be $= L + y$; also let s be the length of the stroke.

If the mass L were urged along the force s by the

force $L + y$, it would acquire a certain velocity, which we may express by \sqrt{xy} ; but it is impelled only by the force y , the rest of P being employed in balancing L . The velocities which different forces generate by impelling a body along the same space are as the square roots of the forces. Therefore $\sqrt{L + y} : \sqrt{y} = \sqrt{s} :$

$\frac{\sqrt{xy}}{\sqrt{L + y}}$. The fourth term of this analogy expresses the velocity of the piston at the end of the stroke. The quantity of motion produced will be had by multiplying this velocity by the mass L . This gives $\frac{L \times \sqrt{xy}}{\sqrt{L + y}}$; and this divided by the power expended, or by $L + y$, gives us the measure of the performance; namely,

$\frac{L \times \sqrt{xy}}{L + y} \times \sqrt{L + y}$.

That this may be a maximum, consider y as the variable quantity, and make the fluxion of this formula $= 0$. This will give us $y = \frac{L}{2}$.

Now $P = L + y$, $= L + \frac{L}{2}$, $= \frac{3}{2} L$. Therefore the

whole load on the outer end of the beam, consisting of the water and the counter weight, must be two-thirds of the pressure of the atmosphere on the steam piston.

We have here supposed that the expenture is the atmospheric pressure; and so it is if we consider it mechanically. But the expenture of which we are sensible, and which we are anxious to employ to the best advantage, is fuel. Supposing this to be employed with the same judgement in all cases, we are almost intitled, by what we now know of the production of steam, to say that the steam produced is proportional to the fuel expended. But the steam requisite for merely filling the cylinder is proportional to the area of the piston, and therefore to the atmospheric pressure. The result of our investigation therefore is still just; but the steam wasted by condensation on the sides of the cylinder does not follow this ratio, and this is more than what is necessary for merely filling it. This deranges our calculations, and is in favour of large cylinders; but this advantage must be in a great measure compensated by a similar variation in the production of the steam; for in similar boilers of greater dimensions the fuel is less advantageously employed, because the surface to which the fuel is applied does not increase in the ratio of the capacity, just as the surface of the cylinder which wastes the steam. The rule may therefore be confined in as pretty exact.

It is a satisfactory thing to observe these results agree very well with the most successful practice. By many changes and trials engineers have established maxims of the construction, which are probably not very far from the best. It is a pretty general maxim, that the load of water should be one-half of the atmospheric pressure. They call this loading the engine with $\frac{7}{8}$ pounds on the inch, and they say that so small a load is necessary on account of the imperfect vacuum. But we have now seen that it is necessary for giving a reasonable velocity of motion. Since, in this practice, w is made $\frac{1}{2}$ or $\frac{2}{3}$ ths of P , and L should be $\frac{2}{3}$ ths of P , and L is $= w + \rho$; it follows, that the counter weight should be

What proportion of moving force may be applied to the greatest advantage.

Steam-Engine.

37
These results agree with the most successful practice.

Steam-
Eng. no.

$\frac{1}{4}$ th of P; and we have found this to be nearly the case in several very good engines.

It will be remarked, that in the preceding investigation we introduced a quantity M to express the resistances to the motion of the engine. This was done in order to avoid a very troublesome investigation. The resistances are of such a nature as to vary with the velocity, and most of them as the square of the velocity. This is the case with the resistance arising from the motion of the water through the pistons of the pumps, and that arising from the friction in the long lift during the working stroke. Had we taken the direct method, which is similar to the determination of the motion through a medium which resists in the duplicate ratio of the velocity, we must have used a very intricate exponential calculus, which few of our readers would have the patience to look at.

But the greatest part of the quantity m supposes a motion already known, and its determination depends on this motion. We must now show how its different component parts may be computed.

1. What arises from the inertia of the moving parts is by far the most considerable portion of it. To obtain it, we must find a quantity of matter which, when placed at the end of the beam, will have the same momentum of inertia with that of the whole moving parts in their natural places. Therefore (in the returning stroke) add together the weight of the great piston with its rod and chains; the pit pump-rods, chains, and any weight that is attached to them; the arch-heads and iron-work at the ends of the beam, and $\frac{1}{3}$ ths of the weight of the beam itself; also the plug-beam with its arch-head and chain, multiplied by the square of its distance from the axis, and divided by the square of half the length of the beam; also the jack-head pump-rod, chain, and arch-head, multiplied by the square of its distance from the axis, and divided by the square of the half-length of the beam. These articles added into one sum may be called M, and may be supposed to move with the velocity of the end of the beam. Suppose this beam to have made a six-foot stroke in two seconds, with an uniformly accelerated motion. In one second it would have moved $1\frac{1}{2}$ feet, and would have acquired the velocity of three feet per second. But in one second gravity would have produced a velocity of 32 feet in the same mass. Therefore the accelerating force, which has produced the velocity of three feet, is nearly $\frac{1}{11}$ th of the weight. Therefore $\frac{M}{11}$ is the first constituent of m in the above investigation. If the observed velocity is greater or less than three feet per second, this value must be increased or diminished in the same proportion.

The second cause of resistance, viz. the immersion of the pump rods in water, is easily computed, being the weight of the water which they displace.

The third cause, the friction of the pistons, &c. is almost insignificant, and must be discovered by experiment.

The fourth cause depends on the structure of the pumps. These pumps, when made of a proper strength, can hardly have the perforation of the piston more than a fourth part of the area of the working-barrel; and the velocity with which the water passes through it is increased at least $\frac{1}{4}$ th by the contraction (see PUMP). The velocity of the water is therefore five times greater

than that of the piston. A piston 12 inches diameter, and moving one foot per second, meets with a resistance equal to 20 pounds; and this increases as the square of the diameter and as the square of the velocity. If the whole depth of the pit be divided into several lifts, this resistance must be multiplied by the number of lifts, because it obtains in each pump.

Thus we make up the value of m ; and we must acknowledge that the method is still indirect, because it supposes the velocity to be known.

We may obtain it more easily in another way, but still with this circumstance of being indirect. We found that ρ was equal to $\sqrt{L m}$, and consequently $m = \frac{\rho^2}{L}$. Now in any engine L and ρ can always be had; and unless ρ deviates greatly from the proportion which we determined to be the best, the value of m thus obtained will not be very erroneous.

It was farther presumed in this investigation, that the motions both up and down were uniformly accelerated, but this cannot be the case when the resistances increase with the velocity. This circumstance makes very little change in the working-stroke, and therefore the theorem which determines the best relation of P to L may be confided in. The resistances which vary with the velocity in this case are a mere trifle when compared with the moving power y . These resistances are, 1st, The strangling of the water at the entry and at the standing valve of each pump: This is about 37 pounds for a pump 12 inches diameter, and the velocity one foot per second, increasing in the duplicate ratio of the diameter and velocity. And, 2d, The friction of the water along the whole lift: This for a pump of the same size and with the same velocity, lifting 20 fathoms, is only about 24 pounds, and varies in the simple proportion of the diameter and the depth, and in the duplicate proportion of the velocity. The resistance arising from inertia is greater than in the returning stroke; because the M in this case must contain the momentum of the water both of the pit-pumps and the jack-head-pump: but this part of the resistance does not affect the uniform acceleration. We may therefore confide

in the propriety of the formula $y = \frac{L}{2}$. And we may obtain the velocity of this stroke at the end of a second with great accuracy as follows. Let $2g$ be the velocity communicated by gravity in a second, and the velocity at the end of the first second of the steam piston's descent will be somewhat less than $\frac{y}{M} 2g$; where M expresses the inertia of all the parts which are in motion during the descent of the steam piston, and therefore includes L. Compute the two resistances just mentioned for this velocity. Call this r . Then $\frac{y - \frac{1}{2} r}{M} 2g$ will give another velocity infinitely near the truth.

But the case is very different in the returning stroke, and the proper ratio of ρ to L is not ascertained with the same certainty: for the moving force ρ is not so great in proportion to the resistance m ; and therefore the acceleration of the motion is considerably affected by it, and the motion itself is considerably retarded, and in a very moderate time it becomes sensibly uniform: for it is precisely similar to the motion of a heavy body falling

Steam-
Engines.37
Resistance
to the motion
of the engine com-
puted.39
Observa-
tion con-
cerning
something
presumed
in the in-
vestigation.

Steam-Engine

falling through the air, and may be determined in the manner laid down in the article *RESISTANCE of Fluids*, viz. by an exponential calculus. We shall content ourselves here with saying, that the resistances in the present case are so great that the motion would be to all intents uniform before the pistons have descended one-third of their stroke, even although there were no other circumstance to affect it.

But this motion is affected by a circumstance quite unconnected with any thing yet considered, depending on conditions not mechanical, and is uncertain, that we are not yet able to ascertain them with any precision; yet they are of the utmost importance to the good performance and improvement of the engine, and therefore deserve a particular consideration.

The counter weight has not only to push down the pump rods, but also to drag up the great piston. This it cannot do unless the steam be admitted into the cylinder. If the steam be no stronger than common air, it cannot enter the cylinder except in consequence of the piston's being dragged up. If common air were admitted into the cylinder, some force would be required to drag up the piston, in the same manner as it is required to draw up the piston of a common syringe; for the air would rush through the small entry of the cylinder in the same manner as through the small nozzle of the syringe. Some part of the atmospheric pressure is employed in driving in the air with sufficient velocity to fill the syringe, and it is only with the remainder that the admitted air presses on the under surface of the syringe. Therefore some of the atmospheric pressure on its upper surface is not balanced. This is felt by the hand which draws it up. The same thing must happen in the steam-engine, and some part of the counter weight is expended in drawing up the steam-piston. We could tell how much is thus expended if we knew the density of the steam; for this would tell us the velocity with which its elasticity would cause it to fill the cylinder. If we suppose it 12 times rarer than air, which it certainly is, and the piston rises to the top of the cylinder in two seconds, we can demonstrate that it will enter with a velocity not less than 1,400 feet per second, whereas 300 feet is enough to make it maintain a density $\frac{1}{12}$ ths of that of steam in equilibrio with the air. Hence it follows, that its elasticity will not be less than $\frac{1}{12}$ ths of the elasticity of the air, and therefore not more than $\frac{1}{12}$ th of counter weight will be expended in drawing up the steam-piston.

But all this is on the supposition that there is an unbounded supply of steam of undiminished elasticity. This is by no means the case. Immediately before opening the steam-cock, the steam was issuing through the safety-valve and all the crevices in the top of the boiler, and (in good engines) was about $\frac{1}{10}$ th stronger or more elastic than air. This had been gathering during something more than the descent of the piston, viz. in about three seconds. The piston rises to the top in about two seconds; therefore about twice and a half as much steam as fills the dome of the boiler is now shared between the boiler and cylinder. The dome is commonly about six times more capacious than the cylinder. If therefore no steam is condensed in the cylinder, the density of the steam, when the piston has reached the top, must be about $\frac{1}{12}$ ths of its former density, and is still more elastic than air. But as much steam is condensed by the cold cy-

Steam-Engine

linder, its elasticity must be less than this. We cannot tell how much less, both because we do not know how much is thus condensed, and because by this diminution of its pressure on the surface of the boiling water, it must be more copiously produced in the boiler; but an attentive observation of the engine will give us some information. The moment the steam-cock is opened we have a strong puff of steam through the safety-valve. At this time, therefore, it is still more elastic than air; but after this, the safety-valve remains shut during the whole rise of the piston, and no steam any longer issues through the safety-valve or crevices; nay, the whole dome of the boiler may be observed to sink.

These facts give abundant proof that the elasticity of the steam during the ascent of the piston is greatly diminished, and therefore much of the counter weight is expended in dragging up the steam piston in opposition to the unbalanced part of the atmospheric pressure. The motion of the returning stroke is therefore so much deranged by this foreign and unappreciated circumstance, that it would have been quite useless to engage in the intricate exponential investigation, and we must sit down contented with a less perfect adjustment of the counter weight and weight of water.—Any person who attends to the motion of a steam-engine will perceive that the descent of the pump-rods is so far from being accelerated, that it is nearly uniform, and frequently it is sensibly retarded towards the end. We learn by the way, that it is of the utmost importance not only to have a quick production of steam, but also a very capacious dome, or empty space above the water in the boiler. In engines where this space was but four or five times the capacity of the cylinder, we have always observed a very sensible check given to the descent of the pump-rods after having made half their stroke. This obliges us to employ a greater counter weight, which diminishes the column of water, or retards the working stroke; it also obliges us to employ a stronger steam, at the risk of bursting the boiler, and increases the expence of fuel.

It would be a most desirable thing to get an exact knowledge of the elasticity of the steam in the cylinder; and this is by no means difficult. Take a long glass tube exactly calibered, and close at the farther end. Put in a small drop of some coloured fluid into it, so as to stand at the middle nearly.—Let it be placed in a long box filled with water to keep it of a constant temperature. Let the open end communicate with the cylinder, with a cock between. The moment the steam-cock is opened, open the cock of this instrument. The drop will be pushed towards the close end of the tube, while the steam in the cylinder is more elastic than the air, and it will be drawn the other way while it is less elastic, and, by a scale properly adapted to it, the elasticity of the steam corresponding to every position of the piston may be discovered. The same thing may be done more accurately by a barometer properly constructed, so as to prevent the oscillations of the mercury.

It is equally necessary to know the state of the cylinder during the descent of the steam-piston. We have hitherto supposed P to be the full pressure of the atmosphere on the area of the piston, supposing the vacuum below it to be complete. But the inspection of our table of elasticity shows that this can never be the case, because the cylinder is always of a temperature far above 32° . We have made many attempts to discover its temperature.

40
The motion affected by a circumstance is at times so irregular as to be considered as a motion.

41

These facts give abundant proof that the elasticity of the steam during the ascent of the piston is greatly diminished, and therefore much of the counter weight is expended in dragging up the steam piston in opposition to the unbalanced part of the atmospheric pressure. The motion of the returning stroke is therefore so much deranged by this foreign and unappreciated circumstance, that it would have been quite useless to engage in the intricate exponential investigation, and we must sit down contented with a less perfect adjustment of the counter weight and weight of water.—Any person who attends to the motion of a steam-engine will perceive that the descent of the pump-rods is so far from being accelerated, that it is nearly uniform, and frequently it is sensibly retarded towards the end. We learn by the way, that it is of the utmost importance not only to have a quick production of steam, but also a very capacious dome, or empty space above the water in the boiler. In engines where this space was but four or five times the capacity of the cylinder, we have always observed a very sensible check given to the descent of the pump-rods after having made half their stroke. This obliges us to employ a greater counter weight, which diminishes the column of water, or retards the working stroke; it also obliges us to employ a stronger steam, at the risk of bursting the boiler, and increases the expence of fuel.

42

How to know the density of the steam in the cylinder.

43

Necessity of knowing the state of the cylinder during the descent of the steam-piston.

Steam-Engines.

perature. We have employed a thermometer in close contact with the side of the cylinder, which soon acquired a steady temperature: this was never less than 145° . We have kept a thermometer in the water which lies on the piston: this never sunk below 135° . It is probable that the cylinder within may be cooled somewhat lower; but for this opinion we cannot give any very satisfactory reason. Suppose it cooled down to 120° ; this will leave an elasticity which would support three inches of mercury. We cannot think therefore that the unbalanced pressure of the atmosphere exceeds that of 27 inches of mercury, which is about 134 pounds on a square inch, or 10½ on a circular inch. And this is the value which we should employ in the equation $P=L+y$. This question may be decided in the same way as the other, by a barometer connected with the inside of the cylinder.

And thus we shall learn the state of the moving forces in every moment of the performance, and the machine will then be as open to our examination as any water or horse mill; and till this be done, or something equivalent, we can only guess at what the machine is actually performing, and we cannot tell in what particulars we can lend it a helping hand. We are informed that Messrs Watt and Boulton have made this addition to some of their engines; and we are persuaded that, from the information which they have derived from it, they have been enabled to make the curious improvements from which they have acquired so much reputation and profit.

Quantity of cold water to be injected.

There is a circumstance of which we have as yet taken no notice, viz. the quantity of cold water injected. Here we confess ourselves unable to give any precise instructions. It is clear at first sight that no more than is absolutely necessary should be injected. It must generally be supplied by the engine, and this expends part of its power. An excess is much more hurtful by cooling the cylinder and piston too much, and therefore wasting steam during the next rise of the piston. But the determination of the proper quantity requires a knowledge, which we have not yet acquired, of the quantity of heat contained in the steam in a latent form. As much water must be injected as will absorb all this without rising near to the boiling temperature. But it is of much more importance to know how far we may cool the cylinder with advantage; that is, when will the loss of steam, during the next rise of the piston, compensate for the diminution of its elasticity during its present descent? Our table of elasticities shows us, that by cooling the cylinder to 120° , we shall leave an elasticity equal to one-tenth of the whole power of the engine: if we cool it only to 140° , we leave an elasticity of one-fifth; if we cool it to a blood-heat, we leave an elasticity of one-twentieth. It is extremely difficult to choose among these varieties. Experience, however, informs us, that the best engines are those which use the smallest quantities of injection water. We know an exceedingly good engine having a cylinder of 30 inches and a six feet stroke, which works with something less than one-fifth of a cubic foot of water at each injection; and we imagine that the quantity should be nearly in the proportion of the capacity of the cylinder. Defaguliers observed, that a very good engine, with a cylinder of 32 inches, worked with 300 inches of water at each injection, which does not much exceed one-sixth of a cubic foot. Mr Watt's observa-

tions, by means of the barometer, must have given him much valuable information in this particular, and we hope that he will not always withhold them from the public.

We have gone thus far in the examination, in order seemingly to ascertain the motion of the engine when loaded and balanced in any known manner, and in order to discover that proportion between the moving power and the load which will produce the greatest quantity of work. The result has been very unsatisfactory, because the computation of the returning stroke is acknowledged to be beyond our abilities. But it has given us the opportunity of directing the reader's attention to the leading circumstances in this inquiry. By knowing the internal state of the cylinder in machines of very different goodness, we learn the connection between the state of the steam and the performance of the machine; and it is very possible that the result of a full examination may be, that in situations where fuel is expensive, it may be proper to employ a weak steam which will expend less fuel, although less work is performed by it. We shall see this confirmed in the clearest manner in some particular employments of the new engines invented by Watt and Boulton.

In the mean time, we see that the equation which we gave from the celebrated Abbé Boffut, is in every respect erroneous even for the purpose which he had in view. We also see that the equation which we substituted in its place, and which was intended for determining that proportion between the counter-weight and the moving force, and the load which would render the working stroke and returning stroke of equal duration, is also erroneous, because these two motions are extremely different in kind, the one being nearly uniform, and the other nearly uniformly accelerated. This being supposed true, it should follow that the counter-weight should be reduced to one half; and we have found this to be very nearly true in some good engines which we have examined.

We shall add but one observation more on this head. An erroneous maxim that the two motions are of equal duration. But the only reason which we have heard for the maxim, is, that it is awkward to see an engine go otherwise. But equally we doubt exceedingly the truth of this maxim, and without being able to give any accurate determination, we think that the engine will do more work if the working stroke be made slower than the returning stroke. Suppose the engine so constructed that they are made in equal times; an addition to the counter-weight will accelerate the returning stroke and retard the working stroke. But as the counter-weight is but small in proportion to the unbalanced portion of the atmospheric pressure, which is the moving force of the machine, it is evident that this addition to the counter-weight must bear a much greater proportion to the counter-weight than it does to the moving force, and must therefore accelerate the returning stroke much more than it retards the working stroke, and the time of both strokes taken together must be diminished by this addition and the performance of the machine improved; and this must be the case as long as the machine is not extravagantly loaded. The best machine which we have seen, in respect of performance, raises a column of water whose weight is very nearly two-thirds of the pressure of the atmosphere.

Steam-Engines.

This examination, though not satisfactory, may direct the attention to the principal circumstances.

An erroneous maxim that the two motions are of equal duration.

Steam-Engine.

atmosphere on the piston, making 11 strokes of six feet each per minute, and the working stroke was almost twice as slow as the other. This engine had worked pumps of 12 inches, which were changed for pumps of 14 inches, all other things remaining the same. In its former state it made from 12 and a half to 13 and a half strokes per minute, the working stroke being considerably slower than the returning stroke. The load was increased, by the change of the pumps, nearly in the proportion to three to four. This had retarded the working stroke; but the performance was evidently increased in the proportion of 3×13 to 4×14 , or of 39 to 44. About 300 pounds were added to the counter-weight, which increased the number of strokes to more than 12 per minute. No sensible change could be observed in the time of the working stroke. The performance was therefore increased in the proportion of 39 to 48. We have therefore no hesitation in saying, that the feemly equality of the two strokes is a sacrifice to fancy. The engineer who observes the working stroke to be slow, fears that his engine may be thought feeble and unequal to its work; a similar notion has long misled him in the construction of water-mills, especially of overshot mills; and, even now, he is submitting with hesitation and fear to the daily correction of experience.

It is needless to engage more deeply in scientific calculations in a subject where so many of the data are so very imperfectly understood.

We venture to recommend as a maxim of construction (supposing always a large boiler and plentiful supply of pure steam unmixed with air), that the load of work be not less than 10 pounds for every square inch of the piston, and the counter-weight to be proportioned that the time of the returning stroke may not exceed two-thirds of that of the working stroke. A serious objection may be made to this maxim, and it deserves mature consideration. Such a load requires the utmost care of the machine, that no admission be given to the common air; and it precludes the possibility of its working, in case the growth of water, or deepening the pit, should make a greater load absolutely necessary. These considerations must be left to the prudence of the engineer. The maxim now recommended relates only to the best actual performance of the engine.

Before quitting this machine, it will not be amiss to give some easy rules, sanctioned by successful practice, for computing its performance. These will enable any artist, who can go through simple calculations, to suit the size of his engine to the task which it is to perform.

The circumstance on which the whole computation must be founded is the quantity of water which must be drawn in a minute, and the depth of the mine; and the performance which may be executed from a good engine is at least 12 strokes per minute of six feet each, working against a column of water whose weight is equal to half of the atmospheric pressure on the steam-piston, or rather to 7.64 pounds on every square inch of its surface.

It is most convenient to estimate the quantity of water in cubic feet, or its weight in pounds, recollecting

that a cubic foot of water weighs 62½ pounds. The depth of the pit is usually reckoned in fathoms of five feet, and the diameter of the cylinder and pump is usually reckoned in inches.

Let Q be the quantity of water to be drawn per minute in cubic feet, and f the depth of the mine in fathoms; let c be the diameter of the cylinder, and p that of the pump; and let us suppose the arms of the beam to be of equal length.

11. To find the diameter of the pump, the area of the piston in square feet is $p^2 \times \frac{0.7854}{144}$. The length

of the column drawn in one minute is 12 times 6 or 72 feet, and therefore its solid contents is $p^3 \times \frac{72 \times 0.7854}{144}$

cubical feet, or $p^3 \times 0.3927$ cubical feet. This must be equal to Q ; therefore p^3 must be $\frac{Q}{0.3927}$ or nearly Q

$\times 2\frac{1}{2}$. Hence this practical rule: Multiply the cubic feet of water which must be drawn in a minute by $2\frac{1}{2}$, and extract the square root of the product: this will be the diameter of the pump in inches.

Thus suppose that 38 cubic feet must be drawn every minute; 38 multiplied by $2\frac{1}{2}$ gives 95, of which the square root is 12, which is the required diameter of the pump.

2. To find the proper diameter of the cylinder.

The piston is to be loaded with 7.64 pounds on every square inch. This is equivalent to six pounds on a circular inch very nearly. The weight of a cylinder of water an inch in diameter and a fathom in height is $2\frac{1}{2}$ pounds, or nearly two pounds. Hence it follows that 6^2 must be made equal to $2fp^2$, and that c^2 is equal to $\frac{2fp^2}{6}$, or to $\frac{f p^2}{3}$.

Hence the following rule: Multiply the square of the diameter of the pump piston (found as above) by the fathoms of lift, and divide the product by 3; the square root of the quotient is the diameter of the cylinder.

Suppose the pit to which the foregoing pump is to be applied is 24 fathoms deep; then $\frac{24 \times 144}{3}$ gives

1152, of which the square root is 34 inches very nearly.

This engine constructed with care will certainly do the work.

Whatever is the load of water proposed for the engine, let 10 be the pounds on every circular inch of the steam piston, and make $c^2 = p^2 \times \frac{2f}{m}$, and the square root will be the diameter of the steam piston in inches.

To free the practical engineer as much as possible from all trouble of calculation, we subjoin the following TABLE of the Dimensions and Power of the Steam Engine, drawn up by Mr Beighton in 1771, and fully verified by practice since that time. The measure is in English ale gallons of 282 cubic inches.

47
The load of work should not be less than 10 pounds for every square inch of the piston.

48
Rules for computing the performance of the steam-engine.

Steam-Engine.

59
Mr. High-ton's table of the diameters and power of the steam-engine.

Dm of pump.	H lbs in one yard.	Press in the foot strokes.	Weights in one yard.	At 16 strokes per min.	Ditto in hog heads.	Data per hour.	The depth to be drawn in yards.										
							15	20	25	30	35	40	45	50	60	70	80
12	14.4	28.8	146	462	7.21	440.	18½	21½	24	26½	28½	30½	32½	34½	37½	40	43½
11	12.13	24.26	123.5	338	6.20	369.33	17	19½	22	25	26½	28	29½	31½	34½	37	39½
10	10.02	20.04	102	320	5.5	304.48	15½	18	20	22	23½	25½	27	28½	31½	34	36½
9	8.12	16.24	82.7	259.8	4.7	247.7	14	16½	18	20	21½	23	24½	25	28	30½	33
8½	7.26	14.52	73.9	232.3	3.43	221.15	13½	15½	17½	19	20½	21½	23	24	26½	28½	31
8	6.41	12.82	65.3	205.2	3.16	195.22	12½	14½	16½	18½	19	20½	21½	23	25	27	29
7½	6.51	12.02	61.2	192.3	3.2	182.13	12	14	15½	17½	18½	19½	21	22	24½	26	28
7½	5.66	11.32	57.6	181.1	2.55	172.30	11	13½	15	16½	18	19	20	21½	23½	25	27
7	4.91	9.82	50.0	157.1	2.31	149.40	10½	13	14	15½	16½	18½	19	20½	22	24	25½
6½	4.23	8.46	43	135.3	2.9	128.54	10	12	13	14	15½	16½	18	19	20	22	23
6	3.61	7.2	36.7	115.5	1.52	110.1	9½	11	12	13	14	15½	16	17	19	20½	22
5½	3.13	6.2	31.8	99.2	1.36	94.30	10	11	12	13	14	15	15½	17	19	20	21
5	2.51	5.0	25.5	80.3	1.7	66.61	10	11	11½	13	13½	14	15½	16½	18½	19½	21
4½	2.02	4.04	20.5	64.6	1.1	60.60	10	11	11½	12	13½	14	15	16	17	18	19½
4	1.6	3.2	16.2	51.2	0.51	48.51	10	10	10	11	11	12	13	14	15	16	17

The first part of the table gives the size of the pump suited to the growth of water. The second gives the size of the cylinder suited to the load of water. If the depth is greater than any in this table, take its fourth part, and double the diameter of the cylinder. Thus if 150 hogheads are to be drawn in an hour from the depth of 100 fathoms, the last column of part first gives for 149.40 a pump of seven inches bore. In a line with this, under the depth of 50 yards, which is one-fourth of 100 fathoms, we find 2½, the double of which is 4½ inches for the diameter of the cylinder.

It is almost impossible to give a general rule for strokes of different lengths, &c. but any one who professes the ability to erect an engine, should surely know as much arithmetic as will accommodate the rule now given to any length of stroke.

We venture to say, that no ordinary engineer can tell *à priori* the number per minute which an engine will give. We took 12 strokes of six feet each for a standard, which a careful engineer may easily accomplish, and which an employer has a right to expect, the engine being loaded with water to half the pressure of the atmosphere: if the load be less, there is some fault—an improper counter weight, or too little boiler, or leaks, &c. &c.

Mr Fitzgerald's method of converting its reciprocating motion into a continued rotary motion.

Such is the state in which Newcomen's steam-engine had continued in use for 60 years, neglected by the philosopher, although it is the most curious object which human ingenuity has yet offered to his contemplation, and abandoned to the efforts of the unlettered artist. Its use has been entirely confined to the raising of water. Mr K and Fitzgerald indeed published in the Philosophical Transactions a method of converting its reciprocating motion into a continued rotary motion by employing the great beam to work a crank or a train of wheel-work. As the real action of the machine is confined to its working stroke, to accomplish this, it became necessary to connect with the crank or wheel-work a very large and heavy fly, which should accumulate in itself the whole pressure of the machine during its time of action, and therefore continue in motion, and urge forward

the working machinery, while the steam engine was going through its inactive returning stroke. This will be the case, provided that the resistance exerted by the working machine during the whole period of the working and returning stroke of the steam-engine, together with the friction of both, does not exceed the whole pressure exerted by the steam-engine during its working stroke; and provided that the momentum of the fly, arising from its great weight and velocity, be very great, so that the resistance of the work during one returning stroke of the steam-engine do not make any very sensible diminution of the velocity of the fly. This is evidently possible and easy. The fly may be made of any magnitude; and being exactly balanced round its axis, it will soon acquire any velocity consistent with the motion of the steam-engine. During the working stroke of the engine it is uniformly accelerated, and by its acquired momentum it produces in the beam the movement of the returning stroke; but in doing this, its momentum is shared with the inert matter of the steam-engine, and consequently its velocity diminished, but not entirely taken away. The next working stroke therefore, by pressing on it afresh, increases its remaining velocity by a quantity nearly equal to the whole that it acquired during the first stroke. We say *nearly*, but not quite equal, because the time of the second working stroke must be shorter than that of the first, on account of the velocity already in the machine. In this manner the fly will be more and more accelerated every succeeding stroke, because the pressure of the engine during the working stroke does more than restore to the fly the momentum which it lost in producing the returning movement of the steam-engine. Now suppose the working part of the machine to be added. The acceleration of the fly during each working stroke of the steam-engine will be less than it was before, because the impelling pressure is now partly employed in driving the working machine, and because the fly will lose more of its momentum during the returning stroke of the steam-engine, part of it being expended in driving the working machine. It is evident, therefore, that a time will

cme

Steam-Engine.

come when the successive augmentation of the fly's velocity will cease; for, on the one hand, the continual acceleration diminishes the time of the next working stroke, and therefore the time of action of the accelerating power. The acceleration must diminish in the same proportion; and on the other hand, the resistance of the working machine generally, though not always, increases with its velocity. The acceleration ceases whenever the addition made to the momentum of the fly during a working stroke of the steam-engine is just equal to what it loses by driving the machine, and by producing the returning movement of the steam-engine.

52
An important addition;

This must be acknowledged to be a very important addition to the engine, and though sufficiently obvious, it is ingenious, and requires considerable skill and address to make it effective (B).

The movement of the working machine, or mill of whatever kind, must be in some degree hobbling or unequal. But this may be made quite insensible, by making the fly exceedingly large, and disposing the greatest part of its weight in the rim. By these means its momentum may be made so great, that the whole force required for driving the mill and producing the returning movement of the engine may bear a very small proportion to it. The diminution of its velocity will then be very trifling.

No counter weight is necessary here, because the returning movement is produced by the inertia of the fly. A counter weight may, however, be employed, and should be employed, viz. as much as will produce the returning movement of the steam-engine. It will do this better than the same force accumulated in the fly; for this force must be accumulated in the fly by the intervention of rubbing parts, by which some of it is lost; and it must be afterwards returned to the engine with a similar loss. But, for the same reason, it would be improper to make the counter weight also able to drive the mill during the returning stroke.

53
but seldom or never adopted.

By this contrivance Mr Fitzgerald hoped to render the steam-engine of most extensive use; and he, or others associated with him, obtained a patent excluding all others from employing the steam engine for turning a crank. They also published proposals for erecting mills of all kinds driven by steam engines, and stated very fairly their powers and their advantages. But their proposals do not seem to have acquired the confidence of the public; for we do not know of any mill ever having been erected under this patent.

53
The great expense of fuel

The great obstacle to this extensive use of the steam-engine is the prodigious expense of fuel. An engine having a cylinder of four feet diameter, working night and day, consumes about 3400 chaldron (London) of good coals in a year.

This circumstance limits the use of steam-engines exceedingly. To draw water from coal-mines, where they can be stocked with unstackable small coal, they are of universal employment; also for valuable mines, for supplying a great and wealthy city with water, and a few other purposes where a great expense can be borne; they are very proper engines; but in a thousand cases where their unlimited powers might be vastly serviceable, the enormous expense of fuel completely excludes them. We cannot doubt but that the attention of engineers was much directed to every thing that could promise a diminution of this expense. Every one had his particular notion for the construction of his furnace, and some were undoubtedly more successful than others. But science was not yet sufficiently advanced: It was not till Dr Black had made his beautiful discovery of latent heat, that we could know the intimate relation between the heat expended in boiling off a quantity of water and the quantity of steam that is produced.

Steam-Engine.
54
to the
of an
point.

Much about the time of this discovery, viz. 1763, Mr James Watt, established in Glasgow in the commercial line, was amusing himself with repairing a working model of the steam engine which belonged to the philosophical apparatus of the university. Mr Watt was a person of a truly philosophical mind, eminently conversant in all branches of natural knowledge, and the pupil and intimate friend of Dr Black. In the course of the above-mentioned amusement many curious facts in the production and condensation of steam occurred to him; and among others, that remarkable fact which is always appealed to by Dr Black as the proof of the immense quantity of heat which is contained in a very minute quantity of water in the form of elastic steam. When a quantity of water is heated several degrees above the boiling point in a close digester, if a hole be opened, the steam rushes out with prodigious violence, and the heat of the remaining water is reduced, in the course of three or four seconds, to the boiling temperature. The water of the steam which has issued amounts only to a very few drops; and yet these have carried off with them the whole excess of heat from the water in the digester.

55
Mr Watt
of the
of the
of the
of the

Since then a certain quantity of steam contains in its great quantity of heat, it must expend a great quantity of fuel; and no construction of furnace can prevent this. Mr Watt therefore set his invention to work to discover methods of husbanding this heat. The cylinder of his little model was heated almost in an instant, so that it could not be touched by the hand. It could not be otherwise, because it condensed the vapour by abstracting its heat. But all the heat thus communicated to the cylinder, and wasted by it on surrounding bodies, contributed nothing to the performance of the

56
in his at-
tempts to
find out a
way to
husband
this heat,

4 P 2 engine,

(B) We do not recollect at present the date of this proposal of Mr Fitzgerald; but in 1781 the Abbé Arnauld, canon of Alais in Languedoc, entertained a thought of the same kind, and proposed it for working lighters in the inland navigations; a scheme which has been successfully practised (we are told) in America. His brother, a major of engineers in the Austrian service, has carried the thing much farther, and applied it to manufactures; and the Aulic Chamber of Mines at Vienna has patronized the project: (See *Journal Encyclopedique*, 1781.) But these schemes are long posterior to Mr Fitzgerald's patent, and are even later than the erection of several machines driven by steam-engines which have been erected by Messrs Watt and Boulton. We think it our duty to state these particulars, because it is very usual for our neighbours on the continent to assume the credit of British inventions.

Steam-Engine.

same time still restricting ourselves to the essential circumstances, and avoiding every peculiarity which is to be found in the prodigious varieties which Mr Watt has introduced into the machines which he has erected, every individual of which has been adapted to local circumstances, or diversified by the progress of Mr Watt's improvements.

61
Description of the machine after these improvements were added.
Fig. 9.

Let A (fig. 9.) represent the boiler. This has received great improvements from his complete acquaintance with the procedure of nature in the production of steam. In some of his engines the fuel has been placed in the middle of the water, surrounded by an iron or copper vessel, while the exterior boiler was made of wood, which transmits, and therefore wastes the heat very slowly. In others, the flame not only plays round the whole outside, as in common boilers, but also runs along several flues which are conducted through the middle of the water. By such contrivances the fire is applied to the water in a most extensive surface, and for a long time, so as to impart to it the greatest part of its heat. So skillfully was it applied in the Albion mills, that although it was perhaps the largest engine in the kingdom, its unconsumed smoke was inferior to that of a very small brew-house. In this second engine of Mr Watt, the top of the cylinder is that up by a strong metal plate *g h*, in the middle of which is a collar or box of leathers *k l*, formed in the usual manner of a jack-head pump, through which the piston rod PD, nicely turned and polished, can move up and down, without allowing any air to pass by its sides. From the dome of the boiler proceeds a large pipe BCIOQ, which, after reaching the cylinder with its horizontal part BC, descends parallel to its side, sending off two branches, viz. IM to the top of the cylinder, and ON to its bottom. At I is a puppet valve opening from below upwards. At L, immediately below this branch, there is a similar valve, also opening from below upwards. The pipe descends to Q, near the bottom of a large cistern *c d e f*, filled with cold water constantly renewed. The pipe is then continued horizontally along the bottom of this cistern (but not in contact), and terminates at R in a large pump ST. The piston S has slack valves opening upwards, and its rod S r, passing through a collar of leathers at T, is suspended by a chain to a small arch head on the outer arm of the beam. There is a valve R in the bottom of this pump, as usual, which opens when pressed in the direction QR, and shuts against a contrary pressure. This pump delivers its contents into another pump XY, by means of the small pipe *t x*, which proceeds from its top. This second pump has a valve at X, and a check in its piston Z as usual, and the piston rod Z σ is suspended from another arch head on the outer arm of the beam. The two valves I and L are opened and shut by means of spammers and handles, which are put in motion by a plug frame, in the same manner as in Newcomen's engine.

Lastly, there may be observed a crooked pipe *a b c*, which enters the upright pipe *e* laterally a little above Q. This has a small jet hole at *a*; and the other end *a*, which is considerably under the surface of the water of the condensing cistern, is covered with a puppet valve σ , whose long stalk *a b* rises above the water, and may be raised or lowered by hand or by the plug beam. The valves R and X, and the checks in the pistons S and Z,

are opened or shut by the pressures to which they are immediately exposed.

Steam-Engine.

This figure is not an exact copy of any of Mr Watt's engines, but has its parts so disposed that all may come distinctly into view, and exactly perform their various functions. It is drawn in its quietest position, the outer end of the beam preponderating by the counter weight, and the piston P at the top of the cylinder, and the pistons S and Z in their lowest situations.

In this situation let us suppose that a vacuum is (by any means) produced in all the space below the piston: the valve I being shut. It is evident that the valve I will also be shut, as also the valve σ . Now let the valve I be opened. The steam from the boiler, as elastic as common air, will rush into the space above the piston, and will exert on it a pressure as great as that of the atmosphere. It will therefore press it down, raise the outer end of the beam, and cause it to perform the same work as an ordinary engine.

When the piston P has reached the bottom of the cylinder, the plug frame shuts the valve I, and opens L. By so doing the communication is open between the top and bottom of the cylinder, and nothing hinders the steam which is above the piston from going along the passage ALON. The piston is now equally affected on both sides by the steam, even though a part of it is continually condensed by the cylinder, and in the pipe IOQ. Nothing therefore hinders the piston from being dragged up by the counter weight, which acts with its whole force, undiminished by any remaining unbalanced elasticity of steam. Here therefore this form of the engine has an advantage (and by no means a small one) over the common engines, in which a great part of the counter weight is expended in overcoming unbalanced atmospheric pressure.

Whenever the piston P arrives at the top of the cylinder, the valve L is shut by the plug frame, and the valves I and σ are opened. All the space below the piston is at this time occupied by the steam which came from the upper part of the cylinder. This being a little wasted by condensation, is not quite a balance for the pressure of the atmosphere. Therefore, during the ascent of the piston, the valve R was shut, and it remains so. When, therefore, the valve σ is opened, the cold water of the cistern must spout up through the hole *a*, and condense the steam. To this must be added the coldness of the whole pipe OQ σ . As fast as it is condensed, its place is supplied by steam from the lower part of the cylinder. We have already remarked, that this successive condensation is accomplished with astonishing rapidity. In the mean time, steam from the boiler presses on the upper surface of the piston. It must therefore descend as before, and the engine must perform a second working stroke.

But in the mean time the injection water lies in the bottom of the pipe OQR, heated to a considerable degree by the condensation of the steam; also a quantity of air has been disengaged from it and from the water in the boiler. How is this to be discharged?—This is the office of the pumps ST and XY. The capacity of ST is very great in proportion to the space in which the air and water are lodged. When, therefore, the piston S has got to the top of its course, there must be a vacuum in the barrel of this pump, and the water and air must open the valve R and come into it. When the

piston

Steam-Engine

piston S comes down again in the next returning stroke, this water and air gets through the valve of the piston; and in the next working stroke they are discharged by the piston into the pump XY, and raised by its piston. The air escapes at Y, and as much of the water as is necessary is delivered into the boiler by a small pipe Yg to supply its waste. It is a matter of indifference whether the pistons S and Z rise with the outer or inner end of the beam, but it is rather better that they rise with the inner end. They are otherwise drawn here, in order to detach them from the rest and show them more distinctly.

Such is Mr Watt's second engine. Let us examine its principles, that we may see the causes of its avowed and great superiority over the common engines.

62
Causes of its superiority over common engines are the full use of the counter weight.

We have already seen one ground of superiority, the full operation of the counter weight. We are authorized by careful examination to say, that in the common engines at least one-half of the counter weight is expended in counteracting an unbalanced pressure of the air on the piston during its ascent. In many engines, which are not the worst, this extends to $\frac{1}{4}$ th of the whole pressure. This is evident from the examination of the engine at Montreuil by Boissier. This makes a very great counter weight necessary, which exhausts a proportional part of the moving force.

63
And great loss of steam.

But the great advantage of Mr Watt's form is the almost total annihilation of the waste of steam by condensation in the cylinder. The cylinder is always boiling hot, and therefore perfectly dry. This must be evident to any person who understands the subject. By the time that Mr Watt had completed his improvements, his experiments on the production of steam had given him a pretty accurate knowledge of its density; and he found himself authorized to say, that the quantity of steam employed did not exceed twice as much as would fill the cylinder, so that not above one-half was unavoidably wasted. But before he could bring the engine to this degree of perfection, he had many difficulties to overcome: He inclosed the cylinder in an outer wooden case at a small distance from it. This diminished the expense of heat by communication to surrounding bodies. Sometimes he allowed the steam from the boiler to occur, yis interval. This undoubtedly prevented all dissipation from the inner cylinder; but in its turn it dissipated much heat by the outer case, and a very sensible condensation was observed between them. This has occasioned him to omit this circumstance in some of his best engines. We believe it was omitted in the Alliston mills.

The greatest difficulty was to make the great piston tight. The old and effectual method, by water lying on it, was inadmissible. He was therefore obliged to have his cylinders most nicely bored, perfectly cylindrical, and finely polished; and he made numberless trials of different soft substances for packing his piston, which should be tight without enormous friction, and which should be so, in a situation perfectly dry, and hot about to go.

After all that Mr Watt has done in this respect, he still perceives in his engines a waste of steam which he still perceives in his engines arises from the unavoidable escape by the sides of the piston during its descent.

But the fact is, that an engine of this construction,

of the same dimensions with a common engine, making the same number of strokes of the same extent, does not consume above one-fourth part of the fuel that is consumed by the best engines of the common form. It is also a very fortunate circumstance, that the performance of the engine is not immediately destroyed, nor indeed sensibly diminished, by a small want of tightness in the piston. In the common engine, if air get in, in this way, it immediately puts a stop to the work; but although even a considerable quantity of steam get past the piston during its descent, the rapidity of condensation is such, that hardly any diminution of pressure can be observed.

Steam-Engine

Mr Watt's penetration soon discovered another most valuable property of this engine. When an engine of the common form is erected, the engineer must make an accurate estimate of the work to be performed, and must proportion his engine accordingly. He must be careful that it be fully able to execute its task; but its power must not exceed its load in any extravagant degree. This would produce a motion which is too rapid, and which, being alternately in opposite directions, would occasion jolts which no building or machinery could withstand. Many engines have been shattered by the pumps drawing air, or a pump-rod breaking; by which accidents the steam-piston descends with such rapidity that every thing gives way. But in most operations of mining, the task of the engine increases, and it must be so constructed at first as to be able to bear this addition. It is very difficult to manage an engine that is much superior to its task; and the safest way is, to have it almost full loaded, and to work it only during a few hours each day, and allow the pit water to accumulate during its repose. This increases the fire cost, and wastes fuel during the inaction of the engine.

64
Another valuable property of it.

But this new engine can at all times be exactly fitted, (at least during the working stroke) to the load of work that then happens to be on it. We have only to diminish steam of a proper elasticity. At the first erection the engine may be equal to twice its task, if the steam admitted above the cylinder be equal to that of common boiling water; but when once the ebullition is fairly commenced, and the whole air expelled from all parts of the apparatus, it is evident, that by damping the fire, steam of half this elasticity may be continually supplied, and the water will continue boiling although its temperature does not exceed 185° of Fahrenheit's thermometer. This appears by inspecting our table of vaporous elasticity, and affords another argument for rendering that table more accurate by new experiments.

65
is, that it can always be exactly fitted to the load which has to be performed on it.

We hope that Mr Watt will not withhold from the public the knowledge which he has acquired on this subject. It may very possibly result from an accurate investigation, that it would be advisable to work our steam-engines with weak steams, and that the diminution of work may be more than compensated by the diminution of fuel. It is more probable indeed, and it is Mr Watt's opinion, that the contrary is the case, and that it is much more economical to employ great heats. At any rate, the decision of this question is of great importance for improving the engine; and we see, in the mean time, that the engine can at all times be fitted so as to perform its task with a moderate and manageable motion, and that as the task increases we can increase the power of the engine.

Steam-Engine.
66
See icon
reference

Steam-Engine.

But the method now proposed has a great inconvenience. While the steam is weaker than the atmosphere, there is an external force tending to squeeze in the sides and bottom of the boiler. This could not be resisted when the difference is considerable, and common air would rush in through every crevice of the boiler and soon choke the engine: it must therefore be given up.

But the same effect will be produced by diminishing the passage for the steam into the cylinder. For this purpose, the puppet valve by which the steam enters the cylinder was made in the form of a long taper spigot, and it was lodged in a cone of the same shape; consequently the passage could be enlarged or contracted at pleasure by the distance to which the inner cone was drawn up.

In this way several engines were constructed, and the general purpose of suiting the power of the engine to its task was completely answered; but (as the mathematical reader will readily perceive) it was extremely difficult to make this adjustment precise and constant. In a great machine like this going by jerks, it was hardly possible that every successive motion of the valve should be precisely the same. This occasioned very sensible irregularities in the motion of the engine, which increased and became hazardous when the joints worked loose by long use.

Mr Watt's genius, always fertile in resources, found out a complete remedy for all these inconveniences. Making the valve of the ordinary form of a puppet clack, he adjusted the button of its stalk or tail so that it should always open full to the same height. He then regulated the pins of the plug-frame, in such a manner that the valve should shut the moment that the piston had descended a certain proportion (suppose one-fourth, one-third, one-half, &c.) of the cylinder. So far the cylinder was occupied by steam as elastic as common air. In pressing the piston farther down, it behaved the steam to expand, and its elasticity to diminish. It is plain that this could be done in any degree we please, and that the adjustment can be varied in a minute, according to the exigency of the case, by moving the plug pins.

In the mean time, it must be observed, that the pressure on the piston is continually changing, and consequently the accelerating force. The motion therefore will no longer be uniformly accelerated: it will approach much faster to uniformity; nay, it may be retarded, because although the pressure on the piston at the beginning of the stroke may exceed the resistance of the load, yet when the piston is near the bottom the resistance may exceed the pressure. Whatever may be the law by which the pressure on the piston varies, an ingenious mechanic may contrive the connecting machinery in such a way that the chairs or rods at the outer end of the beam shall continually exert the same pressure, or shall vary their pressure according to any law he finds most convenient. It is in this manner that the watchmaker, by the form of the fusee, produces an equal pressure on the wheel-work by means of a very unequal action of the main-spring. In like manner, by making the outer arch heads portions of a proper spiral instead of a circle, we can regulate the force of the beam at pleasure.

Thus we see how much more manageable an engine in this form than Newcomen's was, and also more

easily investigated in respect of its power in its various positions. The knowledge of this last circumstance was of mighty consequence, and without it no notion could be formed of what it could perform. This suggested to Mr Watt the use of the barometer communicating with the cylinder; and by the knowledge acquired by these means has the machine been so much improved by its ingenious inventor.

We must not omit in this place one deduction made by Mr Watt from his observations, which may be called a discovery of great importance in the theory of the engine.

Let ABCD (fig. 10.) represent a section of the cylinder of a steam-engine, and EF the surface of its piston. Let us suppose that the steam was admitted while EF was in contact with AB, and that as soon as it had pressed it down to the situation EF the steam-cock is shut. The steam will continue to press it down, and as the steam expands its pressure diminishes. We may express its pressure (exerted all the while the piston moves from the situation AB to the situation EF) by the line EF. If we suppose the elasticity of the steam proportional to its density, as is nearly the case with air, we may express the pressure on the piston in any other position, such as KL or DC, by K / and D c, the ordinates of a rectangular hyperbola F / c, of which AE, AB are the asymptotes, and A the centre. The accumulated pressure during the motion of the piston from EF to DC will be expressed by the area EFcDE, and the pressure during the whole motion by the area ABFE DA.

Now it is well known that the area EFcDE is equal to ABFE multiplied by the hyperbolic logarithm of $\frac{AD}{AE} = L \frac{AD}{AE}$, and the whole area ABFE c DA is = ABFE $\times \left(1 + L \frac{AD}{AE} \right)$.

Thus let the diameter of the piston be 24 inches, and the pressure of the atmosphere on a square inch be 14 pounds; the pressure on the piston is 6333 pounds. Let the whole stroke be 6 feet, and let the steam be stopped when the piston has descended 18 inches, or 1.5 feet. The hyperbolic logarithm of $\frac{6}{1.5}$ is 1.3862943. Therefore the accumulated pressure = ABFE c DA is = 6333 \times 2.3862943 = 15114 pounds.

As few professional engineers are possessed of a table of hyperbolic logarithms, while tables of common logarithms are or should be in the hands of every person who is much engaged in mechanical calculations, let the following method be practised. Take the common logarithm of $\frac{AD}{AE}$, and multiply it by 2.3026; the product is the hyperbolic logarithm of $\frac{AD}{AE}$.

The accumulated pressure while the piston moves from AB to EF is 6333 \times 1, or simply 6333 pounds. Therefore the steam while it expands into the whole cylinder adds a pressure of 8781 pounds.

Suppose that the beam had got free admission during the whole descent of the piston, the accumulated pressure would have been 6333 \times 4, or 25332 pounds.

Here Mr Watt observed a remarkable result. The steam expended in this case would have been four times greater.

70
A discovery of Mr Watt of great importance in the theory of the engine. Fig. 10.

67
remedy at
ended
with some
difficulties;

63
But the
remedy at-
tended
with some
difficulties;

69
which Mr
Watt's in-
ventive
genius
completely
removd.

Fig. 2.

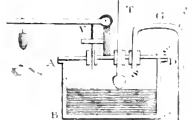

Fig. 1.

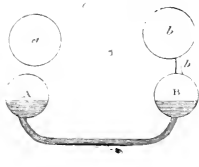
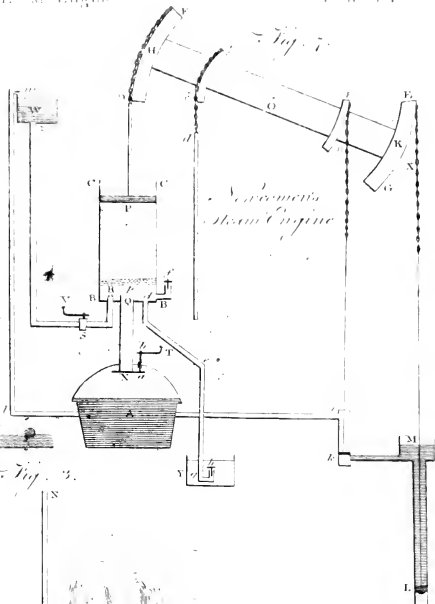

Fig. 6.

K.

Savary's
Steam Engine.

Fig. 7.



Savary's
Steam Engine

Fig. 3.

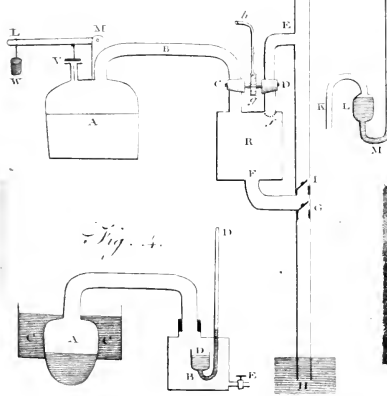
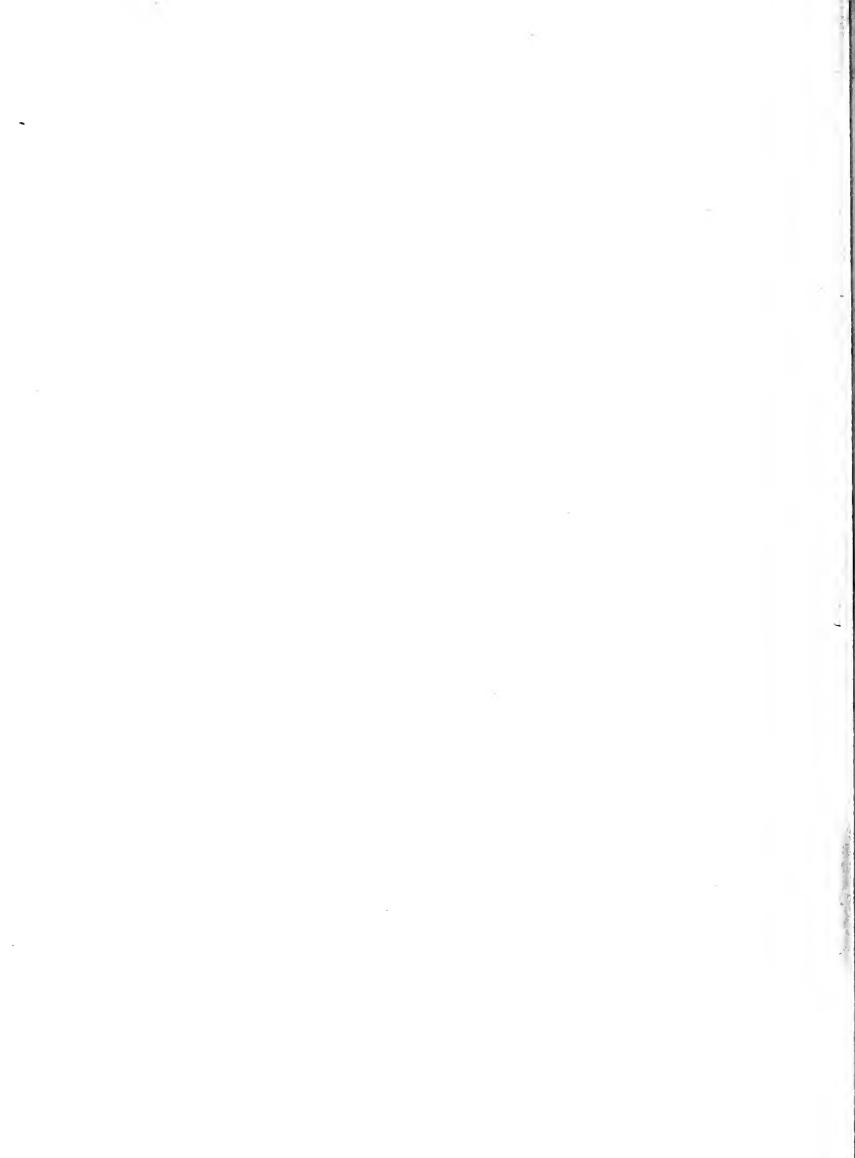
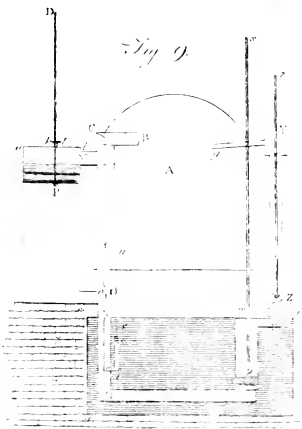
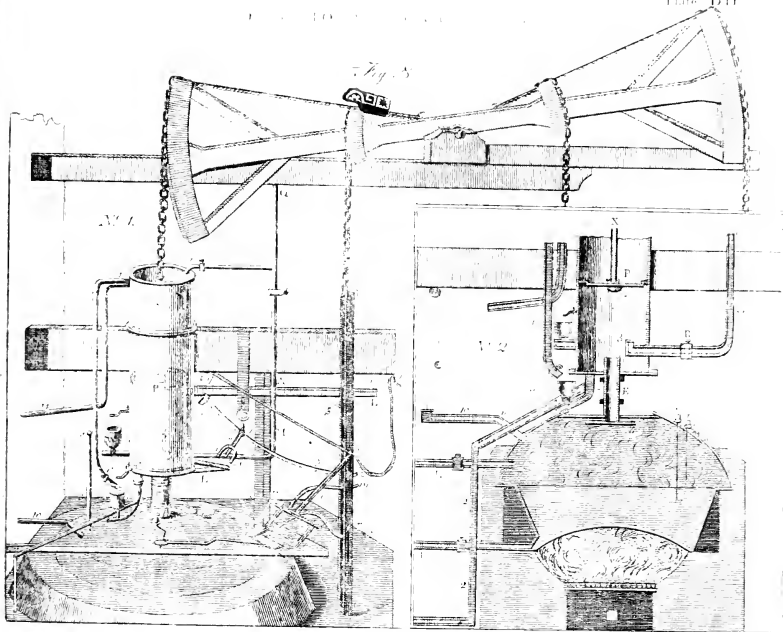

Fig. 4.

Fig. 5.







Hornblower's
STEAM ENGINE.

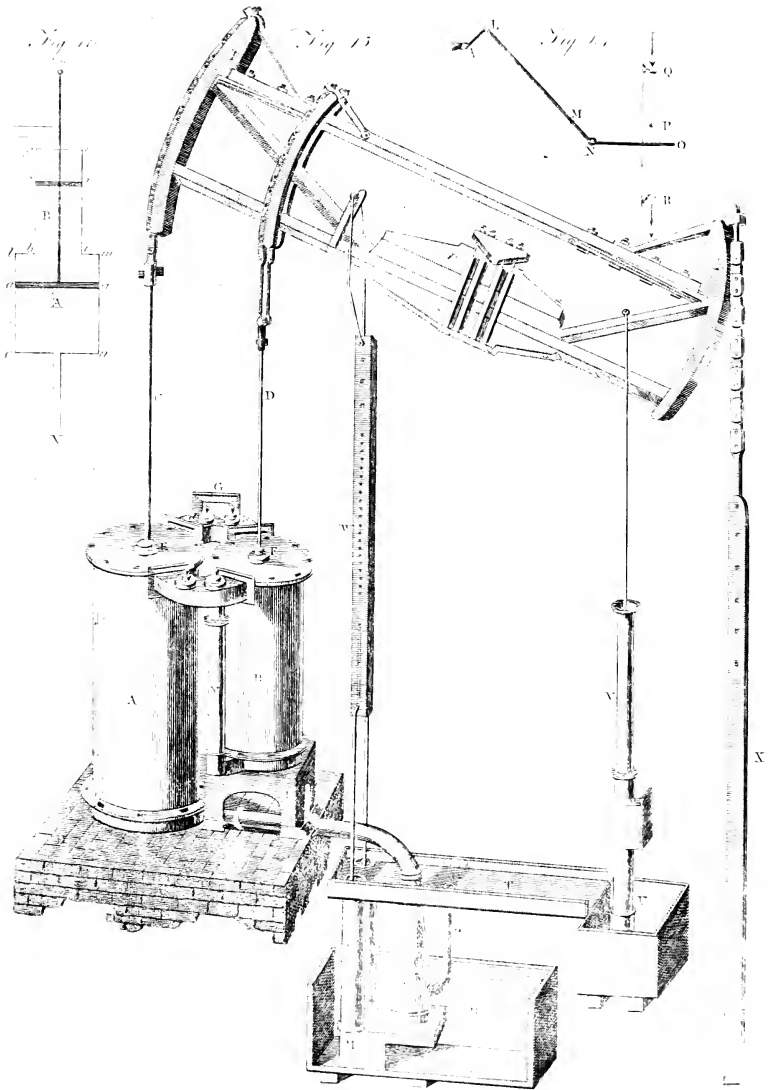



Steam-Engine.

the link, the inner half (that is, the half next the cylinder) of the wheel U will work on the inner half of the wheel W, so that at the end of the revolution of the fly the wheel W must have got to the top of the wheel U, and the outer end of the beam must be raised to its highest position. The next revolution of the fly will bring the wheel W and the beam connected with it to their first positions; and thus every two revolutions of the fly will make a complete period of the beam's reciprocating movements. Now, instead of supposing the fly to drive the beam, let the beam drive the fly. The motions must be perfectly the same, and the ascent or descent of the piston will produce one revolution of the fly.

Fig. 12.

A side view of this apparatus is given in fig. 12, marked by the same letters of reference. This shows the situation of parts which were fore-shortened in fig. 11, particularly the descending branch C of the steam-pipe, and the situation and communications of the two pumps K and I. 8, 8 is the horizontal part of the steam-pipe. 9 is a part of it whose box is represented by the dark circle of fig. 11. D is the box of the steam-check; and the little circle at its corner represents the end of the axis which turns it, as will be described afterwards. N is the place of the upper eduction-valve. A part only of the upper eduction-pipe G is represented, the rest being cut off, because it would have covered the descending steam-pipe CC. When continued down, it comes between the eye and the box E of the lower steam-valve, and the box F of the lower eduction-valve.

Let us now trace the operation of this machine through all its steps. Recurring to fig. 11, let us suppose that the lower part of the cylinder BB is exhausted of all elastic fluids; that the upper steam-valve D and the lower eduction-valve F are open, and that the lower steam-valve E and upper eduction-valve N are shut. It is evident that the piston must be pressed toward the bottom of the cylinder, and must pull down the end of the working beam by means of the toothed rack OO and sector QQ, causing the other end of the beam to urge forward the machinery with which it is connected. When the piston arrives at the bottom of the cylinder, the valves D and F are shut by the plug frame, and E and N are opened. By this last passage the steam gets into the eduction-pipe, where it meets with the injection water, and is rapidly condensed. The steam from the boiler enters at the same time by E, and pressing on the lower side of the piston, forces it upwards, and by means of the toothed rack OO and toothed sector QQ forces up that end of the working beam, and causes the other end to urge forward the machinery with which it is connected: and in this manner the operation of the engine may be continued for ever.

The injection water is continually running into the eduction-pipe, because condensation is continually going on, and therefore there is a continual atmospheric pressure to produce a jet. The air which is disengaged from the water, or enters by leaks, is evacuated only during the rise of the piston of the air-pump K. When this is very copious, it renders a very large air-pump necessary; and in some situations Mr Watt has been obliged to employ two air-pumps, one worked by each aim of the beam. This in every case expends a very considerable portion of the power, for the air pump is

always working against the whole pressure of the atmosphere.

It is evident that this form of the engine, by maintaining an almost constant and uninterrupted impulsion, is much fitter for driving any machinery of continued motion than any of the former engines, which were inactive during half of their motion. It does not, however, seem to have this superiority when employed to draw water: But it is equally fitted for this task. Let the engine be loaded with twice as much as would be proper for it if a single-stroke engine, and let a fly be connected with it. Then it is plain that the power of the engine during the rise of the steam-piston will be accumulated in the fly; and this, in conjunction with the power of the engine during the descent of the steam-piston, will be equal to the whole load of water.

In speaking of the steam and eduction-valves, we said that they were all puppet-valves. Mr Watt employed cocks, and also sliding-valves, such as the regulator or steam-valves in the old engines. But he found them always lose their tightness after a short time. This is not surprising, when we consider that they are always perfectly dry, and almost burning hot. He was therefore obliged to change them all for puppet-checks, which, when truly ground and nicely fitted in their motions at first, are not found to go out of order by any length of time. Other engineers now universally use them in the old form of the steam-engine, without the same reasons, and merely by servile and ignorant imitation.

The way in which Mr Watt opens and shuts these valves is as follows. Fig. 13, represents a check with its seat and box. Suppose it one of the eduction-valves. HH is part of the pipe which introduces the steam, and GG is the upper part of the pipe which communicates with the condenser. At EE may be observed a piece more faintly shaded than the surrounding parts. This is the seat of the valve, and is a brass or bell-metal ring turned conical on the outside, so as to fit exactly into a conical part of the pipe GG. These two pieces are fitted by grinding; and the cone being of a long taper, the ring sticks firmly in it, especially after having been there for some time and united by rust. The check itself is a strong brass plate D, turned conical on the edge, so as to fit the conical or sloping inner edge of the seat. These are very nicely ground on each other with emery. This conical joining is much more obtuse than the outer side of the ring; so that although the joint is air-tight, the two pieces do not stick strongly together. The check has a round tail DG, which is freely moveable up and down in the hole of a cross piece FF. On the upper side of the valve is a strong piece of metal DC firmly joined to it, one side of which is formed into a toothed rack. A is the section of an iron axle which turns in holes in the opposite sides of the valve-box, where it is nicely fitted by grinding, so as to be air-tight. Collets of thick leather, well soaked in melted tallow and rosin, are screwed on the outside of these holes to prevent all ingress of air. One end of this axis projects a good way without the box, and carries a banner or handle, which is moved by the plug-frame. To this axis is fixed a strong piece of metal B, the edge of which is formed into an arch of a circle having the axis A in its centre, and is cut into teeth, which work in the

Steam-Engine.

Fig. 13.

Steam-Engine.

teeth of the rack DC. K is a cover which is fixed by screws to the top of the box HJJH, and may be taken off in order to get at the valve when it needs repairs.

From this description it is easy to see that by turning the handle which is on the axis A, the factor B will lift up the valve by means of its toothed rack DC, till the upper end of the rack touch the knob or button K. Turning the handle in the opposite direction brings the valve down again to its seat.

This valve is extremely tight. But in order to open it for the passage of the steam, we must exert a force equal to the pressure of the atmosphere. This in a large engine is a very great weight. A valve of six inches diameter sustains a pressure not less than 400 pounds. But this force is quite momentary, and hardly impedes the motion of the engine; for the instant the valve is detached from its seat, although it has not moved the 100th part of an inch, the pressure is over. Even this little inconvenience has been removed by a delicate thought of Mr Watt. He has put the spanner in such a position when it begins to raise the valve, that its mechanical energy is almost infinitely great. Let QR (fig. 14) be part of the y-rod-frame descending, and P one of its pins just going to lay hold of the spanner NO moveable round the axis N. On the same axis is another arm NM connected by a joint with the leader ML, which is connected also by a joint with the spanner LA that is on the axis A of the factor within the valve-box. Therefore when the pin P pushes down the spanner NO, the arm NM moves sidewise and pulls down the spanner AL by means of the connecting rod. Things are so disposed, that when the cock is shut, LM and MN are in one straight line. The intelligent mechanic will perceive that, in this position, the force of the lever ONM is insuperable. It has this further advantage, that if any thing should tend to force open the valve, it would be ineffectual; for no force exerted at A, and transmitted by the rod LM, can possibly push the joint M out of its position. Of such importance is it to practical mechanics, that its professors should be persons of penetration as well as knowledge. Yet this circumstance is unheeded by hundreds who have servilely copied from Mr Watt, as may be seen in every engine that is pushed on the public as a discovery and an improvement. When these puppet-valves have been introduced into the common engine, we have not seen one instance where this has been attended to; certainly because its utility has not been observed: and there is one situation where it is of more consequence than in Mr Watt's engine, viz. in the injection-cock. Here the valve is drawn back into a box, where the water is so awkwardly disposed round it that it can hardly get out of its way, and where the pressure even exceeds that of the atmosphere. Indeed this particular substitution of the button-valve for the cock is most injudicious.

We postponed any account of the office of the fly XX (fig. 11), as it is not of use in an engine regulated by the fly VV. The fly XX is only for regulating the reciprocating motion of the beam when the steam is not admitted during the whole descent of the piston. This it evidently must render more uniform, accumulating a momentum equal to the whole pressure of the full supply of steam, and then sharing it with the beam during the rest of the descent of the piston.

When a person properly skilled in mechanics and

chemistry reviews these different forms of Mr Watt's steam-engine, he will easily perceive them susceptible of many intermediate forms, in which any one or more of the distinguishing improvements may be employed. The first great improvement was the condensation in a separate vessel. This increased the original powers of the engine, giving to the atmospheric pressure and to the counter weight their full energy; at the same time the waste of steam is greatly diminished. The next improvement, by employing the pressure of the steam instead of that of the atmosphere, aimed only at a still farther diminution of the waste; but was fertile in advantages, rendering the machine more manageable, and particularly enabling us at all times, and without trouble, to suit the power of the engine to its load of work, however variable and increasing; and brought into view a very interesting proposition in the mechanical theory of the engine, viz. that the whole performance of a given quantity of steam may be augmented by admitting it into the cylinder only during a part of the piston's motion. Mr Watt has varied the application of this proposition in a thousand ways; and there is nothing about the machine which gives more employment to the sagacity and judgement of the engineer. The third improvement of the double impulse may be considered as the finishing touch given to the engine, and renders it as uniform in its action as any water-wheel. In the engine in its most perfect form there does not seem to be above one-fourth of the steam wasted by warming the apparatus; so that it is not possible to make it one-fourth part more powerful than it is at present. The only thing that seems susceptible of considerable improvement is the great beam. The enormous strains exerted now on its arms require a proportional strength. This requires a vast mass of matter, not less indeed in an engine with a cylinder of 54 inches than three tons and a half, moving with the velocity of three feet in a second, which must be communicated in about half a second. This mass must be brought into motion from a state of rest, must again be brought to rest, again into motion, and again to rest, to complete the period of a stroke. This consumes much power; and Mr Watt has not been able to load an engine with more than 10 or 11 pounds on the inch and preserve a sufficient quantity of motion, so as to make 12 or 15 six-foot strokes in a second. Many attempts have been made to lessen this mass by using a light framed wheel, or a light frame of carpentry, in place of a solid beam. These have generally been constructed by persons ignorant of the true scientific principles of carpentry, and have failed accordingly. Mr Watt has made similar attempts; but found, that although at first they were abundantly strong, yet after a short time's employment the fraps and bolts with which the wooden parts were connected cut their way into the wood, and the framing grew loose in the joints, and, without giving any warning, went to pieces in an instant. A solid massy simple beam, of sufficient strength, lends, and sensibly complains (as the carpenters express it), before it breaks. In all great engines, therefore, such only are employed, and in smaller engines he sometimes uses cast-iron wheels or pulleys; nay, he frequently uses no beam or equivalent whatever, but employs the steam-piston rod to drive the machinery to which the engine is applied.

We presume that our thinking readers will not be displeas-

Steam-Engine.

74
Review of
Mr Watt's
three great
improvements.

73
The only
improvement
now
wanting is
to strength-
en the great
beam.

Steam-Engine.

displeas'd with this rational history of the progress of this engine in the hands of its ingenious and worthy inventor. We owe it to the communications of a friend, well acquainted with him, and able to judge of his merits. The public see him always associated with the no less celebrated mechanic and philosopher Mr Boulton of Soho near Birmingham (see SOTO). They have thiered the royal patent from the beginning; and the alliance is equally honourable to both.

74 Mr Watt associated with Mr Boulton.

75 Wherein their profits are derived in erecting engines.

The advantages derived from the patent-right show both the superiority of the engine and the liberal minds of the proprietors. They erect the engines at the expense of the employers, or give working drafts of all the parts, with instructions, by which any resident engineer may execute the work. The employers select the best engine of the ordinary kind in the kingdom, compare the quantities of fuel expended by each, and pay to Messrs Watt and Boulton one-third of the annual savings for a certain term of years. By this the patentees are excited to do their utmost to make the engine perfect; and the employer pays in proportion to the advantage he derives from it.

It may not be here improper to state the actual performance of some of these engines, as they have been ascertained by experiment.

76 What the actual performance of some of these engines is.

An engine having a cylinder of 31 inches in diameter, and making 17 double strokes per minute, performs the work of forty horses working night and day (for which three relays or 120 horses must be kept), and burns 11,000 pounds of Staffordshire coal per day. A cylinder of 19 inches, making 25 strokes of 4 feet each per minute, performs the work of 12 horses working constantly, and burns 3700 pounds of coals per day. A cylinder of 24 inches, making 22 strokes of 5 feet, burns 5500 pounds of coals, and is equivalent to the constant work of 22 horses. And the patentees think themselves authorized by experience to say in general, that these engines will raise more than 20,000 cubic feet of water 24 feet high for every hundred weight of good pit-coal consumed by them.

In consequence of the great superiority of Mr Watt's engines, both with respect to economy and manageableness, they have become of most extensive use; and in every demand of manufacture on a great scale they offer us an indefatigable servant, whose strength has no bounds. The greatest mechanical project that ever engaged the attention of man was on the point of being executed by this machine. The States of Holland were treating with Messrs Watt and Boulton for draining the Haarlem Meer, and even reducing the Zuider Zee; and we doubt not but that it will be accomplished whenever that unhappy nation has sufficiently felt the difference between liberty and foreign tyranny. Indeed such unlimited powers are afforded by this engine, that the engineer now thinks that no task can be proposed to him which he cannot execute with profit to his employer.

77 Proposed to drain the Haarlem Meer by the steam-engines.

78 The attempts to improve Mr Watt's engine in general of little advantage;

No wonder then that all classes of engineers have turned much of their attention to this engine; and seeing that it has done so much, that they try to make it do still more. Numberless attempts have been made to improve Mr Watt's engine; and it would occupy a volume to give an account of them, whilst that account would do no more than indulge curiosity. Our engineers by profession are in general miserably deficient in that accurate knowledge of mechanics and of chemistry

which is necessary for understanding this machine; and we have not heard of one in this kingdom who can be put on a par with the present patentees in this respect. Most of the attempts of engineers have been made with the humbler view of availing themselves of Mr Watt's discoveries, so as to construct a steam-engine superior to Newcomen's, and yet of a form sufficiently different from Watt's to keep it without the reach of his patent. This they have in general accomplished by performing the condensation in a place which, with a little stretch of fancy, not infrequent in a court of law, may be called part of the cylinder.

Steam-Engine.

The success of most of these attempts has interfered so little with the interest of the patentees, that they have not hindered the erection of many engines which the law would have deemed encroachments. We think it our duty to give our opinion on this subject without reserve. There are most expensive undertakings, and few employers are able to judge accurately of the merits of a project presented to them by an ingenious artist. They may see the practicability of the scheme, by having a general notion of the expansion and condensation of steam, and they may be misled by the ingenuity apparent in the construction. The engineer himself is frequently the dupe of his own ingenuity; and it is not always dishonestly, but frequently ignorance, which makes him prefer his own invention or (as he thinks it) improvement. It is a most delicate engine, and requires much knowledge to see what does and what does not improve its performance. We have gone into the preceding minute investigation of Mr Watt's progress with the express purpose of making our readers fully masters of its principles, and have more than once pointed out the real improvements, that they may be firmly fixed and always ready in the mind. By having recourse to them, the reader may pronounce with confidence on the merits of any new construction, and will not be deceived by the puffs of an ignorant or dishonest engineer.

We must except from this general criticism a construction by Mr Jonathan Hornblower near Bristol, on account of its singularity, and the ingenuity and real skill which appears in some particulars of its construction. The following short description will sufficiently explain its principle, and enable our readers to appreciate its merit.

79 and the fire etc of this has not injured the other.

80 Exception in favour of Mr Hornblower.

A and B (fig. 15.) represent two cylinders, of which A is the largest. A piston moves in each, having their rods C and D moving through collars at E and F. These cylinders may be supplied with steam from the boiler by means of the square pipe G, which has a flange to connect it with the rest of the steam-pipe. This square part is represented as branching off to both cylinders. e and d are two cocks, which have handles and tumblers as usual, worked by the plug-beam W. On the fire-side (that is, the side next the eye) of the cylinders is represented another communicating pipe, whose section is also square or rectangular, having also two cocks a, b. The pipe Y, immediately under the cock b, establishes a communication between the upper and lower parts of the small cylinder B, by opening the cock B. There is a similar pipe on the other side of the cylinder A, immediately under the cock d. When the cocks c and a are open, and the cocks b and d are shut, the steam from the boiler has free admission into the upper part of the cylinder B, and the steam

Plate DIV. or Description of his Steam-engine.

from the lower part of B has free admission into the upper part of A; but the upper part of each cylinder has no communication with its lower part.

From the bottom of the great cylinder proceeds the eduction-pipe K, having a valve at its opening into the cylinder, which bends downwards, and is connected with the conical condenser L (C). The condenser is fixed on a hollow box M, on which stand the pumps N and O for extracting the air and water; which lead runs along the trough T into a cistern U, from which it is raised by the pump V for recirculating the boiler, being already nearly boiling hot. Immediately under the condenser there is a spigot valve at S, over which is a small jet pipe, reaching to the bend of the eduction-pipe. The whole of the condensing apparatus is contained in a cistern R of cold water. A small pipe P comes from the side of the condenser, and terminates on the bottom of the trough T, and is there covered with a valve Q, which is kept tight by the water that is always running over it. Lastly, the pump-rods X cause the outer end of the beam to preponderate, so that the quiescent position of the beam is that represented in the figure, the pistons being at the top of the cylinders.

Suppose all the cocks open, and steam coming in copiously from the boiler, and no condensation going on in L; the steam must drive out all the air, and at last follow it through the valve Q. Now shut the valves *b* and *d*, and open the valve S of the condenser. The condensation will immediately commence. There is now no pressure on the under side of the piston of A, and it immediately descends. The communication between the lower part of B and the upper part of A being open, the steam will go from B into the space left by the piston of A. It must therefore expand, and its elasticity must diminish, and will no longer balance the pressure of the steam above the piston of B. This piston therefore, if not withheld by the beam, would descend till it is in equilibrium, having steam of equal density above and below it. But it cannot descend so far; for the cylinder A is wider than B, and the arm of the beam at which its piston hangs is longer than the arm which supports the piston of B: therefore when the piston of B has descended as far as the beam will permit it, the steam between the two pistons occupies a larger space than it did when both pistons were at the tops of their cylinders. Its density, therefore, and its elasticity, diminish as its bulk increases. It is therefore not a balance; for the steam on the upper side of B, and the piston B, pulls at the beam with all the difference of these pressures. The slightest view of the subject must show the reader, that as the pistons descend, the steam that is between them will grow continually rarer and less elastic, and that both pistons will pull the beam downwards.

Suppose now that each has reached the bottom of its cylinder. Shut the cock *a* and the eduction cock at the bottom of A, and open the cocks *b* and *d*. The communication being now established between the upper and lower part of each cylinder, nothing hinders the counter weight from raising the pistons to the top. Let

them arrive there. The cylinder B is at this time filled with steam of the ordinary density, and the cylinder A with an equal absolute quantity of steam, but expanded into a larger space.

Shut the cocks *b* and *d*, and open the cock *a*, and the eduction cock at the bottom of A; the condensation will again operate, and the pistons descend. And thus the operation may be repeated as long as steam is supplied; and one full of the cylinder B of ordinary steam is expended during each working stroke.

Let us now examine the power of this engine. It is evident, that when both pistons are at the top of their respective cylinders, the active pressure (that is, the difference of the pressure on its two sides) on the piston of B is nothing, while that on the piston of A is equal to the full pressure of the atmosphere on its area. This, multiplied by the length of the arm by which it is supported, gives its mechanical energy. As the pistons descend, the pressure on the piston of B increases, while that on the piston of A diminishes. When both are at the bottom, the pressure on the piston of B is at its maximum, and that on the piston of A at its minimum.

Mr Hornblower saw that this must be a beneficial employment of steam, and preferable to the practice of condensing it while its full elasticity remained; but he has not considered it with the attention necessary for ascertaining the advantage with precision.

Let *a* and *b* represent the areas of the pistons of A and B, and let *α* and *β* be the lengths of the arms by which they are supported. It is evident, that when both pistons have arrived at the bottoms of their cylinders, the capacities of the cylinders are as *aα* and *bβ*. Let this be the ratio of *m* to 1. Let *ghik* (fig. 16.) and *lmno* be two cylinders of equal length, communicating with each other, and fitted with a piston-rod *pq*, on which are fixed two pistons *aa* and *bb*, whose areas are as *m* and 1. Let the distance between the pistons be precisely equal to the height of each cylinder, which height we shall call *h*. Let *x* be the space *gb* or *ba*, through which the pistons have descended. Let the upper cylinder communicate with the boiler, and the lower cylinder with the condenser or vacuum V.

Any person in the least conversant in mechanics and pneumatics will clearly see that the strain or pressure on the piston-rod *pq* is precisely the same with the united energies of the two piston rods of Mr Hornblower's engine, by which they tend to turn the working beam round its axis.

The state of the upper cylinder being 1, and its height *h*, its capacity or bulk is *1 h* or *h*; and this expresses the natural bulk of the steam which formerly filled it, and is now expanded into the space *b h l a a m i b*. The part *b h i b* is plainly $= h - x$, and the part *l a a m* is $= m x$. The whole space therefore is $m x + h - x$, $= h + m x - x$, or $h + m - 1 x$. Therefore the density of the steam between the pistons is $\frac{h}{h + m - 1 x}$.

Let *p* be the downward pressure of the steam from the

* (C) This, however, was stopped by Watt's patent; and the condensation must be performed as in Newcomen's engine, or at least in the cylinder A.

Steam-Engine.

the boiler on the upper piston *b b*. This piston is also pressed up with a force $= \rho \frac{h}{h+m-1x}$ by the steam between the pistons. It is therefore, on the whole, pressed downward with a force $= \rho \left(1 - \frac{h}{h+m-1x} \right)$. The lower piston *a a*, having a vacuum below it, is pressed downwards with a force $= \rho \frac{m h}{h+m-1x}$. Therefore the whole pressure on the piston rod downwards is $= \rho \left(1 + \frac{m h}{h+m-1x} - \frac{h}{h+m-1x} \right) = \rho \left(1 + \frac{m-1 h}{h+m-1x} \right) = \rho + \frac{\rho h}{h+m-1x}$.

This then is the momentary pressure on the piston rod corresponding to its descent *x* from its highest position. When the pistons are in their highest position, this pressure is equal to *m*ρ. When they are in their lowest position, it is $= \rho \frac{2m-1}{m}$. Here therefore is an accession of power. In the beginning the pressure is greater than on a single piston in the proportion of *m* to 1; and at the end of the stroke, where the pressure is weakest, it is still much greater than the pressure on a single piston. Thus, if *m* be 4, the pressure at the beginning of the stroke is 4ρ, and at the end it is $\frac{7}{4}\rho$, almost double, and in all intermediate positions it is greater. It is worth while to obtain the sum total of all the accumulated pressures, that we may compare it with the constant pressure on a single piston.

We may do this by considering the momentary pressure $\rho + \frac{\rho h}{h+m-1x}$, as equal to the ordinate GF, H*b*,

or M*c*, of a curve F*b c* (fig. 15.), which has for its axis the line GM equal to *h* the height of our cylinder. Call this ordinate *y*. We have $y = \rho + \frac{\rho h}{h+m-1x}$, and $y - \rho = \frac{\rho h}{h+m-1x}$. Now it is plain that

$\frac{\rho h}{h+m-1x}$ is the ordinate of an equilateral hyperbola,

of which ρh is the power or rectangle of the ordinate and absciss, and of which the absciss reckoned from the centre is $\frac{h}{m-1} + x$. Therefore make GE = ρ*h*, and draw DEA parallel to MG, and make EA = $\frac{GM}{m-1}$, = $\frac{h}{m-1}$. The curve F*b c* is an equilateral hyperbola,

having A for its centre and AD for its asymptote. Draw the other asymptote AB, and its ordinate FB. Since the power of the hyperbola is $= \rho h = GEDM$ (for GE = ρ*h*, and GM = *h*); and since all the inscribed rectangles, such as AEF*b*, are equal to ρ*h*, it follows that AEF*b* is equal to GEDM, and that the area ABF*c*DA is equal to the area GF*c*MG, which

expresses the accumulated pressure in Hornblower's engine.

We can now compute the accumulated pressure very easily. It is evidently $= \rho h \times \left(1 + L \frac{AD}{AE} \right)$.

The intelligent reader cannot but observe that this is precisely the same with the accumulated pressure of a quantity of steam admitted in the beginning, and stopped in Mr Watt's method, when the piston has condensed through the *m*th part of the cylinder. In considering Mr Hornblower's engine, the thing was presented in so different a form that we did not perceive the analogy at first, and we were surprised at the result. We could not help even regretting it, because it had the appearance of a new principle and an improvement; and we doubt not but that it appeared so to the ingenious author; for we have had such proofs of his liberality of mind as permit us not to suppose that he saw it from the beginning, and availed himself of the difficulty of tracing the analogy. And as the thing may mislead others in the same way, we have done a service to the public by showing that this engine, so costly and so difficult in its construction, is no way superior in power to Mr Watt's simple method of stopping the steam. It is even inferior, because there must be a condensation in the communicating passages. We may add, that if the condensation is performed in the cylinder A, which it must be unless with the permission of Watt and Boulton, the engine cannot be much superior to a common engine; for much of the steam from below B will be condensed between the pistons by the coldness of the cylinder A; and this diminishes the downward pressure on A more than it increases the downward pressure on B. We learn however that, by confining the condensation to a small part of the cylinder A, Mr Hornblower has erected engines clear of Mr Watt's patent, which are considerably superior to Newcomen's; so has Mr Symington.

We said that there was much ingenuity and real skill observable in many particulars of this engine. The disposition and connection of the cylinders, and the whole condensing apparatus, are contrived with peculiar neatness. The cocks are very ingenious; they are composed of two flat circular plates ground very true to each other, and one of them turns round on a pin through their centres; each is pierced with three sectoral apertures, exactly corresponding with each other, and occupying a little less than one-half of their surfaces. By turning the moveable plate so that the apertures coincide, a large passage is opened for the steam; and by turning it so that the solid of the one covers the aperture of the other, the cock is shut. Such regulators are now very common in the cast iron stoves for warming rooms.

Mr Hornblower's contrivance for making the collars for the piston rods air-tight is also uncommonly ingenious. This collar is in fact two, at a small distance from each other. A small pipe, branching off from the main steam-pipe, communicates with the space between the collars. This steam, being a little stronger than the pressure of the atmosphere, effectually hinders the air from penetrating by the upper collar; and though a little steam should get through the lower collar into the cylinder A, it can do no harm. We see many cases in which this pretty contrivance may be of signal service.

Steam-Engine.

52
The ac-
multi-
of
the flame
with that
of Mr
Watt's en-
gines.

81
Still, how-
ever, the
engine dis-
covers in-
genuity
and skill.

Steam-Engine.

84
The great improvement is the framing of the working beam.

But it is in the framing of the great working beam that Mr Hornblower's scientific knowledge is most conspicuous; and we have no hesitation in affirming that it is stronger than a beam of the common form, and containing twenty times its quantity of timber. There is hardly a part of it exposed to a transverse strain, if we except the strain of the pump V on the strut by which it is worked. Every piece is either pushed or pulled in the direction of its length. We only fear that the bolts which connect the upper beam with the two iron bars under its ends will work loose in their holes, and tear out the wood which lies between them. We would propose to substitute an iron bar for the whole of this upper beam. This working beam highly deserves the attention of all carpenters and engineers. We have that opinion of Mr Hornblower's knowledge and talents, that we are confident that he will see the fairness of our examination of his engine, and we trust to his candour for an excuse for our criticism.

85
The reciprocating motion of the steam-engine is a defect still to be remedied.

The reciprocating motion of the steam-engine has always been considered as a great defect; for though it be now obviated by connecting it with a fly, yet, unless it is an engine of double stroke, this fly must be an enormous mass of matter moving with great velocity. Any accident happening to it would produce dreadful effects: A part of the rim detaching itself would have the force of a bomb, and no building could withstand it. Many attempts have been made to produce a circular motion at once by the steam. It has been made to blow on the vanes of a wheel of various forms. But the rarity of steam is such, that even if none is condensed by the cold of the vane, the impulse is exceedingly feeble, and the expence of steam, so as to produce any serviceable impulse, is enormous. Mr Watt, among his first speculations on the steam engine, made some attempts of this kind. One in particular was uncommonly ingenious. It consisted of a drum turning air-tight within another, with cavities so disposed that there was a constant and great pressure urging it in one direction. But no packing of the common kind could preserve it air-tight with sufficient mobility. He succeeded by immersing it in mercury, or in an amalgam which remained fluid in the heat of boiling water; but the continual tribration soon calcined the fluid and rendered it useless. He then tried Parent's or Dr Barker's mill, inclosing the arms in a metal drum, which was immersed in cold water. The steam rushed rapidly along the pipe which was the axis, and it was hoped that a great reaction would have been exerted at the ends of the arms; but it was almost nothing. The reason seems to be, that the greatest part of the steam was condensed in the cold arms. It was then tried in a drum kept boiling hot; but the impulse was now very small in comparison with the expence of steam. This must be the case.

Mr Watt has described in his specification to the patent (see some contrivances for producing a circular motion by the immediate action of the steam. Some of these produce alternate motions, and are perfectly analogous to his double-stroke engine. Others produce a continued motion. But he has not given such a description of his valves for this purpose as can enable an engineer to construct one of them. From any guess that we can form, we think the machine very imperfect; and we do not find that Mr Watt has ever erected a

continuous circular engine. He has doubtless found all his attempts inferior to the reciprocating engine with a fly. A very crude scheme of this kind may be seen in the Transactions of the Royal Society of Dublin 1787. But although our attempts have hitherto failed, we hope that the case is not yet desperate: we see different principles which have not yet been employed.

We shall conclude our account of this noble engine with observing, that Mr Watt's form forgets the construction of an excellent air-pump. A large vessel may be made to communicate with a boiler at one side, and with the pump-receiver on the other, and also with a condenser. Suppose this vessel of ten times the capacity of the receiver; fill it with steam from the boiler, and drive out the air from it; then open its communication with the receiver and the condenser. This will rarely the air of the receiver ten times. Repeating the operation will rarely it 100 times; the third operation will rarely it 1000 times; the fourth 10,000 times, &c. All this may be done in half a minute.

STEAM Kitchen. Ever since Dr Papin contrived his digester (about the year 1699), schemes have been proposed for dressing victuals by the steam of boiling water. A philosophical club used to dine at Saltero's coffee-house, Chelsea, about 40 years ago, and had their victuals dressed by hanging them in the boiler of the steam-engine which raises water for the supply of Piccadilly and its neighbourhood. They were completely dressed, and both expeditiously and with high flavour.

A patent was obtained for an apparatus for this purpose by a tin-man in London; we think of the name of Tate. They were afterwards made on a much more effective plan by Mr Gregory, an ingenious tradesman in Edinburgh, and are coming into very general use.

It is well known to the philosopher that the steam of boiling water contains a prodigious quantity of heat, which it retains in a latent state ready to be faithfully accounted for, and communicated to any colder body. Every cook knows the great scalding power of steam, and is disposed to think that it is much hotter than boiling water. This, however, is a mistake; for it will raise the thermometer no higher than the water from which it comes. But we can assure the cook, that if he make the steam from the spout of a tea-kettle pass through a great body of cold water, it will be condensed or changed into water; and when one pound of water has in this manner been boiled off, it will have heated the mass of cold water as much as if we had thrown into it seven or eight hundred pounds of boiling hot water.

If, therefore, a boiler be properly fitted up in a furnace, and if the steam of the water boiling in it be conveyed by a pipe into a pan containing victuals to be dressed, every thing can be cooked that requires no higher degree of heat than that of boiling water: And this will be done without any risk of scorching, or any kind of overheating, which frequently spoils our dishes, and proceeds from the burning heat of air coming to those parts of the pot or pan which is not filled with liquor, and is covered only with a film, which quickly burns and taints the whole dish. Nor will the cook be scorched by the great heat of the open fire that is necessary for dressing at once a number of dishes, nor have his person and clothes soiled by the smoke and soot unavoidable in the cooking on an open fire. Indeed the whole

Steam-Engine.

Steam-Kitchen.

87

Still the case is not desperate, or different principles may be employed.

88

Mr Watt's engine suggests the construction of an excellent air pump.

89

Mr Watt's engine suggests the construction of an excellent air pump.

90

Mr Watt's engine suggests the construction of an excellent air pump.

91

Mr Watt's engine suggests the construction of an excellent air pump.

92

Mr Watt's engine suggests the construction of an excellent air pump.

93

Mr Watt's engine suggests the construction of an excellent air pump.

94

Mr Watt's engine suggests the construction of an excellent air pump.

95

Mr Watt's engine suggests the construction of an excellent air pump.

96

Mr Watt's engine suggests the construction of an excellent air pump.

97

Mr Watt's engine suggests the construction of an excellent air pump.

98

Mr Watt's engine suggests the construction of an excellent air pump.

99

Mr Watt's engine suggests the construction of an excellent air pump.

100

Mr Watt's engine suggests the construction of an excellent air pump.

101

Mr Watt's engine suggests the construction of an excellent air pump.

102

Mr Watt's engine suggests the construction of an excellent air pump.

Steam-Kitchen.

whole process is so neat, so manageable, so open to inspection, and so clearly, that it need neither fatigue nor offend the delicacy of the nicest lady.

We had great doubts, when we first heard of this as a general mode of cookery, as to its economy: we had none as to its efficacy. We thought that the steam, and consequently the fuel expended, must be vastly greater than by the immediate use of an open fire; but we have seen a large tavern dinner expeditiously dressed in this manner, seemingly with much less fuel than in the common method. The following simple narration of facts will shew the superiority. In a paper manufactory in this neighbourhood, the vats containing the pulp into which the frames are dipped are about six feet diameter, and contain above 200 gallons. This is brought to a proper heat by means of a small cockle or furnace in the middle of the liquor. This is heated by putting in about one hundred weight of coals about eight o'clock in the evening, and continuing this till four next morning, renewing the fuel as it burns away. This method was lately changed for a steam heater. A furnace, having a boiler of five or six feet diameter and three feet deep, is heated about one o'clock in the morning with two hundred weight of coals, and the water kept in brisk ebullition. Pipes go off from this boiler to six vats, some of which are at 90 feet distance. It is conveyed into a flat box or vessel in the midst of the pulp, where it condenses, imparting its heat to the sides of the box, and thus heats the surrounding pulp. These six vats are as completely heated in three hours, expending about three hundred weight of coals, as they were formerly in eight hours, expending near eighteen hundred weight of coals. Mr Gregory, the inventor of this steam-heater, has obtained (in company with Mr Scott, plumber, Edinburgh) a patent for the invention; and we are persuaded that it will come into very general use for many similar purposes. The dyers, hatmakers, and many other manufacturers, have occasion for large vats kept in a continual heat; and there seems no way so effectual.

I indeed when we reflect seriously on the subject, we see that this method has immense advantages considered merely as a mode of applying heat. The steam may be applied to the vessel containing the victuals in every part of its surface: it may even be made to enter the vessel, and apply itself immediately to the piece of meat that is to be dressed, and this without any risk of scorching or overdoing.—And it will give out about $\frac{2}{3}$ of the heat which it contains, and will do this only if it be wanted; so that no heat whatever is wasted except what is required for heating the apparatus. Experience shows that this is a mere trifle in comparison of what was supposed necessary. But with an open fire we only apply the flame and hot air to the bottom and part of the sides of our boiling vessels: and this application is hurried in the extreme; for to make a great heat, we must have a great fire, which requires a prodigious and most rapid current of air. This air touches our pans but for a moment, imparts to them but a small portion of its heat; and we are persuaded that three-fourths of the heat is carried up the chimney, and escapes in pure waste, while another great portion beams out into the kitchen to the great annoyance of the scorched cook. We think, therefore, that a page or two of this work

Steam-Kitchen.

will not be thrown away in the description of a contrivance by which a firing may be made to the entertainer, and the providing the pleasures of his table prove a less fatiguing task to this valuable corps of practical chemists.

Let A (fig. 1.) represent a kitchen-boiler, either properly fitted up in a furnace, with its proper fire-place, ash-pit, and flue, or fit on a tripod on the open fire, or built up in the general fire-place. The steam-pipe BC rises from the cover of this boiler, and then is led away with a gentle ascent in any convenient direction. C represents the section of this conducting steam-pipe. Branches are taken off from the side at proper distances. One of these is represented at CDE, furnished with a cock D, and having a taper nozzle E, fitted by grinding into a conical piece F, which communicates with an upright pipe GH, which is soldered to the side of the steaming vessel PQRS, communicating with it by the short pipe I. The vessel is fitted with a cover OT, having a staple handle V. The piece of meat M is laid on a tin-plate gask KL, pierced with holes like a cullender, and standing on three short feet *nnn*.

The steam from the boiler comes in by the pipe J, and is condensed by the meat and by the sides of the vessel, communicating to them all its heat. What is not so condensed escapes between the vessel and its cover. The condensed water lies on the bottom of the vessel, mixed with a very small quantity of gravy and fatty matter from the victuals. Frequently, instead of a cover, another stew-vessel with a cullender bottom is set on this one, the bottom of the one fitting the mouth of the other: and it is observed, that when this is done, the dish in the under vessel is more expeditiously and better dressed, and the upper dish is more slowly, but as completely stewed.

This description of one steaming vessel may serve to give a notion of the whole; only we must observe, that when broths, soups, and dishes with made sauces or containing liquids, are to be dressed, they must be put into a smaller vessel, which is set into the vessel PQRS, and is supported on three short feet, so that there may be a space all round it of about an inch or three quarters of an inch. It is observed, that dishes of this kind are not so expeditiously cooked as on an open fire, but as completely in the end, only requiring to be turned up now and then to mix the ingredients; because as the liquids in the inner vessel can never come into ebullition, unless the steam from the boiler be made of a dangerous heat, and every thing be close confined, there cannot be any of that tumbling motion that we observe in a boiling pot.

The performance of this apparatus is far beyond any expectation we had formed of it. In one which we examined, six pans were itwung together by means of a boiler 10 $\frac{1}{2}$ inches in diameter, standing on a brisk open fire. It boiled very briskly, and the steam pushed frequently through the chinks between the stew-pans and their covers. In one of them was a piece of meat considerably above 30 pounds weight. This required above four hours stewing, and was then very thoroughly and equally cooked; the outside being no more done than the heart, and it was near two pounds heavier than when put in, and greatly swelled. In the mean time, several dishes had been dressed in the other pans. As far

Plate
DV.
FIG. 1.

Steam-Kitchen.

far as we could judge, this cooking did not consume one-third part of the fuel which an open fire would have required for the same effect.

When we consider this apparatus with a little more knowledge of the mode of operation of fire than falls to the share of the cooks (we speak with deference), and consider the very injudicious manner in which the steam is applied, we think that it may be improved so as to surpass any thing that the cook can have a notion of.

When the steam enters the stew-pan, it is condensed on the meat and on the vessel; but we do not want it to be condensed on the vessel. And the surface of the vessel is much greater than that of the meat, and continues much colder; for the meat grows hot, and continues so, while the vessel, made of metal, which is a very perfect conductor of heat, is continually robbed of its heat by the air of the kitchen, and carried off by it. If the meat touch the side of the pan in any part, no steam can be applied to that part of the meat, while it is continually imparting heat to the air by the intermedium of the vessel. Nay, the meat can hardly be dressed unless there be a current of steam through it; and we think this confirmed by what is observed above, that when another stew-pan is set over the first, and thus gives occasion to a current of steam through its cullender bottom to be condensed by its sides and contents, the lower dish is more expeditiously dressed. We imagine, therefore, that not less than half of the steam is wasted on the sides of the different stew-pans. Our first attention is therefore called to this circumstance, and we wish to apply the steam more economically and effectually.

We would therefore construct the steam-kitchen in the following manner:

Fig. 2.

We would make a wooden chest (which we shall call the STEW-CHEST) ABCD (fig. 2.). This should be made of deal, in very narrow slips, not exceeding an inch, that it may not shrink. This should be lined with very thin copper, lead, or even strong tinfoil. This will prevent it from becoming a conductor of heat by foaking with steam. For further security it might be set in another chest, with a space of an inch or two all round, and this space filled with a composition of powdered charcoal and clay. This should be made by first making a mixture of fine potter's clay and water about as thick as poor cream: then as much powdered charcoal must be beat up with this as can be made to stick together. When this is rammed in and dry, it may be hot enough on one side to melt glass, and will not discolour white paper on the other.

This chest must have a cover LMNO, also of wood, having holes in it to receive the stew-pans P, Q, R. Between each pan is a wooden partition, covered on both sides with milked lead or tinfoil. The whole top must be covered with very spongy leather or felt, and made very flat. Each stew-pan must have a bearing or shoulder all round it, by which it is supported, resting on the felt, and lying so true and close that no steam can escape. Some of the pans should be simple, like the pan F, for dressing broths and other liquid dishes. Others should be like E and G, having in the bottom a pretty wide hole H, K, which has a pipe in its upper side, rising about an inch or an inch and half into the stew-pan. The meat is laid on a cullender plate, as in

Steam-Kitchen.

the common way; only there must be no holes in the cullender immediately above the pipe.—These stew-pans must be fitted with covers, or they may have others fitted to their mouths, for warming sauces or other dishes, or stewing greens, and many other subordinate purposes for which they may be fitted.

The main-pipe from the boiler must have branches, (each furnished with a cock), which admit the steam into these divisions. At its first entry some will be condensed on the bottom and sides; but we imagine that there will in two minutes be heated so as to condense no more, or almost nothing. The steam will also quickly condense on the stew-pan, and in half a minute make it boiling hot, so that it will condense no more; all the rest will now apply itself to the meat and to the cover. It may perhaps be advisable to allow the cover to condense steam, and even to waste it. This may be promoted by laying on it flannel soaked in water. Our view in this is to create a demand for steam, and thus produce a current through the stew-pan, which will be applied in its passage to the victuals. But we are not certain of the necessity of this. Steam is not like common air of the same temperature, which would glide along the surfaces of bodies, and impart to them a small portion of its heat, and escape with the rest. To produce this effect there *must* be a current; for air hot enough to melt lead, will not boil water, if it be kept stagnant round the vessel. But steam imparts the *whole* of its latent heat to any body colder than boiling water, and goes no farther till this body be made boiling hot. It is a most faithful carrier of heat, and will deliver its whole charge to any body that can take it. Therefore, although there were no partitions in the stew-chest, and the steam were admitted at the end next the boiler, if the pan at the farther end be colder than the rest, it will all go thither; and will, in short, communicate to every thing impartially according to the demand. If any person has not the confidence in the steam which we express, he may still be certain that there must be a prodigious saving of heat by confining the whole in the stew-chest; and he may make the pans with entire bottoms, and admit the steam into them in the common way, by pipes which come through the sides of the chest and then go into the pan. There will be none lost by condensation on the sides of the chest; and the pans will soon be heated up to the boiling temperature; and hardly any of their heat will be wasted, because the air in the chest will be stagnant. The chief reason for recommending our method is the much greater ease with which the stew-pans can be shifted and cleaned. There will be little difference in the performance.

Nay, even the common steam-kitchen may be prodigiously improved by merely wrapping each pan in three or four folds of coarse dry flannel, or making flannel bags of three or four folds fitted to their shape, which can be put on or removed in a minute. It will also greatly conduce to the good performance to wrap the main steam pipe in the same manner in flannel.

We said that this main-pipe is conducted from the boiler with a gentle ascent. The intention of this is, that the water produced by the unavoidable condensation of the steam may run back into the boiler. But the rapid motion of the steam generally sweeps it up hill, and it runs into the branch-pipes and descends into the stew-pans. Perhaps it would be as well to give the

main-

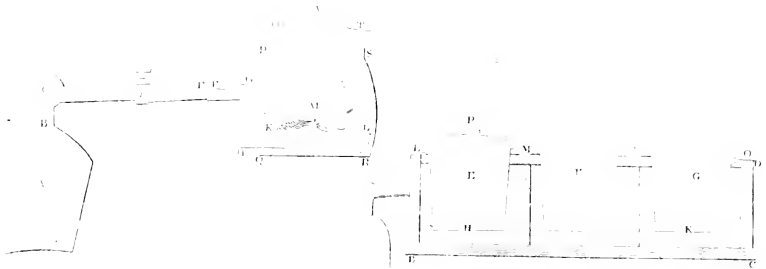

ROOMS heated by STEAM.

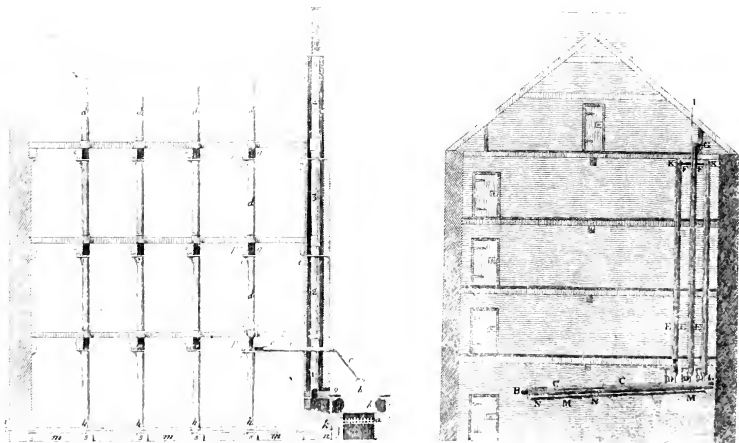



Steam-Kitchen.

main-pipe a declivity the other way, and allow all the water to collect in a hot well at the farther end, by means of a descending pipe, having a loaded valve at the end. This may be so contrived as to be closed by the fire, where it would be too warm that it would not check the boiling if again poured into the boiler. But the utmost attention must be paid to cleanliness in the whole of this passage, because this water is boiled again, and its steam passes through the heart of every diih. This circumstance forbids us to return into the boiler what is condensed in the steam-pans. This would mix the tastes and flavours of every diih, and be very disagreeable. All this must remain in the bottom of each steam-pan: for which reason we put in the pipe rising up in the middle of the bottom. It might indeed be allowed to fall down into the steam-chest, and to be collected in a common receptacle, while the fat would float at top, and the clear gravy be obtained below, perhaps fit for many uses.

The completest method for getting rid of this condensed steam would be to have a small pipe running along the under side of the main conductor, and communicating with it at different places, in a manner similar to the air discharger on the mains of water-pipes. In the paper manufactory mentioned above, each steam-box has a pipe in its bottom, with a stop-cock, by which the water is discharged; and the main pipe being of great diameter, and laid with a proper declivity, the water runs back into the boiler.

But these precautions are of little moment in a steam-kitchen even for a great table; and for the general use of private families, would hurt the apparatus, by making it complex and of nice management. For a small family, the whole apparatus may be set on a table four feet long and two broad, which may be placed on casters, so as to be wheeled out of the way when not in use. If the main conductor be made of wood, or properly cased in flannel, it will condense so little steam that the cooking table may stand in the remotest corner of the kitchen without sensibly impairing its performance; and if the boiler be properly set up in a small furnace, and the flue made so that the flame may be applied to a great part of its surface, we are persuaded that three-fourths of the fuel used in common cookery will be saved. Its only inconvenience seems to be the indispensable necessity of the most anxious cleanliness in the whole apparatus. The most trifling neglect in this will destroy a whole dinner.

We had almost forgotten to observe, that the boiler must be furnished with a funnel for supplying it with water. This should pass through the top, and its pipe reach near to the bottom. It will be proper to have a cock on this funnel. There should also be another pipe in the top of the boiler, having a valve on the top. If this be loaded with a pound on every square inch, and the fire so regulated that steam may be observed to puff sometimes from this valve, we may be certain that it is passing through our dishes with sufficient rapidity; and if we that the cock on the funnel, and load the valve a little more, we shall cause the steam to blow at the covers of the steam-pans. If one of these be made very tight, and have a hole also furnished with a loaded valve, this pan becomes a digester, and will dissolve bones, and do many things which are impracticable in the ordinary cookery.

Vol. XIX. Part II.

STEAM applied to Heating Rooms. Steam has been successfully applied as a substitute for open fires in heating manufactories, and proves to be highly beneficial, not only in point of economy in saving fuel, but also in lessening the danger of accidental fire. The following mode of heating a cotton mill by steam was proposed and practised in 1799 by Mr. Niel Snodgrass of Paisley. We shall give an account of it in his own words.

"Fig. 1. presents a view of an inner gable, which is at one extremity of the preparation and spinning rooms of the mill. On the other side of this gable there is a space of 17 feet, enclosed by an outer gable, and containing the water-wheel, the hair-cake, and small rooms for the accommodation of the work. In this space the furnace and boiler are placed on the ground. The boiler cannot be shown here, as it lies behind the gable exhibited; nor is it of any consequence, as there is nothing peculiar in it. It may be of any convenient form. The feeding apparatus, &c. are in every respect the same as in the boiler of a common steam-engine. A circular copper boiler, two feet diameter by two feet deep, containing 30 gallons of water, with a large copper head as a reservoir for the steam, was found to answer in the present instance. The steam is conveyed from the boiler through the gable, by the copper pipe B, into the tin pipe, C, C. From C it passes into the centres of the perpendicular pipes F, E, E, by the small bent copper tubes D, D, D. The pipes E, E, E, are connected under the garret floor by the tubes F, F, for the more easy circulation of the steam. The middle pipe, E, is carried through the garret floor, and communicates with a lying pipe, 36 feet in length (the end of which is seen at G), for heating the garret. At the further extremity of the pipe G, there is a valve falling inwards to prevent a vacuum being formed on the cooling of the apparatus; the consequence of which would be the crouching of the pipes by the pressure of the atmosphere. Similar valves K, K, are placed near the top of the perpendicular pipes, E, E; and from the middle one E, the small pipe passes through the roof, and is furnished with a valve at I, opening outwards, to suffer the air to escape while the pipes are filling with steam, or the steam itself to escape when the charge is too high.

"The water condensed in the perpendicular pipes E, E, E, trickles down their sides into the three funnels L, L, L, the necks of which may either pass through or round the pipe C, into the copper tube M, M, which also receives the water condensed in C, C, by means of the short tubes N, N. The pipe C, C, is itself so much inclined as to cause the water to run along it to the tubes N, N, and the pipe G in the garret has an inclination of 18 inches in its length, to bring the water condensed in it back to the middle pipe E. The tube M, M, carries back the water through the gable to the boiler, which stands five feet lower than this tube. It is material to return the water to the boiler, as, being nearly at a boiling heat, a considerable expense of fuel is thereby saved.

"The large pipes are ten inches in diameter, and are made of the second kind of tinued iron plates. The dimensions of the smaller tubes may be seen by their comparative size in the engraving, and perhaps they might be varied without inconvenience.

"The apparatus erected as here described, has been found sufficiently strong, and has required no material

74
Plate
DV.
Fig. 1.

the face the first alterations were made. The leading object in the instance under consideration being to save fuel, in order to derive as much heat as possible from a given quantity of fuel, the flue from the furnace, which heats the boiler, is conveyed into common stone pipes placed in the gable. These are erected so as to prevent any danger of fire, in the manner shown in the engraving, fig. 2. The steam with this auxiliary communicates a heat of about 70° to the mill, the rooms of which are 52 feet long, 32 $\frac{1}{2}$ feet wide, and 8 $\frac{1}{2}$ feet high, except the lower story and garret; the former of which is 11, and the latter seven feet high. The rooms warmed in this manner are much more wholesome and agreeable than those heated by the best constructed stoves, being perfectly free from vapour or contaminated air.

"The application of the principle to buildings already constructed, it is presumed, will be sufficiently obvious from the foregoing details. In new manufactories, where the mode of heating may be made a part of the original plan, a more convenient apparatus may be introduced. This will be best explained by a description of fig. 2, which gives a section of a cotton-mill constructed so as to apply the steam apparatus to a new building.

"The furnace for the boiler is shown at *a* (fig. 2). The flue of the furnace conveys the smoke into the cast iron stove pipes, 1, 2, 3, 4. These pipes are placed in a space in the gable, entirely enclosed with brick, except at the small apertures, 5, 6, 7, 8. A current of air is admitted below at 9, and thrown into the rooms by those openings, after being heated by contact with the pipes. This part of the plan is adopted with a view to prevent, as much as possible, any of the heat, produced by the fuel used, from being thrown away. It may be omitted where any danger of fire is apprehended from it, and the smoke may be carried off in any way that is considered absolutely secure. So far, however, as appears from experience, there seems to be little or no danger of fire from a stove of this construction. The greatest inconvenience of a common stove is, that the cockle or metal furnace is liable to crack from the intensity of the heat. By the continuity of the metal from the fireplace, no intense heat is also conducted along the pipes, which exposes them to the same accident. Here the smoke being previously conveyed through a brick flue, can never communicate to the pipes a degree of heat sufficient to crack them. In like manner the pipes, having no communication with the rooms but by the small apertures, cannot come in contact with any combustible substance, and from being surrounded with air, which is constantly changing, can impart only a very moderate degree of heat to the walls. The iron supporters of the pipes may be imbedded in some substance which is a bad conductor of heat, as furnace-tiles and lime, &c. The emission of heated air into the rooms may be regulated by valves. As the pipes are not exposed to cracking, there is no risk of their throwing smoke or vapour into the rooms.

"The boiler *h, h, h*, is six feet long, three and a half feet high, and three feet deep. As there is nothing peculiar in the boiler apparatus, it is omitted. The boiler may be placed in any convenient situation. Where a steam engine is used for other purposes, the steam may be taken from the boiler. The pipe *c, c*, conveys the steam from the boiler to the six perpendicular pipe

d, d, d, d. There is an expanding joint at *e*, stuffed, to make it steam-tight. The steam ascending in the first pipe *d, d, d*, enters the horizontal pipe *f, f, f, f*, (which is slightly inclined) expelling the air, which partly escapes by the valve *g*, and is partly forced into the other pipes. The valve *g* being considerably loaded, forces the accumulating steam down into the rest of the pipes *d, d, d*. The air in these pipes recedes before the steam, and is forced through the tubes *h, h, h*, into the pipe *m, m, m*, whence it escapes at the valve *i*, and the typhon *k*. The water, condensed in the whole of the pipes, passes into the tubes *l, l, l, l*, into the pipe *m, m, m*, which has such a declivity as to discharge the water at the typhon *l*, into the hot well *n*, whence it is pumped back into the boiler.

"The whole of the pipes are of cast iron, except *m, m, m*, which is of copper. The perpendicular pipes serve as pillars for supporting the beams of the hoyle, by means of the projecting pieces *o, o, o*, which may be raised or lowered at pleasure by the wedges *p, p, p*. The pipes are sunk in the beams about an inch, and are made fast to them by the iron straps *q, q*. These in the lower story rest on the stones *s, s, s, s*, and are made tight at the junction with fluting. The pipe in each story supports the one in the story above by a fluted joint as shown at *r*. The pipes in the lower story are seven inches in diameter; those in the higher six inches; those in the other two are of intermediate diameters. The thickness of the metal is three-eighths of an inch. The lower pipes are made larger than the upper, in order to expose a greater heated surface in the lower rooms, because the steam being thrown from above into all the pipes, except the first, would otherwise become incapable of imparting an equal heat as it descends. There is no necessity for valves opening inwards in this apparatus, the pipes being strong enough to resist the pressure of the atmosphere.

"The cotton mill is 65 feet long, 33 wide, and four stories high, the upper being a garret story. In the engraving, five parts out of nine in the length of the building are only shown. The apparatus will heat the rooms to 85° in the coldest season. It is evident that, by increasing the size, or the number of the pipes, and the supply of steam, any degree of heat up to 212° may be easily produced. It may even be carried beyond that point by an apparatus strong enough to compress the steam: this, however, can seldom be wanted. At first it was objected to this construction, that the expansion of the pipes, when heated, might damage the building; but experience has proved, that the expansion occasioned by the heat of steam is quite insensible."

Steam has also been advantageously employed in drying maulin goods, when the state of the weather interrupts this process out of doors. This application of steam, we understand, was the invention of an ingenious mechanic in Paisley, who never derived the smallest benefit from the discovery. It was adopted immediately by some bleachers in the neighbourhood, and has now come into very general use. The steam is introduced into cylinders of tin plate, and the goods to be dried are wrapped round the cylinders which communicate to them a heat equal at least to the temperature of boiling water, and in this way the process of drying is expeditiously accomplished.

SIENITES or *S. sparactis*, a species of mineral belonging

ted in all propositions of dilance, in the manner of Archimedes, at once the most simple, perspicuous, and elegant of all.

We cannot help observing, that all this difficulty (and it is a real one to the philosopher who aims at rendering mechanics a demonstrative science) has arisen from an improper search after simplicity. Had Archimedes taken a lever as it really exists in nature, and considered it as *materia*, consisting of atoms united by cohesion; and had he traced the intermediate pressures by whose means the two external weights are put in opposition to each other, or rather to the support given to the fulcrum; all difficulty would have vanished. (See what is said on this subject in the article *STRENGTH of Timber*, &c.)

The quantity of goods which may be weighed by this instrument depends on the weight of the counterpoise, and on the dilance CD from the fulcrum at which the goods are suspended. A double counterpoise hanging at the same division will balance or indicate a double quantity of goods hanging at D; and any counterpoise will balance and indicate a double quantity of goods, if the dilance CD be reduced to one half. And it sometimes occurs that steelyards are constructed that they have two or more points of suspension D, to which the scale may occasionally be attached. It is evident, that in this case the value or indication of the divisions of the long arm will be different, according to the point from which the scale is suspended. The same division which would indicate 20 pounds when CD is three inches, will indicate 30 pounds when it is two inches. As it would expose to chance of mistakes, and be otherwise troublesome to make this reduction, it is usual to make as many divided scales on the long arm as there are points of suspension D on the short arm; and each scale having its own numbers, all trouble and all chance of mistake is avoided.

But the range of this instrument is not altogether at the pleasure of the maker. Besides the inability of a slender beam to carry a great load, the divisions of the scale answering to pounds or half-pounds become very minute when the dilance CD is very short; and the balance becomes less delicate, that is, less sensibly affected by small differences of weight. This is because in such cases the thickness which it is necessary to give the edges of the nails does then bear a sensible proportion to the dilance CD between them; so that when the balance inclines to one side, that arm is sensibly shortened, and therefore the energy of the preponderating weight is lessened.

We have hitherto supposed the steelyard to be in equilibrio when not loaded. But this is not necessary, nor is it usual in those which are commonly made. The long arm commonly preponderates considerably. This makes no difference, except in the beginning of the scale. The preponderancy of the long arm is equivalent to some goods already in the scale, suppose four pounds. Therefore when there are really 10 pounds in the scale, the counterpoise will balance it when hanging at the division 6. This division is therefore reckoned 10, and the rest of the divisions are numbered accordingly.

A scientific examination of the steelyard will convince us that it is inferior to the balance of equal arms

in point of sensibility: But it is extremely compendious and convenient; and when accurately made and attentively used, it is abundantly exact for most commercial purposes. We have seen one at Leipzig which has been in use since the year 1718, which is very sensible to a difference of one pound, when loaded with nearly three tons on the short arm; and we saw a waggon loaded with more than two tons weighed by it in about six minutes.

The steelyard in common use in the different countries of Europe is of a construction still simpler than what we have described. It consists of a batten of hard wood, having a heavy lump A (fig. 3.) at one end, and Fig. 3. a swivel-hook B at the other. The goods to be weighed are suspended on the hook, and the whole is carried in a loop of whip-cord C, in which it is slid backward and forward, till the goods are balanced by the weight of the other end. The weight of the goods is estimated by the place of the loop on a scale of divisions in harmonic progression. They are marked (we presume) by trial with known weights.

The chief use that is now made of the steelyard in these kingdoms is for the weighing of loaded waggons and carts. For this it is extremely convenient, and more than sufficiently exact for the purpose in view. We shall describe one or two of the most remarkable; and we shall begin with that at Leipzig already mentioned.

This steelyard is represented in fig. 4. as run out, Fig. 4. and just about to be hooked for lifting up the load. The steelyard itself is OPQ, and is about 12 feet long. The short arm PQ has two points of suspension *c* and *b*; and the stirrup which carries the chains for holding the load is made with a double hook, instead of a double eye, that it may be easily removed from the one pin to the other. For this purpose the two hooks are connected above an half or staple, which goes over the arm of the steelyard like an arch. This is represented in the little figure above the steelyard. The suspension is shifted when the steelyard is run in under cover, by hooking to this staple the running block of a small tackle which hangs in the door through which the steelyard is run out and in. This operation is easy, but necessary, because the stirrup, chains, and the stage on which the load is placed, weigh some hundreds.

The outer pin *b* is 14 inches, and the inner one *c* is seven inches, distant from the great nail which rests in the sheers. The other arm is about 10½ feet long, formed with an obtuse edge above. On the inclined plane on each side of the ridge is drawn the scale of weights adapted to the inner pin *c*. The scales corresponding to the outer pin *b* are drawn on the upright sides. The counterpoise slides along this arm, hanging from a saddle-piece made of brass, that it may not contract rust. The motion is made easy by means of rollers. This is necessary, because the counterpoise is greatly above a hundred weight. This saddle-piece has like two laps on each side, on which are engraved vernier scales, which divide their respective scales on the arm to quarters of a pound. Above the saddle is an arch, from the summit of which hangs a little plummet, which shows the equilibrium of the steelyard to the weight, because the sheers are four feet out of the house, and he cannot see their coincidence with the needle of the steelyard. Lastly, near the end of the long arm

STEELYARD.

Plate DVI.

Fig. 1.

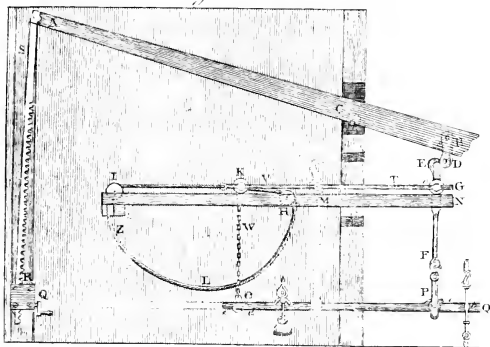

Fig. 2.

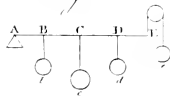

Fig. 3.

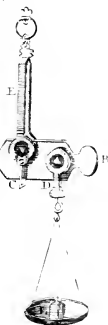

Fig. 5.

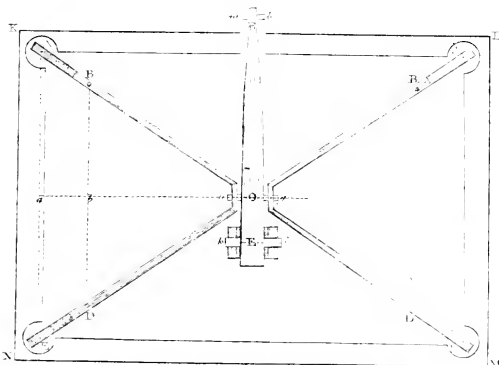
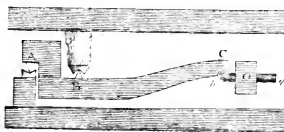
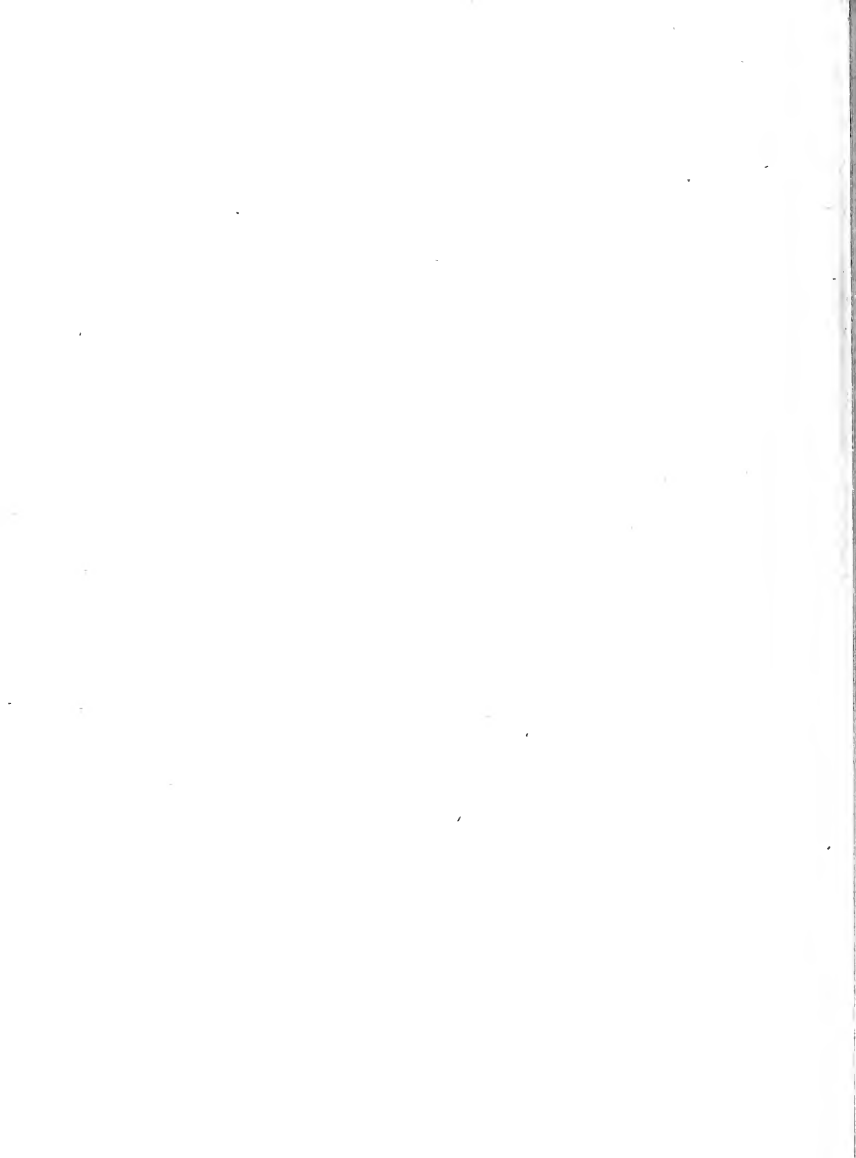

Fig. 6.



Fig. 7.





Steel-yard are two pins *d* and *e*, for suspending occasionally two eke weights for continuing the scale. These are kept hanging on adjoining hooks, ready to be lifted on by a little tackle, which is also hooked immediately above the pins *d* and *e*.

The scales of weights are laid down on the arm as follows. Let the eke-weights appropriated to the pins *d* and *e* be called D and E, and call the counterpoise C. Although the stirrup with its chains and flage weigh some hundreds, yet the length and size of the arm OP gives it a preponderancy of 320 pounds. Here, then, the scale of weights must commence. The counterpoise weighs about 125 pounds. Therefore,

1. When the load hangs by the pin *b*, 14 inches from the centre, the distance from one hundred to another on the scale is about 11 inches, and the first scale (on the side of the arm) reaches from 500 to 1200. In order to repeat or continue this, the eke weight E is hung on the pin *e*, and the counterpoise C is brought back to the mark 500; and the two together balance 1100 pounds hanging at *b*. Therefore a second scale is begun on the side of the arm, and continued as far out as the first, and therefore its extremity marks 2000; that is, the counterpoise C at 2200 and the eke-weight E at *e* balance 2200 hanging at *b*.

2. To continue the scale beyond 2000, the load must be hung on the inner pin *c*. The eke-weight E is taken off, and the eke-weight D is hung on its pin *d*. The general counterpoise being now brought close to the sheers, it, together with the weight D at *d*, balance 2000 pounds hanging at *c*. A scale is therefore begun on one of the inclined planes *a-top*, and continued out to 4000, which falls very near to the pin *d*, each hundred pounds occupying about five inches on the arm. To complete the scale, hang on the eke-weight E on its pin *e*, and bring back the counterpoise to the sheers, and the three together balance 3800 hanging at *c*. Therefore when the counterpoise is now slid out to 4000, it must complete the balance with 3800 hanging at *c*.

It required a little consideration to find out what proportion of the three weights C, D, and E, would make the repetitions of the scale extend as far as possible, having very little of it expressed twice, or upon two scales, as is the case here. We see that the space corresponding to a single pound is a very sensible quantity on both scales, being one-ninth of an inch on the first two scales, and one-twentieth on the last two.

This very ponderous machine, with its many weights, cannot be easily managed without some assistance from mechanics. It is extremely proper to have it susceptible of motion out and in, that it may be protected from the weather, which would soon destroy it by rust. The contrivance here is very effectual, and abundantly simple.

When the steelyard is not in use, it is supported at one end by the iron rod F, into which the upper end of the sheers is hooked. The upper end of this rod has a strong hook E, and a little below at *a* it is pierced with a hole, in which is a very strong bolt or pin of tempered steel, having a roller on each end close to the rod on each side. These rollers rest on two joists, one of which is represented by MN, which traverses the building, with just room enough between them to allow the rod F to hang freely down. The other end O of the steelyard rests in the bight of a large flat hook

at the end of a chain W, which hangs down between the joists, and is supported on them by a frame with rollers H. This is connected with the rollers at G, which carry the sheers by means of two iron-rods, of which one only can be seen. These connect the two sets of rollers in such a manner that they must always move together, and keep their distance invariable. This motion is produced by means of an endless rope HI ZLKVII passing over the pulleys I and K, which turn between the joists, and hanging down in a bight between them. It is evident that by pulling on the part LZ we pull the frame of rollers in the direction GH, and thus bring the whole into the loose in the position marked by the dotted figure. It is also plain, that by pulling on the part LK we force the roller frame and the whole apparatus out again.

It remains to show how the load is raised from the ground and weighed. When the steelyard is run out for use, the upper hook E just enters into the ring D, which hangs from the end of the great osken lever BCA about 22 feet long, turning on gudgeons at C about 5 feet from this end. From the other end A descends a long iron-rod SR, which has one side formed into a toothed rack that is acted on by a frame of wheel-work turned by an endless screw and winch Q. Therefore when the hook E is well engaged in the ring D, a man turns the winch, and thus brings down the end A of the great lever, and raises the load two or three inches from the ground. Every thing is now at liberty, and the weigher now manages his weights on the arm of the steelyard till he has made an equilibrium.

We need not describe the operation of letting down the load, disengaging the steelyard from the great lever, and bringing it again under cover. The whole of this service is performed by two men, and may be done in succession by one, and is over in five or six minutes.

The most compendious and economical machine of this kind that we have seen is one, first used (we have heard) for weighing the riders of race-horses, and afterwards applied to the more reputable service of weighing loaded carriages.

Fig. 5. is a plan of the machine. KLMN is the Fig. 5. plan of a rectangular box, which has a platform lid or cover, of size sufficient for placing the wheels of a cart or wagen. The box is about a foot deep, and is sunk into the ground till the platform cover is even with the surface. In the middle of the box is an iron lever supported on the fulcrum pin *ik*, formed like the nail of a balance, which rests with its edge on arches of hardened steel firmly fastened to the bottom of the box. This lever goes through one side of the box, and is furnished at its extremity with a hard steel pin *lm*, also formed to an edge below. In the very middle of the box it is crossed by a third nail of hardened steel *gh*, also formed to an edge, but on the upper side. These three edges are in one horizontal plane, as in a well made balance.

In the four corners A, A', E', E, of the box are firmly fixed four blocks of tempered steel, having their upper surfaces formed into spherical cavities, well polished and hard tempered. ABCDE represents the upper edge of an iron bar of considerable strength, which rests on the cavities of the steel blocks in A and E, by means

which should it is the position of the lever, the end of the bar is divided into equal parts or cells. The points are in a straight line parallel to the side KN of the box. The rule is part C of the crooked bar is fixed with hard-tempered steel, and is to be fixed into an edge parallel to AE and KN, by which it rests on the upper edge of the first pin g which is in the lever. In a line parallel to AE, and on the upper side of the crooked bar ACL are fixed two studs or points of hardened steel B and D projecting upwards above half an inch. The shaft run over has four feet like a foot, terminated by hard steel studs, which are fixed into spherical cavities and well polished. With this it rests on the over cast poles B, B', D, D'. The bar ACE is kned in such a manner vertically, that the points A, B, D, E and the edge C are all in a horizontal plane. These particulars will be better understood by looking at the elevation in fig. 6. What has been said of the bar ACL must be understood as also said of the bar A' C' E'.

Draw through the centre of the box the line abc 121, or the bar to the line AE, HD. It is evident that the bar ACE is equivalent to a lever abc , having the fulcrum or axis AE, resting with its extremity C on the pin g , and loaded at b . It is also evident the aC is to ab as the load on this lever to the pressure which it exerts on the pin g , and that the same proportion subsists between the whole load on the platform and the pressure which it exerts on the pin g . It will also appear on attentive consideration, that this proportion is not at all changed in whatever manner the load is placed on the platform. It very frequently, the two ends of the pin g may be unequal in breadth, and the lever weighted and balanced a little; but the total pressure is not changed.

If there be now placed a balance or steelyard at the side LN, in such a manner that one end of it may be directly above the pin h in the end of the lever EOF, it may be connected by a wire or slender rod, and a weight of the other arm of the balance or steelyard may be put in equilibrium with any load that can be laid on the platform. As in a counterpoise being first hung on to balance the apparatus when unloaded, any additional weight will measure the load really laid on the platform. If ab be to ac as 1 to 8, and EO to EP, also as 1 to 8, and if a common balance be used above, 64 pounds on the platform will be balanced by one pound in the scale, and every pound will be balanced by 64 or an ounce. This would be a very convenient partition for mail purposes, as it would enable us to get a common balance and common weights to compare the machine: Or it may be made with a balance of unequal arms, or with a steelyard.

Some have thought to improve this instrument by using edges like those of the tails of a balance, instead of points. But unless made with uncommon accuracy, they will render the balance very evil. The small deviation of the two edges A and B, or of B and D, from perfect parallelism to KN, is equal to a broad fork, or equal to the whole deviation. We imagine that, with a very extremely care, the machine may be made to weigh with an error of the sixth, which is exact enough for a purpose in commerce.

It is necessary that the points be attached to the Bars. Some have put the points at A and E in the

middle of the bar, into the bottom of the cavity, and by these ends they are dirty, which soon destroyed the instrument when used. But if it occasions a change or preparation for the oil lever by any kind of the cavity, or any of the oil will be nearly happen when the wheels of a loaded cart are pushed on the platform. The cavity in the steel that should have a little rim round it, and it should be kept full of oil. In a nice machine a quarter of an inch of quicksilver would effectually prevent all these inconveniences.

The simplest and most economical form of this machine is to have to balance or steelyard beyond; but to make the first steelyard EGF a lever of the first kind, viz. having the fulcrum between O and F, and allow it to project far beyond the box. The long or outward arm of this lever is then divided into a scale of weights, commencing at the side of the box. A counterpoise must be chosen, such as will, when at the beginning of the scale, balance the outward load that will probably be examined. It will be convenient to carry on this scale by means of the weights hung on at the extremity of the lever, and to use but one moveable weight. By this method the divisions of the scale will always have one value. The best arrangement is as follows: Place the mark O at the beginning of the scale, and let it extend only to 100, if for pounds; or to 112, if for cwt.; or to 12, if for stones; and let the cwt-weights be numbered 1, 2, 3, &c. Let the lowest weight be marked on the beam. This is always to be added to the weight shown by the operation. Let the cwt-weights stand at the end of the beam, and let the general counterpoise always hang at O. When the cart is put on the platform, the end of the beam tilts up. Hang on the heaviest cwt weight that is not sufficient to press it down. Now complete the balance by sliding out the counterpoise. Suppose the constant load to be 312 lbs, and that the counterpoise stands at 86, and that the cwt-weight is 9; we have the load $= 986 + 312 = 1298$ lbs.

STEELE, SIR RICHARD, was born about the year 1676 in Dublin; in which kingdom one branch of the family was possessed of a considerable estate in the county of Wexford. His father, a counsellor at law in Dublin, was private secretary to James duke of Omond; but he was of English extraction; and his son, while very young, being carried to London, he put him to school at the Charter-house, whence he was removed to Milton College in Oxford. Our author left the university, which he did without taking any degree, in the full resolution to enter into the army. This step was highly displeasing to his friends; but the ardour of his passion for a military life rendered him deaf to any other proposal. Not being able to procure a better station, he entered as a private gentleman in the horse guards, notwithstanding he thereby lost the succession to his Irish estate. However, as he had a flow of good nature, a generous spirit, and frankness of spirit, and a sparkling vivacity of wit, these qualities rendered him the delight of the soldiers, and procured him an entire's commission in the guards. In the mean time, as he had made choice of a profession which set him free from all the ordinary restraints in youth, he thought not to indulge his inclinations, but he would be exact. Yet his gaiety and revels did not mix without some cool hours of reflection; it was in these that he drew up his little treatise intitled

The Clever Hero, with a list of twelve new actors hired, to do a check upon his politics. The purpose it had had some time by him, when he visited it in 1701, with a dedication to Lord Carter, who had not only appointed him his private secretary, but procured for him a company in Lord Lumley's regiment of Footiers.

The same year he brought out his comedy, call'd *The Funeral*, or *Grave à la Mode*. This play was in the regard of King William, who resolv'd to give him some official marks of his favour; and though, upon that prince's death, his hopes were disappointed, yet, in the beginning of Queen Anne's reign, he was appointed to the profitable place of gazetter. He ow'd this part to the friendship of Lord Halifax, and the earl of Sunderland, to whom he had been recommended by his schoolfellow Mr Addison. That gentleman also lent him an helping hand in promoting the comedy call'd *The Tender Husband*, which was acted in 1704 with great success. But his next play, *The Lying Lover*, had a very different fate. Upon this subject in the stage, he turned the same humorous current into another channel; and early in the year 1709, he began to publish the *Tatler*; which admirable paper was undertaken in concert with Dr Swift. His reputation was perfectly established by this work; and, during the course of it, he was made a commissioner of the stamp-duties in 1710. Upon the change of the ministry the same year, he joined the duke of Marlborough, who had several years entertain'd a friendship for him; and upon his Grace's dismissal from all employments in 1711, Mr Steele address'd a letter of thanks to him for the services which he had done to his country. However, as our author still continued to hold his place in the stamp-duties under the new administration, he wisely declined the diffusion of political satires; and, adhering more closely to Mr Addison, he dropt the *Tatler*, and afterwards, by the assistance chiefly of that steady friend, he carried on the same plan, much improv'd, under the title of *The Spectator*. The success of this paper was equal to that of the former; which encouraged him, before the close of it, to proceed upon the same design in the number of the *Gardener*. This was opened in the beginning of the year 1713, and was laid down in Octo. of the same year. But in the course of it his thoughts took a stronger turn to politics; he express'd with great warmth against the ministry, and being desirous to procure his views that way by procuring a seat in the house of commons, he immediately remov'd all obstacles thereto. For that purpose he took care to prevent a Decree's dissolution from his seat in the stamp-duties, by a timely resignation of it to the earl of Oxford; and at the same time gave up a pension, which had been till this time paid him by the king as a reward to the late Prince George of Denmark. This done, he wrote the famous *Speech* upon the dissolution of Denmark, which was published Aug. 27. 1713, and the parliament being dissolved next day, the *Gardener* was soon followed by several other years of discourses against the administration. Upon the opening of the new parliament, Mr Steele having an opportunity to make for the house of Commons, he in 1714, in Honour, took his seat accordingly in the house of commons; he was expelled thence five days after, for writing the chief

of it, he call'd the *High Men*, and one of his political papers intitled the *Opinion*. Presently after his expulsion he published a paper for writing the history of the duke of Marlborough in the famous *Review*, he wrote the *Spectator*; and, in opposition to the *Reviewer*, he set up a paper call'd the *Reader*, and continu'd publishing several other things in the same spirit till the death of the queen. Immediately after which, as a reward for these services, he was taken into favour by her successor to the throne, King George I. He was appointed surveyor of the royal works at Hampton-Court, governor of the royal company of a medal, put into the commission of the peace for the county of Middlesex, and in 1715 received the honour of knighthood. In the first parliament of that King, he was chosen member for Broughshayle in Yorkshires; and, after the suppression of the rebellion in the north, was appointed one of the commissioners of the fortified cities in Scotland. In 1718, he buried his second wife, who had brought him a handsome fortune and a good estate in Wales; but neither this, nor the simple additions lately made to his fortune, were sufficient to answer his demands. The dissoluteness of his spirit often reduced him to necessities of want for his support; and the project of the *Opera* in this year cost him that clergy to the prodigious necessities. This vessel was intended to carry all above, and without venting, to any part of the kingdom; but notwithstanding all his loving cares, to whom he paid very returns to him; for after he had learn'd to improve a great part of his confidence and building the vessel, he was oblig'd to sell the project, which he had projected, it being out of his power to be a more project. His pleasure in being taken alive from the coast of Ireland, was the fish, though supplied by this contrivance with a continued stream of water white as snow, yet variety of their confinement, it threw themselves to pieces, and the fishes of the party so that when they were brought to market they were worth very little.

The following year he oppos'd the remarkable prerogative of the house of commons; and, during the course of his opposition to the court, his licence for selling glass was not renew'd, and his patent rendered ineffectual, at the instance of the lord chamberlain. He did his utmost to prevent a great loss, and finding every other avenue of approach to his royal employer, only barred against him by his powerful secretary, he resolv'd to the method of applying to the public, in hope that his complaints might, at the ear of his Majesty, though in a direct course, be that canal. In this spirit he found the plan of a periodical paper, to be published twice a week, under the title of the *Britisher*, the first number of which came out on the 22 of Juny 1719-20. In the mean time, the difficulties of being out of favour at court, like other misfortunes, drew after it a train of more. During the course of this paper, in which he had assum'd the sign'd name of *Samuel Johnson*, he was outrageously attacked by Mr Deane, the noted critic, in a very ill managed, call'd *The Character and Conduct of Samuel Johnson*. To this insult our author made a proper reply by the Theatre.

While he was struggling with all his might to keep himself in ruin, he found time to turn his pen, and the ink, into a *Book of Letters*, which he publish'd

Steele
II
Steering.

brought the nation to ruin in 1720; and the next year he was restored to his office and authority in the play-house in Drury-Lane. Of this it was not long before he made an additional advantage, by bringing his celebrated comedy called the *Confidant Lovers* upon that stage, where it was acted with prodigious success; so that the receipt there must have been very considerable, besides the profits accruing by the sale of the copy, and a purse of 500*l.* given to him by the king, to whom he dedicated it. Yet notwithstanding these ample supplies, about the year following, being reduced to the utmost extremity, he sold his share in the play-house; and soon after commenced a law-suit with the managers, which in 1726 was decided against him. Having now again, for the last time, brought his fortune, by the most heedless profusion, into a desperate condition, he was rendered altogether incapable of retrieving the loss, by being seized with a paralytic disorder, which greatly impaired his understanding. In these unhappy circumstances, he retired to his seat at Llangunan near Caermarthen in Wales, where he died on the 21st of September 1729, and was privately interred, according to his own desire, in the church of Caermarthen. Among his papers were found the manuscripts of two plays, one called *The Gentlemen*, founded upon the Eunuch of Terence, and the other intitled *The School of Action*, both nearly finished.

Sir Richard was a man of undissimbled and extensive benevolence, a friend to the friendless, and, as far as his circumstances would permit, the father of every orphan. His works are chaste and manly. He was a franger to the most distant appearance of envy or malevolence; never jealous of any man's growing reputation; and so far from arrogating any praise to himself from his conjunction with Mr Addison, that he was the first who desired him to distinguish his papers. His great fault was want of economy; and it has been said of him, he was certainly the most agreeable and the most innocent rake that ever trod the rounds of dissipation.

STEEPLE, an appendage erected generally on the western end of churches, to hold the bells. Steeples are denominated from their form, either spires or towers: the first are such as ascend continually diminishing either conically or pyramidally; the latter are mere parallelograms, and are covered a-top platform-like.

STEREAGE, on board a ship, that part of the ship next below the quarter-deck, before the bulk-head of the great cabin, where the steersman stands, in most ships of war. See STERING.

STERING, in *Navigation*, the art of directing the ship's way by the movements of the helm; or of applying its efforts to regulate her course when the advances.

The perfection of steering consists in a vigilant attention to the motion of the ship's head, so as to check every deviation from the line of her course in the first instant of its motion; and in applying as little of the power of the helm as possible. By this she will run more uniformly in a straight path, as declining less to the right and left; whereas, if a greater effort of the helm is employed, it will produce a greater declination from the course, and not only increase the difficulty of steering, but also make a crooked and irregular track through the water. See HELM.—The helmsman should diligently watch the movements of the head by

the land, clouds, moon, or stars; because, although the course is in general regulated by the compass, yet the vibrations of the needle are not so quickly perceived as the fallies of the ship's head to the right or left, which, if not immediately restrained, will acquire additional velocity in every instant of their motion, and demand a more powerful impulse of the helm to reduce them; the application of which will operate to turn her head as far on the contrary side of her course.—The phrases used in steering a ship vary according to the relation of the wind to her course. Thus, if the wind is fair or large, the phrases used by the pilot or officer who superintends the steering are, *port, star-board, and steady*. The first is intended to direct the ship's course farther to the right; the second is to guide her farther to the left; and the last is designed to keep her exactly in the line whereon she advances, according to the course prescribed. The excess of the first and second movements is called *hard-a-port*, and *hard-a-star-board*; the former of which gives her the greatest possible inclination to the right, and the latter an equal tendency to the left.—If, on the contrary, the wind is foul or scant, the phrases are *luff, thus, and no nearer*; the first of which is the order to keep her close to the wind; the second, to retain her in her present situation; and the third to keep her falls full.

In a ship of war, the exercise of steering the ship is usually divided amongst a number of the most expert sailors, who attend the helm in their turns; and are accordingly called *timoneers*, from the French term *timonier*, which signifies "helmsman." The steering is constantly superintended by the quarter-masters, who also attend the helm by rotation. In merchant ships every seaman takes his turn in this service, being directed therein by the mate of the watch, or some other officer.—As the safety of a ship, and all contained therein, depends in a great measure on the steering or effects of the helm, the apparatus by which it is managed should often be diligently examined by the proper officers. Indeed, a negligence in this important duty appears almost unpardonable, when the fatal effects which may result from it are duly considered.

STEEVENS, GEORGE, the most successful of all the editors and commentators of Shakespeare, was born in the year 1735. We know nothing respecting his parents, but they appear to have been in affluent circumstances. Our author received the rudiments of his education at Kington-upon-Thames, and had Gibbon the historian for a companion at that school. From hence he went to Eton, and in a few years was admitted a fellow commoner of King's college, Cambridge; but no mention is made of his peculiar course of studies. It appears, however, that he had little relish for the mathematics, which lead at Cambridge to academical honours. On the first establishment of the Essex militia, he accepted of a commission; but he spent the concluding years of his life in almost total seclusion from the world, seldom mingling with society, but in the shops of book-sellers, in the Shakespeare gallery, or in the morning conversations of Sir Joseph Banks.

Although not an original writer, we cannot in justice refuse him a place among the first literary characters of the age, when we consider the works he illustrated, and the learning, sagacity, taste, and general knowledge which he brought to the task. With a versatility of talents,

Steering
Steevens.

Stevens
Stellaria.

lents, he was eminent both by his pen and his pencil, but his chief excellence lay in his critical knowledge of an author's text; and the best specimen of his great abilities is his edition of Shakespeare, in which he has left every competitor far behind him. He had studied the age of Shakespeare, and employed his persevering industry in becoming acquainted with the writings, manners, and laws of that period, as well as the provincial peculiarities, whether of language or customs, which prevailed in different parts of the kingdom, but more particularly in those where Shakespeare passed the early years of his life. He was continually increasing this store of knowledge, by the acquisition of the obsolete publications of a former age, which he spared no expense to obtain. His critical sagacity and observation were constantly employed in calling forth the hidden meanings of the dramatic bard, and of course enlarging the display of his beauties. This advantage is apparent from his last edition of Shakespeare, which contains so large a portion of new, intertelling, and accumulated instruction. In preparing it for the press, he gave an instance of activity and perseverance without example. To this work he exclusively devoted a period of 18 months, during which he left his house every morning at one o'clock, going to his friend Mr Isaac Read's chambers in Barnard's-inn, without any consideration of the weather or the season, and there he found a sheet of the Shakespeare letter-press ready for correction. Thus, while the printers slept the editor was awake, by which means he completed, in less than 20 months, his splendid edition of Shakespeare in 15 vols. octavo; a labour almost incredible, and by which the energy and persevering powers of his mind were fully proved.

He probably reaped satisfaction with being a commentator from the particular habits of his life, and his devotion to the name of Shakespeare. But at the same time he was a classical scholar of the first order, and well acquainted with the belles lettres of Europe. He studied ancient and modern history; and particularly that of his own country. His genius was strong and original; his wit abundant; his imagination of every colour; and his sentiments enlivened with the most brilliant expressions. His eloquence was logical and animated; his descriptions were so true to nature, his figures so curiously selected, and so happily grouped, that he might be regarded as a speaking Hogarth. He scattered his wit and his humour too freely around him, and they were not lost for want of gathering.

Mr Stevens had a very handsome fortune, which he managed with discretion. His generosity was equal to his fortune; and though not profuse of his money to sturdy beggars, few persons distributed with more liberality to truly deserving objects. He possessed all the graces of outward accomplishment, at a period when civility and politeness were characteristics of a gentleman.

He bequeathed his valuable Shakespeare, illustrated with about 1500 prints, to Lord Spencer; his Hogarth perfect, with the exception of one or two pieces, to Mr Windham; and his corrected copy of Shakespeare, with 200 guineas, to his friend Mr Read. He died in the month of January 1800, about 65 years of age.

STEGANOGRAPHY, the art of secret writing, or of writing in ciphers, known only to the persons corresponding. See CIPHER.

STELLARIA, a genus of plants belonging to the
VOL. XIX. PART II.

Stellaria
Stemion.

class decandria, and in the natural system arranged under the 22d order, *Caryophyllaceæ*. See BOTANY Index.

STELLATE, in Botany, a term applied to leaves which grow not less than six at a joint, and are arranged like the rays of a star.

STELLERA, GERMAN GROUNDSEL, a genus of plants belonging to the class octandria; and in the natural system arranged under the 31st order, *Vepreculæ*. See BOTANY Index.

STELLIONATE, in the civil law, a kind of crime committed by a fraudulent bargain, where one of the parties sells a thing for what it is not; as if I sell an estate for my own which belongs to another, or convey a thing as free and clear which is already engaged to another, or put off copper for gold, &c.

STEM, in Botany, that part of a plant arising out of the root, and which sustains the leaves, flowers, fruits, &c. By washing and rubbing the stems of trees, their annual increase is promoted; for the method of doing which, see the article TREE.

STEM of a Ship, a circular piece of timber into which the two sides of a ship are united at the fore-end; the lower end of it is scarfed to the keel, and the bowsprit rests upon its upper end. The stem is formed of one or two pieces, according to the size of the vessel; and as it terminates the ship forward, the ends of the wales and planks of the sides and bottom are let into a groove or channel, in the middle of its surface, from the top to the bottom; which operation is called *rabiting*. The outside of the stem is usually marked with a scale, or division of feet, according to its perpendicular height from the keel. The intention of this is to ascertain the draught of water at the fore-part, when the ship is in preparation for a sea-voyage, &c. The stem at its lower end is of equal breadth and thickness with the keel, but it grows proportionally broader and thicker towards its upper extremity. See SHIP-BUILDING.

STEMMATA, in the history of insects, are three smooth hemispheric dots, placed generally on the top of the head, as in most of the hymenoptera and other classes. The name was first introduced by Linnæus.

STEMODIA, a genus of plants belonging to the class didymia; and in the natural system ranging under the 40th order, *Personatæ*. See BOTANY Index.

STEMPHYLA, a word used by the ancients to express the hulks of grapes, or the remains of the pressings of wine. The same word is also used by some to express the remaining mass of the olives, after the oil is pressed out.

STEMPHYLITES, a name given by the ancients to a sort of wine pressed hard from the hulks.

STEMPLES, in mining, cross bars of wood in the shafts which are sunk to mines.

In many places the way is to sink a perpendicular hole, or shaft, the sides of which are strengthened from top to bottom with wood-work, to prevent the earth from falling in; and the transverse pieces of wood are called *stemples*, and by means of these the miners in some places descend, without using any rope.

STEMSON, in a ship, an arching piece of timber fixed within the apron, to reinforce the scarf thereof, in the same manner as the apron supports the scarf of the stem. In large ships it is usually formed of two pieces.

STENOGRAPHY (A).

CHAP. I.

THE art of stenography, or short writing, was known and practised by most of the ancient civilized nations. The Egyptians, who were distinguished for learning at an early period, at first expressed their words by a delineation of figures called *hieroglyphics*. A more concise mode of writing seems to have been afterwards introduced, in which only a part of the symbol or picture was drawn. This answered the purpose of shorthand in some degree. After them the Hebrews, the Greeks, and the Romans*, adopted different methods of abbreviating their words and sentences, suited to their respective languages. The initials, the finals, or radicals, often served for whole words; and various combinations of these sometimes formed a sentence. Arbitrary marks were likewise employed to determine the meaning, and to assist legibility; and it seems probable that every writer, and every author of antiquity, had some peculiar method of abbreviation, calculated to facilitate the expression of his own sentiments, and intelligible only to himself.

It is also probable, that some might by these means take down the heads of a discourse or oration; but few, very few, it is presumed, could have followed a speaker through all the meanders of rhetoric, and noted with precision every syllable, as it dropt from his mouth, in a manner legible even to themselves.

To arrive at such consummate perfection in the art was reserved for more modern times, and is still an acquisition by no means general.

In every language of Europe, till about the close of the 16th century, the Roman plan of abbreviating (viz. substituting the initials or radicals, with the help of arbitraries, for words) appears to have been employed. Till then no regular alphabet had been invented expressly for stenography, when an English gentleman of the name of *Willis* invented and published one (B). His plan was soon altered and improved, or at least pretended to be so. One alteration succeeded another; and at

intervals, for a series of years past, some men of ingenuity and application have compiled and published systems of stenography, and doubtless have themselves reaped all the advantages that attend it. But among the various methods that have been proposed, and the different plans that have been adopted by individuals, none has yet appeared fortunate enough to gain general approbation; or proved sufficiently simple, clear, and concise, to be universally studied and practised.

Some systems are replete with unmeaning symbols, perplexing arbitraries, and ill-judged contractions; which render them so difficult to be attained by a common capacity, or ordinary application, that it is not to be wondered at if they have sunk into neglect, and are now no longer known (C). Other systems, by being too prolix, by containing a multiplicity of characters, and those characters not simple or easily remembered, become ineffectual to the purpose of expedition, and are only superior in obscurity to a common hand. Some, again, not only reject all arbitraries and contractions, but even prepositions and terminations; which last, if not too lavishly employed and badly devised, highly contribute to promote both expedition and legibility; and though they reduce their characters to fewer than can possibly express the various modifications of sound, yet they make nearly one half of them complex. In the disposition of the vowels, there is the greatest perplexity in most systems. A dot is sometimes substituted for all the vowels indiscriminately, and the judgement is left to determine which letter out of six any dot is intended to express; or a minute space is allotted them; so that unless they be arranged with mathematical precision they cannot be distinguished from one another; but such a minute attention is inconsistent with the nature of short-hand, which should teach us to write down in a short time, as well as in small bounds, what we wish to preserve of what we hear. Nor is the plan of lifting the pen and putting the next consonant in the vowel's place, in the middle of words, less liable to objections; or that of representing all the vowels by distinct characters, being obviously ill calculated for facility and dispatch,

(A) The value of stenography is not unknown to the learned; and the care and success with which it has been lately cultivated in these kingdoms will, in all probability, soon render it an object of general attention. No one, however, appears to us to have simplified and improved the art so much as Dr Mavor, author of *Universal Stenography*, who has liberally permitted us to present our readers with a complete view of his scheme. To those who wish to become proficient in SHORT WRITING, we earnestly recommend his entire publication (printed for Cadell and Davis, Strand, London), which in many schools of the first reputation now forms a deserved class-book.

(B) Mr Locke says, a regular method of short-writing seems to be known and practised only in Britain. This is not now the case; and indeed there is no reason to doubt whether characters may not be invented to express the various sounds, or letters, employed in any language, either ancient or modern.

(C) A list of writers on stenography. Mr Addy, Alidge, Angell, Annet, Blandemore, Blosset, Botley, Bridges, Byrom, Coles, Cross, Dix, Everardt, Ewen, Facey, Farthing, Gibbs, Graeme, Gunney, Heath, Holdforth, Hopkins, Jenke, LaSourer, Lane, Lyle, Mearns, Masfon, Mavor, Metcalle, Nicholas, Palmer, Rich, Ridpath, Shelton, Seale, Tanner, Taylor, Thicknesse, Tiften, Webber, Walton, Williamson, Willis, B. D. and Willis, &c.

* Vide *Buxtorf, Diog. Laertius, Plutarch*, &c.

dispatch, and consequently inadmissible into any useful system.

It is to be confessed, that the person who first proposed the omission of vowels in the middle of words (D), which it is obvious are not wanted, and invented letters, which could be connected as in a running hand without lifting the pen in the middle of the word, made a real improvement on the works of his predecessors. But, in fine, most systems, either in their plan or execution, labour under some capital defect, attended with circumstances highly discouraging to the learner, and which in a great measure defeat the end of their invention, by being too complicated to be learned with ease and remembered with accuracy; or to be practised with the expedition which is requisite; and so difficult to be deciphered, that a man can scarcely read what he has just written.

To obviate these defects; to provide against prolixity and conciseness, which might occasion obscurity; to exhibit a system founded on the simplest principles, which might be easily learned and read, and yet be capable of the utmost expedition—were the motives that gave rise to the present attempt.

This method will be found different from any yet published, and superior to all in the disposition of the vowels and the facility of arranging them; the confusion in placing which seems to detract from the merit of the best performances on the subject; and it may be affirmed, without ostentation, that characters simpler in their form, and more perfect in their union, have not been applied to the art of stenography.

As well as it could be determined, the simplest characters are appropriated to the letters most usually employed: indeed, as far as possible, those which are complex have been rejected; but as it was an object always kept in view that the writing should be on a line, a few are admitted into the alphabet for that reason.

The characters for the double and triple consonants are the easiest that could be invented, consistent with perspicuity (E); for care has been taken to provide against all obscurity which might arise by adopting letters too similar in their formation; and with respect to the prepositions and terminations, those which occur most frequently are expressed by the simplest characters, which will be found perfectly easy in their application.

The arbitraries are few in number (F), and the arbitrary abbreviations, as they are entirely from the letters of the alphabet, and chosen from some thousands of words in common use, will well repay the learner for an hour's trouble in committing them to memory.

The last chapter lays down a scheme of abbreviation,

comprised in a few rules, perfectly easy to be understood and practised by proficient in this art, which we hope will answer the expectation of the author, and will be found free from the perplexity complained of in many systems where abbreviation is admitted. The principal rules are new, are so easy, so extensive in their use, and so consistent with expedition and legibility, it applied with judgement, that they alone might suffice. The learner is however advised by no means to adopt any of them, till experience has convinced him that they may be used without error or injury to legibility. All abbreviating rules are suited to those only who have made some progress in the stenographic art; for although they certainly promote expedition in a wonderful manner, and afford the greatest ease to a proficient, yet a learner, as expedition is not his first, though his ultimate view, should admit of nothing that in the least renders the reading difficult.

CHAPTER II.

The English alphabet consists of twenty-six letters; six of which are vowels, *a, e, i, o, u,* and *y*; and the other twenty consonants, *b, c, d, f, g, h, k, l, m, n, p, q, r, s, t, v, x,* and *z*. The general pronunciation of the vowels is as in the following table.

This alphabet, as is observed by the best grammarians that have written on the language, is both defective and redundant in expressing the various modifications of sound. See Louth's Grammar, Sheridan's Lectures on Etymology.

Custom or prejudice has assigned some letters a place, when others would with much more propriety express the same sound: and to this may be added, that several letters, sometimes in one word, seem to be admitted for no other reason than to perplex a young beginner or a foreigner, as an obstruction to true pronunciation, and to add to the apparent length of the word, when they are entirely quiescent and useless. That this is the genius of the orthography of our language must be perceived by the most superficial observer; but no modern tongue is absolutely free from the same exceptions. In particular, the French has a great number of dormant letters, which, it is obvious, render the pronunciation more difficult and perplexing to learners (G).

But as it is neither our business nor our intention to propose a mode of spelling different from that in common use, when applied to printing or long-hand writing (since several innovators in orthography have fallen into contempt, and their plans have been only preferred as beacons to warn others of the folly of endeavouring to subvert established principles); we shall only observe, that in stenography, where the most expeditious and concise See Preface to the Dictionary.

(D) Mr Byrom rejected vowels entirely in the middle of words, as others before him had only done partially. Without critically examining the executive part of his performance, which is very defective, it must be owned, that it is above the reach of human ingenuity to exceed his general plan; which for ever must be fallen into every future rational system.

(E) These for *th* and *ch* may be either made upright or sloping to the right.

(F) These are not by any means prescribed; they may be employed or not according to the fancy of the learner.

(G) The Latin and Greek claim a just superiority over every modern tongue in this respect. In them no confusion or doubt can arise from the manner of spelling; and the reader can scarcely be wrong (unless in quantity) in founding all the letters he sees.

concise method is the best, if consistent with perspicuity, the following simple rules are studiously to be regarded and practised.

2
Rules for
the con-
sonants.

RULE I. All quiescent consonants in words are to be dropped; and the orthography to be directed only by the pronunciation: which being known to all, will render this art attainable by those who cannot spell with precision in long hand.

RULE II. When the absence of consonants, not entirely dormant, can be easily known, they may often be omitted without the least obscurity.

RULE III. Two or sometimes more consonants may, to promote greater expedition, be exchanged for a single one of nearly similar sound; and no ambiguity as to the meaning ensue (H).

RULE IV. When two consonants of the same kind or same sound come together, without any vowel between them, only one is to be expressed; but if a vowel or vowels intervene, both are to be written: only observe, if they are perpendicular, horizontal, or oblique lines, they must only be drawn a size longer than usual; and characters with loops must have the size of their heads doubled*.

* See
Plate
D.VII.

Might is to be written *mit*, fight *fit*, machine *masbin*, enough *enuf*, laugh *laf*, prophet *profet*, physics *fyiks*, through *thro*, foreign *foren*, sovereign *soveren*, palm *sam*, receipt *refet*, write *rite*, wright *riz*, island *iland*, knavery *navery*, temptation *temation*, knife *nife*, sick *sik*, thigh *thi*, honour *onour*, indictment *inditement*, acquaint *aquaint*, chaos *kaor*, &c.

3
First rule
exempli-
fied.

Strength *strenth*, length *lenth*, friendship *frenship*, connect *concl*, commandment *commannt*, conjunct *conjunt*, humble *humle*, lumber *lumer*, slumber *slumer*, number *numer*, exemplary *exemplary*, &c.

4
Second rule
exempli-
fied.

Rocks *rox*, acts *aks* or *ax*, facts *faks* or *fax*, districts *distriks*, or *distrix*, affects *afeks* or *afex*, afflicts *affliks* or *affliks*, conquer *kontr*, &c.

5
Third rule
exempli-
fied.

Letter *leter*, little *litle*, command *comand*, error *eror*, terror *teror*, &c. But in *remember*, *moment*, *fisher*, and such like words, where two consonants of the same name have an intervening vowel, both of them must be written.

6
Fourth rule
exempli-
fied.

These four rules, with their examples, being carefully considered by the learner, will leave him in no doubt concerning the disposition and management of the consonants in this scheme of short-writing; we shall therefore proceed to lay down rules for the application of the vowels with ease and expedition.

7
Rules for
the vowels.

RULE I. Vowels, being only simple articulate sounds, though they are the connectives of consonants, and employed in every word and every syllable, are not necessary to be inserted in the middle of words; because the consonants, if fully pronounced, with the assistance of connection, will always discover the meaning of a word, and make the writing perfectly legible.

RULE II. If a vowel is not strongly accented in the incipient syllable of a word, or if it is mute in the final, it is likewise to be omitted; because the sound of the

incipient vowel is often implied in that of the first consonant, which will consequently supply its place.

RULE III. But if the vowel constitutes the first or last syllable of a word, or is strongly accented at its beginning or end, that vowel is continually to be written.

RULE IV. If a word begins or ends with two or more vowels though separated, or when there is a coalition of vowels, as in diphthongs and triphthongs; only one of them is to be expressed, which must be that which agrees best with the pronunciation.

RULE V. In monosyllables, if they begin or end with a vowel, it is always to be inserted, unless the vowel be *e* mute at the end of a word.

Such are the general principles of this art; in vindication and support of which it will be needless to offer any arguments, when it is considered that brevity and expedition are the chief objects, if consistent with legibility; and the subsequent specimens in the orthography recommended will, we hope, be sufficient to show that there is no real deficiency in the last mentioned particular.

He who md us mlt be etrnal, grt, nd mnptnt. It is Specimen or dty, as rfnl bngs, to frv, lv, nd oby hm.—A mn tht of the mod wd avd blm, thd be frkmfpl in al hs axns, nd ndvr wth in the engra- al hs mt to pls evry bdy.—I wd nt frm any knxns wth a mn who hd no rgrd fr hmslf; nthr wd I blv a mn who phy.

hdv nns tld me a li.—Onr is of al thgs the mlt dsklt to prfv ntrmfnd; nd whn onns mchd, lk the chfity of a wmn, nvr fns wth its wntd ltr.—Wth grd mns, knplfms nd an efy plt adrs, mny nk a fgr in the wrt, whs mnl abtws wd kkrfly hv rsd thm aby the rnk of a stmn.—Idlms is the prnt of a thsnd msfrms, wch ar nvr flt by the ndftrs: it is a pn nd a pnlfmst of itself, nd brngs wnt nd bgrv in its trn.—Vrtu is the frst thng tht shd be rgrdd; it is a rwrld of itself; mks a mn rfpktbl hr, nd wl mk hm etrnly hpy brftr.—Prd is a mlt prms psn, wch yt ws plntd by hvn in ur ntr, to rs ur emlms to imtt grt nd wrthy kkrks or axns, to xt in us a sl fr wht is rt nd gft, nd a ldbl ndgnfn gnft oprfs nd wrks of any knd of nkyty; in shrt, to mk us st a prpr vlu upon urvlfs, nd dfps a wrthls fld, hu evr klted. Ths fr prd is a vrtu, nd my gftly be kld a grtns of fl. Bt prd, lk othr pns, gnly fxs upon rng obgks, or is spld in rng prfnfs. Hu kmn is it to be a rcth wth evry vs hs rndrd mfrbl, nd evry fly kntmbl, vng hmflf on hs btrh, nd blng ths illstr nfrftrs, of whm he nrhts ntng bt the nm or t! nfrftrs who if thy nu hm, wd dfr th dfrndt wth kntmt. But al prd of ths frt is fly, nd evr to be avdd.

CHAP. III.

As the whole of this art depends upon a regular method and a simple alphabet, we have not only endeavoured to establish the former on satisfactory principles, but have been careful to appropriate, according to the comparative frequency of their occurrence, such characters

(H) By this rule likewise *q* at *d* or *v* in the middle of words, but never in the beginning, may be exchanged for *t* and *f*, when they admit of an easier connecting with the following character, or will make the writing appear clearer.

ters for the letters *as*, after repeated trials and alterations, were conceived to be the best adapted for shorthand.

The stenographic alphabet consists of 18 distinct characters (viz. two for the vowels and the rest for the consonants), taken from lines and femicircular curves; the formation and application of which we shall now explain, beginning with the vowels.

For the three first vowels, *a*, *e*, and *i*, a comma is appropriated in different positions; and for the other three, *o*, *u*, and *y*, a point. The comma and point, when applied to *a*, and *o*, is to be placed, as in the Plate DVII. at the top of the next character; when for *e* and *u*, opposite to the middle; and when for *i* and *y*, at the bottom.

This arrangement of the vowels is the most simple and distinct that can easily be imagined. Places at the top, the middle, and the bottom of characters, which make three different positions, are as easily distinguished from one another as any three separate characters could be; and a comma is made with the same facility as a point.

Simple lines may be drawn four different ways; perpendicular, horizontal, and with an angle of about 45 degrees to the right and left. An ascending oblique line to the right, which will be perfectly distinct from the rest when joined to any other character, may likewise be admitted. These characters being the simplest in nature, are assigned to those five consonants which most frequently occur, viz. *l*, *r*, *t*, *c* hard or *k*, and *e* soft or *s*.

Every circle may be divided with a perpendicular and horizontal line, so as to form likewise four distinct characters. These being the next to lines in the simplicity of their formation, we have appropriated them for *b*, *d*, *n*, and *m*.

The characters expressing nine of the consonants are all perfectly distinct from one another; eight only remain which are needful, viz. *f*, *g* or *j*, *h*, *p*, *q*, *v*, *w*, and *x*; to find characters for which we must have recourse to mixed curves and lines. The characters which we have adopted are the simplest in nature after those already applied, admit of the easiest joining, and tend to preserve lineality and beauty in the writing.

It must be observed that we have no character for *c* when it has a hard sound, as in *castle*; or soft, as in *city*; for it naturally takes the sound of *k* or *s*, which in all cases will be sufficient to supply its place.

R likewise is represented by the same character as *l*; only with this difference, *r* is written with an ascending stroke (*1*), and *l* with a descending; which is always to be known from the manner of its union with the following character; but in a few monosyllables where *r* is the only consonant in the word, and consequently stands

alone, it is to be made as is shown in the alphabet for distinction's sake.

Z, as it is a letter seldom employed in the English language, and only a coarser and harder expression of *s*, must be supplied by *s* whenever it occurs; as for *Zedekiah* write *Sedekiah*, &c.

CHAP. IV.

THE prepositions and terminations in this scheme are so simple, that the greatest benefit may be reaped from them, and very little trouble required to attain them; as the incipient letter or the incipient consonant of all the prepositions and of several of the terminations is used to express the whole. But although in Plate DVII. sufficient specimens are given of the manner of their application, that the learner of less ingenuity or more slow perception may have every advantage, we have subjoined the following directions.

RULE I. The preposition is always to be written without joining, yet so near as plainly to show what word it belongs to; and the best way is to observe the same order as if the whole was to be connected.

RULE II. A preposition, though the same letters that constitute it may be met with in the middle or end of a word, is never to be used, because it would expose to obscurity.

RULE III. Observe that the preposition *omni* is expressed by the vowel *o* in its proper position; and for *anti*, *anta*, *ante*, by the vowel *a*, which the radical part of the word will easily distinguish from being only simple vowels.

The first rule for the prepositions is (allowing such exceptions as may be seen in the Plate) to be observed for the terminations; and also the second, *mutatis mutandis*; except that whenever *fis*, *fus*, *fys*, *ciour*, *ciour*, and *ces* occur, they are to be expressed as directed in the fourth rule for the consonants, whether in the beginning, middle, or end of words (*K*).

RULE IV. The terminative character for *tion*, *tion*, *cion*, *cion*, *tian*, is to be expressed by a small circle joined to the nearest letter, and turned to the right; and the plurals *tions*, *fions*, *cions*, *cians*, *tians*, *tionce*, by a dot on the same side.

RULE V. The terminative character for *ings*, is to be expressed likewise by a small circle, but drawn to the left hand; and its plural *ings* by a dot (*L*).

RULE VI. The plural sign *s* is to be added to the terminative characters when necessary.

RULE VII. The separated terminations are never to be used but in polysyllables or words of more syllables than one.

These rules duly observed will point out a method as concise and elegant as can be desired, for expressing the most

(1) The character for *h*, when lineality requires it, may be made from the bottom and inverted (see Plate DVII.). And often *h* may be omitted entirely, or a vowel may be substituted in its stead, without any injury to legibility, it being rather a breathing than letter.

(K) But in a few words where three horizontal characters meet, it will be better to express the *fit*, &c. by the femicircular character in Plate DVII. opposite *riour*.

(L) In horizontal characters, by the left hand is meant the top, and by the right the space below the letter (see *ing* joined, Plate DVII.). In all other characters the right and left positions will naturally be known.

most frequent and longest prepositions and terminations in the English language. If it should be thought necessary to increase their number by the addition of others, it will be an easy matter for any one of the least discernment to do so, by proceeding on the principles before laid down.

CHAP. V.

14
Rules for
abbrevia-
tion.

THOUGH a more concise method of writing, or more numerous abbreviations, may not be indispensably necessary, if the foregoing directions be practised for a considerable time, yet contractions will be found extremely useful and convenient to those who have attained a proper knowledge of the subject, and lead to a greater degree of expedition, at the same time that they diminish the labour of writing. It has been observed in the introduction, that abbreviations are only to be employed by proficient in this art; because expedition is not the first, though the ultimate, object in view; and that an easy legibility is of the utmost consequence to the learner; which, however, cannot be preserved, if he adopts too soon those very rules which in time will afford him the greatest ease when applied with judgment.

The following short and practical rules will be found, we hope, fully adequate to every purpose for which they were intended, and are far superior in the facility of their application to any which we have seen.

RULE I. The usual abbreviations in long hand are always to be followed; as Mr for Master, M. D. for Doctor of Physic, and Abp. for Archbishop, &c.

RULE II. Substantives, adjectives, verbs, and participles, when the sense will direct to the meaning, are to be expressed by their initial consonant with the distinguishing marks exhibited in Plate DVII. viz. a substantive must have the dot exactly over its initial consonant; an adjective must have a dot under it; a verb is to be expressed by a comma over its initial consonant; and a participle by a comma under (u). These being the four principal parts of speech will be sufficient; and an adept will never be at a loss to know when he can with safety apply this rule to them.

RULE III. To render the writing more legible, the last letter of the word may be joined to the first, and the proper mark applied.

RULE IV. The constituent or radical part of words, especially if they are long, will often serve for the whole, or sometimes the first syllable: as, we ought to moderate our *ex.* by our *circum.*; a man's *man.* commonly shane his *for.*

RULE V. All long words without exception may have their prepositions or terminations expressed by the initial consonant of such preposition or termination.

RULE VI. When there is a great dependence between the parts of a sentence, the initial letter will often suffice; as *L.* is the capital of Great *B.*; the eldest *S.* of the king of Great *B.* is styled prince of *H.* Every one, it is presumed, will allow this to be perfectly legible in long-hand, then why may it not in stenography?

RULE VII. The terminations *ness* and *less* may be omitted; as *faithfulness* is only to be written *faithful*; *forwardness*, *forward*; *heedless*, *heed*; *stubbornness*, *stubborn*, &c.

RULE VIII. The second and third persons of verbs, ending in *est* and *est*, may be expressed by *s*; as, he *loves*, thou *teaches*; instead of he *loveth*, thou *teachest*; or even without *s*; as, he *love*, &c.

RULE IX. Words may often be entirely omitted, and yet no ambiguity ensue; as, *In beginning God created heaven and earth*, for *In the beginning God created the heaven and the earth*.

RULE X. When there is an immediate repetition of a sentence or word, a line is to be drawn under the sentence or word to be repeated; as, *Amen, Amen*, is to be written *Amen*; but if any words intervene before a word or sentence is to be repeated, the line must be drawn as before, and a *A* or mark of omission placed where the repetition should begin; as, *Is it just the innocents should be condemned* *A* *reviled*?

THE CONTENTS of the STENOGRAPHIC PLATES.

Fabricius's Reply to Pyrrhus.

As to my poverty, you have indeed, Sir, been rightly informed. My whole estate consists in a house of but mean appearance, and a little spot of ground, from which by my own labour I draw my support. But if by any means you have been persuaded to think, that this poverty makes me less considered in my country, or in any degree unhappy, you are extremely deceived. I have no reason to complain of fortune, she supplies me with all that nature requires; and if I am without superfluities, I am also free from the desire of them. With these I confess I should be more able to succour the necessitous, the only advantage for which the wealthy are to be envied; but as small as my possessions are, I can still contribute something to the support of the state and the assistance of my friends. With regard to honours, my country places me, poor as I am, upon a level with the richest: for Rome knows no qualifications for great employments but virtue and ability. She appoints me to officiate in the most august ceremonies of religion; she entrusts me with the command of her armies; she confides in my care the most important negotiations. My poverty does not lessen the weight and influence of my counsels in the senate; the Roman people honour me for that very poverty which you consider as a disgrace; they know the many opportunities I have had in war to enrich myself without incurring censure; they are convinced of my disinterested zeal for their prosperity; and if I have any thing to complain of in the return they make, it is only the excess of their applause. What value then can I set upon your gold and silver! What king can add any thing to my fortune! Always attentive to discharge the duties incumbent

Plate
DVIII.

(*) The dot or comma being placed thus will never occasion them to be mistaken for vowels, because they should always be on one side or other; whereas the mark for parts of speech may constantly be placed exactly over or under.

incumbent on me, I have a mind free from self-reproach, and I have an honest fame. *Dodley's Preceptor.*

Letter to a Friend against waste of Time.

Converse often with yourself, and neither lavish your time, nor suffer others to rob you of it. Many of our hours are stolen from us, and others pass insensibly away; but of both these losses the most painful is that which happens through our own neglect. If we take the trouble to observe, we shall find that one considerable part of our life is spent in doing evil, and the other in doing nothing, or in doing what we should not do. We don't seem to know the value of time, nor how precious a day is; nor do we consider that every moment brings us nearer our end. Reflect upon this, I entreat you, and keep a strict account of time. Procrastination is the most dangerous thing in life. Nothing is properly ours but the instant we breathe in, and all the rest is nothing; it is the only good we possess; but then it is fleeting, and the first comer robs us of it. Men are so weak, that they think they oblige by giving of trifles, and yet reckon that time as nothing for which the most grateful person in the world can never make amends. Let us therefore consider time as the most valuable of all things; and every moment spent, without some improvement in virtue or some advancement in goodness, as the greatest sublimary loss.

St Paul's Speech before Agrippa and Festus.

I think myself happy, King Agrippa, that I shall answer for myself this day before thee, touching all things whereof I am accused of the Jews: especially because I know thee to be expert in all customs and questions which are among the Jews, wherefore I beseech thee to hear me patiently. My manner of life from my youth, which was at first among mine own nation at Jerusalem, know all the Jews, which knew me from the beginning (if they would testify), that, after the strictest sect of our religion I lived a Pharisee. And now I stand and am judged for the hope of the promise made by God unto our fathers: unto which promise our twelve tribes incessantly serving God day and night hope to come; for which hope's sake, King Agrippa, I am accused of the Jews. Why should it be thought a thing incredible with you, that God should raise the dead, when God himself has given assurance of it unto all men, in that he hath raised Christ from the dead? As for my own part, most noble Festus, I own I once verily thought that even I myself ought to do many things contrary to the name of Jesus of Nazareth. Which thing I also did in Jerusalem. I punished the saints oft in every synagogue, and compelled them to blaspheme; and being exceedingly mad against them, I persecuted them even unto strange cities. In pursuit of which, as I went to Damascus, with authority and commission from the chief priests: At mid-day, O King, I saw in the way a light from heaven, above the brightness of the sun, shining about me, and them which journeyed with me. And when we were all fallen to the earth, I heard a voice speaking unto me, and saying in the Hebrew tongue, Saul, Saul, why persecutest thou me? It is hard for thee to kick against the pricks. And I said, Who art thou, Lord? And he said, I am Jesus whom thou persecutest. But rise, and stand upon thy feet: for I have appeared unto thee for this pur-

pose, to make thee a minister and a witness both of these things which thou hast seen, and of those things in which I will appear unto thee. Whereupon, O King Agrippa, I was not disobedient to the heavenly vision: but shewed first unto them of Damascus, and at Jerusalem, and throughout all the coasts of Judea, and then to the Gentiles, that they should repent and turn to God. For these causes the Jews caught me in the temple, and went about to kill me. Having therefore obtained help of God, I continue unto this day, witnessing both to small and great, saying none other things than those which the prophets and Moses did say should come: That Christ should suffer, and that he should be the first that should rise from the dead, and should show light unto the people, and to the Gentiles. This is the real truth: Believe me, I am no peltent fellow, nor mover of sedition; but always endeavour all that lies in me to preserve a confidence void of offence towards God and towards man: nor can the Jews prove the things whereof they now accuse me. Neither am I, Festus, besides myself; but speak thus freely before the king, because he knows these things to be fact; yea, I am fully persuaded the king knows them all to be fact; for they were not done in a corner. King Agrippa, believest thou the prophets? I know that thou believest. And would to God that not only thou, but also all that hear me this day, were altogether such as I am except these bonds. *Holmes's Rhetoric.*

Pope to Atterbury.

Once more I write to you as I promised, and this once I fear will be the last; the curtain will soon be drawn between my friend and me, and nothing left but to wish you a long good night; may you enjoy a state of repose in this life not unlike that sleep of the soul which some have believed is to succeed it, where we lie utterly forgetful of that world from which we are gone, and arising for that to which we are to go. If you retain any memory of the past, let it only image to you what has pleased you best; sometimes present a dream of an absent friend, or bring you back an agreeable conversation. But, upon the whole, I hope you will think less of the time past than the future; as the former has been less kind to you than the latter infallibly will be. Do not envy the world your studies: They will tend to the benefit of men, against whom you can have no complaint; I mean, of all posterity: and, perhaps, at your time of life, nothing else is worth your care. What is every year of a wise man's life but a censure or critic on the past? Those whose date is the shortest, live long enough to laugh at one half of it: The boy despises the infant, the man the boy, the philosopher both, and the Christian all. You may now begin to think your manhood was too much a puerility; and you will never suffer your age to be but a second infancy. The toys and baubles of your childhood are hardly now more below you than those toys of our riper and our declining years; the drums and rattles of ambition, and the dirt and bubbles of avarice. At this time, when you are cut off from a little society, and made a citizen of the world at large, you should bend your talents not to serve a party, or a few, but all mankind. Your genius should mount above that mist, in which its participation and neighbourhood with earth hath long involved it: To shine abroad, and to heaven,

ought.

ought to be the business and the glory of your present situation. Remember it was at such a time that the greatest lights of antiquity dazzled and blazed the night; in their retreat, in their exile, or in their death. But why do I talk of dazzling or blazing? it was then that they did good, that they gave light, and that they became guides to mankind. Those aims alone are worthy of spirits truly great, and such I therefore hope will be yours. Resentment indeed may remain, perhaps cannot be quite extinguished, in the noblest minds; but revenge will never harbour there: Higher principles than those of the fit, and better principles than those of the latter, will infallibly influence men whose thoughts and whose hearts are enlarged, and cause them to prefer the whole to any part of mankind, especially

to so small a part as one's single self. Believe me, my Lord, I look upon you as a spirit entered into another life, as one just upon the edge of immortality, where the passions and affections must be much more exalted, and where you ought to despise all little views and all mean retrospects. Nothing is worth your looking back: and therefore look forward, and make (as you can) the world look after you; but take care it be not with pity, but with esteem and admiration. I am, with the greatest sincerity and passion for your fame as well as happiness, your, &c.

The above most charming and most affectionate letter was written about a month before Atterbury bishop of Rochester was sent into banishment, and is universally admired.

S T E

STENTOROPHONIC TUBE, a speaking trumpet; thus called from Stentor, a person mentioned by Homer. See **TRUMPET**.

STEP, in a ship, a block of wood fixed on the decks or bottom of a ship, and having a hole in its upper side, fitted to receive the heel of a mast or capstan. The steps of the main and foremasts of every ship rest upon the keelson, to which they are firmly secured by knees, bolts, or spike-nails. The step of the mizen-mast usually rests upon the lower deck.

STEPHANUM, a genus of plants belonging to the pentandria class; and in the natural method ranking under the 47th order, *Stellatae*. See **BOTANY Index**.

STEPHANOPHORUS, in antiquity, the chief priest of Pallas, who presided over the rest. It was usual for every god to have a chief priest; that of Pallas was the Stephanophorus just mentioned, and that of Hercules was called Dadouchus.—Stephanophorus was also a priest who assisted the women in the celebration of the festival Thesmophoria.

STEPHANUS BYZANTINUS, an able grammarian, who lived in the fifth or sixth century. He wrote a Dictionary, in which he made a great number of observations, borrowed from mythology and history, which showed the origin of cities and colonies, of which we have nothing remaining but a mean abridgement by Hermodorus the grammarian; but from that work the learned have received great light; and Sigonius, Casaubon, Scaliger, Salmastius, &c. have employed themselves in illustrating it.

STEPHEN, king of England. See **ENGLAND**, No 108, &c.

STEPHEN, or *St Stephen's Day*, a festival of the Christian church, observed on the 26th of December, in memory of the first martyr St Stephen.

STEPHENS, a family of printers deservedly celebrated. They flourished at the time of the revival of learning, and contributed a great deal towards dispelling the cloud of ignorance which had so long overshadowed Europe. Some of the classics before the 16th century were in a great measure lost, and all of them were exceedingly

S T E

corrupted. By their abilities and indefatigable industry these defects were supplied, and the learned were furnished with beautiful and correct editions of the Greek and Roman authors. Thus the world was not only supplied with an inexhaustible fund of amusement and instruction in these ancient writings; but it is to the ardour which they inspired, and to the model of elegance which they displayed, that the present advanced state of literature is in a great measure owing.

HENRY STEPHENS, the first of these illustrious men, was born in France, soon after the discovery of printing, perhaps about the year 1465. He settled as a printer at Paris, and was probably patronized by Louis XII. A great proportion of the books which he published were Latin: They are printed in the Roman letter, and are not inelegant, though some of them abound rather too much in contractions. He died about the year 1520, and left behind him three sons, Francis, Robert, and Charles. His widow married Simeon de Colines (*Colinæus* in Latin), who thus got possession of Henry's printing-house, and continued the profession till his death.

Of **FRANCIS**, the eldest son, little more is known than that he carried on business along with his father-in-law Colinæus, and that he died at Paris in 1550.

ROBERT STEPHENS, the second son, was born in 1503. In his youth he made great proficiency in the Roman, Greek, and Hebrew languages, and at the age of 19 had acquired so much knowledge, that his father-in-law entrusted him with the management of his press. An edition of the New Testament was published under his inspection, which gave great offence to the Paris divines, who accused him of heresy, and threatened to prevent the sale of the book. Soon after he began business himself, and married Perrette the daughter of Jodocus Badius, a printer and an author. She was a woman of learning, and understood Latin, which indeed was the necessary consequence of her situation. Her husband always entertained a number of learned men as correctors of the press: Being foreigners, and of different nations, they made use of no other language but Latin; which Perrette being accustomed to hear, was able in a short time

Stentorophonic
||
Stephens.

Stephens

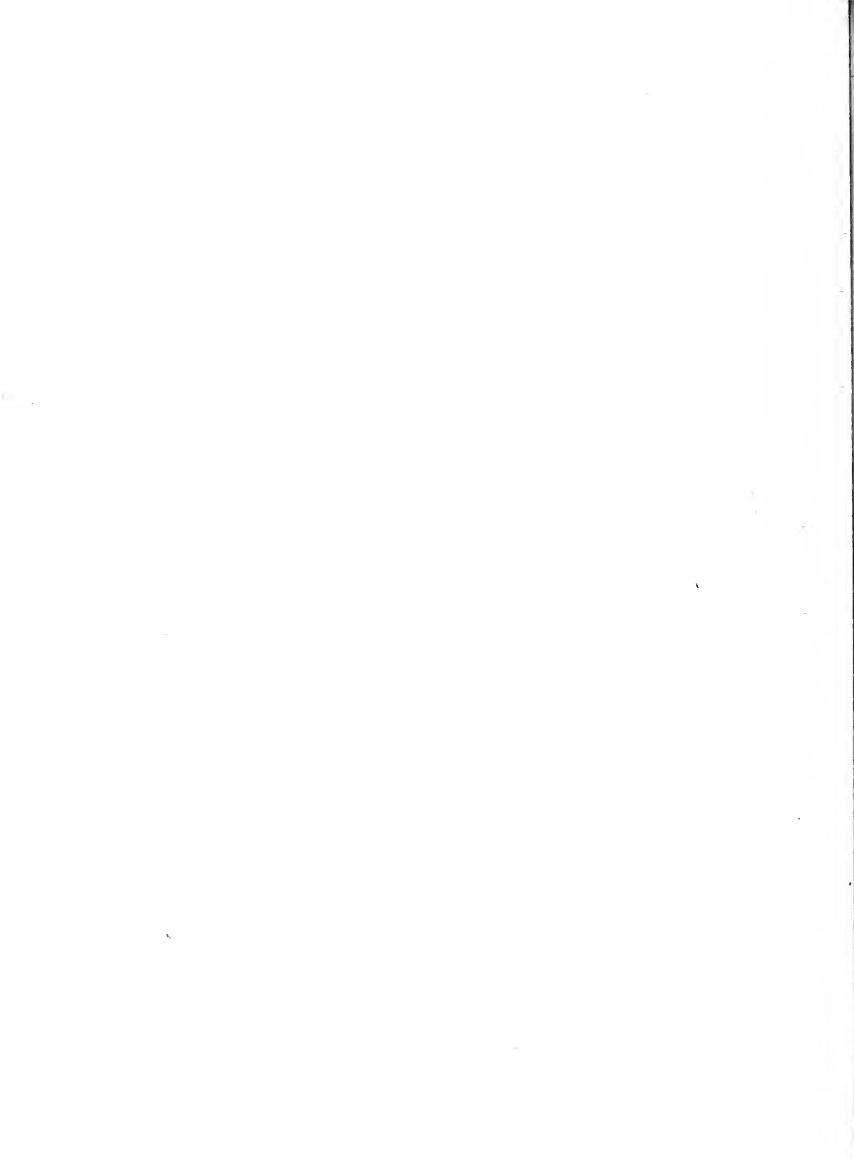

FABRICIUS' Alph. to PYRRHUS.

SI. PAUL'S SPELL. II.

1. 2. 3. 4. 5. 6. 7. 8. 9. 10. 11. 12. 13. 14. 15. 16. 17. 18. 19. 20. 21. 22. 23. 24. 25. 26. 27. 28. 29. 30. 31. 32. 33. 34. 35. 36. 37. 38. 39. 40. 41. 42. 43. 44. 45. 46. 47. 48. 49. 50. 51. 52. 53. 54. 55. 56. 57. 58. 59. 60. 61. 62. 63. 64. 65. 66. 67. 68. 69. 70. 71. 72. 73. 74. 75. 76. 77. 78. 79. 80. 81. 82. 83. 84. 85. 86. 87. 88. 89. 90. 91. 92. 93. 94. 95. 96. 97. 98. 99. 100.

1. 2. 3. 4. 5. 6. 7. 8. 9. 10. 11. 12. 13. 14. 15. 16. 17. 18. 19. 20. 21. 22. 23. 24. 25. 26. 27. 28. 29. 30. 31. 32. 33. 34. 35. 36. 37. 38. 39. 40. 41. 42. 43. 44. 45. 46. 47. 48. 49. 50. 51. 52. 53. 54. 55. 56. 57. 58. 59. 60. 61. 62. 63. 64. 65. 66. 67. 68. 69. 70. 71. 72. 73. 74. 75. 76. 77. 78. 79. 80. 81. 82. 83. 84. 85. 86. 87. 88. 89. 90. 91. 92. 93. 94. 95. 96. 97. 98. 99. 100.

LETTER &c.

1. 2. 3. 4. 5. 6. 7. 8. 9. 10. 11. 12. 13. 14. 15. 16. 17. 18. 19. 20. 21. 22. 23. 24. 25. 26. 27. 28. 29. 30. 31. 32. 33. 34. 35. 36. 37. 38. 39. 40. 41. 42. 43. 44. 45. 46. 47. 48. 49. 50. 51. 52. 53. 54. 55. 56. 57. 58. 59. 60. 61. 62. 63. 64. 65. 66. 67. 68. 69. 70. 71. 72. 73. 74. 75. 76. 77. 78. 79. 80. 81. 82. 83. 84. 85. 86. 87. 88. 89. 90. 91. 92. 93. 94. 95. 96. 97. 98. 99. 100.

POPE & ATTERBURY.

1. 2. 3. 4. 5. 6. 7. 8. 9. 10. 11. 12. 13. 14. 15. 16. 17. 18. 19. 20. 21. 22. 23. 24. 25. 26. 27. 28. 29. 30. 31. 32. 33. 34. 35. 36. 37. 38. 39. 40. 41. 42. 43. 44. 45. 46. 47. 48. 49. 50. 51. 52. 53. 54. 55. 56. 57. 58. 59. 60. 61. 62. 63. 64. 65. 66. 67. 68. 69. 70. 71. 72. 73. 74. 75. 76. 77. 78. 79. 80. 81. 82. 83. 84. 85. 86. 87. 88. 89. 90. 91. 92. 93. 94. 95. 96. 97. 98. 99. 100.

1. 2. 3. 4. 5. 6. 7. 8. 9. 10. 11. 12. 13. 14. 15. 16. 17. 18. 19. 20. 21. 22. 23. 24. 25. 26. 27. 28. 29. 30. 31. 32. 33. 34. 35. 36. 37. 38. 39. 40. 41. 42. 43. 44. 45. 46. 47. 48. 49. 50. 51. 52. 53. 54. 55. 56. 57. 58. 59. 60. 61. 62. 63. 64. 65. 66. 67. 68. 69. 70. 71. 72. 73. 74. 75. 76. 77. 78. 79. 80. 81. 82. 83. 84. 85. 86. 87. 88. 89. 90. 91. 92. 93. 94. 95. 96. 97. 98. 99. 100.

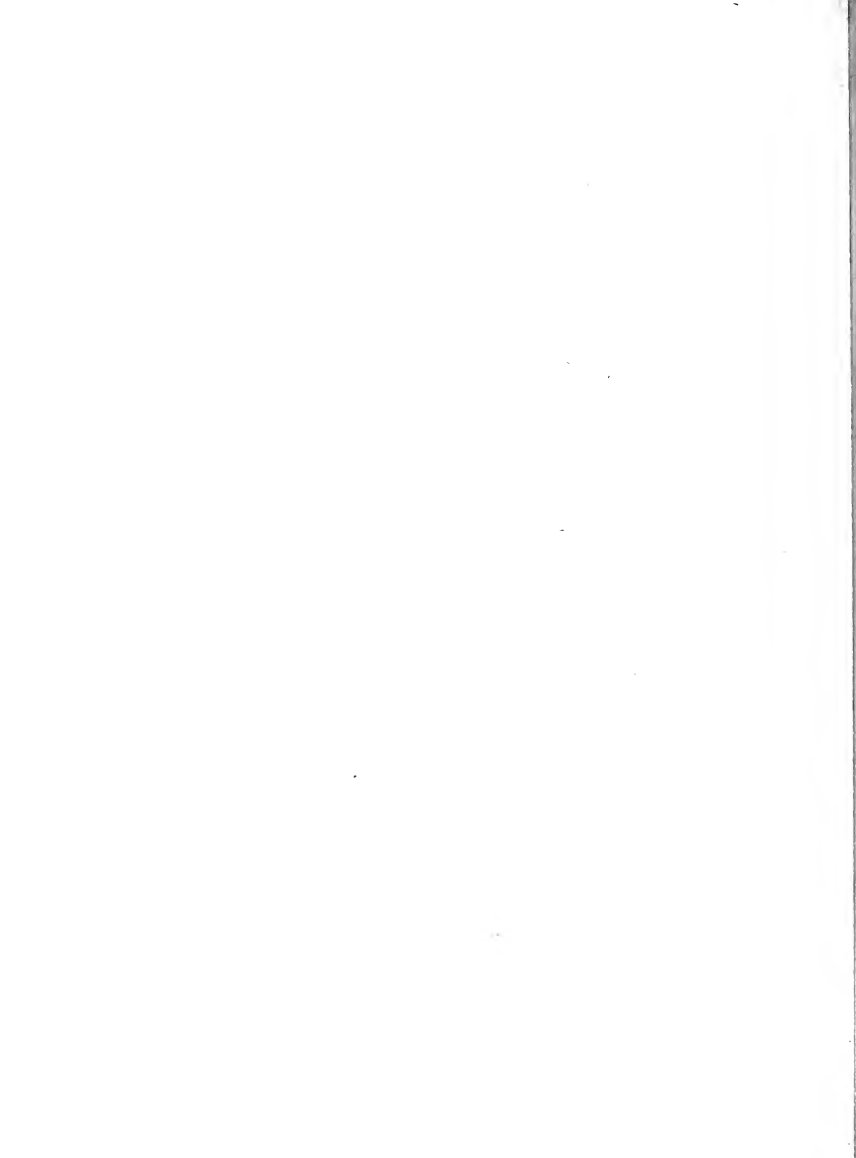

Stephens. not only to understand, but even to speak with tolerable ease.

In 1531 he published his Latin "Thesaurus;" a work of great importance, which he laboured at for two years. The mark which he put upon all his books was a tree branched, with a man looking upon it, and these words *noli alium sapere*, to which he sometimes added *sed time*. In 1539, Francis I. made him his printer, and ordered a new set of elegant types to be founded for him. His frequent editions of the New Testament gave great offence to the doctors of the Sorbonne, who accused him of heresy for his annotations, and insisted upon the suppression of some of his books. Although Henry the French king in some measure protected him, the persecution of these divines rendered him so unhappy, not to mention the expence and loss of time which an almost constant attendance at court unavoidably occasioned, that in 1552 he abandoned his country and went to Geneva. Here he embraced the Protestant religion, and thus justified in some measure the suspicions of his theological enemies. It has been affirmed by several writers that he carried along with him the royal types, and the moulds also in which they were cast; but it is certain that he never afterwards made use of those types. Besides, is it possible that the author of so daring a theft could have been not only protected in Geneva, but even courted and honoured by the most eminent men of the age? Is it credible that such a crime could have been concealed for 60 years; or that Henry, the son and heir of the perpetrator, would have enjoyed the favour of the French king, if Robert Stephens had acted such a shameful part? If he was burnt in effigy at Paris, it was not their fault, but for having changed his religion. After his arrival at Geneva, he published an account of the dispute between him and the Paris divines, which does as much honour to his abilities as his *Thesaurus* does to his learning. He died in 1559, after a life of the most extraordinary industry. The books of which he was the editor were not fewer than 360. Many of them were ancient classics in different languages. Several were accompanied with annotations which he collected, and all of them were corrected by collating manuscripts. He was so anxious to obtain perfect accuracy, that he used to expose his proofs in public, and reward those who discovered a mistake. His books consequently were very correct. It is said that his New Testament, called *O Mirificam* (because the preface begins with these words), has not a single fault.

It was Robert Stephens who first divided the New Testament into verses during a journey between Paris and Lyons. The advantages of this improvement are fully counterbalanced by its defects. It has destroyed the unity of the books, and induced many commentators to consider every verse as a distinct and independent aphorism. To this in some measure is to be ascribed the many absurd interpretations and creeds that have been forced out of that book.

By his last will his estate was left exclusively to four of his children as should settle at Geneva. He left behind him three sons, Henry, Robert, and Francis.

CHARLES STEPHENS, the third son of Henry, was, like the rest of his family, familiarly acquainted with the learned languages. This recommended him to Lazarus de Balif, who made him tutor to his son, and in 1540 carried him along with him to Germany. He

studied medicine, and practised it with success in France. He did not, however, forsake the profession of his family, but exercised it in Paris, where he became the editor of many books remarkable for neatness and elegance. He wrote above thirty treatises on different subjects, particularly on botany, anatomy, and history. He died in 1564.

ROBERT STEPHENS, the son of Robert the first of that name, did not accompany his father to Geneva, but continued to profess the Catholic religion, and to reside at Paris. His letter was remarkably beautiful.— He was made king's printer, and died about 1589.

His brother FRANCIS was also a printer. He embraced the Protestant religion, and resided at Geneva.

HENRY STEPHENS, the remaining son of Robert, was born at Paris in 1528. He became the most learned and most celebrated of all his family. From his very birth almost he gave proofs of uncommon abilities, and displayed an ardent passion for knowledge. The *Medea* of Euripides, which he saw acted while at school, first kindled his love for poetry, and inspired him with the desire of acquiring the language in which that tragedy is written. He entreated his father not to condemn him to study Latin, which he already understood from conversation, but to initiate him at once into the knowledge of Greek. His father willingly granted his request; and Henry applied with such vigour, that in a short time he could repeat the *Medea* by heart. He afterwards studied Greek under Peter Danefius, who was tutor to the Dauphin, and finally heard the lectures of Tufanus and Turnebus. He became eager at an early age to understand astrology, and accordingly attended a professor of that mysterious art; but he was not long in discovering its absurdity. At 19 he began his travels, which he undertook in order to examine foreign libraries, and to become acquainted with learned men. He spent two years in Italy, and returned into France completely master of Italian, and bringing along with him copies of several scarce authors, particularly a part of Anacreon, which before was thought lost.

He found his father publishing an edition of the New Testament, to which he prefixed some Greek verses.— Soon after, he visited England and the Netherlands, where he met with John Clement, an Englishman, to whom he was indebted for the remaining odes of Anacreon. During this journey he learned the Spanish language, which was very much spoken at that time in the Low Countries.

Whether Henry accompanied his father to Geneva or not is uncertain; at least he must have returned immediately to France, for we find him soon after established at Paris, and publishing the odes of Anacreon. In 1554 he went to Rome, and thence to Naples. This journey was undertaken at the request, and in the service, of the French government. He was discovered, and would have been arrested as a spy, had he not by his address and skill in the language of the country been able to pass himself for a native of Italy. On his return to France he assumed the title of printer to Ulric Fugger, a very rich and learned German nobleman, who allowed him a considerable pension.

In 1560 he married a relation, as is generally supposed, of Henry Scrimgeour, a Scotch nobleman, with whom he was intimately acquainted. She was a woman, as he himself informs us, endowed with the noblest

Stephens. spirit and the most amiable dispositions. Her death, which happened in 1586, brought on a disease that had twice attacked him before. It was a disquitt at all those pursuits which had formerly charmed him, an aversion to reading and the sight of books. It was probably occasioned by too constant and severe an application to literary pursuits. In 1572 he published his *Theaurus Lingue Græcæ*, one of the greatest works, perhaps, that ever was executed by one man, if we consider the wretched materials which more ancient dictionaries could furnish, if we consider the size and perfection of the work, and the immense labour and learning which must have been employed in the compilation. This work had been carried on at a greater expence than he could well bear. He expected to be reimbursed by the sale of the book, but he was unfortunately disappointed. John Scapula, one of his own servants, exacted from it whatever he thought would be most serviceable to students, and published it beforehand in 4th. By this act of treachery Henry was reduced to poverty.

See Scapula.

About this time he was much beloved by Henry III. of France, who treated him so kindly, and made him such flattering promises, that he resided frequently at court. But these promises were never fulfilled, owing to the civil wars which soon after distracted France, and the unfortunate death of King Henry himself. During the remainder of his life his situation was very unsettled. We find him sometimes at Paris, sometimes in Geneva, in Germany, and even in Hungary. He died at Lyons in 1598, at the age of 70. He was fond of poetry from his very infancy. It was a custom of his to compose verses on horseback, and even to write them, though he generally rode a very mettlesome steed. His *Theaurus* was his great work, but he was also the author of several other treatises. His poems are numerous: His Apology for Herodotus is a witty satire on the Roman Catholics. His Concordance to the New Testament must have been a laborious work, and has deservedly endeared him to every Christian who wishes to acquire a rational and critical knowledge of the Scriptures. The number of books which he published, though fewer than his father, was great, and superior in elegance to any thing which the world had then seen. A great proportion of them were Greek; he was the editor, however, of many Roman and even of some eastern writings. His Greek classics are remarkably correct; the principal of them are Homer, Anacreon, Æschylus, Maximus Tyrus, Diodorus Siculus, Pindar, Xenophon, Thucydides, Herodotus, Sophocles, Diogenes Laertius, Plutarch, Plato, Apollonius Rhodius, Æschines, Lyfias, Callimachus, Theocritus, Herodian, Dionysius Hallicarnassensis, Dion Cassius, Iocrates, Appian, Xiphilin, &c. His temper in the latter part of his life is represented as haughty and severe, owing probably to his disappointments. He left behind him a son and two daughters, one of whom was married to the learned Isaac Casaubon.

PAUL STEPHENS, the son of Henry, continued his father's profession at Geneva. He was a man of learning, and wrote translations of several books, and published a considerable number of the ancient classics; but his editions possess little of his father's elegance. He died in 1627, at the age of 62, after selling his types to one Chouet a printer.—His son ANTHONY, the last printer of the family, abandoned the Protestant religion, and re-

turned to France, the country of his ancestors. He received letters of naturalization in 1612, and was made printer to the king; but managing his affairs ill, he was reduced to poverty, and obliged to retire into an hospital, where he died in 1674, miserable and blind, at the age of 80.

Stephens II
Stercorifer.

STERCORARIANS, or STERCORANISTÆ, foimed from *stercus* "dung," a name which those of the Romish church anciently gave to such as held that the hot was liable to digestion, and all its consequences, like other food.

STERCULIA, a genus of plants belonging to the class monœcia; and in the natural system ranging under the 38th order, *tricoceæ*. See BOTANY Index.

STEREOGRAPHIC PROJECTION, is the projection of the circles of the sphere on the plane of some one great circle, the eye being placed in the pole of that circle. See PROJECTION of the Sphere.

STEREOMETR, an instrument invented in France for measuring the volume of a body, however irregular, without plunging it in any liquid. If the volume of air contained in a vessel be measured, when the vessel contains air only, and also when it contains a body whose volume is required to be known, the volume of air ascertained by the first measurement, deducting the volume ascertained by the second, will be the volume of the body itself. Again, if the volume of any mass of air be inversely as the pressure to which it is subjected, the temperature being supposed constant, it will be easy to deduce, from the mathematical relations of quantity, the whole bulk if the difference between the two bulks under two known pressures be obtained by experiment.

Suppose that the first pressure is double the second, or the second volume of air double the first, and the difference equal to 50 cubic inches; the first volume of air will likewise be 50 cubic inches. The design of the stereometer is to ascertain this difference at two known pressures.

The instrument is a kind of funnel AB (fig. 1.) composed of a capsule A, in which the body is placed, and the tube B as uniform in the bore as can be procured. The upper edge of the capsule is ground with emery, that it may be hermetically closed with a glass cover M slightly greased. A double scale is passed on the tube, having two sets of graduations; one to denote the length, and the other the capacities, as determined by experiment.

Plate
DLX.
Fig. 1.

When this instrument is used, it must be plunged into a vessel of mercury, with the tube very upright, till the mercury rise within and without to a point C of the scale. See fig. 2.

The capsule is then closed with the cover, which being greased will prevent its communication between the external air and that contained within the capsule and tube.

Fig. 2.

In this situation of the instrument, the internal air is compressed by the weight of the atmosphere, expressed by the length of the mercury in the tube of the common barometer.

The instrument is then elevated, still keeping the tube in the vertical position. It is thus represented, fig. 2. second position. The mercury descends in the tube, but not to the level of the external surface, and a column of mercury DE remains suspended in the tube, the height of which is known by the scale. The interior air is less compressed

STEREOMETER.

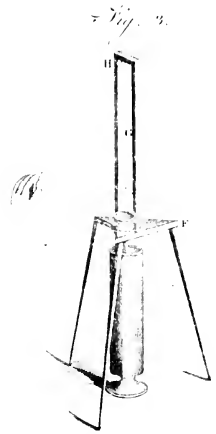
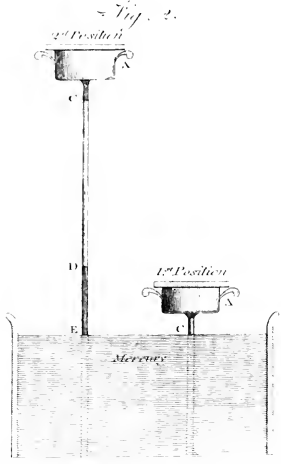
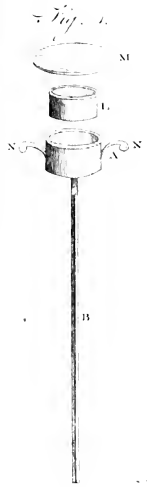

S O H, S Analysis of.

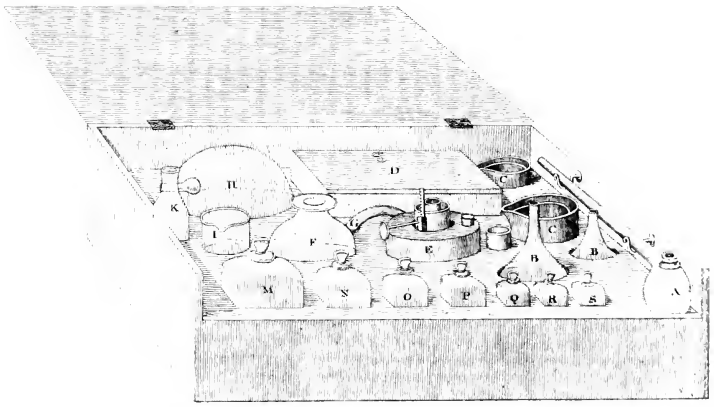

Stereomet-
ter
||
stereotomy.

compressed than before, the increase of its volume being equal to the whole capacity of the tube from C to D, indicated by the second scale.

It is therefore known that the pressures are in proportion to the barometrical column, and to the same column — D E. The bulks of the air in these two states are inversely in the same proportion; and the difference between these bulks is the absolute quantity left void in the tube by the fall of the mercury; from which data the following rule is deduced. Multiply the number expressing the less pressure by that which denotes the augmentation of capacity, and divide the product by the number which denotes the difference of the pressures. The quotient is the bulk of the air when subject to the greater pressure.

Suppose the height of the mercury in the barometer to be 78 centimetres, and the instrument being empty to be plunged into the mercury to the point C. It is then covered and raised till the small column of mercury D E is suspended, say at the height of six centimetres. The internal air at first compressed by a force represented by 78 centimetres, is now only compressed by a force = 72 centimetres, or $78 - 6 = 72$.

Suppose that the capacity of the part CD of the tube which the mercury has quitted is two cubic centimetres.

Then $\frac{72}{6} \times 2 = 24$ cubical centimetres, the volume of the air included in the instrument when the mercury rose as high as C in the tube.

The body of which the volume is to be ascertained must then be placed in the capsule, and the operation repeated. Let the column of mercury suspended be = 8 centimetres, when the capacity of the part CD of the tube is = 2 centimetres cubic. Then the greatest pressure being denoted by 78 centimetres, the least will be 70 centimetres, the difference of pressure being 8, and difference of the volumes two cubic centimetres.

Hence $\frac{72}{8} \times 2$ gives the bulk of the included air under

the greatest pressure 17.5 cubic centimetres. Then $24 - 17.5 = 6.5$ the volume of the body introduced. If the absolute weight of the body be multiplied by its bulk in centimetres, and divided by the absolute weight of one cubic centimetre of distilled water, the quotient will be = the specific gravity of the body in the common form of the tables, where distilled water is taken as unity, or the term of comparison.

Mr Nicholson supposes that the author of the invention had not finished his meditations on the subject. If he had, it is probable that he would have determined his pressures, as well as the measures of bulks, by weight. For if the whole instrument were let to its positions by suspending it from one arm of a balance at H (fig. 3.) the quantity of counterpoise, when in equilibrio, might be applied to determine the pressures to a degree of accuracy much greater than can be obtained by linear measurement.

STEREOMETRY, $\Sigma\tau\epsilon\rho\iota\omicron\mu\epsilon\tau\rho\iota\alpha$, formed of $\sigma\tau\epsilon\rho\iota\omicron\mu\epsilon$ solid, and $\mu\epsilon\tau\rho\epsilon\omicron$ measure, that part of geometry which teaches how to measure solid bodies, i. e. to find the solidity or solid contents of bodies; as globes, cylinders, cubes, vessels, ships, &c.

STEREOTOMY, formed from $\sigma\tau\epsilon\rho\iota\omicron\mu\epsilon$, and $\tau\omicron\mu\alpha$,

section, the art or act of cutting solids, or making sections thereof; as walls and other membranes in the profiles of architecture.

STEREOTYPE PRINTING, a method of printing, which was introduced into this country by William Ged of Edinburgh before the middle of the 18th century, and which has been revived of late, and greatly improved by the French. It has also been brought into practice in Britain by Earl Stanhope, who has produced some beautiful specimens of it. Some persons seem disposed to dispute the invention of Ged, seeing that the same method of printing by wooden blocks was practised by the Chinese and Japanese many hundred years ago. See *GED, life of*, and *PRINTING*.

STERILITY, barrenness, in opposition to fertility. It has been asserted by many authors, that all monstres produced by a mixture of different species of animals, such as mules, are barren; but this does not hold universally, even with the mule, which is the instance most generally adduced.

Sterility in women sometimes happens from a miscarriage, or violent labour injuring some of the genital parts; but one of the most frequent causes is the suppression of the menstrual flux.—There are other causes arising from various diseases incident to those parts, by which the uterus may be unfit to receive or retain the male seed;—from the tubæ fallopianæ being too short, or having lost their erectile power; in either of which cases no conception can take place;—from universal debility and relaxation; or a local debility of the genital system; by which means, the parts having lost their tone or contractile power, the semen is thrown off immediately *post coitum*;—from imperforation of the vagina, the uterus, or the *tubæ*, or from diseased ova, &c. Hence medical treatment can only avail in cases arising from topical or universal debility; in correcting irregularities of the menstrual flux, or in removing tumors, cicatrices, or contractions of the passage, by the art of surgery.

STERIS, a genus of plants belonging to the class pentandria. See *BOTANY Index*.

STERLING, an epithet by which genuine English money is distinguished. It is unnecessary to mention the various conjectures of antiquaries about the origin and meaning of this appellation. The most probable opinion seems to be this, that some artists from Germany, who were called *Esterlings*, from the situation of their country, had been employed in fabricating our money, which consisted chiefly of silver pennies; and that from them the penny was called an *esterling*, and our money *esterling* or *sterling* money.

STERN, the posterior face of a ship; or that part which is repleated to the view of a spectator, placed on the continuation of the keel behind. The stern is terminated above by the tiller, and below by the counters; it is limited on the sides by the quarter-pieces, and the intermediate space comprehends the galleries and windows of the different cabins. See *QUARTER of a Ship*, *SHIP*, and *SHIP-BUILDING*.

STEER-FAST, a rope used to confine the stern of a ship or boat to any wharf or jetty head, &c.

STERN-MÜß, in sea language, usually denotes that part of a fleet of ships which is in the rear, or farthest a-stern, as opposed to head-moist.

STERN-Post, a long straight piece of timber erected on the extremity of the keel, to sustain the rudder and terminate the ship behind.

This piece ought to be well secured and supported; because the ends of all the lower planks of the ship's bottom are fixed in a channel, cut on its surface; and the whole weight of the rudder is sustained by it.

STERN-Sheets, that part of a boat which is contained between the stern and the aftmost or hindmost seat of the rowers. It is generally furnished with benches to accommodate the passengers. See *BOAT*.

STERNA, the *TERN*; a genus of birds arranged under the order of *palmipedes*. See *ORNITHOLOGY Index*.

STERNE, LAURENCE, an English writer of a very peculiar cast, was born at Clomwell, in the south of Ireland, on 24th November 1713. His father Roger Sterne was the grandson of Sterne archbishop of York, who has been supposed, we know not upon what grounds, to have been the author of the excellent book entitled "The Whole Duty of Man." Laurence inherited nothing of his ancestor's manner of writing, but rather resembled Rabelais, whose wit he carried with him even into the pulpit.

In 1722 he was sent to school at Halifax in Yorkshire, where he continued till 1732, when he was removed to Jesus College in Cambridge. How long he resided in college, or what progress he made in literature or science, is not known: his works display rather native genius than profound erudition. Upon quitting the university he went to York, and being in orders was presented to the living of Sutton by the interest of his uncle Dr Sterne, a prebendary of that church. In 1741 he married, and was soon afterwards made a prebendary of York, by the interest also of his uncle, who was then upon very good terms with him; but "quickly quarrelled with him (he says), and became his bitterest enemy, because he would not be a party man, and write paragraphs in the newspapers." By his wife's means he got the living of Stillington, but remained near 20 years at London, doing duty at both places. He was then in very good health, which, however, soon after forsook him; and books, painting, fiddling, and shooting, were, as he tells us, his amusements.

In 1765, he went to London to publish his two first volumes of "Tristram Shandy;" and was that year presented to the curacy of Coxwold. In 1762 he went to France, and two years after to Italy, for the recovery of his health; but his health never was recovered. He languished under a consumption of the lungs, without the slightest depression of spirits, till 1768, when death put a period to his terrestrial existence.

The works of Sterne are very generally read. They consist of, 1. The Life and Opinions of Tristram Shandy; 2. Sermons; 3. A Sentimental Journey; 4. Letters, published since his death. In every serious page, and in many of much levity, the author writes in praise of benevolence, and declares that no one who knew him could suppose him one of those wretches who heap misfortune upon misfortune: But we have heard anecdotes of him extremely well authenticated, which proved that it was easier for him to praise this virtue than to practise it. His wit is universally allowed; but many readers have persuaded themselves that they found wit

in his blank pages, while it is probable that he intended nothing but to amuse himself with the idea of the sage conjectures to which these pages would give occasion. Even his originality is not such as is generally supposed by those fond admirers of the Shandean manner, who have presumed to compare him with Swift, Arbuthnot, and Butler. He has borrowed both matter and manner from various authors, and in particular from an old work, "The Anatomy of Melancholy by Burton," as every reader may be convinced by the learned, elegant, and candid comments on his works published by Dr Ferriar, in the fourth volume of the Memoirs of the Literary and Philological Society of Manchester.

STERNOCOSTALES, commonly called the *musculi triangulares sterni*, in *Anatomy*, are five pairs of fleshy planes, disposed more or less obliquely on each side the sternum, on the insides of the cartilages of the second, third, fourth, fifth, and sixth true ribs.

STERNO-HYOIDEUS, in *Anatomy*. See *Table of the Muscles*, under the article *ANATOMY*.

STERNOMANTIS, in antiquity, a designation given to the Delphian priests, more usually called *Pythia*.—*Sternomantis* is also used for any one that had a prophesying demon within him.

STERNOMASTOIDÆUS, a muscle. See *Table of the Muscles*, under *ANATOMY*.

STERNOTHYROIDEUS, a muscle. See *Table of the Muscles*, under *ANATOMY*.

STERNUM. See *ANATOMY Index*.

STERNUTATIVE, or *STERNUTATORY*, a medicine proper to produce sneezing. See *SNEEZING*.

STETIN, or *STETTIN*, a sea-port town of Germany, in the circle of Upper Saxony, and capital of Hither Pomerania, with the title of a duchy, and a castle. It had long a famous school, which the wars of Germany never disturbed. The ancient dukes of Pomerania resided here; and it was taken by the elector of Brandenburg in 1676, but given to Sweden by the treaty of Nimeguen. In 1713 it submitted to the allies; and then the said elector was put in possession again of this important place, which is a bulwark to the marche of Brandenburg; and the fortifications have been greatly improved. It is now a flourishing place, and carries on a considerable trade. It is seated on the river Oder, 72 miles north of Francfort, and 70 north by east of Berlin. E. Long. 14. 38. N. Lat. 53. 35. The duchy is 125 miles in length, and borders upon Mecklenburg, and partly upon Brandenburg. The breadth is from 17 to 25 miles, and it is divided by the river Oder into two parts.

STEW, a small kind of fish-pond, the peculiar use of which is to maintain fish, and keep them in readiness for the daily use of the family, &c.

*STEW*s (from the French *estuves*, i. e. *thermae*, *balneum*), those places which were permitted in England to women of professed incontinency; so called, because dissolute persons are wont to prepare themselves for venereous acts by bathing; and hot baths were by Homer reckoned among the effeminate sort of pleasures. These stews were suppressed by King Henry VIII. about the year 1516.

*STEW*ARD (*senecallus*, compounded of the Saxon *steda*, i. e. "room" or "stead," and *ward*, "a ward" or "keeper"), an officer appointed in another's stead or place, and always taken for a principal officer within his jurisdiction.

Steward. jurisdiction. Of these there are various kinds. The greatest officer under the crown is the lord high-steward of England, an office that was anciently the inheritance of the earls of Leicester, till forfeited by Simon de Mountfort to King Henry III. But the power of this officer is so very great, that it has not been judged safe to trust it any longer in the hands of a subject, excepting only *pro hac vice*, occasionally: as to officiate at a coronation, at the arraignment of a nobleman for high-treason, or the like. During his office, the steward bears a white staff in his hand; and the trial, &c. ended, he breaks the staff, and with it his commission expires. There is likewise a lord-steward of the king's household, who is the chief officer of the king's court, has the care of the king's house, and authority over all the officers and servants of the household, except such as belong to the chapel, chamber, and stable.

SEWARD, an officer in a ship of war, appointed by the purser to distribute the different species of provisions to the officers and crew; for which purpose he is furnished with a mate and proper assistants.

Court of the Lord High STEWARD of Great Britain, is a court instituted for the trial of peers indicted for treason or felony, or for misprison of either. The office of this great magistrate is very ancient, and was formerly hereditary, or at least held for life, or *dum bene se gesserit*: but now it is usually, and hath been for many centuries past, granted *pro hac vice* only; and it hath been the constant practice (and therefore seems now to have become necessary) to grant it to a lord of parliament, else he is incapable to try such delinquent peer. When such an indictment is therefore found by a grand jury of freeholders in the King's bench, or at the assizes before the justices of *oyer and terminer*, it is to be removed by a writ of *certiorari* into the court of the lord high-steward, which has the only power to determine it. A peer may plead a pardon before the court of King's bench, and the judges have power to allow it, in order to prevent the trouble of appointing an high-steward merely for the purpose of receiving such plea: but he may not plead in that inferior court any other plea, as guilty or not guilty of the indictment, but only in this court; because, in consequence of such plea, it is possible that judgement of death might be awarded against him. The king, therefore, in case a peer be indicted of treason, felony, or misprison, creates a lord high-steward *pro hac vice* by commission under the great seal; which recites the indictment so found, and gives his Grace power to receive and try it *secundum legem et consuetudinem Angliæ*. Then when the indictment is regularly removed by writ of *certiorari*, commanding the inferior court to certify it up to him, the lord high-steward directs a precept to a serjeant at arms, to summon the lords to attend and try the indicted peer. This precept was formerly issued to summon only 18 or 20 selected from the body of the peers; then the number came to be indefinite; and the custom was for the lord-high-steward to summon as many as he thought proper (but of late years not less than 23); and that those lords only should sit upon the trial; which threw a monstrous weight of power into the hands of the crown, and this its great officer, of selecting only such peers as the then predominant party should most approve of. And accordingly, when the earl of Clarendon fell into disgrace with Charles II. there was a design formed to

prorogue the parliament, in order to try him by a select number of peers; it being doubted whether the whole house could be induced to fall in with the views of the court. But now, by statute 7 W. III. c. 2. upon all trials of peers for treason or misprison, all the peers who have a right to sit and vote in parliament shall be summoned at least 20 days before such trial, to appear and vote therein; and every lord appearing shall vote in the trial of such peer, first taking the oaths of allegiance and supremacy, and subscribing the declaration against popery.

During the session of parliament, the trial of an indicted peer is not properly in the court of the lord high-steward, but before the court last mentioned of our lord the king in parliament. It is true, a lord high-steward is always appointed in that case to regulate and add weight to the proceedings: but he is rather in the nature of a speaker *pro tempore*, or chairman of the court, than the judge of it; for the collective body of the peers are therein the judges both of law and fact, and the high-steward has a vote with the rest in right of his peerage. But in the court of the lord high-steward, which is held in the recess of parliament, he is the sole judge of matters of law, as the lords triors are in matters of fact; and as they may not interfere with him in regulating the proceedings of the court, so he has no right to intermix with them in giving any vote upon the trial. Therefore, upon the conviction and attainder of a peer for murder in full parliament, it hath been holden by the judges, that in case the day appointed in the judgement for execution should lapse before execution done, a new time of execution may be appointed by either the high court of parliament during its sitting, though no high-steward be existing, or, in the recess of parliament, by the court of King's bench, the record being removed into that court.

It has been a point of some controversy, whether the bishops have now a right to sit in the court of the lord-high-steward to try indictments of treason and misprison. Some incline to imagine them included under the general words of the statute of King William "all peers who have a right to sit and vote in parliament;" but the expression had been much clearer, if it had been "all lords," and not "all peers;" for though bishops, on account of the baronies annexed to their bishoprics, are clearly lords of parliament, yet their blood not being ennobled, they are not universally allowed to be peers with the temporal nobility: and perhaps this word might be inserted purposely with a view to exclude them. However, there is no instance of their sitting on trials for capital offences, even upon impeachments or indictments in full parliament, much less in the court we are now treating of; for indeed they usually withdraw voluntarily, but enter a protest, declaring their right to stay. It is observable, that in the 11th chapter of the constitutions of Clarendon, made in parliament 11th Henry II. they are expressly excluded, rather than excluded, from sitting and voting in trials, which concern life or limb: *episcopi, sicut ceteri barones, debent interesse iudiciis cum baronibus, quousque perveniantur ad diminutionem membrorum vel ad novitatem*. And Becket's quarrel with the king hereupon was not on account of the exception (which was agreeable to the canon law), but of the general rule, that compelled the bishops to attend at all. And the determination of the house of

Stewart,
Stewart.

lords in the earl of Danby's case, which hath ever since been adhered to, is consonant to these constitutions; "that the lords spiritual have a right to stay and sit in court in capital cases, till the court proceeds to the vote of guilty or not guilty." It must be noted, that this resolution extends only to trials in full parliament; nor to the court of the lord high-steward (in which no vote can be given, but merely that of guilty or not guilty), no bishop, as such, ever was or could be summoned: and though the statute of King William regulates the proceedings in that court, as well as in the court of parliament, yet it never intended to new-model or alter its constitution; and consequently does not give the lords spiritual any right, in cases of blood, which they had not before. And what makes their exclusion more reasonable is, that they have no right to be tried themselves in the court of the lord high-steward, and therefore surely ought not to be judges there. For the privilege of being thus tried depends upon nobility of blood rather than a seat in the house, as appears from the trials of the popish lords, of lords under age, and (since the union) of the Scotch nobility, though not in the number of the sixteen; and from the trials of females, such as the queen consort or dowager, and of all peeresses by birth; and peeresses by marriage also, unless they have, when dowagers, disparaged themselves by taking a commoner to their second husband.

STEWART of the *Children Hundreds*. See *CHILTERN Hundreds*.

STEWART, DR MATTHEW, an eminent mathematician, was in 1717 born at Rothay in the isle of Bute, of which parish his father was minister. Being intended for the church, he went through the usual course of a grammar-school education, and was in 1734 received as a student into the university of Glasgow. There he had the happiness of having for his preceptors in moral science and in mathematics the celebrated professors Hutcheson and Simson; by the latter of whom he was instructed in what may not improperly be called the *arcana* of the ancient geometry.

Mr Stewart's views making it necessary for him to remove to Edinburgh, he was introduced by Dr Simson to Mr Maclaurin, that his mathematical studies might suffer no interruption; and he attended the lectures of that great master with such advantage as might be expected from eminent abilities, directed by the judgement of him who made the philosophy and geometry of Newton intelligible to ordinary capacities. Mr Stewart, however, had acquired, from his intimacy with Dr Simson, such a predilection for the ancient geometry, as the modern analysis, however powerfully recommended, could not lessen; and he kept up a regular correspondence with his old master, giving him an account of his progress and his discoveries in geometry, and receiving in return many curious communications respecting the *Loca Plani* and the porisms of Euclid. See *PORTER* and *STIMSON*.

While the second invention of porisms, to which more genius was perhaps required than to the first discovery of them, employed Dr Simson, Mr Stewart pursued the same subject in a different and new direction. In doing so, he was led to the discovery of those curious and interesting propositions which were published under the title of *General Theorems* in 1736. They were given without the demonstrations; but did not fail to place

their discoverer at once among the geometers of the first rank. They are for the most part porisms, though Mr Stewart, careful not to anticipate the discoveries of his friend, gave them no other name than that of theorems.

Our author had before this period entered into the church; and obtained, through the patronage of the duke of Argyll and the earl of Bute, the living of Hosenath, a retired country parish in the west of Scotland: but in 1747 he was elected to the mathematical chair in the university of Edinburgh, which had become vacant the year before by the death of Mr Maclaurin. The duties of this office gave a turn somewhat different to his pursuits, and led him to think of the most simple and elegant means of explaining those difficult propositions which were hitherto only accessible to men deeply versed in the modern analysis. In doing this, he was pursuing the object which of all others he most ardently wished to attain, viz. the application of geometry to such problems as the algebraic calculus alone had been thought able to resolve. His solution of Kepler's problem was the first specimen of this kind which he gave to the world; and it was impossible to have produced one more to the credit of the method he followed, or of the abilities with which he applied it. On this problem the utmost resources of the integral calculus had been employed. But though many excellent solutions had been given, there was none of them at once direct in its method and simple in its principles. Mr Stewart was so happy as to attain both these objects; and his solution appeared in the second volume of the *Essays* of the Philosophical Society of Edinburgh for the year 1756. In the first volume of the same collection there are some other propositions of Mr Stewart's, which are an extension of a curious theorem in the fourth book of Pappus. They have a relation to the subject of porisms, and one of them forms the gist of Dr Simson's Restoration. They are besides very beautiful propositions, and are demonstrated with all the elegance and simplicity of the ancient analysis.

The prosecution of the plan which he had formed of introducing into the higher parts of mixed mathematics the strict and simple form of ancient demonstration, produced the *Traacts Physical and Mathematical*, which were published in 1761, and the *Essay on the Sun's Distance*, which was published in 1763. In this last work it is acknowledged that he employed geometry on a task which geometry cannot perform; but while it is granted that his determination of the sun's distance is by no means free from error, it may safely be asserted that it contains a great deal which will always interest geometers, and will always be admired by them. Few errors in science are redeemed by the display of so much ingenuity, and what is more singular, of so much sound reasoning. The investigation is everywhere elegant, and will probably be long regarded as a specimen of the most arduous inquiry which has been attempted by mere geometry.

The *Sun's Distance* was the last work which Dr Stewart published; and though he lived to see several animadversions on it made public, he declined entering into any controversy. His disposition was far from polemical; and he knew the value of that quiet which a literary man should rarely suffer his antagonists to interrupt. He used to say, that the decision of the point

Account of
Dr Stewart
in the *Edinburgh
Philosophical
Transactions*,
vol. i.
by Mr
Playfair.

Stewart,
Stewart.

in question was now before the public; that if his investigation was right it would never be overturned, and that if it was wrong it ought not to be defended. A few months before he published the essay just mentioned, he gave to the world another work, intitled *Propositiones Geometricae More Veterum Demonstratae*. This title, it is said, was given to it by Dr Simson, who rejoiced in the publication of a work so well calculated to promote the study of the ancient geometry. It consists of a series of geometrical theorems for the most part new; investigated first by an analysis, and afterwards synthetically demonstrated by the inversion of the same analysis.

Dr Stewart's constant use of the geometrical analysis had put him in possession of many valuable propositions which did not enter into the plan of any of the works that have been enumerated. Of these not a few have found a place in the writings of Dr Simson, where they will for ever remain to mark the friendship of these two mathematicians, and to evince the esteem which Dr Simson entertained for the abilities of his pupil.

Soon after the publication of the *San's Distant*, Dr Stewart's health began to decline, and the duties of his office became burdensome to him. In the year 1772 he retired to the country, where he afterwards spent the greater part of his life, and never resumed his labours in the university. But though mathematics had now ceased to be his business, they continued to be his amusement till a very few years before his death, which happened on the 23d of January 1785, at the age of 68.

The habits of study, in a man of original genius, are objects of curiosity, and deserve to be remembered. Concerning those of Dr Stewart, his writings have made it unnecessary to remark, that from his youth he had been accustomed to the most intense and continued application. In consequence of this application, added to the natural vigour of his mind, he retained the memory of his discoveries in a manner that will hardly be believed. He rarely wrote down any of his investigations till it became necessary to do so for the purpose of publication. When he discovered any proposition, he would put down the enunciation with great accuracy, and on the same piece of paper would construct very neatly the figure to which it referred. To these he trusted for recalling to his mind at any future period the demonstration or the analysis, however complicated it might be. Experience had taught him, that he might place this confidence in himself without any danger of disappointment; and for this singular power he was probably more indebted to the activity of his invention than the mere tenaciousness of his memory. Though he was extremely studious, he read few books, and verified the observation of M. D'Alembert, that of all the men of letters, mathematicians read least of the writings of one another. His own investigations occupied him so efficiently; and indeed the world would have had reason to regret the misapplication of his talents, had he employed in the mere acquisition of knowledge that time which he could dedicate to works of invention.

STEWART, in *Scott Law*. See *LAW INDEX*.

STEWARTIA, a genus of plants belonging to the class monadelphica, and in the natural system ranging

under the 37th order, *Columnifera*. See *BOTANY* *Stebadiana*
Index. *Stemati-*
4.02.

STIBADIUM, among the Romans, a low kind of table couch or bed of a circular form, which succeeded to the triclinia, and was of different sizes, according to the number of guests for which it was designed. Tables of this kind were called *hexaclina*, *octaclina*, or *enecaclina*, according as they held six, eight, or nine guests, and so of any other number.

STIBIUM, a name for ANTIMONY.

STICHOS, a name given by the old writers to a pectoral confection, the principal ingredient of which was the herb *marrubium* or horehound.

STICKLEBACK, a genus of fishes. See *GASTEROSTEUS*. *ICHTHYOLOGY INDEX*.

STICKS, in *Printing*, slips of wood that lie between the foot of the page and the che's, to which they are wedged fast by the quins, to keep the form firm, in conjunction with the side-sticks, which are placed at the side of the page, and fixed in the same manner by means of quins.

STIFFLE, or GREAT MUSCLE, in the manege, is the part of the hind leg of a horse which advances towards his belly. This is a most dangerous part to receive a blow upon.

STIGMA, a brand or impression with a hot iron; a mark of infamy. See *STIGMATIZING*.

STIGMA, in *Botany*, the summit or top of the style, accounted by the sexualists the female organ of generation in plants, which receives the fecundating dust of the tops of the stamina, and transmits its vapour or effluvia through the style into the heart of the seed-bud, for the purpose of impregnating the seeds.

STIGMATA, in *Natural History*, the apertures in different parts of the bodies of insects communicating with the tracheae or air-vessels, and serving for the office of respiration.

STIGMATA, in antiquity, certain marks impressed on the left shoulders of the soldiers when listed.

STIGMATA, were also a kind of notes or abbreviations, consisting only of points, disposed various ways; as in triangles, squares, crosses, &c.

STIGMATA, is also a term introduced by the Franciscans, to express the marks or prints of our Saviour's wounds, said to have been miraculously impressed by him on the body of their seraphic father St Francis.

STIGMATIZING, among the ancients, was inflicted upon slaves as a punishment, but more frequently as a mark to know them by: in which case, it was done by applying a red-hot iron marked with certain letters to their foreheads, till a fair impression was made; and then pouring ink into their furrows, that the inscription might be the more conspicuous.

Soldiers were branded in the hand with the name or character of their general.

After the same manner, it was customary to stigmatize the worshippers and votaries of some of the gods. The marks used on these occasions were various; sometimes they contained the name of the god, sometimes his particular ensign, as the thunderbolt of Jupiter, the trident of Neptune, the ivy of Bacchus, &c. or they marked themselves with some mystical number, whereby the god's name was described. To these three ways of stigmatizing St John is supposed to refer (*Rev. chap. xiii. ver. 16, 17.*). Theodoret is of opinion, that the

Jews

Stigmatis-
ing
||
Stilling-
fleet.
* Lib. v.

Stilling-
fleet.

Jews were forbidden to brand themselves with stigmata, because the idolaters, by that ceremony, used to consecrate themselves to their false gods.

Among some nations, stigmatizing was considered as a distinguishing mark of honour and nobility. In Thrace, as Herodotus tells us *, it was practised by none but persons of credit, nor omitted by any but persons of the meanest rank. The ancient Britons are also said to have imprinted on the bodies of their infants the figures of animals, and other marks, with hot irons.

STIL DE GRAIN, in the colour trade, the name of a composition used for painting in oil or water, and is made of a decoction of the lycium or Avignon berry, in alum-water, which is mixed with whiting into a paste, and formed into twined sticks. It ought to be chosen of a fine gold yellow, very fine, tender, and friable, and free from dirt.

STILAGO, a genus of plants belonging to class gymnosandria. See BOTANY Index.

STILBE, a genus of plants belonging to the class polygamia, and order of dioecia. See BOTANY Index.

STILBITE, a species of mineral, or variety of zeolite. See ZEOLITE, MINERALOGY Index.

STILE, See STYLE.

STILL, the name of an apparatus used in chemistry for various purposes, and in the distillation of ardent spirits.

STILL-Bottoms, in the distillery, a name given by the traders to what remains in the still after working the wash into low wines. These bottoms are procured in the greatest quantity from the malt-wash, and are of so much value to the distiller in the fattening of hogs, &c. that he often finds them one of the most valuable articles of the business.

STILLINGFLEET, EDWARD, bishop of Worcester, was the son of Samuel Stillingfleet, gentleman, and was born at Cranborn in Dorsetshire in 1635. He was educated at St John's College, Cambridge; and having received holy orders, was, in 1657, presented to the rectory of Sutton in Nottinghamshire. By publishing his *Origines Sacrae*, one of the ablest defences of revealed religion that has ever been written, he soon acquired such reputation, that he was appointed preacher of the Bolls Chapel; and in January 1665 was presented to the rectory of St Andrew's, Holborn. He was afterwards chosen lecturer at the Temple, and appointed chaplain in ordinary to King Charles II. In 1668 he took the degree of doctor of divinity; and was soon after engaged in a dispute with those of the Romish religion, by publishing his discourse concerning the idolatry and fanaticism of the church of Rome, which he afterwards defended against several antagonists. In 1680 he preached at Guildhall chapel a sermon on Phil. iii. 26. which he published under the title of *The Mischief of Separation*; and this being immediately attacked by several writers, he in 1683 published his *Unreasonableness of Separation*. In 1685 appeared his *Origines Britannicae*, or the Antiquities of the British Church, in folio. During the reign of King James II. he wrote several tracts against popery, and was prolocutor of the convocation, as he had likewise been under Charles II. After the Revolution he was advanced to the bishopric of Worcester, and was engaged in a dispute with the Socinians, and also with Mr Locke; in which last contest he is generally thought to have been

unsuccessful. He died at Westminster in 1699, and was interred in the cathedral of Worcester, where a monument was erected to his memory by his son. Dr Stillingfleet wrote other works besides those here mentioned, which, with the above, have been reprinted in 6 vols. folio.

STILLINGFLEET, Benjamin, an ingenious naturalist, was grandson of the preceding. His father Edward was fellow of St John's College in Cambridge, F. R. S. M. D. and Gresham professor of physic; but marrying in 1692, he lost his lucrative offices and his father's favour; a misfortune that affected both himself and his posterity. However, going into orders, he obtained, by his father's means, the living of Newington-Butts, which he immediately exchanged for those of Wood-Norton and Swanton in Norfolk. He died in 1708.

Benjamin, his only son, was educated at Norwich school, which he left in 1720, with the character of an excellent scholar. He then went to Trinity-College in Cambridge, at the request of Dr Bentley, the master, who had been private tutor to his father, domestic chaplain to his grandfather, and much indebted to the family. Here he was a candidate for a fellowship, but was rejected by the master's influence. This was a severe and unexpected disappointment, and but little alleviated afterwards by the Doctor's apology, that it was a pity that a gentleman of Mr Stillingfleet's parts should be buried within the walls of a college.

Perhaps, however, this ingratitude of Dr Bentley was not of any real disservice to Mr Stillingfleet. By being thrown into the world, he formed many honourable and valuable connections. He dedicated some translations of Linnaeus to the late Lord Lyttleton, partly, he says, from motives of private respect and honour. Lord Barrington gave him, in a very polite manner, the place of the master of the barracks at Kensington; a favour to which Mr Stillingfleet, in the dedication of his Calendar of Flora to that nobleman, alludes with equal politeness, as well as with the warmest gratitude. His Calendar of Flora was formed at Stratton in Norfolk in the year 1755, at the hospitable seat of his very worthy and ingenious friend Mr Marsham, who had made several observations of that kind, and had communicated to the public his curious observations on the growth of trees. But it was to Mr Wyndham of Felbrig in Norfolk that he appears to have had the greatest obligations: he travelled abroad with him, spent much of his time at his house, and was appointed one of his executors (Mr Garrick was another), with a considerable addition to an annuity which that gentleman had settled upon him in his lifetime.

Mr Stillingfleet's genius seems, if we may judge from his works, to have led him principally to the study of natural history; which he prosecuted as an ingenious philosopher, an useful citizen, and a good man. In this walk of learning he mentions, as his friends, Dr Watson, Mr (afterwards Dr) Solander, Mr Hudson, Mr Price of Foxley, and some others; to whom may be added the ingenious Mr Pennant. Nor can we omit the flattering mention which Mr Gray makes of him in one of his letters, dated from London in 1761: "I have lately made an acquaintance with this philosopher, who lives in a garret here in the winter, that he may support some near relations who depend upon him. He is always employed, consequently (according to my old maxim)

Stilling-
fleet
Stilling-
fleet

maxim) always happy, always cheerful, and seems to me a very worthy honest man. His pleasant scheme is to send some persons, properly qualified, to reside a year or two in Attica, to make themselves acquainted with the climate, productions, and natural history of the country, that we may understand Aristotle, Euclid, Ptolemy, &c. who have been heathen Greek to us for so many ages; and this he has got proposed to Lord Bute, no unlikely person to put it in execution, as he is himself a botanist."

Mr Stillingfleet published a volume of miscellaneous tracts, which is in much esteem, and does great honour to his head and heart. They are chiefly translations of some essays in the *Annates Académiques*, published by Linnæus, interperfed with some observations and additions of his own. In this volume he shows also a taste for classical learning, and entertains us with some elegant poetical effusions of his own. But his Essay on Conversation, published in the first volume of Dutton's Collection of Poems, entitles him to a distinguished rank among our English poets. This poem is addressed to Mr Wyndham, with all that warmth of friendship which distinguishes Mr Stillingfleet. As it is chiefly didactic, it does not admit of so many ornaments as some compositions of other kinds. However, it contains much good sense, shows a considerable knowledge of mankind, and has several passages that in point of harmony and easy verification would not disgrace the writings of our most admired poets. Here more than once Mr Stillingfleet shows himself still more for Dr Bentley's cruel treatment of him; and towards the beautiful and moral close of it (where it is supposed he gives us a sketch of himself) seems to hint at a mortification of a more delicate nature, which he is said to have suffered from the other sex.

To these disappointments it was perhaps owing that Mr Stillingfleet neither married nor went into orders. His London residence was at a saddler's in Piccadilly; where he died in 1721, aged above 70, leaving several valuable papers behind him. He was buried in St James's church, without the slightest monument to his memory.

STILLINGIA, a genus of plants belonging to the class monœcia, and to the order of *monadelphæ*. See *BOTANY Indiv.*

STILYARD. See *STEEL-Yard*.

STILPO, a celebrated philosopher of Megara, flourished under the reign of Ptolemy Euergetes. In his youth he had been addicted to licentious pleasures, from which he religiously refrained from the moment that he ranked himself among philosophers. When Ptolemy Soter, at the taking of Megara, offered him a large sum of money, and requested that he would accompany him into Egypt, he accepted but a small part of the offer, and retired to the island of Ægina, whence, on Ptolemy's departure, he returned to Megara. That city being again taken by Demetrius the son of Antigonus, and the philosopher required to give an account of his effects which he had lost during the hurry of the plunder, he replied, that he had lost nothing; for no one could take from him his learning and eloquence. So great was the fame of Stilpo, that the most eminent philosophers of Athens took pleasure in attending upon his discourses. His peculiar doctrines were, that Ipe-

ties or universals have no real existence, and that one thing cannot be predicated of another. With respect to the former of these opinions, he seems to have taught the same doctrine with the sect afterwards known by the appellation of *Nominalists*. To prove that one thing cannot be predicated of another, he said, that *goodness and man*, for instance, are different things, which cannot be confounded by asserting the one to be the other: he argued farther, that goodness is an universal, and universals have no real existence; consequently since nothing cannot be predicated of any thing, goodness cannot be predicated of man. Thus, whilst this subtle Epicurian was, through his whole argument, predicating one thing of another, he denied that any one thing could be the accident or predicate of another. P. Stilpo was famous in this reasoning; if he meant any thing more than to expose the sophistry of the schools, he must be confessed to have been an eminent master of the art of wrangling; and it was not wholly without reason that Glycera, a celebrated courtesan, when she was reproved by him as a corrupter of youth, replied, that the charge might be justly started upon himself, who spent his time in filling their heads with sophistical quibbles and useless subtleties. In ethics he seems to have been a Stoic, and in religion he had a public and a private doctrine, the former for the multitude, and the latter for his friends. He admitted the existence of a supreme divinity, but had no reverence for the Grecian superstitions.

STILOBAÏUM, in *Architecture*, denotes the body of the pedestal of any column.

STILTON, a town of England, in Huntingdonshire, 75 miles from London, south-west of Yaxley, on the Roman highway from Caistor to Huntingdon, called *Emines Street*, some parts of which, in this neighbourhood, appear still paved with stone. This place is famous for cheese called *English Parmesan*, which is generally kept till it is old before it is brought to table, and even the process of decay is accelerated by various means, to render it agreeable to a vitiated taste. For making Stilton cheese, the following receipt is given in the first volume of the *Repository of Arts and Manufactures*:

"Take the night's cream, and put it to the morning's new milk, with the rennet: when the curd is come, it is not to be broken, as is done with other cheeses, but take it out with a bowl-dish altogether, and place it in a sieve to drain gradually; and as it drains, keep gradually pressing it till it becomes firm and dry; then place it in a wooden hoop; afterwards to be kept dry on boards, turned frequently, with cloth binders round it, which are to be tightened as occasion requires, and changed every day until the cheese become firm enough to support itself; after the cloth is taken off, the cheese is rubbed every day all over, for two or three months, with a brush; and if the weather be damp or moist twice a-day; and even before the cloth is taken off, the top and bottom are well rubbed every day."

STIMULANTS, in *Medicæ*, substances which increase the action of certain parts of the body. In particular, they quicken the motion of the blood, increase the action of the muscular fibres, and affect the nervous system.

STIMULI, in *Botany*, a species of armature or offensive weapon, with which some plants, as nettle, cassia,

de, acalypha, and tragia, are furnished. Their use, says Linnaeus, is by their venomous punctures to keep off naked animals that would approach to hurt them.

STING, an apparatus in the bodies of certain insects, in form of a little spear, serving them as a weapon of offence.

STING-Ray. See RALA, ICHTHOLOGY Index.

STINK-POT, an earthen jar or shell, charged with powder, grenades, and other materials of an offensive and suffocating smell. It is frequently used by privateers, in the western ocean, in the attack of an enemy whom he designs to board; for which purpose it is furnished with a light fuse at the opening or touch-hole. See BOARDING.

STINT, a species of bird. See TRINGA, ORNITHOLOGY Index.

STIPA, FEATHER GRASS, a genus of plants belonging to the class triandria, and order of digynia; and in the natural system ranging under the 4th order, Gramina. See BOTANY Index.

STIPEND, among the Romans, signifies the same with tribute; and hence *stipendarii* were the same with *tributarii*.

STIPEND, in Scots Law. See LAW, § cliv. 12.

STIPULA, in Botany, one of the fulera or proppes of plants, defined by Linnaeus to be a scale, or small leaf, stationed on each side the base of the footstalks of the flower and leaves, at their first appearance, for the purpose of support. Elmgren restricts it to the footstalks of the leaves only.

STIPULATION, in the civil law, the act of stipulating, that is, of treating and concluding terms and conditions to be inserted in a contract. Stipulations were anciently performed at Rome, with abundance of ceremonies; the first whereof was, that one party should interrogate, and the other answer, to give his consent, and oblige himself. By the ancient Roman law, nobody could stipulate but for himself; but as the tabelliones were public servants, they were allowed to stipulate for their masters; and the notaries succeeding the tabelliones have inherited the same privilege.

STIRIA, a province of Germany, in the circle of Austria, with the title of a duchy. It is bounded on the north by the archduchy of Austria, on the east by Hungary, on the south by Carinthia, and on the west by Carinthia and the archbishopric of Salzburg; it is 125 miles in length and 17 in breadth, and is said to contain 22 cities, 95 towns, 338 castles, 15 convents, and 200,000 inhabitants. Though it is a mountainous country, yet there is a great deal of land fit for tillage, and the soil is so good, that the inhabitants never were in want of corn. It contains mines of very good iron; whence the arms made there are in great esteem. The women differ greatly from the Austrians, and are very plain and ingenuous. They have all swellings on their throats, called *brachecoles*. The men are also very simple, and are rather disposed to indulge in indolence. The chief town is Graz.

STIRLING, a town of Scotland, situated on the river Forth, 33 miles north-west of Edinburgh, in W. Long. 3. 50. N. Lat. 56. 6. It is also called *Sterling* and *Striveling*; from the former of which Boethius falsely derives the name *Sterling money*; because, says he, Otho I. a Saxon prince, after the overthrow of the Scots, established a mint there. The name of *Striveling* is said

to have been derived from the frequency of strikes or conflicts in the neighbourhood. The town contains about 4000 inhabitants. It has a manufacture of tartans and shalloons, and employs about 30 looms in that of carpets. The great street is very broad. In it is the tolbooth, where is kept the standard for the wet measures of Scotland. The other streets are narrow and irregular.—Stirling is in miniature a resemblance of Edinburgh; being built on a rock of the same form, with a fortress on the summit. The origin of the castle is unknown. The rock of Stirling was strongly fortified by the Picts, amongst whom architecture and several other useful arts had made a considerable progress. As it lay in the extremities of their kingdom, the possession of it was the occasion of frequent contentions betwixt them and their neighbours the Scots and Northumbrians; each of whose dominions did, for some time, terminate near it.

When the Scots, under Kenneth II. overthrew the Pictish empire near the middle of the ninth century, they endeavoured to obliterate every memorial of that people. They not only gave new names to provinces and towns, but, with all the rage of barbarians, demolished many magnificent and useful edifices which had been reared up by them, and this fortress among the rest. It was, however, soon rebuilt, though upon an occasion not very honourable to the Scots.

Upon the death of Kenneth II. in 855, his brother Donald V. mounted the throne of Scotland. In the beginning of his reign the kingdom was invaded by Othrecht and Ella, two Northumbrian princes, who, uniting their forces with the Cumbrian Britons, and a number of Picts, who upon their expulsion from their native country had taken refuge in England, advanced to Jedburgh, where Donald encountered them; and, after a fierce and bloody battle, obtained a complete victory; but, having taken up his station in Berwick, in supreme security, the Northumbrians, informed of the careless posture in which the Scottish army lay, surprised them by a hasty march, dispersed them, and made a prisoner of the king. Pursuing the advantage they had gained, they marched northward, and subdued all before them to the fifth of Forth and the town of Stirling. But the forlorn situation of the Scots, without a king and without an army, obliging them to sue for peace, they obtained it, upon condition that they should pay a sum of money for the ransom of the king, and yield up all their dominions upon the fourth side of the Forth to the conquerors.

The Northumbrians taking possession of the territories ceded to them by this treaty, rebuilt the castle of Stirling, and planted it with a strong garrison, in order to preserve their new conquests, upon the frontiers of which it was situated. Our authorities also inform us, that they erected a stone bridge over the Forth, upon the summit of which a cross was raised, with the following inscription in monkish rhyme.

*Anglos a Scotis separat crux ista remotis;
Armis hic stant Bruti, Scoti stant hic, cruce tuti.*

Which is thus translated by Bellenden.

I am free marche, as passer-geris may ken,
To Scotis, to Britons, and to Inglisken.

None of the ancient English historians mentions this conquest. The whole story, as well as the inscription,

Stirling

wears much of a monkish garb; yet its authenticity is not a little confirmed by the arms of the town of Stirling, upon which is a bridge, with a cross, and the Latin line of the above Latin Dutch is the motto round it.

We must not, however, imagine, that in those times that fortress bore any resemblance to the present structure, which is adapted to the use of fire-arms. Its size and form probably resembled those castles which, under the feudal constitution, the English and Scottish barons used to erect upon their estates for dwelling-houses; and which, in those barbarous ages, they found necessary to fortify for their defence, not only against foreign invaders, but often against the attacks of their own neighbours. It is directly such a Gothic figure as this which represents the *Castrum Striv. lense* upon the arms of Stirling.

This fortress, after it had continued in the possession of the Northumbrian Saxons about 20 years, was, together with the whole country upon the south side of the Forth, restored to the Scot, upon condition of their assisting the Saxons against their turbulent invaders the Danes. Upon the arms of Stirling are two branches of a tree, to represent the *Nemus Striv. lense*; but the situation and boundaries of that forest, which was probably a wing of the Caledonian, cannot be ascertained. Upon the south of Stirling, vestiges of a forest are still discernible for several miles. Banks of natural timber fill remain in the cattle park, at Murray's wood, and near Nether Bannockburn; and stumps of trees, with much brushwood, are to be seen in all the adjacent fields.

When Kenneth III. received intelligence of the Danes having invaded his dominions, he appointed the castle of Stirling to be the place of rendezvous for his army; and he marched from thence to the battle of Luncarty, where he obtained a victory over those rovers, in the end of the 10th century.

In the 12th century, this castle is spoken of as a place of great importance, and one of the strongest fortresses in the kingdom. In 1174, a calamity, not unusual amongst the Scottish monarchs, befel William, who at that time occupied the throne. He was taken prisoner in an unsuccessful expedition which he made into England; and, after having been detained 12 months in captivity, was released, upon stipulating to pay a large sum of money for his ransom; and, until payment thereof, delivering into the hands of the English the four principal fortresses in the kingdom, which in those days were Stirling, Edinburgh, Roxburgh, and Berwick. This was the first great advantage that England obtained over Scotland; and indeed the most important transaction which had passed between these kingdoms from the Norman conquest.

Though the Scottish monarchs, in their frequent peregrinations through the kingdom, often visited Stirling, and held their courts for some time in the castle; yet it did not become a royal residence till the family of Stuart mounted the throne, and it was from different princes of this family that it received its present form. It was the place of the nativity of James II.; and, when refused to the throne, he frequently kept his court in it. It is well known to have been the place where that prince perpetrated an atrocious deed, the murder of William earl of Douglas, whom he stabbed with his own hand. The royal apartments were at that time in the north-west

corner of the castle, and are now the residence of the fort-major. The room where the murder was committed still goes by the name of *D'uglas's room*.

James III. contracting a fondness for the castle on account of its pleasant situation, made it the chief place of his residence, and added several embellishments to it. He built within it a magnificent hall, which in those days was deemed a noble structure, and is still entire. It now goes by the name of the *parliament-house*, having been designed for the accommodation of that supreme court. It was covered with an osken roof of exquisite workmanship, which, though very little decayed, was a few years ago removed to make way for one of more modern structure. James also erected a college of secular priests in the castle, which he called the *chapel royal*, and which proved one cause of his own ruin. As the expences necessary for maintaining the numerous officers of such an institution were considerable, he annexed to it the revenues of the rich priory of Coldingham in the Merse, which at that time happened to become vacant. This priory had for a long time been held by persons connected with the family of Hume; and that family, considering it as belonging to them, strongly opposed the annexation. The dispute seems to have lasted several years; for one parliament had passed a vote, annexing the priory to the chapel-royal, and a subsequent one enacted a statute prohibiting every attempt that was contrary or prejudicial to that annexation.

James V. was crowned in the castle of Stirling; and the palace, which is the chief ornament of it, was the work of that prince. This is a stately and commodious structure, all of hewn stone, with much statuary work upon it. It is built in form of a square, with a small court in the middle, in which the King's lions are said to have been kept; and hence it still goes by the name of the *lions den*. The palace contains many large and elegant apartments; the ground-floor is now converted into barrack-rooms for the soldiers of the garrison; the upper affords a house for the governor, with lodgings for some of the subaltern officers.

Opposite to the palace, upon the north, stands an elegant chapel, which was built by James VI. for the baptism of his son, Prince Henry, in 1594. In this chapel is preserved the hulk of a large boat, which that whimsical monarch caused to be built and placed upon carriages, in order to convey into the castle the provisions for that solemnity.

A strong battery, with a tier of guns pointing to the bridge over the Forth, was erected during the regency of Mary of Lorraine, mother to Queen Mary. It is called the *French battery*, probably because constructed by engineers of that nation. The first addition was made to the fortifications in the reign of Queen Anne. Formerly they reached no farther than the old gate, upon which the flag-staff now stands: but in that reign they were considerably enlarged upon the side towards the town; and barracks, which are bomb-proof, with several other conveniences for a siege, were erected.

Upon the south side of the castle lies a park inclosed with a stone-wall, called the *king's park*, and near to the foot of the rock on which the castle stands, by the royal gardens; vestiges of the walks and parterres, with a few stumps of fruit-trees, are still visible; but by long neglect, and the natural weight of the soil, the place is

Stirling

Stirling,
Stirling-
shire.

now little better than a marsh. In the gardens is a mound of earth in form of a table, with benches of earth around it, where, according to tradition, the court sometimes held *jeux-champêtres*. In the castle-hill is an hollow, comprehending about an acre of ground, and having all the appearance of an artificial work, which was used for jousts, tournaments, and other feats of chivalry.

Northward of the castle lies the Govan, or perhaps more properly the *Gowling* hill (A); in the middle of which is a final mound called *Hurly Haaby*, upon which Duke Murdoch and his two sons were executed for treasonable practices in the reign of James I.

The prospect from the castle is most delightful, as well as extensive, being greatly beautified, especially upon the east, by the windings of the Forth; which are so numerous, that though the distance by land from Stirling to Alloa is, in a straight line, not quite six miles, it is said to be 24 by water. As this river generally runs upon plain ground, it rolls its stream in so slow and silent a manner, that what Silus Italicus saith of the Ticius is applicable to it, if, instead of *locenti* in that poet, we should read *lucifo*; for the clay-banks, together with the tide, which flows above Stirling, render the Forth perpetually muddy:

*Vix credas lali, ripis tam mitis opacis
Sonniferam ducit latulo gurgite lympham.*

The lordship and castle of Stirling were a part of the usual dowry of the queens of Scotland, at least after the family of Stuart came to the throne, in which they were invested at their marriage.

Robert lord Falkine was appointed governor of the castle by King David II. and the office continued in that family till 1715.

This fortress hath been the scene of many transactions. Being by its situation considered as a key to the northern parts of the kingdom, the possession of it hath been always esteemed of great importance to those who fought to be masters of Scotland. It was undoubtedly a place of strength when the art of war by ordinance was in its infancy; but though it resisted the utmost efforts of the rebels in 1746, it could not now hold out three days if besieged by an army of a few thousand men conducted by an engineer of knowledge and industry.

STIRLINGSHIRE, a county of Scotland, of which Stirling is the capital. It extends 20 miles in length and 12 in breadth; being bounded on the west by part of Lennox and Clydesdale; on the east, by Clackmannanshire, the river Forth, and part of Lothian; on the south east, by Lothian; and on the north by Montebath. The face of the country is open and agreeable, diversified by hill and dale, well watered with streams and rivers; the principal of which is the Forth, rising in the neighbourhood of a high mountain called *Pen Lo-mond*, and, running eastward, forms the firth of Edinburgh. The southern part is hilly, affording plenty of game, and pasture for sheep, horses, and black cattle. The eastern part is fertile, producing plentiful harvests of corn, and great abundance of coal. Lead-ore is found

in different parts of the county; and the rivers abound with pike, trout, and salmon.

The population of this county at two different periods, and according to the different parishes, will be seen in the following table:

| Parishes. | Population in 1755. | Population in 1795. |
|----------------------|---------------------|---------------------|
| Alth | 2316 | 2350 |
| Alva | 436 | 612 |
| Baldernock | 621 | 620 |
| Balfron | 755 | 1381 |
| 5 Borkennar | 529 | 600 |
| Buchanan | 1699 | 1111 |
| Campsie | 1399 | 2517 |
| Denny | 1392 | 1400 |
| Drymen | 2789 | 1607 |
| 10 Falkirk | 3932 | 3020 |
| Fentry | 891 | 543 |
| Gargunnock | 936 | 850 |
| Kilsrenn | 939 | 573 |
| Killyth | 1395 | 2450 |
| 15 Kippen | 1799 | 1777 |
| Laibert and Danipace | 1864 | 4000 |
| Muiravonside | 1339 | 1065 |
| Polmont | 1594 | 1400 |
| St Ninians | 6491 | 7079 |
| 20 Strathmannan | 1009 | 1010 |
| Stirling | 3951 | 4693 |
| Strathblane | 797 | 620 |
| | <hr/> | <hr/> |
| | 38,813 | 46,663 |
| | | 38,813 |

Increase, 7850*

* Statist.
Hist. of
Scotland.

STIRBUP, in the manege, a rest or support for the horseman's foot, for enabling him to mount, and for keeping him firm in his seat.

Stirrups were unknown to the ancients. The want of them in getting upon horseback was supplied by agility or art. Some horses were taught to stoop to take their riders up; but the riders often leapt up by the help of their spears, or were assisted by their slaves, or made use of ladders for the purpose. Græculus filled the highways with stones, which were intended to answer the same end. The same was also required of the conveyors of the roads in Greece as part of their duty.

Ménage observes, that St Jerome is the first author who mentions them. But the passage alluded to is not to be found in his epistles; and if it were there, it would prove nothing, because St Jerome lived at a time when stirrups are supposed to have been invented, and after the use of saddles. Montfaucon denies the authenticity of this passage; and, in order to account for the ignorance of the ancients with regard to an instrument so useful and so easy of invention, he observes, that while cloths and housings only were laid upon the horses backs, on which the riders were to sit, stirrups could not have been used, because they could not have been fastened with the same security as upon a saddle. But it is

more

(A) So called from the wallings and lamentations (in Scotch, *gowling*) that were made for Duke Murdoch.

Sfirrup more probable, that in this instance, as in many others, the progress of human genius and invention is a certain and slow, depending frequently upon accidental causes.

Sfirrup of a Ship, a piece of timber put upon a ship's keel, when some of her keel happens to be broken off, and they cannot come conveniently to put or fit in a new piece; then they patch in a piece of timber, and bind it on with an iron, which goes under the ship's keel, and comes up on each side of the ship, where it is nailed strongly with spikes; and this they call a *sfirrup*.

STOBÆUS, Jotus, a laborious Greek writer, who lived at the end of the fourth century, composed many works, of which there are only his Collections remaining, and even these are not as he composed them; many things being inserted by later authors. This work contains many important sentiments collected from the ancient writers, poets, and philosophers.

STOCK, in gardening, &c. the stem or trunk of a tree. What stock is most proper for each kind of fruit, ought as well to be considered and known, as what soil is most suitable to trees; for on these two things the future vigour of trees, and the goodness of fruit, equally depend. The best way for those who intend to plant, is to raise their own stocks, by which they will be better assured of what they do; but if they should buy their trees of nurserymen, they should diligently inquire upon what stocks they were propagated. See *GRAFTING*.

STOCK, in trade. See *CAPITAL SAKE*.

STOCK-BROKER. See *BROKER* and *STOCKS*.

STOCK-DIEB. See *COLUMBA*, *ORNITHOLOGY Indiv.*

STOCK-Jobbing, the art or mystery of trafficking in the public stocks or funds. See *FUND* and *Stock-Jobbing*.

STOCK Gillyflower. See *CHEIRANTHUS*, *BOTANY Indiv.*

STOCKHOLM, the capital of Sweden, is situated in the province of Uppland, in E. Long. 19. 30. and N. Lat. 59. 20. Its foundation is by the best Swedish writers generally attributed to Birger Jarl, regent of the kingdom about the middle of the 13th century during the minority of his son Waldemar, who had been raised to the throne by the states of the kingdom; but it was not before the 18th century that the royal residence was transferred from Upsala to this city.

This capital, which is very long and irregular, occupies, besides two peninsulas, seven small rocky islands, scattered in the Meälar. In the streams which issue from that lake, and in a bay of the gulf of Bothnia. A variety of conical and enchanting views are formed by numberless rocks of granite rising baldly from the surface of the water, on dry bare and craggy, partly dotted with houses, or feathered with wood. The harbour is an inlet of the Baltic: the water is clear as crystal, and of such depth that ships of the largest burthen can approach the quay, which is of considerable breadth, and lined with spacious buildings and ware houses. At the extremity of the harbour several forts rise one above another in the form of an amphitheatre; and the palace, a magnificent building, crowns the summit. Towards the sea, about two or three miles from the town, the harbour is contracted into a narrow strait, and, winding among high rocks, disappears from the sight; and the prospect is terminated by distant hills, overspread with

forest. It is far beyond the power of words, or of the Stockholm pencil, to delineate these singular views. The central island, from which the city derives its name, and the Rittsholm, are the handfast parts of the town. Excepting in the suburbs, where the houses are of wood painted red, the generality of the buildings are of stone, or brick intercoloured white. The royal palace, which stands in the centre of Stockholm, and upon the highest spot of ground, was begun by Charles XI.: it is a large quadrangular stone edifice, and the style of architecture is both elegant and magnificent.

It is the habitation not only of the royal family, but also of the greater part of the officers belonging to the household. It likewise comprehends the national or supreme court of justice, the colleges of war, chancery, treasury, and commerce; a chapel, armoury, library, and office for the public records; but the greater number of inferior officers and servants belonging to the court, are, with the foot-guards, quartered on the burghers. The castle, and all the stately edifices in the kingdom, are covered with copper. The palace of the nobility, in which this order sits during the session of the diet, is an elegant building adorned on the outside with marble statues and columns, and on the inside with painting and sculpture. This and three other palaces stand on the banks of the lake, and are built on the same model, as to compose an uniform piece of architecture. The bank, built at the expense of the city, is a noble edifice, and joins with many sumptuous houses belonging to the nobility in exhibiting a splendid appearance. The houses of the burghers are generally built of brick in the city; but in the suburbs they are commonly made up of timber, and therefore very subject to conflagrations. Their houses are often framed in Finland, according to the plan and dimensions preferred: whence they are transported in pieces to Stockholm by water, and there fit up by the carpenters. These wooden habitations, if kept in proper repair, will last 30 or 40 years, and are deemed warmer, neater, and more healthy, than those of brick or stone. To prevent the danger of conflagrations, the city is divided into 12 wards. In each of these there is a master and four assistants, who forthwith repair to the place where the fire breaks out; and all porters and labourers are obliged to range themselves under the mark of the ward to which they belong. A fire-watch patrols the streets by night, to give warning or assistance as it may be wanted; and a centinel is maintained in the steeple of every church, to toll the bell on the first appearance of any such accident. The police of Stockholm is entirely subjected to the regulations of the grand governor, assisted by a deputy and bailiff of the castle. This city is the emporium of Sweden, to which all the commodities of the kingdom are brought for exportation, and where almost all the imports from abroad are deposited. The port or haven formed by the lake Meälar is large enough to contain 1000 sail of shipping; and furnished with a key or wharf about an English mile in length, to which the vessels may lie with their broadsides. The greatest inconveniences attending this situation are, the distance from the sea, which is not within less than 12 miles of the town; the want of tides; and the winding of the river, which is remarkably crooked. It opens into the Baltic; and the entrance, which is dangerous and rocky, the Swedes have secured with two small forts: within, it is perfectly safe and com-

Stocks. The northern suburbs are remarkable for the king's gardens, and for the great number of artificers who have chosen their habitations in this quarter. In the southern suburbs the Muscovite commodities are sold; and here is a magnificent exchange where the merchants daily assemble. Population 85,000.

STOCKING, that part of the clothing of the leg and foot which immediately covers and screens them from the rigour of the cold. Anciently, the only stockings in use were made of cloth, or of milled stuffs sewed together; but since the invention of knitting and weaving stockings of silk, wool, cotton, thread, &c. the use of cloth stockings is quite discontinued. Dr Howel, in his History of the World (vol. ii. p. 222.) relates, that Queen Elizabeth, in 1521, was presented with a pair of black knit silk stockings by her silk-woman, and thenceforth the rever wore cloth ones any more. The same author adds, that King Henry VIII. ordinarily wore cloth hose, except there came from Spain, by great chance, a pair of silk stockings. His son, King Edward VI. was presented with a pair of long Spanish silk stockings by Sir Thomas Gresham, and the present was then much taken notice of. Hence it should seem, that the invention of silk knit stockings originally came from Spain. Others relate, that one William Rider, an apprentice on London bridge, seeing at the house of an Italian merchant a pair of knit worsted stockings from Mantua, took the hint, and made a pair exactly like them, which he presented to William earl of Pembroke, and that they were the first of that kind worn in England, anno 1564.

The modern stockings, whether woven or knit, are formed of an infinite number of little knots, called *itches*, *le ys*, or *ryshes*, intermingled in one another.

Knit stockings are wrought with needles made of polished iron or brass wire, which interweave the threads and form the meshes the stocking consists of. At what time the art of knitting was invented it is perhaps impossible to determine, though it has usually been attributed to the Scots, as it is said that the first works of this kind came from Scotland. It is added, that it was on this account that the company of stocking-knitters, established at Paris 1527, took for their patron St Fiacre, who is said to have been the son of a king of Scotland. But it is most probable that the method of knitting stockings by wires or needles was first brought from Spain.

Woven stockings are generally very fine; they are manufactured on a frame or machine made of polished iron, the structure of which it is needless to describe, as it may be seen in almost every considerable town in Great Britain. The invention of this machine is, by Mr Anderson, attributed to William Lee, M. A. of St John's College, Cambridge, at a period so early as 1589. Others have given the credit of this invention to a student of Oxford at a much later period, who, it is said by Aaron Hill*, was driven to it by dire necessity. This young man, falling in love with an innkeeper's daughter, married her though he had not a penny, and he by his marriage lost a fellowship. They soon fell into extreme poverty; and their marriage producing the consequences naturally to be expected from it, the amorous pair became miserable, not so much on account of their sickness, as from the melancholy dread of what would become of their yet unborn infant.

Their only means of support were the knitting of stockings, at which the woman was very expert: "But sitting constantly together from morning to night, and the scholar often fixing his eyes, with sedate observation, on the motion of his wife's fingers in the dexterous management of her needles, he took it into his imagination, that it was not impossible to contrive a little loom which might do the work with much more expedition. This thought he communicated to his wife, and joining his head to her hands, the endeavour succeeded to their will. Thus the ingenious stocking-loom, which is so common now, was first invented; by which he did not only make himself and his family happy, but has left his nation indebted to him for a benefit which enables us to export silk stockings in great quantities, and to a vast advantage, to those very countries from whence before we used to bring them at considerable loss in the balance of our trade."

STOCKS, or PUBLIC FUNDS in England. By the word *stock* was originally meant a particular sum of money contributed to the establishing a fund to enable a company to carry on a certain trade, by means of which the person became a partner in that trade, and received a share of the profit made thereby, in proportion to the money employed. But this term has been extended farther, though improperly, to signify any sum of money which has been lent to the government, on condition of receiving a certain interest till the money is repaid, and which makes a part of the national debt. As the security both of the government and of the public companies is esteemed preferable to that of any private person, as the stocks are negotiable and may be sold at any time, and as the interest is always punctually paid when due; so they are thereby enabled to borrow money on a lower interest than what could be obtained from lending it to private persons, where there must be always some danger of losing both principal and interest.

But as every capital stock or fund of a company is raised for a particular purpose, and limited by parliament to a certain sum, it necessarily follows, that when that fund is completed, no stock can be bought of the company; though shares already purchased may be transferred from one person to another. This being the case, there is frequently a great disproportion between the original value of the shares and what is given for them when transferred: for if there are more buyers than sellers, a person who is indifferent about selling will not part with his share without a considerable profit to himself; and on the contrary, if many are disposed to sell, and few inclined to buy, the value of such shares will naturally fall in proportion to the impotence of those who want to turn their stock into specie.

A stock may likewise be affected by the court of chancery: for if that court should order the money, which is under their direction, to be laid out in any particular stock, that stock, by having more purchasers, will be raised to a higher price than any other of the like value.

By what has been said, the reader will perceive how much the credit and interest of the nation depends on the support of the public funds. While the annuities and interest for money advanced is there regularly paid, and the principal insured by both prince and people (a

security

* See the
History of
the Rise
and Pro-
gress of
the Stock
in En-
gland, &c.
1727, 281.

Stocks security not to be had in other nations; foreigners will lend us their property, and all Europe be interested in our welfare: the paper of the companies will be converted into money and merchandise, and Great Britain can never want cash to carry her schemes into execution. See the article **FUND**.

STOCKS, a frame erected on the shore of a river or harbour, whereon to build shipping. It generally consists of a number of wooden blocks, ranged parallel to each other, at convenient distances, and with a gradual declivity towards the water.

STOCKS, a wooden machine to put the legs of offenders in, for securing disorderly persons, and by way of punishment in divers cases, ordained by statute, &c.

STOCKTON upon Tees, a handsome town in the county of Durham, about 16 miles south of the city of Durham. It is now a port of considerable trade; though, at the restoration, it was a despicable village, the best house in which could hardly boast of any thing better than clay-walls and a thatched roof. About 40 years ago it sent out in one year 75 vessels for the port of London: and the trade is much increased since.

STOEBE, **BASTARD ÆTHIOPIAN**, a genus of plants belonging to the class *syngenesia*; and in the natural system ranging under the 49th order *complicata*. See **BOTANY Index**.

STOKESIA, a genus of plants belonging to the *syngenesia* class, and order of *polygamia aequalis*. The corollets in the ray are disposed in the shape of a funnel, and are long and irregular. The down is four-billed, and the receptacle is naked. One species only is known, which is a herbaceous plant, and a native of South Carolina.

STOICS, the name given to a sect of Grecian philosophers, from *Στεῖς*, "the porch in Athens," which the founder of the sect chose for his school. For the peculiar tenets of this sect, see **METAPHYSICS**, Chap. iv. Part 3. **MORAL PHILOSOPHY**, n^o 8. and **ZENO**.

STOLBERG, a small town of Germany, in the circle of Upper Saxon, and territory of Thuringia, of which it is the capital place. It is situated between two mountains, 50 miles north-west of Leipzig. E. Long. 11. 8. N. Lat. 51. 42.

STOLE, a sacerdotal ornament worn by the Romish parish priests above their surplice, as a mark of superiority in their respective churches; and by other priests over the alb, at celebrating of mass, in which case it goes across the stomach; and by deacons, over the left shoulder, fear-wife: when the priest reads the gospel for any one, he lays the bottom of his stole on his head. The stole is a broad sash, or slip of stuff, hanging from the neck to the feet, with three crosses thereon.

Green of the STOLE, the eldest gentleman of his Majesty's bedchamber, whose office it is to present and put on his Majesty's first garment, or shirt, every morning, and to order the things in the chamber.

STOMACH, in *Anatomy*. See **ANATOMY**, n^o 91.

STOMACHIC MEDICINES are such as strengthen the stomach and promote digestion, &c.

Stomachic corroboratives are such as strengthen the tone of the stomach and intestines; among which are cuminatives, as the roots of galengals, red gentian, zedoary, pimpinella, cibus aromaticus, and arum. Oil barks and rinds, those of cassia alba, sandal, citrus,

Stville and China oranges, &c. Of spice, pepper, ginger, cloves, cinnamon, cardamum, and mace.

STOMOXYS, a genus of insects belonging to the order of diptera. See **ENTOMOLOG**, p. 214.

STONE, **EDMUND**, a distinguished self-taught mathematician, was born in Scotland; but neither the place nor the time of his birth is well known; nor have we any memoirs of his life, except a letter from the Chevalier de Raoulay, author of the *Travels of Cyrus*, in a letter to Father Cattel, a Jesuit at Paris, and published in the *Memoirs de Trevoux*, p. 129, as follows: "True genius overcomes all the disadvantages of birth, fortune, and education; of which Mr Stone is a rare example. Born a son of a gardener of the duke of Argyle, he arrived at eight years of age before he learnt to read.—

By chance a servant having taught young Stone the letters of the alphabet, there needed nothing more to discover and expand his genius. He applied himself to study, and he arrived at the knowledge of the most sublime geometry and analysis, without a master, without a conductor, without any other guide but pure genius.

"At 18 years of age he had made these considerable advances without being known, and without knowing himself the prodigies of his acquisitions. The duke of Argyle, who joined to his military talents a general knowledge of every science that adorns the mind of a man of his rank, walking one day in his garden, lay lying on the grass a Latin copy of Sir Isaac Newton's celebrated *Principia*. He called some one to him to take and carry it back to his library. Our young gardener told him that the book belonged to him. 'To you?' replied the duke. 'Do you understand geometry, Latin, Newton?' I know a little of them, replied the young man with an air of simplicity arising from a profound ignorance of his own knowledge and talents. The duke was surprised; and having a taste for the sciences, he entered into a conversation with the young mathematician: he asked him several questions, and was astonished at the force, the accuracy, and the candour of his answers. 'But how (said the duke) came you by the knowledge of all these things?' Stone replied, 'A servant taught me, ten years since, to read: Does one need to know any thing more than the 24 letters in order to learn every thing else that one wishes?' The duke's curiosity redoubled—He sat down upon a bank, and requested a detail of all his proceedings in becoming so learned.

"I first learned to read, said Stone: the masons were then at work upon your house: I went near them one day, and I saw that the architect used a rule, compasses, and that he made calculations. I inquired what might be the meaning and use of these things; and I was informed that there was a science called Arithmetic: I purchased a book of arithmetic, and I learned it.—I was told there was another science called Geometry: I bought the books, and I learnt geometry. By reading I found that there were good books in these two sciences in Latin: I bought a dictionary, and I learned Latin. I understood also that there were good books of the same kind in French: I bought a dictionary, and I learned French. And this, my lord, is what I have done: it seems to me that we may learn every thing when we know the 24 letters of the alphabet."

"This account charmed the Duke. He drew this

was added

Stone

wonderful genius out of his obscurity; and he provided him with an employment which left him plenty of time to apply himself to the sciences. He discovered in him also the same genius for music, for painting, for architecture, for all the sciences which depend on calculations and proportions."

"I have seen Mr Stone. He is a man of great simplicity. He is at present sensible of his own knowledge; but he is not puffed up with it. He is possessed with a pure and disinterested love for the mathematics, though he is not solicitous to pass for a mathematician; vanity having no part in the great labour he sustains to excel in that science. He despises fortune also; and he has solicited me twenty times to request the duke to give him less employment, which may not be worth the half of that he now has, in order to be more retired, and less taken off from his favourite studies. He discovers sometimes, by methods of his own, truths which others have discovered before him. He is charmed to find on these occasions that he is not a first inventor, and that others have made a greater progress than he thought. Far from being a plagiarist, he attributes ingenious solutions, which he gives to certain problems, to the hints he has found in others, although the connection is but very distant." &c.

Mr Stone was author and translator of several useful works; viz. 1. A New Mathematical Dictionary, in 1 vol. 8vo, first printed in 1726. 2. Fluxions, in 1 vol. 8vo, 1730. The Direct Method is a translation from the French, of Hospital's *Analyse des Infiniment Petits*; and the Inverse Method was supplied by Stone himself. 3. The Elements of Euclid, in 2 vols. 8vo, 1731. A neat and useful edition of those Elements, with an account of his life and writings of Euclid, and a defence of his Elements against modern objections. Beside other smaller works. Stone was a fellow of the Royal Society, and had inserted in the *Philosophical Transactions* (vol. xli. p. 218), an "Account of two species of lines of the 3d order, not mentioned by Sir Isaac Newton or Mr Stirling."

STONE, *Jerome*, the son of a reputable farmer, was born in the parish of Scoonie, in the county of Fife, North Britain. His father died abroad when he was but three years of age, and his mother, with her young family, was left in very narrow circumstances. Jerome, like the rest of the children, having got the ordinary school education, reading English, writing, and arithmetic, betook himself to the business of a travelling chapman. But the dealing in buckles, garters, and such small articles, not suiting his superior genius, he soon converted his little stock into books, and for some years went through the country, and attended the fairs as an itinerant bookseller. There is great reason to believe that he engaged in this new species of traffic, more with a view to the improvement of his mind than for any pecuniary emolument. Formed by nature for literature, he possessed a peculiar talent for acquiring languages with amazing facility. Whether from a desire to understand the Scriptures in their original languages, or from being informed that these languages are the parents of many others, he began his philological pursuits with the study of the Hebrew and Greek tongues; and, by a wonderful effort of genius and application, made himself so far master of these, without any kind of assistance, as to be able to interpret the

Hebrew Bible and Greek Testament into English *ad aperturam libri*. At this time he did not know one word of Latin. Sensible that he could make no great progress in learning, without the knowledge of at least the grammar of that language, he made application to the parish schoolmaster for his assistance. Some time afterwards, he was encouraged to prosecute his studies at the university of St Andrews. An unexampled proficiency in every branch of literature recommended him to the esteem of the professors; and an uncommon fund of wit and pleasantry rendered him, at the same time, the favourite of all his fellow students, some of whom speak of him to this day with an enthusiastic degree of admiration and respect. About this period some very humorous poetical pieces of his composition were published in the *Scots Magazine*. Before he had finished his third session, or term, at St Andrews's, on an application to the college by the master of the school of Dunkeld for an usher, Mr Stone was recommended as the best qualified for that office; and about two or three years after, the matter being removed to Perth, Mr Stone, by the favour of his Grace the Duke of Atholl, who had conceived a high opinion of his abilities, was appointed his successor.

When he first went to Dunkeld, he entertained but an unfavourable opinion of the Gaelic language, which he considered as nothing better than a barbarous inarticulate gibberish; but being bent on investigating the origin and descent of the ancient Scots, he suffered not his prejudices to make him neglect the study of their primitive tongue. Having, with his usual assiduity and success, mastered the grammatical difficulties which he encountered, he set himself to discover something of the true genius and character of the language. He collected a number of ancient poems, the production of Irish or Scottish bards, which, he said, were daring, innocent, passionate, and bold. Some of these poems were translated into English verse, which several persons now alive have seen in manuscript, before Mr Macpherson published any of his translations from Ossian.

He died while he was writing and preparing for the press a treatise, intitled, "An Inquiry into the Origin of the Nation and Language of the ancient Scots, with Conjectures about the Primitive State of the Celtic and other European Nations;" an idea which could not have been conceived by an ordinary genius. In this treatise he proves that the Scots drew their original, as well as their language, from the ancient Gauls. Had Mr Stone lived to finish this work, which discovers great ingenuity, immense reading, and indefatigable industry, it would have thrown light upon the dark and early periods of the Scottish history, as he opens a new and plain path for leading us through the unexplored labyrinth of antiquity. But a fever put an end to his life, his last hours, and his usefulness, in the year 1757, being then only in the 30th year of his age. He left, in manuscript, a much esteemed and well-known allegory, intitled "The Immortality of Authors," which has been published and often reprinted since his death, and will be a lasting monument of a lively fancy, sound judgment, and correct taste. It was no small ornament of this extraordinary character, that he paid a pious regard to his aged mother, who survived him two years, and received an annual pension from the Duchess of Atholl as a testimony of respect to the memory of her son.

Stoneware,
Stones.

STONEHIVE, or **STONEHAVEN**, a small town in the county of Kincardine, in Scotland, 15 miles south from Aberdeen. It was built in the time of Charles II. and stands at the foot of some high cliffs, in a small bay, with a rocky bottom, opening a little in one part, so that small vessels may find admittance, but only at high water. A pier runs out from the harbour on the north side to secure them after their entrance. The town contains about 800 inhabitants. The manufactures are sail-cloths and oamaburghs, knit woilied and thread stockings.

STONES, in *Natural History*, have been defined bodies which are insipid, not ductile, nor indissoluble, nor soluble in water. For a view of the classification of stones and of their distribution, see **MINERALOGY** and **GEOLOGY**.

Here we shall make a few observations on some speculative discussions relative to their natural history.

As philosophers have perplexed themselves much about the origin and formation of the earth (a subject certainly far beyond the ken of the human intellect, at least if we believe that it was made by the Almighty power of G. d.), so they have also proposed theories to explain the origin of stones. When philosophers limit their inquiries within the boundaries of science, where they are led by the sober and safe conduct of observation and experiment, their conclusions may be solid and may be useful; but when, throwing experiment and observation aside, they rear a theory upon an airy nothing, or upon a single touched fact, their theories will vanish before the touch of true philosophy as a romantic palace before the rod of the enchanter. Sometimes from whim, or caprice, or vanity, they attempt to confound every thing: they wish to prove that the soul is move matter, that plants are animals, and that fossils are plants, and thus would banish two substances, spirit and dead matter, entirely from the world; as if the Author of Nature were actuated by fordid views of primanity in the works of creation, though we evidently see that a generous profusion is one of the characteristic marks of these works. We leave the task of confounding the different classes of being to those philosophers whose minds are too contracted to comprehend a great variety of being at one view, or who prefer novelty to every thing else. We content ourselves with the old opinion, that the soul is a spiritual substance; that plants are plants, and that stones are stones.

We have been led into these remarks by finding that some philosophers say that stones are vegetables; that they grow and increase in size like a plant. This theory, we believe, was first offered to the world by M. Tournefort, in the year 1702, after returning from his travels in the east. It was founded on a curious fact. In surveying the labyrinth of Crete, he observed that the names which visitors had engraving upon the rock were not formed of hollow but of prominent letters like busto

VOL. XIX. Part II.

relievs. He supposes that these letters were at first hollowed out by knives; that the hollows have since been filled up by the growth of the stone; and hence he concludes that stones vegetate. We will we were fully assured of the fact that the letters were at first hollowed, before we attempt to account for their prominence. But even allowing the supposition to be true that they were at first hollow, we reply it is only a single fact, and that it is altogether unphilosophical to deduce a general system from a single fact.

In the *second* place, this protuberancy of the characters is very improperly called vegetation, for it is not produced by a process in any respect like the vegetation of a plant. Vegetation supposes vessels containing fluids and growth by expansion; but who ever heard of vessels in a stone, of fluids moving in them, or of the different parts expanding and swelling like the branch or trunk of a tree? Even the fact which Tournefort mentions proves nothing. He does not pretend to say, that the rock itself is increasing, but only that a few small hollows are filled with new fleshy matter, which rises a little above the surrounding surface of the rock. This matter evidently has been once liquid, and at length has congealed in the channel into which it had run. But is not this easily explained by a common process, the formation of stalactites? When water charged with calcareous matter is exposed to the action of air, the water evaporates, and leaves the calcareous earth behind, which hardens and becomes like a stone.

Having thus examined the principal fact upon which M. Tournefort founds his theory, it is unnecessary to follow him minutely through the rest of his subject. He compares the accretion of matter in the labyrinth to the consolidation of a bone when broken, by a callus formed of the extravasated nutritious juice. This observation is thought to be confirmed, by finding that the projecting matter of the letters is whitish and the rock itself greyish. But it is easy to find comparisons. The difficulty, as Pope says, is to apply them. The resemblance between the filling up of the hollow of a stone, and the consolidation of a broken bone by a callus, we confess ourselves not philosophers enough to see. Were we writing poetry it had title, perhaps it might appear. The circumstance, that the prominent matter of the letters is whitish, while the rock is greyish, we flatter ourselves strengthens our supposition that it consists of a deposition of calcareous matter. Upon the whole, we conclude, we hope logically, that no such theory as this, that stones are vegetables, can be drawn from the supposed fact respecting the labyrinth. We have to regret, that the account which we have seen of the subject is so imperfect, that we have not sufficient materials for a proper investigation. Tournefort has not even told us of what kind of stone or earth the accretion consists; yet this single information would probably have decided the question (A).

4 X

STONES

(A) To give a more distinct notion of Tournefort's theory, we shall subjoin his conclusions: From these observations (he says) it follows, that there are stones which grow in the quarries, and of consequence that are solid; that the same juice which nourishes them serves to rejoin their parts when broken; just as in the bones of animals, and the branches of trees, when kept up by bandages; and, in a word, that they vegetate. There is, then (he says), no room to doubt but that they are organized; or that they draw their nutritious juice from the

STONES AND EARTHS, ANALYSIS OF.

Preliminary
Process.

AT the close of our article MINERALOGY, we referred to this place for an account of the method of examining the chemical constitution of earths and stones. In the article ORES, we have given a pretty full detail of the methods of analysing that class of minerals. In this place we propose briefly to point out the most improved processes for the analysis of the other three classes of mineral bodies, viz. earths and stones, salts, and combustibles; to which we shall add some account of the method of examining soils.

But before proceeding to the immediate object of this treatise, it may be useful to make some observations on some preliminary processes connected with the subject under consideration.

In the first place, it is necessary that the mineral to be examined be reduced to a fine powder. To effect this with very hard stones, they are made red hot, and in this state thrown into cold water. By the sudden change of temperature in the different parts of the stone, it cracks, and falls to pieces. If the pieces be not sufficiently small, the same process is to be repeated. The fragments are then to be reduced to smaller pieces in a polished steel mortar, and the cavity of this mortar ought to be cylindrical. A pebble of the same metal should be made to fit it exactly, that no part of the stone may escape during the operation of pounding. The stone being in this way reduced to powder, a determinate quantity is taken, 100 or 200 grains, for example, and this is to be reduced to as fine a powder as possible; or, as it is called, to an impalpable powder. This operation is most successfully performed in an agate mortar, with a pebble of the same mineral; a mortar of about four inches in diameter, and rather more than one inch deep, is found to answer the purpose very well. It is found most convenient to operate on small quantities only at a time; not more than five or six grains. When the powder feels soft, adheres, and appears under the pebble in the form of a cake, it is then as fine as possible. It is now to be accurately weighed, and it is usually found to have acquired some additional weight, arising from part of the mortar being worn off during the pounding. This additional weight must be attended to, and after the analysis is completed, a part of the substance of the mortar must be subtracted. In the case of an agate or flint mortar being used, the portion rubbed off, which increases the weight, may be regarded as pure siliceous earth.

The chemical vessels necessary for the analysis of mi-

Preliminary
Processes.

nerals are crucibles for exposing the substances to heat, glasses and shallow dishes for solutions and evaporations. The crucibles should be of platina or pure silver, and of such a capacity as to hold from seven to eight cubic inches of water. The vessels in which the solutions, evaporations, and other processes are performed, should be of glass or porcelain; the glass vessels, as being more brittle, and therefore more apt to break, are found to be less economical than those of porcelain. Some chemists employ porcelain vessels which are in the form of sections of spheres, and are glazed both in the inside and outside, excepting part of the bottom, which comes into immediate contact with the fire. Wedgwood's glazed vessels for evaporations, are found to answer very well; the glaze is thin, and the vessels are not very apt to crack; but it is supposed by some chemists, that it is occasionally acted on by strong acids. It is scarcely necessary to add, that an accurate balance is a necessary instrument in the hands of the analyst.

I. *Of the Analysis of EARTHS and STONES.*

The ingredients which have been discovered by means of analysis, in the composition of simple stones are, silica, alumina, lime, magnesia, zirconia, and glucina, with some of the metallic oxides, as those of iron, copper, manganese, chromium, and nickel; but it never happens that the whole of these substances are found in combination; and indeed it is a rare circumstance to meet with more than four or five in the same stone. With a view of discovering the different substances which enter into the composition of stones, the following method is recommended.

Take 200 grains of the stone to be examined, or, if it be inconvenient to procure this quantity, 100 grains will be sufficient. Let it be reduced to a fine powder, mixed with three times its weight of pure potash, and a small portion of water, and then subjected to heat in a crucible of silver. The heat must be applied slowly at first, and the matter is to be constantly stirred, that no part of it may be thrown out of the crucible by the swelling of the potash. The water being evaporated, the mixture is to be kept at a red heat for half an hour; and being removed from the furnace, some notion may be formed of the nature of the ingredients, by examining the contents; for, if the mixture be in a liquid state, the stone is chiefly composed of siliceous earth; if it be of the consistence of paste, and have an opaque appearance,

the earth. This juice must be first filtered and prepared in their surface, which may be here esteemed as a kind of bark; and hence it may be conveyed to all the other parts. It is highly probable the juice which filled the cavities of the letters was brought thither from the bottom of the roots; nor is there any more difficulty in conceiving this than in comprehending how the sap should pass from the roots of our largest oaks to the very extremities of their highest branches. Some stones, then (he concludes), must be allowed to vegetate and grow like plants; but this is not all; (he adds), that probably they are generated in the same manner; at least, that there are abundance of stones whose generation is inconceivable, without supposing that they come from a kind of seeds, wherein the organic parts of the stones are wrapped up as those of the largest plants are in their seeds.

Preliminary processes. ance, the other earths predominate; but if it remain in a powdery form, the aluminous earth is in greater proportion. The oxides of different metals are indicated by the colour of the mafs; when it is of a dark or brownish red, the metallic oxide is that of iron; a grafs green colour denotes manganese; and yellowish green the oxide of chromium.

But there are some ftones on which potafh has a very feeble action, and in this cafe borax has been fubftituted for the alkali. This is the method which was followed by Mr. Chenevix in analyzing aluminous ftones. A hundred grains of fuphure in powder were mixed with 250 grains of calcined borax, and fubjected to a ftrong heat in a crucible of platina for two hours. When the mafs was cold, it exhibited the appearance of a greenifh blue glafs, which adhered ftrongly to the crucible; but the whole being boiled for fome hours in muriatic acid, it was completely diffolved; the earthy matter was then precipitated by means of fub-carbonate of ammonia, and the precipitate, after being well wafhed, was again diffolved in muriatic acid; and in this way the borax was feparated. The remaining part of the analysis was exactly fimilar to that directed for other ftones, excepting only that the alumina was feparated from the potafh by means of muriate of ammonia.

But to return to the examination and farther treatment of the mafs in the filver crucible, which after being removed from the furnace, and wiped on the outside, is to be placed in a porcelain capsule; it is then filled with water, and this water is renewed occafionally, till the whole matter is feparated from the crucible. By this means a part of the compound of the alkali with the filiceous and aluminous earths, is diffolved, and with a fufficient quantity of water, the whole may be diffolved. Muriatic acid is now to be added till the whole of the mafs is brought to a ftate of folution. This, however, will not be the cafe, if the ftone be compofed chiefly of filica. On the firft addition of the acid, a flakey precipitate is produced, becaufe the acid unites with the alkali, which held the mafs in folution. An efferefcence afterwards takes place, which arifes from the decomposition of a portion of carbonate of potafh, formed during the fufion; and the flakey precipitate is again diffolved, as well as the matter which remained in the form of powder at the bottom of the veflel. If the powder be filica and alumina, there is no efferefcence; but if it contain lime, an efferefcence is produced. The folution in the muriatic acid being formed, if it feem appear colourlefs, it may be inferred that it contains no metallic oxide, or at leaft a very fmall portion. An orange red colour fhews that it contains iron, a purplifh red indicates manganese, and a golden yellow, chromium.

The folution is now to be introduced into an evaporating difh of porcelain, and being covered with paper, is to be placed on a fand bath, and evaporated to drynefs. Towards the end of the evaporation, as the liquid affumes the form of a jelly, it muft be continually ftirred with a rod of filver or porcelain, to permit the acid and water to afcend, and to allow the whole mafs to be equally dried; for it is in this way that the filica and alumina are feparated from each other. The matter being reduced to a dry powder, add to it a large quantity of pure water, ftir it to a moderate heat, and pour it on a filter. This folution may be denomi-

nated A. Wash repeatedly the powder which remains upon the filter, till the water which falls through is wafhed no longer precipitates filver from its folution. The powder remaining is filiceous earth, which is to be dried between folds of blotting paper, and then made red hot in a crucible of platina or filver, and when it is cold it is to be accurately weighed. If it appear filiceous earth, it is in the form of a white powder, is of a white colour, does not adhere to the fingers, and is infoluble in acids. If it be at all coloured, it fhews that it contains fome metallic oxide, and is a proof that the compound has been carried on with too great a heat. To feparate the oxide, boil the filica with an acid, and then wafh and dry it as before. This acid folution is to be added to the folution A, and the whole is to be evaporated to about the quantity of an English pint; then add to it a folution of carbonate of potafh, till the precipitation ceases; and it may be neceffary to boil it a few moments, to allow the whole of the precipitate to fall to the bottom. The whole of the precipitate being collected at the bottom, the fupernatant liquid is decanted off, and the water being put in its place, the precipitate and water are thrown on a filter; and when the water has run off, the filter with the precipitate upon it is placed on the folds of blotting paper. After the precipitate has acquired fuch a degree of confiftence, collect it carefully with an ivory knife, mix it with a folution of pure potafh, and boil it in a capsule of porcelain. The potafh diffolves the alumina or glucina, and the other fubftances remain in the form of a powder. This powder may be called B.

Add to the folution of potafh as much acid as will faturate the potafh, and alfo rediffolve any precipitate which at firft appeared; and then add carbonate of ammonia till the tafte of it be perceptible in the liquid. The whole of the alumina is now precipitated in the form of white flakes, while the glucina remains diffolved, if a fufficient quantity of carbonate of ammonia had been employed. Filter the liquid; and the alumina remaining on the filter being wafhed and dried, and after being made red hot, and allowed to cool, is weighed. To prove its being alumina, diffolve it in fulphuric acid, and a fufficient quantity of fulpate or acetate of potafh being added, the whole of it will be converted into alum crystals, if the earth employed be aluminous earth.

To feparate the glucina, the liquid which paffed through the filter is to be boiled for fome time, and if the folution contain any of this earth it will be precipitated in the form of a light powder, which may be dried in the ufual manner, and weighed. It is a fine, foft, light, talcufe powder, when in a ftate of purity; and the application of heat does not make it concrete, as happens to alumina.

We now return to the refiduum B, in which may be expected lime, magnesia, and fome of the metallic oxides. But if it be fuppofed that this refiduum contains any vitria, it is to be treated with carbonate of ammoniac, which diffolves the vitria, and leaves the other bodies unacted. The vitria being feparated, the refiduum B is to be diffolved in weak fulphuric acid, and the folution evaporated to drynefs. Add to it a quantity of water, which will diffolve the fulpate of magnesia, as well as the metallic filices; but the oxide of lime remains undiffolved, or if it is vitiated, it will be precipitated by X. c. c.

dilute, it may be thrown down by adding a small portion of weak alcohol. After being made red hot in a crucible, it is to be weighed, and the lime will amount to $\frac{1}{3}$ of the weight. The solution containing the remaining sulphates being diluted with a large portion of water, a small excess of acid is to be added, and then a saturated carbonate of potash. The magnesia and oxide of manganese remain dissolved, and the oxides of chromium, iron, and nickel, are precipitated. This precipitate may be denominated C.

Add to the solution a solution of hydrofulphuret of potash, and the magnesia in the state of a hydrofulphuret will be precipitated. Calcine the precipitate in contact with air, and weigh it. The addition of pure potash to the solution will precipitate the magnesia, which being washed, and subjected to a red heat, is also to be weighed.

The residuum C is to be repeatedly boiled with nitric acid, and then mixed with pure potash; and, being heated, the liquid is to be decanted off. The precipitate thus obtained, consisting of the oxides of iron and nickel, is to be washed with pure water, and this water is to be added to the solution of the nitric acid and potash. The chromium, if any be present, is contained in that solution, and is in the form of an acid. Add to the solution muscivic acid in excess, and let the evaporation be continued till the liquor become of a green colour; then add a pure alkali, by which the chromium is precipitated in the state of oxide, which is to be dried in the usual way, and weighed.

The precipitate containing the oxides of iron and nickel is to be dissolved in muriatic acid; ammonia is to be added in excess, when the oxide of iron precipitates; and being collected, washed and dried, is to be weighed. By evaporating the solution, the oxide of nickel will be also precipitated, or the whole may be precipitated by the addition of hydrofulphuret of ammonia. This being treated in the same manner as the other substances, is also to be weighed.

The weight of the whole substances thus obtained being added together, and being compared with the weight of the matter originally operated upon, if the two be equal, or if the difference do not exceed three or four parts in 1000, it may be inferred that the analysis is nearly correct; but a considerable loss of weight indicates some error, and requires the analysis to be carefully repeated. If the same loss of weight appear, it may be concluded that the stone contained some substance which is soluble in water, or has been driven off by the heat. To ascertain the last point, a portion of the stone is to be broken into small pieces, and exposed to a strong heat, in a porcelain retort. If it contain water, or any volatile substance, it will come over into the receiver, and by this means the nature and weight of the ingredients separated may be ascertained. If nothing come over into the receiver, or if what is obtained be not equal to the deficient weight, it may be inferred that the stone contains some matter which is soluble in water.

A fixed alkali has been not infrequently found in simple stones; and to ascertain whether the mineral subjected to analysis contains any alkaline matter, different methods have been pursued. These methods we shall now describe. The stone being reduced to an insoluble powder, is cautiously heated repeatedly with sulphuric acid, and the mass is to be digested in water; and

this solution being properly concentrated, is set aside Preliminary for some days. The appearance of crystals of alum is a Process. certain indication that the mineral contained potash; and the quantity of potash may be estimated at $\frac{1}{100}$ of the weight of these crystals; but if no crystals be obtained, the solution is to be evaporated to dryness, and the residuum exposed to a moderate red heat. Digest it afterwards in water, and add carbonate of ammonia, and filter; evaporate again to dryness, expose the residue to a heat of 700° , and redissolve it. The solution being properly concentrated, will give crystals of sulphate of soda or of potash, as the one or the other alkali is present. Potash may be discovered by adding to the solution of the salt, a solution of nitro-muriate of platinum somewhat concentrated. A yellow precipitate, which is muriate of platinum and potash, is thus obtained.

Klaproth's method for discovering fixed alkalis in minerals is the following. He takes four parts of nitrate of barytes to one of the mineral to be examined, and fuses them together in a porcelain crucible. A spongy mass of a light-blue colour was thus obtained, and with the addition of diluted muriatic acid, was completely dissolved. The solution, which was of a yellow colour, was then mixed with a sufficient quantity of sulphuric acid, by which the barytes is precipitated, and the muriatic acid expelled. The liquid is next evaporated to dryness, and the mass being digested in water, is filtered, and the sulphate of barytes and silica remain on the filter. The clear solution is saturated with carbonate of ammonia, and filtered a second time; and all the earthy and metallic bodies being separated, the sulphates of fixed alkali and ammonia only remain in the solution, which being evaporated to dryness, the dry saline mass is introduced into a porcelain crucible, and subjected to such a degree of heat as is sufficient to drive off the sulphate of ammonia. The residuum is then dissolved in water, and crystallized; and thus a pure, fixed alkaline sulphate is obtained, which is again dissolved in water, and decomposed, by adding acetate of barytes. The solution is then filtered, and the liquid is evaporated to dryness. The saline mass obtained is the acetate of a fixed alkali, which being exposed to heat in a crucible, became of a reddish colour. The carbonaceous residuum is then to be dissolved in water, filtered, and crystallized, and the salt thus procured is a carbonate of a fixed alkali, the nature of which may be easily recognized by the means stated above.

M. Davy's method of detecting a fixed alkali in minerals, is different. One hundred grains of the stone in very fine powder are to be fused for half an hour at a strong red heat, in a crucible of platinum or silver, with 200 grains of boric acid. An ounce and half of nitric acid diluted with seven or eight times its quantity of water, is then digested upon the fused mass, till the decomposition of the whole is completed. Evaporate the fluid to about two ounces, or one ounce and a half; by this means the siliceous earth is separated, which being collected on a filter, is to be washed with distilled water, till the boric acid and the whole of the saline matter are separated. The fluid is then mixed with water that has passed through the filter, and evaporated to the quantity of half a pint, after which it is saturated with carbonate of ammonia, and boiled with an excess of this salt, till the whole of the substances capable of being

being precipitated, have been thrown down. The solution being filtered, the earths and metallic oxides remain on the filter. Add nitric acid to the liquid till it acquire a strong four taste, and evaporate till the boric acid appear free.

The fluid is then to be filtered, and evaporated to dryness, and the dry mass being exposed to a heat of about 450° Fahrenheit, the nitrate of ammonia is decomposed, and the nitrate of potash or soda remains behind.

To detect fluoric acid, which has been sometimes met with as a component part of stones, Klaproth heats the mineral with sulphuric acid in a glass retort, the corrosion of which, and the deposition of silica in the water of the receiver, are certain tests of fluoric acid.

After the general observations which have now been offered, we proceed to give examples of the analysis of minerals belonging to the different genera of earths and stones; and we shall follow the same order in which those genera are described in the article MINERALOGY.

1. ZIRCON GENUS.

The mineral affording the earth which characterises this genus, was analysed by Klaproth in the following manner. We select that species which is called hyacinth.

A. 100 grains of hyacinth being levigated in the flint-mortar, received an increase of weight of half a grain.

B. This pulverized hyacinth, digested with two ounces of nitro-muriatic acid, yielded, upon saturating the solution with potash, a light-brown precipitate, of three grains and a half, when dried. Ammonia, added to it, dissolved nothing; and it remained colourless. After the precipitate had been again separated from the volatile alkali, muriatic acid was added, which dissolved its ferruginous contents, leaving a white earth behind, which, when ignited, weighed $1\frac{1}{2}$ grain. The portion of iron, precipitated by caustic ammonia from the muriatic solution, weighed half a grain, when ignited, and became black and resplendent. It was fused with a neutral phosphate, upon charcoal, to find whether it contained manganese; no trace was perceptible.

C. The above $1\frac{1}{2}$ grains of earth B were now added again to the hyacinth, after treatment with acids. The stone was then subjected to red heat, with six times its quantity of caustic alkali, in the manner explained in the essay on the jargon of Ceylon; the ignited mass was again liquefied with water; and the earth remaining after this process weighed 123 grains, when collected, educated, and dried.

D. The alkaline lishium was then saturated with muriatic acid, and evaporated. At first it continued clear; but towards the end siliceous earth separated, the quantity of which, after ignition, amounted to six grains.

E. To the 123 grains, previously well washed with water, a sufficient quantity of muriatic acid was added; which, with the assistance of heat, dissolved nearly the whole, a trifling residue excepted. This muriatic solution, evaporated in a moderate heat to a sixth or eighth part, lost its fluidity, and formed a limpid gelatinous conglutium. It was then covered with water, and exposed, with repeated agitation, to a dispelling heat.

By this management, the siliceous earth separated in slimy, intumefaced grains, and weighed, after ignition, 23 $\frac{1}{2}$ grains.

F. The solution, thus freed from its silica, was now saturated with a boiling ley of mild alkali; and the precipitate was washed and dried in the air. This last weighed 114 grains, proving, upon every trial, to be jargonic earth. A fourth part of it, heated to redness, weighed 16 $\frac{1}{2}$ grains; which make the whole amount to 66 grains.

G. The above six grains D, with the 23 $\frac{1}{2}$ grains F, in the whole 29 $\frac{1}{2}$ grains of siliceous earth, were ignited with a quadruple weight of vegetable alkali. When this mass had been again saturated with water, it left a residue, which was extracted by muriatic acid. From this muriatic solution, also, when saturated with potash, jargonic earth fell down, weighing four grains after ignition. Hence, subtracting these, the quantity of siliceous earth is reduced to 25 $\frac{1}{2}$ grains.

One hundred parts of hyacinth, therefore, have given

| | | | | |
|---------------|---|------------------|------|-------|
| Jargonia | F | 66 | } | 70 |
| G | | 4 | | |
| Silica | G | 25 $\frac{1}{2}$ | } | 23 |
| Substrat | A | 1 | | |
| Oxide of iron | B | - | | 0.50 |
| | | | | 95.50 |
| | | | Loss | 4.50 |
| | | | | 100 |

2. Of the SILICEOUS GENUS.

A great preparation of the stones belonging to this genus are transparent, and have a vitreous appearance. They are so hard as to scratch glass, and, excepting the fluoric acid, they are not acted upon by acids. By fusion with alkalies they form glass; they also enter into fusion with boracic acid, and the acid of phosphorus. Stones composed chiefly of pure silica, are transparent and colourless. When a mineral is presented for examination, even if it possess most of the properties which characterize stones belonging to this genus, some preliminary processes may be pursued to ascertain farther its nature and component parts.

A. It is sometimes difficult to reduce siliceous stones to a fine powder. To facilitate this operation, a portion of the stone may be heated to redness, and in this state suddenly plunged into cold water. If by the first heating it is not sufficiently brittle, the operation may be repeated until the mineral can be reduced to a fine powder, as already directed.

B. One part of the stone in fine powder is now to be mixed with four or five parts of potash, dissolved in the same quantity of water. The mixture is introduced into a silver crucible, and evaporated to dryness, stirring it continually with a silver rod, according to the directions given above. The mass being evaporated to dryness, the heat is to be gradually increased, till the crucible appears of a dull red heat, or till the mass enter into quiet fusion. In this state it is kept for an hour.

C. Remove the crucible from the fire before it is completely cold; loosen the mass with water, by adding fresh

ANALYSIS OF STONES, &c.

fresh portions from time to time, till the whole is detached from the crucible, and then add 12 times its bulk of water to effect a solution. If the stone consisted chiefly of siliceous earth, the greater part of the mass will be dissolved.

D. Add muriatic acid till no farther precipitate is effected, and without separating the precipitate, evaporate the whole to dryness.

E. Pour six times its bulk of muriatic acid, previously diluted with four parts of water, on the dry mass; boil the mixture for half an hour; let the insoluble part subside, and then collect it on a filter, and after being dried, subject it in a crucible to a red heat. This powder is the siliceous earth contained in the mineral.

But stones included under this genus contain very different proportions, not only of siliceous earth, but also of the other earths; and some of them even contain a far greater proportion of other earths than that which characterizes the genus under which they are arranged.

Analysis of Leucite.

The analysis of this mineral is particularly interesting, not only as Klaproth first detected in it potash, which was supposed to belong exclusively to the vegetable kingdom, and hence called vegetable alkali, but also as it places the skill and address of that eminent chemist in its examination in a very conspicuous light. The process was conducted in the following manner*.

Ignited alone upon charcoal, the leucite is completely infusible. It undergoes no manner of alteration, and its splinters lose nothing of their lustre.

A small fragment, put into fused borax, is for a long time moved about in it before it dissolves, which it does by degrees; and the glass globule obtained is clear and light-brown.

By fusion with a neutral phosphate, the solution is still slower, and a colourless rity glass pearl is produced.

One hundred grains of coarsely pounded leucite exposed for an hour to a strong red heat, in a small porcelain pot, lost of weight only one-eighth of a grain, and even the violent heat of the porcelain furnace produced in the leucite only an inconsiderable change.

A. One hundred grains of leucite, reduced to an impalpable powder, being several times digested in muriatic acid, dissolved a considerable part. A siliceous residue of 74 grains remained after ignition.

B. The siliceous earth ignited with twice its weight of caustic alkali, softened again with water, covered with muriatic acid, added to excess of saturation, and, after sufficient digestion with this last, being collected on the filter, and heated to redness, was found to have lost little of its weight.

C. Precipitate of potash added to the muriatic solution produced a precipitate which indicated one-eighth of a grain of oxide of iron.

D. The solution by caustic ammonia being decomposed, and the precipitate being separated, the remaining liquor was tried with carbonate of soda, but no farther change was effected.

E. The precipitate produced by means of pure ammonia D was first dried. It was next purified by digesting it with distilled vinegar, and afterwards neutralizing this acid by ammonia. It weighed 24 grains

and a half, when calcinated and ignited: Diluted sulphuric acid completely dissolved it to a limpid liquor, and when properly treated, the solution yielded only alum.

F. To obtain the earth, which possibly might have remained latent in the several washings, the whole was evaporated to dryness. After having re-dissolved the saline mass in water, the remaining portion of earth was collected, it amounted only to half a grain, and was siliceous earth.

There were therefore obtained,

| | | | | |
|---------|---|-----|------------------|----------------------|
| Silica | - | (A) | 54 | |
| | - | (F) | $\frac{1}{2}$ | |
| | | | 54 $\frac{1}{2}$ | - 54.50 ^o |
| Alumina | - | (E) | - | - 24.50 |
| | | | | 79 |
| | | | | 24 |
| | | | | 100 |

The remarkable loss of more than one-fifth of the whole weight of the mineral under examination, excited suspicion that some error had crept into the analysis, and led to a repetition of the experiments, by varying the processes as follows.

A. One hundred grains of leucite in fine powder were ignited for half an hour, with double their weight of caustic potash. To the mass softened with water muriatic acid was added, just to the point of saturation, and the mixture being filtered, the remaining undissolved residuum was washed and dried.

B. The mineral thus prepared for decomposition, was then treated with muriatic acid, and kept for some time at a boiling heat. By this process a quantity of silica separated, which after being heated to redness weighed 53 grains and a half.

C. Oxalate of potash being added to the muriatic solution, concentrated by evaporation, produced no turbidity. The alumina was separated by the same means as in the former experiments, and its weight amounted to nearly the same. By other trials it did not appear to have any mixture of other earths, and no other earth could be obtained by evaporating the waters with which the powders had been washed.

Thus, after varying the experiments, the same results were obtained, and the same loss still appeared. In the farther prosecution of this investigation, the following experiments were had recourse to.

A. Two hundred grains of leucite in fine powder were repeatedly digested with muriatic acid, and the siliceous earth collected on the filter, washed, and weighed after being red hot, amounted to 109 grains.

B. The muriatic solution was of a yellowish colour, and being reduced by evaporation in a sand heat to the consistence of honey, the surface appeared covered with a saline crust; and when completely cooled, the mass appeared like a thick clear oil, of a golden yellow colour, and full of crystals, some of which were of a cubical, and some of a tabular form. The yellow fluid was gently poured off, and the salt rinsed with small portions of alcohol. The solution diluted with alcohol was again evaporated, and the small portion of salt thus obtained

* *Essays*,
p. 348.

Siliceous
Genus.

tained was again washed with alcohol, and added to the first. The whole of the salt being dried, weighed 70 grains. This was dissolved in water, and some drops of a solution of ammonia being added, threw down some particles of alumina. The solution being crystallized in a warm place, yielded only cubical crystals, some of which were elongated to four-sided columns.

C. That part of the muriatic solution which shot into crystals being dissolved with water, and decomposed in a boiling heat, by carbonate of soda, yielded a precipitate, which after washing, drying, and ignition, amounted to 47½ grains of aluminous earth. Three times its weight of concentrated sulphuric acid was added, and the mixture was evaporated nearly to dryness. The mass was again dissolved in water, and combined with a solution of acetate of potash, which being crystallized, produced only alum.

D. The siliceous earth A was mixed with double its weight of potash, and subjected to a strong red heat for an hour. The mass was reduced to powder, and diluted with water. Muriatic acid was added in excess, and digested with it. The filtered muriatic solution being saturated with soda yielded 1½ grain of aluminous earth, after which there remained of silica 157½ grains.

The 200 grains of leucite have thus afforded of

| | |
|-----------|--------|
| Silica D | grs. |
| Alumina C | 47.75 |
| ———— D | 1.55 |
| | 156.75 |

Here there was still a deficiency of 23.25 grains, to account for which the 70 grains of salt B must be examined. This examination was conducted in the following manner.

1. The taste and figure of the crystals were found to be the same with those of muriate of potash.

2. The solution produced no change in vegetable blues, or in red-dened litmus paper.

3. When heated to redness, the salt made a crackling noise, and remained fixed in the fire.

4. Neither carbonate of soda nor caustic ammonia produced any turbidity in the solution.

5. Two parts of strong sulphuric acid were added to three of the salt, and the muriatic acid being driven off by heat, the mass was again dissolved in water, which afforded crystals of sulphate of potash.

6. The remaining portion of salt was dissolved in a small quantity of water, and to this was added a concentrated solution of crystallized acid of tartar. The acidulous tartrate of potash (cream of tartar) was thus immediately produced and precipitated in the form of sand. This was washed, dried, burnt in a silver crucible, and the coal obtained repeatedly washed with water. The solution being evaporated to dryness, after being examined by the proper tests, appeared to be a carbonate of potash, which being saturated with nitric acid, afforded nitrate of potash.

Thus it appears that the base of the 70 grains of salt consisted entirely of pure potash, which was neutralized by part of the muriatic acid employed in decomposing the mineral; and according to the proportions of lime in muriate of potash, the 70 grains A contain 427 grains

of alkali; and in this way the deficiency in the examination of the leucite is accounted for.

The result of the analysis is as follows.

| | |
|---------|--------|
| Silica | grs. |
| Alumina | 53.75 |
| Potash | 21.62 |
| | 21.35 |
| | ———— |
| | 129.72 |

Analysis of Pitchstone.

The pitchstone which is the subject of the following analysis, also conducted by Klaproth, is the transparent yellowish or olive green variety of that mineral from Meissen. It affords an example of soda, the other fixed alkali, forming a component part of it.

A. 100 grains in coarse fragments were introduced into a covered crucible, and were subjected to a red heat for half an hour. When taken from the fire they appeared of a white gray mixed with a yellowish colour, and having a rough feel, with something of the appearance of glazing. They lost 8½ grains of weight.

B. In the heat of a porcelain furnace, the pitchstone was fused both in the clay and charcoal crucible, and was converted into a clear glass, full of small froth holes.

C. 100 grains of pitchstone in fine powder were treated with a solution of 200 grains of caustic soda, and being put into a silver crucible, were kept for half an hour in a pretty strong red heat. The mass was then filtered with water; muriatic acid was added in excess; the solution was evaporated in a sand heat, nearly to dryness; water was again poured upon it, after which it was filtered, and 73 grains of siliceous earth were obtained.

D. Caustic soda was mixed in excess with the muriatic solution, and the whole was digested in a boiling heat, by which the precipitate formed at the beginning of the process was again dissolved; a brown residuum still remained, which being separated, the alkaline solution was neutralized, and precipitated with carbonate of soda. The precipitate, which was alumina, after being washed, dried, and heated to redness, amounted to 14½ grains. The whole of it yielded crystals of alum, with sulphuric acid and potash.

E. The residuum which remained undissolved by the caustic soda D, was first dissolved in muriatic, and then united with sulphuric acid. Sulphate of lime was obtained, which was collected, and washed with diluted alcohol. By reducing the filtered fluid by evaporation to a smaller quantity, and combining it with sulphuric acid, another portion of sulphate of lime, which, added to the first, amounted to three grains, indicating 15 grains of pure lime.

F. The fluid was now freed from the calcareous earth; the iron which it contained was precipitated by carbonate of ammonia, which amounted to one grain. The remaining fluid was evaporated to dryness, and water being added to the saline residuum, five minute flakes of oxide of manganese separated, but in no greater quantity than one-tenth of a grain.

G. 100 grains of pitchstone in powder were mixed with 300 grains of crystallized nitrate of barites, and heated to redness in a porcelain vessel, till the mass was entirely

ANALYSIS OF STONES, &c.

720
Argillaceous Genus

entirely decomposed. The cold mass was softened with water, neutralized with muriatic acid, and combined in such proportion with sulphuric acid, that the latter, after the evaporation of the mixture, and separation of the muriatic acid by heat, was still in excess. The mass was washed with hot water; the residuum separated by filtration; and the clear fluid was mixed with carbonate of ammonia in excess. The precipitate thus obtained was collected on a filter, and the remaining fluid was evaporated to dryness, and the portion of sulphate of ammonia subjected to a moderate heat in a porcelain vessel, was driven off. A fixed salt remained, which appeared to be sulphate of soda. This was redissolved, and decomposed by acetate of barytes; the filtered solution was evaporated to dryness; the dry salt was heated to redness in a crucible of platinum. The saline residuum being redissolved, filtered, and again evaporated to dryness, yielded three grains of dry carbonate of soda, indicating $1\frac{1}{2}$ grain of pure soda. This being neutralized with nitric acid, gave crystals of nitrate of soda.

The 100 grains of the mineral thus examined consist of

| | |
|-----------------|------------------|
| Silica C | 87 $\frac{1}{2}$ |
| Alumina D | 73 |
| Lime E | 14.5 |
| Oxide of iron D | 1 |
| — manganese D | .10 |
| Soda G | 1.75 |
| Water A | 8.50 |
| | 99.85 |

3. ARGILLACEOUS Genus.

As many of the stones included under this genus are composed of similar substances with those arranged in the former genus, it is obvious that the examination is to be conducted in the same way. We shall therefore give one example of the analysis of a stone belonging to this genus, and the example is that of basalt by Klaproth*.

Analysis of Basalt.

A. Small fragments of this stone were subjected to a strong red heat for 30 minutes; the loss of weight was two per cent. and the mass became of a lighter colour, and more readily yielded to the pestle.

B. Basalt exposed to the heat of a porcelain furnace in a common clay crucible, fused into a compact black brown glass, which in thin splinters was transparent. It also entered into thin fusion in a crucible of semi-indurated steatites; part of it ran into the clefts produced in the steatites, and the rest was found crystallized in brown shining lamellae, which on the surface were striated, and cellularly concreted. In a charcoal crucible it was converted into a dull gray and finely porous mass, in which were inferted numerous grains of iron.

C. To ascertain whether this stone contained soda, 120 grains of basalt in fine powder were mixed with 400 grains of nitrate of barytes, and were at first exposed in a large porcelain vessel to a moderate heat, and afterwards to a heat gradually raised to ignition. The mixture swelled up, and when the heat was increased, white fumes arose on uncovering the vessel, which led

to a supposition that the soda was beginning to volatilize. The fire was then removed.

D. The porous mass, after cooling and being reduced to powder, was drenched with water, and treated with muriatic acid. The whole entered into solution, and produced a clear yellow fluid. The solution was evaporated, and sulphuric acid was added gradually, till it was in excess. The sulphate of barytes was precipitated.

E. The saline mass by filtration was reduced to dryness, and water was added, the sediment separated, and appeared to consist of the sulphate of barytes, and the siliceous earth of the stone. The clear fluid was saturated with ammonia, and the precipitate which was obtained being filtered off, the neutralized liquor was evaporated to dryness, and then exposed in a porcelain vessel to a moderately intense heat, till the whole sulphate of ammonia was driven off. The fixed portion remaining dissolved in water, and crystallized, appeared to be pure sulphate of soda. This was dissolved, decomposed by acetate of barytes; the precipitate, which was sulphate of barytes, was separated by the filter, and the clear fluid being evaporated to dryness, the dry acetate of soda was heated to redness in a crucible of platinum; and in this way 4 $\frac{1}{2}$ grains of dry carbonate of soda was obtained, which is equal to 2.6 grains of pure soda.

F. To separate the other ingredients, 120 grains of powdered basalt were ignited for two hours with 400 grains of carbonate of soda, in a crucible of porcelain; but with a degree of heat which did not produce fusion. It united into a yellowish, somewhat hard mass, which being reduced to powder, and softened with water, was neutralized with muriatic acid. It was then a little super-saturated with nitric acid, and evaporated to dryness. The colour of the dry mass was fassion yellow. It was dissolved in water, slightly acidulated with muriatic acid, and after being digested for a short time it was filtered. The siliceous earth collected on the filter was exposed to a red heat, and being weighed, amounted to 4 $\frac{1}{2}$ grains.

G. The muriatic solution being sufficiently diluted with water, was precipitated at the temperature of boiling water, by means of carbonate of soda. The precipitate being separated, was digested with a solution of caustic soda, and a dark brown residuum was separated by filtration. Muriatic acid was added in a small excess to the alkaline fluid, and this was precipitated with carbonate of ammonia. The precipitate obtained, after being washed and ignited, amounted to 16 $\frac{1}{2}$ grains. It yielded alum, when treated with sulphuric acid and potash, and was therefore aluminous earth.

H. The brown residuum G was dissolved in muriatic acid with particular attention to the precise point of saturation. Succinate of ammonia was added to the solution, to precipitate the iron; and the succinate of iron obtained, when perfectly washed and strongly heated in a covered crucible, afforded 20 grains of oxide of iron, which were attracted by the magnet.

I. The iron being separated, the fluid was treated at the temperature of boiling with carbonate of soda; a white precipitate was obtained, which was dissolved in nitric acid; and sulphuric acid being combined with the solution, threw down sulphate of lime. This was separated, and the remaining liquor being evaporated

Argillaceous Genus

* 3734, 11. 193.

nearly to dryness, was again distilled with a mixture of water and alcohol. Another portion of sulphate of lime fell down, which being separated, was added to the former. The whole of the sulphate of lime was decomposed by boiling it with carbonate of soda in solution, and the carbonate of lime thus obtained, after being washed and dried, weighed 17 grains, indicating nine grains and a half of pure lime.

K. Upon the fluid left from the last process, caustic soda was affused; a slimy precipitate was formed, which rapidly dissolved in sulphuric acid, and communicated a brown colour to the solution. It was evaporated in a sand bath; loose brown flakes fell down at the commencement of the process, and these being separated by the filter, appeared to be oxide of manganese; the quantity eliminated did not exceed one-eighth of a grain.

L. The remaining portion of the fluid was evaporated to dryness, and the residuum was exposed in a small crucible to a strong red heat. It was again dissolved in water, and yielded a small portion of alumina coloured with iron, and contaminated with manganese. After ignition it did not weigh more than half a grain; but the clear solution was entirely crystallized, and afforded sulphate of magnesia. Carbonate of soda was added to the magnesian salt in solution, by which the earthy base was precipitated in the state of carbonate. It weighed six grains, which is equal to $2\frac{1}{2}$ grains of pure magnesia.

The following is the result of the preceding analysis.

| | |
|----------------------|-----------|
| Silica F | 44.5 grs. |
| Alumina G | 16.25 |
| — I | .5 |
| Oxide of iron H | 20. |
| Lime I | 9.5 |
| Magnesia L | 2.25 |
| Oxide of manganese K | .12 |
| Soda E | 2.60 |
| Water A | 2. |
| | <hr/> |
| | 97.72 |

4. MAGNESIAN Genus.

Besides several of the earths detected in minerals belonging to the former genera, the stones arranged under this genus are distinguished by being combined with magnesia. We shall only give one example of the analysis of a magnesian stone.

Analysis of Steatites.

This mineral, which was found in Cornwall, was analyzed by Klaproth in the following manner.

A. One ounce of the stone in small pieces was subjected to a strong red heat, by placing the glass retort which contained it in an open fire. A small portion of water distilled over, which was pure and tasteless. The mineral lost 75 grains of its weight, and became darker in the colour, and considerably harder.

B. After being reduced to powder, it was carefully mixed, and heated red hot, with two ounces of carbonate of potash in a porcelain pot. The concreted mass was levigated with water, and digested with muriatic acid in excess. A white loose slimy earth was precipitated, which after being washed, dried, and subjected to a red heat, weighed 224 grains. It was pure silica.

VOL. XIX. Part II.

C. Prussiate of potash was added to the filtered solution, and produced a blue precipitate, which being collected, washed, dried, and ignited with a little wax, was found, after cooling, to weigh seven grains. The whole of it was attracted by the magnet. The portion of iron belonging to the prussiate of potash being subtracted, left $3\frac{1}{2}$ grains of oxide of iron as a constituent of the mineral under examination.

D. Carbonate of potash being added to the solution freed from the iron, precipitated its earthy ingredient. This, after washing, and gentle ignition, weighed 192 grains. These were covered with a proportionate quantity of concentrated distilled vinegar, and being digested in a low heat, were thrown upon the filter. The earth remaining on the paper, which, after being dried and heated red hot, weighed 93 grains, was mixed with three times its weight of strong sulphuric acid, and the mixture being evaporated in a sand heat nearly to dryness, the dry mass was dissolved in water and filtered; 26 grains of siliceous earth were thus obtained.

E. In the sulphuric solution D, there still remained 67 grains of earth, which being precipitated by an alkali, appeared to consist entirely of aluminous earth.

F. Ninety-nine grains of the first, 192 grains of the earthy precipitate D. were taken up by the acetic acid, which being precipitated by carbonate of potash, and the earth obtained being tried by sulphuric acid, was found to be pure magnesia.

This analysis shows that the 480 grains of steatites thus examined, afforded

| | |
|-----------------|--------|
| Silica B | 204 |
| — D | 26 |
| Magnesia F | 99 |
| Alumina E | 67 |
| Oxide of iron C | 3.75 |
| Water A | 75. |
| | <hr/> |
| | 474.75 |
| Loss | 5.25 |
| | <hr/> |
| | 480.00 |

or 100 parts of the mineral contain

| | |
|---------------|-------|
| Silica | 45 |
| Magnesia | 20.5 |
| Alumina | 14. |
| Oxide of iron | 1. |
| Water | 15.5 |
| | <hr/> |
| | 99.0 |

5. CALCAREOUS Genus.

The analysis of stones belonging to this genus must be varied according to the nature of the combination into which the lime has entered. With regard to the processes to be followed in the examination of calcareous stones, they are susceptible of a natural division into such as are soluble in muriatic or nitric acid with effervescence, and such as are scarcely soluble in those acids, and do not effervesce. To the first belong all the stones called limestones, or carbonates of lime; and to the second belongs sulphate of lime, or gypsum.

Analysis of Carbonate of Lime.

Carbonate of lime, whether in the form of lime spar, or in a less pure state, in the form of limestone, is soluble

Calcareous
Gems

with effervescence in nitric or muriatic acid. When exposed to heat, it yields carbonic acid gas, and is converted into quicklime; and when fused with an alkali, does not form a uniform mass. But we shall give a short view of the processes to be followed in a more particular examination.

A. Let a determinate quantity of the stone be reduced to a fine powder. Digest it repeatedly with muriatic acid till no further action is produced upon it. Dilute the solution, throw it upon a filter, and, after drying, weigh the insoluble residuum.

B. Let the remaining solution be diluted with 24 times its bulk of water; add sulphuric acid diluted; a precipitate takes place if the stone contained any barytes, the amount of which, after being collected and dried, may be ascertained by weighing.

C. Add to the filtered solution, after the barytes has been separated, a solution of carbonate of soda, as long as any precipitate is formed. Collect this precipitate, and let it be so much dried that it may be easily removed from the filter.

D. Add to the precipitate with sulphuric acid till all effervescence ceases.

E. Introduce the whole into a mixture of three parts of distilled water, and one of alcohol, in the proportion of eight parts of the mixture to the quantity of the substance previously dissolved in nitric acid. Let the whole be digested for some hours in the cold, filter the fluid, and dry the insoluble residuum and weigh it.

F. The remaining solution is next to be decomposed by a solution of carbonate of potash, and the precipitate being collected, is to be washed, dried, and weighed.

By this examination, if the stone is to be ranked with carbonate of lime, the weight of the insoluble part E, after subtracting from it one-third, must exceed the weight of the insoluble parts A and B.

Analysis of Sulphate of Lime.

As this is insoluble in nitric or muriatic acids, its analysis must be conducted in a different manner.

A. Let one part of the mineral, reduced to fine powder, be boiled with four times its weight of carbonate of potash, in a sufficient quantity of water for two or three hours; as the fluid evaporates, water is to be added.

B. Introduce the insoluble mass obtained by the last process into a flask containing diluted nitric acid, and the whole being dissolved, let it be evaporated to dryness, and weighed.

C. Add to the dried mass more than its own weight of strong sulphuric acid; apply heat, and let it be gradually increased till fumes cease to rise, and let it be again weighed.

D. Let the insoluble part be digested in twice its weight of cold water; filter the fluid, collect the insoluble residuum, and dry it in a dull red heat. To ascertain the quantity of lime, subtract from the weight of the insoluble mass left (in C) 59 parts; what remains is equal to the quantity of lime.

E. The quantity of lime also may be ascertained, by subjecting it to some time to a red heat, the insoluble mass B; for by this process it will be converted into quicklime.

Analysis of Fluete of Lime.

In the examination of this mineral, a quantity of it may be reduced to powder, and melted with sulphu-

ric acid, in a leaden or pewter vessel. The mixture being heated, fumes arise, to which a plate of glass being exposed, is soon corroded. In this way the fluoric acid may be detected, and the quantity of base may be ascertained by decomposing the mineral by means of sulphuric acid, and afterwards analyzing the sulphate of lime, as already directed.

Analysis of Phosphate of Lime.

The analysis of this mineral may be conducted in the following manner.

A. Let a determinate portion be digested in five times its quantity of muriatic acid, and let the operation be repeated till the acid has no farther action upon the residuum; decant the fluid, and then let it be diluted with water and filtered.

B. Add to the muriatic solution, liquid ammonia; collect the precipitate which is formed, and after being washed and dried, expose it to heat.

C. Add nitric acid to the precipitate till the whole is dissolved. Precipitate again by means of sulphuric acid; let the whole then be filtered, and let the insoluble residuum be washed with as little water as possible.

D. Evaporate the filtered fluid to the consistence of syrup; the fluid thus obtained is phosphoric acid, if the stone examined have been phosphate of lime. The test of phosphoric acid is, that it precipitates lime water, and also forms precipitates with the solutions of sulphate of iron, and nitrate of mercury; but it does not precipitate the muriate or nitrate of barytes.

6. BARYTIC GENUS.

Analysis of Carbonate of Barytes.

A. Take a determinate quantity of the mineral, and dissolve it in diluted nitric acid; take a portion of the solution, and add to it a solution of sulphate of soda. If a precipitate take place, by adding a small quantity of the salt to the solution of the earth, diluted with 24 times its bulk of water, it may be inferred that the base of the mineral is barytes.

B. Let the nitric solution be evaporated to dryness, and exposed in a silver crucible to a white heat; the earth obtained is barytes, which is soluble in 20 times its weight of water; and after evaporation, crystallizes into long four-sided prisms.

Analysis of Sulphate of Barytes.

This mineral was analyzed by Klapproth in the following manner.

A. 200 grains were mixed with 500 grains of carbonate of potash, and were exposed for two hours to a red heat; the mass was reduced to powder, boiled with water, and the undissolved earth was collected on the filter.

B. To separate the siliceous earth, the fluid was neutralized by muriatic acid, and evaporated to dryness. The saline mass was redissolved in water, and the silica remaining after being ignited, weighed 15 grains.

C. The barytic earth, freed from the sulphuric acid B, was covered with water; muriatic acid was added; the whole was dissolved by digestion, except two grains of silica. The filtered solution was crystallized, and afforded muriate of barytes.

D. The crystals were redissolved in water, and sulphuric acid was added to the solution, while any precipitate appeared, and the regenerated sulphate of barytes

Calcareous
Gems

Barytic Genus. being washed and dried, weighed 185 grains, but after ignition, only 185 grains.

One hundred parts of this mineral are therefore composed of

| | |
|-----------------------|-------|
| Sulphate of barytes D | 90 |
| Silica B | 9 |
| — C | 1 |
| | <hr/> |
| | 100 * |

7. STRONTIAN GENUS.

Analysis of Carbonate of Strontites.

This mineral was analyzed by Klaproth, in the following manner.

A. 100 parts were dissolved in muriatic acid, diluted with half its quantity of water. Thirty parts of carbonic acid were driven off during the solution, which being evaporated, afforded crystals in the shape of needles; and these crystals being dissolved in alcohol, communicated to it the property of burning with a carmine red flame. This is the test of ironitic earth.

B. To ascertain whether the mineral examined contained any barytes, three drops of a solution of one grain of sulphate of potash in six ounces of water were added to the muriatic solution; no appearance of precipitate was observed till next day, and therefore it contained no barytes, as in that case an immediate precipitate would have taken place.

C. Carbonate of potash was then added to the muriatic solution; a decomposition took place; and the carbonate of strontites was precipitated. This being subjected to a strong heat, the carbonic acid was driven off, and the whole of the remaining earth being dissolved in water, crystallized. After being dried, it weighed 69.5.

One hundred parts of this mineral therefore contain

| | |
|---------------|---------|
| Pure earth | 69.5 |
| Carbonic acid | 30. |
| Water | .5 |
| | <hr/> |
| | 100.0 † |

II. SALTS.

The analysis of minerals arranged under this class, is in general less difficult, in consequence of their easy solubility, than those already examined. We shall therefore give only one example.

Analysis of Native Saltpetre.

This native salt was examined by Klaproth †, according to the following method.

A. 1000 grains of the native salt, with limestone and gypsum to which it adhered, were covered with boiling water. The colourless solution was gently evaporated; during the crystallization, tender needle-shaped crystals of selenite appeared, and the whole of the solution crystallized to a perfect prismatic nitre. The selenite weighed 45 grains, and the salt amounted to 446 grains.

B. To ascertain whether any common salt could be detected in the mineral, the crystals were redissolved in water, and acetate of barytes was dropped into the solution. A precipitate was obtained, amounting to 26 grains of sulphate of barytes, shewing that 184 grains of selenite were still combined with the neutral salt. A solution of nitrate of silver was added to the nitric solution, which

produced a precipitate of 47 grains of muriate of silver, so that the quantity of common salt can only be estimated at two grains. The pure nitre is thus reduced to 425½ grains. Klaproth suspects that the neutral muriate mixed with the native nitre, is rather a muriate of potash, than muriate of soda.

C. The stony matters remaining amounted to 550 grains; muriatic acid was poured upon them, and produced great effervescence with pieces of limestone. One hundred and eighty-six grains of white gypsum remained; and the sulphuric acid being separated from it, by boiling with carbonate of potash, the carbonate of lime remaining behind dissolved without residuum in nitric acid.

D. The limestone taken up by the muriatic acid, weighed 304 grains. Being farther examined, it appeared to be calcareous earth, slightly contaminated with iron.

One hundred parts, therefore, of this salt contain

| | |
|-----------------------------|--------|
| Pure prismatic nitre B | 42.55 |
| Muriate of a neutral salt B | .22 |
| Sulphate of lime A B C | 25.45 |
| Carbonate of lime D | 30.4 |
| Loss | 1.4 |
| | <hr/> |
| | 100.00 |

III. COMBUSTIBLES.

Analysis of Coal.

The constituent parts of coal are carbone and bitumen, with some earthy matters, and sometimes a small quantity of metallic matter. The proportion of earthy matters contained in coal may be ascertained by weighing a determinate quantity, and burning it. The nature of the earths contained in the residuum may be discovered by the processes already given.

To ascertain the proportion of charcoal and bitumen contained in coal, we shall describe the method followed by Mr Kirwan.

It has been found that a certain proportion of carbone or pure charcoal, detonated with nitre in the state of ignition, decomposes a given proportion of that salt; and it appears from the experiments of Lavoisier, that 13.21 parts of charcoal decompose 100 parts of nitre, while the detonation is performed in close vessels; but in an open crucible, a smaller proportion of charcoal is required, in consequence of part of the nitre being decomposed by the action of the air of the atmosphere. According to Kirwan, about 10 parts of charcoal are sufficient to decompose 96 parts of nitre. Mr Kirwan also found that vegetable pitch and maltha did not produce any detonation with nitre, but merely burnt on its surface; and that the same quantity of charcoal was required for the decomposition of the nitre, as if no bituminous substance had been employed. Since, therefore, bitumen produces no effect in decomposing nitre, Kirwan thought that the proportion of charcoal, in any coal, might be ascertained by detonation with nitre. In this way the proportion of carbonaceous and earthy matter in any coal being discovered, the proportion of bitumen which it contains may be estimated by calculation.

In the experiments on the analysis of coal, Mr Kirwan employed a large crucible placed in a wind furnace, and exposed to an equable heat. The coal was reduced to

Combustible.

small pieces of the size of a pin head, and was projected in portions of one or two grains at a time, into the nitre, the moment it became red hot. This was continued till the detonation ceased.

By this process it appeared that 50 grains of Kilkenny coal were necessary to decompose 480 grains of nitre. According to the same proportion, 90 grains of nitre would have required for its decomposition 10 grains of coal, which is exactly equal to the quantity of charcoal that would have been required to produce the same effect; and thus it appeared that Kilkenny coal is almost entirely composed of carbonaceous matter.

In the examination of cannel coal, Mr Kirwan burnt 240 grains, till the whole of the carbonaceous matter was consumed; a residuum of seven grains and a half of reddish brown ashes, which appeared to be chiefly aluminous earth, was left, or about 3.12 per cent. Sixty-six grains and a half of this coal were found necessary to decompose 480 grains of nitre. Fifty grains of charcoal would have produced the same effect, and hence 66½ grains of coal contain 50 of charcoal, and 2.08 parts of ashes, which being subtracted from 66½ grains, leaves 11.42 for the quantity of bitumen contained in the coal. Hence the constituent parts of this coal are,

| | |
|----------|-------|
| Charcoal | 75.2 |
| Bitumen | 21.68 |
| Ashes | 3.1 |
| | 99.98 |

For a more particular analysis of combustible minerals, see Mr Hatchett's experiments, detailed in the Philosophical Transactions for 1804.

IV. Analysis of SOILS.

The examination of soils is by no means the least important, because on a knowledge of the nature and proportions of the ingredients which enter into the composition of soils, depends the opinion to be formed of their fertility. Soils consist of different combinations of the earths, mixed with a certain proportion of animal and vegetable matter. The investigation of the nature of soils has been particularly prosecuted by Mr Kirwan* and Mr Davy. From the observations of the latter, the following account of the analysis of soils is extracted.

* See his Treatise on Manures.

1. The really important instruments required for the analysis of soils are few, and but little expensive. They are, a balance capable of containing a quarter of a pound of common soil, and capable of turning when loaded with a grain; and a series of weights from a quarter of a pound troy to a grain; a wire sieve, sufficiently coarse to admit a pepper-corn through its apertures; an Argand lamp and stand; some glass bottles; Hessian crucibles; porcelain or queen's ware evaporating basins; a Wedgewood pebble and mortar; some filters made of half a sheet of blotting paper, folded so as to contain a pint of liquid, and greased at the edges; a bone knife, and an apparatus for collecting and measuring aeriform fluids.

The chemical substances or reagents required for separating the constituent parts of the soil, are muriatic acid (spirit of salt), sulphuric acid, and pure volatile alkali dissolved in water, solution of prussiate of potash, soap lye, solution of carbonate of ammonia, of muriate of ammonia, solution of neutral carbonate of potash, and nitrate of ammonia.

2. In cases when the general nature of the soil of a field is to be ascertained, specimens of it should be taken from different places, two or three inches below the surface, and examined as to the similarity of their properties. It sometimes happens, that upon plains the whole soils for analysis of the upper stratum of the land is of the same kind, and in this case one analysis will be sufficient; but in valleys, and near the beds of rivers, there are very great differences, and it now and then occurs that one part of a field is calcareous, and another part siliceous; and in this case, and in analogous cases, the portions different from each other should be separately submitted to experiment.

Soils.

Made of collecting for analysis.

Soils, when collected, if they cannot be immediately examined, should be preserved in phials quite filled with them, and closed with ground glass stoppers.

The quantity of soil most convenient for a perfect analysis is from two to four hundred grains. It should be collected in dry weather, and exposed to the atmosphere till it becomes dry to the touch.

The specific gravity of a soil, or the relation of its weight to that of water, may be ascertained by introducing into a phial, which will contain a known quantity of water, equal volumes of water and of soil; and this may be easily done by pouring in water till it is half full, and then adding the soil till the fluid rises to the mouth; the difference between the weight of the soil and that of the water will give the result. Thus, if the bottle contain 400 grains of water, and gains 200 grains when half filled with water and half with soil, the specific gravity of the soil will be two, that is, it will be twice as heavy as water; and if it gained 165 grains, its specific gravity would be 1.825, water being 1000.

It is of importance that the specific gravity of a soil should be known, as it affords an indication of the quantity of animal and vegetable matter it contains; these substances being always most abundant in the lighter soils.

The other physical properties of soils should likewise be examined before the analysis is made, as they denote, to a certain extent, their composition, and serve as guides in directing the experiments. Thus, siliceous soils are generally rough to the touch, and scratch glass when rubbed upon it; aluminous soils adhere strongly to the tongue, and emit a strong earthy smell when breathed on; and calcareous soils are soft, and much less adhesive than aluminous soils.

3. Soils, though as dry as they can be made by continued exposure to air, in all cases still contain a considerable quantity of water, which adheres with great obstinacy to the earths and animal and vegetable matter, and can only be driven off from them by a considerable degree of heat. The first process of analysis is, to free the given weight of the soil from as much of this water as possible, without, in other respects, affecting its composition; and this may be done by heating it for ten or twelve minutes over an Argand's lamp, in a basin of porcelain, to a temperature equal to 300 Fahrenheit; and in case a thermometer is not used, the proper degree may be easily ascertained, by keeping a piece of wood in contact with the bottom of the dish: as long as the colour of the wood remains unaltered, the heat is not too high; but when the wood begins to be charred, the process must be stopped. A small quantity of water will perhaps remain in the soil even after this operation,

Soils.

Made of collecting for analysis.

but

So-l. but it always affords useful comparative results; and if a higher temperature were employed, the vegetable or animal matter would undergo decomposition, and in consequence the experiment be wholly unfair.

The loss of weight in the process should be carefully noted; and when in 400 grains of soil it reaches as high as 50, the soil may be considered as in the greatest degree absorbent, and retentive of water, and will generally be found to contain a large proportion of aluminous earth. When the loss is only from 20 to 10, the land may be considered as only slightly absorbent and retentive, and the siliceous earth as most abundant.

4. None of the loose stones, gravel, or large vegetable fibres should be divided from the pure soil till after the water is drawn off; for these bodies are themselves often highly absorbent and retentive, and in consequence influence the fertility of the land. The next process, however, after that of heating, should be their separation, which may be easily accomplished by the sieve, after the soil has been gently bruised in a mortar. The weights of the vegetable fibres or wood, and of the gravel and stones, should be separately noted down, and the nature of the last ascertained; if calcareous, they will effervesce with acids; if siliceous, they will be sufficiently hard to scratch glass; and if of the common aluminous class of stones, they will be soft, easily scratched with a knife, and incapable of effervescing with acids.

5. The greater number of soils, besides gravel and stones, contain larger or smaller proportions of sand of different degrees of fineness; and it is a necessary operation, the next in the process of analysis, to detach them from the parts in a state of more minute division, such as clay, loam, marle, and vegetable and animal matter. This may be effected in a way sufficiently accurate, by agitation of the soil in water. In this case, the coarse sand will generally separate in a minute, and the finer in two or three minutes; whilst the minutely divided animal or vegetable matter will remain in a state of mechanical suspension for a much longer time; so that, by pouring the water from the bottom of the vessel, after one, two, or three minutes, the sand will be principally separated from the other substances, which, with the water containing them, must be poured into a filter, and, after the water has passed through, collected, dried, and weighed. The sand must likewise be weighed, and their respective quantities noted down. The water of lixiviation must be preserved, as it will be found to contain the saline matter, and the soluble animal or vegetable matters, if any exist in the soil.

6. By the process of washing and filtration, the soil is separated into two portions, the most important of which is generally the finely divided matter. A minute analysis of the sand is seldom or never necessary, and its nature may be detected in the same manner as that of the stones or gravel. It is always either siliceous sand, or calcareous sand, or a mixture of both. If it consist wholly of carbonate of lime, it will be rapidly soluble in muriatic acid, with effervescence; but if it consist partly of this substance, and partly of siliceous matter, the respective quantities may be ascertained by weighing the residuum after the action of the acid, which must be applied till the mixture has acquired a sour taste, and has ceased to effervesce. This residuum is the siliceous part; it must be washed, dried, and heated strongly in a crucible: the difference between the

weight of the whole, indicates the proportion of calcareous sand.

7. The finely divided matter of the soil is usually very compound in its nature; it sometimes contains all the four primitive earths of soils, as well as animal and vegetable matter; and to ascertain the proportions of these, with tolerable accuracy, is the most difficult part of the subject.

The first process to be performed, in this part of the analysis, is the exposure of the fine matter of the soil to the action of the muriatic acid. This substance should be poured upon the earthy matter in an evaporating basin, in a quantity equal to twice the weight of the earthy matter; but diluted with double its volume of water. The mixture should be often stirred, and suffered to remain for an hour or an hour and a half before it is examined.

If any carbonate of lime or of magnesia exist in the soil, they will have been dissolved in this time by the acid, which sometimes takes up likewise a little oxide of iron; but very seldom any alumina.

The fluid should be passed through a filter; the solid matter collected, washed with rain water, dried at a moderate heat, and weighed. Its loss will denote the quantity of solid matter taken up. The washings must be added to the solution; which, if not sour to the taste, must be made so by the addition of fresh acid, when a little solution of common prussiate of potash must be mixed with the whole. If a blue precipitate occur, it denotes the presence of oxide of iron, and the solution of the prussiate must be dropped in till no further effect is produced. To ascertain its quantity, it must be collected in the same manner as other solid precipitates, and heated: the result is oxide of iron.

Into the fluid freed from oxide of iron, a solution of neutralized carbonate of potash must be poured till all effervescence ceases in it, and till its taste and smell indicate a considerable excess of alkaline salt.

The precipitate that falls down is carbonate of lime; it must be collected on the filter, and dried at a heat below that of redness.

The remaining fluid must be boiled for a quarter of an hour, when the magnesia, if any exist, will be precipitated from it, combined with carbonic acid, and its quantity is to be ascertained in the same manner as that of the carbonate of lime.

If any minute proportion of alumina should, from peculiar circumstances, be dissolved by the acid, it will be found in the precipitate with the carbonate of lime, and it may be separated from it by boiling for a few minutes with soap lye, sufficient to cover the solid matter. This substance dissolves alumina, without acting upon carbonate of lime.

Should the finely divided soil be sufficiently calcareous to effervesce very strongly with acids, a very simple method may be adopted for ascertaining the quantity of carbonate of lime, and one sufficiently accurate in all common cases.

Carbonate of lime, in all its states, contains a determinate proportion of carbonic acid, *i. e.* about 45 per cent.; so that when the quantity of this elastic fluid, given out by any soil during the solution of its calcareous matter in an acid, is known, either in weight or measure, the quantity of carbonate of lime may be easily discovered.

So-l. Examination of the finely divided matter of soils, and mode of detecting lime and magnesia.

So-l.

4 Separation of stones, &c.

5 Separation of the sand and clay, or loam, from each other.

6 Examination of the sand.

When.

Subt.

When the process by diminution of weight is employed, two parts of the acid and one part of the matter of the foil must be weighed in two separate bottles, and very slowly mixed together till the effervescence ceases; the difference between their weight before and after the experiment denotes the quantity of carbonic acid lost; for every four grains and a half of which, ten grains of carbonate of lime must be eliminated.

The best method of collecting the carbonic acid, so as to discover its volume, is by the pneumatic apparatus, the construction and application of which are described at the end of this article. The estimation is, for every ounce measure of carbonic acid, two grains of carbonate of lime.

8
Mode of
ascertain-
ing the
quantity
of minute
finely di-
vided ani-
mal and
vegetable
matter.

8. After the fine matter of the foil has been acted upon by muriatic acid, the next process is to ascertain the quantity of finely divided insoluble animal and vegetable matter that it contains.

This may be done with sufficient precision, by heating it to strong ignition in a crucible over a common fire till no blackness remains in the mass. It should be often stirred with a metallic wire, so as to expose new surfaces continually to the air; the loss of weight that it undergoes denotes the quantity of the substance that it contains destructible by fire and air.

It is not possible to ascertain whether this substance is wholly animal or vegetable matter, or a mixture of both. When the smell emitted during the incineration is similar to that of burnt feathers, it is a certain indication of some animal matter; and a copious blue flame at the time of ignition almost always denotes a considerable proportion of vegetable matter. In cases when the experiment is needed to be very quickly performed, the destruction of the decomposable substances may be assisted by the agency of nitrate of ammonia, which, at the time of ignition, may be thrown gradually upon the heated mass, in the quantity of twenty grains for every hundred of residual oil. It affords the principle necessary to the combustion of the animal and vegetable matter, which it causes to be converted into elastic fluids; and it is itself at the same time decomposed and lost.

9
Mode of
separating
aluminous
and siliceous
matter
from oxides
of iron.

9. The substances remaining after the decomposition of the vegetable and animal matter, are generally minute particles of earthy matter containing usually alumina and silica with combined oxide of iron.

To separate these from each other, the solid matter should be boiled for two or three hours with sulphuric acid, diluted with four times its weight of water; the quantity of the acid should be regulated by the quantity of solid residuum to be acted on, allowing for every hundred grains two drachms or one hundred and twenty grains of acid.

The substance remaining after the action of the acid may be considered as siliceous; and it must be separated and its weight ascertained, after washing and drying in the usual manner.

The alumina and the oxide of iron, if they exist, are both dissolved by the sulphuric acid; they may be separated by carbonate of ammonia, added to excess; it throws down the alumina, and leaves the oxide of iron in solution; and this substance may be separated from the liquid by boiling.

Should any magnesia and lime have escaped solution in the muriatic acid, they will be found in the sulphuric acid; this, however, is scarcely ever the case; but

the process for detecting them, and ascertaining their quantities, is the same in both instances.

The method of analysis by sulphuric acid is sufficiently precise for all usual experiments; but if very great accuracy be an object, dry carbonate of potash must be employed as the agent, and the residuum of the incineration must be heated red for half an hour, with four times its weight of this substance, in a crucible of silver, or of well baked porcelain. The mass obtained must be dissolved in muriatic acid, the solution evaporated till it is nearly solid; distilled water must then be added, by which the oxide of iron and all the earths, except silica, will be dissolved in combination as muriates. The flux, after the usual process of lixiviation, must be heated red; the other substances may be separated in the same manner as from the muriatic and sulphuric solutions.

10. If any saline matter, or soluble vegetable or animal matter, be suspected in the foil, it will be found in the water of lixiviation used for separating the sand.

This water must be evaporated to dryness in an appropriate dish, at a heat below its boiling point.

If the solid matter obtained is of a brown colour and inflammable, it may be considered as partly vegetable extract. If its smell, when exposed to heat, be strong and fetid, it contains animal mucilaginous or gelatinous substance; if it be white and transparent, it may be considered as principally saline matter. Nitrate of potash (nitre), or nitrate of lime, is indicated in this saline matter, by its detonating with a burning coal. Sulphate of magnesia may be detected by its bitter taste; and sulphate of potash produces no alteration in solution of carbonate of ammonia, but precipitates solution of muriate of barytes.

11. Should sulphate or phosphate of lime be suspected in the entire foil, the detection of them requires a particular process upon it. A given weight of it, for instance four hundred grains, must be heated red for half an hour in a crucible, mixed with one third of powder, and photod charcoal. The mixture must be boiled for a quarter of an hour, in a half pint of water, and the fluid collected through the filter, and exposed for some days to the atmosphere in an open vessel. If any soluble quantity of sulphate of lime (gypsum) existed in the foil, a white precipitate will gradually form in the fluid, and the weight of it will indicate the proportion.

Phosphate of lime, if any exist, may be separated from the foil after the process for gypsum. Muriatic acid must be digested upon the foil, in quantity more than sufficient to saturate the soluble earths; the solution must be evaporated, and water poured upon the solid matter. This fluid will dissolve the compounds of earths with the muriatic acid, and leave the phosphate of lime untouched.

12. When the examination of a foil is completed, the products should be classed, and their quantities added together; and if they nearly equal the original quantity of foil, the analysis may be considered as accurate. It must however be noticed, that when phosphate or sulphate of lime is discovered by the independent process 11, a correction must be made for the general process, by subtracting a sum equal to their weight from the quantity of carbonate of lime obtained by precipitation from the muriatic acid.

In arranging the products, the form should be in the order

Soils.

10
Mode of
discovering
soluble ani-
mal and
vegetable
matter,
and saline
matter.

11
Mode of
detecting
sulphate
of lime
(gypsum)
and phos-
phate of
lime in
soils.

12
Results &
products.

Soils. order of the experiments by which they were obtained.

Thus, 400 grains of a good siliceous sandy soil may be supposed to contain

| | | | | |
|---|---|---|-----|------|
| Of water of absorption | - | - | 18 | grs. |
| Of loose stones and gravel, principally siliceous, | - | - | 42 | |
| Of undecomposed vegetable fibres | - | - | 10 | |
| Of fine siliceous sand | - | - | 200 | |
| Of minutely divided matter separated by filtration, and consisting of | - | - | | |
| Carbonate of lime | - | - | 25 | |
| Carbonate of magnesia | - | - | 4 | |
| Matter destructible by heat, principally vegetable, | - | - | 10 | |
| Silica | - | - | 40 | |
| Alumina | - | - | 32 | |
| Oxide of iron | - | - | 4 | |
| Soluble matter, principally sulphate of potash and vegetable extract, | - | - | 5 | |
| Gypsum | - | - | 3 | |
| Phosphate of lime | - | - | 2 | |
| Amount of all the products | - | - | 395 | |
| Loss | - | - | 5 | |

In this instance the loss is supposed small; but in general, in actual experiments, it will be found much greater, in consequence of the difficulty of collecting the whole quantities of the different precipitates; and when it is within thirty for four hundred grains, there is no reason to suspect any want of due precision in the processes.

13. A very fertile corn soil from Ormonist in East Lothian afforded, in 100 parts, only 11 parts of mild calcareous earth; it contained 25 parts of siliceous sand: the finely divided clay amounted to 45 parts. It lost nine in decomposed animal and vegetable matter, and four in water, and afforded indications of a small quantity of phosphate of lime.

This soil was of a very fine texture, and contained very few stones or vegetable fibres. It is not unlikely that its fertility was in some measure connected with the phosphate; for this substance is found in wheat, oats, and barley, and may be a part of their food.

A soil from the low lands of Somersetshire, celebrated for producing excellent crops of wheat and beans without manure, was found to consist of one-ninth of sand, chiefly siliceous, and eight-ninths of calcareous marl tinged with iron, and containing about five parts in 100 of vegetable matter. No phosphate or sulphate of lime could be detected in it; but that its fertility must have depended principally upon its power of attracting principles of vegetable nourishment from water and the atmosphere.

14. Mr Tillet, in some experiments made on the composition of soils at Paris, found that a soil composed of three-eighths of clay, two-eighths of river sand, and three-eighths of the parings of limestone, was very proper for wheat.

14. In general, bulbous roots require a soil much more sandy and less absorbent than the grasses. A very good potato soil, from Warfel in Cornwall, afforded seven-eighths of siliceous sand; and its absorbent power

was so small, that 100 parts lost only two by drying at 400 Fahrenheit.

Plants and trees, the roots of which are fibrous and hard, and capable of penetrating deep into the earth, will vegetate to advantage in almost all common soils which are moderately dry, and which do not contain a very great excess of vegetable matter.

The soil taken from a field at Suenfield-place in Suffolk, remarkable for producing flourishing oaks, was found to consist of six parts of sand, and one part of clay and finely divided matter. And 100 parts of the entire soil, submitted to analysis, produced

| | | | | |
|------------------------------|---|---|----|-------|
| Water | - | - | 3 | parts |
| Silica | - | - | 54 | |
| Alumina | - | - | 28 | |
| Carbonate of lime | - | - | 3 | |
| Oxide of iron | - | - | 5 | |
| Decomposing vegetable matter | - | - | 4 | |
| Loss | - | - | 3 | |

15. From the great difference of the causes that influence the productiveness of lands, it is obvious that, in the present state of science, no certain system can be devised for their improvement, independent of experience: but there are few cases in which the labour of analytical trials will not be amply repaid by the certainty with which they denote the best methods of amelioration; and this will particularly happen when the defect of composition is found in the proportions of the primitive earths.

In supplying animal or vegetable manure, a temporary food only is provided for plants, which is in all cases exhausted by means of a certain number of crops; but when a soil is rendered of the best possible constitution and texture, with regard to its earthy parts, its fertility may be considered as permanently established. It becomes capable of attracting a very large portion of vegetable nourishment from the atmosphere, and of producing its crops with comparatively little labour and expence.

Description of the Apparatus for the Analysis of Soils.

Plate
DIX.

A, Retort.

B, B, Funnels for the purpose of filtering.

D, Balance.

E, Argand's Lamp.

F, G, H, K, The different parts of the apparatus required for measuring the quantity of elastic fluid given out during the action of an acid on calcareous soils.

F, Represents the bottle for containing the soil.

K, The bottle containing the acid furnished with a stopcock.

G, The tube connected with a flaccid bladder.

I, The graduated measure.

H, The bottle for containing the bladder. When this instrument is used, a given quantity of soil is introduced into F: K is filled with muriatic acid diluted with an equal quantity of water; and the stopcock being closed is connected with the upper orifice of I, which is ground to receive it. The tube G is introduced into the lower orifice of F, and the bladder connected with it, placed in its natural state into H, which is filled with water. The graduated measure is placed under the tube of H. When the stopcock of K is turned

cd, the acid flows into F, and acts upon the foil; the elastic fluid generated passes through G into the bladder, and displaces a quantity of water in H equal to it in bulk, and this water flows through the tube into the graduated measure; the water in which gives by its volume the indication of the proportion of carbonic acid

disengaged from the foil; for every ounce measure of which two grains of carbonate of lime may be eliminated.

L, Represents the stand for the lamp.
M, N, O, P, Q, R, S, Represent the bottles containing the different reagents.*

Soils.

* Plin.
Mag. vol.
Anni. p. 16

S T O

S T O

Stones.

Artificial STONE. See *STRUCCO.*

Elastic STONE. Some marbles possess the property of elasticity, and hence come under the denomination of elastic stones. But the most remarkable stone of this nature is the elastic sandstone from Brazil. It is a micaceous sandstone in laminae not exceeding half an inch in thickness. Some siliceous stones also have the same property, or acquire it by being exposed to a certain degree of heat.

Philosopher's STONE. See *PHILOSOPHER'S Stone.**Precious STONES.* See *GEM.*

Rocking STONE, or *Logan,* a stone of a prodigious size, so exactly poised, that it would rock or flake with the smallest force. Of these stones the ancients give us some account. Pliny says, that at Harpasa, a town of Asia, there was a rock of such a wonderful nature, that if touched with the finger it would shake, but could not be moved from its place with the whole force of the body*. Ptolemy Hephestion mentions † a gygonian stone near the ocean, which was agitated when struck by the stalk of an asphodel, but could not be removed by a great exertion of force. The word *gygonius* seems to be Celtic; for *gwingog* signifies *motians*, the rocking-stone.

Many rocking stones are to be found in different parts of this island; some natural, others artificial, or placed in their position by human art. In the parish of St Leven, Cornwall, there is a promontory called *Castle Treryn.* On the western side of the middle group, near the top, lies a very large stone, so evenly poised that any hand may move it from one side to another; yet it is so fixed on its base, that no lever nor any mechanical force can remove it from its present situation. It is called the *Logan-stone,* and is at such a height from the ground that no person can believe that it was raised to its present position by art. But there are other rocking stones, which are so shaped and so situated, that there can be no doubt but they were erected by human strength. Of this kind Borlase thinks the great *Quoit* or *Karn-lehau,* in the parish of Tywidnek, to be. It is 39 feet in circumference, and four feet thick at a medium, and stands on a single pedestal. There is also a remarkable stone of the same kind in the island of St Agnes in Scilly. The under rock is 10 feet six inches high, 47 feet round the middle, and touches the ground with no more than half its base. The upper rock rests on one point only, and is so nicely balanced, that two or three men with a pole can move it. It is eight feet six inches high, and 47 in circumference. On the top there is a basin hollowed out, three feet eleven inches in diameter at a medium, but wider at the brim, and three feet deep. From the globular shape of this upper stone, it is highly probable that it was rounded by human art,

and perhaps even placed on its pedestal by human strength. In Sithney parish, near Helston, in Cornwall, stood the famous logan, or rocking stone, commonly called *Men Amber,* q. d. *Men an Bar,* or the *top-stone.* It was eleven feet by six, and four high, and so nicely poised on another stone that a little child could move it, and all travellers who came this way desired to see it. But Shrubhall, Cromwell's governor of Pendennis, with much ado caused it to be undermined, to the great grief of the country. There are some marks of the tool on it, and, by its quadrangular shape, it was probably dedicated to Mercury.

That the rocking stones are monuments erected by the Druids cannot be doubted; but tradition has not informed us for what purpose they were intended. Mr Toland thinks that the Druids made the people believe that they alone could move them, and that by a miracle; and that by this pretended miracle they condemned or acquitted the accused, and brought criminals to confess what could not otherwise be extorted from them. How far this conjecture is right we shall leave to those who are deeply versed in the knowledge of antiquities to determine.

Sonorous STONE, a kind of stone remarkable for emitting an agreeable sound when struck, and much used in China for making musical instruments which they call *king.*

The various kinds of sonorous stones known in China differ considerably from one another in beauty, and in the strength and duration of their tone; and what is very surprising, is that this difference cannot be discovered either by the different degrees of their hardness, weight, or fineness of grain, or by any other qualities which might be supposed to determine it. Some stones are found remarkably hard, which are very sonorous; and others exceedingly soft, which have an excellent tone; some extremely heavy emit a very sweet sound; and there are others as light as pumice stone which have also an agreeable sound.

The chemists and naturalists of Europe have never yet attempted to discover, whether some of our stones may not have the same properties as the sonorous stones of the extremities of Asia. It however appears, that the Romans were formerly acquainted with a sonorous stone of the class of *hiang-che.* Pliny (says the Abbé du Bos, in his Reflections on Poetry and Painting, when speaking of curious stones) observes that the stone called *chalcephonas,* or *brazen sound,* is black; and that, according to the etymology of its name, it sends forth a sound much resembling that of brass when it is struck. The passage of Pliny is as follows: *Chalcephonas nigra est; sed ejus avis tinnitum reddit.*

Some sonorous stones were at length sent into France,

Stones.

Borlase,
chap. iv.
p. 181.

* Eib. II.

c. 60.

† Lab. III.

c. 3.

and the late Duke de Chaulnes examined them with particular attention. The following are some of his observations: "The Academy of Sciences, Mr Romé de Lillie, and several other learned mineralogists, when asked if they were acquainted with the black flone of which the Chinese king was made, for answer cited the passage of Pliny mentioned by Boethius de Bott, Linnæus, and in the Dictionary of Bomare, and added what Mr Anderson says in his Natural History of Iceland respecting a bluish kind of flone which is very sonorous. As the black flone of the Chinese becomes of a bluish colour when filed, it is probably of the same species. None of the rest who were consulted had ever seen it. The Chinese flone has a great resemblance at first sight to black marble, and like it is calcareous; but marble generally is not sonorous. It also externally resembles touchstone, which is a kind of basalt, and the basaltos found near volcanoes; but these two flones are vitrifications."

The duke next endeavoured to procure some information from the flone-cutters. They all replied, that blue-coloured marble was very sonorous, and that they had seen large blocks of it which emitted a very strong sound; but the duke having ordered a king to be constructed of this kind of flone, it was found that it did not possess that property. By trying the black marble of Flanders, a piece was at length found which emitted an agreeable sound: it was cut into a king, which is almost as sonorous as those of China. All these observations give us reason to believe that the flones of which the king are formed are nothing else but a black kind of marble, the constituent parts of which are the same as those of the marble of Europe, but that some difference in their organization renders them more or less sonorous.

Swine-STONE (*lapis fuillus*), or *stetid flone*, so called from its excessively fetid smell, is a calcareous flone impregnated with petroleum. See *MINERALOGY Index*.

STONE-Marrow, a variety of clay so called from its having the appearance of marrow.

STONE-Ware, a species of pottery so called from its hardness. See *DELFT-Ware* and *PORCELAIN*.

STONE in the Bladder. See *MEDICINE*, N° 407, and *SURGERY Index*.

STONE, in merchandize, denotes a certain weight for weighing commodities. A flone of beef at London is the quantity of eight pounds: in Herefordshire 12 pounds: in the North 16 pounds. A flone of glass is five pounds; of wax eight pounds. A flone of wool (according to the statute of 11 Hen. VII.) is to weigh 14 pounds; yet in some places it is more, in others less; as in Gloucestershire 15 pounds; in Herefordshire 12 pounds. Among horse-couriers a flone is the weight of 14 pounds.

The reason of the name is evident. Weights at first were generally made of flone. See *Deut. xxv. 13*, where the word כֶּסֶף, translated *weight*, properly signifies a flone.

STONE-Chatter. See *MOTACILLA*, *ORNITHOLOGY Index*.

STONEHENGE, a celebrated monument of antiquity, stands in the middle of a flat area near the summit of a hill six miles distant from Salisbury. It is inclosed by a circular double bank and ditch near 30 feet broad, after crossing which we ascend 30 yards before we reach the work. The whole fabric consisted of two

circles and two ovals. The outer circle is about 133 feet diameter, consisting when entire of 60 flones, 30 uprights and 30 imposts, of which remain only 24 uprights, 17 standing and 7 down, 3 feet asunder, and 8 imposts. Eleven uprights have their 5 imposts on them by the grand entrance. These flones are from 13 to 20 feet high. The lesser circle is somewhat more than 8 feet from the inside of the outer one, and consisted of 40 lesser flones (the highest 6 feet), of which only 19 remain, and only 11 standing: the walk between these two circles is 300 feet in circumference. The *Adytum* or *Cell* is an oval formed of 10 flones (from 16 to 22 feet high), in pairs, with imposts, which Dr Stukeley calls *trilithons*, and above 30 feet high, rising in height as they go round, and each pair separate, and not connected as the outer pair; the highest 8 feet. Within these are 19 more smaller single flones, of which only 6 are standing. At the upper end of the *Adytum* is the altar, a large slab of blue coarse marble, 22 inches thick, 16 feet long, and 4 broad; pressed down by the weight of the vast flones that have fallen upon it. The whole number of flones, uprights, imposts, and altar, is exactly 140. The flones are far from being artificial, but were most probably brought from those called the *Grey Weathers* on Marlborough Downs, 15 or 16 miles off; and if tried with a tool they appear of the same hardness, grain, and colour, generally reddish. The heads of oxen, deer, and other beasts, have been found on digging in and about Stonehenge; and human bones in the circumjacent barrows. There are three entrances from the plain to this structure, the most considerable of which is from the north-east, and at each of them were raised on the outside of the trench two huge flones with two smaller within parallel to them.

It has been long a dispute among the learned, by what nation, and for what purpose, these enormous flones were collected and arranged. The first account of this structure we meet with is in Geoffrey of Monmouth, who, in the reign of King Stephen, wrote the history of the Britons in Latin. He tells us, that it was erected by the counsel of Merlin the British enchanter, at the command of Aurelius Ambrosius the last British king, in memory of 460 Britons who were murdered by Hengist the Saxon. The next account is that of Polydore Virgil, who says that the Britons erected this as a sepulchral monument of Aurelius Ambrosius. Others suppose it to have been a sepulchral monument of Boadicea the famous British queen. Inigo Jones is of opinion, that it was a Roman temple; from a flone 16 feet long, and four broad, placed in an exact position to the eastward altar-fashion. Mr Charlton attributed it to the Danes, who were two years masters of Wiltshire. A tin tablet, on which were some unknown characters, supposed to be Punic, was dug up near it in the reign of Henry VIII. but is lost; probably that might have given some information respecting its founders. Its common name, *Stonehenge*, is Saxon, and signifies a "flone gallows," to which these flones, having transverse imposts, bear some resemblance. It is also called in Welch *choir gaur*, or "the giants dance."

Mr Grose thinks that Dr Stukeley has completely proved this structure to have been a British temple in which the Druids officiated. He supposes it to have been the metropolitan temple of Great Britain, and

Stone-
henge
||
Stopper.

G of 2
A. 191
T. 6.
Vol. IV.
P. 90.

translates the words *choir gour* "the great choir or temple." The learned Mr Bryant is of opinion that it was erected by a colony of Cushites probably before the time of the Druids; because it was usual with them to place one vault alone upon another for a religious memorial; and these they often placed so equally, that even a breath of wind would sometimes make them vibrate. Of such stones one remains at this day in the pile of Stonehenge. The ancients distinguished stones erected with a religious view, by the name of *amber*; by which was signified any thing solar and divine. The Grecians called them *πυργαί αμβροσίας, petrae ambrosiæ*. Stonehenge, according to Mr Bryant, is composed of these amber stones: hence the next town is denominated *Ambrosbury*; not from a Roman Ambrosius, for no such person ever existed, but from the *ambrosiæ petrae*, in whose vicinity it stood. Some of these were rocking stones; and there was a wonderful monument of this sort near Penzance in Cornwall, which still retains the name of *mam-amber*, or the sacred stones. Such a one is mentioned by Apollonius Rhodius, supposed to have been raised in the time of the Argonautæ, in the island Tenos, as the monument of the two-winged sons of Boreas, slain by Hercules; and there are others in China and other countries.

STOOK, a term used in many parts of the kingdom for a shock of corn containing 12 sheaves.

STOOL, in *Medicine*, an evacuation or discharge of the feces by the anus.

STOOL, in *Mining*, is used when the miners leave off digging deeper, and work in the ends forward. The end before them is called the *stool*.

STOOL, in *Ship building*, the name of the supporters of the poop and top lanterns.

STOOPING, in *Falconry*, is when a hawk, being upon her wings at the height of her pitch, bends down violently to take the fowl.

STOPPERS, in a ship, certain short pieces of rope, which are usually knotted at one or both ends, according to the purpose for which they are designed. They are either used to suspend any heavy body, or to retain a cable, shroud, &c. in a fixed position. Thus, the anchors, when first hoisted up from the ground, are hung to the cat head by a stopper attached to the latter, which passing through the anchor-ring, is afterwards fastened to the timber-head; and the same rope serves to fasten it on the bow at sea; or to suspend it by the ring which is to be sunk from the ship to the bottom. The stoppers of the cable have a large knot and a lanard at one end, and are fastened to a ring-bolt in the deck by the other. They are attached to the cable by the lanard, which is fastened securely round both by several turns passed behind the knot, or about the neck of the stopper; by which means the cable is restrained from running out of the ship when the rides at anchor.

The stoppers of the shroud have a knot and a lanard at each end. They are only used when the shrouds are cut asunder in battle, or disabled by tempestuous weather: at which time they are lashed, in the same manner as those of the cables, to the separated parts of the shroud, which are thereby reunited, so as to be fit for immediate service. This, however, is only a temporary expedient.

STOPS. See PUNCTUATION; and SCRIPTURE, N^o 136.

STORAX. See STYRAX, MATERIA MEDICA *Index*.

STORK. See ARDEA, ORNITHOLOGY *Index*.

STOVE for heating apartments, greenhouses, hot-houses, fruit-walls, &c.

When treating of the mechanical properties of air, we explained in sufficient detail the manner in which the expansion produced in a mass of air by heat produces that motion up our chimneys which is called the draught of the chimney; and, in the article **SMOKE**, we considered the circumstances which tend to check, to promote, or to direct this current, so as to free us from the smoke and vitiated air which necessarily accompanies the consumption of the fuel. In **PNEUMATICS** we also attended to the manner in which our fires immediately operate in warming our apartments. At present, when about to describe a method of warming intrinsically different, we must pay some more attention to the distinguishing circumstance. Without pretending to explain the physical connection of heat and light, it may suffice to observe, that heat, as well as light, is communicated to distant bodies in an instant by radiation. A person passing hastily by the door of a glass-house feels the glow of heat in the very moment he sees the dazzling light of the furnace mouth, and it is interrupted by merely screening his face with his hand. In this way is an apartment partly warmed by an open fire; and we avoid the oppressive heat by sitting where the fire is not seen, or by interposing a screen. We are apt to connect this so strongly in the imagination with the light emitted by the fire, that we attribute the heat to the immediate action of the light. But this opinion is shown to be gratuitous by a curious experiment made before the Royal Society by Dr Hooke, and afterwards, with more care and accurate examination, by Mr Scheele. They found, that by bringing a plate of the most transparent glass briskly between the fire and one's face, the heat is immediately intercepted without any sensible diminution of the light. Scheele, by a very pretty investigation, discovered that the glass made the separation, and did it both in refraction and reflection; for he found, that when the light of the same fire was collected into a focus by means of a polished metal concave speculum, a thermometer placed there was *insensibly* affected. But if we employ a glass speculum foiled in the usual manner with quicksilver, of the same diameter and focal distance, and of equally brilliant reflection, there is hardly any sensible heat produced in the focus, and the thermometer must remain there for a very long while before it is sensibly affected. When we repeated this curious experiment, we found, that after the glass has remained a long while in this position, whether transmitting or reflecting the light, it loses in a great measure its power of intercepting the heat. By varying this observation in many of its circumstances, we think ourselves entitled to conclude, that the glass absorbs the heat which it intercepts, and is very quickly heated by the absorption. While it rises in its own temperature, it intercepts the heat powerfully; but when it is, as it were, saturated, attracting no more than what it immediately imparts to the air in corporeal contact with it, the heat passes freely through along with the light. If

the

Stops
||
Stove.

Stove. the glass be held so near the fire that the surrounding air is very much heated, no sensible interruption of heat is perceived after the glass is thus saturated. We found the cheek more quickly sensible than the thermometer of this instantaneous radiation of the heat which accompanies the light, or is separated from it in this experiment. It is a very instructive experiment in the physiology of heat.

We cannot say how far this radiation of heat may extend, nor whether the accompaniment of light is absolutely necessary. The mathematician proceeds on the supposition that it extends as far as the radiation of light, and that, being also rectilinear, the density of the heat is proportional to that of the light. But these notions are somewhat gratuitous; and there are appearances which render them doubtful. When with a lens of an inch in diameter we form a focus on a piece of black unpolished marble of an inch diameter, the mathematician must allow that no more rays fall on the marble than if the lens were away: therefore the marble should be equally warmed in either case. But it is by no means so, as we have repeatedly found by exposing it during equal times, and then dropping it into water. The water which is heated by the marble on which the focus has been formed will be found to have acquired from it much more heat than from the other. The tops of lofty mountains which are never shaded by clouds, but enjoy perpetual sunshine and serenity, instead of being warmer than the valleys below, are covered with never-melting snow; and we have some grounds to suspect that the genial influence of the sun requires the co-operation of the atmosphere, and to doubt whether there is any warmth at the moon, on which no atmosphere like ours can be observed. Perhaps the heat which cheers us, and fertilizes our earth, is chemically separated from our atmosphere by its elective attraction for the light of the sun. Our successors in the study of meteorology need not fear that the subject of their research will be soon deprived of scientific allurements. We know but little of it after all the progress we have made during this last century, and it still presents an ample field of discussion.

We said that the accompaniment of light is not demonstrably necessary. We are certain that heat may be imparted without any sensible light, in a manner which we can hardly suppose any thing but radiation. If a piece of very hot iron be placed a little without the principal focus of a metallic concave speculum, and a very sensible air-thermometer be placed in its conjugate focus, it will instantly show an elevation of temperature, although the iron is quite impervious to the eye which has even been a long while in the dark. No such rise of temperature is observed if the thermometer be placed a little to one side of the focus of the speculum; therefore the phenomenon is precisely similar to the radiation of light. We are obliged therefore to acknowledge that the heat is radiated in this experiment in the same way that light is in the common optical experiments.

Although this is the most usual way that we in this country employ fuel for warming our apartments, it is by no means the only way in which the heat diffused from this fuel may be imparted to distant bodies. It is not even the most effectual method; it is diffused also by immediate communication to bodies in contact. The air in immediate contact with the burning fuel is heated,

and imparts some of its heat to the air lying beyond it, and this is partly shared with the air which is still further off; and this diffusion, by communication *en contact*, goes on till the remote air contiguous to the walls, the floor, the ceiling, the furniture, the company, all get a share of it in proportion to their attractions and their capacities. And as the air is thus continually supplied, and continually gives out heat, the walls, &c. become gradually warmer, and the room becomes comfortable and pleasant. But we apprehend that no great proportion of the heat actually acquired by the room is communicated in this way. This diffusion by contact is but slow, especially in air which is very dry; so slow indeed, that the air in the immediate neighbourhood of the fuel is hurried up the chimney before it has time to impart any of the heat received in contact. We know that the time employed in diffusing itself in this way through stagnant air to any moderate distance is very considerable. We imagine therefore that the heat communicated to our rooms by an open fire is chiefly by radiation, but in a way something different from what we mentioned before. We imagine, that as the piece of glass in Dr Hooke's experiment absorbs the heat, so the whole mass of air which fills the room intercepts the radiated heat in every part of the room where the fire is seen, and is as it were saturated with it throughout, and ready to impart it to every body immersed in it. We cannot otherwise account for the *equality* of the heat in the different parts of the room. Mere radiation on the solid bodies would warm them in the inverse duplicate ratio of their distances from the fire; and diffusion by contact, if compatible with the rapid current up the chimney, would heat the room still more unequally. Recollect how slowly, and with what rapid diminution of intensity, the colour of blue vitriol is communicated to water even to a very small distance. But because all parts of the air of the room absorb radiated heat, what is saturated at a higher temperature, being nearer to the fire, rises to the ceiling, fires outwards along the ceiling, and has its place supplied by the air, which is thus pushed towards the fire from the places which are not directly illuminated.

Far different is the method of warming the room by a stove. Here the radiation, if any, is very feeble or scanty; and if a passage were allowed up the chimney for the warmed air, it would be quickly carried off. This is well known to the English who reside in the cold climates of St Peterburgh, Archangel, &c. They love the exhilarating flutter of an open fire, and often have one in their parlour; but this, so far from warming the room during the extreme cold weather, obliges them to heat their stoves more frequently, and even abstracts the heat from a whole suite of apartments. But all passage this way is that up when we warm a room by stoves. The air immediately contiguous to the stove is heated by contact, and this heat is gradually, though slowly, diffused through the whole room. The diffusion would however be very slow indeed, were it not for the great expansibility of air by heat. But the air surrounding the stove quickly expands and rises to the ceiling, while the neighbouring air slides in to supply the place, may be even pushed in by the air which goes outwards aloft. Thus the whole air is foam mixed, and the room acquires almost an equal temperature throughout.

The warming by stoves must therefore be managed upon very different principles from those adopted in the employment of open fires. The general principle is, 1st, To employ the fuel in the most effectual manner for heating the external part of the stove, which is immediately efficient in warming the contiguous air; and, 2d, To keep in the room the air already warmed, at least as much as is consistent with wholesomeness and cleanliness.

The first purpose is accomplished by conducting the flue of the furnace round its external parts, or, in short, by making every part of the flue external. Of all forms, that of a long pipe, returned backwards and forwards, up and down (provided only that the place of its last discharge be considerably higher than its entry from the fire-place), would be the most effectual. We have seen a very small stove constructed in this way, the whole being inclosed in a handsome case of polished iron plate, pierced and cut into elegant foliage like the cock of a watch, so that the odd looking pipes were completely concealed. Though only three feet long, one foot thick, and six feet high, it warmed a very lofty room of 24 feet by 18, and consumed less than half the fuel of a stove of the more usual make, which did not so fully warm a smaller chamber.

It would occupy a volume to describe the immense variety of stoves which ingenuity or architectonic taste has constructed. We shall content ourselves with giving a specimen of the two chief classes into which they may be distinguished.

The air of a room may be equally warmed, either by applying it to the surface of a small stove made very hot, or to the surface of a much larger stove more moderately heated. The first kind is chiefly used in Holland, Flanders, and the milder climates of Germany and Poland. The last are universally used in the frozen climates of Russia and Sweden. The first are generally made of cast-iron, and the last of brick-work covered with glazed tiles or stucco.

Fig. 1. represents a small German stove fully sufficient for warming a room of 24 feet by 18. The base is about three feet broad and 14 inches deep, that is, from back to front, and six or seven feet high. The decoration is in the fashion of that country; but the operative structure of it will admit of any style of ornament. A, is the fire-place, and the wood or charred coal is laid on the bottom, which has no bars. Bars would admit the air too freely among the fuel, and would both consume it too fast and raise too great a heat. That no heat may be uselessly expended, the sole of the fire-place and the whole bottom of the stove is raised an inch or two above the floor of the room, and the air is therefore warmed by it in succession, and rises upwards. For the same reason the back of the stove is not in contact with the wall of the room, or of the niche in which it is placed. The fire-place is shut up by a door which fits closely to its case, and has a small socket at the bottom, whose aperture is regulated by a sliding plate, so as to admit no more air than what suffices for slowly consuming the fuel. The flame and heated air rise to the top of the fire-place three or four inches above the arch or mantle-piece, and get out laterally by two narrow passages B, B, immediately below the top-plate of the base. The current bends downwards on each side, passes at C, C, under the parti-

tion plates which divide the two side chambers, and then rises upwards through the outer division of each, and passes through narrow flits D, D, in the top plate, and from thence along the two hollow piers E, E. The two lateral currents unite at the top of the arch, and go through the single passage F into the larger hollow behind the escutcheon G. From this place it either goes straight upwards into the vent in the wall by a pipe on the top of the stove, or it goes into the wall behind by a pipe inserted in the back of the stove. The propriety of this construction is very obvious. The current of hot air is applied to exterior parts of the stove everywhere except in the two side chambers of the base, where the partition-plates form one side of the canal. Even this might be avoided by making each of these side-chambers a detached hollow pillar. But this would greatly increase the trouble of construction and joining together, and is by no means necessary. The arch H has a graceful appearance, and affords a very warm situation for any thing that requires it, such as a drink in a sick person's bed-chamber, &c. Persons of a certain class use this place for keeping a dish warm; nay, the lower part of the arch is frequently occupied by an inclosed chamber, where the heat rises high enough even for dressing victuals, as will be easily imagined when we reflect that the sole of it is the roof of the fire-place.

The stove now described is supplied with fuel and with air by the front door opening into the room. That there may be room for fuel, this middle part projects a few inches before the two side-chambers. These last, with the whole upper part of the stove, are not more than ten inches deep. The passages, therefore, from the fire-place are towards the back of it; so that if we have a mind to see the fire (which is always cheerful), the door may be thrown open, and there is no danger of the smoke coming out after the current has once warmed the upper part of the stove. When the stove is of such dimensions that the base is about two feet and a half or three feet high, the fire-place may be furnished with a small grate in the British style. If the door is so hung that it can not only be thrown back, but lifted off its hinges, we have a stove grate of the completest kind, fully adequate, in our mild climate, to warm a handsome apartment, even with an open fire; and when we hang on the door, and shut up the fire-place, a stove of the dimensions already given is almost too much for a large drawing room.

We have frequently remarked, that one side of these stoves grows much warmer than the other, and that it was difficult to prevent or remedy this; and we imagine that this is an unavoidable defect in all stoves with a double flue. It is scarcely possible to make the fire so equable in the fire-place, that one side shall not be a little warmer than the other, and a brisker current will then be produced in it. This must increase the consumption of the fuel on this side, which will increase the current, will heat this side still more, and thus go on continually till the fuel on this side is expended; after which the other side will obtain and increase the superiority. The flue is made double, that the fire-place may occupy the middle of the front; and it will be difficult to gain this point of symmetry with one flue. The inconvenience may, however, be corrected by damping valves placed in some part of the upright funnels E, E.

In the colder winters on the continent, it is thought necessary to increase the effect by making the fire-place open to the back of the stove. Its mouth or door communicates with or is joined to an opening of the same dimensions formed in the wall, and the door is on the other side in an antichamber or lobby. In Westphalia, and other places of Germany, the apartments are disposed round a spacious lobby, into which all their fire-places open, and are there supplied with fuel. By this construction it is plain that the air of the room, already warmed by the stove, is not carried off, and the room is more heated. But this method is very unfavourable to cheerfulness and health. The same air, confined, and repeatedly breathed and compounded with all the volatile emanations of the room, quickly loses that refreshing quality that is so desirable, and even so necessary for health. It is never renewed except by very partial admixtures when the room doors are thrown open, and becomes disagreeable to any person coming in from the open air; and in the houses of the less opulent becomes really offensive and nauseous.

Something of this is unavoidable in all rooms heated by stoves. Even in our apartments in this island, persons of delicate nerves are hurt by what they call the close air of a room; and it is long before the smell of dinner is quite removed from a dining-room, notwithstanding the copious current up the chimney. This must be incomparably more sensible in a room heated by a stove; and this inconvenience is peculiarly sensible with respect to the stove which we are considering at present, where we employ a small surface heated to a great degree.

Such stoves are seldom made of any thing else than cast-iron. This (in those parts at least which are in immediate contact with the fuel) is in a state of continual calcination, and even throwing off scales. This indeed is not seen, because it is the bottom or sole of the fire-place which is so heated: but the effect on the air of the room is the same. The calcination of the iron is occasioned by the combination of pure vital air with the iron. This is abstracted from the general mass of atmospheric air in the room, of which it usually constitutes about two-fifths. By this abstraction the remainder becomes less fit for supporting animal life or flame, and may even become highly deleterious. In every degree the remainder becomes less refreshing, and grows dull and oppressive. This is always accompanied by a peculiar smell, which, though not disgusting, is unpleasant. It resembles the smell of burnt feathers, or more exactly the smell we feel if we rub violently for some time the palms of our hands together when perfectly dry.

For similar reasons these iron stoves occasion a sickly smell, by burning every particle of dust which falls on the hot parts; and if they be wiped with a woollen cloth, or any cloth not perfectly free from every kind of greasy or oily matter, a smell is produced for a day or days afterwards; so that without the most scrupulous attention we suffer by our very cleanliness.

For such reasons we think that the stoves of brick-work covered with stucco or with glazed tiles are vastly preferable. These are much used in the genteler houses in Flanders and Holland, where they are made in the most elegant forms, and decorated with beautiful sculpture or enamel; but it is plain that they cannot be so

effectual, nor equally warm a room with the same expense of fuel. Earthen ware, especially when covered with porous stucco, is far inferior to metal in its power of conducting heat. If built of bricks, they must be vastly more bulky when the fire-place and flues are of the same dimensions. The most perfect way of constructing them would certainly be to make them of pottery, in parts exactly fitted to each other, and joined by a proper cement. This mode of constructing would admit of every elegance of form or richness of ornament, and would not be so bulky as those which are built of bricks. The great difficulty is to prevent their cracking by the heat. Different parts of the stove being of very different heats, they expand unequally, and there is no cement which can withstand this, especially when we recollect that the same heat which expands the baked earth causes the clay or cement, with which the parts of the stove are put together or covered, to contract. Accordingly those earthen ware stoves seldom stand a winter or two without cracking in some place or other, even when strengthened by iron hoops and cramps judiciously disposed within them. Even hoopng them them externally, which would be very unsightly, will not prevent this; for nothing can resist the expansion and contraction by heat and cold. When a crack happens in a stove, it is not only unsightly, but highly dangerous; because it may be so situated, that it will discharge into the room the air vitiated by the fire.

For these and other reasons, we can scarcely hope to make stoves of brick-work or pottery which shall bear the necessary heat without cracking; and their use must therefore be confined to cases where very moderate heat is sufficient. We need not describe their construction. It is evident that it should be more simple than that of iron stoves; and we imagine that in the very few cases in which they are likely to be employed in this country, a single fire-place and an arch over it, divided, if we please, by a partition or two of thin tile to lengthen the flue, will be quite enough. If the stove is made in whole or in part of potters ware, a base for the fire-place, with an urn, column, obelisk, or pyramid above it, for increasing the surface, will also be sufficient. The failure commonly happens at the joinings, where the different pieces of a different heat, and perhaps of a different baking, are apt to expand unequally, and by working on each other one of them must give way. Therefore, instead of making the joints close and using any cement, the upper piece should stand in a groove formed in the undermost, having a little powdered chalk or clay sprinkled over it, which will effectually prevent the passage of any air; and room being thus given for the unequal expansion, the joint remains entire. This may be considered as a general direction for all furnace-work, where it is in vain to attempt to hinder the mutual working of the parts.

We have seen stoves in small apartments at St Petersburg, which were made internally of potters ware, in a great variety of forms, and then covered with a thick coat of stucco, finished externally with the utmost elegance of ornament, and we were informed that they were very rarely subject to crack. They did not give much heat, on account of the very low conducting power of the porous stucco; but we imagine that they would be abundantly warm for a moderate room in this country.

Stove

When fitted up in these situations, and with these precautions, the brick or pottery stoves are incomparably more fire and pleasant than the iron ones.

But in the intense colds of Russia and Sweden, or even for very large rooms in this kingdom, stoves of these small dimensions are not sufficiently powerful, and we must follow the practice of those countries where they are made of great size, and very moderately heated. It is needless to describe their external form, which may be varied at pleasure. Their internal structure is the same in all, and is distinctly described in PNEUMATICS, N^o 364. We shall only enlarge a little on the peculiarities connected with the general principle of their construction.

The stove is intended as a sort of magazine, in which a great quantity of heat may be quickly accumulated, to be afterwards slowly communicated to the air of the room. The stove is therefore built extremely massive; and it is found that they are more powerful when coated with clay as wet as can be made to hang together. We imagine the reason of this to be, that very wet clay, and more particularly flucco, must be exceedingly porous when dry, and therefore a very slow conductor of heat. Instead of sticking on the glazed tiles with no more clay or flucco than is sufficient to attach them, each tile has at its back a sort of box baked in one piece about two or three inches deep. It is represented in fig. 2. This is filled with mortar, and then stuck on the brick-work of the stove, which has a great number of iron pins or hooks driven into the joints, which may sink into this clay and keep it firmly attached when dry. This coating, with the massive brick-work, forms a great mass of matter to be heated by the fuel. The lower chamber, which is the fire-place, is somewhat wider, and considerably thicker than the stories above, which are merely flues. When the fire-place is finished and about to be arched over, a flat iron bar of small thickness is laid along the top of the side-wall on both sides, a set of finishing bricks being moulded on purpose with a notch to receive the iron bar. Cross bars are laid over these, one at each end and one or two between, having a bit turned down at the ends, which takes hold of the longitudinal bars, and keeps them from being thrust outwards either by the pressure of the arch or by the swelling in consequence of the heat. In

Fig. 2.

Fig. 3.

fig. 3. A is the cross section of one of the long bars, and BC is part of one of the cross bars, and CD is the clench which confines the bar A. This precaution is chiefly necessary, because the construction of the stove upwards obliges the walls of the other stories to bear a little on the arch of the fire-place. The building above is kept together in like manner by other courses of iron bars at every second return of the flue. The top of the stove is finished by a pretty thick covering of brick-work. The last passage for the air at H (see PNEUMATICS, fig. 62.) is a ring lining its upper extremity, and projecting an inch or two above it. The flat round it is covered with sand. When we would stop this passage, a covered shape like a basin or cover for dishes at table is wheeled over it. The rim of this, resting on the sand, effectually prevents all air from coming through and getting up the vent. Access is had to this damper by a door which can be shut tight enough to prevent the heated air of the room from wafting itself up the vent. When the room is too warm, it may be very ra-

pidly cooled by opening this door. The warm air rushes up with great rapidity, and is replaced by cool air from without.

Stove

The management of the stove is as follows. About eight o'clock in the morning the *pietchnick*, or servant who has the charge of the stoves, takes off the cover, shuts the damper-door, and opens the fire-place door. He then puts in a handful of wood shavings or straw, and kindles it. This warms the stove and vent, and begins a current of air through it. He then lays a few chips on the sole of the fire-place, immediately within the door; and behind this he arranges the billets of birchwood, with their ends inwards. Then he lays on more wood in the front, till he thinks there is enough. He sets fire to the chips, shuts the door, and opens the small wicket at its bottom. The air blows the flame of the chips upon the billets behind them, and thus kindles them. They consume slowly, while the billets in front remain untouched by the fire. The servant, having made his first round of the rooms, returns to this stove, and opens the door above to admit air into the vent. This is to supply its draught, and thus to check the draught in the body of the stove, which is generally too strong at this time, and would consume the fuel too fast. By this time the billets in the front are burning, first at the bottom, and the rest in succession as they sink down on the embers and come opposite to the wicket. The room does not yet feel any effect from the fire, the heat of which has not yet reached its external surface; but in about half an hour this grows warm. The upper door is shut again, that no heat may now be wasted. The *pietchnick* by and by spreads the embers and ashes over the whole bottom of the fire-place with a rake, by which the bottom is greatly heated, and heats the air contiguous to it externally (for it stands on little pillars) very powerfully. He takes care to bring up to the top of the ashes every bit of wood or coal that is not yet consumed, that all may be completely expended. He does this as briskly as possible, that the room may not lose much warmed air by keeping open the fire-place door. At his last visit, when he observes no more glowing embers, he shuts the fire-place door and wicket, and puts the damper on the passage above, and shuts its door.—All this is over in about an hour and a half after kindling the fire. All current of air is now at an end within the stove, and it is now a great mass of brick-work, heated to a great degree within, but only about blood-warm externally. The heat gradually spreads outwards, and the external surface of the stove acquires its greatest heat about three o'clock in the afternoon; after which it gradually cools till next morning.

This heat seldom is so great that one cannot bear to touch the stove with his cheek, and to keep it there. In consequence of this it can burn none of the dust which unavoidably falls on the stove, and we are never troubled with the sickening smells that are unavoidable when we employ the small cast-iron stoves much heated. The great expence of heat in a room arises from the glass windows. The pane is so thin that the external air keeps it continually cold, and thus the windows are continually robbing the air of the room of its heat. This expence of heat is reduced to less than one-third by double casements. The inner casement is about as much colder than the room as the outer casement is warmer

warmer than the air of the fields; and we have the singular advantage of having no ice formed on the glasses. But to ensure this last advantage, the frame of the inner casement must be padded with paper, and those of the outer casement must be left unpadded. If we do the contrary, we shall certainly have ice on the outer casement; the reason of which is easily seen.

We have been thus particular in our description of the management, because the reasons of some particulars are not very obvious, and the practice would not readily occur to us in this country; so that a person who, on the faith of our recommendation, should prefer one of these stoves to the German stove, whose management is simple and obvious, might be greatly disappointed. But by following this method, we are confident that the Russian stove will be found much superior both in warmth and agreeable air. The spreading out of the embers, and waiting till all is reduced to ashes before the doors are shut, is also absolutely necessary, and a neglect of it would expose us to imminent danger of suffocation by fixed air; and this is the only inconvenience of the Russian stove, from which the other stove is free. The fixed air has no smell; and the best indication of its presence is a slight giddiness and lassitude, which disposes us to sit down and to sleep. This would be fatal; and we must immediately open the upper passage and the fire-place door, so as to produce a strong current to carry the vitiated air of the room up the chimney. Throwing up the ashes, or at least opening all the doors, is proper on such an occasion.

If we burn pit-coal, either raw or charred, this precaution is still more necessary; because the cinder is not so easily or so soon completely consumed. This fuel will require a little difference in the management from wood fuel, but which is easily seen by any person of reflection. The safe way would be to take out all half-burnt coal before shutting up the doors.

If we use raw pit-coal, great care is necessary to prevent the accumulation of soot in the upper part of the stove. It is an inaccessible place for the chimney-sweep; and if we attempt to burn it out, we run a great risk of splitting that part of the stove which is the most slightly constructed. It is advisable therefore to burn it away every day, by giving a brisk draught with an open door for five minutes. With wood or coak there is no danger.

It will not be improper in this place to give some instructions for the construction of stoves for warming several floors in a great manufactory, such as a cotton-mill, or a public library or museum.

In such situations we think cleanliness, wholesomeness, and sweetness of air, no less necessary than in the drawing room of a man of oulence. We therefore recommend the brick-stove in preference to the iron one; and though it would not be the best or most economical practice to heat it but once a-day, and we should rather prefer the German practice of constant feeding, we still think it highly proper to limit the heat to a very moderate degree, and employ a large surface.

If the disposition of the rooms allows us the convenience of a thick party-wall, we would place the pipes in the middle of this wall, in an arch which pierces through the wall. Immediately above this arch we would carry up a very wide chimney through the whole height. This chimney must have a passage opening

into each floor on both sides, which may be very accurately shut up by a door. The stove being set up under the arch, it must have a pipe communicating with its flue, and rising up through this chimney. Could an earthen pipe be properly supported, and secured from splitting by hoops, we should prefer it for the reason already given. But as this is perhaps expecting too much, we must admit the use of a cast iron pipe. This is the real chimney or flue of the stove, and must be of as great diameter as possible, that it may act, by an extensive surface, all the way up.

The stove stands under the arch in the wall; but the air that is warmed by its surface would escape on both sides, and would be expended in that single floor. To prevent this, the stove must be inclosed in a case; this may be of brick-work, at the distance of two or three inches from the stove all round. It must be well shut in above, and at the foundation must have a row of small holes to admit the air all around it. This air will then be warmed over the whole space between the stove and the case, pass up the chimney, and there receive additional heat from the flue-pipe which is in the middle. Great care must be taken that the fire-place door have no communication with the space between the stove and its case, but be inclosed in a mouth-piece which comes through the case, and opens into the feeding room. Thus all the air which goes up to the rooms will be pure and wholesome, provided we take care that every thing be kept clean and sweet about the air-holes below. Observe that those air-holes which are near the furnace door must be inclosed in a wooden trunk which takes in its air at some distance from this door; for since the current between the stove and case may be almost as great as the current within the stove (say, when a puff of wind beats down the chimney, it may even exceed it), there is a risk of some vitiated air and smoke being drawn into the case.

If the stove cannot be placed in the arch of a party-wall, it may be set adjoining to a side or outer wall, and furnished with a case, a large chimney, and a flue-pipe, in the same manner. But in this case a great deal of heat is wasted on this outer wall, and carried off by the external air. In this situation we would recommend to line that part of the wall which is behind the stove (at two or three inches distance), and the whole of the chimney, with plaster on laths. These should be nailed on battens properly fastened on the wall, leaving a space of an inch between the laths and the wall. The plaster should be of the most springy kind, having in it a quantity of clay in powder instead of the full proportion of sand. Horse-dung, washed with water and strained through coarse shannel, leaves a great portion of unassimilated vegetable fibre, which will mix very intimately in the plaster, and make it a substance very unfit for conducting heat. There is no danger of catching fire by this lining. We have seen a most tremendous fire rage for three hours, in contact with a partition of lath and plaster (on the plaster-side however), without discolouring the thin laths on the other side. We once saw a cottage chimney on fire, and burn till the foot was consumed. This chimney was nothing but a pipe of a foot wide, made of laths, and plastered on the inside and outside; and it passed through a thatched roof. We therefore recommend this in place of the brick-case for inclosing the stove. It would save heat; and as it might

be made in pieces on detached frames, which could be joined by iron straps and hinges, any part of the stove could be laid open for repairs at pleasure.

We have no hesitation in saying that a stove constructed in this manner would be greatly superior in power to any we have seen, and would be free from many of their disgusting defects. We beg leave therefore to introduce here the description of one which was to have been erected in one of the churches of the city of Edinburgh.

Fig. 4.

Fig. 4. is a sketch of the plan of the church contained in the parallelogram AFED. P marks the place of the pulpit, and LMNO the front of the galleries. These are carried back to the side-walls AB and DC. But at the end opposite to the pulpit they do not reach so far, but leave a space BFEC about 12 feet wide. Below the back of the galleries, on each side, there is a passage ABGH, KICD, separated from the seated part of the church by partitions which reach from the floor to the galleries, so that the space HGIK is completely shut in. The church is an ancient Gothic building, of a light and airy structure, having two rows of large windows above the arcades, and a spacious window in the east end above the pulpit. The congregation complain of a cold air, which they feel pouring down upon their heads. This is more particularly felt by those sitting in the fronts of the galleries. We imagine that this arises chiefly from the extensive surface of the upper row of windows, and of the cold stone-walls above, which robs the air of its heat as it glides up along the sides of the church. It becomes heavier by collapsing, and in this state descends in the middle of the church.

The stove S is placed against the middle of the west wall at the distance of a few inches, and is completely inclosed in a case of lath and plaster. The vent, which is to carry off the smoke and burnt air, is conveyed up or along the wall, and through the roof or side-wall, but without any communication with the case. In like manner the fire-place door is open to the passage, without communicating with the case; and care is taken that the holes which admit the air into the case are so disposed that they shall run no risk of drawing in any air from the fire-place door.

From the top of this case proceed two trunks Q, R, each of which is two feet broad and six inches deep, coated within and without with the most spongy plaster that can be composed. For this purpose we should recommend a composition of powdered charcoal and as much clay and quicklime as will give it a very slight cohesion. We know that a piece of this may be held in the hand, without inconvenience, within an inch of where it is of a glowing red heat.—These trunks open into another trunk XVTYZ, which ranges along the partition immediately under the galleries, and may be formed externally into a cornice, a little massive indeed, but not unsightly in a building of this style. This trunk is coated in the same manner. It has several openings a, a, &c. which have sliders that can be drawn aside by means of handles accessible from the outer passage.—At the extremities X and Z of this trunk are two perpendicular trunks which come up through the galleries, and are continued to a considerable height. At their junction with the horizontal trunk are two doors large enough to admit a lamp. Each perpendicular trunk has also a valve by which it can be completely stopped.

The stove is managed as follows: Early in the morning the superintendent shuts all the sliders, and sets a lamp (burning) in each of the trunks X and Z, and shuts the doors. He then puts on and kindles the fire in the stove, and manages it either in the Russian or German method. Perhaps the latter is preferable, as being liable to fewer accidents from mistake or neglect.

The lamps lit in the lower ends of the upright trunks presently warm them, and produce a current of air upwards. This must be supplied by the horizontal trunk, which must take it from the case round the stove. Thus a current is begun in the direction we wish. By and by the air in the case acquires heat from the stove, and the current becomes extremely brisk. When the manager perceives this, he removes the lamps, shuts the valves, and opens the holes a, a, &c. beginning with the most remote, and proceeding slowly towards the stove from each extremity of the horizontal branches. The heated air now issues by these holes, glides along the ceiling below the galleries, and escapes, by rising up along the fronts of the galleries, and will be sensibly felt by those sitting there, coming on their faces with a gentle warmth. It will then rise (in great part) straight up, while some of it will glide backwards, to the comfort of those who sit behind.

The propriety of shutting the valves of the upright trunks is evident. If they were left open, no air would come out by the holes a, a, &c.; but, on the contrary, the air would go in at these holes to supply the current, and the stove be rendered useless. The air delivered by these holes will keep close to the ceiling, and will not, as we imagine, incommode those who sit below the galleries. But if it should be found to render these parts too warm, holes may be pierced through the ceiling, by which it will rise among the people above, and must be very comfortable. It will require the careful attention of some intelligent person to bring all this into a proper train at first, by finding the proper apertures of the different holes, so as to render the heat equable through the whole space. But this being once ascertained the difficulty is over.

The air trunks must be very capacious, but may be contracted towards the extremities as their lateral discharges diminish; and the row of holes which admit the air to the case round the stove must be fully able to supply them.

It must be observed, that in this construction the ascensional force is but small. It is only the height of a short column of warm air from the ground to the galleries. At first indeed it is great, having the unlimited height of the perpendicular trunks at X and Z; but during the use of the stove it is reduced to nine or ten feet. It is necessary, therefore, that the stove be highly heated, perhaps considerably beyond the Russian practice, but yet inferior to the heat of the German iron stoves. But still we strongly recommend the brick or pottery stoves, on account of the wholesome sweetness of the air which they furnish; and we are certain that a stove of moderate dimensions, eight feet long, for instance, by eight feet high, will be sufficient for warming a church holding 1200 or 1500 people. If the stove could be placed lower, which in many situations is very practicable, its effect would be proportionally greater, because all depends on the rapidity of the current. When we are limited in height, we must extend the

stove

STOVE

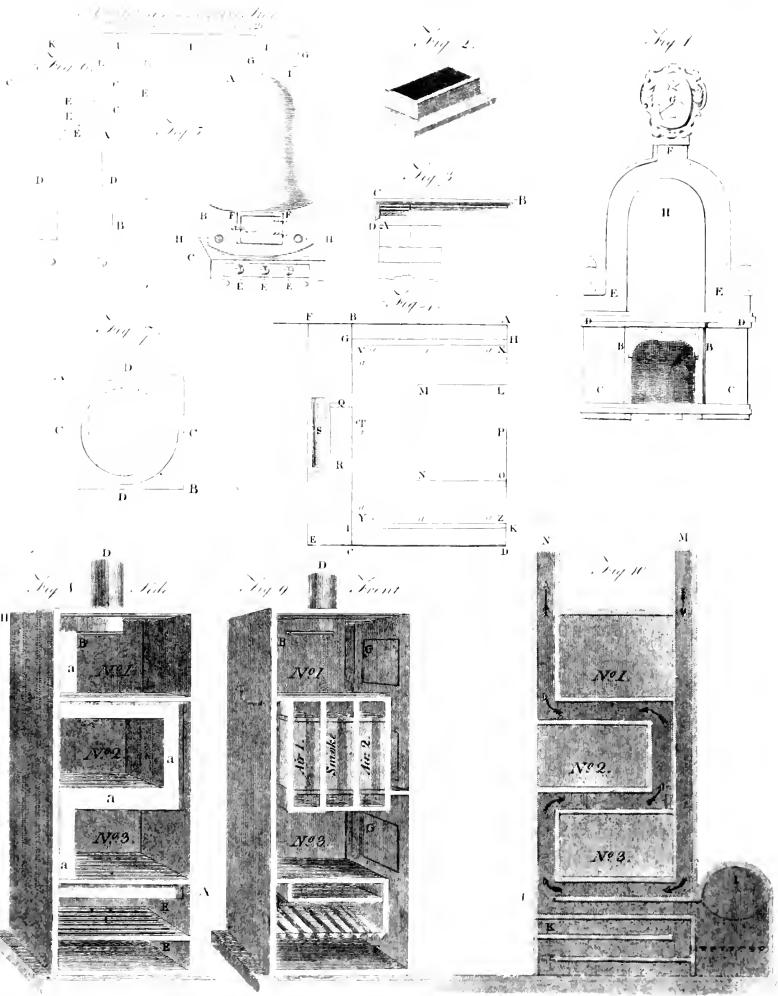

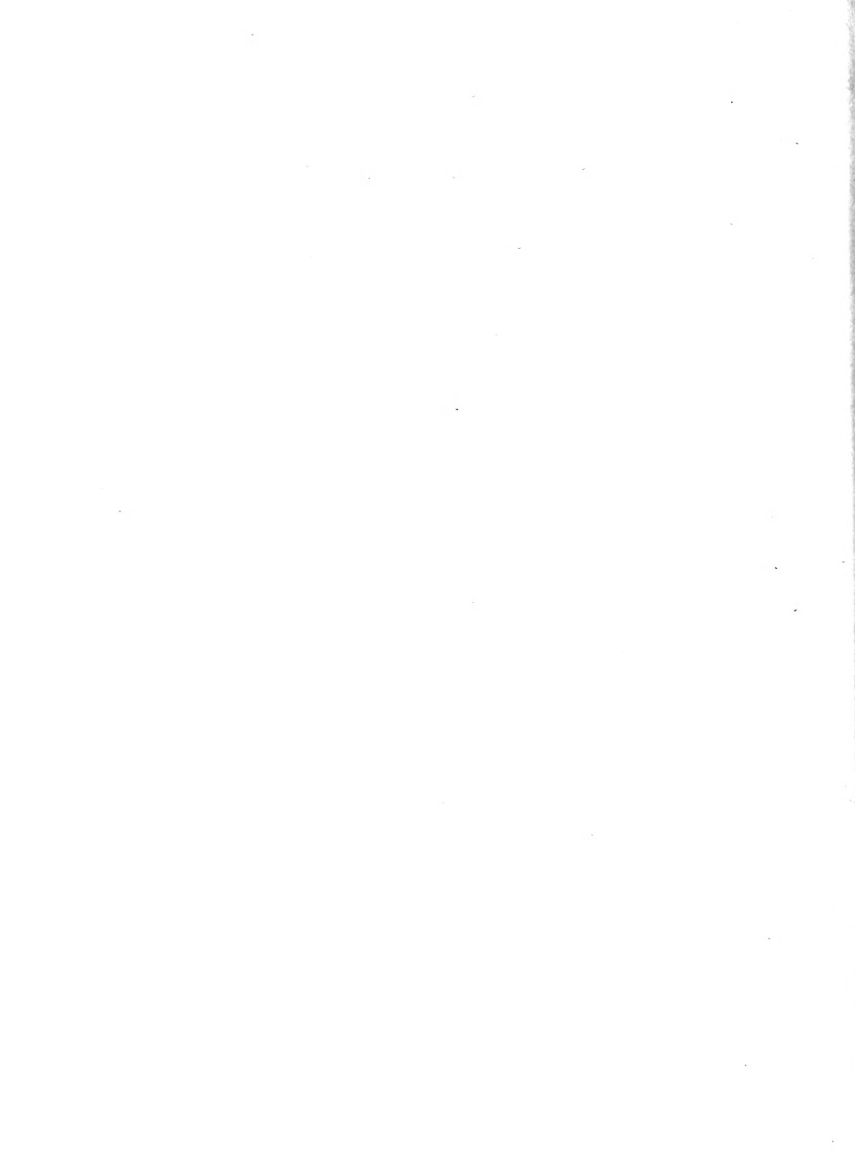

Stove. Above so much the more in length, and make the air trunks more capacious. These and many other circumstances of local modification must be attended to by the erec- tor of the stove; and without the judicious attention of an intelligent artist, we may expect nothing but dis- appointment. It is hardly possible to give instructions suited to every situation; but a careful attention to the general principle which determines the ascensional force will free the artist from any great risk of failure.

We may say the same thing of stoves for conserva- tories, hot-houses, hot walls, &c. and can hardly add any thing of consequence to what we have already said on these heads in the article PNEUMATICS.

We must not, however, dismiss the subject without taking notice of the very ingenious projects which have been frequently offered for drying malt by stoves. Many of these are to be seen in the publications of the Aca- demies of Stockholm, Upsal, Copenhagen; and some have been erected in this kingdom, but they have not been found to answer.

We apprehend that they cannot answer. To dry malt, and make it fit for the ales and beers for which this island is so famous, it is by no means enough that we give it a proper and an equable supply of heat.— This alone would bake it and make it stinty, causing the moisture to penetrate the mealy particles of the grain; and, by completely dissolving the soluble parts, would render each kernel an uniform mass, which would dry into a stinty grain, breaking like a piece of glass.—A grain of malt is not an inert pulp. It is a SEED, in an active state, growing, and of an organized structure. We wish to stop it in this state, and kill it, not by heating it, but by abstracting its moisture. We thus leave it in its granulated or organized form, spongy, and fit for imbibing water in the mash tub, without running into a paste.

To accomplish these purposes, the construction of our malt kilns seems very well adapted. The kiln is the only flue of the furnace, and a copious current of air is formed through among the grains, carrying off with it the water which is evaporating by the heat. But this evaporation, being chiefly in consequence of the vapour being immediately dissolved by the passing air, will stop as soon as the current of air stops. This current has to make its way through moist grain, laid in a pretty thick bed, and matted together. Some force, therefore, is necessary to drive it through. This is furnished by the draught of the kiln. Substituting a stove, immedi- ately applied to the malt, will not have this effect. The only way in which we think this can be done different from the present, is to have a horizontal flue, as has been proposed in these projects, to read out at a small distance below the grate on which the malt is laid, and to cover the whole with a high dome, like a glass-house dome. This being filled with a tall column of hot air, and having no passage into it but through the malt, would produce the current which we want. We are convinced that this will make much less fuel serve; but we are by no means certain that the sulphureous and carbonic acid which accompanies the air in our common kiln is not a necessary or a useful ingredient in the process. It is well known that different coaks, cinders, or charcoal, impart different qualities to the malts, and are preferred each for its own purpose.

A Stove constructed on similar principles, but compo- VOL. XIX. Part II,

fed of very different materials, has been lately erected in several of the churches in Edinburgh. This stove, which is formed entirely of cast iron, may be considered as a double stove, an outer case, and a furnace or inner stove. The fuel is burnt in the inner stove; and the smoke produced during the process of combustion, is carried off by a chimney, which passes through the top of the outer stove, and is conveyed to the outside of the building. The outer case includes not only the furnace or inner stove, but also a considerable space, occupied by the air of the atmosphere, which is freely admitted through a number of openings placed around it; and when any current of air is produced, it passes off from the space between the outer case and inner stove, and is conveyed by tubes through the body of the apartment. But we shall first describe the different parts of which the stove is composed, after which we shall be better able to understand its mode of operation.

Fig. 5. exhibits a perspective view of this stove. AB is the body, which is about three feet high, and of a circular form. BC is a square pedestal on which the stove is placed, and which contains the ash pit DD. The height of the pedestal is about a foot, and it is nearly insulated by reeling on the spherical supports aa, also of cast iron. EEE are openings in front of the ash pit through which the air enters to support the combu- tion. These openings can be enlarged or diminished, or opened and shut at pleasure. FF is the door of the furnace through which the fuel is introduced. This door is attached to the inner furnace, and is double. It is one foot broad, and 11 inches high. GG is the chimney, which passes from the furnace within, through the outer case, and conveys the smoke out of the build- ing. HH are openings in the outer case, and are eight in number, through which the air enters, and being heated, is greatly rarified, and passes off through the funnel or pipe IIII. This pipe communicates only with the outer stove, and being shut at the end K, the air rushes out from the small tubes LL, inserted into the side of the pipe IIII, and thus mixes with the cold air of the church. The diameter of the outer case at the bottom is about two feet, and the diameter of the furnace within is about 16 inches.

Fig. 6. is a section of the stove. AB is the outer case, from which passes off the pipe or funnel CCC, by which the heated air is conveyed through the church. DD is the furnace in the inside, in which the fuel is burnt, and EEE is the chimney or funnel which conveys the smoke from the inner furnace out of the building. It passes through the outer stove AB at F.

Fig. 7. is a plan of this stove. AB is the pedestal on which it rests, and which contains the ash pit. CC is the outer case, and DD is the furnace within, in which are seen the transverse bars which support the fuel.

The length of the body of the church, in which two stoves of the form and dimensions now described are erected, is about 65 feet, and the breadth is about 35 feet. The tubes IIII are conveyed along the lower edge of the gallery, about half the length of the church. The fires are lighted up about four or five o'clock on the Sunday morning, during the earlier part of the cold season; but as the season advances, it is usual to light them up the night before. From this time till the congrega- tion assemble for the afternoon service, the furnaces

Stove.

are kept constantly supplied with fuel. By this management the air in the church is kept comfortably warm during the coldest season of the year.

These stoves, it appears to us, are susceptible of some improvement, both in their construction and in the places in which they are erected. With regard to the first circumstance, an external coating of plaster work, or of the same kind of materials as are used for coating the inside of chemical furnaces, would be of some use in preventing an unnecessary waste of heat, as well as the disagreeable smell which is sometimes complained of, and which is supposed to arise from the combustion of light bodies floating in the air and drawn by the current to the heated metal; and with regard to the last, viz. the places in which they are erected, it is perfectly obvious that they ought to be as completely insulated as possible, and particularly ought not to communicate with any body which is a good conductor of heat. Some of the stoves erected in the churches of Edinburgh, which we have examined, are faulty in this respect. One in particular is placed in close contact with a gable wall.

The quantity of coals consumed in two of these stoves in one of the churches of Edinburgh during the course of a season, we have been informed, amounts to about five carts of 12 cwt. each; so that at the Edinburgh prices of coal, the expense for fuel for heating one of the churches is about 50 shillings. This being added to the expenses of attendance, includes the whole expenditure, besides some occasional repairs which are required in heating a church of the above dimensions.

The following is the description of an improved stove by Mr Field of Newman Street London, in which, it is stated by the author, the various advantages of heating, boiling, steaming, evaporating, drying, ventilating, &c. are united; some of which we shall detail in his own words.

" Fig. 8. represents a longitudinal section of the stove, showing the course of the air from its entrance into the flues of the stove at A, to its entrance into the upper chamber of the stove at B; and also the course of the smoke from the fire-place at C, till it escapes from the stove at D. E, E, are the doors or openings of the fire-place and ash-hole.

" Fig. 9. is a similar section at right angles with the above, exhibiting the course of the air through the chambers of the stove, from its entrance into the chamber N^o 1. at B to its entrance beneath the fire-place at F. This figure also shows sections of the flues, with the divisions through which the air and smoke pass separately, the smoke-flue in the centre, and the air-flues on each side. G, G, are doors and openings through which the articles to be dried are introduced into the chambers.

" When the fire is lighted, and the doors of the chambers, ash hole, and fire-place, closed, the air by which the fire is supplied enters at A, fig. 8. passes through the air-flues a, a, a, enters the upper chamber at B, traverses and descends through the chambers N^o 1, 2, 3, and arrives beneath the fire at F, fig. 9. Having supplied the fire with oxygen, it passes through the flue with the smoke, and escapes at D, heating in its protracted course the chambers and air-flues.

" As the cold air enters the stove at A, immediately above a plate forming the top of the fire-place, and pursues a similar route with the fire-flue, it enters the cham-

Stove,
Stair-
bridge.

bers very much heated and rarefied. Hence any moist substance placed in the chambers evaporates in consequence, not only of the heated flues circulating round them, but of a stream of warm rarefied air, which, while it continually raises evaporation, as continually bears away the exhaled moisture in its passage to the fire, thus imitating the gradual and efficacious plan of nature in drying by the sun and air. While these effects are taking place within the flues, part of the air which enters at A, fig. 8. and 9. passes through air-flues on the other side of the fire-flue, pursues a parallel course with the first, and gives out a current of warm air to the room at an aperture H. This effect may be obtained in a much higher degree, if the doors of the chambers and ash-hole are opened: should the hand or face be then brought near, they would be fanned with a stream of warm air, especially from the upper chamber.

" By means of this stove I have evaporated milk to dryness, without burning or discolouring it; and have dried cherries, plums, and other fruits, so as to imitate those which are received from abroad. I have repeatedly dried colours and the most delicate substances without the slightest injury, even though the operation proceeded quickly.

" The height of the stove is about five feet and a half; its diameter two feet and a half, and that of the flues four inches. The external part is constructed of brick, and the internal parts of thin Ryegate or fire-stone, except the top of the fire-place, which is a plate of cast iron. Were it to be wholly formed of iron, its effects would necessarily be more powerful.

" Fig. 10. represents an extension of the plan, in which stoves of this kind may be advantageously connected with one or more furnaces for chemical or other uses. The fire-place, brought out, either in front or on one side, by the present positions of its crown J, forms a reverberatory furnace, or will make a sand-bath by reversing it.

" The space occupied by the fire-place in fig. 8. may in this be converted into apartments for evaporating substances, or occasionally for cooling them by an opening at K to admit cold air, while the warm air of the stove is excluded by a register or door. The dotted lines show the manner in which a second furnace may be connected by an opening into the flue at L.

" In addition to the uses already pointed out, this stove would probably be found extremely serviceable in drying japaners goods, and consuming the noxious fumes and gas which arise from the oil and varnish used in this business.

" Since the stove is not limited to any certain dimensions, it might be adapted to the drying of malt and hops, perhaps of herbs, corn, and seeds generally. It might also be accommodated to the purposes of the sugar-bakers, connected with the great fires they employ for their boilers. It has been shown to be useful in the confectioners art, and probably it may be equally so in baking biscuits for the navy; nor less so in drying linen for the laundress, dyer, calico-printer, and bleacher. I have myself found it well accommodated for a chemical laboratory *."

STOURBRIDGE, or STURRICH, the name of a ^{Mag. vol. 1.} village near Cambridge, noted for its famous fair kept annually on the 7th of September, and which continues for a fortnight. The commodities are, horses, hogs, iron, wool, leather, cheese, &c. This place is also noted

* Phil.
Mag. vol. 1.
Saxil.

Stow,
Stow-
market.

noted for an excellent species of clay capable of resisting an intense heat. It is used in making pots for glass-houses, fire-bricks, &c.; and is sold at an high price.

STOW, the name of a market-town in Gloucestershire in England, situated in W. Long. 1. 50. N. Lat. 51. 24. It is also the name of a fine seat of the marquis of Buckingham in Buckinghamshire. Here are the best gardens in England, adorned with huts, fountains, obelisks, pavilions, and temples. It is two miles from the town of Buckingham.

STOW, John, the industrious historian, son of Thomas Stow merchant-taylor of St Michael's, Cornhill, in London, was born about the year 1525. Of the early part of his life we know very little, except that he was bred to his father's business, which in the year 1560 he relinquished, devoting himself entirely to the study of our ancient historians, chronicles, annals, charters, registers, and records. Of these he made a considerable collection, travelling for that purpose to different parts of the kingdom, and transcribing such manuscripts as he could not purchase. But this profession of an antiquary being attended with no present emolument, he was obliged for subsistence to return to his trade.—It happened, however, that his talents and necessities were made known to Dr Parker archbishop of Canterbury: who being himself an antiquary, encouraged and enabled Mr Stow to prosecute his darling study. In those times of persecution, though Elizabeth was then upon the throne, honest John Stow did not escape danger. His collection of Popish records was deemed cause of suspicion. His younger brother Thomas preferred no less than 140 articles against him before the ecclesiastical commission; but the proof being insufficient, he was acquitted. In 1565 he first published his Summary of the Chronicles of England. About the year 1584 he began his Survey of London. In 1585 he was one of the two collectors for a great minter of Limestreet ward: in the same year he petitioned the corporation of London to bestow on him the benefit of two freemen, to enable him to publish his survey; and in 1589 he petitioned again for a pension. Whether he succeeded, is not known. He was principally concerned in the second edition of Holinshed's chronicle, published in 1587. He also corrected, and twice augmented, Chaucer's works, published in 1561 and in 1597. His survey of London was first published in 1598. To these laborious works he would have added his large Chronicle, or History of England; but he lived only to publish an abstract of it, under the title of *Flores Historiarum*. The folio volume, which was printed after his death, with the title of *Stow's Chronicle*, was taken from his papers by Edmund Howes. Having thus spent his life and fortune in these laborious pursuits, he was at last obliged to sell the charitable and well disposed for relief. For this purpose, King James I. granted him, in 1623, a brief, which was renewed in 1624, authorizing him to collect in churches the benefactions of his fellow-citizens. He died in April 1627, aged 85; and was buried in his parish church of St Andrew's Underhill, where his widow erected a decent monument to his memory. John Stow was a most indefatigable antiquarian, a faithful historian, and an honest man.

STOWMARKET, a town of Suffolk, in England,

situated in E. Long. 1. 6. N. Lat. 52. 16. It is a large handsome place, situated between the branches of the rivers Gipping and Orwell, and is remarkable for having the best cherries in England.

STOWAGE, the general disposition of the several materials contained in a ship's hold, with regard to their figure, magnitude, or solidity.

In the stowage of different articles, as ballast, casks, cases, bales, and boxes, there are several general rules to be observed, according to the circumstances or quantities of those materials. The casks which contain any liquid are, according to the sea phrase, to be *lany-up* and *lany-free*, i. e. closely wedged up in a horizontal position, and rolling on their quarters: so that the Liggs where they are thicked being entirely free all round, cannot rub against each other by the motion of the vessel. Dry goods, or such as may be damaged by the water, are to be carefully inclosed in casks, bales, cases, or wrappers; and wedged off from the bottom and sides of the ship, as well as from the bow, masts, and pumpwell. Due attention must likewise be had to their disposition with regard to each other, and to the trim and centre of gravity of the ship; so that the heaviest may always be nearest the keel, and the lightest gradually above them.

STRABISMUS, squinting. See **MEDICINE Ind.**

STRABO, a celebrated Greek geographer, philosopher, and historian, was born at Amasia, and was descended from a family settled at Gnostus in Cete. He was the disciple of Xenarchus, a Peripatetic philosopher, and at length attached himself to the Stoics. He contracted a strict friendship with Cornelius Gallus, governor of Egypt, and travelled into several countries to observe the situation of places, and the customs of nations. He flourished under Augustus, and died under Tiberius about the year 25, in a very advanced age.—He composed several works, all of which are lost except his Geography in 17 books; which are justly esteemed very precious remains of antiquity. The two first books are employed in showing, that the study of geography is not only worthy of, but even necessary to, a philosopher; the third describes Spain; the fourth, Gaul and the Britanic isles; the fifth and sixth, Italy and the adjacent isles; the seventh, which is imperfect at the end, Germany, the countries of the Getæ and Illyrii, Taurica Chersonesus, and Epirus; the eighth, ninth, and tenth, Greece with the neighbouring isles; the four following, Asia within Mount Taurus; the fifteenth and sixteenth, Asia without Taurus, India, Persia, Syria, Arabia; and the seventeenth, Egypt, Æthiopia, Carthage, and other places of Africa. Strabo's work was published with a Latin version by Xylander, and notes by Isaac Casaubon, (or rather by Henry Scimzeer, from whom Casaubon chiefly stole them), at Paris, 1620, in folio. But the best edition is that of Amsterdam in 1707, in two volumes folio, by the learned Theodore Jaionius ab Almeloveen, with the entire notes of Xylander, Casaubon, Meursius, Cluver, Hollenius, Salmatius, Borchart, E. Spanheim, Cellarius, and others. To this edition is subjoined the *Chronothæticæ*, or epitome of Strabo; which according to Mr Dodwell, who has written a very elaborate and learned dissertation about it, was made by some unknown person between the years of Christ 676 and 996. It has been found of some use,

Stowe-
II
Strabo

Strada,
Strahan.

not only in helping to correct the original, but in supplying in some measure the defect in the seventh book. Mr Dodwell's dissertation is prefixed to this edition.

STRADA, FAMILIANUS, a very ingenious and learned Jesuit, was born at Rome in the latter end of the 16th century, and taught rhetoric there, in a public manner, for fifteen years. He wrote several pieces upon the art of oratory, and published some orations with a view of illustrating by example what he had inculcated by precept. But his *Profusiones Academicæ* and his *Historia de Bello Belgico* are the works which raised his reputation, and have preserved his memory. His history of the war of Flanders was published at Rome; the first deced in 1640, the second in 1647; the whole extending from the death of Charles V. which happened in 1558, to the year 1590. It is written in good Latin, as all allow; but its merit in other respects has been variously determined. His *Profusiones Academicæ* show great ingenuity, and a masterly skill in classical literature; that profusion especially in which he introduces Lucretius, Claudian, Ovid, Statius, and Virgil, each of them versifying according to his own strain. They have been often printed. We know not the year of Strada's birth or of his death.

STRAHAN, WILLIAM, an eminent printer, was born at Edinburgh in the year 1715. His father, who had a small appointment in the customs, gave his son the education which every one of decent rank then received in a country where the avenues to learning were easy, and open to men of the most moderate circumstances. After having passed through the tuition of a grammar school, he was put apprentice to a printer; and when a very young man, removed to a wider sphere in that line of business, and went to follow his trade in London. Sober, diligent, and attentive, while his emoluments were for some time very scanty, he contrived to live rather within than beyond his income; and though he married early, and without such a provision as prudence might have looked for in the establishment of a family, he continued to thrive, and to better his circumstances. This he would often mention as an encouragement to early matrimony; and used to say, that he never had a child born that Providence did not send some increase of income to provide for the increase of his household. With sufficient vigour of mind, he had that happy flow of animal spirits that is not easily discouraged by unpromising appearances.

His abilities in his profession, accompanied with perfect integrity and unabating diligence, enabled him, after the first difficulties were overcome, to advance with rapid success. And he was one of the most flourishing men of the trade, when, in the year 1770, he purchased a share of the patent for king's printer of Mr Eyre, with whom he maintained the most cordial intimacy during the rest of his life. Beside the emoluments arising from this appointment, as well as from a very extensive private business, he now drew largely from a field which required for a degree of speculative sagacity to cultivate on account of the great literary property which he acquired by purchasing the copy-rights of the most celebrated authors of the time. In this his liberality kept pace with his prudence, and in some cases went perhaps rather beyond it. Never had such rewards been given to the labours of literary men as now were received from

him and his associates in those purchases of copy-rights Strahan.

Having now attained the first great object of business, wealth, Mr Strahan looked with a very allowable ambition on the stations of political rank and eminence. Politics had long occupied his active mind, which he had for many years pursued as his favourite amusement, by corresponding on that subject with some of the first characters of the age. Mr Strahan's queries to Dr Franklin in the year 1769, respecting the discontents of the Americans, published in the London Chronicle of 28th July 1778, show the just conception he entertained of the important consequences of that dispute, and his anxiety as a good subject to investigate, at that early period, the proper means by which their grievances might be removed, and a permanent harmony restored between the two countries. In the year 1775 he was elected a member of parliament for the borough of Malmbury in Wiltshire, with a very illustrious colleague, the Hon. C. J. Fox; and in the succeeding parliament, for Wootton Bassett, in the same county. In this station, applying himself with that industry which was natural to him, he was a useful member, and attended the house with a scrupulous punctuality. His talents for business acquired the consideration to which they were entitled, and were not unnoticed by the minister.

In his political connection he was constant to the friends to whom he had first been attached. He was a ready supporter of that party who were turned out of administration in spring 1784, and lost his seat in the house of commons by the dissolution of parliament with which that change was followed: a situation which he did not shew any desire to resume on the return of the new parliament; arising from a feeling of some decline in his health, which had rather suffered from the long sittings and late hours with which the political warfare in the preceding had been attended. Without any fixed disease, his strength visibly declined; and though his spirits survived his strength, yet the vigour and activity of his mind were considerably impaired. Both continued gradually to decline till his death, which happened on the 9th of July 1785 in the 71st year of his age.

Endued with much natural sagacity, and an attentive observation of life, he owed his rise to that station of opulence and respect which he attained, rather to his own talents and exertion, than to any accidental occurrence of favourable or fortunate circumstances. His mind was not uninformed by letters; and from a habit of attention to style, he acquired a considerable portion of critical acuteness in the discernment of its beauties and defects? In one branch of writing he particularly excelled—the epistolary; in which he not only showed the precision and clearness of business, but possessed a neatness as well as a fluency of expression which few letter-writers have been known to surpass. Letter-writing was one of his favourite amusements; and among his correspondents were men of such eminence and talents as well repaid his endeavours to entertain them. Among these, as before mentioned, was the justly celebrated Dr Franklin, originally a printer like Mr Strahan, whose friendship and correspondence, notwithstanding the difference of their sentiments in political matters,

he continued to enjoy till his death. One of the latest letters which he received from his illustrious and venerable friend contained a humorous allegory of the state of politics in Britain, drawn from the profession of printing; of which, though the doctor had quitted the exercise, he had not forgotten the terms.

The judicious disposition which Mr Strahan made of his property, affords an evident proof of his good sense and propriety. After providing munificently for his widow and children, his principal study seems to have been to mitigate the affliction of those (and many there were) who would more immediately have felt his loss, by bequeathing them liberal annuities for their lives; and (recollecting that all of a profession are not equally provident) he left 1000*l.* to the Company of Stationers, the interest to be divided among infirm old printers.

As the virtuous connections of the life and the heart are always pleasing to trace,—of Mr Strahan it may briefly be said, that his capacity, diligence, and probability, raised him to the head of his profession. The good humour and obliging disposition which he owed to nature, he cultivated with care, and confirmed by habit. His sympathetic heart beat time to the joy and sorrow of his friends. His advice was always ready to direct youth, and his purse open to relieve indigence. Living in times not the purest in the English annals, he escaped unscathed through the artifices of trade and the corruption of politics. In him a strong natural capacity, improved by an extensive knowledge of the world, served only to render respectable his unaffected simplicity of manners, and to make his Christian philanthropy more discerning and useful. The uninterrupted health and happiness which accompanied him for half a century in the capital, proves honestly to be the best policy, temperance the greatest luxury, and the essential duties of life its most agreeable amusement. In his elevated fortune, none of his former acquaintance ever accused him of neglect. He attained prosperity without envy, enjoyed wealth without pride, and dispensed bounty without ostentation.

STRAIKS, in the military art, are strong plates of iron, six in number, fixed with large nails called *strainsails*, on the circumference of a cannon wheel, over the joints of the fellows; both to strengthen the wheel, and to save the fellows from wearing on hard ways or streets.

STRAIN, a pain occasioned by the violent extension of some membranous or tendinous part.

STRAIN, *Stress*, in *Mechanics*, are terms indiscriminately used to express the force which is exerted in any part of a machine or structure of any kind tending to break it in that part. Thus every part of a rope is equally strained by the weight which it supports. Every part of a pillar is equally strained by the load which it supports. A mill axle is equally twisted and strained in every part which lies between the part of the wheel actuated by the moving power and the part which is resisted by the work to be performed. Every part of a lever or joint is differently strained by a force acting on a distant part.

It is evident that we cannot make the structure fit for its purpose, unless the strength at every part be at least equal to the stress laid on, or the strain excited in that part. It is no less plain, that if we are ignorant of the principles which determine this strain, both in in-

tenfy and direction, in relation to the magnitude and the situation of its remote cause, the only security we have for success is to give to every part of the assemblage such solidity that we can leave no doubt of its sufficiency. But only experience shows us that this vague security is in many cases uncertain, if we are thus ignorant. In all cases it is slovenly, unlike an artful, attended with waste's expence, and in machines is attended with a loss of power which is wasted in changing the motions of a needless load of matter.

It must therefore greatly tend to the improvement of all professions occupied in the erection or employment of such structures, to have a distinct notion of the strains to which these parts are exposed. Frequently, nay generally, these strains are not immediate, but arise from the action of forces on distant parts, by which the assemblage is strained, and there is a tendency to rupture in every part. This strain is induced on every part, and is there modified by fixed mechanical laws. There it is our business to learn; but our chief object in this investigation is to determine the strength of materials which it is necessary to oppose in every part to this strain; and how to oppose this strength in such a manner that it shall be exerted to the best advantage. The notions of strain and strength therefore hardly admit of separation; for it is even by means of the strength of the intermediate parts that the strain is propagated to, or excited in, the part under consideration. It is proper therefore to consider the whole together under the article **STRENGTH of Materials** in mechanics.

STRAINING, is the clarification of a liquor, by passing it through a sieve or filter. The word is derived from the French, *effreindre*; which is formed from *ex*, "out of," and *fringere*, "to press."

STRAIT, a narrow channel or arm of the sea, shut up between lands on either side, and affording a passage out of one great sea into another.

There are three kinds of straits. 1. Such as join one ocean to another. Of this kind are the straits of Magellan and Le Maire. 2. Those which join the ocean to a gulf; the straits of Gibraltar and Babelmandel are of this kind, the Mediterranean and Red sea being only large gulfs. 3. Those which join one gulf to another; as the straits of Caffa, which join the Palus Mæotis to the Euxine or Black sea. The passage of straits is commonly dangerous, on account of the rapidity and opposite motion of currents. The most celebrated strait in the world is that of Gibraltar, which is about from 24 to 36 miles long, and from 15 to 24 broad, joining the Mediterranean sea with the Atlantic ocean. The straits of Magellan, discovered in 1520 by F. Magellan, were used some time as a passage out of the North into the South sea; but since the year 1616, that the strait of Le Maire has been discovered, the former has been disused; both because of its length, which is full three hundred miles, and because the navigation thereof is very dangerous, from the waves of the North and South seas meeting in it and clashing. The strait at the entrance of the Baltic is called the *Sound*; that between England and France, *Le pas de Calais*, or the *Channel*. There are also the straits of Weigats, of Jess, of Anian, of Davis, and Hudson, &c.

STRAKES, or **STREAKS**, in a ship, the uniform ranges of planks on the bottom and sides of a ship, or the continuation of planks joined to the ends of each other,

Strakes
||
Strange

other, and reaching from the item to the stern-post and fashion-pieces; the low-fl of these, which is called the *garboard-strake*, is let into the keel below, and into the item and stern-post. They say also a *Keel's heels a strake*, that is, hangs or inclines to one side the quantity of a whole plank's breadth.

STRAKES, or *Straks*, in mining, are frames of boards fixed on or in the ground, where they wash and dress the small ore in a little stream of water, hence called *strakod ore*.

STRALSUND, a strong and rich sea-port town of Germany, in Hither Pomerania, formerly an important trading-place. In 1678 it was forced to surrender to the elector of Brandenburg, after 1800 houses had been burnt to ashes in one night's time. After this the Swedes defended it to the last extremity; and Chas. XII. in 1714, came hither after his return out of Turkey. But the throne of Sweden not being able to hold out against five great powers, it was forced to submit in 1715. In 1720 it was rendered back to Sweden, but in a very poor condition. It is almost surrounded by the sea and the lake Francon, and has a harbour separated from the life of Rügen by a narrow strait. It is 15 miles north-west of Gröppwald, and 40 north-east of Gültrow. E. Long. 13. 28. N. Lat. 54 17.

STRAMONIUM, a species of plant. See DATURA, BOTANY Index.

STRAND (*Saxo*), any shore or bank of a sea or great river. Hence the street in the west suburbs of London, which lay next the shore or bank of the Thames, was called the *Strand*. An immunity from custom, and all impositions upon goods or vessels by land or water, was usually expressed by *strand* or *stream*.

STRANDED (from the Saxon *strand*), is when a ship is by tempest, or by ill steeerage, run on ground, and so perishes. Where a vessel is stranded, justices of the peace, &c. shall command constables near the sea-coasts to call assistance for the preservation of the ship; and officers of men of war are to be aiding and assisting thereto.

STRANGE, SIR ROBERT, an eminent engraver, who carried the art to great perfection in this country, and was distinguished not only as an artist, but highly respected and beloved on account of his private virtues and domestic habits. Modest as he was ingenious, his life to say that the works of an artist should serve for his life and monument. His works no doubt will perpetuate his name whilst any taste for the fine arts remains.

Sir Robert Strange was born in the island of Pomona in Orkney, July the 14th 1721; and died at London July the 5th 1792. He was lineally descended from David Strange or Strang, a younger son of the family of the Stranges or Strangs of Balcauky, in the county of Fife, who settled in Orkney at the time of the Reformation. But as there were no males remaining of the elder branch of the Stranges of Balcauky, Sir Robert became the male representative of it, and was found by a legal investigation to have a right to the armorial bearings and every other mark of honour belonging to that ancient family.

He received his classical education at Kirkwall in Orkney, under the care of a learned, worthy, and much respected gentleman, Mr Murdoch Mackenzie, who has rendered infinite service to his country by the accurate

surveys and charts he has given of the islands of Orkney, and of the British and Irish coasts. Strange.

Originally intended for the law, Mr Strange soon became tired of that profession, and perceived that his genius decisively led him to the arts of drawing and engraving. For this purpose he was introduced to the late Mr Richard Cooper at Edinburgh, the only person there who had then any taste in that line of the fine arts. He was bound with him as an apprentice for six years; during which time he made such progress in his new profession, that his friends entertained the highest expectation of his success; nor were they disappointed.

In the year 1747 he married Isabella, only daughter of William Lumiden, son of Bishop Lumiden; and soon after his marriage he went to France, where with the most ardent application he prosecuted his studies, chiefly at Paris, under the direction of the celebrated Le Bas, who engraved many excellent prints from the Dutch painters. It was from Le Bas he had the first hint of the use of the instrument commonly called the *dry needle*; but which he afterwards greatly improved by his own genius, and which has added such superior beauties to his engravings.

In the year 1751 Mr Strange removed with his family from Edinburgh and settled at London, where he engraved several fine historical prints, which justly acquired to him great reputation. At this period historical engraving had made little progress in Britain, and he may be properly considered as its father.

The admiration he always had for the works of the great Italian painters made him long desire to visit Italy, the seat of the fine arts; and the farther he advanced in life, he became the more persuaded that a journey to that country was essential to an artist who had the laudable ambition to excel in his profession. He therefore undertook this journey in the year 1760. In Italy he made many admirable drawings, several of which he afterwards engraved. These drawings are now in the possession of Lord Dundas.

Everywhere in Italy singular marks of attention were bestowed on Mr Strange; not only by great personages, but by the principal academies of the fine arts in that country. He was made a member of the academies of Rome, Florence, and Bologna, and professor in the royal academy at Parma.

To show the estimation in which his talents were held at Rome, we cannot but record the following anecdote. The ceiling of the room of the Vatican library, in which the collection of engravings is kept, is elegantly painted by Signor Rotfancelli. It represents the progress of engraving; and the portraits of the most eminent artists in that line are there introduced, among which is that of our artist. Under his arm he holds a portfolio, on which his name is inscribed. He is the only British artist on whom this honour has been conferred.

In France, where he resided many years at different periods, his talents likewise received every mark of attention that could be bestowed on a foreigner. He was made a member of the royal academy of painting at Paris.

His majesty King George III. ever attentive to the progress of the fine arts in Britain, and sensible of the advantages of which engraving particularly has been to this

this country, even in a commercial light; and deigns to give a mark of his royal approbation of the merit of Mr Strange, whom he considered as at the head of his profession and the great improver of it—was graciously pleased to confer the honour of knighthood on him the 5th of January 1787.

Such was Sir Robert Strange as an artist; nor was he less distinguished by his truly amiable moral qualities, which endeared him to all who had the happiness to know him.

With regard to his works, he left fifty capital plates, still in good condition, which are carefully preserved in his family. They are engraved from pictures by the most celebrated painters of the Roman, Florentine, Lombard, Venetian, and other schools. They are historical, both sacred and profane, poetical, allegorical.

From his earliest establishment in life, Sir Robert carefully preferred about eighty copies of the finest and most choice impressions of each plate he engraved; which, from length of time, have acquired a beauty, mellowness, and brilliancy, easier seen than described. He did this with a view of presenting them to the public at a period when age should disable him from adding to their number. These he collected into as many volumes, and arranged them in the order in which they were engraved. To each volume he prefixed two portraits of himself, on the same plate, the one an etching, the other a finished proof, from a drawing by John Baptiste Greufe. This is the last plate which he engraved; and is a proof that neither his eyes nor hand were impaired by age. It likewise shows the use he made both of aquafortis and the graver. Each volume, besides a dedication to the king, contains an introduction on the progress of engraving, and critical remarks on the pictures from which his engravings are taken. These volumes were ready to be given to the public, when Sir Robert's death delayed this magnificent publication; a publication which does so much honour to the artist, and to the country which gave him birth. He died at London 6th July 1792.

The following is an authentic catalogue of his works. Plate 1. Two Heads of the author—one an etching, the other a finished proof, from a drawing by John Baptiste Greufe; 2. The Return from Market, by Wouvermans; 3. Cupid, by Vanloo; 4. Mary Magdalen, by Guido; 5. Cleopatra, by the same; 6. The Madonna, by the same; 7. The Angel Gabriel, by the same; 8. The Virgin, holding in her hand a book, and attended by angels, by Carlo Maratti; 9. The Virgin with the Child asleep, by the same; 10. Liberality and Modesty, by Guido; 11. Apollo rewarding Merit and punishing Arrogance, by Andrea Sacchi; 12. The Finding of Romulus and Remus, by Pietro da Cortona; 13. Caesar repudiating Pompeia, by the same; 14. Three Children of King Charles I. by Vandyke; 15. Bellarius, by Salvator Rosa; 16. St Agnes, by Dominico; 17. The Judgement of Hercules, by Nicolas Poussin; 18. Venus attired by the Graces, by Guido; 19. and 20. Justice and Meekness, by Raphael; 21. The O-Spring of Love, by Guido; 22. Cupid Striking, by the same; 23. Abraham giving up the Headship of Har, by Guercino; 24. Esther a Suppliant before Ahasuerus, by the same; 25. Joseph and Potiphar's Wife, by Guido; 26. Venus Blinding Cupid, by Titian; 27. Venus, by the same; 28. Danae, by the same; 29.

Portrait of King Charles I. by Vandyke; 30. The Madonna, by Correggio; 31. St Cecilia, by Raphael; 32. Mary Magdalen, by Guido; 33. Our Saviour appearing to his Mother after his Resurrection, by Guercino; 34. A Mother and Child, by Parmegiano; 35. Cupid Meditating, by Schidoni; 36. Laomedon King of Troy decubed by Neptune and Apollo, by Salvator Rosa; 37. The Death of Dido, by Guercino; 38. Venus and Adonis, by Titian; 39. Fortune, by Guido; 40. Cleopatra, by the same; 41. Two Children at School, by Schidoni; 42. Mary Magdalen, by Correggio; 43. Portrait of King Charles I. attended by the marquis of Hamilton, by Vandyke; 44. Queen Henrietta, attended by the Prince of Wales, and holding in her arms the Duke of York, by the same; 45. Apotheosis of the Royal Children, by West; 46. The Annunciation, by Guido; 47. Portrait of Raphael Sancio D'Urbino, by himself; 48. Sappho, by Carlo Dolci; 49. Our Saviour asleep, by Vandyke; 50. St John in the Desert, by Murillo.

STRANGER, in Law, denotes a person who is not privy or party to an act. Thus a stranger to a judgement is he to whom a judgement does not belong; in which sense the word stands directly opposed to party or privy.

STRANGLES, in *Ferriery*. See that article, N^o 481.

STRANGURY, a suppression of urine. See MEDICINE *Index*.

STRAP, among surgeons, a sort of band used to stretch out limbs in the setting of broken or disjunct bones.

STRAP, in a ship, the rope which is spliced about any block, and made with an eye to fasten it anywhere on occasion.

STRAPS, in the manege. The straps of a saddle are small leather straps, nailed to the bows of the saddle, with which we make the girths fast to the saddle.

STRAPADO, or STRAPADO, a kind of military punishment, wherein the criminals hands being tied behind him, he is hoisted up with a rope to the top of a long piece of wood, and let fall again almost to the ground; so that, by the weight of his body in the shock, his arms are dislocated. Sometimes he is to undergo three strapados or more.

STRASBURG, an ancient, large, handsome, and strong city of France, in Alsace, with a population of 40,000. It contains about 200 streets, part of which are very narrow, and most of the houses are built after the ancient taste. However, there are a great number of handsome buildings, such as the hotel of the marshal of France, who is commander of the city; the hotel of the cardinal of Rouen, the bishop's palace, the Jesuits college, the royal hospital, the hotel of H. E. D. Amstutz, the arsenal, the town-house, and the cathedral. It has a wooden bridge over the Rhine, which is thought to be one of the finest in Europe; as is likewise the cathedral church, whose tower is the handsomest in Germany, and the clock is greatly admired by all travellers. Some look upon it as one of the wonders of the world, and the people is allowed to be the highest in Europe. The clock not only shows the hours of the day, but the motion of the sun, moon, and stars. Among other things there is an anchor, which turns an

Stratæ,
Strata.

hour-glass every hour; and the twelve apostles proclaim noon, by each of them striking a blow with a hammer on a bell. There is likewise a cock, which is a piece of clock-work, that crows every hour. There are 700 steps up to the tower or steeple, it being 500 feet high. It was a free and imperial city; but the king of France became master of it in 1681, and great y augmented the fortifications, though before it had 365 cannon. The inhabitants were formerly Protestants, and carried on a great trade; but most of them have been obliged to embrace the Romish superstition, though there is still a sort of toleration. Such was Strasburg before the French revolution; what it is now we have not leisure to inquire. It is located on the river Ill, 55 miles north of Basle, 112 south-west of Metz, and 253 east of Paris. E. Long. 7. 51. N. Lat. 48. 35.

STRATA, in *Natural History*, the several beds or layers of different matters whereof the earth is composed. See GEOLOGY.

The strata whereof the earth is composed are so very different in different countries, that it is impossible to say any thing concerning them that may be generally applicable: and indeed the depths to which we can penetrate are so small, that only a very few can be known to us at any rate; those that lie near the centre, or even a great way from it, being for ever hid. One reason why we cannot penetrate to any great depth is, that as we go down the air becomes foul, loaded with pernicious vapours, inflammable air, fixed air, &c. which destroy the miners, and there is no possibility of going on. In many places, however, these vapours become pernicious much sooner than in others, particularly where sulphureous minerals abound, as in mines of metal, coal, &c.

But however great differences there may be among the under strata, the upper one is in some respects the same all over the globe, at least in this respect, that it is fit for the support of vegetables, which the others are not, without long exposure to the air. Properly speaking, indeed, the upper stratum of the earth all round, is composed of the pure vegetable mold, though in many places it is mixed with large quantities of other strata, as clay, sand, gravel, &c.; and hence proceed the differences of soils so well known to those who practise agriculture.

It has been supposed, by some naturalists, that the different strata of which the earth is composed were originally formed at the creation, and have continued in a manner immutable ever since: but this cannot possibly have been the case, since we find that many of the strata are strangely intermixed with each other; the bones of animals both marine and terrestrial are frequently found at great depths in the earth; beds of cypher-shells are found of immense extent in several countries; and concerning these and other shell-fish, it is remarkable, that they are generally found much farther from the surface than the bones or teeth either of marine or terrestrial animals. Neither are the shells or other remains of fish found in those countries adjoining to the seas where they grow naturally, but in the most distant regions. Mr Whitehurst, in his Inquiry into the Original State and Formation of the Earth, has given the following account of many different kinds of animals, whose shells and other remains or *osseous* are found

in England; though at present the living animals are not to be found except in the East and West Indies.

A CATALOGUE of EXTRANEOUS FOSSILS, showing where they were dug up; also their native Climates. Myself selected from the curious Cabinet of Mr NELLSON, in King-street, Red-Lion Square.

| Their names, and Places where found. | Native Climate. |
|--|---|
| CHAMBERED NAUTILUS. Sheppy islands; Richmond in Surrey; Sherbone in Dorsetshire, - | Chinese Ocean, and other Parts of that great sea. |
| TEETH OF SHARKS. Sheppy island, Oxfordshire, Middlesex, Surrey, Northamptonshire, - | East and West Indies. |
| SEA-LORTOISE, several kinds; the Hawk-bill, Logger-head, and Green species. Sheppy island, - | West Indies. |
| MANGROVE TREE OYSTERS. Sheppy island, - | West Indies. |
| COXCOMB TREE OYSTERS. Oxfordshire, Gloucestershire, Dorsetshire, and Hanover, - | Coast of Guinea. |
| VERTEBRÆ and PALATES of the ORBES. Sheppy island, and many other parts of England, - | East and West Indies. |
| CROCODILE. Germany, Derbyshire, Nottinghamshire, Oxfordshire, and Yorkshire, - | East and West Indies. |
| ALLIGATOR'S TEETH. Oxfordshire, Sheppy island, - | East and West Indies. |
| THE BANDED BUCCINUM. Oxfordshire, and the Alps, - | West Indies. |
| THE DIPPING-SNAIL, and STAR-FISH. Sheppy island, - | West Indies. |
| TAIL PUCINUM. Sheppy island, Hordel Cliff, Hampshire, - | East Indies. |

Nothing has more perplexed those who undertake to form theories of the earth than these appearances. Some have at once boldly asserted, from these and other phenomena, that the world is eternal. Others have had recourse to the universal deluge. Some, among whom is the Count de Euffon, endeavour to prove that the ocean and dry land are perpetually changing places; that for many ages the highest mountains have been covered with water, in consequence of which the marine animals just mentioned were generated in such vast quantities, that the waters will again cover these mountains. the habitable part of the earth become sea, and the sea become dry land as before, &c. Others have imagined that they might be occasioned by volcanoes, earthquakes, &c. which confound the different strata, and often intermix the productions of the sea with those of the dry land.

But for a view of the different strata so far as they are known; as well as for a view of some of the theories which have been proposed to account for the formation and changes of the earth, see GEOLOGY.

Mr Forster has given an account of some of the strata of the South-sea islands, the substance of which may be seen in the following table.

SOUTH GEORGIA.

1. No soil, except in a few crevices of the rocks.

2. Ponderous slate, with some iron particles, in horizontal strata, perpendicularly intersected with veins of quartz.

Southern Isle of New Zealand.

1. Fine light black mould, in some places nine inches deep, but generally not so much.
2. An argillaceous substance, nearly related to the class of TALCONS, turned into earth by the action of the air.
3. The same substance farther indurated, in oblique strata, generally dipping to the south.

EASTER ISLAND.

1. Reddish-brown dusty mould, looking as if it had been burnt.
2. Burnt rocks, resembling flags or dross and other volcanic matters.

MARQUESAS.

1. Clay mixed with mould.
2. An earthy argillaceous substance mixed with tarras and puzzolana.

OTAHEITE.

The shores are coral rock, extending from the reef encircling these isles to the very high water-mark. There begins the sand, formed in some places from small shells and rubbed pieces of coral; but in others the shores are covered with blackish sand, consisting of the former sort mixed with black, sometimes glittering, particles of mica, and here and there some particles of the refractory iron ores called in England SKIM, the *ferrum micaceum* of Linnæus, and KALL, the *molybdenum spuma lupi* of the same author. The plains from the shores to the foot of the hills are covered with a very fine thick stratum of black mould, mixed with the above-mentioned sand, which the natives manure with shells. The first and lower range of hills are formed of a red ochreous earth, sometimes so intensely red, that the natives use it to paint their canoes and cloth. The higher hills consist of a hard, compact, and stiff clayey substance, hardening into stone when out of the reach of the sun and air. At the top of the valleys, along the banks of the rivers, are large masses of coarse granite stones of various mixtures; in one place are pillars of a grey, solid basalt; and, in several others, fragments of black basalt.

FRIENDLY ISLANDS and New HEBRIDES.

The same with the above.

MALLICOLLO.

Yellowish clay mixed with common sand.

TANNA, a *Volcanic Island.*

The chief strata here are clay mixed with aluminous earth, interspersed with lumps of pure chalk. The strata of the clay are about six inches, deviating very little from the horizontal line.

NEW CALEDONIA and the adjacent Isles.

The shores consist of shell-sand, and particles of quartz; the soil in the plains a black mould mixed with this

land. The sides of the hills composed of a yellow ochreous clay, richly spangled with small particles of cat-silver, or a whitish kind of daze, the *mica argentea* of Linnaus. The higher parts of the hills consist of a stone called by the German miners *gesslein*, composed of quartz and great lumps of the above cat-silver. The latter is sometimes of an intensely red or orange colour, by means of an iron ochre.

"From the above account, says Mr Forster, it appears, I think, evidently, that all the high tropical isles of the South sea have been subject to the action of volcanoes. Pyritical and sulphurous substances, together with a few iron-stones, and some vestiges of copper, are no doubt found in several of them: but the mountains of New Caledonia are the most likely to contain the richest metallic veins; and the same opinion, I suspect, may be formed of the mountains in New Zealand."

In the city of Modena in Italy, and for some miles round that place, there is the most singular arrangement of strata perhaps in the whole world. From the surface of the ground to the depth of 14 feet, they meet with nothing but the ruins of an ancient city. Being come to that depth, they find paved streets, artificers shops, floors of houses, and several pieces of inland work. After these ruins they find a very solid earth, which one would think had never been removed; but a little lower they find it black and marly, and full of briars. Signior Ramazzini in one place found a heap of wheat entire at the depth of 24 feet; in another, he found silbert-trees with their nuts. At the depth of about 28 feet, they find a bed of chalk, about 11 feet deep, which cuts very easily; after this a bed of marly earth of about two feet, mixed with rushes, leaves, and branches. After this bed comes another of chalk, nearly of the same thickness; and which ends at the depth of 42 feet. This is followed by another bed of marly earth like the former; after which comes a new chalk-bed, but thinner, which also has a marly bed underneath it. This ends at the depth of 63 feet; after which they find sand mingled with small gravel, and several marine shells. This stratum is usually about five feet deep, and underneath it is a vast reservoir of water. It is on account of this water that the soil is so frequently dug, and the strata so well known in this part of the world. After coming to the sandy bottom above-mentioned, the workmen pierce the ground with a terebra or augre, when the water immediately springs up with great force, and fills the well to the brim. The flow is perpetual, and neither increases by rain, nor decreases by drought. Sometimes the augre meets with great trees, which give the workmen much trouble; they also sometimes see at the bottom of these wells great bones, coals, flints, and pieces of iron.

It has been asserted by some, that the specific gravity of the strata constantly increased with the depth from the surface. But Dr Leigh, in his Natural History of Lancashire, speaking of the coal-pits, denies the strata to lie according to the laws of gravitation; observing, that the strata there are first a bed of marble, then free-stone, next iron-stone, then coal, or channel mire, then some other strata, then coal again, &c. This determined Mr Derham to make a nice inquiry into the matter: accordingly, in 1712, he caused divers places to be bored, laying the several strata by themselves;

Strata
||
Stratists.

themselves; and afterwards determined very carefully their specific gravity. The result was, that in his yard the strata were gradually specifically heavier and heavier the lower and lower they went; but in another place in his fields, he could not perceive any difference in the specific gravities.

Accounting the Royal Society therewith, their operator Mr Hooke was ordered to try the strata of a coal pit, which he did to the depth of 30 strata: the thickness and specific gravity of each whereof he gives us in a table in the Philosophical Transactions; and from the whole makes this inference, that it evidently appears the gravities of the several strata are in no manner of order, but purely casual, as if mixed by chance.

STRATAGEM, in the art of war, any device for deceiving and surprising an enemy. The ancients dealt very much in stratagems: the moderns wage war more openly, and on the square. Frontinus has made a collection of the ancient stratagems of war.

STRATEGUS, *στρατηγος*, in antiquity, an officer among the Athenians, whereof there were two chosen yearly, to command the troops of the state.

Plutarch says, there was one chosen from out of each tribe; but Pollux seems to say they were chosen indifferently out of the people. The people themselves made the choice; and that on the last day of the year, in a place called *Πρυξ*. The two *strategi* did not command together, but took their turns day by day; as we find from Herodotus and Cornelius Nepos. Sometimes indeed, as when a person was found of merit vastly superior, and exceedingly famed in war, the command was given to him alone: but it was ever a rule not to put any person in the office but whose estate was in Attica, and who had children, that there might be some hostages and securities for his conduct and fidelity. Constantine the Great, besides many other privileges granted to the city of Athens, honoured its chief magistrate with the title of *Μεγας Στρατηγος*, *Magnus Dux*.

STRATH, in the Scottish language, signifies a long narrow valley, with a river running along the bottom.

STRATHEARN, a beautiful and extensive valley in Perthshire, bounded on the north by the lofty ridge of mountains called the *Grampians*, and on the south by the Ocellis, which are rounded on the tops and covered with verdure. It is called *Strathearn* from the river Earn, which runs through the middle of it from west to east for about 30 miles. On each side of the banks of this beautiful stream are many villages and country-seats distinguished for romantic situations. Were we to single out any of the villages, we would mention Crieff, which stands on a fine sloping ground on the north side of the Earn, and has been much admired by travellers for its situation, and the variety, contrast, singularity, and beauty of the prospect which it affords.

STRATHNAVER, a subdivision or district of the county of Sutherland in Scotland; bounded on the north by the ocean, on the east by Caithness, on the south by Sutherland properly so called, and on the west partly by Ross and partly by the ocean.

STRATIOTES, WATER-SOLDIER, a genus of plants belonging to the class polyandria. See *POTANY Index*.

STRATO, a philosopher of Lampfacus, disciple and successor in the school of Theophrastus, about 248 years before the Christian era. He applied himself with uncommon industry to the study of nature; and after the most mature investigations, he supported that nature was inanimate, and that there was no god but nature. (See *PLASTIC Nature*). He was appointed preceptor to Ptolemy Philadelphus, who not only revered his abilities and learning, but also rewarded his labours with unbounded liberality. He wrote different treatises, all now lost.

STRAWBERRY. See *FRAGARIA*, *BOTANY Index*.

STRAWBERRY-Tree. See *ARBUTUS*, *POTANY Index*.

STRENGTH OF MATERIALS, in *Mechanics*, is an Importance subject of so much importance, that in a nation so eminent as this for invention and ingenuity in all species of manufactures, and in particular so distinguished for its improvements in machinery of every kind, it is somewhat singular that no writer has treated it in the detail which its importance and difficulty demands. The man of science who visits our great manufactories is delighted with the ingenuity which he observes in every part, the innumerable inventions which come even from individual artificers, and the determined purpose of improvement and refinement which he sees in every workshop. Every cotton mill appears an academy of mechanical science; and mechanical invention is spreading from these fountains over the whole kingdom: But the philosopher is mortified to see this ardent spirit so cramped by ignorance of principle, and many of these original and brilliant thoughts obscured and clogged with needless and even hurtful additions, and a complication of machinery which checks improvement even by its appearance of ingenuity. There is nothing in which this want of scientific education, this ignorance of principle, is so frequently observed as in the injudicious proportion of the parts of machines and other mechanical structures; proportions and forms of parts in which the strength and position are nowise regulated by the strains to which they are exposed, and where repeated failures have been the only lessons.

It cannot be otherwise. We have no means of instruction, except two very short and abstracted treatises of the late Mr Emerson on the strength of materials. We do not recollect a performance in our language from which our artists can get information. Treatises written expressly on different branches of mechanical arts are totally silent on this, which is the basis and *only principle* of their performances. Who would imagine that PRICE'S *BRITISH CARPENTER*, the work of the first reputation in this country, and of which the sole aim is to teach the carpenter to erect solid and durable structures, does not contain one proposition or one reason by which one form of a thing can be shown to be stronger or weaker than another? We doubt very much if one carpenter in an hundred can give a reason to convince his own mind that a joint is stronger when laid on its edge than when laid on its broad side. We speak in this strong manner in hopes of exciting some man of science to publish a system of instruction on this subject. The limits of our Work will not admit of a detail: but we think it necessary to point out the leading principles, and to give the traces of that systematic connection by which all the knowledge already possessed of this subject may be brought

Strato
||
Strength of
Materials.

Strength of Brought together and properly arranged. This we shall
 Materials now attempt in as brief a manner as we are able.

2 Strength of THE strength of materials arises immediately or ulti-
 materials mately from the cohesion of the parts of bodies. Our
 arises from cohesion. examination of this property of tangible matter has as yet been very partial and imperfect, and by no means enables us to apply mathematical calculations with precision and success. The various modifications of cohesion, in its different appearances of perfect softness, pliability, ductility, elasticity, hardness, have a mighty influence on the strength of bodies, but are hardly susceptible of measurement. Their texture also, whether uniform like glass and ductile metals, crystallized or granulated like other metals and freestone, or fibrous like timber, is a circumstance no less important; yet even here, although we derive some advantage from remarking to which of these forms of aggregation a substance belongs, the aid is but small. All we can do in this want of general principles is to make experiments on every class of bodies. Accordingly philosophers have endeavoured to instruct the public in this particular. The Royal Society of London at its very first institution made many experiments at their meetings, as may be seen in the first registers of the Society*. Several individuals have added their experiments. The most numerous collection in detail is by Machenbroek, professor of natural philosophy at Leyden. Part of it was published by himself in his *Essais de Physique*, in two vols. 4to; but the full collection is to be found in his *System of Natural Philosophy*, published after his death by Lulofs, in three vols 4to. This was translated from the Low Dutch into French by Sigaud de la Fond, and published at Paris in 1763, and is a prodigious collection of physical knowledge of all kinds, and may almost suffice for a library of natural philosophy. But this collection of experiments on the cohesion of bodies is not of that value which one expects. We presume that they were carefully made and faithfully narrated; but they were made on such small specimens, that the unavoidable natural inequalities of growth or texture produced irregularities in the results which bore too great a proportion to the whole quantities observed. We may make the same remark on the experiments of Couplet, Pitot, De la Hire, Du Hamel, and others of the French academy. In short, if we except the experiments of Buffon on the strength of timber, made at the public expence on a large scale, there is nothing to be met with from which we can obtain absolute measures which may be employed with confidence; and there is nothing in the English language except a simple list by Emerson, which is merely a set of affirmations, without any narration of circumstances, to enable us to judge of the validity of his conclusions; but the character of Mr Emerson, as a man of knowledge and of integrity, gives even to these assertions a considerable value.

3 Experiments to ascertain it.

* See Bache's *History*, and Hooke's *Mathematical Collections*.

4 But to make use of any experiments, there must be employed some general principle by which we can generalize their results. They will otherwise be only narrations of detached facts. We must have some notion of that intermedium, by the intervention of which an external force applied to one part of a lever, joint, or pillar, occasions a strain on a distant part. This can be nothing but the cohesion between the parts. It is this connecting force which is brought into action, or, as we

more shortly express it, excited. This action is manifested in every part by the laws of mechanics. It is this action which is what we call the *Strength* of that part, and its effect is the strain on the adjoining parts; and thus it is the same force, differently viewed, that constitutes both the strain and the strength. When we consider it in the light of a resistance to fracture, we call it *Strength*.

We call every thing a *force* which we observe to be ever accompanied by a change of motion; or, more strictly speaking, we infer the presence and agency of a force wherever we observe the state of things, in respect of motion different from what we know to be the result of the action of all the forces which we know to act on the body. Thus when we observe a rope prevent a body from falling, we infer a moving force inherent in the rope with as much confidence as when we observe it drag the body along the ground. The immediate action of this force is undoubtedly exerted between the immediately adjoining parts of the rope. The immediate effect is the keeping the particles of the rope together. They ought to separate by any external force drawing the ends of the rope contrariwise; and we ascribe their not doing so to a mechanical force really opposing this external force. When desired to give it a name, we name it from what we conceive to be its effect, and therefore its characteristic, and we call it COHESION. This is merely a name for the fact; but it is the same thing in all our denominations. We know effects, notling of the causes but in the effects; and our name for the cause is in fact the name of the effect, which is COHESION. We mean nothing else by gravitation or magnetism. What do we mean when we say that Newton understood thoroughly the nature of gravitation, of the force of gravitation; or that Franklin understood the nature of the electric force? Nothing but this. Newton considered with patient sagacity the general facts of gravitation, and has described and classed them with the utmost precision. In like manner, we shall understand the nature of cohesion when we have discovered with equal generality the laws of cohesion, or general facts which are observed in the appearances, and when we have described and classed them with equal accuracy.

Let us therefore attend to the more simple and obvious phenomena of cohesion, and mark with care every circumstance of resemblance by which they may be classed. Let us receive these as the laws of cohesion, characteristic of its supposed cause, the force of cohesion. We cannot pretend to enter on this vast research. The modifications are innumerable: and it would require the penetration of more than Newton to detect the circumstance of similarity amidst millions of discriminating circumstances. Yet this is the only way of discovering which are the primary facts characteristic of the force, and which are the modifications. The study is immense, but it is by no means desperate; and we entertain great hopes that it will ere long be successfully prosecuted; but, in our particular predicament, we must content ourselves with selecting such general laws as seem to give us the most immediate information of the circumstances that must be attended to by the mechanician in his constructions, that he may unite strength with simplicity, economy, and energy.

1. Then, it is a matter of fact that all bodies are in a certain

Strength of
Materials
7
All bodies
elastic.

certain degree perfectly elastic; that is, when their form or bulk is changed by certain moderate compressions or dilations, it requires the continuance of the changing force to continue the body in this new state; and when the force is removed, the body recovers its original form. We limit the assertion to *certain moderate* changes: For instance, take a lead wire of one-fiftieth of an inch in diameter and ten feet long; fix one end firmly to the ceiling, and let the wire hang perpendicular; affix to the lower end an index like the hand of a watch; on some stand immediately below let there be a circle divided into degrees, with its centre corresponding to the lower point of the wire: now turn this index twice round, and thus twist the wire. When the index is let go, it will turn backwards again, by the wire's untwisting itself, and make almost four revolutions before it stops; after which it twists and untwists many times, the index going backwards and forwards round the circle, diminishing however its arch of twist each time, till at last it settles precisely in its original position. This may be repeated for ever. Now, in this motion, every part of the wire partakes equally of the twist. The particles are stretched, require force to keep them in their state of extension, and recover completely their relative positions. These are all the characters of what the mechanician calls *perfect elasticity*. This is a quality quite familiar in many cases; as in glass, tempered steel, &c. but was thought incompetent to lead, which is generally considered as having little or no elasticity. But we make the assertion in the most general terms, with the limitation to moderate derangement of form. We have made the same experiment on a thread of pipe-clay, made by forcing soft clay through the small hole of a syringe by means of a screw; and we found it more elastic than the lead wire: for a thread of one-twentieth of an inch diameter and seven feet long allowed the index to make two turns, and yet completely recovered its first position.

2. But if we turn the index of the lead wire four times round, and let it go again, it untwists again in the same manner, but it makes little more than four turns back again; and after many oscillations it finally stops in a position almost two revolutions removed from its original position. It has now acquired a new arrangement of parts, and this new arrangement is permanent like the former; and, what is of particular moment, it is perfectly elastic. This change is familiarly known by the denomination of a *SET*. The wire is said to have *TAKEN A SET*. When we attend minutely to the procedure of nature in this phenomenon, we find that the particles have as it were slid on each other, still cohering, and have taken a new position, in which their connecting forces are in equilibrium: and in this change of relative situation, it appears that the connecting forces which maintained the particles in their first situation were not in equilibrium in some position intermediate between that of the first and that of the last form. The force required for changing this first form augmented with the change, but only to a certain degree; and during this process the connecting forces always tended to the recovery of this first form. But after the change of mutual position has passed a certain magnitude, the union has been partly destroyed, and the particles have been brought into new situations; such, that the forces which now connect each with its neighbour tend, not

8
What is
meant by
set.

to the recovery of the first arrangement, but to push them farther from it, into a new situation, to which they now verge, and require force to prevent them from acquiring. The wire is now in fact again perfectly elastic; that is, the forces which now connect the particles with their neighbours augment to a certain degree as the derangement from this new position augments. This is not reasoning from any theory. It is narrating facts, on which a theory is to be founded. What we have been just now saying is evidently a description of that sensible form of tangible matter which we call *ductility*. It has every gradation of variety, from the softness of butter to the firmness of gold. All these bodies have some elasticity; but we say they are not perfectly elastic, because they do not completely recover their original form when it has been greatly damaged. The whole gradation may be most distinctly observed in a piece of glass or hard sealing wax. In the ordinary form glass is perhaps the most completely elastic body that we know, and may be bent till just ready to snap, and yet completely recovers its first form, and takes no set whatever; but when heated to such a degree as just to be visible in the dark, it loses its brittleness, and becomes so tough that it cannot be broken by any blow; but it is no longer elastic, takes any set, and keeps it. When more heated, it becomes as plastic as clay; but in this state is remarkably distinguished from clay by a quality which we may call *visciditv*, which is something like elasticity, of which clay and other bodies purely plastic exhibit no appearance. This is the joint operation of strong adhesion and softness. When a rod of perfectly soft glass is suddenly stretched a little, it does not at once take the shape which it acquires after some little time. It is owing to this, that in taking the impression of a seal, if we take off the seal while the wax is yet very hot, the sharpness of the impression is destroyed immediately. Each part drawing its neighbour, and each part yielding, the prominent parts are pulled down and blunted, and the sharp hollows are pulled upwards and also blunted. The seal must be kept on till all has become not only stiff but hard.

to
Visciditv.

This visciditv is to be observed in all plastic bodies which are homogeneous. It is not observed in clay, because it is not homogeneous, but consists of hard particles of argillaceous earth sticking together by their attraction for water. Something like it might be made of finely powdered glass and a clammy fluid such as turpentine. Visciditv has all degrees of softness till it degenerates to rosy fluidity like that of olive oil. Perhaps something of it may be found even in the most perfect fluid that we are acquainted with, as we observed in the experiments for ascertaining specific gravity.

xx
Observed
in all ho-
mogeneous
plastic bo-
dies.

There is in a late volume of the Philosophical Transactions a narrative of experiments, by which it appears that the thread of the spider is an exception to our first general law, and that it is perfectly ductile. It is there asserted, that a long thread of gossamer, furnished with an index, takes any position whatever; and that though the index be turned round any number of times (even many hundreds), it has no tendency to recover its first form. The thread takes completely any set whatever. We have not had an opportunity of repeating this experiment, but we have distinctly observed a phenomenon totally inconsistent with it. If a fibre of gossamer about an inch long be held by the end horizontally, it bends downward

Strength of Materials. downward in a curve like a slender slip of whalebone or a hair. If totally devoid of elasticity, and perfectly indifferent to any set, it would hang down perpendicularly without any curvature.

When ductility and elasticity are combined in different proportions, an immense variety of sensible modes of aggregation may be produced. Some degree of both are probably to be observed in all bodies of complex constitution; that is, which consist of particles made up of many different kinds of atoms. Such a constitution of a body must afford many situations permanent, but easily deranged.

12
Particles acted on by attractions and repulsions

In all these changes of disposition which take place among the particles of a ductile body, the particles are at such distance that they still cohere. The body may be stretched a little; and on removing the extending force, the body shrinks into its first form. It also resists moderate compressions; and when the compressing force is removed, the body swells out again. Now the corpufcular fact here is, that the particles are acted on by attractions and repulsions, which balance each other when no external force is acting on the body, and which augment as the particles are made, by any external cause, to recede from this situation of mutual inactivity; for since force is requisite to produce either the dilatation or the compression, and to maintain it, we are obliged, by the constitution of our minds, to infer that it is opposed by a force accompanying or inherent in every particle of dilatable or compressible matter; and as this necessity of employing force to produce a change indicates the agency of these corpufcular forces, and marks their kind, according as the tendencies of the particles appear to be toward each other in dilatation, or from each other in compression; so it also measures the degrees of their intensity. Should it require three times the force to produce a double compression, we must reckon the mutual repulsions triple when the compression is doubled; and so in other instances. We see from all this that the phenomena of cohesion indicate some relation between the centres of the particles.

13
The great problem in corpufcular mechanism.

To discover this relation is the great problem in corpufcular mechanism, as it was in the Newtonian investigation of the force of gravitation. Could we discover this law of action between the corpufcles with the same certainty and distinctness, we might with equal confidence say what will be the result of any position which we give to the particles of bodies; but this is beyond our hopes. The law of gravitation is so simple, that the discovery or detection of it amid the variety of celestial phenomena required but one step; and in its own nature its possible combinations still do not greatly exceed the powers of human research. One is almost disposed to say that the Supreme Being has exhibited it to our reasoning powers as sufficient to employ with success our utmost efforts, but not to abstruse as to discourage us from the noble attempt. It seems to be otherwise with respect to cohesion. Mathematics informs us, that if it deviates sensibly from the law of gravitation, the simplest combinations will make the joint action of several particles an almost impenetrable mystery. We must therefore content ourselves, for a long time to come, with a careful observation of the simplest cases that we can propose, and with the discovery of secondary laws of action, in which many particles combine their influence. In pursuance of this plan, we observe,

3. That whatever is the situation of the particles of a body with respect to each other, when in a quiescent state, they are kept in these situations by the balance of opposite forces. This cannot be refused, nor can we form to ourselves any other notion of the state of the particles of a body. Whether we suppose the ultimate particles to be of certain magnitudes and shapes, touching each other in single points of cohesion; or whether we (with Boetovitch) consider them as at a distance from each other, and acting on each other by attractions and repulsion—we must acknowledge, in the first place, that the centres of the particles (by whose mutual distances we must estimate the distance of the particles) may and do vary their distances from each other. What else can we say when we observe a body increase in length, in breadth, and in thickness, by heating it, or when we see it diminish in all these dimensions by an external compression? A particle, therefore, situated in the midst of many others, and remaining in that situation, must be conceived as maintained in it by the mutual balancing of all the forces which connect it with its neighbours. It is like a ball kept in its place by the opposite action of two springs. This illustration merits a more particular application. Suppose a number of balls ranged on the table in the angles of equilateral triangles, and that each ball is connected with the six which lie around it by means of an elastic wire curled like a cork-screw; suppose such another stratum of balls above this, and parallel to it, and so placed that each ball of the upper stratum is perpendicularly over the centre of the equilateral triangle below, and let these be connected with the balls of the under stratum by similar spiral wires. Let there be a third and a fourth, and any number of such strata, all connected in the same manner. It is plain that this may extend to any size and fill any space.—Now let this assemblage of balls be firmly contemplated by the imagination, and be supposed to shrink continually in all its dimensions, till the balls, and their distances from each other, and the connecting wires, all vanish from the sight as discrete individual objects. All this is very conceivable. It will now appear like a solid body, having length, breadth, and thickness; it may be compressed, and will again resume its dimensions; it may be stretched, and will again shrink; it will move away when struck; in short, it will not differ in its sensible appearance from a solid elastic body. Now when this body is in a state of compression, for instance, it is evident that any one of the balls is at rest, in consequence of the mutual balancing of the actions of all the spiral wires which connect it with those around it. It will greatly conduce to the full understanding of all that follows to recur to this illustration. The analogy or resemblance between the effects of this constitution of things and the effects of the corpufcular forces is very great; and wherever it obtains, we may safely draw conclusions from what we know would be the condition of a body of common tangible matter. We shall just give one instructive example, and then have done with this hypothetical body. We can suppose it of a long shape, resting on one point; we can suppose two weights A, B, suspended at the extremities, and the whole in equilibrium. We commonly express this state of things by saying that A and B are in equilibrium. This is very inaccurate. A is in fact in equilibrium with the united action of all the springs which connect the ball to which it is applied

Strength of Materials.
14
Particles kept in their places by a balance of forces.

15
Illustration of this proposition.

16
By example.

Strength of
Materials.Strength of
Materials.

with the adjoining balls. These springs are brought into action, and each is in equilibrium with the joint action of all the rest. Thus through the whole extent of the hypothetical body, the springs are brought into action in a way and in a degree which mathematics can easily investigate. We need not do this: it is enough for our purpose that our imagination readily discovers that some springs are stretched, others are compressed, and that a pressure is exerted on the middle point of support, and the support excites a reaction which precisely balances it; and the other weight is, in like manner, in immediate equilibrium with the equivalent of the actions of all the springs which connect the last ball with its neighbours. Now take the analogical or resembling case, an oblong piece of solid matter, resting on a fulcrum, and loaded with two weights in equilibrium. For the actions of the connecting springs substitute the corpuscular forces, and the result will resemble that of the hypothesis.

Now as there is something that is at least analogous to a change of distance of the particles, and a concomitant change of the intensity of the connecting forces, we may express this in the same way that we are accustomed to do in similar cases. Let A and B (fig. 1.) represent the centres of two particles of a coherent elastic body in their quiescent inactive state, and let us consider only the mechanical condition of B. The body may be stretched. In this case the distance AB of the particles may become AC. In this state there is something which makes it necessary to employ a force to keep the particles at this distance. C has a tendency towards A, or we may say that A attracts C. We may represent the magnitude of this tendency of C towards A, or this attraction of A, by a line Cc perpendicular to AC. Again, the body may be compressed, and the distance AB may become AD. Something obliges us to employ force to continue this compression; and D tends from A, or A appears to repel D. The intensity of this tendency or repulsion may be represented by another perpendicular Dd; and, to represent the different directions of these tendencies, or the different nature of these actions, we may let Dd on the opposite side of AB. It is in this manner that the Abbé Boscovich has represented the actions of corpuscular forces in his celebrated Theory of Natural Philosophy. Newton had said, that, as the great movements of the solar system were regulated by forces operating at a distance, and varying with the distance, so he strongly suspected (*valde suspicor*) that all the phenomena of cohesion, with all its modifications in the different sensible forms of aggregation, and in the phenomena of chemistry and physiology, resulted from the similar agency of forces varying with the distance of the particles. The learned Jesuit pursued this thought; and has shown, that if we suppose an ultimate atom of matter endowed with powers of attraction and repulsion, varying, both in kind and degree, with the distance, and if this force be the same in every atom, it may be regulated by such a relation to the distance from the neighbouring atom, that a collection of such may have all the sensible appearance of bodies in their different forms of solids, liquids, and vapours, elastic or unelastic, and endowed with all the properties which we perceive, by whose immediate operation the phenomena of motion by impulse, and all the phenomena of chemistry, and of animal and vegetable economy, may be produced. He shows, that notwithstanding a

perfect sameness, and even a great simplicity in this atomical constitution, there will result from this union all that unpeppable variety of form and property which diversity and embellish the face of nature. We shall take another opportunity of giving such an account of this celebrated work as it deserves. We mention it only, by the bye, as far as a general notion of it will be of some service on the present occasion. For this purpose, we just observe that Boscovich conceives a particle of any individual species of matter to consist of an unknown number of particles of simpler constitution; each of which particles, in their turn, is compounded of particles still more simply constituted, and so on through an unknown number of orders, till we arrive at the simplest possible constitution of a particle of tangible matter, susceptible of length, breadth, and thickness, and necessarily consisting of four atoms of matter. And he shows that the more complex we suppose the constitution of a particle, the more must the sensible qualities of the aggregate resemble the observed qualities of tangible bodies. In particular, he shows how a particle may be so constituted, that although it act on one other particle of the same kind through a considerable interval, the interposition of a third particle of the same kind may render it totally, or almost totally, inactive; and therefore an assemblage of such particles would form such a fluid as air. All these curious inferences are made with incontrovertible evidence; and the greatest encouragement is thus given to the mathematical philosopher to hope, that by cautious and patient proceeding in this way, we may gradually approach to a knowledge of the laws of cohesion, that will not thus a comparison even with the *Principia* of Newton. No step can be made in this investigation, but by observing with care, and generalizing with judgement, the phenomena, which are abundantly numerous, and much more at our command than those of the great and sensible motions of bodies. Following this plan, we observe,

4. It is matter of fact, that every body has some degree of compressibility and dilatability; and when the changes of dimension are so moderate that the body completely recovers its original dimensions on the cessation of the changing force, the extensions or compressions are sensibly proportional to the extending or compressing forces: and therefore the connecting forces are proportional to the distances of the particles from their quiescent, neutral, or inactive positions. This seems to have been first viewed as a law of nature by the penetrating eye of Dr Robert Hooke, one of the most eminent philosophers of the last century. He published a cipher, which he said contained the theory of springiness and of the motions of bodies by the action of springs. It was this, *cellino sessu*.—When explained in his dissertation, published some years after, it was *ut tensio sic vis*. This is precisely the proposition just now asserted as a general fact, a law of nature. This dissertation is full of curious observations of facts in support of his assertion. In his application to the motion of bodies he gives his noble discovery of the balance-spring of a watch, which is founded on this law. The spring, as it is more and more coiled up, or uncoiled, by the motion of the balance, acts on it with a force proportional to the distance of the balance from its quiescent position. The balance therefore is acted on by an accelerating force, which varies in the same manner as the force of gravity

Plate
DNL
Fig. 1.17
How Boscovich represents the action of corpuscular forces.15
Every body is compressible and dilatible.19
Law discovered by Dr Hooke.

Strength of gravity acting on a pendulum swinging in a cycloid. **Materials.** Its vibrations therefore must be performed in equal time, whether they are wide or narrow. In the same dilatation Hooke mentions all the facts which John Bernoulli afterwards adduced in support of Leibnitz's whimsical doctrine of the force of bodies in motion, or the doctrine of the *vires vires*; a doctrine which Hooke might justly have claimed as his own, had he not seen its utility.

Ad con- Experiments made since the time of Hooke show that **firm by the** this law is strictly true in the extent to which we have limited it, viz. in all the changes of form which will be completely undone by the elasticity of the body. It is nearly true to a much greater extent. James Bernoulli, in his dissertation on the elastic curve, relates some experiments of his own, which seem to deviate considerably from it; but on close examination they do not. The finest experiments are those of Coulomb, published in some late volumes of the memoirs of the Academy of Paris. He suspended balls by wires, and observed their motions of oscillation, which he found accurately corresponding with this law.

This we shall find to be a very important fact in the doctrine of the strength of bodies, and we desire the reader to make it familiar to his mind. If we apply to this our manner of expressing these forces by perpendicular ordinates Cc , Dd (fig. 1), we must take other situations E , F , of the particle B , and draw Ee , Ff ; and we must have $Dd : Ff = BD : BF$; or $Cc : Ee = EC : BE$. In such a supposition Fd Bec must be a straight line. But we shall have abundant evidence by and by that this cannot be strictly true, and that the line Bec which limits the ordinates expressing the attractive forces becomes concave towards the line ABE , and that the part Bdf is convex towards it. All that can be safely concluded from the experiments hitherto made is, that to a certain extent the forces, both attractive and repulsive, are sensibly proportional to the dilatations and compressions. For,

5. It is universally observed, that when the dilatations have proceeded a certain length, a less addition of force is sufficient to increase the dilatation in the same degree. This is always observed when the body has been so far stretched that it takes a set, and does not completely recover its form. The like may be generally observed in compressions. Most persons will recollect, that in violently stretching an elastic cord, it becomes suddenly weaker, or more easily stretched. But these phenomena do not positively prove a diminution of the corporeal force acting on one particle: It more probably arises from the division of some particles, whose action contributed to the whole or sensible effect. And in compressions we may suppose something of the same kind; for when we compress a body in one direction, it commonly bulges out in another; and in cases of very violent action some particles may be divided, whose transverse action had formerly balanced part of the compressing force. For the reader will see on reflection, that since the compression in one direction causes the body to bulge out in the transverse direction; and since this bulging out is in opposition to the transverse forces of attraction, it must employ some part of the compressing force. And the common appearances are in perfect uniformity with this conception of things. When we press a bit of dryish clay, it swells out and cracks transversely. When a pillar of wood is overloaded, it

swells out, and small crevices appear in the direction of the fibres. After this it will not bear half of the load. This the carpenters call CRIPPLING; and a knowledge of the circumstances which modify it is of great importance, and enables us to understand some very paradoxical appearances, as will be shown by and by.

This partial dividing of particles formerly cohering is, we imagine, the chief reason why the totality of the forces which really oppose an external strain does not increase in the proportion of the extensions and compressions. But sufficient evidence will also be given that the forces which would connect one particle with one other particle do not augment in the accurate proportion of the change of distance; that in extensions they increase more slowly, and in compressions more rapidly.

But there is another cause of this deviation perhaps equally effectual with the former. Most bodies manifest some degree of ductility. Now what is this? The fact is, that the parts have taken a new arrangement, in which they again cohere. Therefore, in the passage to this new arrangement, the sensible forces, which are the joint result of many corporeal forces, begin to respect this new arrangement instead of the former. This must change the simple law of corporeal force, characteristic of the particular species of matter under examination. It does not require much reflection to convince us that the possible arrangements which the particles of a body may acquire, without appearing to change their nature, must be more numerous according as the particles are of a more complex constitution; and it is reasonable to suppose that the constitution even of the most simple kind of matter that we are acquainted with is exceedingly complex. Our microscopes show us animals so minute, that a heap of them must appear to the naked eye an uniform mass with a grain finer than that of the finest marble or razor hone; and yet each of these has not only limbs, but bones, muscular fibres, blood-vessels, fibres, and a blood consisting, in all probability, of globules organized and complex like our own. The imagination is here left in wonder; and nothing is left us but to adore inconceivable art and wisdom, and to exult in the thought that we are the only spectators of this beautiful scene who can derive pleasure from the view. What is trodden under foot with indifference, even by the half-reasoning elephant, may be made by us the source of the purest and most unmixed pleasure. But let us proceed to observe,

6. That the forces which connect the particles of the tangible bodies change by a change of distance, not only in degree, but also in kind. The particle B (fig. 1) is attracted by A when in the situation C or E . It is repelled by it when at D or F . It is not affected by it when in the situation B . The reader is requested carefully to remark, that this is not an inference founded on the authority of our mathematical figure. The figure is an expression (to assist the imagination) of facts in nature. It requires no force to keep the particles of a body in their quietest situations; but if they are separated by stretching the body, they endeavour (pardon the figurative expression) to come together again. If they are brought nearer by compression, they endeavour to recede. This endeavour is manifested by the necessity of employing force to maintain the extension or condensation; and we represent this by the different position

21
When a body is much dilated, a small addition of force will increase its dilatation.

Materials. ²² Ductility another cause of deviation.

23
The forces which connect the particles of tangible bodies change by a change of distance, not only in degree, but also in kind.

Strength of
Materials.

of our lines. But this is not all: the particle B, which is repelled by A when in the situation F or D, is neutral when at B, and is attracted when at C or E, may be placed at such a distance AG from A greater than AB that it shall be again repelled, or at such a distance AH that it shall again be attracted; and these alterations may be repeated again and again. This is curious and important, and requires something more than a bare assertion for its proof.

24
Light al-
ternately
attracted
and repel-
led.

In the article OPTICS we mentioned the most curious and valuable observations of Sir Isaac Newton, by which it appears that light is thus alternately attracted and repelled by bodies. The rings of colour which appear between the object glasses of long telescopes showed, that in the small interval of $\frac{1}{1000}$ th of an inch, there are at least an hundred such changes observable, and that it is highly probable that these alternations extend to a much greater distance. At one of these distances the light actually converges towards the solid matter of the glass, which we express shortly, by saying that it is attracted by it, and that at the next distance it declines from the glass, or is repelled by it. The same thing is more simply inferred from the phenomena of light passing by the edges of knives and other opaque bodies. We refer the reader to the experiments themselves, the detail being too long for this place; and we request him to consider them minutely and attentively, and to form distinct notions of the inferences drawn from them. And we desire it to be remarked, that although Sir Isaac, in his discussion, always considers light as a set of corpuscles moving in free space, and obeying the actions of external forces like any other matter, the particular conclusion in which we are just now interested does not at all depend on this notion of the nature of light. Should we, with Des Cartes or Huygens, suppose light to be the undulation of an elastic medium, the conclusion will be the same. The undulations at certain distances are disturbed by forces directed towards the body, and at a greater distance, the disturbing forces tend from the body.

25
The same
alternations
of attrac-
tion and
repulsion
observable
in the par-
ticles of
other bod-
ies, as
glass.

But the same alternations of attraction and repulsion may be observed between the particles of common matter. If we take a piece of very flat and well-polished glass, such as is made for the horizon glasses of a good Hadley's quadrant, and if we wrap round it a fibre of silk as it comes from the cocoon, taking care that the fibre nowhere cross another, and then press this pretty hard on such another piece of glass, it will lift it up and keep it suspended. The particles therefore of the one do most certainly attract those of the other, and this at a distance equal to the thickness of the silk fibre. This is nearly the limit; and it sometimes requires a considerable pressure to produce the effect. The pressure is effectual only by compressing the silk fibre, and thus diminishing the distance between the glass plates. This adhesion cannot be attributed to the pressure of the atmosphere, because there is nothing to hinder the air from insinuating itself between the plates, since they are separated by the silk. Besides, the experiment succeeds equally well under the receiver of an air-pump. This most valuable experiment was first made by Huygens, who reported it to the Royal Society. It is narrated in the Philosophical Transactions, N^o 86.

Here then is an attraction acting, like gravity, at a distance. But take away the silk fibre, and try to make

Strength of
Materials.

the glasses touch each other, and we shall find a very great force necessary. By Newton's experiments it appears, that unless the prismatic colours begin to appear between the glasses, they are at least $\frac{1}{1000}$ th of an inch asunder or more. Now we know that a very considerable force is necessary for producing these colours, and that the more we press the glasses together the more rings of colours appear. It also appears from Newton's measures, that the difference of distance between the glasses where each of these colours appear is about the $89,000$ th part of an inch. We know farther, that when we have produced the last appearance of a greasy or pearly colour, and then augment the pressure, making it about a thousand pounds on the square inch, all colours vanish, and the two pieces of glass seem to make one transparent undistinguishable mass. They appear now to have no air between them, or to be in mathematical contact. But another fact shows this conclusion to be premature. The same circles of colours appear in the top of a soap bubble; and as it grows thinner at top, there appears an unreticulating spot in the middle. We have the greatest probability therefore that the perfect transparency in the middle of the two glasses does not arise from their being in contact, but because the thickness of air between them is too small in that place for the reflection of light. Nay, Newton expressly found no reflection where the thickness was $\frac{1}{2}$ ths or more of the $333,333$ th part of an inch.

All this while the glasses are strongly repelling each other, for great pressure is necessary for continuing the appearance of those colours, and they vanish in succession as the pressure is diminished. This vanishing of the colours is a proof that the glasses are moving off from each other, or repelling each other. But we can put an end to this repulsion by very strong pressure, and at the same time sliding the glasses on each other. We do not pretend to account for this effect of the sliding motion; but the fact is, that by so doing, the glasses will cohere with very great force, so that we shall break them by any attempt to pull them asunder. It commonly happens (at least it did so with us), that in this sliding compression of two smooth flat plates of glass they scratch and mutually destroy each other's surface. It is also worth remarking, that different kinds of glass exhibit different properties in this respect. Flint glass will attract even though a silk fibre lies double between them, and they much more readily cohere by this sliding pressure.

Here then are two distances at which the plates of glass attract each other; namely, when the silk fibre is interposed, and when they are forced together with this sliding motion. And in any intermediate situation they repel each other. We see the same thing in other solid bodies. Two pieces of lead made perfectly clean, may be made to cohere by grinding them together in the same manner. It is in this way that pretty ornaments of silver are united to iron. The piece is scraped clean, and a small bit of silver like a fish scale is laid on. The die which is to strike it into a flower or other ornament is then set on it, and we give it a smart blow, which forces the metals into contact as firm as if they were soldered together. It sometimes happens that the die adheres to the coin so that they cannot be separated: and it is found that this frequently happens, when the engraving is such, that the raised figure is not complete-

26
Lead and
iron.

Strength of Materials. ly surrounded with a smooth flat ground. The probable cause of this is curious. When the coin has a flat surface all around, this is produced by the most prominent part of the die. This applies to the metal, and completely confines the air which filled the hollow of the die. As the pressure goes on, the metal is squeezed up into the hollow of the die; but there is still air compressed between them, which cannot escape by any passage. It is therefore prodigiously condensed, and exerts an elasticity proportioned to the condensation. This serves to separate the die from the metal when the stroke is over. The hollow part of the die has not touched the metal all the while, and we may say that the impression was made by air. If this air escape by any engraving reaching through the border, they cohere inseparably.

We have admitted that the glass plates are in contact when they cohere thus firmly. But we are not certain of this: for if we take these coloring glasses, and touch them with water, it quickly infiltrates itself between them. Yet they still cohere, but can now be pretty easily separated.

It is owing to this repulsion, exerted through its proper sphere, that certain powders swim on the surface of water, and are wetted with great difficulty. Certain insects can run about on the surface of water. They have bristly feet, which occupy a considerable surface; and if their feet are viewed with a magnifying glass, the surface of the water is seen depressed all around, resembling the footsteps of a man walking on feather-beds. This is owing to a repulsion between the brush and the water. A common fly cannot walk in this manner on water. Its feet are wetted, because they attract the water instead of repelling it. A steel needle, wiped very clean, will lie on the surface of water, making an impression as a great bar would make on a feather bed; and its weight is less than that of the displaced water. A dew drop lies on the leaves of plants without touching them mathematically, as is plain from the extreme brilliancy of the reflection at the posterior surface; nay, it may be sometimes observed that at the drops of rain lie on the surface of water, and roll about on it like balls on a table. Yet all these substances can be wetted; that is, water can be applied to them at such distances that they attract it.

What we said a little ago of water insinuating itself between the glass plates without altogether destroying their cohesion, shows that this cohesion is not the same that obtains between the particles of one of the plates; that is, the two plates are not in the state of one continued mass. It is highly probable, therefore, that between these two states there is an intermediate state of repulsion, nay, perhaps many such, alternated with attractive forces.

A piece of ice is elastic, for it rebounds and rings. Its particles, therefore, when compressed, resist; and when stretched, contract again. The particles are therefore in the state represented by B in figure 1, acted on by repulsive forces, if brought nearer; and by attractive forces, if drawn further asunder. Ice expands, like all other bodies, by heat. It absorbs a vast quantity of fire; which, by confounding its attractions and repulsions with those of the particles of ice, changes completely the law of adhesion, without making any sensible change in the distance of the particles, and the ice becomes w-

Strength of Materials. ter. In this new state the particles are again in limits between attractive and repulsive forces; for water has been shown, by the experiments of Canton and Zimmerman, to be elastic or compressible. It again expands by heat. It again absorbs a prodigious quantity of heat, and becomes elastic vapour; its particles, repelling each other at all distances yet observed. The distance between the particles of one plate of glass and those of another which lies on it, and is carried by it, is a distance of repulsion; for the force which supports the upper piece is acting in opposition to its weight. This distance is less than that at which it would *supposed* it be below it with a silk fibre interposed; for no prismatic colours appear between them when the silk fibre is interposed. But the distance at which glass attracts water is much less than this, for no colours appear when glass is wetted with water. This distance is less, and not greater, than the other; for when the glasses have water interposed between them instead of air, it is found, that when any particular colour appears, the thickness of the plate of water is to that of the plate of air which would produce the same colour nearly as 3 to 4. Now, if a piece of glass be wetted, and exhibit no colour, and another piece of glass be simply laid on it, no colour will appear; but if they are strongly pressed, the colours appear in the same manner as if the glasses had air between. Also, when glass is simply wetted, and the film of water is allowed to evaporate, when it is thus reduced to a proper thinness, the colours show themselves in great beauty.

These are a few of many thousand facts, by which it is unquestionably proved that the particles of tangible matter are connected by forces acting at a distance, varying with the distance, and alternately attractive and repulsive. If we represent these forces as we have already done in fig. 1. by the ordinates C, D, E, F, G , &c. of a curve, it is evident that this curve must cross the axis at all those distances where the forces change from attractive to repulsive, and the curve must have branches alternately above and below the axis.

All these alternations of attraction and repulsion take place at small and insensible distances. At all sensible distances the particles are influenced by the attraction of gravitation; and therefore this part of the curve must be a hyperbola whose equation is $y = \frac{a^2}{x}$. What is the

form of the curve corresponding to the smallest distance of the particles? that is, what is the mutual action between the particles just before their coming into absolute contact? Analogy should lead us to suppose it to be repulsion: for solidity is the last and simplest form of bodies with which we are acquainted.—Fluids are more compounded, containing fire as an essential ingredient. We should conclude that this ultimate repulsion is insuperable, for the hardest bodies are the most elastic. We are fully entitled to say, that this repelling force exceeds all that we have ever yet applied to overcome it; nay, there are good reasons for saying that this ultimate repulsion, by which the particles are kept from a mathematical contact, is really insuperable in its own nature, and that it is impossible to produce mathematical contact.

We will all just mention one of these, which we consider as unanswerable. Suppose two atoms, or ultimate particles of matter A and B. Let A be at rest, and B move

Strength of
Materials. (move up to it with the velocity 2; and let us suppose that it comes into mathematical contact, and impels it (according to the common acceptance of the word). Both move with the velocity 1. This is granted by all to be the final result of the collision. Now the instant of time in which this communication happens is no part either of the duration of the solitary motion of A, nor of the joint motion of A and B: It is the separation or boundary between them. It is at once the end of the first, and the beginning of the second, belonging equally to both. A was moving with the velocity 2. The distinguishing circumstance therefore of its mechanical state is, that it has a determination (however incomprehensible) by which it would move for ever with the velocity 2, if nothing changed it. This it has during the whole of its solitary motion, and therefore in the last instant of this motion. In like manner, during the whole of the joint motion, and therefore in the first instant of this motion, the atom A has a determination by which it would move for ever with the velocity 1. In one and the same instant, therefore, the atom A has two incompatible determinations. Whatever notion we can form of this state, which we call velocity, as a distinction of condition, the same impossibility of conception or the same absurdity occurs. Nor can it be avoided in any other way than by saying, that this change of A's motion is brought about by insensible gradations; that is, that A and B influence each other precisely as they could do if a slender spring were interposed. The reader is desired to look at what we have said in the article PHYSICS, § 82.

The two magnets there spoken of are good representations of two atoms endowed with mutual powers of repulsion; and the communication of motion is accomplished in both cases in precisely the same manner.

If, therefore, we shall ever be so fortunate as to discover the law of variation of that force which connects one ATOM of matter with another atom, and which is therefore characteristic of matter, and the ultimate source of all its sensible qualities, the curve whose ordinates represent the kind and the intensity of this atomical force will be something like that sketched in fig. 2. The first branch $a n B$ will have $A K$ (perpendicular to the axis $A H$) for its asymptote, and the last branch $l m o$ will be to all sense a hyperbola, having $A O$ for its asymptote; and the ordinates $A l, m, E, \&c.$ will be proportional to $\frac{1}{A l^2}, \frac{1}{A m^2}, \&c.$ expressing the universal gravitation of matter. It will have many branches $B b C, D d E, F f G, \&c.$ expressing attractions, and alternate repulsive branches $C c D, E e F, G g H, \&c.$ All these will be contained within a distance $A H$, which does not exceed a very minute fraction of an inch.

The first part of this curve which can be a constituent of a body being length, breadth, and thickness, must consist of two such parts, all of which conditions their influence on each atom of another such particle. It is evident that the curve which expresses the forces that connect two such particles will be totally different from this original curve, this last being a simple one. Something the last known, our mathematical knowledge is a terrible difficulty over the first; but when we proceed to compose a body of particles, each of which consists of four such particles, we may observe as follows, that the component force which connects them is thus $\frac{1}{4}$ of that which, and that the

discovery of the primary force from an accurate knowledge of the corpular forces of this particular matter is absolutely out of our power.

All that we can learn is, the possibility, may the certainty, of an innumerable variety of external sensible forms and qualities, by which different kinds of matter will be distinguished, arising from the number, the order of competition, and the arrangement of the subderivative particles of which a particle of this or that kind of matter is composed. All these varieties will take place at those small and insensible distances which are between A and H, and may produce all that variety which we observe in the tangible or mechanical forms of bodies, such as elasticity, ductility, hardness, softness, fluidity, vapour, and all those unseen motions or actions which we observe in fusion and congelation, evaporation and condensation, solution and precipitation, crystallization, vegetable and animal assimilation and secretion, &c. &c. &c. while all bodies must be, in a certain degree, elastic, all must gravitate, and all must be impenetrable.

This general and satisfactory resemblance between the appearance of tangible matter and the legitimate consequence of this general hypothetical property of an atom of matter, affords a considerable probability that such is the origin of all the phenomena. We earnestly recommend to our readers a careful perusal of Boolevich's celebrated treatise. A careful perusal is necessary for seeing its value; and nothing will be got by a hasty look at it. The reader will be particularly pleased with the facility and evidence with which the ingenious author has deduced all the ordinary principles of mechanics, and with the explanation which he has given of fluidity, and his deduction from thence of the laws of hydrostatics. No part of the treatise is more valuable than the doctrine of the propagation of pressure through solid bodies. This, however, is but just touched on in the course of the investigation of the principles of mechanics. We shall borrow as much as will suffice for our present inquiry into the strength of materials; and we trust that our readers are not displeas'd with this general sketch of the doctrine (if it may be so called) of the cohesion of bodies. It is curious and important in itself, and is the foundation of all the knowledge we can acquire of the present article. We are sorry to say that it is as yet a new subject of study; but it is a very promising one, and we by no means despair of seeing the whole of chemistry brought by its means within the pale of mechanical science. The great and distinguishing agent in chemistry is heat, or fire the cause of heat; and one of its most singular effects is the conversion of bodies into elastic vapour. We have the clearest evidence that this is brought about by mechanical forces: for it can be opposed or prevented by external pressure, a very familiar mechanical force. We may perhaps find another mechanical force which will prevent fusion.

The foundation of all the knowledge we can acquire of the present article. We are sorry to say that it is as yet a new subject of study; but it is a very promising one, and we by no means despair of seeing the whole of chemistry brought by its means within the pale of mechanical science. The great and distinguishing agent in chemistry is heat, or fire the cause of heat; and one of its most singular effects is the conversion of bodies into elastic vapour. We have the clearest evidence that this is brought about by mechanical forces: for it can be opposed or prevented by external pressure, a very familiar mechanical force. We may perhaps find another mechanical force which will prevent fusion.

Having now made our readers familiar with the mode of action in which cohesion operates in giving strength to solid bodies, we proceed to consider the means to which this strength is equipp'd.

A piece of solid matter is exposed to four kinds of strains, pretty different in the manner of their operation, which are

1. It may be torn aunder, as in the case of ropes, Rretchers, King-pows, eye-banms, &c.

11
The name
of the
material
is
given
to
the
body.

37
The
time of
a new
ject.

Strength of Materials.

2. It may be crushed, as in the case of pillars, posts, and truss beams.
3. It may be broken across, as happens to a joist or lever of any kind.
4. It may be wrenched or twisted, as in the case of the axle of a wheel, the nail of a press, &c.

I. IT MAY BE PULLED ASUNDER.

34 Matter may be pulled asunder.

This is the simplest of all strains, and the others are indeed modifications of it. To this the force of cohesion is *directly* opposed, with very little modification of its action by any particular circumstances.

When a long cylindrical or prismatic body, such as a rod of wood or metal, or a rope, is drawn by one end, it must be resisted at the other, in order to bring its cohesion into action. When it is fastened at one end, we cannot conceive it any other way than as equally stretched in all its parts; for all our observations and experiments on natural bodies concur in showing us that the forces which connect their particles, in any way whatever, are equal and opposite. This is called the *third law of motion*; and we admit its universality, while we affirm that it is purely experimental (see PHYSICS). Yet we have met with dissertations by persons of eminent knowledge, where propositions are maintained inconsistent with this. During the dispute about the communication of motion, some of the ablest writers have said, that a spring compressed or stretched at the two ends was gradually less and less compressed or stretched from the extremities towards the middle: but the same writers acknowledged the universal equality of action and reaction, which is quite incompatible with this state of the spring. No such inequality of compression or dilatation has ever been observed; and a little reflection will show it to be impossible, in consistency with the equality of action and reaction.

Since all parts are thus equally stretched, it follows, that the strain in any transverse section is the same, as also in every point of that section. If therefore the body be supposed of a homogeneous texture, the cohesion of the parts is equable; and since every part is equally stretched, the particles are drawn to equal distances from their quiescent positions, and the forces which are thus excited and now exerted in opposition to the stretching force, are equal. This external force may be increased by degrees, which will gradually separate the parts of the body more and more from each other, and the connecting forces increase with this increase of distance, till at last the cohesion of some particles is overcome. This must be immediately followed by a rupture, because the remaining forces are now weaker than before.

It is the united force of cohesion, immediately before the division of the first particles, that we call the STRENGTH of the section. It may also be properly called its ABSOLUTE STRENGTH, being exerted in the simplest form, and not modified by any relation to other circumstances.

25 A cylindrical bar, &c. to be attended to in every construction requiring strength.

If the external force has not produced any permanent change on the body, and it therefore recovers its former dimensions when the force is withdrawn, it is plain that this strain may be repeated as often as we please, and the body which withstands it once will always withstand it. It is evident that this should be attended to in all con-

structions, and that in all our investigations on this subject it should be kept strictly in view. When we treat a piece of soft clay in this manner, and with this precaution, the force employed must be very small. If we exceed this, we produce a permanent change. The rod of clay is not indeed torn asunder; but it has become somewhat more slender: the number of particles in a cross section is now smaller; and therefore, although it will again, in this new form, suffer, or allow an endless repetition of a *certain* strain without any further permanent change, this strain is smaller than the former.

Strength of Materials.

Something of the same kind happens in all bodies which receive a STRAIN by the strain to which they are exposed. All ductile bodies are of this kind. But there are many bodies which are not ductile. Such bodies break completely whenever they are stretched beyond the limit of their perfect elasticity. Bodies of a fibrous structure exhibit very great varieties in their cohesion. In some the fibres have no lateral cohesion, as in the case of a rope. The only way in which all the fibres can be made to unite their strength is, to twist them together. This causes them to bind each other so fast, that any one of them will break before it can be drawn out of the bundle. In other fibrous bodies, such as timber, the fibres are held together by some cement or gluten. This is seldom as strong as the fibre. Accordingly timber is much easier pulled asunder in a direction transverse to the fibres. There is, however, every possible variety in this particular.

36 Great varieties in cohesion.

In stretching and breaking fibrous bodies, the visible extension is frequently very considerable. This is not solely the increasing of the distance of the particles of the cohering fibre: the greatest part chiefly arises from drawing the crooked fibre straight. In this, too, there is great diversity; and it is accompanied with important differences in their power of withstanding a strain. In some woods, such as fir, the fibres on which the strength most depends are very straight. Such woods are commonly very elastic, do not take a set, and break abruptly when overstrained: others, such as oak and birch, have their resisting fibres very undulating and crooked, and stretch very sensibly by a strain. They are very liable to take a set, and they do not break so suddenly, but give warning by *complaining*, as the carpenters call it; that is, by giving visible signs of a derangement of texture. Hard bodies of an uniform glassy structure, or granulated like stones, are elastic through the whole extent of their cohesion, and take no set, but break at once when overloaded.

Notwithstanding the immense variety which nature exhibits in the structure and cohesion of bodies, there are certain general facts of which we may now avail ourselves with advantage. In particular,

The absolute cohesion is proportional to the area of the section. This must be the case where the texture is perfectly uniform, as we have reason to think it is in crystals and the ductile metals. The cohesion of each particle being alike, the whole cohesion must be proportional to their number, that is, to the area of the section. The same must be admitted with respect to bodies of a granulated texture, where the granulation is equal and uniform. The same must be admitted of fibrous bodies, if we suppose their fibres equally strong, equally

of dense, and similarly disposed through the whole section; and this we must either suppose, or must state the diversity, and measure the cohesion accordingly.

We may therefore assert, as a general proposition on this subject, that the absolute strength in any part of a body by which it resists being pulled asunder, or the force which must be employed to tear it asunder in that part, is proportional to the area of the section perpendicular to the extending force.

Therefore all cylindrical or prismatic rods are equally strong in every part, and will break alike in any part; and bodies which have unequal sections will always break in the slenderest part. The length of the cylinder or prism has no effect on the strength; and the vulgar notion, that it is easier to break a very long rope than a short one, is a very great mistake. Also the absolute strengths of bodies which have similar sections are proportional to the squares of their diameters or homologous sides of the section.

The weight of the body itself may be employed to strain it and to break it. It is evident, that a rope may be so long as to break by its own weight. When the rope is hanging perpendicularly, although it is equally strong in every part, it will break towards the upper end, because the strain on any part is the weight of all that is below it. Its RELATIVE STRENGTH in any part, or power of withstanding the strain which is actually laid on it, is inversely as the quantity below that part.

When the rope is stretched horizontally, as in towing a ship, the strain arising from its weight often bears a very sensible proportion to its whole strength.

Fig. 3. Let AEB (fig. 3) be any portion of such a rope, and AC, BC be tangents to the curve into which its gravity bends it. Complete the parallelogram ACRD. It is well known that the curve is a catenaria, and that DC is perpendicular to the horizon; and that DC is to AC as the weight of the rope AEB to the strain at A.

In order that a suspended heavy body may be equally able in every part to carry its own weight, the section in that part must be proportional to the solid contents of all that is below it. Suppose it a conical spindle, formed by the revolution of the curve Aae (fig. 4) round the axis CE. We must have $AC^2 : ae^2 = AEB \text{ sol.} : a E b \text{ sol.}$ This condition requires the logarithmic curve for Aae, of which Ce is the axis.

These are the chief general rules which can be fully deduced from our cleared notions of the cohesion of bodies. In order to make a very practical use of them, it is proper to have some measures of the cohesion of such bodies as are commonly employed in our mechanics, and other structures where they are exposed to this kind of strain. These must be deduced solely from experiment.

Fig. 4. Therefore they must be considered as no more than general values, or as the averages of many particular trials. The irregularities are very great, because none of the substances are constant in their texture and firmness. Metals differ by a thousand circumstances unknown to us, according to their purity, to the heat with which they were melted, to the moulds in which they were

cast, and the treatment they have afterwards received, Strength of Metals.

It is a very curious and inexplicable fact, that by forging a metal, or by frequently drawing it through a smooth hole in a steel plate, its cohesion is greatly increased. This operation undoubtedly deranges the natural situation of the particles. They are squeezed closer together in one direction; but it is not in the direction in which they resist the fracture. In this direction they are rather separated to a greater distance. The general density, however, is augmented in all of them except lead, which grows rather rarer by wire-drawing; but its cohesion may be more than tripled by this operation. Gold, silver, and brass, have their cohesion nearly tripled; copper and iron have it more than doubled. In this operation they also grow much harder. It is proper to heat them to redness after drawing a little. This is called *making* or *annealing*. It softens the metal again, and renders it susceptible of another drawing without the risk of cracking in the operation.

We do not pretend to give any explanation of this remarkable and very important fact, which has something resembling it in woods and other fibrous bodies, as will be mentioned afterwards.

The varieties in the cohesion of stones and other minerals, and of vegetable and animal substances, are hardly susceptible of any description or classification.

We shall take for the measure of cohesion the number of pounds avoirdupois which are just sufficient to tear asunder a rod or bundle of one inch square. From this it will be easy to compute the strength corresponding to any other dimension.

1/2, METALS.

| | | Hrs. |
|-------------------|--------------------------------------|------------|
| Gold, cast | - - - - - | 20,000 |
| | - - - - - | 24,000 |
| Silver, cast | - - - - - | 40,000 |
| | - - - - - | 43,000 |
| | - - - - - | 43,000 |
| Copper, cast | { Japan - - - - - | 19,500 |
| | { Barbary - - - - - | 22,000 |
| | { Hungary - - - - - | 31,000 |
| | { Anglica - - - - - | 34,000 |
| | { Sweden - - - - - | 37,000 |
| Iron, cast | - - - - - | 42,000 |
| | - - - - - | 59,000 |
| Iron, bar | { Ordinary - - - - - | 68,000 |
| | { Silesian - - - - - | 75,000 |
| | { Best Swedish and Russian - - - - - | 84,000 |
| | { Horse-nails - - - - - | 71,000 (A) |
| Steel, bar | { S-ite - - - - - | 120,000 |
| | { Razor temper - - - - - | 150,000 |
| | { Malacca - - - - - | 3,100 |
| Tin, cast | { Banca - - - - - | 3,600 |
| | { Block - - - - - | 3,800 |
| | { English block - - - - - | 5,200 |
| Lead, cast | { - - - - - grain | 6,700 |
| | - - - - - | 860 |
| | Regulus of antimony - - - - - | 1,000 |
| | Zinc - - - - - | 2,600 |
| Bismuth - - - - - | 2,900 | |

It

(A) This was an experiment by Muschenbroek, to examine the vulgar notion that iron forged from old horse balls was stronger than all others, and shows its falsity.

Strength of Materials. It is very remarkable that almost all the mixtures of metals are more tenacious than the metals themselves. The change of tenacity depends much on the proportion of the ingredients, and the proportion which produces the most tenacious mixture is different in the different metals. We have selected the following from the experiments of Mufchenbroek. The proportion of ingredients here selected is that which produces the greatest strength.

| | | |
|--|---|--------|
| Two parts of gold with one of silver | - | 23,000 |
| Five parts of gold with one of copper | - | 50,000 |
| Five parts of silver with one of copper | - | 48,000 |
| Four parts of silver with one of tin | - | 41,000 |
| Six parts of copper with one of tin | - | 41,000 |
| Five parts of Japan copper with one of Banca tin | - | 37,000 |
| Six parts of Chili copper with one of Malacca tin | - | 60,000 |
| Eight parts of Swedish copper with one of Malacca tin | - | 64,000 |
| Beds consists of copper and zinc in an unknown proportion; its strength is | - | 51,000 |
| Three parts of black tin with one part of lead | - | 10,000 |
| Eight parts of black tin with one part of zinc | - | 10,000 |
| Four parts of Malacca tin with one part of regalia of antimony | - | 12,000 |
| Eight parts of lead with one of zinc | - | 4,500 |
| Four parts of tin with one of lead and one of zinc | - | 13,000 |

These numbers are of considerable use in the arts. The mixtures of copper and tin are particularly interesting in the Forge of great guns. We see that, by mixing copper with whose greatest strength does not exceed 37,000, with tin which does not exceed 6200, we produce a metal whose tenacity is almost double, at the same time that it is harder and more easily wrought. It is, however, more fusible, which is a great inconvenience. We also see that a very small addition of zinc almost doubles the tenacity of tin, and increases the tenacity of lead five times; and a small addition of lead doubles the tenacity of tin. These are economical mixtures. This is a very valuable information to the plumbers for augmenting the strength of water pipes.

By having recourse to these tables, the engineer can proportion the thickness of his pipes (of whatever metal) to the pressures to which they are exposed.

27. Woods.

We may refer to this part of the table the following general observations.

1. The wood is stronger by surrounding the pith or heart of the tree is, as well as the inferiority is so much more remarkable as the tree is older. In this assertion, however, we speak with some hesitation. Mufchenbroek's detail of experiments is contradictory in the affirmative. Buffon, on the other hand, says that his experience has taught him that the heart of a young tree is the strongest, but he gives no instances. We are certain, from our own observations of our oaks, on very large and old trees, that the heart is much weaker than the exterior part.

2. The wood next the bark, commonly called the **Strength of Materials.** *white or blue*, is also weaker than the rest; and the wood gradually increases in strength as we recede from the centre to the b.l.a.

3. The wood is stronger in the middle of the trunk than at the springing of the branches or at the root; and the wood of the branches is weaker than that of the trunk.

4. The wood of the north side of all trees which grow in our European climates is the weakest; and that of the south-east side is the strongest; and the difference is most remarkable in hedge row trees, and such as grow singly. The heart of a tree is never in its centre, but always nearer to the north side, and the annual coats of wood are thinner on that side. In conformity with this, it is a general opinion of carpenters that timber is stronger where annual plates are thicker. The trachea or air-vessels are weaker than the simple ligneous fibres. These air-vessels are the fine in diameter and number of rows in trees of the same species, and they make the visible separation between the annual plates. Therefore when these are thicker, they contain a greater proportion of the simple ligneous fibres.

5. All woods are more tenacious while green, and lose very considerably by drying after the trees are felled.

The only author who has put it in our power to judge of the propriety of his experiments is Mufchenbroek. He has described his method of trial minutely; and it seems unexceptionable. The woods were all formed into slips fit for his apparatus, and part of the slip was cut away to a parallelogram of $\frac{1}{4}$ th of an inch square, and therefore $\frac{1}{4}$ th of a square inch in section. The absolute strengths of a square inch were as follow:

| | lbs. | | lbs. |
|-------------|--------|-------------|-------|
| Locust tree | 21,100 | Pomegranate | 9,750 |
| J. job | 18,500 | Lemon | 6,250 |
| Beech, oak | 17,500 | Tamarind | 8,750 |
| Orange | 15,500 | Fir | 8,330 |
| Alder | 13,900 | Walnut | 8,130 |
| Elm | 13,200 | Pitch pine | 7,650 |
| Mulberry | 12,500 | Quince | 6,750 |
| Willow | 12,500 | Cypress | 6,000 |
| Ash | 12,000 | Poplar | 5,500 |
| Plum | 11,800 | Cedar | 4,800 |
| Elder | 10,000 | | |

Mr Mufchenbroek has given a very minute detail of the experiments on the oak and the walnut, stating the weights which were required to tear asunder slips taken from the four sides of the tree, and on each side, in a regular progression from the centre to the circumference. The numbers of this table corresponding to these two timber may therefore be considered as the average of more than 50 trials made of each; and he says that all the others were made with the same care. We cannot therefore see any reason for not confiding in the results; yet they are considerably higher than those given by some other writers. Mr Parent says, on the authority of his own experiments, and of those of Mr Parent, that 65 pounds will pull to r.asunder a square line of found oak, and that it will bear 50 with safety. This gives 8640 for the unit of strength of a square inch, which is manifestly inferior to Mufchenbroek's valuation.

We may add to these,

| | | | | |
|-----------------------------|-------------------|---|---|--------|
| Strength of Materials. | Ivory | - | - | 16,270 |
| | Bone | - | - | 5,250 |
| | Horn | - | - | 8,750 |
| 44 and of other substances. | Whalebone | - | - | 7,500 |
| | Tooth of sea-calf | - | - | 4,075 |

45
No substance to be strained in white-tire above one half its strength.

The reader will surely observe, that these numbers express something more than the utmost cohesion; for the weights are such as will very quickly, that is, in a minute or two, tear the rods asunder. It may be said in general, that two thirds of these weights will sensibly impair the strength after a considerable while, and that one-half is the utmost that can remain suspended at them without risk for ever; and it is this last allotment that the engineer should reckon upon in his constructions. There is, however, considerable difference in this respect. Woods of a very straight fibre, such as fir, will be less impaired by any load which is not sufficient to break them immediately.

According to Mr Emerfon, the load which may be safely suspended to an inch square is as follows:

| | | | | |
|------------------------------------|---|---|---|--------|
| Iron | - | - | - | 76,400 |
| Brass | - | - | - | 35,600 |
| Hemp rope | - | - | - | 19,600 |
| Ivory | - | - | - | 15,700 |
| Oak, box, yew, plum-tree | - | - | - | 7,850 |
| Elm, ash, beech | - | - | - | 6,070 |
| Walnut, plum | - | - | - | 5,360 |
| Red fir, holly, elder, plane, crab | - | - | - | 5,000 |
| Cherry, hazel | - | - | - | 4,760 |
| Alder, asp, birch, willow | - | - | - | 4,290 |
| Lead | - | - | - | 430 |
| Freestone | - | - | - | 914 |

He gives us a practical rule, that a cylinder whose diameter is d inches, loaded to one-fourth of its absolute strength, will carry as follows:

| | | | | |
|-----------|---|---|-----|--------|
| Iron | - | - | 135 | } Cwt. |
| Good rope | - | - | 22 | |
| Oak | - | - | 14 | |
| Fir | - | - | 9 | |

The rank which the different woods hold in this list of Mr Emerfon's is very different from what we find in Mufchenbroek's. But precise measures must not be expected in this matter. It is wonderful that in a matter of such unquestionable importance the public has not enabled some persons of judgement to make proper trials. They are beyond the abilities of private persons.

II. BODIES MAY BE CRUSHED.

46
It is of importance to know what will crush bodies.

It is of equal, perhaps greater, importance to know the strain which may be laid on solid bodies without danger of crushing them. Pillars and posts of all kinds are exposed to this strain in its simplest form; and there are cases where the strain is enormous, viz. where it arises from the oblique position of the parts; as in the struts, braces, and trusses, which occur very frequently in our great works.

It is therefore most desirable to have some general knowledge of the principle which determines the strength of bodies in opposition to this kind of strain. But unfortunately we are much more at a loss in this than in the last case. The mechanism of nature is much more

complicated in the present case. It must be in some circuitous way that compression can have any tendency to tear asunder the parts of a solid body, and it is very difficult to trace the steps.

If we suppose the particles insuperably hard and in contact, and disposed in lines which are in the direction of the external pressures, it does not appear how any pressure can disunite the particles; but this is a gratuitous supposition. There are infinite odds against this precise arrangement of the lines of particles; and the compressibility of all kinds of matter in some degree shows that the particles are in a situation equivalent to dilance. This being the case, and the particles, with their intervals, or what is equivalent to intervals, being in situations that are oblique with respect to the pressures, it must follow, that by squeezing them together in one direction, they are made to bulge out or separate in other directions. This may proceed so far that some may be thus pushed laterally beyond their limits of cohesion. The moment that this happens the resistance to compression is diminished, and the body will now be crushed together. We may form some notion of this by supposing a number of spherules, like small shot, sticking together by means of a cement. Compressing this in some particular direction causes the spherules to act among each other like so many wedges, each tending to penetrate through between the three which lie below it: and this is the simplest, and perhaps the only distinct, notion we can have of the matter. We have reason to think that the constitution of very homogeneous bodies, such as glass, is not very different from this. The particles are certainly arranged symmetrically in the angles of some regular solids. It is only such an arrangement that is consistent with transparency, and with the free passage of light in every direction.

If this be the constitution of bodies, it appears probable that the strength, or the resistance which they are capable of making to an attempt to crush them to pieces, is proportional to the area of the section whose plane is perpendicular to the external force; for each particle being similarly and equally acted on and resisted, the whole resistance must be as their number; that is, as the extent of the section.

Accordingly this principle is assumed by the few writers who have considered this subject; but we confess that it appears to us very doubtful. Suppose a number of brittle or friable balls lying on a table uniformly arranged, but not cohering nor in contact, and that a board is laid over them and loaded with a weight; we have no hesitation in saying, that the weight necessary to crush the whole collection is proportional to their number or to the area of the section. But when they are in contact (and still more if they cohere), we imagine that the case is materially altered. Any individual ball is crushed only in consequence of its being bulged outwards in the direction perpendicular to the pressure employed. If this could be prevented by a hoop put round the ball like an equator, we cannot see how any force can crush it. Any thing therefore which makes this bulging outwards more difficult, makes a greater force necessary. Now this effect will be produced by the mere contact of the balls before the pressure is applied; for the central ball cannot swell outward laterally without pushing away the balls on all sides of it. This is prevented by the friction on the table and upper board

Strength of board, which is at least equal to one third of the pressure. Thus any interior ball becomes stronger by the mere vicinity of the others; and if we farther suppose them to cohere laterally, we think that its strength will be still more increased.

The analogy between these balls and the cohering particles of a triable body is very perfect. We should therefore expect that the strength by which it resists being crushed will increase in a greater ratio than that of the section, or the square of the diameter of similar sections; and that a square inch of any matter will bear a greater weight in proportion as it makes a part of a greater section. Accordingly this appears in many experiments, as will be noticed afterwards. Muschenbroek, Euler, and some others, have supposed the strength of columns to be as the biquadrates of their diameters. But Euler deduced this from formula which occurred to him in the course of his algebraic analysis; and he boldly adopts it as a principle, without looking for its foundation in the physical assumptions which he had made in the beginning of his investigation. But some of his original assumptions were as paradoxical, or at least as gratuitous, as these results; and those, in particular, from which this proportion of the strength of columns was deduced, were almost foreign to the case; and therefore the inference was of no value. Yet it was received as a principle by Muschenbroek and by the academicians of St. Petersburg. We make these very few observations, because the subject is of great practical importance; and it is a great obstacle to improvements when deference to a great name, joined to incapacity or indolence, causes authors to adopt his careless reveries as principles from which they are afterwards to draw important consequences. It must be acknowledged that we have not as yet established the relation between the dimensions and the strength of a pillar on solid mechanical principles. Experience plainly contradicts the general opinion, that the strength is proportional to the area of the section; but it is still more inconsistent with the opinion, that it is in the quadruplicate ratio of the diameters of similar sections. It would seem that the ratio depends much on the internal structure of the body; and experiment seems the only method for ascertaining its general laws.

45
to be as-
certained
only by ex-
periment.

If we suppose the body to be of a fibrous texture, having the fibres situated in the direction of the pressure, and slightly adhering to each other by some kind of cement, such a body will fail only by the bending of the fibres, by which they will break the cement and be detached from each other. Something like this may be supposed in wooden pillars. In such cases, too it would appear that the resistance must be as the number of equally resisting fibres, and as their mutual support, jointly; and, therefore, as some function of the area of the section. The same thing must happen if the fibres are naturally crooked or undulated, as is observed in many woods, &c. provided we suppose some similarity in their form. Similarity of some kind must always be supposed, otherwise we need never aim at any general inferences.

In all cases therefore we can hardly refuse admitting that the strength in opposition to compression is proportional to a function of the area of the section.

As the whole length of a cylinder or prism is equally pressed, it does not appear that the strength of a pillar is at all affected by its length. If indeed it be supposed

to bend under the pressure, the case is greatly changed, because it is then exposed to a transverse strain; and this increases with the length of the pillar. But this will be considered with due attention under the next class of strains.

Strength of
Materials

Few experiments have been made on this species of strength and strain. Mr. Petit says, that his experiment; and those of Mr. Parent, show that the force necessary for crushing a body is nearly equal to that which will tear it asunder. He says that it requires something more than 60 pounds on every square line to crush a piece of found oak. But the rule is by no means general: Glass, for instance, will carry a hundred times as much as oak in this way, that is, resting on it; but will *sustain* above four or five times as much. Oak will sustain a great deal more than fir; but fir will carry twice as much as a pillar. Woods of a soft texture, although consisting of very tenacious fibres, are more easily crushed by their load. This softness of texture is chiefly owing to their fibres not being straight but undulated, and there being considerable vacancies between them, so that they are easily bent laterally and crushed. When a post is overstrained by its load, it is observed to swell sensibly in diameter. Increasing the load causes longitudinal cracks or shivers to appear, and it presently after gives way. This is called *cripping*.

In all cases where the fibres lie oblique to the strain the strength is greatly diminished, because the parts can then be made to slide on each other, when the cohesion of the cementing matter is overcome.

Muschenbroek has given some experiments on this subject; but they are cases of long pillars, and therefore do not belong to this piece. They will be considered afterwards.

The only experiments of which we have seen any detail (and it is useless to insert mere assertions) are those of Mr. Gauthey, in the 4th volume of Rozier's *Journal de Physique*. This engineer exposed to great pressures small rectangular parallelepipeds, cut from a great variety of stones, and noted the weights which crushed them. The following table exhibits the nucleus results of many trials on two very uniform kinds of freestone, one of them among the hardest and the other among the softest used in building.

Column 1st expresses the length AB of the section in French lines or 12ths of an inch; column 2d expresses the breadth BC; column 3d is the area of the section in square lines; column 4th is the number of ounces required to crush the piece; column 5th is the weight which was then borne by each square line of the section; and column 6th is the round numbers to which Mr. Gauthey imagines that those in column 5th approximate.

Experi-
ments for
this pur-
pose made
in free-
stone

| | | Hard Stone. | | Force | | | |
|---|----|-------------|---------|--------|-------|-----|----|
| | AB | BC | AB x BC | Weight | Force | | |
| 1 | 8 | 8 | 64 | 736 | 11.5 | 12 | |
| 2 | 8 | 12 | 96 | 2625 | 27.3 | 25 | |
| 3 | 8 | 16 | 128 | 4496 | 35.1 | 36 | |
| | | Soft Stone. | | Force | | | |
| 4 | 9 | 16 | 144 | 262 | 3.9 | 4 | |
| 5 | 9 | 18 | 162 | 848 | 5.3 | 4.5 | |
| 6 | 15 | 18 | 324 | 2928 | 9 | 9 | |
| 7 | 15 | 24 | 432 | 5296 | 12.2 | 12 | 12 |

Lib.

Strength of
Materials

Little can be deduced from these experiments: The 1st and 3d, computed with the 5th and 6th, should furnish similar results; for the 1st and 3th are respectively half of the 2d and 6th; but the 2d is three times stronger (that is, a line of the 3d) than the first, whereas the 6th is only twice as strong as the 5th.

It is evident, however, that the strength increases much faster than the area of the section, and that a square line can carry more and more weight, according as it makes a part of a larger and larger section. In the series of experiments on the soft stone, the individual strength of a square line seems to increase nearly in the proportion of the section of which it makes a part.

Mr Gauthier deduces, from the whole of his numerous experiments, that a pillar of hard stone of Givry, whose section is a square foot, will bear with perfect safety 664,000 pounds, and that its extreme strength is 871,000, and the smallest strength observed in any of his experiments was 460,000. The soft bed of Givry stone had for its smallest strength 187,000, for its greatest 311,000, and for its safe load 249,000. Good brick will carry with safety 320,000; chalk will carry only 9200. The bold-est piece of architecture in this respect which he has seen is a pillar in the church of All-Saints at Angers. It is 24 feet long and 11 inches square, and is loaded with 60,000, which is not one-seventh of what is necessary for crushing it.

We may observe here by the way, that Mr Gauthier's measure of the suspending strength of stone is vastly small in proportion to its power of supporting a load laid above it. He finds that a prism of the hard bed of Givry, of a foot section, is torn asunder by 4600 pounds; and if it be firmly fixed horizontally in a wall, it will be broken by a weight of 36,000 suspended a foot from the wall. If it rest on two props at a foot distance, it will be broken by 206,000 laid on its middle. These experiments agree so ill with each other, that little use can be made of them. The subject is of great importance, and well deserves the attention of the patriotic philosopher.

A set of good experiments would be very valuable, because it is against this kind of strain that we must guard by judicious construction in the most delicate and difficult problems which come through the hands of the civil and military engineer. The construction of stone arches, and the construction of great wooden bridges, and particularly the construction of the frames of carpentry called *centres* in the erection of stone bridges, are the most difficult jobs that occur. In the centres on which the arches of the bridge of Orleans were built some of the pieces of oak were carrying upwards of two tons on every square inch of their scantling. All who saw it said that it was not able to carry the fourth part of the intended load. But the engineer understood the principles of his art, and ran the risk; and the result completely justified his confidence; for the centre did not complain in any part, only it was found too supple; so that it went out of shape while the haunches only of the arch were laid on it. The engineer corrected this by loading it at the crown, and thus kept it completely in shape during the progress of the work.

In the Memoirs (old) of the Academy of Petersburg for 1778, there is a dissertation by Euler on this subject, but particularly limited to the strain on columns, in which the bending is taken into the account. Mr Fufs has treated the same subject with relation to carpentry

in a subsequent volume. But there is little in these papers besides a dry mathematical disquisition, proceeding on assumptions which (to speak favourably) are extremely gratuitous. The most important consequence of the compression is wholly overlooked, as we shall presently see. Our knowledge of the mechanism of cohesion is as yet far too imperfect to entitle us to a confident application of mathematics. Experiments should be multiplied.

The only way we can hope to make these experiments useful is to pay a careful attention to the manner in which the fracture is produced. By discovering the general resemblances in this particular, we advance a step in our power of introducing mathematical measurement. Thus, when a cubical piece of chalk is slowly crushed between the chaps of a vice, we see it uniformly split in a surface oblique to the pressure, and the two parts then slide along the surface of fracture. This should lead us to examine mathematically what relation there is between this surface of fracture and the necessary force; then we should endeavour to determine experimentally the position of this surface. Having discovered some general law or resemblance in this circumstance, we should try what mathematical hypothesis will agree with this. Having found one, we may then apply our simple notions of cohesion, and compare the result of our computations with experiment. We are authorized to say, that a series of experiments have been made in this way, and that their results have been very uniform, and therefore satisfactory, and that they will soon be laid before the public as the foundations of successful practice in the construction of arches.

III. A BODY MAY BE BROKEN ACROSS.

The most usual, and the greatest strain, to which materials are exposed, is that which tends to break them transversely. It is seldom, however, that this is done in a manner perfectly simple; for when a beam projects horizontally from a wall, and a weight is suspended from its extremity, the beam is commonly broken near the wall, and the intermediate part has performed the functions of a lever. It sometimes, though rarely, happens that the pin in the joint of a pair of pincers or scissars is cut through by the strain; and this is almost the only case of a simple transverse fracture. Being so rare, we may content ourselves with saying, that in this case the strength of the piece is proportional to the area of the section.

Experiments were made for discovering the resistances made by bodies to this kind of strain in the following manner: Two iron bars were disposed horizontally at an inch distance; a third hung perpendicularly between them, being supported by a pin made of the substance to be examined. This pin was made of a prismatic form, so as to fit exactly the holes in the three bars, which were made very exact, and of the same size and shape. A scale was suspended at the lower end of the perpendicular bar, and loaded till it tore out that part of the pin which filled the middle hole. This weight was evidently the measure of the lateral cohesion of two sections. The side-bars were made to grasp the middle bar pretty strongly between them, that there might be no distance imposed between the opposite pressures. This would have combined the energy of a lever with the purely transverse pressure. For the same reason it was necessary

Strength of Materials. ⁵⁵ Their re-
 sult. ⁵⁶ The strength of a lever. Fig. 5.

that the internal parts of the holes should be no smaller than the edges. Great irregularities occurred in our first experiments from this cause, because the pins were somewhat tighter within than at the edges; but when this was corrected they were extremely regular. We employed three sets of holes, viz. a circle, a square (which was occasionally made a rectangle whose length was twice its breadth), and an equilateral triangle. We found in all our experiments the strength exactly proportional to the area of the section, and quite independent of its figure or position, and we found it considerably above the direct cohesion; that is, it took considerably more than twice the force to tear out this middle piece than to tear the pin asunder by a direct pull. A piece of fine freestone required 253 pounds to pull it directly asunder, and 575 to break it in this way. The difference was very contingent in any one substance, but varied from four-thirds to six-thirds in different kinds of matter, being smallest in bodies of a fibrous texture. But indeed we could not make the trial on any bodies of considerable cohesion, because they required such forces as our apparatus could not support. Chalk, clay baked in the sun, baked sugar, brick, and freestone, were the strongest that we could examine.

But the more common case, where the energy of a lever intervenes, demands a minute examination.

Let DABC (fig. 5.) be a vertical section of a prismatic solid (that is, of equal size throughout), projecting horizontally from a wall in which it is firmly fixed; and let a weight P be hung on it at B, or let any power P act at B in a direction perpendicular to AB. Suppose the body of inflexible strength in every part except in the vertical section DA, perpendicular to its length. It must break in this section only. Let the cohesion be uniform over the whole of this section; that is, let each of the adjoining particles of the two parts cohere with an equal force f .

There are two ways in which it may break. The part ABCD may simply slide down along the surface of fracture, provided that the power acting at B is equal to the accumulated force which is exerted by every particle of the section in the direction AD.

But suppose this effectually prevented by something that supports the point A. The action at P tends to make the body turn round A (or round a horizontal line passing through A at right angles to AB) as round a joint. This it cannot do without separating at the line DA. In this case the adjoining particles at D or at E will be separated horizontally. But their cohesion resists this separation. In order, therefore, that the fracture may happen, the energy or momentum of the power P, acting by means of the lever AB, must be superior to the accumulated energies of the particles. The energy of each depends not only on its cohesive force, but also on its situation; for the supposed inflexible firmness of the rest of the body makes it a lever turning round the fulcrum A, and the cohesion of each particle, such as D or E, acts by means of the arm DA or EA. The energy of each particle will therefore be had by multiplying the force exerted by it in the instant of fracture by the arm of the lever by which it acts.

Let us therefore first suppose, that in the instant of fracture every particle is exerting an equal force f . The energy of D will be $f \times DA$, and that of E will be $f \times EA$, and that of the whole will be the sum of all these

products. Let the depth DA of the section be called d , or $\frac{1}{2}$ of it, and let any undetermined part of it EA be called x , and then the space occupied by any particle will be $\frac{1}{2} dx$. The cohesion of this space may be represented by $f \times \frac{1}{2} dx$, and that of the whole by $f \times d$. The energy by which each element x of the line DA, or d , resists the fracture, will be $f \times x$, and the whole accumulated energy

will be $f \times \int x dx$. This we know to be $f \times \frac{1}{2} d^2$, or

$f d \times \frac{1}{2} d$. It is the same therefore as if the cohesion $f d$ of the whole section had been acting at the point G, which is the middle of DA.

The reader who is not familiarly acquainted with this fluxionary calculus may arrive at the same conclusion in another way. Suppose the beam, instead of projecting horizontally from a wall, to be hanging from the ceiling, in which it is firmly fixed. Let us consider how the equal cohesion of every part operates in hindering the lower part from separating from the upper by opening round the joint A. The equal cohesion operates just as equal gravity would do, but in the opposite direction. Now we know, by the most elementary mechanics, that the effect of this will be the same as if the whole weight were concentrated in the centre of gravity G of the line DA, and that this point G is in the middle of DA. Now the number of fibres being as the length d of the line, and the cohesion of each fibre being $= f$, the cohesion of the whole line is $f \times d$ or $f d$.

The accumulated energy therefore of the cohesion in the instant of fracture is $f d \times \frac{1}{2} d$. Now this must be equal or just inferior to the energy of the power employed to break it. Let the length AB be called l ; then $P \times l$ is the corresponding energy of the power. This gives us $f d \times \frac{1}{2} d = P l$ for the equation of equilibrium corresponding to the vertical section ADCE.

Suppose now that the fracture is not permitted at DA, but at another section δa more remote from B. The body being prismatic, all the vertical sections are equal; and therefore $f d \times \frac{1}{2} d$ is the same as before. But the energy of the power is by this means increased, being now $= P \times B a$, instead of $P \times B A$: Hence we see that when the prismatic body is not inflexibly strong in all its parts, but equally strong throughout, it must break close at the wall, where the strain or energy of the power is greatest. We see, too, that a power which is just able to break it at the wall is unable to break it anywhere else; also an absolute cohesion $f d$, which can withstand the power P in the section DA, will not withstand it in the section δa , and will withstand more in the section $d' a'$.

This teaches us to distinguish between absolute and relative strength. The relative strength of a section has a reference to the strain actually exerted on that section. This relative strength is properly measured by the power which is just able to balance or overcome it, when applied at its proper place. Now since we had $f d \times \frac{1}{2} d = P l$, we have $P = \frac{f d \times \frac{1}{2} d}{l}$ for the measure of the strength of the section of the section DA, in relation to the power applied at B.

If the solid is a rectangular beam, whose breadth is b , it is plain that all the vertical sections are equal, and that AG or $\frac{1}{2} d$ is the same in all. Therefore the equa-

Strength of cohesion will be $\rho = f d b \times \frac{1}{2} d$.

The product db evidently expresses the area of the section of fracture, which we may call s , and we may express the equilibrium thus, $\rho = f s \frac{1}{2} d$, and $2 l : d :: f s : \rho$.

Now $f s$ is a proper expression of the absolute cohesion of the section of fracture, and ρ is a proper measure of its strength in relation to a power applied at B. We may therefore say, that twice the length of a rectangular beam is to the d , depth as the absolute cohesion to the relative strength.

Since the action of equal cohesion is similar to the action of equal gravity, it follows, that whatever is the figure of the section, the relative strength will be the same as if the absolute cohesion of all the fibres were acting at the centre of gravity of the section. Let g be the distance between the centre of gravity of the section and the axis of fracture, we shall have $\rho l = f s g$, and $l : g :: f s : \rho$. It will be very useful to recollect this analogy in words: "The length of a prismatic beam of any shape is to the height of the centre of gravity above the lower side, as the absolute cohesion to the strength relative to this length."

Because the relative strength of a rectangular beam is $\frac{f b d^2}{l}$ or $\frac{f b d^2}{2 l}$, it follows, that the relative strengths of different beams are proportional to the absolute cohesion of the particles, to the breadth, and to the square of the depth directly, and to the length inversely; also in prisms whose sections are similar, the strengths are as the cubes of the diameters.

67
Ascertained
by the
equal
cohesion:

Such are the more general results of the mechanism of this transverse strain, in the hypothesis that all the particles are exerting equal forces in the instant of fracture. We are indebted for this doctrine to the celebrated Galileo; and it was one of the first specimens of the application of mathematics to the science of nature.

We have not included in the preceding investigation that action of the external force by which the solid is drawn likewise, or tends to slide along the surface of fracture. We have supposed a particle E to be pulled only in the direction E e, perpendicular to the section of fracture, by the action of the crooked lever B A E. But it is also pulled in the direction E A; and its reaction is in some direction e E, compounded of e f, by which it resists being pulled outwards; and e e by which it resists being pulled downwards. We are but imperfectly acquainted with the force e e, and only know that their accumulated sum is equal to the force ρ ; but in all important cases which occur in practice, it is unnecessary to attend to this force; because it is so small in comparison of the forces in the direction E e, as we easily conclude from the usual smallness of AD in comparison of AB.

68
but that
hypothesis
not con-
formable
to nature.

The hypothesis of equal cohesion, exerted by all the particles in the instant of fracture, is not conformable to nature: for we know, that when a force is applied transversely at B, the beam is bent downwards, becoming convex on the upper side; that side is therefore on the stretch. The particles at D are farther removed from each other than those at E, and are therefore actually exerting greater cohesive forces. We cannot say with certainty and precision in what proportion each fibre is extended. It seems most probable that the extensions

are proportional to the distances from A. We shall suppose this to be really the case. Now recollect the general law which we formerly said was observed in all moderate extensions, viz. that the attractive forces exerted by the dilated particles were proportional to their dilations. Suppose now that the beam is so much bent that the particles at D are exerting their utmost force, and that this fibre is just ready to break or actually breaks. It is plain that a total fracture must immediately ensue; because the force which was superior to the full cohesion of the particle at D, and a certain portion of the cohesion of all the rest, will be more than superior to the full cohesion of the particle next within D, and a smaller portion of the cohesion of the remainder.

Now let F represent, as before, the full force of the exterior fibre D, which is exerted by it in the instant of its breaking, and then the force exerted at the same instant by the fibre E will be had by this analogy, AD : AE, or $d : x :: f : \frac{f x}{d}$, and the force really exerted by the fibre E is $f \times \frac{x}{d}$.

The force exerted by a fibre whose thickness is x is therefore $\frac{f x^2}{d}$; but this force resists the strain by acting by means of the lever EA or x . Its energy or momentum is therefore $\frac{f x^3}{d}$, and the accumulated momenta of all the fibres in the line AE will be $f \times$ sum of $\frac{x^3}{d}$. This, when x is taken equal to d , will express the momentum of the whole fibres in the line AD. This, therefore, is $f \frac{d^3}{d}$, or $f \frac{1}{2} d^3$, or $f d \times \frac{1}{2} d$. Now $f d$ expresses the absolute cohesion of the whole line AD. The accumulated momentum is therefore the same as if the absolute cohesion of the whole line were exerted at one-third of AD from A.

From these premises it follows that the equation expressing the equilibrium of the strain and cohesion is $\rho l = f d \times \frac{1}{2} d$; and hence we deduce the analogy, "As the distance of the length is to the depth, so is the absolute cohesion to the relative strength."

This equation and this proportion will equally apply to rectangular beams whose breadth is b ; for we shall then have $\rho l = f b d \times \frac{1}{2} d$.

We also see that the relative strength is proportional to the absolute cohesion of the particles, to the breadth, and to the square of the depth directly, and to the length inversely: for ρ is the measure of the force with which it is resisted, and $\rho = \frac{f b d^2}{l} = \frac{f b d^2}{2 l}$. In this respect therefore this hypothesis agrees with the Galilean; but it assigns to every beam a smaller proportion of the absolute cohesion of the section of fracture, in the proportion of three to two. In the Galilean hypothesis this section has a momentum equal to one-half of its absolute strength, but in the other hypothesis it is only one-third. In beams of a different form the proportion may be different.

As this is a most important proposition, and the foundation

59
The strength
of the section
is to the depth
as the absolute
cohesion to the
relative strength.

Strength of Cohesion of many practical maxims, we are anxious to have it clearly comprehended, and its evidence perceived by all. Our better informed readers will therefore indulge us while we endeavour to present it in another point of view, where it will be better seen by those who are not familiarly acquainted with the fluxionary calculus.

60
The same proposition presented in another point of view.
Fig. 6.

Fig. 6. A is a perspective view of a three-sided beam projecting horizontally from a wall, and loaded with a weight at B just sufficient to break it. DABC is a vertical plane through its highest point D, in the direction of its length. aDa is another vertical section perpendicular to AB. The piece being supposed of insuperable strength everywhere except in the section aDa , and the cohesion being also supposed insuperable along the line aAa , it can break nowhere but in this section, and by turning round aAa as round a hinge. Make Dd equal to AD, and let Dd represent the absolute cohesion of the fibre at D, which absolute cohesion we expressed by the symbol f . Let a plane ada be made to pass through aa and d , and let $d'd'a'$ be another cross section. It is plain that the prismatic solid contained between the two sections aDa and $d'd'a'$ will represent the full cohesion of the whole section of fracture; for we may conceive this prism as made up of lines such as Ff , equal and parallel to Dd , representing the absolute cohesion of each particle such as F . The pyramidal solid $dDaad$, cut off by the plane ada , will represent the cohesions actually exerted by the different fibres in the instant of fracture. For take any point E in the surface of fracture, and draw Ee parallel to AB, meeting the plane ada in e , and let eAE be a vertical plane. It is evident that Dd is to Ee as AD to AE; and therefore (since the forces exerted by the different fibres are as their extension, and their extension as their distances from the axis of fracture) Ee will represent the force actually exerted by the fibre in E, while D is exerting its full force Dd . In like manner, the plane Fff expresses the cohesion exerted by all the fibres in the line FF, and so on through the whole surface. Therefore the pyramid $dDaad$ expresses the accumulated exertion of the whole surface of fracture.

Farther, suppose the beam to be held perpendicular to the horizon with the end B uppermost, and that the weight of the prism contained between the two sections aDa and $d'd'a'$ (now horizontal) is just able to overcome the full cohesion of the section of fracture. The weight of the pyramid $dDaad$ will also be just able to overcome the cohesions actually exerted by the different fibres in the instant of fracture, because the weight of each fibre, such as Ee , is just superior to the cohesion actually exerted at E.

Let o be the centre of gravity of the pyramidal solid, and draw oO perpendicular to the plane ada . The whole weight of the solid $dDaad$ may be conceived as accumulated in the point o , and as acting on the point O, and it will have the same tendency to separate the two cohering surfaces as when each fibre is hanging by its respective point. For this reason the point O may be called the centre of actual effort of the unequal forces of cohesion. The momentum therefore, or energy by which the cohering surfaces are separated, will be properly measured by the weight of the solid $dDaad$ multiplied by OA; and this product is equal to the product of the weight p multiplied by BA, or by l .

Thus suppose that the cohesion along the line AD only is considered. The whole cohesion will be represented by a triangle ADd . Dd represents f , and AD is d , and AD is o . Therefore ADd is $\frac{1}{2}fd$. The centre of gravity o of the triangle ADd is in the intersection of a line drawn from A to the middle of Dd with a line drawn from d to the middle of AD; and therefore the line oO will make $AO = \frac{2}{3}$ of AD. Therefore the actual momentum of cohesion is $f \times \frac{2}{3}d \times \frac{1}{2}d = \frac{1}{3}fd^2$, or equal to the absolute cohesion acting by means of the lever $\frac{d}{3}$.

If the section of fracture is a rectangle, as in a common joint, whose breadth aa is $= b$, it is plain that all the vertical lines will be represented by triangles like ADd ; and the whole actual cohesion will be represented by a wedge whose bases are vertical planes, and which is equal to half of the parallelepiped $AD \times Dd \times aa$, and will therefore be $= \frac{1}{2}fbd$; and the distance AO of its centre of gravity from the horizontal line AA' will be $\frac{2}{3}$ of AD. The momentum of cohesion of a joint will therefore be $\frac{1}{3}fbd \times \frac{2}{3}d$, or $fb d \frac{2}{9}d$, as we have determined in the other way.

The beam represented in the figure is a triangular prism. The pyramid $dDaad$ is $\frac{1}{3}$ of the prism $aad'd'a'$. If we make s represent the surface of the triangle aDa , the pyramid is $\frac{1}{3}$ of fs . The distance AO of its centre of gravity from the horizontal line AA' will be $\frac{2}{3}$ of AD, or $\frac{2}{3}d$. Therefore the momentum of actual cohesion is $\frac{1}{3}fs \times \frac{2}{3}d = fs \frac{2}{9}d$; that is, it is the same as if the full cohesion of all the fibres were accumulated at a point I whose distance from A is $\frac{2}{9}$ th of AD or d ; or (that we may see its value in every point or view) it is $\frac{2}{9}$ th of the momentum of the full cohesion of all the fibres when accumulated at the point D, or acting at the distance $d = AD$.

This is a very convenient way of conceiving the momentum of actual cohesion, by comparing it with the momentum of absolute cohesion applied at the distance AD from the axis of fracture. The momentum of the absolute cohesion applied at D is to the momentum of actual cohesion in the instant of fracture as AD to AI. Therefore the length of AI, or its proportion to AD, is a sort of index of the strength of the beam. We shall call it the INDEX, and express it by the symbol i .

Its value is easily obtained. The product of the absolute cohesion by AI must be equal to that of the actual cohesion by AO. Therefore say, "as the prismatic solid $aad'd'a'$ is to the pyramidal solid $aad'd'a'$, so is AO to AI." We are assisted in this determination by a very convenient circumstance. In this hypothesis of the actual cohesions being as the distances of the fibres from A, the point O is the centre of oscillation or percussion of the surface $dDaad$ turning round the axis aa : for the momentum of cohesion of the line FF is $FF \times Ff \times EA = FF \times EA^2$, because Ff is equal to EA. Now AO, by the nature of the centre of gravity, is equal to the sum of all these momenta divided by the pyramid $aad'd'a'$; that is, by the sum of all the $FF \times Ff$; that is, by the sum of all the $FF \times EA$.

Therefore $AO = \frac{\text{sum of } FF \times EA^2}{\text{sum of } FF \times EA}$, which is just the value of the distance of the centre of percussion of the triangle aad from A: (See ROTATION). Moreover,

Strength of Materials. If G be the centre of gravity of the triangle aDa , we shall have DA to GA as the absolute cohesion to the sum of the cohesions actually exerted in the instant of fracture; for, by the nature of this centre of gravity, AG is equal to $\frac{\text{sum of } FF \times EA}{\text{sum of } FF}$, and the sum of $FF \times$

AG is equal to the sum of $FF \times EA$. But the sum of all the lines FF is the triangle aDa , and the sum of all the $FF \times EA$ is the sum of all the rectangles $FFff$; that is, the pyramid $aDaa$. Therefore a prism whose base is the triangle aDa , and whose height is AG , is equal to the pyramid, or will express the sum of the actual cohesions; and a prism, whose base is the same triangle, and whose height is Dd or Da , expresses the absolute cohesion. Therefore DA is to GA as the absolute cohesion to the sum of the actual cohesions.

Therefore we have $DA : GA :: OA : IA$.

Therefore, whatever be the form of the beam, that is, whatever be the figure of its section, find the centre of oscillation O , and the centre of gravity G of this section. Call their distances from the axis of fracture o and g . Then AI or $i = \frac{o \cdot g}{d}$, and the momentum of cohesion is $f s \times \frac{o \cdot g}{d}$, where s is the area of fracture.

This index is easily determined in all the cases which generally occur in practice. In a rectangular beam AI is $\frac{3}{4}$ of AD ; in a cylinder (circular or elliptic) AI is $\frac{5}{8}$ ths of AD , &c. &c.

In this hypothesis, that the cohesion actually exerted by each fibre is as its extension, and that the extensions of the fibres are as their distances from A (fig. 5), it is plain that the forces exerted by the fibres D, E , &c. will be represented by the ordinates Dd, Ee , &c. to a straight line Aa . And we learn from the principles of ROTATION that the centre of percussion O is in the ordinate which passes through the centre of gravity of the triangle ADd , or (if we consider the whole section having breadth as well as depth) through the centre of gravity of the solid bounded by the planes DA, dA ; and we found that this point O was the centre of effort of the cohesions actually exerted in the instant of fracture, and that I was the centre of an equal momentum, which would be produced if all the fibres were accumulated there and exerted their full cohesion.

This consideration enables us to determine, with equal facility and neatness, the strength of a beam in any hypothesis of forces. The above hypothesis was introduced with a cautious limitation to moderate strains, which produced no permanent change of form, or no set as the artists call it; and this suffices for all purposes of practice, seeing that it would be impudent to expose materials to more violent strains. But when we compare this theory with experiments in which the pieces are really broken, considerable deviations may be expected, because it is very probable that in the vicinity of rupture the forces are no longer proportional to the extensions.

That no doubt may remain as to the justness and completeness of the theory, we must show how the relative strength may be determined in any other hypothesis. Therefore suppose that it has been established by experiment on any kind of solid matter, that the forces actually exerted in the instant of fracture by the fibres

at D, E , &c. are as the ordinates Dd, Ee , &c. of any curve line $Ae'd'$. We are supposed to know the form of this curve, and that of the solid which is bounded by the vertical plane through AD , and by the surface which passes through this curve $Ae'd'$ perpendicularly to the length of the beam. We know the place of the centre of gravity of this curve surface or solid, and can draw a line through it parallel to AB , and cutting the surface of fracture in some point O . This point is also the centre of effort of all the cohesions actually exerted; and the product of AO and of the solid which expresses the actual cohesions will give the momentum of cohesion equivalent to the former $f s \frac{o \cdot g}{d}$. Or we may find an index AI , by making AI a fourth proportional to the full cohesion of the surface of fracture, to the accumulated actual cohesions, and to AO ; and then $f s \times i$ ($=AI$) will be the momentum of cohesion; and we shall still have I for the point in which all the fibres may be supposed to exert their full cohesion f , and to produce a momentum of cohesion equal to the real momentum of the cohesions actually exerted, and the relative strength of the beam will still be $p = \frac{f s i}{l}$ or $\frac{f s g o}{d l}$.

Thus, if the forces be as the squares of the extensions (still supposed to be as the distances from A), the curve $Ae'd'$ will be a common parabola, having AB for its axis and AD for the tangent at its vertex. The area ADd' will be $\frac{1}{2}$ $AD \times Dd$; and in the case of a rectangular beam, AO will be $\frac{1}{3}$ ths AD , and AI will be $\frac{1}{3}$ th of AD .

We may observe here in general, that if the forces actually exerted in the instant of fracture be as any power q of the distance from A , the index AI will be $= \frac{AD}{q+2}$ for a rectangular beam, and the momentum of cohesion will always be (*ceteris paribus*) as the breadth and as the square of the depth; nay, this will be the case whenever the action of the fibres D and E is expressed by any similar functions of d and x . This is evident to every reader acquainted with the fluxionary calculus.

As far as we can judge from experience, no simple algebraic power of the distance will express the actual cohesions of the fibres. No curve which has either AD or AB for its tangent will suit. The observations which we made in the beginning show, that although the curve of fig. 2. must be sensibly straight in the vicinity of the points of intersection with the axis, in order to agree with our observations which show the moderate extensions to be as the extending forces, the curve must be concave towards the axis in all its attractive branches, because it cuts it again. Therefore the curve $Ae'd'$ of fig. 5. must make a finite angle with AD or AB , and it must, in all probability, be also concave towards AD in the neighbourhood of d' . It may however be convex in some part of the intermediate arch. We have made experiments on the extensions of different bodies, and find great diversities in this respect: But in all, the moderate extensions were as the forces, and this with great accuracy till the body took a set, and remained longer than formerly when the extending force was removed.

We must now remark, that this correction of the Galilean hypothesis of equal forces was suggested by the bending

It has the strength may be determined by experiment on any kind of solid matter, such

Strength of bending which is observed in all bodies which are strained transversely. Because they are bent, the fibres on the convex side have been extended. We cannot say in what proportion this obtains in the different fibres. Our most distinct notions of the internal equilibrium between the particles render it highly probable that their extension is proportional to their distance from that fibre which remains its former dimensions. But by whatever law this is regulated, we see plainly that the actions of the stretched fibres must follow the proportions of some function of this distance, and that therefore the relative strength of a beam is in all cases susceptible of mathematical determination.

62
Bernoulli's problem of the elastic curve.

We also see an intimate connection between the strain and the curvature. This suggested to the celebrated James Bernoulli the problem of the ELASTIC CURVE, i. e. the curve into which an extensible rigid body will be bent by a transverse strain. His solution in the *Acta Lipsæ* 1694 and 1695 is a very beautiful specimen of mathematical discussion; and we recommend it to the perusal of the curious reader. He will find it very perceptibly treated in the first volume of his works, published after his death, where the wide steps which he had taken in his investigation are explained so as to be easily comprehended. His nephew Daniel Bernoulli has given an elegant abridgement in the *Peterburg Memoirs* for 1729. The problem is too intricate to be fully discussed in a work like ours; but it is also too intimately connected with our present subject to be entirely omitted. We must content ourselves with showing the leading mechanical properties of this curve, from which the mathematician may deduce all its geometrical properties.

63
Its leading mechanical property described.

When a bar of uniform depth and breadth, and of a given length, is bent into an arch of a circle, the extension of the outer fibres is proportional to the curvature; for, because the curves formed by the inner and outer sides of the beam are similar, the circumferences are as the radii, and the radius of the inner circle is to the difference of the radii as the length of the inner circumference is to the difference of the circumferences. The difference of the radii is the depth of the beam, the difference of the circumferences is the extension of the outer fibres, and the inner circumference is supposed to be the primitive length of the beam. Now the second and third quantities of the above analogy, viz. the depth and length of the beam, are constant quantities, as is also their product. Therefore the product of the inner radius and the extension of the outer fibre is also a constant quantity, and the whole extension of the outer fibre is inversely as the radius of curvature, or is directly as the curvature of the beam.

The mathematical reader will readily see, that into whatever curve the elastic bar is bent, the whole extension of the outer fibre is equal to the length of a similar curve, having the same proportion to the thickness of the beam that the length of the beam has to the radius of curvature.

Fig. 7.
Now let ADCB (fig. 7.) be such a rod, of uniform breadth and thickness, firmly fixed in a vertical position, and bent into a curve AEFB by a weight W suspended at B, and of such magnitude that the extremity B has its tangent perpendicular to the action of the weight, or parallel to the horizon. Suppose too that the extensions are proportional to the extending

Strength of Materials

forces. From any two points E and F draw the horizontal ordinates EG, FH. It is evident that the exterior fibres of the sections Ee and Ff are stretched by forces which are in the proportion of EG to FH (these being the long arms of the levers, and the equal thick- nesses Ee, Ff being the short arms). Therefore (by the hypothesis) their extensions are in the same proportion. But because the extensions are proportional to some similar functions of the distance from the axes of fracture E and F, the extension of any fibre in the section Ee is to the contemporaneous extension of the similarly situated fibre in the section Ff, as the extension of the exterior fibre in the section Ee is to the extension of the exterior fibre in the section Ff; therefore the whole extension of Ee is to the whole extension of Ff as EG to FH, and EG is to FH as the curvature in E to the curvature in F.

Here let it be remarked, that this proportionality of the curvature to the extension of the fibres is not limited to the hypothesis of the proportionality of the extensions to the extending forces. It follows from the extension in the different sections being as some similar function of the distance from the axis of fracture; an assumption which cannot be refuted.

This then is the fundamental property of the elastic curve, from which its equation, or relation between the abscissa and ordinate, may be deduced in the usual forms, and all its other geometrical properties. These are foreign to our purpose; and we shall notice only such properties as have an immediate relation to the strain and strength of the different parts of a flexible body, and which in particular serve to explain some difficulties in the valuable experiments of M. Buffon on the Strength of Beams.

64
It is not a circle.

We observe, in the first place, that the elastic curve cannot be a circle, but is gradually more incurved as it recedes from the point of application B of the straining forces. At B it has no curvature; and if the bar were extended beyond B there would be no curvature there. In like manner, when a beam is supported at the ends and loaded in the middle, the curvature is greatest in the middle; but at the props, or beyond them, if the beam extend farther, there is no curvature. Therefore when a beam projecting 20 feet from a wall is bent to a certain curvature at the wall by a weight suspended at the end, and a beam of the same size projecting 20 feet is bent to the very same curvature at the wall by a greater weight at 10 feet distance, the figure and the mechanical state of the beam in the vicinity of the wall is different in these two cases, though the curvature at the very wall is the same in both. In the first case every part of the beam is incurved; in the second, all beyond the 10 feet is without curvature. In the first experiment the curvature at the distance of five feet from the wall is three-fourths of the curvature at the wall; in the second, the curvature at the same place is but one-half of that at the wall. This must weaken the long beam in this whole interval of five feet, because the greater curvature is the result of a greater extension of the fibres.

65
Every beam has a certain determinate curvature for every beam which cannot be exceeded without breaking it; for there is a certain separation of two adjoining particles that prevents an end to their cohesion. A fibre can therefore

Strength of Materials } be extended only a certain proportion of its length. The ultimate extension of the outer fibres must bear a certain determinate proportion to its length, and this proportion is the same with that of the thickness (or what we have hitherto called the depth) to the radius of ultimate curvature, which is therefore determinate.

66 And when of uniform breadth and depth is most incurvated where the strain is greatest. A beam of uniform breadth and depth is therefore most incurvated where the strain is greatest, and will break in the most incurvated part. But by changing its form, so as to make the strength of its different sections in the ratio of the strain, it is evident that the curvature may be the same throughout, or may be made to vary according to any law. This is a remark worthy of the attention of the watchmaker. The most delicate problem in practical mechanics is so to taper the balance-spring of a watch that its wide and narrow vibrations may be isochronous. Hooke's principle *ut tensio sic vis* is not sufficient when we take the *inertia* and motion of the spring itself into the account. The figure into which it bends and unbends has also an influence. Our readers will take notice that the artist aims at an accuracy which will not admit an error of $\frac{1}{100000}$ strength, and that Hurrison and Arnold have actually attained it in several instances. The taper of a spring is at present a nostrum in the hands of each artist, and he is careful not to impart his secret.

Again, since the depth of the beam is thus proportional to the radius of ultimate curvature, this ultimate or breaking curvature is inversely as the depth. It may be expressed by $\frac{1}{d}$.

67 To what the curvature is proportional. When a weight is hung on the end of a prismatic beam, the curvature is nearly as the weight and the length directly, and as the breadth and the cube of the depth inversely; for the strength is $= \frac{b^3 d^3}{3l}$. Let us

suppose that this produces the ultimate curvature $\frac{1}{d}$. Now let the beam be loaded with a smaller weight w , and let the curvature produced be C , we have this analogy $f \frac{b^3 d^3}{3l} : w = \frac{1}{d} : C$, and $C = \frac{3lw}{fb^3 d^3}$. It is evident that this is also true of a beam supported at the ends and loaded between the props; and we see how to determine the curvature in its different parts, whether arising from the load, or from its own weight, or from both.

68 Deflection. When a beam is thus loaded at the end or middle, the loaded point is pulled down, and the space through which it is drawn may be called the DEFLECTION. This may be considered as the subtense of the angle of contact, or as the versed sine of the arch into which the beam is bent, and is therefore as the curvature when the length of the arches is given (the flexure being moderate), and as the square of the length of the arch when the curvature is given. The deflection therefore is as the curvature and as the square of the length of the arch jointly; that is, as $\frac{3lw}{fb^3 d^3} \times l^2$, or as $\frac{3l^3 w}{fb^3 d^3}$. The deflection from the primitive shape is therefore as the bending weight and the cube of the length directly, and as the breadth and cube of the depth inversely.

In beams just ready to break, the curvature is as the

depth inversely, and the deflection is as the square of the length divided by the depth; for the ultimate curvature at the breaking part is the same whatever is the length; and in this case the deflection is as the square of the length.

We have been the more particular in our consideration of this subject, because the refusing theorems afford us the finest methods of examining the laws of corpufcular action, that is, for discovering the variation of the force of cohesion by a change of distance. It is true it is not the atomical law, or HYLARCHIC PRINCIPLE as it may justly be called, which is thus made accessible, but the specific law of the particles of the substance or kind of matter under examination. But even this is a very great point; and coincidences in this respect among the different kinds of matter are of great moment. We may thus learn the nature of the corpufcular action of different substances, and perhaps approach to a discovery of the *mechanism* of chemical affinities. For that chemical actions are insensible cases of local motion is undeniable, and local motion is the province of mechanical discussion; nay, we see that these hidden changes are produced by mechanical forces in many important cases, for we see them promoted or prevented by means purely mechanical. The conversion of bodies into elastic vapour by heat can at all times be prevented by a sufficient external pressure. A strong solution of Glauber's salt will congeal in an instant by agitation, giving out its latent heat; and it will remain fluid for ever, and return its latent heat in a close vessel which it completely fills. Even water will by such treatment freeze in an instant by agitation, or remain fluid for ever by confinement. We know that heat is produced or extricated by friction, that certain compounds of gold or silver with saline matters explode with irretrievable violence by the smallest pressure or agitation. Such facts should rouse the mathematical philosopher, and excite him to follow out the conjectures of the illustrious Newton, encouraged by the ingenious attempts of Boolevich; and the proper beginning of this study is to attend to the laws of attraction and repulsion exerted by the particles of cohering bodies, discoverable by experiments made on their actual extensions and compressions. The experiments of simple extensions and compressions are quite insufficient, because the total stretching of a wire is so small a quantity, that the mistake of the 1000th part of an inch occasions an irregularity which deranges any progression so as to make it useless. But by the bending of bodies, a distension of $\frac{1}{8}$ of an inch may be easily magnified in the deflection of the spring ten thousand times. We know that the investigation is intricate and difficult, but not beyond the reach of our present mathematical attainments; and it will give very fine opportunities of employing all the address of analysis. In the 17th century and the beginning of the 18th this was a sufficient excitement to the first geniuses of Europe. The cycloid, the catenaria, the elastic curve, the velaria, the caustics, were reckoned an abundant recompense for much study; and James Bernoulli requested, as an honourable monument, that the logarithmic spiral might be inscribed on his tombstone. The reward for the study to which we now presume to incite the mathematicians is the almost unlimited extension of natural science, important in every particular branch. To go no further than our present subject, a great deal of important practical knowledge

Strength of Jedge respecting the strength of bodies is derived from the single observation, that in the moderate extensions which happen before the parts are overstrained the forces are nearly in the proportion of the extensions or separations of the particles. To return to our subject.

Materials. James Bernoulli, in his second dissertation on the elastic curve, calls in question this law, and accommodates his investigation to any hypothesis concerning the relation of the forces and extensions. He relates some experiments of late strings where the relation was considerably different. Strings of three feet long,

| | | | | | | |
|-----------------|----|-----|-----|-----|----|--------|
| Stretched by | 2, | 4, | 6, | 8, | 10 | pd. |
| Were lengthened | 9, | 17, | 23, | 27, | 30 | lines. |

But this is a most exceptionable form of the experiment. The strings were twisted, and the mechanism of the extensions is here exceedingly complicated, combined with compressions and with transverse twists, &c. We made experiments on fine slips of the gum caoutchouc, and on the juice of the berries of the white bryony, of which a single grain will draw a thread of two feet long, and again return into a perfectly round sphere. We measured the diameter of the thread by a microscope with a micrometer, and thus could tell in every state of extension the proportional number of particles in the sections. We found, that though the whole range in which the distance of the particles was changed in the proportion of 13 to 1, the extensions did not *sensibly* deviate from the proportion of the forces. The same thing was observed in the caoutchouc as long as it perfectly recovered its first dimensions. And it is on the authority of these experiments that we presume to announce this as a law of nature.

70 Dr Robert Hooke was undoubtedly the first who attended to this subject, and assumed this as a law of nature. Mariotte indeed was the first who expressly used it for determining the strength of beams: this he did about the 1679, correcting the simple theory of Galileo. Leibnitz indeed, in his dissertation in the *Acta Eruditorum* 1684 de *Resilientia Solidorum*, introduces this consideration, and wishes to be considered as the discoverer; and he is always acknowledged as such by the Bernoullis and others who adhered to his peculiar doctrines. But Mariotte had published the doctrine in the most express terms long before; and Bussinger, in the *Comment. Petropoli* 1729, completely vindicates his claim. But Hooke was unquestionably the discoverer of this law. It made the foundation of his theory of springs, announced to the Royal Society about the year 1661, and read in 1666. On this occasion he mentions many things on the strength of bodies as quite familiar to his thoughts, which are immediate deductions from this principle; and among these *all* the facts which John Bernoulli so vauntingly adduces in support of Leibnitz's physical dogmas about the force of bodies in motion; a doctrine which Hooke might have claimed as his own, had he not perceived its frivolous inanity.

But even with this first correction of Mariotte, the mechanism of transverse strain is not fully nor justly explained. The force acting in the direction BP (fig. 5.), and bending the body ABCD, not only stretches the fibres on the side opposite to the axis of fracture, but compresses the side AB, which becomes concave by the strain. Indeed it cannot do the one without doing the other: For in order to stretch the fibres at D, there

must be some fulcrum, some support, on which the virtual lever BAD may press, that it may tear asunder the stretched fibres. This fulcrum must sustain both the pressure arising from the cohesion of the distended fibres, and also the action of the external force, which immediately tends to cause the prominent part of the beam to slide along the section DA. Let BAD (fig. 5.) be considered as a crooked lever, of which A is the fulcrum. Let an external force be applied at B in the direction BP, and let a force equal to the accumulated cohesion of AD be applied at O in the direction opposite to AB, that is, perpendicular to AO; and let these two forces be supposed to balance each other by the intervention of the lever. In the first place, the force at O must be to the force at B as AB to AO: Therefore, if we make AK equal and opposite to AO, and AL equal and opposite to AB, the common principles of mechanics inform us that the fulcrum A is affected in the same manner as if the two forces AK and AL were immediately applied to it, the force AK being equal to the weight P, and AL equal to the accumulated cohesion actually exerted in the instant of fracture. The fulcrum is therefore really pressed in the direction AM, the diagonal of the parallelogram, and it must resist in the direction and with the force MA; and this power of resistance, this support, must be furnished by the repulsive forces exerted by *those particles only* which are in a state of actual compression. The force AK, which is equal to the external force P, must be resisted in the direction KA by the lateral cohesion of the whole particles between D and A (the particle D is not only drawn forward but downward). This prevents the part CDAB from sliding down along the section DA.

This is fully verified by experiment. If we attempt to break a long slip of cork, or any such very compressible body, we always observe it to bulge out on the concave side before it cracks on the other side. If it is a body of fibrous or foliated texture, it seldom fails splintering off on the concave side; and in many cases this splintering is very deep, even reaching half way through the piece. In hard and granulated bodies, such as a piece of freestone, chalk, dry clay, sugar, and the like, we generally see a considerable splinter or fliver fly off from the hollow side. If the fracture be slowly made by a force at B gradually augmented, the formation of the splinter is very distinctly seen. It forms a triangular piece like *a Ib*, which generally breaks in the middle. We doubt not but that attentive observation would show that the direction of the crack on each side of I is not very different from the direction AM and its correspondent on the other side. This is by no means a circumstance of idle curiosity, but intimately connected with the mechanism of cohesion.

Let us see what consequences result from this state of the case respecting the strength of bodies. Let DAKC (fig. 8.) represent a vertical section of a prism of compressible materials, such as a piece of timber. Suppose it loaded with a weight P hung at its extremity. Suppose it of such a constitution that all the fibres in AD are in a state of dilatation, while those in AA are in a state of compression. In the instant of fracture the particles at D and E are withheld by forces Dd, Ee, and the particles at A and E repel, resist, or support, with forces Aa, Ee.

Some line, such as *dca*, will limit all these ordinates;

71 which was first assumed by Dr Hooke.

72 Though corrected by Mariotte, it does not properly explain the mechanism of transverse strain.

73 fully verified by experiment.

74 can represent a vertical section of a prism of compressible materials, such as a piece of timber. Suppose it loaded with a weight P hung at its extremity. Suppose it of such a constitution that all the fibres in AD are in a state of dilatation, while those in AA are in a state of compression. In the instant of fracture the particles at D and E are withheld by forces Dd, Ee, and the particles at A and E repel, resist, or support, with forces Aa, Ee.

Strength of Materials. nates, which represent the forces actually exerted in the instant of fracture. If the forces be as the extensions and compressions, as we have great reason to believe, $d e \Delta$ and $A e \delta$ will be two straight lines. They will form one straight line $d A \delta$, if the forces which resist a certain dilatation are equal to the forces which resist an equal compression. But this is quite accidental, and is not strictly true in any body. In most bodies which have any considerable firmness, the compressions made by any external force are not so great as the dilatations which the same force would produce; that is, the repulsions which are excited by any supposed degree of compression are greater than the attractions excited by the same degree of dilatation. Hence it will generally follow, that the angle $d A D$ is less than the angle $\delta A \Delta$, and the ordinates $D d, E e, \&c.$ are less than the corresponding ordinates $\Delta \delta, E e, \&c.$

But whatever be the nature of the line $d A \delta$, we are certain of this, that the whole area $A D d$ is equal to the whole area $A \Delta \delta$: for as the force at B is gradually increased, and the parts between A and D are more extended, and greater cohesive forces are excited, there is always such a degree of repulsive forces excited in the particles between A and Δ that the one set precisely balances the other. The force at B , acting perpendicularly to AB , has no tendency to pull the whole piece closer on the part next the wall or to pull it away. The sum of the attractive and repulsive forces actually excited must therefore be equal. These sums are represented by the two triangular areas, which are therefore equal.

The greater we suppose the repulsive forces corresponding to any degree of compression, in comparison with the attractive forces corresponding to the same degree of extension, the smaller will $A \Delta$ be in comparison of AD . In a piece of cork or sponge, $A \Delta$ may chance to be equal to AD , or even to exceed it; but in a piece of marble, $A \Delta$ will perhaps be very small in comparison of AD .

Now it is evident that the repulsive forces excited between A and Δ have no share in preventing the fracture. They rather contribute to it, by furnishing a fulcrum to the lever, by whose energy the cohesion of the particles in AD is overcome. Hence we see an important consequence of the compressibility of the body. Its power of resisting this transverse strain is diminished by it, and so much the more diminished as the stuff is more compressible.

This is fully verified by some very curious experiments made by Du Hamel. He took 16 bars of willow 2 feet long and $\frac{1}{2}$ an inch square, and supporting them by props under the ends, he broke them by weights hung on the middle. He broke 4 of them by weights of 40, 41, 47, and 52 pounds: the mean is 45. He then cut 4 of them $\frac{1}{4}$ through on the upper side, and filled up the cut with a thin piece of harder wood stuck in pretty tight. These were broken by 48, 54, 50, and 52 pounds; the mean of which is 51. He cut other four $\frac{1}{2}$ through, and they were broken by 47, 49, 50, 46; the mean of which is 48. The remaining four were cut $\frac{3}{4}$ through; and their mean strength was 42.

Another set of his experiments is still more remarkable.

Six battens of willow 36 inches long and 1 $\frac{1}{2}$ square were broken by 525 pounds at a medium.

Strength of Materials. Six bars were cut $\frac{1}{4}$ through, and the cut filled with a wedge of hard wood stuck in with a little force: these broke with 551.

Six bars were cut half through, and the cut was filled in the same manner: they broke with 512.

Six bars were cut $\frac{3}{4}$ through: these broke with 530.

A batten cut $\frac{1}{4}$ through, and loaded till nearly broken, was unloaded, and the wedge taken out of the cut. A thicker wedge was put in tight, so as to make the batten straight again by filling up the space left by the compression of the wood: this batten broke with 577 pounds.

From this it is plain that more than $\frac{3}{4}$ of the thickness (perhaps nearly $\frac{1}{2}$) contributed nothing to the strength.

The point A is the centre of fracture in this case; and in order to estimate the strength of the piece, we may suppose that the crooked lever virtually concerned in the strain is DAB . We must find the point I , which is the centre of effort of all the attractive forces, or that point where the full cohesion of AD must be applied, so as to have a momentum equal to the accumulated moments of all the variable forces. We must in like manner find the centre of effort i of the repulsive or supporting forces exerted by the fibres lying between Δ and A .

It is plain, and the remark is important, that this last centre of effort is the real fulcrum of the lever, although A is the point where there is neither extension nor contraction; for the lever is supported in the same manner as if the repulsions of the whole line $A \Delta$ were exerted at that point. Therefore let S represent the surface of fracture from A to D , and f represent the absolute cohesion of a fibre at D in the instant of fracture. We shall have $fS \times \overline{I+} = p l$, or $l: I + i = fS : p$; that is, the length AB is to the distance between the two centres of effort I and i , as the absolute cohesion of the section between A and D is to the relative strength of the section.

It would be perhaps more accurate to make AI and Ai equal to the distances of A from the horizontal lines passing through the centres of gravity of the triangles dAD and $\delta A \Delta$. It is only in this construction that the points I and i are the centres of real effort of the accumulated attractions and repulsions. But I and i , determined as we have done, are the points where the full, equal, actions may be all applied, so as to produce the same momenta. The final results are the same in both cases. The attentive and duly informed reader will see that Mr Bullinger, in a very elaborate dissertation on the strength of beams in the *Comment. Petropolitian.* 1729, has committed several mistakes in his estimation of the actions of the fibres. We mention this because his reasonings are quoted and appealed to as authorities by Muschenbroek and other authors of note. The subject has been considered by many authors on the continent. We recommend to the reader's perusal the very minute discussions in the *Memoirs of the Academy of Paris* for 1722 by Varignon, the *Memoirs* for 1708 by Parent, and particularly that of Coulomb in the *Mém. par les Savans Etrangers*, tom. vii.

It is evident from what has been said above, that if S and s represent the surfaces of the sections above and below A , and if G and g are the distances of their centres of gravity from A , and O and o the distances of their centres

75
An important consequence of the compressibility of body fully proved.

Strength of centres of oscillation, and D and d their whole depths, Materials
 the momentum of cohesion will be $\frac{f \cdot S \cdot G \cdot O}{D} = \frac{f \cdot s \cdot g \cdot o}{d}$
 $= \rho l$.

If (as is most likely) the forces are proportional to the extensions and compressions, the distances AI and Ai , which are respectively $= \frac{G \cdot O}{D}$ and $\frac{g \cdot o}{d}$, are respectively $= \frac{1}{3} DA$, and $\frac{1}{3} \Delta A$; and when taken together are $= \frac{1}{3} D \Delta$. If, moreover, the extensions are equal to the compressions in the instant of fracture, and the body is a rectangular prism like a common joist or beam, then DA and ΔA are also equal; and therefore the momentum of cohesion is $f b \times \frac{1}{3} d \times \frac{1}{3} d$, $= \frac{f b d^2}{6}$, $= f b d \times \frac{1}{3} d = \rho l$. Hence we obtain this analogy, "Six times the length is to the depth as the absolute cohesion of the section is to its relative strength."

⁷⁶
 This consequence follows from the extension.

Thus we see that the compressibility of bodies has a very great influence on their power of withstanding a transverse strain. We see that in this most favourable supposition of equal dilations and compressions, the strength is reduced to one half of the value of what it would have been had the body been incompressible. This is by no means obvious; for it does not readily appear how compressibility, which does not diminish the cohesion of a single fibre, should impair the strength of the whole. The reason, however, is sufficiently convincing when pointed out. In the instant of fracture a smaller portion of the section is actually exerting cohesive forces, while a part of it is only serving as a fulcrum to the lever, by whose means the strain on the section is produced. We see too that this diminution of strength does not so much depend on the sensible compressibility, as on its proportion to the dilatibility by equal forces. When this proportion is small, ΔA is small in comparison of DA , and a greater portion of the whole fibre is exerting attractive forces. The experiments already mentioned, of Du Hamel de Monceau, on battens of willow, show that its compressibility is nearly equal to its dilatibility. But the case is not very different in tempered steel. The famous Harrison, in the delicate experiments which he made while occupied in making his longitude watch, discovered that a rod of tempered steel was nearly as much diminished in its length as it was augmented by the same external force. But it is not by any means certain that this is the proportion of dilatation and compression which obtains in the very instant of fracture. We rather imagine that it is not. The forces are nearly as the dilatations till very near breaking; but we think that they diminish when the body is just going to break. But it seems certain that the forces which resist compression increase faster than the compressions, even before fracture. We know incontestably that the ultimate resistances to compression are insuperable by any force which we can employ. The repulsive forces therefore (in their whole extent) increase faster than the compressions, and are expressed by an asymptotic branch of the Bolesian curve formerly explained. It is therefore probable, especially in the more simple substances, that they increase faster, even in such compressions as frequently obtain in the breaking of hard bodies. We are disposed to think that this is always the case in such bodies as do not fly off in splinters on the concave side; but this must be

understood with the exception of the permanent changes See Art. 57
 which may be made by compression, when the bodies are crippled by it. This always increases the compression itself, and causes the neutral point to shift still more towards D . The effect of this is sometimes very great and fatal.

Experiment alone can help us to discover the proportion between the dilatibility and compressibility of bodies. The strain now under consideration seems the best calculated for this research. Thus if we find that a piece of wood an inch square requires 12,000 pounds to tear it asunder by a direct pull, and that 200 pounds will break it transversely by acting 10 inches from the section of fracture, we must conclude that the neutral point A is in the middle of the depth, and that the attractive and repulsive forces are equal. Any notions that we can form of the constitution of such fibrous bodies as timber, make us imagine that the *sensible* compressions, including what arises from the bending up of the compressed fibres, is much greater than the real corporeal extensions. One may get a general conviction of this unexpected proposition by reflecting on what must happen during the fracture. An undulated fibre can only be drawn straight, and then the corporeal extension begins; but it may be bent up by compression to any degree, the corporeal compression being little affected all the while. This observation is very important; and though the forces of corporeal repulsion may be almost insuperable by any compression that we can employ, a *sensible* compression may be produced by forces not enormous, sufficient to cripple the beam. Of this we shall see very important instances afterwards.

It deserves to be noticed, that although the relative ⁷⁷
 strength of a prismatic solid is extremely different in the The proportional
 three hypotheses now considered, yet the proportional strengths of
 strengths of different pieces follow the same ratio; different pieces follow
 namely, the direct ratio of the breadth, the direct ratio the
 of the square of the depth, and the inverse ratio of the same
 length. In the first hypothesis (of equal forces) the ratio
 strength of a rectangular beam was $\frac{f b d^2}{2l}$; in the second
 (of attractive forces proportioned to the extensions) it
 was $\frac{f b d^2}{3l}$; and in the third (equal attractions and repulsions proportioned to the extensions and compressions) it was $\frac{f b d^2}{6l}$, or more generally $\frac{f b d^2}{m l}$, where m expresses the unknown proportion between the attractions and repulsions corresponding to an equal extension and compression.

Hence we derive a piece of useful information, which ⁷⁸
 is confirmed by unexceptionable experience, that the The
 strength of a piece depends chiefly on its depth, that is, the strength of
 that dimension which is in the direction of the strain, is a piece de-
 A bar of timber of one inch in breadth and two inches pend chiefly
 in depth is four times as strong as a bar of only one inch on its
 deep, and it is twice as strong as a bar two inches broad depth.
 and one deep; that is, a joist or lever is always strongest when laid on its edge.

There is therefore a choice in the manner in which ⁷⁹
 the cohesion is opposed to the strain. The general aim And there-
 must be to put the centre of effort I as far from the ful- is to place in
 crum or the neutral point A as possible, so as to give the the man-
 greatest energy or momentum to the cohesion. Thus if ner in
 a triangular bar projecting from a wall is loaded with a which the
 weight is applied to
 the strain.

Strength of weight at its extremity, it will bear thrice as much when one of the sides is uppermost as when it is undermost. The bar of fig. 6. would be three times as strong if the side AB were uppermost and the edge DC undermost.

Hence it follows that the strongest joint that can be cut out of a round tree is not the one which has the greatest quantity of timber in it, but such that the product of its breadth by the square of its depth shall be the greatest possible. Let ABCD (fig. 9.) be the section of this joint inscribed in the circle, AB being the breadth and AD the depth. Since it is a rectangular section, the diagonal BD is a diameter of the circle, and BAD is a right-angled triangle. Let BD be called a , and BA be called x ; then AD is $= \sqrt{a^2 - x^2}$. Now we must have $AB \times AD^2$, or $x \times a^2 - x^3$, or $a^2 x - x^3$, a maximum. Its fluxion $a^2 x - 3x^2 x'$ must be made $= 0$, or $a^2 = 3x^2$, or $x = \frac{a}{\sqrt{3}}$. If therefore we make $DE = \frac{1}{3} DB$, and draw EC perpendicular to BD , it will cut the circumference in the point C, which determines the depth BC and the breadth CD.

Because $BD : BC = CD : CE$, we have the area of the section $BC \cdot CD = BD \cdot CE$. Therefore the different sections having the same diagonal BD are proportional to their heights CE. Therefore the section ECDA is less than the section BCDA, whose four sides are equal. The joint so shaped, therefore, is both stronger, lighter, and cheaper.

The strength of ABCD is to that of $aBCD$ as 10,000 to 9186, and the weight and expence as 10,000 to 10,627; so that ABCD is preferable to $aBCD$ in the proportion of 10,627 to 9186, or nearly 115 to 100.

From the same principles it follows that a hollow tube is stronger than a solid rod containing the same quantity of matter. Let fig. 10. represent the section of a cylindrical tube, of which AF and BE are the exterior and interior diameters, and C the centre. Draw BD perpendicular to EC, and join DC. Then, because $BD^2 = CD^2 - CE^2$, BD is the radius of a circle containing the same quantity of matter with the ring. If we estimate the strength by the first hypothesis, it is evident that the strength of the tube will be to that of the solid cylinder, whose radius is BD, as $BD^2 \times AC$ to $BD^3 \times BD$; that is, as AC to BD : for BD^3 expresses the cohesion of the ring or the circle, and AC and BD are equal to the distances of the centres of effort (the same with the centres of gravity) of the ring and circle from the axis of the fracture.

The proportion of these strengths will be different in the other hypotheses, and is not easily expressed by a general formula; but in both it is still more in favour of the ring or hollow tube.

The following very simple solution will be readily understood by the intelligent reader. Let O be the centre of oscillation of the exterior circle, o the centre of oscillation of the inner circle, and w the centre of oscillation of the ring included between them. Let M be the quantity of surface of the exterior circle, m that of the inner circle, and μ that of the ring.

$$\text{We have } Fw = \frac{MFO - mFo}{\mu} = \frac{\zeta FC^2 + EC^2}{4FC}$$

and the strength of the ring $= \frac{f\mu \times Fw}{2}$, and the

strength of the same quantity of matter in the form of a solid cylinder is $f\mu \times \frac{1}{2} BD$; so that the strength of the ring is to that of the solid rod of equal weight as Fw to $\frac{1}{2} BD$, or nearly as FC to BD . This will easily appear by recollecting that FO is $= \frac{\text{sum of } p \cdot r^2}{m \cdot FC}$ (See NOTATION), and that the momentum of cohesion is $\frac{f\mu \cdot FC \cdot Ca}{2FC} = \frac{f\mu \cdot Fo}{2}$ for the inner circle, &c.

Emerfon has given a very inaccurate approximation to this value in his *Mechanics*, 410. This property of hollow tubes is accompanied also and more with greater stiffness; and the superiority in strength and stiffness is so much the greater as the surrounding shell is thinner in proportion to its diameter.

Hence we see the admirable wisdom of the nature in forming the bones of animal limbs hollow. The bones of the arms and legs have to perform the office of levers, and are thus opposed to very great transverse strains. By this form they become incomparably stronger and stiffer, and give more room for the insertion of muscles, while they are lighter and therefore more agile; and the same wisdom has made use of this hollow for other valuable purposes of the animal economy.

In like manner the quills in the wings of birds acquire by their thinness the very great strength which is necessary, while they are so light as to give sufficient buoyancy to the animal in the rare medium in which it must live and fly about. The stalks of many plants, such as all the grasses, and many reeds, are in like manner hollow, and thus possess an extraordinary strength. Our best engineers now begin to imitate nature by making many parts of their machines hollow, such as their axes of cast iron, &c.; and the ingenious Mr Ramsden now makes the axes and framings of his great astronomical instruments in the same manner.

In the supposition of homogeneous texture, it is plain that the fracture happens as soon as the particles at D are separated beyond their utmost limit of cohesion. This is a determined quantity, and the piece bends till this degree of extension is produced in the outermost fibre. It follows, that the smaller we suppose the distance between A and D, the greater will be the curvature which the beam will acquire before it breaks. Greater depth therefore makes a beam not only stronger but also stiffer. But if the parallel fibres can slide on each other, both the strength and the stiffness will be diminished. Therefore if, instead of one beam DAKC (fig. 8.) we suppose two, DABC and ADKB, not cohering, each of them will bend, and the extension of the fibres AB of the under beam will not hinder the compression of the adjoining fibres AB of the upper beam. The two together therefore will not be more than twice as strong as one of them (supposing $DA = A\Delta$) instead of being four times as strong; and they will bend as much as either of them alone would bend by half the load. This may be prevented, if it were possible to unite the two beams all along the seam AB, so that the one shall not slide on the other. This may be done in small works, by gluing them together with a cement as strong as the natural lateral cohesion of the fibres. If this cannot be done (as it cannot in large works), the sliding is prevented by JOGGING the beams together; that is, by cutting down several rectangular notches in the upper side of the lower beam, and making similar notches

Material
So
The strongest joint has at the greatest quantity of timber.
Fig. 9.

Fig. 10.
A hollow tube stronger than a solid rod containing the same quantity of matter.
Fig. 10.

Strength of Matter
82
83
84
85
86
87
88
89
90
91
92
93
94
95
96
97
98
99
100

Strength of Materials in the under side of the upper beam, and *GH*; up the square spaces with pieces of very hard wood firmly driven in, as represented in fig. 11. Some employ iron bolts by way of joggles. But when the joggle is much harder than the wood into which it is driven, it is very apt to work loose, by widening the hole into which it is lodged. The same thing is sometimes done by earthing the one upon the other, as represented in fig. 12; but this wastes more timber, and is not so strong, because the mutual hooks which this method forms on each beam are very apt to tear each other up. By one or other of these methods, or something similar, may a compound beam be formed, of any depth, which will be almost as stiff and strong as an entire piece.

Fig. 11.

Fig. 12.

53

How strength may be combined with plianency. Fig. 13.

56

Maxims of construction.

Fig. 14. and 15.

Fig. 16. and 17.

Fig. 17.

57

The strain depends on the external force.

On the other hand, we may combine strength with plianency, by composing our beam of several thin planks laid on each other, till they make a proper depth, and leaving them at full liberty to slide on each other. It is in this manner that coach-springs are formed, as is represented in fig. 13. In this assemblage there must be no joggles nor bolts of any kind put through the planks or plates; for this would hinder their mutual sliding. They must be kept together by straps which surround them, or by something equivalent.

The preceding observations show the propriety of some maxims of construction, which the artists have derived from long experience. Thus, if a mortise is to be cut out of a piece which is exposed to a cross strain, it should be cut out from that side which becomes concave by the strain, as in fig. 14, but by no means as in fig. 15.

If a piece is to be strengthened by the addition of another, the added piece must be joined to the side which grows convex by the strain, as in fig. 16, and 17.

Before we go any farther, it will be convenient to recal the reader's attention to the analogy between the strain on a beam projecting from a wall and loaded at the extremity, and a beam supported at both ends and loaded in some intermediate point. It is sufficient on this occasion to read attentively what is delivered in the article ROOF, N^o 19.—We learn there that the strain on the middle point C (fig. 17. of the present article) of a rectangular beam AB, supported on props at A and B, is the same as if the part CA projected from a wall, and were loaded with the half of the weight W suspended at A. The momentum of the strain is therefore $\frac{1}{2} W \times \frac{1}{2} AB$, $= W \times \frac{1}{4} AB = p \frac{1}{4} l$, or $\frac{p}{4} l$. The momentum of cohesion must be equal to this in every hypothesis.

Having now considered in sufficient detail the circumstances which affect the strength of any section of a solid body that is strained transversely, it is necessary to take notice of some of the chief modifications of the strain itself. We shall consider only those that occur most frequently in our constructions.

The strain depends on the external force, and also on the lever by which it acts.

It is evidently of importance, that since the strain is exerted in any section by means of the cohesion of the parts intervening between the section under consideration and the point of application of the external force, the body must be able in all these intervening parts to propagate or excite the strain in the remote section. In

every part it must be able to resist the strain exerted in that part. It should therefore be equally strong; and it is useless to have any part stronger, because the piece will nevertheless break where it is not stronger throughout; and it is useless to make it stronger (relatively to its strain) in any part, for it will nevertheless equally fail in the part that is too weak.

Suppose then, in the first place, that the strain arises from a weight suspended at one extremity, while the other end is firmly fixed in a wall. Supposing also the cross sections to be all rectangular, there are several ways of shaping the beam so that it shall be equally strong throughout. Thus it may be equally deep in every part, the upper and under surfaces being horizontal planes. The condition will be fulfilled by making all the horizontal sections triangles, as in fig. 18. The two sides are vertical planes meeting in an edge at the extremity L. For the equation expressing the balance of strain and strength is $p = fl/d^2$. Therefore since d^2 is the same throughout, and also p , we must have $fl = l$, and b (the breadth AD of any section ABCD) must be proportional to l (or AL), which it evidently is.

Or, if the beam be of uniform breadth, we must have d^2 everywhere proportional to l . This will be obtained by making the depths the ordinates of a common parabola, of which L is the vertex and the length is the axis. The upper or under side may be a straight line, as in fig. 19, or the middle line may be straight, and then both upper and under surfaces will be curved. It is almost indifferent what is the shape of the upper and under surfaces, provided the distances between them in every part be as the ordinates of a common parabola.

Or, if the sections are all similar, such as circles, squares, or any other similar polygons, we must have d^2 or b^2 proportional to l , and the depths or breadths must be as the ordinates of a cubical parabola.

It is evident that these are also the proper forms for a lever moveable round a fulcrum, and acted on by a force at the extremity. The force comes in the place of the weight suspended in the cases already considered; and as such levers always are connected with another arm, we readily see that both arms should be fashioned in the same manner. Thus in fig. 18. the piece of timber may be supposed a kind of steelyard, moveable round a horizontal axis OP, in the front of the wall, and having the two weights S P and π in equilibrium. The strain occasioned by each at the section in which the axis OP is placed must be the same, and each arm OL and OA must be equally strong in all its parts. The longitudinal sections of each arm must be a triangle, a common parabola, or a cubic parabola, according to the conditions previously given.

And, moreover, all these forms are equally strong: For any one of them is equally strong in all its parts, and they are all supposed to have the same section at the front of the wall or at the fulcrum. They are not, however, equally stiff. The first, represented in fig. 18, will bend least upon the whole, and the one formed by the cubic parabola will bend most. But their curvature at the very fulcrum will be the same in all.

It is also plain, that if the lever is of the second or third kind, that is, having the fulcrum at one extremity, it must still be of the same shape; for in abstract mechanics it is indifferent which of the three points is considered as the axis of motion. In every lever the

Strength of Materials.
 two forces at the extremities act in one direction, and the force in the middle acts in the opposite direction, and the great strain is always at that point. Therefore a lever such as fig. 18. moveable round an axis passing horizontally through λ , and acting against an obstacle at OP, is equally able in all its parts to resist the strains excited in those parts.

The same principles and the same construction will apply to beams, such as joists, supported at the ends L and λ (fig. 13.), and loaded at some intermediate part OP. This will appear evident by merely inverting the directions of the forces at their three points, or by recurring to the article Roofs, N^o 19.

⁸⁰ Hitherto we have supposed the external straining force as acting only in one point of the beam. But it may be uniformly distributed all over the beam. To make a beam in such circumstances equally strong in all its parts, the shape must be considerably different from the former.

Thus suppose the beam to project from a wall.

⁸⁰ The external straining force may be distributed over the beam.
⁸⁰ To make a beam strong which projects from a wall.
 If it be of equal breadth throughout, its sides being vertical planes parallel to each other and to the length, the vertical section in the direction of its length must be a triangle instead of a common parabola; for the weight uniformly distributed over the part lying beyond any section, is as the length beyond that section: and since it may all be conceived as collected at its centre of gravity, which is the middle of that length, the lever by which this load acts or strains the section is also proportional to the same length. The strain on the section (or momentum of the load) is as the square of that length. The section must have strength in the same proportion. Its strength being as the breadth and the square of the depth, and the breadth being constant, the square of the depth of any section must be as the square of its distance from the end, and the depth must be as that distance; and therefore the longitudinal vertical section must be a triangle.

But if all the transverse sections are circles, squares, or any other similar figures, the strength of every section, or the cube of the diameter, must be as the square of the length beyond that section, or the square of its distance from the end; and the sides of the beam must be a semicubical parabola.

If the upper and under surfaces are horizontal planes, it is evident that the breadth must be as the square of the distance from the end, and the horizontal sections may be formed by arches of the common parabola, having the length for their tangent at the vertex.

By recurring to the analogy so often quoted between a projecting beam and a joint, we may determine the proper form of joists which are uniformly loaded through their whole length.

⁸¹ This is a frequent and important case, being the office of joists, rafters, &c.; and there are some circumstances which must be particularly noticed, because they are not so obvious, and have been misunderstood. When a beam AB (fig. 20.) is supported at the ends, and a weight is laid on any point P, a strain is excited in every part of the beam. The load on P causes the beam to press on A and B, and the props react with forces equal and opposite to these pressures. The load at P is to the pressures at A and B as AB to PB and PA, and the pressure at A is to that at B as PB to PA; the beam therefore is in the same state, with re-

Strength of Materials.
 spect to strain in every part of it, as if it were resting on a prop at P, and were loaded at the ends with weights equal to the two pressures on the props: and observe, these pressures are such as will balance each other, being inversely as their distances from P. Let P represent the weight or load at P. The pressure on the prop P must be $P \times \frac{PA}{AB}$. This is therefore the reaction of the prop B, and is the weight which we may suppose suspended at B, when we conceive the beam resting on a prop at P, and carrying the balancing weights at A and B.

The strain occasioned at any other point C, by the load P at P, is the same with the strain at C, by the weight $P \times \frac{PA}{AB}$ hanging at B, when the beam rests on P, in the manner now supposed; and it is the same if the beam, instead of being balanced on a prop at P, had its part AP fixed in a wall. This is evident. Now we have shown at length that the strain at C, by the weight $P \times \frac{PA}{AB}$ hanging at B, is $P \times \frac{PA}{AB} \times BC$. We desire it to be particularly remarked that the pressure at A has no influence on the strain at C, arising from the action of any load between A and C; for it is indifferent how the part AP of the projecting beam PB is supported. The weight at A just performs the same office with the wall in which we suppose the beam to be fixed. We are thus particular, because we have seen even persons not unaccustomed to discussions of this kind puzzled in their conceptions of this strain.

Now let the load P be laid on some point p between C and B. The same reasoning shows us that the point is (with respect to strain) in the same state as if the beam were fixed in a wall, embracing the part p B, and a weight $= P \times \frac{pB}{AB}$ were hung on at A, and the strain at C is $P \times \frac{pB}{AB} \times AC$.

In general, therefore, the strain on any point C, arising from a load P laid on another point P, is proportional to the rectangle of the distances of P and C from the ends nearest to each. It is $P \times \frac{PA \times CB}{AB}$, or $P \times \frac{pB \times CA}{AB}$, according as the load lies between C and A or between C and B.

⁹² A general proposition.
 Cor. 1. The strains which a load on any point P occasions on the points C, c , lying on the same side of P, are as the distances of these points from the end B. In like manner the strains on E and e are as EA and eA .

Cor. 2. The strain which a load occasions in the part on which it rests is as the rectangle of the parts on each side. Thus the strain occasioned at C by a load is to that at D by the same load as $AC \times CB$ to $AD \times DB$. It is therefore greatest in the middle.

Let us now consider the strain on any point C arising from a load uniformly distributed along the beam. Let arising from a load distributed along the beam. AP be represented by x , and Pp by x , and the whole weight on the beam by a . Then

The weight on Pp is $= a \frac{x}{AB}$, Pressure

Let arising from a load distributed along the beam. AP be represented by x , and Pp by x , and the whole weight on the beam by a . Then

The weight on Pp is $= a \frac{x}{AB}$, Pressure

Strength of Materials

Strength of Materials

Pressure on B by the weight on Pp = $a \frac{x}{AB} \times \frac{x}{AB}$

Or " " " = $a \frac{x^2}{AB^2}$

Pres. on B by whole wf. on AC = $a \frac{AC^2}{AB^2} = a \frac{AC^2}{2AB^2}$

Strain at C by the weight on AC = $a \frac{AC^2 \times BC}{2AB^2}$

Strain at C by the weight on BC = $a \frac{BC^2 \times AC}{2AB^2}$

Da. by whole weight on AB = $a \frac{AC^2 \times BC + BC^2 \times AC}{2AB^2}$

= $a \frac{AC \times BC \times AC + CB}{2AB^2} = a \frac{AC \times BC}{2AB}$

Thus we see that the strain is proportional to the rectangle of the parts, in the same manner as if the load a had been laid directly on the point C, and is indeed equal to one-half of the strain which would be produced at C by the load a laid on there.

Mistakes in this subject committed by authors of reputation.

It was necessary to be thus particular, because we see in some elementary treatises of mechanics, published by authors of reputation, mistakes which are very plausible, and mislead the learner. It is there said, that the pressure at B from a weight uniformly diffused along AB is the same as if it were collected at its centre of gravity, which would be the middle of AB; and then the strain at C is said to be this pressure at B multiplied by BC. But surely it is not difficult to see the difference of these strains. It is plain that the pressure of gravity downwards on any point between the end A and the point C has no tendency to diminish the strain at C, arising from the upward reaction of the prop B; whereas the pressure of gravity between C and B is almost in direct opposition to it, and must diminish it. We may however avoid the fluxional calculus with safety by the consideration of the centre of gravity, by supposing the weights of AC and BC to be collected at their respective centres of gravity; and the result of this computation will be the same as above: and we may use either method, although the weight is not uniformly distributed, provided only that we know in what manner it is distributed.

This investigation is evidently of importance in the practice of the engineer and architect, informing them what support is necessary in the different parts of their constructions. We considered some cases of this kind in the article ROOFS.

It is now easy to form a joint, so that it shall have the same relative strength in all its parts.

I. To make it equally able in all its parts to carry a given weight laid on any point C taken at random, or uniformly diffused over the whole length, the strength of the section at the point C must be as $AC \times CB$. Therefore

1. If the sides are parallel vertical planes, the square of the depth (which is the only variable dimension) or CD^2 , must be as $AC \times CB$, and the depths must be ordinates of an ellipse.

2. If the transverse sections are similar, we must make CD^2 as $AC \times CB$.

3. If the upper and under surfaces are parallel, the breadth must be as $AC \times CB$.

II. If the beam is necessarily loaded at some given point C, and we would have the beam equally able in all its parts to resist the strain arising from the weight at C, we must make the strength of every transverse section between C and either end as its distance from that end. Therefore

1. If the sides are parallel vertical planes, we must make $CD^2 : EF^2 = AC : AE$.

2. If the sections are similar, then $CD^2 : EF^2 = AC : AE$.

3. If the upper and under surfaces are parallel, then, breadth at C; breadth at E = $AC : AE$.

The same principles enable us to determine the strain and strength of square or circular plates, of different extent, but equal thickness. This may be comprehended in this general proposition.

Similar plates of equal thickness supported all round will carry the same absolute weight, uniformly distributed, or resting on similar points, whatever is their extent, but of equal thickness.

Suppose two similar oblong plates of equal thickness, and let their lengths and breadths be L, l and B, b , terminated at their ends by the same proportions. Let their strength or momentum of cohesion be C, c , and the strains from the weights W, w , be S, s .

Suppose the plates supported at the ends only, and resting fracture transversely. The strains, being as the weights and lengths, are as WL and wl , but their cohesions are as the breadths; and since they are of equal relative strength, we have $WL : w \div B : b$, and $WLb \div w \div B$ and $L : l \div w \div B : Wb$; but since they are of similar shapes $L : l \div B : b$, and therefore $w \div W$.

The same reasoning holds again when they are also supported along the sides, and therefore holds when they are supported all round (in which case the strength is doubled).

And if the plates are of any other figure, such as circles or ellipses, we need only conceive similar rectangles inscribed in them. These are supported all round by the continuity of the plates, and therefore will sustain equal weights; and the same may be said of the segments which lie without them, because the strengths of any similar segments are equal, their lengths being as their breadths.

Therefore the thickness of the bottoms of vessels holding heavy liquors or grains should be as their diameters, and as the square root of their depths jointly.

Also the weight which a square plate will bear is to that which a bar of the same matter and thickness will bear as twice the length of the bar to its breadth.

There is yet another modification of the strain which tends to break a body transversely, which is of very frequent occurrence, and in some cases must be very carefully attended to, viz. the strain arising from its own weight.

When a beam projects from a wall, every section is strained by the weight of all that projects beyond it. This may be considered as all collected at its centre of gravity. Therefore the strain on any section is in the joint ratio of the weight of what projects beyond it, and the distance of its centre of gravity from the section.

The determination of this strain and of the strength necessary for withstanding it must be more complicated than the former, because the form of the piece which results from this adjustment of strain and strength influences

To form a joint which may have the same relative strength in all its parts.

The strain of a beam arising from its own weight.

Strength of
Materials
Fig. 22.

of strain on the same section of a beam simply resting on supports at the ends, and loaded at some intermediate point or points. The strain on the middle C of a beam AB (fig. 22.) is supposed, arising from a weight laid on there, is the same with the strain which half of it weight hanging at B would produce on the same section C if the other end of the beam were fixed in a wall. If therefore 1000 pounds hung on the end of a beam projecting 10 feet from a wall will just break it at the wall, it will require 2000 pounds on its middle to break the same beam resting on two props 10 feet asunder. We have also shown in that article the additional strength which will be given to this beam by extending both ends beyond the props, and there fastening it firmly into other pillars or supports. We can hardly add any thing to what has been laid in that article, except a few observations on the effects of the obliquity of the external force. We have hitherto supposed it to act in the direction BP (fig. 8.) perpendicular to the length of the beam. Suppose it to act in the direction BP, oblique to BA. In the article Roofs we supposed the strain to be the same as if the force P acted at the distance AB', but still perpendicular to AB; to it is. But the strength of the section AΔ is not the same in both cases; for by the obliquity of the action the piece DCKΔ is pressed to the other. We are not sufficiently acquainted with the corporeal forces to say precisely what will be the effect of the pressure arising from this obliquity; but we can clearly see, in general, that the point A, which in the instant of fracture is neither stretched nor compressed, must now be farther up, or nearer to D; and therefore the number of particles which are exerting cohesive forces is smaller, and therefore the strength is diminished. Therefore, when we endeavour to proportion the strength of a beam to the strain arising from an external force acting obliquely, we make too liberal allowance by increasing this external force in the ratio of AB to AB'. We acknowledge our inability to assign the proper correction. But this circumstance is of very great influence. In many machines, and many framings of carpentry, this oblique action of the straining force is unavoidable; and the most enormous strains to which materials are exposed are generally of this kind. In the frames set up for carrying the ringstones of arches, it is hardly possible to avoid them: for although the judicious engineer disposes his beams so as to sustain only pressures in the direction of their lengths, tending either to crush them or to tear them asunder, it frequently happens that, by the settling of the work, the pieces come to check and bear on each other transversely, tending to break each other across. This we have remarked upon in the article Roofs, with respect to a truss by Mr Price (see Roofs, N^o 42, 43, 45). Now when a cross strain is thus combined with an enormous pressure in the direction of the length of the beam, it is in the utmost danger of snapping suddenly across. This is one great cause of the carrying away of masts. They are compressed in the direction of their length by the united force of the threads, and in this state the transverse action of the wind soon completes the fracture.

123
Effects of
the obliquity
of the
external
force.

124
The strain
on columns.

When considering the compressing strains to which materials are exposed, we deferred the discussion of the strain on columns, observing that it was not, in the case, which usually occur, a simple compression, but was combined with a transverse strain, arising from the bending

of the column. When the column ACB (fig. 23.) rests on the ground at B, and loaded at A, by a weight A, acting in the vertical direction AB, is bent into a curve ACB, so that the tangent at C is perpendicular to the horizon, its condition to remain perpendicular to a beam firmly fixed between B and C, and strongly pulled by the end A, is as to bend it between C and A. Although we cannot conceive how a force acting on a straight column AB in the direction AB can bend it, we may suppose that the force acted first in the horizontal direction Ab till it was bent to this degree, and that the rope was then gradually removed from the direction Ab to the direction AB, increasing the force as much as is necessary for preserving the same quantity of flexure.

The first author (we believe) who considered this important subject with scrupulous attention was the celebrated Euler, who published in the Berlin Memoirs for 1755 his Theory of the Strength of Columns. The general proposition established by this theory is, that the strength of prismatical columns is in the direct quadruplicate ratio of their diameters, and the inverse duplicate ratio of their lengths. He prosecuted this subject in the Petersburg Commentaries for 1778, confirming his former theory. We do not find that any other author has bestowed much attention on it, all seeming to acquiesce in the determinations of Euler, and to consider the subject as of very great difficulty, requiring the application of the most refined mathematics. Mufchenbroek has compared the theory with experiment; but the comparison has been very unsatisfactory, the difference from the theory being so enormous as to afford no argument for its justness. But the experiments do not contradict it, for they are so anomalous as to afford no conclusion or general rule whatever.

To say the truth, the theory can be considered in no other light than as a specimen of ingenious and very artificial algebraic analysis, Euler was unquestionably the first analyst in Europe for resource and address. He knew this, and enjoyed his superiority, and without scruple admitted any physical assumptions which gave him an opportunity of displaying his skill. The inconsistency of his assumptions with the known laws of mechanism gave him no concern; and when his algebraic processes led him to any conclusion which would make his readers stare, being contrary to all our usual notions, he frankly owned the paradox, but went on in his analysis, saying, "Sed analysis magis filendam." Mr Robins has given some very noble instances of this confidence in his analysis, or rather of his confidence in the indolent submission of his readers. Nay, so fond was he of this kind of amusement, that after having published an unentailed Theory of Light and Colours, he published several Memoirs, explaining the aberration of the heavenly bodies, and deducing some very wonderful consequences, fully confirmed by experience, from the Newtonian principles, which were opposite and totally inconsistent with his own theory, merely because the Newtonian theory gave him "occiduum analysis promovenda." We are thus severe in our observations, because his theory of the strength of columns is one of the strongest instances of this wanton kind of proceeding, and because his followers in the Academy of St Petersburg, such as Mr Paul, Laxell, and others, adopt his conclusions, and merely echo his words. Since the death of Daniel Bernoulli

Strength of
Materials
Fig. 23.

125
Effects of
the obliquity
of the
external
force.

Fig. 23.
Materials

Bernoulli no member of that academy has controverted any thing advanced by their *Professor sublimis geometricæ*, to whom they had been indebted for their places and for all their knowledge, having been (most of them) his amanuenses, employed by this wonderful man during his blindness to make his computations and carry on his algebraic investigations. We are not a little surpris'd to see Mr Emerson, a considerable mathematician, and a man of very independent spirit, hastily adopting the same theory, of which we doubt not but our readers will easily see the fallacy.

Fig. 23.

Euler considers the column ACB as in a condition precisely similar to that of an elastic rod bent into the curve by a cord AB connecting its extremities.—In this he is not mistaken.—But he then draws CD perpendicular to AB, and considers the strain on the section C as equal to the momentum or mechanical energy of the weight A acting in the direction DB upon the lever κ C D, moveable round the fulcrum κ , and tending to tear asunder the particles which cohere along the section C κ . This is the same principle (as Euler admits) employed by James Bernoulli in his investigation of the elastic curve ACB. Euler considers the strain on the section κ as the same with what it would sustain if the same power acted in the horizontal direction EF on a point E as far removed from C as the point D is. We reasoned in the same manner (as has been observed) in the article Roofs, where the obliquity of action was inconsiderable. But in the present case, this substitution leads to the greatest mistakes, and has rendered the whole of this theory false and useless. It would be just if the column were of materials which are incompressible. But it is evident, by what has been said above, that by the compression of the parts the real fulcrum of the lever shifts away from the point κ , so much the more as the compression is greater. In the great compressions of loaded columns, and the almost unmeasurable compressions of the truss beams in the centres of bridges, and other cases of chief importance, the fulcrum is shifted far over towards κ , so that very few fibres resist the fracture by their cohesion; and these few have a very feeble energy or momentum, on account of the short arm of the lever by which they act. This is a most important consideration in carpentry, yet makes no element of Euler's theory. The consequence of this is, that a very small degree of curvature is sufficient to cause the column or strut to snap in an instant, as is well known to every experienced carpenter. The experiment by Muschenbroek, which Euler makes use of in order to obtain a measure of strength in a particular instance, from which he might deduce all others by his theorem, is an incontestable proof of this. The force which broke the column is not the twentieth part of what is necessary for breaking it by acting at E in the direction EF. Euler takes no notice of this immense discrepancy, because it must have caused him to abandon the speculation with which he was then amusing himself.

Fig. 24.
This theory false and useless.

The limits of this work do not afford room to enter minutely upon the refutation of this theory; but we can easily show its uselessness, by its total inconsistency with common observation. It results legitimately from this theory, that if CD have no magnitude, the weight A can have no momentum, and the column cannot be broken.—True,—it cannot be broken in this way, snapped by a

transverse fracture, if it do not bend; but we know very well that it can be crushed or crippled, and we see this frequently happen. This circumstance or event does not enter into Euler's investigation, and therefore the theory is imperfect at least and useless. Had this crippling been introduced in the form of a physical assumption, every topic of reasoning employed in the process must have been laid aside, as the intelligent reader will easily see. But the theory is not only imperfect, but false. The ordinary reader will be convinced of this by another legitimate consequence of it. Fig 24. is the same Fig. 24. with fig. 126. of *Emerson's Mechanics*, where this subject is treated on Euler's principles, and represents a crooked piece of matter resting on the ground at F, and loaded at A with a weight acting in the vertical direction AF. It results from Euler's theory that the strains at κ , B, D, E, &c. are as $b\kappa$, BC, DI, EK, &c. Therefore the strains at G and H are nothing; and this is asserted by Emerson and Euler as a serious truth; and the piece may be thinned *ad infinitum* in these two places, or, even cut through, without any diminution of its strength. The absurdity of this assertion strikes at first hearing. Euler asserts the same thing with respect to a point of contrary flexure. Farther discussion is (we apprehend) needless.

This theory must therefore be given up. Yet these Yet Euler's dissertations deserve a perusal, both as they very ingenious specimens of analysis, and because they contain maxims of practice which are important. Although they give an erroneous measure of the comparative strength of columns, they show the immense importance of preventing all bendings, and point out with accuracy where the tendencies to bend are greatest, and how this may be prevented by very small forces, and what a prodigious accession of force this gives the column. There is a valuable paper in the same volume by Fufs on the *Strains on framed Carpentry*, which may also be read with advantage.

It will now be asked, what shall be substituted in place of this erroneous theory? what is the true proportion of the strength of columns? We acknowledge our inability to give a satisfactory answer. Such can be obtained only by a previous knowledge of the proportion between the extensions and compressions produced by equal forces, by the knowledge of the absolute compressions producible by a given force, and by a knowledge of the degree of that derangement of parts which is termed crippling. These circumstances are but imperfectly known to us, and there lies before us a wide field of experimental inquiry. Fortunately the force requisite for crippling a beam is prodigious, and a very small lateral support is sufficient to prevent that bending which puts the beam in imminent danger. A judicious engineer will always employ transverse bristles, as they are called, to stay the middle of long beams, which are employed as pillars, struts, or truss beams, and are exposed, by their position, to enormous pressures in the direction of their lengths. Such stays may be observed, disposed with great judgment and economy, in the centres employed by Mr Perronet in the erection of his great stone arches. He was obliged to correct this omission made by his ingenious predecessor in the beautiful centres of the bridge of Orleans, which we have no hesitation in affirming to be the finest piece of carpentry in the world.

Strength of Materials.

167
Yet Euler's dissertations deserve a perusal.

168
A new theory cannot be substituted in place of Euler's, till many experiments be made.

Strength of Materials. It only remains on this head to compare these theoretical deductions with experiment.

Experiments on the transverse strength of bodies are easily made, and accordingly are very numerous, especially those made on timber, which is the case most common and most interesting. But in this great number of experiments there are very few from which we can draw much practical information. The experiments have in general been made on such small scantlings, that the unavoidable natural inequalities bear too great a proportion to the strength of the whole piece. Accordingly, when we compare the experiments of different authors, we find them differ enormously, and even the experiments by the same author are very anomalous. The complete series that we have yet seen is that detailed by Bâllidor in his *Science des Ingenieurs*. They are contained in the following table. The pieces were found, even-grained oak. The column *b* contains the breadths of the pieces in inches; the column *d* contains their depths; the column *l* contains their lengths; column *p* contains the weights (in pounds) which broke them when hung on their middles; and *m* is the column of averages or mediums.

| N ^o | <i>b</i> | <i>d</i> | <i>l</i> | <i>p</i> | <i>m</i> |
|----------------|----------|----------|----------|----------|----------|
| 1 | 1 | 1 | 18 | 400 | 406 |
| | | | | 415 | |
| | | | | 425 | |
| 2 | 1 | 1 | 18 | 600 | 625 |
| | | | | 600 | |
| | | | | 624 | |
| 3 | 2 | 1 | 18 | 810 | 805 |
| | | | | 795 | |
| | | | | 812 | |
| 4 | 1 | 2 | 18 | 1570 | 1585 |
| | | | | 1580 | |
| | | | | 1590 | |
| 5 | 1 | 1 | 36 | 185 | 187 |
| | | | | 190 | |
| | | | | 180 | |
| 6 | 1 | 1 | 36 | 285 | 283 |
| | | | | 290 | |
| | | | | 285 | |
| 7 | 2 | 2 | 36 | 1550 | 1585 |
| | | | | 1620 | |
| | | | | 1585 | |
| 8 | 2½ | 2½ | 36 | 1665 | 1660 |
| | | | | 1675 | |
| | | | | 1640 | |

The ends lying loose.

The ends firmly fixed.

Loose.

Loose.

Loose.

Fixed.

Loose.

Loose.

119 Corollaries deduced from them. By comparing Experiments 1st and 3d, the strength appears proportional to the breadth.

Experiments 3d and 4th shew the strength proportional to the square of the depth.

VOL. XIX. Part II.

Experiments 1st and 5th shew the strength nearly in the inverse proportion of the lengths, but with a sensible deficiency in the longer pieces.

Experiments 5th and 7th shew the strengths proportional to the breadths and the square of the depth.

Experiments 1st and 7th shew the same thing, compounded with the inverse proportion of the length: the deficiency relative to the length is not so remarkable here.

Experiments 1st and 2d, and experiments 5th and 6th shew the increase of strength, by fastening the ends, to be in the proportion of 2 to 3. The theory gives the proportion of 2 to 4. But a difference in the manner of fixing may produce this deviation from the theory, which only supposed them to be held down at places beyond the props, as when a joist is held in the walls, and also rests on two pillars between the walls. (See what is said on this subject in the article ROOF, § 19.) ; where note, that there is a mistake, when it is said that a beam supported at both ends and loaded in the middle, will carry twice as much as if one end were fixed in the wall and the weight suspended at the other end. The reasoning employed there shews that it will carry four times as much.

The chief source of irregularity in such experiments is the fibrous, or rather plated texture of timber. It consists of annual additions, whose cohesion with each other is vastly weaker than that of their own fibres. Let fig. 25, represent the section of a tree, and ABCD, Fig. 15, *a b c d* the section of two battens that are to be cut out of it for experiment, and let AD and *a d* be the depths, and DC, *d c* the breadths. The batten ABCD will be the strongest, for the same reason that an assemblage of planks set edgewise will form a stronger joist than planks laid above each other like the plates of a coach-spring. M. Buffon found by many trials that the strength of ABCD was to that of *a b c d* (in oak) nearly as 8 to 7. The authors of the different experiments were not careful that their battens had their plates all disposed similarly with respect to the grain. But even with this precaution they would not have afforded sure grounds of computation for large works; for great beams occupy much, if not the whole, of the section of the tree; and from this it has happened that their strength is less than in proportion to that of a small lath or batten. In short, we can trust no experiments but such as have been made on large beams. These must be very rare, for they are most expensive and laborious, and exceed the abilities of most of those who are disposed to study this matter.

But we are not wholly without such authority. M. Buffon and M. Du Hamel, two of the first philosophers and mechanicians of the age, were directed by government to make experiments on this subject, and were supplied with ample funds and apparatus. The relation of their experiments is to be found in the Memoirs of the French Academy for 1740, 1741, 1742, 1768; as also in Du Hamel's valuable performances *sur l'Exploitation des Arbres, et sur la Conservation et le Transport de Bois*. We earnestly recommend these dissertations to the perusal of our readers, as containing much useful information relative to the strength of timber, and the best methods of employing it. We shall here give an abstract of M. Buffon's experiments.

Strength of
Materials
111
Mr Buff
font's exper-
iments on
bars of
found oak.

He relates a great number which he had procured during two years on small battens. He found that the odds of a single layer, or part of a layer, more or less, or even a different disposition of them, had such influence that he was obliged to abandon this method, and to have recourse to the largest beams that he was able to break. The following table exhibits one series of experiments on bars of found oak, clear of knots, and four inches square. This is a specimen of all the rest.

Column 1st is the length of the bar in clear feet between the supports.

Column 2d is the weight of the bar (the 2d day after it was felled) in pounds. Two bars were tried of each length. Each of the first three pairs consisted of two cuts of the same tree. The one next the root was always found the heaviest, stiffest, and strongest. Indeed M. Buffon says that this was invariably true, that the heaviest was always the strongest; and he recommends it as certain (or sure) rule for the choice of timber. He finds that this is always the case when the timber has grown vigorously, forming very thick annual layers. But he also observes that this is only during the advances of the tree to maturity; for the strength of the different circles approaches gradually to equality during the tree's healthy growth, and then it decays in these parts in a contrary order. Our tool-makers assert the same thing with respect to beech; yet a contrary opinion is very prevalent; and wood with a fine, that is, a small grain, is frequently preferred. Perhaps no person has ever made the trial with such minuteness as M. Buffon, and we think that much deference is due to his opinion.

Column 3d is the number of pounds necessary for breaking the tree in the course of a few minutes.

Column 4th is the inches which it bent down before breaking.

Column 5th is the time at which it broke.

| 1 | 2 | 3 | 4 | 5 |
|----|--|---|--|---|
| 7 | $\left\{ \begin{array}{l} 60 \\ 56 \end{array} \right.$ | $\left\{ \begin{array}{l} 5350 \\ 5275 \end{array} \right.$ | $\left\{ \begin{array}{l} 3.5 \\ 4.5 \end{array} \right.$ | $\left\{ \begin{array}{l} 20 \\ 22 \end{array} \right.$ |
| 8 | $\left\{ \begin{array}{l} 68 \\ 63 \end{array} \right.$ | $\left\{ \begin{array}{l} 4600 \\ 4500 \end{array} \right.$ | $\left\{ \begin{array}{l} 3.75 \\ 4.7 \end{array} \right.$ | $\left\{ \begin{array}{l} 15 \\ 13 \end{array} \right.$ |
| 9 | $\left\{ \begin{array}{l} 77 \\ 71 \end{array} \right.$ | $\left\{ \begin{array}{l} 4100 \\ 3950 \end{array} \right.$ | $\left\{ \begin{array}{l} 4.85 \\ 5.5 \end{array} \right.$ | $\left\{ \begin{array}{l} 14 \\ 12 \end{array} \right.$ |
| 10 | $\left\{ \begin{array}{l} 84 \\ 82 \end{array} \right.$ | $\left\{ \begin{array}{l} 3625 \\ 3600 \end{array} \right.$ | $\left\{ \begin{array}{l} 5.85 \\ 6.5 \end{array} \right.$ | $\left\{ \begin{array}{l} 15 \\ 15 \end{array} \right.$ |
| 12 | $\left\{ \begin{array}{l} 100 \\ 95 \end{array} \right.$ | $\left\{ \begin{array}{l} 3550 \\ 2925 \end{array} \right.$ | $\left\{ \begin{array}{l} 7. \\ 8. \end{array} \right.$ | |

The experiments on other sizes were made in the same way. A pair at least of each length and size was taken. The mean results are contained in the following table. The beams were all square, and their sizes in inches are placed at the head of the columns, and their lengths in feet are in the first column.

| | 4 | 5 | 6 | 7 | 8 | A |
|----|------|-------|-------|-------|-------|-------|
| 7 | 5312 | 11525 | 18950 | 32200 | 47649 | 11525 |
| 8 | 4550 | 9757 | 15525 | 26050 | 39750 | 10085 |
| 9 | 4025 | 8308 | 13150 | 22350 | 32800 | 8964 |
| 10 | 3612 | 7125 | 11250 | 19475 | 27750 | 8268 |
| 12 | 2987 | 6075 | 9100 | 16175 | 23450 | 6723 |
| 14 | | 5300 | 7475 | 13225 | 19775 | 5763 |
| 16 | | 4350 | 6362 | 11000 | 16375 | 5242 |
| 18 | | 3700 | 5562 | 9245 | 13200 | 4482 |
| 20 | | 3225 | 4950 | 8375 | 11487 | 4234 |
| 22 | | 2975 | | | | 3667 |
| 24 | | 2162 | | | | 3362 |
| 28 | | 1775 | | | | 2881 |

Strength of
Materials.

M. Buffon had found by numerous trials that oak-timber lost much of its strength in the course of drying or seasoning; and therefore, in order to secure uniformity, his trees were all felled in the same fable of the year, were squared the day after, and tried the third day. Trying them in this green state, gave him an opportunity of observing a very curious and unaccountable phenomenon. When the weights were laid briskly on, nearly sufficient to break the log, a very sensible smoke was observed to issue from the two ends with a sharp hissing noise. This continued all the while the tree was bending and cracking. This shows that the log is affected or drained through its whole length; indeed this must be inferred from its bending through its whole length. It also shows us the great effects of the compression. It is a pity M. Buffon did not take notice whether this smoke issued from the upper or compressed half of the section only, or whether it came from the whole.

We must now make some observations on these experiments, in order to compare them with the theory which we have endeavoured to establish.

M. Buffon considers the experiments with the 5-inch bars as the standard of comparison, having both extended these to greater lengths, and having tried more pieces of each length.

Our theory determines the relative strength of bars of the same section to be inversely as their lengths. But (if we except the five experiments in the first column) we find a very great deviation from this rule. Thus the 5-inch bar of 28 feet long should have half the strength of that of 14 feet, or 2630; whereas it is but 1775. The bar of 14 feet should have half the strength of that of 7 feet, or 5762; whereas it is but 3300. In like manner, the fourth of 11525 is 2881; but the real strength of the 28 feet bar is 1775. We have added a column A, which exhibits the strength which each of the 5-inch bars ought to have by the theory. This deviation is most distinctly seen in fig. 26, where BK is the scale of lengths, B being at the point 7 of the scale, and K at 28. The ordinate CB is = 11525, and the other

ordinates DE, GK, &c. are respectively = $\frac{7CB}{\text{Length}}$. The lines DF, GH, &c. are made = 4350, 1775, &c. expressing the strengths given by experiment. The 10 feet bar and the 24 feet bar are remarkably anomalous. But all are deficient, and the defect has an evident progression from the first to the last. The same thing may

112
Observations
on Mr Buffon's
experiments.

Fig. 26

Strength of
Materia s

be shown of the other columns, and even of the first, though it is very small in that column. It may also be observed in the experiments of Belidor, and in all that we have seen. We cannot doubt therefore of its being a law of nature, depending on the true principles of cohesion, and the laws of mechanics.

But it is very puzzling, and we cannot pretend to give a satisfactory explanation of the difficulty. The only effect which we can conceive the length of a beam to have, is to increase the strain at the section of fracture by employing the intervening beam as a lever. But we do not distinctly see what change this can produce in the mode of action of the fibres in this section, so as either to change their cohesion or the place of its centre of effort: yet something of this kind must happen.

We see indeed some circumstances which must contribute to make a smaller weight sufficient, in Mr Buffon's experiments, to break a long beam, than in the exact inverse proportion of its length.

In the first place, the weight of the beam itself augments the strain as much as if half of it were added in form of a weight. Mr Buffon has given the weights of every beam on which he made experiments, which is very nearly 74 pounds per cubic foot. But they are much too small to be counted for the deviation from the theory. The half weights of the 5-inch beams of 7, 14, and 28 feet length are only 47, 92, and 182 pounds; which makes the real strains in the experiments 11460, 5300, and 1936; which are far from violating the proportions 4, 2, and 1.

Buffon says that healthy trees are universally strongest at the root end; therefore, when we use a longer beam, its middle point, where it is broken in the experiment, is in a weaker part of the tree. But the trials of the 5-inch beams show that the difference from this cause is almost insensible.

The length must have some mechanical influence which the theory we have adopted has not yet explained. It may not however be inadequate to the task. The very ingenious investigation of the elastic curve by James Bernoulli and other celebrated mathematicians is perhaps as refined an application of mathematical analysis as we know. Yet in this investigation it was necessary, in order to avoid almost insuperable difficulties, to take the simplest possible case, viz. where the thickness is exceedingly small in comparison with the length. If the thickness be considerable, the quantities neglected in the calculus are too great to permit the conclusion to be accurate, or very nearly so. Without being able to define the form into which an elastic body of considerable thickness will be bent, we can say with confidence, that in an extreme case, where the compression is to the concave side is very great, the curvature differs considerably from the Bernoullian curve. But as our investigation is incomplete and very long, we do not offer it to the reader. The following more familiar considerations will, we apprehend, render it highly probable that the relative strength of beams decreases faster than in the inverse ratio of their length. The curious observation by Mr Buffon of the vapour which issued with a hissing noise from the ends of a beam of green oak, while it was breaking by the load on its middle, shows that the whole length of the piece was affected: indeed it must be, since it is bent throughout. We have shown above, that a certain definite curvature of a beam of a given form is

always accompanied by rupture. Now suppose the beam A of 10 feet long, and the beam B of 20 feet long, bent to the same degree, at the place of their rupture in the wall; the weight which hangs on A is nearly double of that which hangs on B. The form of any portion, suppose 5 feet, of these two beams, immediately adjoining to the wall, is considerably different. At the distance of 5 feet the curvature of A is $\frac{1}{2}$ of its curvature at the wall. The curvature of B in the corresponding point is $\frac{1}{4}$ th of the same curvature at the wall. Through the whole of the intermediate 5 feet, therefore, the curvature of B is greater than that of A. This must make it weaker throughout. I must therefore endeavour to slide more on each other (so as I may acquire *not* greater curvature), and thus affect their lateral union, and therefore those which are stronger will not assist their weaker neighbours. To this we must add, that in the shorter beams the force with which the fibres are pressed laterally on each other is double. This must impede the mutual sliding of the fibres which we mentioned a little ago; nay, this lateral compression may enrage the law of longitudinal cohesion (as we already have seen to the reader who is acquainted with Hooke's doctrines), and increase the strength of the very surface of fracture, in the same way (however inexplicable) as it does in metals when they are hammered or drawn into wire.

The reader must judge how far these remarks are worthy of his attention. The engineer will carefully keep in mind the important fact, that a beam of quadruple length, instead of having $\frac{1}{16}$ th of the strength, has only about $\frac{1}{26}$ th; and the philosopher should endeavour to discover the cause of this diminution, that he may give the artist a more accurate rule of computation.

Our ignorance of the law by which the cohesion of the particles changes by a change of distance, hinders us from discovering the precise relation between the curvature and the momentum of cohesion; and all we can do is to multiply experiments, upon which we may establish some empirical rules for calculating the strength of solids, and those from which we must reason at present are too few and too anomalous to be the foundation of such an empirical formula. We may, however, observe, that Mr Buffon's experiments give us considerable assistance in this particular: For if to each of the numbers of the column for the 5-inch beams, corrected by adding half the weight of the beam, we add the constant number 1245, we shall have a set of numbers which are very nearly reciprocals of the lengths. Let 1245 be called c , and let the weight which is known by experiment to be necessary for breaking the 5-inch beam of the length a be

called P . We shall have $\frac{P+c \times a}{l} = c \times p$. Thus the

weight necessary for breaking the 7-foot bar is 11360. This added to 1245, and the sum multiplied by 7, gives

$\frac{80635}{15} = 5375\frac{2}{3}$. Let l be 18; then $\frac{80635}{15} = 5375\frac{2}{3} = c \times p$, which differs not more than $\frac{1}{3}$ th from what experiment gives us. This rule holds equally well with all the other lengths except the 12 and 24 foot beams, which are very anomalous. Such a formula is abundantly exact for practice, and will answer through a great variety of length, though it cannot be admitted to be a true one; because, in a certain very great

114
Probable that the relative strength of beams decreases faster than in the inverse ratio of their length.

114
We cannot discover the precise relation between the curvature and the momentum of cohesion.

length, the strength will be nothing. For other fibres the constant number must change in the proportion of d^3 , or perhaps of p .

The next comparison which we have to make with this theory is the relation between the strength and the square of the depth of the section. This is made by comparing with each other the numbers in any horizontal line of the table. In making this comparison we find the numbers of the five-inch bars uniformly greater than the rest. We imagine that there is something peculiar to these bars: They are in general heavier than in the proportion of their section, but not so much so as to account for all their superiority. We imagine that this set of experiments, intended as a standard for the rest, has been made at one time, and that the section has had a considerable influence. The fact however is, that if this column be kept out, or uniformly diminished about one-sixteenth in their strength, the different sizes will deviate very little from the ratio of the square of the depth, as determined by theory. There is however a small deficiency in the bigger beams.

We have been thus anxious in the examination of these experiments, because they are the only ones which have been related in sufficient detail, and made on a proper scale for giving us data from which we can deduce confidential maxims for practice. They are so troublesome and expensive that we have little hopes of seeing their number greatly increased; yet surely our navy board would do an unspeakable service to the public by appropriating a fund for such experiments under the management of some man of science.

There remains another comparison which is of chief importance, namely, the proportion between the ABSOLUTE COHESION and the RELATIVE STRENGTH. It may be guessed, from the very nature of the thing, that this must be very uncertain. Experiments on the absolute strength must be confined to very small pieces, by reason of the very great forces which are required for tearing them asunder. The values therefore deduced from them must be subject to great inequalities. Unfortunately we have got no detail of any experiments; all that we have to depend on is two passages of Mufchenbroek's *Essai de Physique*; in one of which he says that a piece of found oak $\frac{1}{2}$ inch of an inch square is torn asunder by 1150 pounds; and in the other, that an oak plank 12 inches broad and one thick will just suspend 180163 pounds. These give for the cohesion of an inch square 15755 and 15762 pounds. Bouguer, in his *Traité de Mécanique*, says that it is very well known that a rod of found oak one fourth of an inch square will be torn asunder by 1000 pounds. This gives 16000 for the cohesion of a square inch. We shall take this as a round number, easily used in our computations. Let us compare this with M. Buffon's trials of beams four inches square.

The absolute cohesion of this section is $16,000 \times 16 = 256,000$. Did every fibre exert its whole force in the instant of fracture, the momentum of cohesion would be the same as if it had all act'd at the centre of gravity of the section at 2 inches from the axis of fracture, and is therefore 512000. The 4-inch beam, 7 feet long, was broken by 5312 pounds hung on its middle. The half of this, or 2656 pounds, would have broken it, if suspended at its extremity, projecting $3\frac{1}{2}$ feet or 42 inches from a wall. The momentum of this strain is

therefore $2656 \times 42 = 111,552$. Now this is in equilibrium with the actual momentum of cohesion, which is therefore 111,552, instead of 512000. The strength is therefore diminished in the proportion of 512000 to 111,552, or very nearly of 4.59 to 1.

As we are quite uncertain as to the place of the centre of effort, it is needless to consider the full cohesion as acting at the centre of gravity, and producing the momentum 512,000; and we may convert the whole into a simple multiplier m of the length, and say, as m times the length is to the depth, so is the absolute cohesion of the section to the relative strength. Therefore let the absolute cohesion of a square inch be called f , the breadth b , the depth d , and the length l (all in inches), the relative strength, or the external force p , which balances

it, is $\frac{f b d^2}{9.15 l}$, or in round numbers $\frac{f b d^2}{9 l}$; for $m = 2 \times 4.59$.

This great diminution of strength cannot be wholly accounted for by the inequality of the cohesive forces exerted in the instant of fracture; for in this case we know that the centre of effort is at $\frac{1}{3}$ of the height in a rectangular section (because the forces really exerted are as the extensions of the fibres). The relative strength would be $\frac{f b a^2}{3 l}$, and p would have been 8127 instead

of 2656.

We must ascribe this diminution (which is three times greater than that produced by the inequality of the cohesive forces) to the compression of the under part of the beam; and we must endeavour to explain in what manner this compression produces an effect which seems so little explicable by such means.

As we have repeatedly observed, it is a matter of nearly universal experience that the forces actually exerted by the particles of bodies, when stretched or compressed, are very nearly in the proportion of the distances to which the particles are drawn from their natural positions. Now, although we are certain that, in enormous compressions, the forces increase faster than in this proportion, this makes no sensible change in the present question, because the body is broken before the compressions have gone so far; nay, we imagine that the compressed parts are crippled in most cases even before the extended parts are torn asunder. Mufchenbroek asserts this with great confidence with respect to oak, on the authority of his own experiments. He says, that although oak will suspend half as much again as fir, it will not support, as a pillar, two-thirds of the load which fir will support in that form.

We imagine therefore that the mechanism in the present case is nearly as follows:

Let the beam DCK Δ (fig. 27.) be loaded at its extremity with the weight P, acting in the direction KP perpendicular to DC. Let D Δ be the section of fracture. Let DA be about one-third of D Δ . A will be the particle or fibre which is neither extended nor compressed. Make $\Delta \delta : D \delta :: DA : A \Delta$. The triangles D $\Delta \delta$, $\Delta \delta A$, will represent the accumulated attracting and repelling forces. Make AI and A $\delta :: \frac{1}{2} DA$ and $\frac{1}{2} \Delta A$. The point I will be that to which the full cohesion D δ or f of the particles in AD must be applied, so as to produce the same momentum which the variable forces at I, D, &c. really produce at their several points

Strength of application. In like manner, I is the centre of similar effort of the repulsive forces excited by the compression between A and Δ , and it is the real fulcrum of a bended lever $I K$, by which the whole effect is produced. The effect is the same as if the full cohesion of the stretched fibres in AD were accumulated in I , and the full repulsion of all the compressed fibres in $A \Delta$ were accumulated in K . The forces which are balanced in the operation are the weight P , acting by the arm $I K$, and the full cohesion of AD acting by the arm $I \Delta$. The forces exerted by the compressed fibres between A and Δ only serve to give support to the lever, that it may exert its strain.

We imagine that this does not differ much from the real procedure of nature. The position of the point A may be different from what we have deduced from Mr Buffon's experiments, compared with Muschebrook's value of the absolute cohesion of a square inch. If this last should be only 12000, DA must be greater than we have here made it, in the proportion of 12000 to 16000. For $I \Delta$ must still be made $\frac{1}{4} A \Delta$, supposing the forces to be proportional to the extensions and compressions. There can be no doubt that a part only of the cohesion of $D \Delta$ operates in resisting the fracture in all substances which have any compressibility; and it is confirmed by the experiments of Mr Du Hamel on willow, and the inference are by no means confined to that species of timber. We say therefore, that when the beam is broken, the cohesion of AD alone is exerted, and that each fibre exerts a force proportional to its extension; and the accumulated momentum is the same as if the full cohesion of AD were acting by the lever $I \Delta$, $\frac{1}{4}$ of $D \Delta$.

It may be said, that if only one-third of the cohesion of oak be exerted, it may be cut two-thirds through without weakening it. But this cannot be, because the cohesion of the whole is employed in preventing the lateral slide so often mentioned. We have no experiments to determine that it *may not* be cut through one-third without loss of its strength.

This must not be considered as a subject of mere speculative curiosity. It is intimately connected with all the practical uses which we can make of this knowledge; for it is almost the only way that we can learn the compressibility of timber. Experiments on the direct cohesion are indeed difficult, and exceedingly expensive if we attempt them in large pieces. But experiment on compression are almost impracticable. The most instructive experiments would be, first to establish, by a great number of trials, the transverse force of a modern batten; and then to make a great number of trials on the diminution of its strength, by cutting it through on the concave side. This would very nearly give us the proportion of the cohesion which really operates in resisting fractures. Thus if it be found that one-half of the beam may be cut on the under side without diminution of its strength (taking care to drive in a slice of harder wood), we may conclude that the point A is at the middle, or somewhat above it.

Much lies before the curious mechanic, and we are as yet very far from a scientific knowledge of the strength of timber.

In the mean time, we may derive from these experiments of Buffon a very useful practical rule, without relying on any value of the absolute cohesion of oak. We

see that the strength is nearly as the breadth, as the square of the depth, and as the inverse of the length. It is most convenient to measure the breadth and depth of the beam in inches, and its length in feet. Since, $\frac{117}{1}$ then, a beam four inches square and seven feet between the supports is broken by 5312 pounds, we must conclude that a batten one inch square and one foot between the supports will be broken by 581 pounds. Then the strength of any other beam of oak, or the weight which will just break it when hung on its middle, is $581 \frac{b d^2}{l}$.

But we have seen that there is a very considerable deviation from the inverse proportion of the lengths, and we must endeavour to accommodate our rule to this deviation. We found, that by adding 1245 to each of the ordinates or numbers in the column of the five-inch bars, we had a set of numbers very nearly reciprocal of the lengths; and if we make a similar addition to the other columns in the proportion of the cubes of the sixes, we have nearly the same result. The greatest error (except in the case of experiments which are very irregular) does not exceed $\frac{1}{15}$ th of the whole. Therefore, for a radical number, add to the 5312 the number 640, which is to 1245 very nearly as 40 to 31. This gives 5952. The 64th of this is 93, which corresponds to a bar of one inch square and seven feet long. Therefore 93×7 will be the reciprocal corresponding to a bar of one foot. This is 651. Take from this the present empirical correction, which is $\frac{b d^2}{l}$, or 10, and there remains 641 for the strength of the bar. This gives us for a general rule $p = 651 \frac{b d^2}{l} - 10 b d^2$.

Example. Required the weight necessary to break an oak beam eight inches square and 20 feet between the props, $p = 651 \times \frac{8 \times 5^2}{20} - 10 \times 8 \times 5^2$. This is 11345, whereas the experiment gives 11357. The error is very small indeed. The rule is most deficient in comparison with the five-inch bars, which we have already said appear stronger than the rest.

The following process is easily remembered by such as are not algebraists.

Multiply the breadth in inches twice by the depth, and call this product f . Multiply f by 651, and divide by the length in feet. From the quotient take 10 times f . The remainder is the number of pounds which will break the beam.

We are not sufficiently sensible of our principles to be confident that the correction $10f$ should be in the proportion of the section, although we think it most probable. It is quite empirical, founded on Buffon's experiments. Therefore the safe way of using this rule is to suppose the beam square, by increasing or diminishing its breadth till equal to the depth. Then find the strength by this rule, and diminish or increase it for the change which has been made in its breadth. Thus, there can be no doubt that the strength of the beam given as an example is double of that of a beam of the same depth and half the breadth.

The reader cannot but observe that all this calculation relates to the very greatest weight which a beam will bear for a very few minutes. Mr Buffon uniformly found

Strength of
Materials

found that two-thirds of this weight sensibly impaired its strength, and frequently broke it at the end of two or three months. One-half of this weight brought the beam to a certain bend, which did not increase after the first minute or two, and may be borne by the beam for any length of time. But the beam contracted a bend, of which it did not recover any considerable portion. One-third seemed to have no permanent effect on the beam; but it recovered its reclinal shape completely, even after having been loaded several months, provided that the timber was seasoned when first loaded; that is to say, one-third of the weight which would quickly break a seasoned beam, or one-fourth of what would break one just felled, may lie on it for ever without giving the beam a set.

We have no detail of experiments on the strength of other kinds of timber: only Mr Buffon says, that fir has about $\frac{2}{3}$ ths of the strength of oak; Mr Parent makes it $\frac{1}{2}$ ths; Emcrien, $\frac{3}{4}$ ths, &c.

We have been thus minute in our examination of the mechanism of this transverse strain, because it is the greatest to which the parts of our machines are exposed. We wish to impress on the minds of artists the necessity of avoiding this as much as possible. They are improving in this respect, as may be seen by comparing the centres on which stone arches of great span are now turned with those of former times. They were formerly a load of mere joists resting on a multitude of posts, which obstructed the navigation, and were frequently losing their shape by some of the posts sinking into the ground. Now they are more generally trusses, where the beams abut on each other, and are relieved from transverse strains. But many performances of eminent artists are still very injudiciously exposed to cross strains. We may instance one which is considered as a fine work, viz. the bridge at Walton on Thames. Here every beam of the great arch is a joint, and it hangs together by framing. The finest piece of carpentry that we have seen is the centre employed in turning the arches of the bridge at Orleans, described by Perronet. In the whole there is not one cross strain. The beam, too, of Hornblower's steam-engine, described in that article, is very scientifically constructed.

118
Strain produced by twisting.
119
The resistance must be in proportion to the number of particles.

IV. The last species of strain which we are to examine is that produced by twisting. This takes place in all axes which connect the working parts of machines.

Although we cannot pretend to have a very distinct conception of that modification of the cohesion of a body by which it resists this kind of strain, we can have no doubt that, when all the particles act alike, the resistance must be proportional to the number. Therefore if we suppose the two parts ABCD, ABFE (fig. 28.) of the body EFCD to be of insuperable strength, but cohering more weakly in the common surface AB, and that one part ABCD is pushed laterally in the direction AB, there can be no doubt that it will yield only there, and that the resistance will be proportional to the surface.

Fig. 28.

In like manner, we can conceive a thin cylindrical tube, of which KAH (fig. 20.) is the section, as cohering more weakly in that section than anywhere else. Suppose it to be grafed in both ends, and the two parts twisted round the axis in opposite directions, as we would twist the two joints of a flute, it is plain that it will first fail in this section, which is the circumference

Fig. 29.

of a circle, and the particles of the two parts which are contiguous to this circumference will be drawn from each other laterally. The total resistance will be as the number of equally resisting particles, that is, as the circumference (for the tube being supposed very thin, there can be no sensible difference between the dilatation of the external and internal particles). We can now suppose another tube within this, and a third within the second, and so on till we reach the centre. If the particles of each ring exerted the same force (by suffering the same dilatation in the direction of the circumference), the resistance of each ring of the section would be as its circumference and its breadth (supposed indefinitely small, and the whole resistance would be as the surface; and this would represent the resistance of a solid cylinder. But when a cylinder is twisted in this manner by an external force applied to its circumference, the external parts will suffer a greater circular extension than the internal; and it appears that this extension (like the extension of a beam strained transversely) will be proportional to the distance of the particles from the axis. We cannot say that this is demonstrable, but we can assign no proportion that is more probable. This being the case, the forces simultaneously exerted by each particle will be as its distance from the axis. Therefore the whole force exerted by each ring will be as the square of its radius, and the accumulated force actually exerted will be as the cube of the radius; that is, the accumulated force exerted by the whole cylinder, whose radius is CA, is to the accumulated force exerted at the same time by the part whose radius is CE, as CA³ to CE³.

The whole cohesion now exerted is just two-thirds of what it would be if all the particles were exerting the same attractive forces which are just now exerted by the particles in the external circumference. This is plain to any person in the least familiar with the fluxionary calculus. But such as are not may easily see it in this way.

Let the rectangle AC ea be set upright on the surface of the circle along the line CA, and revolve round the axis Ce. It will generate a cylinder whose height is Ce or Aa, and having the circle KAH for its base. If the diagonal Ca be supposed also to revolve, it is plain that the triangle eCa will generate a cone of the same height, and having for its base the circle described by the revolution of ea, and the point C for its apex. The cylindrical surface generated by Aa will express the whole cohesion exerted by the circumference AHK, and the cylindrical surface generated by e e will represent the cohesion exerted by the circumference ELM, and the solid generated by the triangle CAa will represent the cohesion exerted by the whole circle AHK, and the cylinder generated by the rectangle AC ea will represent the cohesion exerted by the same surface if each particle had suffered the extension Aa.

Now it is plain, in the first place, that the solid generated by the triangle e EC is to that generated by a AC as EC³ to AC³. In the next place, the solid generated by a AC is two-thirds of the cylinder, because the cone generated by e Ca is one-third of it.

We may now suppose the cylinder twisted till the particles in the external circumference lose their cohesion. There can be no doubt that it will now be wrenched asunder, all the inner circles yielding in succession. Thus we obtain one useful information, viz. that a body of homogeneous texture resists a simple twist with two-thirds

Strength of Materials. 110
 With what force a body of a homogeneous texture resists a simple twist.
 111
 The forces exerted in breaking two cylinders are as the squares of the diameters.
 112
 Relative strength of the section to the external force employed to break it.

thirds of the force with which it resists an attempt to force one part laterally from the other, or with one-third part of the force which will cut it asunder by a square-edged tool. For to drive a square-edged tool through a piece of lead, for instance, is the same as forcing a piece of the lead as thick as the tool laterally away from the two pieces on each side of the tool. Experiments of this kind do not seem difficult, and they would give us very useful information.

When two cylinders AHK and BNO are wrrenched asunder, we must conclude that the external particles of each are just put beyond their limits of cohesion, are equally extended, and are exerting equal forces. Hence it follows, that in the instant of fracture the sum total of the forces actually exerted are as the squares of the diameters.

For drawing the diagonal Ce , it is plain that $Ee = Aa$, expresses the distension of the circumference ELM, and that the solid generated by the triangle CEe expresses the cohesion, exerted by the surface of the circle ELM, when the particles in the circumference suffer the extension Ee equal to Aa . Now the solids generated by CAa and CEe being respectively two-thirds of the corresponding cylinders, are as the squares of the diameters.

Having thus ascertained the real strength of the section, and its relation to its absolute lateral strength, let us examine its strength relative to the external force employed to break it. This examination is very simple in the case under consideration. The straining force must act by some lever, and the cohesion must oppose it by acting on some other lever. The centre of the section may be the neutral point, whose position is not disturbed.

Let F be the force exerted laterally by an exterior particle. Let a be the radius of the cylinder, and x the indeterminate distance of any circumference, and \dot{x} the indefinitely small interval between the concentric circles; that is, let \dot{x} be the breadth of a ring and x its radius. The forces being as the extensions, and the extensions as the distances from the axis, the cohesion actually exerted at any part of any ring will be $f \frac{x \dot{x}}{a}$. The force exerted by the whole ring (being as the circumference or as the radius) will be $f \frac{x^2 \dot{x}}{a}$. The momentum of cohesion of a ring, being as the force multiplied by its lever, will be $f \frac{x^3 \dot{x}}{a}$. The accumulated momentum will be the sum or fluent of $f \frac{x^3 \dot{x}}{a}$; that is, when $x = a$, it will be $\frac{1}{2} f a^3 = \int f a^3$.

113
 The resistance of the axle is as the cube of its diameter.

Hence we learn that the strength of an axle, by which it resists being wrrenched asunder by a force acting at a given distance from the axis, is as the cube of its diameter.

But farther, $\frac{1}{2} f a^3 = f a^2 \times \frac{1}{2} a$. Now $f a^2$ represents the full lateral cohesion of the section. The momentum therefore is the same as if the full lateral cohesion were accumulated at a point distant from the axis

by one-fourth of the radius or one-eighth of the diameter of the cylinder.

Therefore let F be the number of pounds which measures the lateral cohesion of a circular inch, d the diameter of the cylinder in inches, and l the length of the lever by which the straining force ρ is supposed to act, we shall have $F \times \frac{1}{8} d^3 = \rho l$, and $\Gamma \frac{d^3}{8 l} = \rho$.

We see in general that the strength of an axle, by which it resists being wrrenched asunder by twisting, is as the cube of its diameter.

We see also that the internal parts are not acting so powerfully as the external. If a hole be bored out of the axle of half its diameter, the strength is diminished only one-eighth, while the quantity of matter is diminished one-fourth. Therefore hollow axles are stronger than solid ones containing the same quantity of matter. Thus let the diameter be 5 and that of the hollow 4: then the diameter of another solid cylinder having the same quantity of matter with the tube is 3. The strength of the solid cylinder of the diameter 5 may be expressed by 5³ or 125. Of this the internal part (of the diameter 4) exerts 64; therefore the strength of the tube is 125 - 64 = 61. But the strength of the solid axle is the same quantity of matter and diameter 3 is 3³, or 27, which is not half of that of the tube.

Engineers, therefore, have of late introduced this improvement in their machines, and the axles of cast iron are all made hollow when their size will admit it. They have the additional advantage of being much stiffer, and of affording much better fixture for the flanches, which are used for connecting them with the wheels or levers by which they are turned and strained. The superiority of strength of hollow tubes over solid cylinders is much greater in this kind of strain than in the former or transverse. In this last case the strength of this tube would be to that of the solid cylinder of equal weight as 64 to 32 and a half nearly.

The apparatus which we mentioned on a former occasion for trying the lateral strength of a square inch of solid matter, enabled us to try this theory of twist with all desirable accuracy. The bar which hung down from the pin in the former trials was now placed in a horizontal position, and loaded with a weight at the extremity. Thus it acted as a powerful lever, and enabled us to wrench asunder specimens of the strongest materials. We found the results perfectly conformable to the theory, in as far as it determined the proportional strength of different sizes and forms: but we found the ratio of the resistance to twisting to the simple lateral resistance considered different; and it was some time before we discovered the cause.

We had here taken the simplest view that is possible of the action of cohesion in resisting a twist. It is frequently exerted in a very different way. When, for instance, an iron axle is joined to a wooden one by being driven into one end of it, the extensions of the different circles of particles are in a very different proportion. A little consideration will show that the particles in immediate contact with the iron axle are in a state of violent extension; so are the particles of the exterior surface of the wooden part, and the intermediate parts are left strained. It is almost impossible to align the exact proportion of the cohesive forces exerted in the different

Strength of Materials.

114
 Hollow axles more proper than solid ones.

115
 and now generally used.

116
 The ratio of resistance to twisting to the simple lateral resistance appears different.

Strength of
Materials.127
But when
the experi-
ment was
altered, it
was exact-
ly the
same.128
Experi-
ments on
chalk, clay,
and wax,
satisfac-
tory; but
those on
timber in-
regular.129
Concluding
remarks.

parts. Numberless cases can be pointed out where parts of the axle are in a state of compression, and where it is still more difficult to determine the state of the other particles. We must content ourselves with the deductions made from this simple case, which is fortunately the most common. In the experiments just now mentioned the centre of the circle is by no means the neutral point, and it is very difficult to ascertain its place; but when this consideration occurred to us, we easily freed the experiments from this uncertainty, by extending the lever to both sides, and by means of a pulley applied equal force to each arm, acting in opposite directions. Thus the centre became the neutral point, and the resistance to twist was found to be two-thirds of the simple lateral strength.

We beg leave to mention here that our success in these experiments encouraged us to extend them much farther. We hoped by these means to discover the absolute cohesion of many substances, which would have required an enormous apparatus and a most unmanageable force to tear them asunder directly. But we could reason with confidence from the resistance to twist (which we could easily measure), provided that we could ascertain the proportion of the direct and the lateral strengths. Our experiments on chalk, finely prepared clay, and white bees-wax (of one melting and one temperature), were very consistent and satisfactory. But we have hitherto found great irregularities in this proportion in bodies of a fibrous texture like timber. These are the most important cases, and we still hope to be able to accomplish our project, and to give the public some valuable information. This being our sole object, it was our duty to mention the method which promises success, and thus excite others to the task; and it will be so mortification to us to be deprived of the honour of being the first who thus adds to the stock of experimental knowledge.

When the matter of the axle is of the most simple texture, such as that of metals, we do not conceive that the length of the axle has any influence on the fracture. It is otherwise if it be of a fibrous texture like timber: the fibres are bent before breaking, being twisted into spirals like a cork-screw. The length of the axle has somewhat of the influence of a lever in this case, and it is easier wrenched asunder if long. Accordingly we have found it so; but we have not been able to reduce this influence to calculation.

Our readers are requested to accept of these endeavours to communicate information on this important and difficult subject. We are duly sensible of their imperfection, but flatter ourselves that we have in many instances pointed out the method which must be pursued for improving our knowledge on this subject; and we have given the English reader a more copious list of experiments on the strength of materials than he will meet with in our language. Many useful deductions might be made from these premises respecting the manner of disposing and combining the strength of materials in our structures. The best form of joints, mortises, tenons, scarpes; the rules for joggling, tabling, laying, filling, &c. practised in the delicate art of mill making, are all founded on this doctrine: but the discussion of these would be equivalent to writing a complete treatise of carpentry. We hope that this will be executed by some intelligent mechanic, for there is nothing in our language on this subject but what is almost contemptible;

yet there is no mechanic art that is more susceptible of scientific treatment. Such a treatise, if well executed, could not fail of being well received by the public in this age of mechanical improvement.

Strength-
ness
of
Striking.

STRENGTHENERS, or CORROBORANTS, such medicines as are supposed to add to the firmness of the fluids. See MATERIA MEDICA Index.

STRETCHING, in Navigation, is generally understood to imply the progression of a ship under a great surface of sail, when close-hauled. The difference between this term and *standing*, consists apparently in the quantity of sail; which in the latter may be very moderate; but stretching generally signifies excess; as, we saw the enemy at daybreak stretching to the southward under a crowd of sail, &c. *Falcons*.

STRETTO, in Italian music, is sometimes used to signify that the measure is to be short and concise, and consequently quick. In this sense it stands opposed to LARGO.

STRATLED LEAF, among botanists, one that has a number of longitudinal furrows on its surface.

STRIKE, a measure of capacity, containing four bushels. Also an instrument used in measuring corn.

STRIX, the OWL; a genus of birds belonging to the order of accipitres. See ORNITHOLOGY Index.

The *lubo*, or great-eared owl inhabits inaccessible rocks and desert places, and preys on hares and feathered game. Its appearance in cities was deemed an unlucky omen; Rome itself once underwent a lustration because one of them strayed into the capitol. The ancients had them in the utmost abhorrence; and thought them, like the screech-owls, the messengers of death. Pliny styles it *lubo funebris*, and *noctis monstrum*.

*Solaque culminibus serali carmine bubo
Sape queri et longas in flumina ducere voces.* VIRGIL.

Perch'd on the roof, the bird of night complains,
In lengthen'd shrieks and dire funeral strains.

STROBILUS, in Botany, a pericarp formed from an amentum by the hardening of the scales.

STROKING, or rubbing gently with the hand, a method which has been employed by some persons for curing diseases.

Mr Greatrakes or Greatrix, the famous Irish stroker, is said to have performed many wonderful cures. He gives the following account of his discovery of this art, and of the success with which he practised it. "About See Brief Account of Mr Valentine Greatrakes, Lond. 1666, 4to.
1662 I had an impulse (says he), or a strange persuasion in my own mind (of which I am not able to give any rational account to another), which did very frequently suggest to me, that there was bestowed on me the gift of curing the king's evil; which, for the extraordinary nature of it, I thought fit to conceal for some time; but at length I communicated this to my wife, and told her, that I did verily believe that God had given me the blessing of curing the king's evil; for whether I were in private or public, sleeping or waking, still I had the same impulse. But her reply to me was, that the conceived this was a strange imagination; yet, to prove the contrary, a few days after there was one William Mather of Salterbridge in the parish of Lismore, who brought his son William to my house, desiring my wife to cure him, who was a person ready to afford her charity to her neighbours, according to her small skill in chirurgery.

Fig. 1.

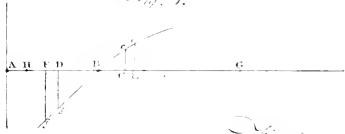

Fig. 2.

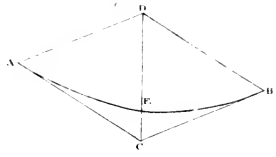

Fig. 3.

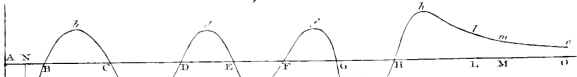

Fig. 5.

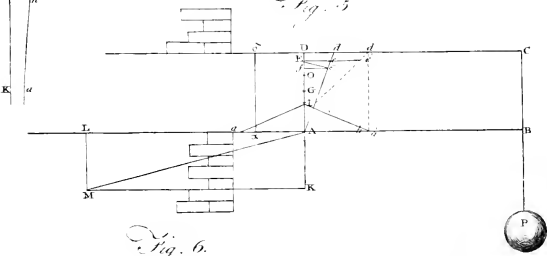

Fig. 4.

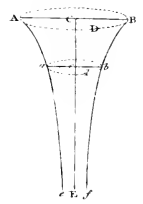

Fig. 6.

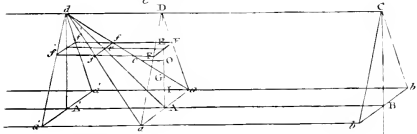

Fig. 8.

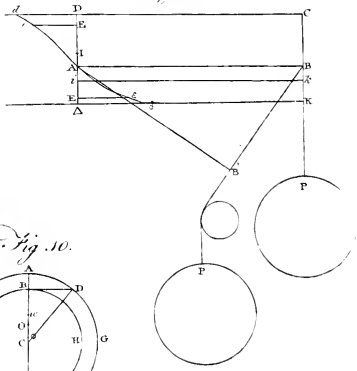

Fig. 7.

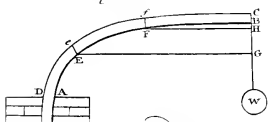

Fig. 9.

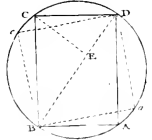
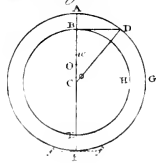

Fig. 10.



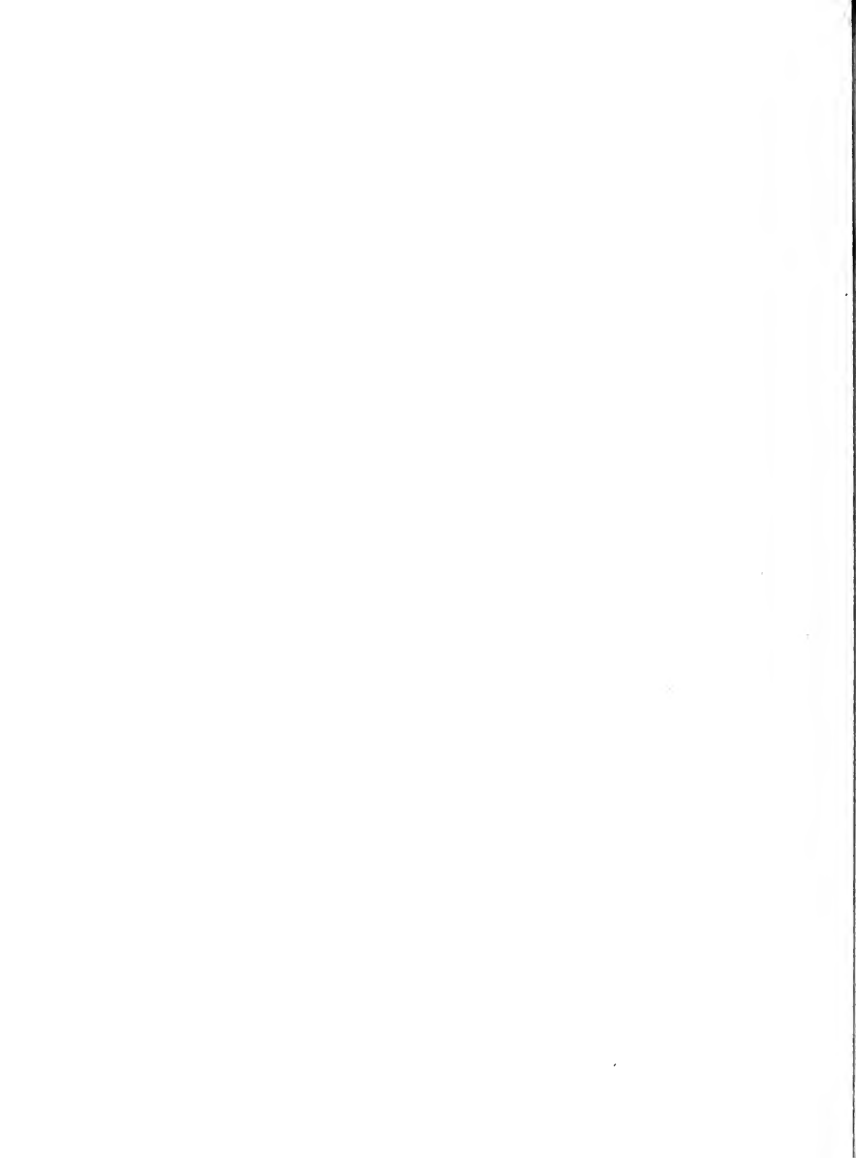

Fig. 11.

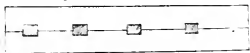

Fig. 12.

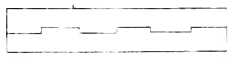

Fig. 14.

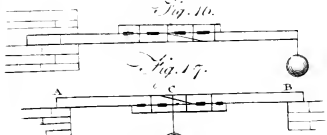

Fig. 16.

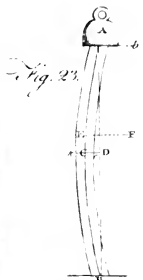
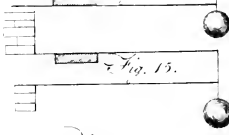

Fig. 18.

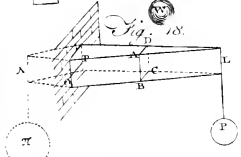

Fig. 19.

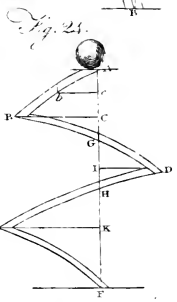
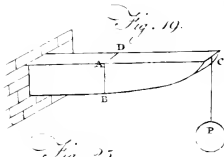

Fig. 21.

Fig. 22.

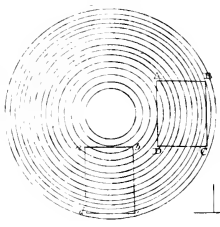
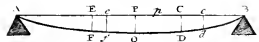

Fig. 24.

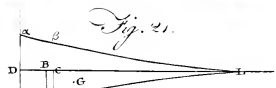

Fig. 25.

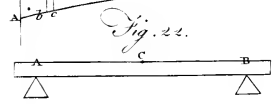

Fig. 26.

Fig. 27.

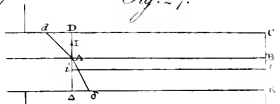

Fig. 28.

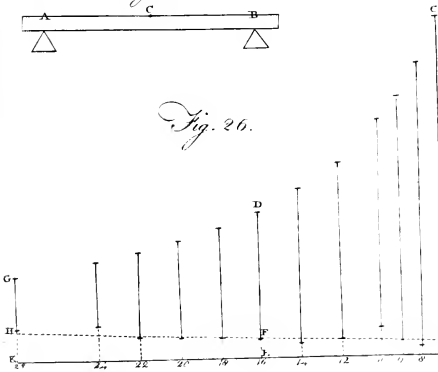

Fig. 29.

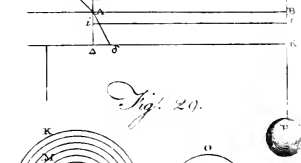
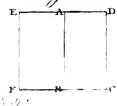
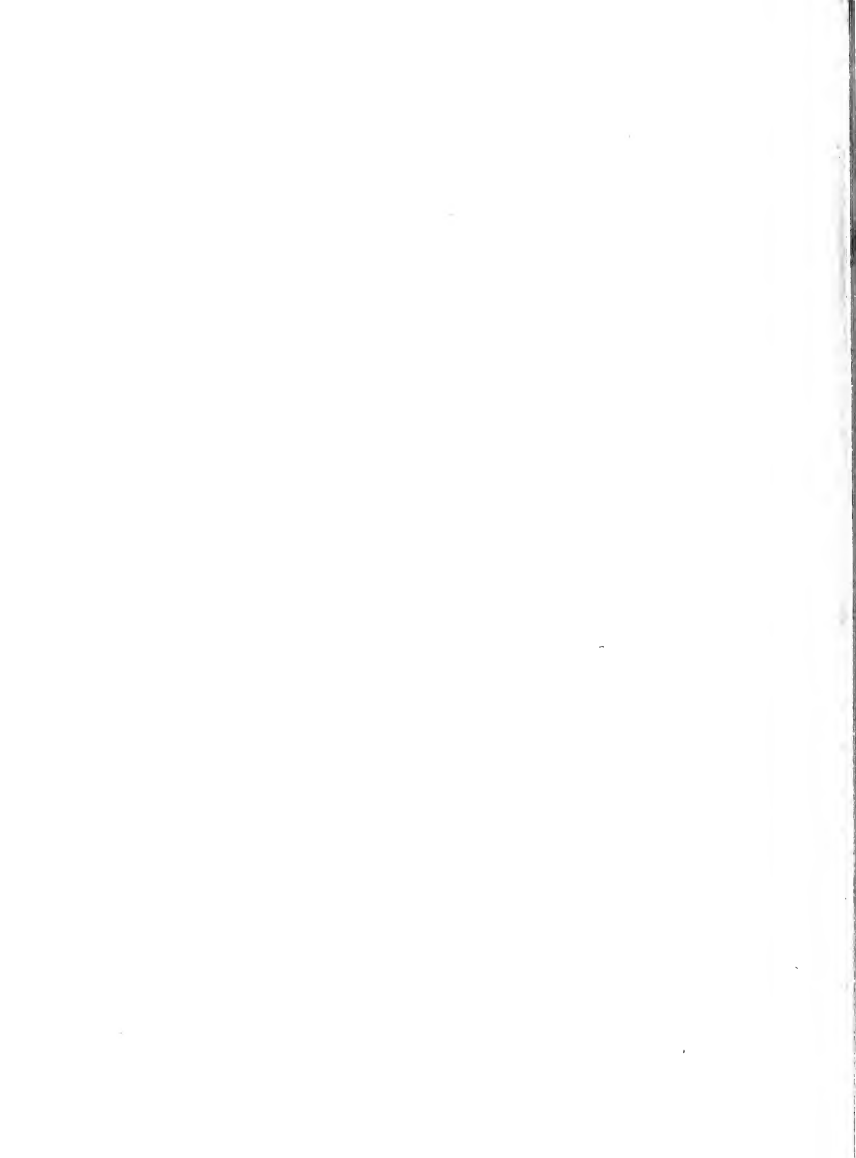

Fig. 30.





Strokmg
||
Stromboli.

chirurgery. On which my wife told me, there was one that had the king's evil very grievously in the eyes, cheek, and throat; whereupon I told her, that she should now see whether this was a bare fancy or imagination, as she thought it, or the dictates of God's Spirit on my heart. Then I laid my hands on the places affected, and prayed to God for Jesus sake to heal him; and bid the parent two or three days afterwards to bring the child to me again, which accordingly he did; and I then saw the eye was almost quite whole; and the node, which was almost as big as a pullet's egg, was suppurated; and the throat strangely amended; and, to be brief (to God's glory I speak it) within a month discharged itself quite, and was perfectly healed, and fo continues, God be praised."

Then there came to him one Margaret Mackthane of Ballineely, in the parish of Liffmore, who had been afflicted with the evil above seven years, in a much more violent degree; and soon after, his fame increasing, he cured the lame disease in many other persons for three years. He did not meddle all this time with any other dilemper; till about the end of these three years, the ague growing epidemical, he found, as formerly, that there was bestowed on him the gift of curing that disease. He cured Colonel Phaire, of Cahrimony in the county of Corke, of an ague, and afterwards many other persons of different dilempers, by stroking; so that his name was wonderfully cried up, as if some divine person had been sent from above. January 1665-6, he came over to England, at the request of the earl of Orrery; in order to cure the lady of the lord-viscount Conway, of Ragley in Warwickshire, who had for many years laboured under a most violent headache. He staid at Ragley three weeks or a month; and though he failed in his endeavours to relieve that lady, he cured vast numbers of people in those parts and at Worcester.

Though we are no friends to the marvellous, nor believe it possible that either the king's evil or ague can be cured by stroking or friction of any kind, whether gentle or severe, we have no hesitation to acknowledge that many cures might be performed by Mr Greatrakes. Every reflecting person who reads the foregoing account which he gives of himself will see that he was an enthusiast, and believed himself guided by a particular revelation; and such is the credulity of mankind, that his pretensions were readily admitted, and men crowded with eagerness to be relieved of their diseases. But it is well known to physicians, that in many cases the imagination has accomplished cures so wonderful as the force of medicine. It is owing chiefly to the influence of imagination that we have so many accounts from people of veracity of the wonderful effects of quack medicines. We are perfectly assured that these medicines, by their natural operation, can never produce the effects ascribed to them; for there is no kind of proportion between the medicine and the effect produced, and often no connection between the medicine and the disease.

STROMATEUS, a genus of fishes belonging to the order of acodes. See ICHTHYOLOGY Index.

STROMBOLI, the most northern of the Lipari islands. It is a volcano, which constantly discharges much fire and smoke. It rises in a conical form above the surface of the sea. On the east side it has three or four little craters ranged near each other, not at the

summit, but on the declivity, nearly at two-thirds of its height. But as the surface of the volcano is very rugged and intersected with hollow ways, it may be naturally concluded, that at the time of some great eruption, the summit and a part of this side fell in, as must have happened also to Vesuvius; consequently, the common chance is at this day on the declivity, although always in the centre of the whole base. It is inhabited notwithstanding its fires; but care is taken to avoid the proximity of the crater, which is yet much to be feared. "I was assured (says M. de Luc) by an Englishman, who, like me, had the curiosity to visit these isles, that the fine weather having invited him and his company to land at Stromboli, they ascended a volcano, whose craters at that time threw out nothing; but that while they were attentively viewing them, unapprehensive of any danger, they were suddenly saluted by such a furious discharge, as to be obliged to retreat with precipitation, and not without one of the company being wounded by a piece of scoria." Of all the volcanoes recorded in history, Stromboli seems to be the only one that burns without ceasing. Etna and Vesuvius often lie quiet for many months, and even years, without the least appearance of fire; but Stromboli is ever at work, and for ages past has been looked upon as the great lighthouse of these seas. E. Long. 15. 45. N. Lat. 35. 0.

STROMBUS, a genus of shell-fish. See CONCHOLGY Index.

STRONGOLI, a town of the kingdom of Naples, with a bishop's see. It is situated on a rugged mountain, is about three miles from the sea, and eleven north from St Severino. It is supposed to be the ancient *Petelia*, which made a conspicuous figure in the second Punic war by its obstinate resistance against Hannibal. Near its walls Marcellus the rival of Hannibal was slain in a skirmish. E. Long. 17. 26. N. Lat. 39. 20.

STRONTITES, or STRONTIAN EARTH, so called from having been discovered at Strontian in Scotland. See CHEMISTRY Index.

STROPHE, in ancient poetry, a certain number of verses, including a perfect sense, and making the first part of an ode. See POLTRY, N^o 130.

STRUMLE, scrophulous tumours arising on the neck and throat, constituting what is commonly called the king's evil. See MEDICINE Index.

STRUMPELLA, a genus of plants belonging to the class syngenesia. See BOTANY Index.

STRUTHIO, a genus of birds belonging to the order of galline. See ORNITHOLOGY Index.

STRUTHIOLA, a genus of plants belonging to the class of tetrandria. See BOTANY Index.

STRYCHNOS, a genus of plants belonging to the class pentandria, and in the natural system ranging under the 28th order, *luridee*. See BOTANY Index.

STRYMON, in *Ancient Geography*, formerly *Cozasus*; a river constituting the ancient limits of Macedonia and Thrace; rising in Mount Scombrus (Aristotle). Authors differ as to the modern name of this river.

STRYPE, JOHN, was descended from a German family, born at London, and educated at Cambridge. He was vicar of Low Layton in Essex, and distinguished himself by his compilations of Lives and Memoirs; in which, as Dr Birch remarks, his fidelity and industry will always give a value to his writings, however deli-

Stuart.

tute they may be of the graces of style. He died in 1757, after having enjoyed his vicarage near 68 years.

STUART, DR GILBERT, was born at Edinburgh in the year 1742. His father Mr George Stuart was professor of humanity in the university, and a man of considerable eminence for his classical taste and literature. For these accomplishments he was probably indebted in no small degree to his relation the celebrated Ruddiman, with whom both he and his son conversed familiarly, though they afterwards united to injure his fame.

Gilbert having finished his classical and philosophical studies in the grammar school and university, applied himself to jurisprudence, without following, or probably intending to follow, the profession of the law. For that profession he has been represented as unqualified by indolence; by a passion which at a very early period of life he displayed for general literature; and by boundless dilipation:—and all these circumstances may have contributed to make him relinquish pursuits in which he could hope to succeed only by patient perseverance and strict decorum of manners. That he did not waste his youth in idleness, is, however, evident from An Historical Dissertation concerning the Antiquity of the British Constitution, which he published before he had completed his twenty-second year, and which had so much merit as to induce the university of Edinburgh to confer upon the author, though so young a man, the degree of LL.D.

After a studious interval of some years, he produced a valuable work, under the title of A View of Society in Europe, in its Progress from Rudeness to Refinement; or, Inquiries concerning the History of Laws, Government, and Manners. He had read and meditated with patience on the most important monuments of the middle ages; and in this volume (which speedily reached a second edition) he aimed chiefly at the praise of originality and invention, and discovered an industry that is seldom connected with ability and discernment. About the time of the publication of the first edition of this performance, having turned his thoughts to an academical life, he asked for the professorship of public law in the university of Edinburgh. According to his own account he had been promised that place by the minister, but had the mortification to see the professorship bestowed on another, and all his hopes blasted by the influence of Dr Robertson, whom he represented as under obligations to him.

To the writer of this article, who was a stranger to these rival candidates for literary fame, this part of the story seems very incredible; as it is not easy to conceive how it ever could be in the power of Dr Stuart to render to the learned Principal any essential service. It was believed indeed by the earl of Buchan, and by others, who observed that the illiberal jealousy not infrequent in the world of letters, was probably the source of this oration; which entirely broke the intimacy of two persons who, before that time, were understood to be on the most friendly footing with each other. In particular, however, it was likely to have been the vice of Dr Stuart as of Dr Robertson; for we have been told by a writer*, who, at least in one instance, has completely proved what he asserts, that such was Gilbert Stuart's envy of pre-eminence as a man, that he considered ingratitude as one of the most venial sins; such was his

conceit as a writer, that he regarded no one's merits but his own; such were his disappointments, both as a writer and a man, that he allowed his peevishness to four into malice, and inaugurated his malevolence till it settled in corruption.⁷⁹

Soon after this disappointment, Dr Stuart went to London, where he became from 1768 to 1774 one of the writers of the Monthly Review. In 1772 Dr Adam, rector of the high-school at Edinburgh, published a Latin Grammar, which he intended as an improvement of the famous Ruddiman's. Stuart attacked him in a pamphlet under the name of *Bajby*, and treated him with much levity. In doing this, he was probably actuated more by some personal dislike of Dr Adam than by regard to the memory of his learned relation; for on other occasions he showed sufficiently that he had no regard to Ruddiman's honour as a grammarian, editor, or critic.

In 1774 he returned to his native city, and began the Edinburgh Magazine and Review, in which he discussed the liberty and constitution of England, and distinguished himself by an inquiry into the character of John Knox the reformer, whose principles he reprobated in the severest terms. About this time he revised and published Sullivan's Lectures on the Constitution of England. Soon after he turned his thoughts to the history of Scotland, and published Observations concerning its Public Law and Constitutional History; in which he examined with a critical care the preliminary book to Dr Robertson's History. His next work was The History of the Reformation; a book which deserves praise for the easy dignity of the narrative, and for strict impartiality. His last great work, The History of Scotland from the Establishment of the Reformation to the Death of Queen Mary, which appeared in 1782, has been very generally read and admired. His purpose was to vindicate the character of the injured Queen, and expose the weakness of the arguments by which Dr Robertson had endeavoured to prove her guilty; but though the style of this work is his own, it contains very little matter which was not furnished by Goodall and Tytler; and it is with the arms which these two writers put into his hands that Dr Stuart attacked his great antagonist.

In 1782 he once more visited London, and engaged in the Political Herald and English Review; but the jaundice and droop increasing on him, he returned by sea to his native country, where he died in the house of his father on the 13th of August 1786.

In his person Dr Stuart was about the middle size and justly proportioned. His countenance was modest and expressive, sometimes glowing with sentiments of friendship, of which he was truly susceptible, and at others darting that satiric and indignation at folly and vice which appear in some of his writings. He was a boon companion; and, with a constitution that might have stood the shock of ages, he fell a premature martyr to intemperance. His talents were certainly great, and his writings are useful; but he seems to have been influenced more by passion than by prejudice, and in his character there was not much to be imitated.

STUCCO, in building, a composition of white marble pulverised, and mixed with plaster of lime; and the whole being sifted and wrought up with water, is to be used like common plaster: this is called by Pliny *mar-maratum opus*, and *allurium opus*.

* *Chalmers in the Life of Goodall*.

Stucco.

A patent has been granted to Mr B. Higgins for inventing a new kind of stucco, or water-cement, more firm and durable than any heretofore. Its composition, as extracted from the specification signed by himself, is as follows: "Drift-sand, or quarry (A) sand, which consists chiefly of hard quartose flat-faced grains with sharp angles; which is the best, or may be most easily freed by washing, from clay, salts, and calcareous, pyro-feous, or other grains less hard and durable than quartz; which contains the smallest quantity of pyrites or heavy metallic matter separable by washing; and which suffers the smallest diminution of its bulk in washing in the following manner—is to be preferred before any other. And where a coarse and a fine sand of this kind, and corresponding in the size of their grains with the coarse and fine sands hereafter described, cannot be easily procured, let such sand of the foregoing quality be chosen as may be sorted and cleaned in the following manner:

"Let the sand be sifted in streaming clear water, through a sieve which shall give passage to all such grains as do not exceed one-sixteenth of an inch in diameter; and let the stream of water and the sifting be regulated so that all the sand, which is much finer than the Lyn-sand commonly used in the London glass-houses, together with clay and every other matter specifically lighter than sand, may be washed away with the stream, while the purer and coarser sand, which passes through the sieve, subsides in a convenient receptacle, and whilst the coarse rubbish and rubble remain on the sieve to be rejected.

"Let the sand which thus subsides in the receptacle be washed in clean streaming water through a finer sieve, so as to be further cleaned and sorted into two

parcels, which will remain in the sieve which is to give passage to such grains of sand only as are less than one-thirtieth of an inch in diameter, and which is to be saved apart under the name of *coarse sand*; and a finer, which will pass through the sieve and subside in the water, and which is to be saved apart under the name of *fine sand*.—Let the coarse and the fine sand be dried separately, either in the sun or on a clean iron-plate, let on a convenient surface, in the manner of a sand-heat (B).

"Let lime be chosen (C) which is stone-lime, which heats the most in flaking, and which the quickest when dust watered; which is the best made and clearest kept; which dissolves in distilled vinegar with the least effervescence, and leaves the smallest residue of scale, and in this residue the smallest quantity of clay, gypsum, or martial matter.

"Let the lime chosen according to these important rules be put in a brass-wired sieve to the quantity of 14 pounds. Let the sieve be finer than either of the foregoing; the finer, the better it will be: let the lime be flaked (D) by plunging it in a butt filled with soft water, and raising it out quickly and suffering it to heat and fume, and by repeating this plunging and raising alternately, and agitating the lime, until it be made to pass through the sieve into the water; and let the part of the lime which does not easily pass through the sieve be rejected: and let fresh portions of the lime be thus used, until as many (E) ounces of lime have passed through the sieve as there are quarts of water in the butt. Let the water thus imregnated stand in the butt closely covered (F) until it becomes clear; and through wooden (G) corks placed at different heights in the butt, let the clear liquor be drawn off as fast (H) and as

5 G 2

as

(A) "This is commonly called *pit-sand*.

(B) "The sand ought to be stirred up continually until it is dried, and is then to be taken off; for otherwise the evaporation will be very slow, and the sand which lies next the iron plate, by being overheated, will be discoloured.

(C) "The preference given to stone-lime is founded on the present practice in the burning of lime, and on the closer texture of it, which prevents it from being so soon injured by exposure to the air as the more spongy chalk-lime is; not on the popular notion that stone-lime has something in it whereby it excels the best chalk in the cementing properties. The gypsum contained in stone-lime remains unaltered, or very little altered, in the lime, after the burning; but it is not to be expected that clay or martial matter should be found in their native state in well-burned lime; for they concrete or vitrify with a part of the calcareous earth, and constitute the hard grains or lumps which remain undissolved in weak acids, or are separable from the flaked lime by sifting it immediately through a sieve.

(D) "This method of imregnating the water with lime is not the only one which may be adopted. It is, however, preferred before others, because the water clears the sooner in consequence of its being warmed by the flaking lime; and the gypseous part of the lime does not diffuse itself in the water so freely in this way as it does when the lime is flaked to fine powder in the common method, and is then blended with the water; for the gypseous part of the lime flakes at first into grains rather than into fine powder, and will remain on the sieve after the pure lime has passed through, long enough to admit of the intended fermentation; but when the lime is otherwise flaked, the gypseous grains have time to flake to a finer powder, and passing through the sieve, dissolve in the water along with the lime. I have imagined that other advantages attended this method of preparing the lime-water, but I cannot yet speak of them with precision.

(E) "If the water contains no more acidulous gas than is usually found in river or rain water, a fourth part of this quantity of lime, or less, will be sufficient.

(F) "The calcareous crust which forms on the surface of the water ought not to be broken, for it assists in excluding the air, and preventing the absorption of acidulous gas whereby the lime-water is spoiled.

(G) "Brass-corks are apt to colour a part of the liquor.

(H) "Lime-water cannot be kept many days unimpaired, in any vessels that are not perfectly air-tight. If the liquor be drawn off before it clears, it will contain whitening, which is injurious; and if it be not instantly

used

Stucco.

as low as the lime subsides, for use. This clear liquor I call the *cementing liquor* (I). The freer the water is from saline matter, the better will be the cementing liquor made with it.

" Let 36 pounds of the aforesaid chofin lime be flaked, by gradually sprinkling on it, and especially on the unflaked pieces, the cementing liquor, in a close (K) clean place. Let the flaked part be immediately (L) sifted through the last-mentioned fine brass-wired sieve: Let the lime which passes be used instantly, or kept in air-tight vessels, and let the part of the lime which does not pass through the sieve be rejected (M).— This finer richer part of the lime which passes through the sieve I call *purified lime*.

" Let bone-ash be prepared in the usual manner, by grinding the whitest burnt bones, but let it be sifted, to be much finer than the bone-ash commonly sold for making cupels.

" The most eligible materials for making my cement being thus prepared, take 36 pounds of the coarse sand and 42 pounds of the fine sand; mix them on a large plank of hard wood placed horizontally; then spread the sand so that it may stand to the height of six inches, with a flat surface on the plank; wet it with the cementing liquor; and let any superfluous quantity of the liquor, which the sand in the condition described cannot retain, flow away off the plank. To the wetted sand add 14 pounds of the putrefied lime in several successive portions, mixing and beating them up together in the mean time with the instruments generally used in making fine mortar: then add 14 pounds of the bone-ash in successive portions, mixing and beating all together. The quicker and the more perfectly these materials are mixed and beaten together, and the sooner the cement thus formed is used, the better (N) it will be. This I call the *water-cement coarse-grained*, which is to be ap-

plied in building, pointing, plastering, stuccoing, or other work, as mortar and stucco now are; with this difference chiefly, that as this cement is shorter than mortar or common stucco, and dries sooner, it ought to be worked expeditiously in all cases; and in stuccoing, it ought to be laid on by sliding the trowel upwards on it; that the materials used along with this cement in building, or the ground on which it is to be laid in stuccoing, ought to be well wetted with the cementing liquor in the instant of laying on the cement; and that the cementing liquor is to be used when it is necessary to moisten the cement, or when a liquid is required to facilitate the floating of the cement.

" When such cement is required to be of a finer texture, take 98 pounds of the fine sand, wet it with the cementing liquor, and mix it with the purified lime and the bone-ash in the quantities and in the manner above described: with this difference only, that 15 pounds of lime, or (O) thereabouts, are to be used instead of 14 pounds, if the greater part of the sand be as fine as Lynn-sand. This I call *water-cement fine-grained*. It is to be used in giving the last coating, or the finish to any work intended to imitate the finer-grained stones or stucco. But it may be applied to all the uses of the water-cement coarse-grained, and in the same manner.

" When for any of the foregoing purposes of pointing, building, &c. such a cement is required much cheaper and coarser-grained, then much coarser clean sand than the foregoing coarse sand, or well-washed fine rubble, is to be provided. Of this coarse sand or rubble take 36 pounds, of the foregoing coarse sand 28 pounds, and of the fine sand 14 pounds; and after mixing these, and wetting them with the cementing liquor in the foregoing manner, add 14 pounds, or somewhat less, of the (P) purified lime, and then 14 pounds or somewhat less

used after it is drawn limpid from the butt into open vessels, it will grow turbid again, and deposit the lime changed to whiting by the gas absorbed from the air. The calcareous matter which subsides in the butt resembles whiting the more nearly as the lime has been more sparingly employed; in the contrary circumstances, it approaches to the nature of lime; and in the intermediate state, it is fit for the common composition of the plasters for inside stucco.

(I) " At the time of writing this specification, I preferred this term before that of lime-water, on grounds which I had not sufficiently examined.

(K) " The vapour which arises in the flaking of lime contributes greatly to the flaking of these pieces which lie in its way; and an unnecessary waste of the liquor is prevented, by applying it to the lime heaped in a pit or in a vessel, which may restrain the issue of the vapour, and direct it through the mass. If more of the liquor be used than is necessary to flake the lime, it will create error in weighing the flaked powder, and will prevent a part of it from passing freely through the sieve. The liquor is therefore to be used sparingly, and the lime which has escaped its action is to be sprinkled apart with fresh liquor.

(L) " When the aggregation of the lumps of lime is thus broken, it is impaired much sooner than it is in the former state, because the air more freely pervades it.

(M) " Because it consists of heterogeneous matter or of ill-burnt lime; which last will flake and pass through the sieve, if the lime be not immediately sifted after the flaking, agreeable to the text.

(N) " These proportions are intended for a cement made with sharp sand, for incrustation in exposed situations, where it is necessary to guard against the effects of hot weather and rain. In general, half this quantity of bone-ashes will be found sufficient; and although the incrustation in this latter case will not harden deeply so soon, it will be ultimately stronger, provided the weather be favourable.

" The injuries which lime and mortar sustain by exposure to the air, before the cement is finally placed in a quiet state, are great; and therefore our cement is the worse for being long beaten, but the better as it is quickly beaten until the mixture is effected, and no longer.

(O) " The quantity of bone-ashes is not to be increased with that of the lime; but it is to be lessened as the exposure and purposes of the work will admit.

(P) " Because less lime is necessary, as the sand is coarser.

Stucco.

Stucco. lefs of the bone-afh, mixing them together in the manner already defcribed. When my cement is required to be white, white fand, white lime, and the whitest bone-afh are to be chofen. Gray fand, and gray bone-afh formed of half-burnt bones, are to be chofen to make the cement gray; and any other colour of the cement is obtained, either by chofing coloured fand, or by the admixture of the neceffary quantity of coloured tale in powder, or of coloured, vitreous, or metallic powders, or other durable colouring ingredients commonly ufed in Paint.

“ To the end that fuch a water-cement as I have defcribed may be made as ufeal as it is poffible in all circumftances; and that no perfon may imagine that my claim and right under thefe letters-patent may be eluded by divers variations, which may be made in the foregoing procefs without producing any notable defect in the cement; and to the end that the principles of this art, as well as the art itfelf, of making my cement, may be gathered from this fpecification and perpetuated to the public; I fhall add the following obfervations:

“ This my water-cement, whether the coarfe or fine grained, is applicable in forming artificial ftone, by making alternate layers of the cement and of flint, hard ftone, or brick, in moulds of the figure of the intended ftone, and by expofing the mafles fo formed to the open (Q) air to harden.

“ When fuch cement is required for water (R) fences, two-thirds of the prefcribed quantity of bone-afhes are to be omitted; and in the place thereof an equal meafure of powdered terras is to be ufed; and if the fand employed be not of the coarfeft fort, more terras muft be added, fo that the terras fhall be by weight one-fixth part of the weight of the fand.

“ When fuch a cement is required of the fineft grain (S) or in a fluid form, fo that it may be applied with a brush, flint powder, or the powder of any quartofe or

hard earthy fubftance, may be ufed in the place of fand; but in a quantity fmaller, as the flint or other powder is finer; fo that the flint-powder, or other fuch powder, fhall not be more than fix times the weight of the lime, nor lefs than four times its weight. The greater the quantity of lime within thefe limits, the more will the cement be liable to crack by quick drying, and *vice verfa*.

“ Where fuch fand as I prefer cannot be conveniently procured, or where the fand cannot be conveniently washed and fortified, that fand which moft refembles the mixture of coarfe and fine fand above prefcribed, may be ufed as I have directed, provided due attention is paid to the quantity of the lime, which is to be greater (T) as the quantity is finer, and *vice verfa*.

“ Where fand cannot be eafily procured, any durable ftoney body, or baked earth grofsly powdered (U), and fortified nearly to the fizes above prefcribed for fand, may be ufed in the place of fand, meafure for meafure, but not weight for weight, unlefs fuch grofs powder be as heavy fpecifically as fand.

“ Sand may be cleaned from every fofter, lighter, and lefs durable matter, and from that part of the fand which is too fine, by various methods preferable (X), in certain circumftances, to that which I have defcribed.

“ Water may be found naturally free from fixable gas, felenite, or clay; fuch water may, without any notable inconvenience, be ufed in the place of the cementing liquor; and water approaching this ftate will not require fo much lime as I have ordered to make the cementing liquor; and a cementing liquor fufficiently ufeal may be made by various methods of mixing lime and water in the defcribed proportions, or nearly fo.

“ When ftone-lime cannot be procured, chalk-lime, or fluell-lime, which beft refembles ftone-lime, in the characters above written of lime, may be ufed in the manner

(Q) “ But they muft not be expofed to the rain until they are almoft as ftiong as frefh Portland ftone; and even then they ought to be fheltered from it as much as the circumftances will admit. Thefe ftones may be made very hard and beautiful, with a fmall expence of bone-afh, by foaking them, after they have dried thoroughly and hardened, in the lime liquor, and repeating this procefs twice or thrice, at diftant intervals of time. The like effect was experienced in incrustations.

(R) “ In my experiments, mortar made with terras-powder, in the ufual method, does not appear to form fo ftiong a cement for water-fences as that made, according to the fpecification, with coarfe fand; and I fee no more reafon for avoiding the ufe of fand in terras-mortar, than there would be for rejecting ftone from the embankment. The bone-afhes meant in this place are the dark gray or black fort. I am not yet fully fatisfied about the operation of them in this inftance.

(S) “ The qualities and ufes of fuch fine calcareous cement are recommended chiefly for the purpofe of fmoothing and finishing the ftonger cruftaceous works, or for wafhing walls to a lively and uniform colour. For this laft intention, the mixture muft be as thin as new cream, and laid on briskly with a brush, in dry weather; and a thick and durable coat is to be made by repeated wafhing; but is not to be attempted by ufig a thicker liquor; for the coat made with this laft is apt to fcule, whilft the former endures the weather much longer than any other thin calcareous covering that has been applied in this way. Fine yellow-ochre is the cheapft colouring ingredient for fuch wafh, when it is required to imitate Bath-ftone, or the warm-white ftone.

(T) “ If fea-fand be well wafhed in frefh water, it is as good as any other round fand.

(U) “ The cement made with thefe and the proper quantities of purified lime and lime-water, are inferior to the beft, as the grains of thefe powders are more perifhable and brittle than thofe of fand. They will not therefore be employed, unlefs for the fake of evafion, or for want of fand: in this latter cafe, the finer powder ought to be wafhed away.

(X) “ This and the next paragraph is infered with a view to evafions, as well as to fuggelt the eafier and cheaper methods which may be adopted in certain circumftances, by artifts who underftand the principles which I endeavoured to teach.

manner described, except that fourteen pounds and a half of chalk-lime will be required in the place of fourteen pounds of it, no less. The proportion of lime which I have preferred above may be increased without inconvenience, when the cement or stucco is to be applied where it is not liable to dry quickly; and in the contrary circumstance, this proportion may be diminished; and the defect of lime in quantity or quality may be very advantageously supplied (Y), by causing a considerable quantity of the cementing liquor to soak into the work, in successive portions, and at distant intervals of time, so that the calcareous matter of the cementing liquor, and the matter attracted from the open air, may fill and strengthen the work.

* The powder of almost every well-dried or burnt animal substance may be used instead of bone-ash; and several earthy powders, especially the micaceous and the metallic; and the calcined ashes or divers vegetables whose earth will not burn to lime; and the ashes of mineral fuel, which are of the calcareous kind, but will not burn to lime, will answer the ends of bone-ash in some degree.

* The quantity of bone-ash described may be lessened without injuring the cement, in those circumstances especially which admit the quantity of lime to be lessened, and in those wherein the cement is not liable to dry quickly. And the art of remedying the defects of lime may be advantageously practised to supply the deficiency of bone-ash, especially in building, and in making artificial stone with this cement.*

STUD, in the manege, a collection of breeding horses and mares.

STUDDING-SAILS, certain light sails extended, in moderate and steady breezes, beyond the skirts of the principal sails, where they appear as wings upon the yard arms.

STUFF, in Commerce, a general name for all kinds of fabrics of gold, silver, silk, wool, hair, cotton, or thread, manufactured on the loom; of which number are velvets, brocades, molans, satins, taffetas, cloths, serges, &c.

STUKELY, DR WILLIAM, a celebrated antiquarian, descended from an ancient family in Lincolnshire, was born at Holbech in 1687, and educated in Bennet college, Cambridge. While an under graduate, he often indulged a strong propensity to drawing and designing; but made physic his principal study, and first began to practise at Bolton in his native country. In 1717 he removed to London, where, on the recommendation of Dr Mead, he was soon after elected a fellow of the Royal Society; he was one of the first who revived that of the antiquarians in 1718, and was their secretary for many years during his residence in town. In 1729 he took holy orders by the encouragement of Archbishop Wake; and was soon after presented by Lord-chancellor King with the living of All-Saints in Stamford. In 1741 he became one of the founders of the Egyptian society, which brought him acquainted with the benevolent duke of Montague, one of the members; who prevailed on him to leave Stamford, and presented him to the living

of St George the Martyr, Queen Square. He died of a stroke of the palsy in 1765. In his physical capacity, his Dilation of the Spleen was well received; and his *lin. rarum Curiosum*, the fruit fruit of his juvenile excursions, was a good specimen of what was to be expected from his riper age. His great learning, and profound researches in the dark remains of antiquity, enabled him to publish many elaborate and curious works; his friends used to call him the *arch-druid* of his age. His uncouth, intitled *Palaeographia Sacra*, on the vegetable creation, bespoke him a totamit, philologist, and divine.

STUM, in the wine-trade, denotes the unfermented juice of the grape after it has been several times racked off and separated from its sediment. The casks are for this purpose well matched or fumigated with brimstone every time, to prevent the liquor from fermenting, as it would otherwise readily do, and become wine. See MUST.

STUPIDITY. The Greek word *μωροτη* corresponds most with our English word *stupidity* or *foolishness*, when used to express that state of mind in which the intellects are defective. The immediate causes are said to be, a deficiency of vital heat, or a defect in the brain. Stupid children sometimes become frantically youths; but if stupidity continues to the age of puberty, it is hardly ever removed. If stupidity follows upon a violent passion, an injury done to the head, or other evident cause, and if it continues long, it becomes incurable. But the stupidity which consists in a loss of memory, and succeeds a lethargy, spontaneously ceases when the lethargy is cured.

STUPOR, a numbness in any part of the body, whether occasioned by ligatures obstructing the blood's motion, by the palsy, or the like.

STUPPA, or STUPE, in Medicine, is a piece of cloth dipped in some proper liquor, and applied to an affected part.

STURDY, a distemper to which cattle are subject, called also the *turning evil*. See FERRERY INDEX.

STURGEON. See ACCIPENSER, ICHTHYOLOGY INDEX.

STURMIUS, JOHN, a learned philologist and rhetorician, was born at Sleida in Eifel near Cologne in 1527. He studied at first in his native country with the sons of Count de Manderscheid, whose receiver his father was. He afterwards pursued his study at Liege in the college of St Jerom, and then went to Louvain in 1524. Five years he spent there, three in learning and two in teaching. He set up a printing-press with Rudger Relcius professor of the Greek tongue, and printed several Greek authors. He went to Paris in 1529, where he was highly esteemed, and read public lectures on the Greek and Latin writers, and on logic. He married there, and kept a great number of boarders: but as he liked what were called the *new opinions*, he was more than once in danger; and this undoubtedly was the reason why he removed to Strasburg in 1537, in order to take possession of the place offered him by the magistrates. The year following he opened a school, which became

(Y) * T is practise is noticed, as the remedy which may be used for the defects arising from evasive measures, and as the method of giving spongy incrustations containing bone-ashes the greatest degree of hardness.*

became famous, and by his means obtained of Maximilian II. the title of an university in 1566. He was very well skilled in polite literature, wrote Latin with great purity, and was a good teacher. His talents were not confined to the school; for he was frequently intrusted with deputations in Germany and foreign countries, and discharged these employments with great honour and diligence. He showed extreme charity to the refugees on account of religion: He not only laboured to assist them by his advice and recommendations; but he even impoverished himself for them. He died in his 82d year, after he had been for some time blind. He published many books; the principal of which are, 1. *Partitiones Dialecticæ*. 2. *De Educatione Principum*. 3. *De Nobilitate Anglicana*. 4. *Lingua Latina refoventis Ratio*. 5. Excellent Notes on Aristotle's and Hermogenes's Rhetoric, &c.

He ought not to be confounded with *John Sturmius*, a native of Mechlin, and physician and professor of mathematics at Louvain, who also wrote several works.

STURNUS, the STARLING; a genus of birds belonging to the order of passeræ. See ORNITHOLOGY *Index*.

STYLE, or **STYTHE**, in the eye. See CRITHE.

STYLE, a word of various significations, originally deduced from *Stylus*, a kind of bodkin wherewith the ancients wrote on plates of lead, or on wax, &c. and which is still used to write on ivory-leaves and paper prepared for that purpose, &c.

STYLE, in dialling, denotes the gnomon or cock of a dial raised on the plane thereof to project a shadow.

STYLE, in Botany. See BOTANY.

STYLE, in language, is the peculiar manner in which a man expresses his conceptions. It is a picture of the ideas which rise in his mind, and of the order in which they are there produced.

The qualities of a good style may be ranked under two heads; per-*fect* and ornament. It will readily be admitted, that per-*fect* ought to be essentially connected with every kind of writing; and to attain it, attention must be paid, first to single words and phrases, and then to the construction of sentences. When considered with respect to words and phrases, it requires these three qualities; purity, propriety, and precision. When considered with regard to sentences, it requires a clear arrangement of the words and unity in the sense; to which, if strength and harmony be added, the style will become ornamented.

One of the most important directions to be observed by him who writes to form a good style, is to acquire clear and precise ideas on the subject concerning which he is to write or speak. To this must be added frequency of composition, and an acquaintance with the style of the best authors. A servile imitation, however, of any author is carefully to be avoided; for he who copies, can hardly avoid copying faults as well as beauties. A style cannot be proper unless it be adapted to the subject, and likewise to the capacity of our hearers, if we are to speak in public. A simple, clear, and unadorned style, such as that of Swift, is fittest for intricate disquisition; a style elegant as Addison's, or impetuous like Johnson's, is most proper for fixing the attention on truths, which, though known, are too much neglected. We must not be inattentive to the ornaments of style, if we wish that our labours should be read and admired;

but he is a contemptible writer, who looks not beyond the dress of language, who lays not the chief stress upon his matter, and who does not regard ornament as a secondary and inferior recommendation. For further observations on the different kinds of style, see ORATORY, N° 99, &c.

STYLE, in *Jurisprudence*, the particular form or manner of proceeding in each court of jurisdiction, agreeable to the rules and orders established therein: thus we say, the style of the court of chancery, of chancery, of parliament, of the privy-council, &c.

STYLE, in *Musick*, denotes a peculiar manner of singing, playing, or composing; as being properly the manner that each person has of playing, singing, or teaching; which is very different both in respect of different geniuses, of countries, nations, and of the different matters, places, times, subjects, passions, expressions, &c. Thus we say, the style of Palestrina, of Lully, of Corelli, of Handel, &c.; the style of the Italians, French, Spaniards, &c.

Old STYLE, the Julian method of computing time, as the

New STYLE is the Gregorian method of computation. See CALENDAR.

STYLEPHORUS CHORDATUS, a genus of fishes belonging to the order of apodes. See ICHTHOLOGY *Index*, and Transactions of the Linnæan Society, vol. i.

STYLET, a small dangerous kind of poniard which may be concealed in the hand, chiefly used in treacherous assassinations. The blade is usually triangular, and so small that the wound it makes is almost imperceptible.

STYLITES, **PILLAR SAINTS**, in ecclesiastical history, an appellation given to a kind of solitaries, who stood motionless upon the tops of pillars, raised for this exercise of their patience, and remained there for several years, amidst the admiration and applause of the stupid populace. Of these we find several mentioned in ancient writers, and even as low as the twelfth century, when they were totally suppressed.

The founder of the order was St Simeon Stylites, a famous anchorite in the fifth century, who first took up his abode on a column six cubits high; then on a second of twelve cubits, a third of twenty-two, a fourth of thirty-six, and on another of forty cubits, where he thus passed thirty-seven years of his life. The tops of these columns were only three feet in diameter, and were defended by a rail that reached almost to the girdle, somewhat resembling a pulpit. There was no lying down in it. The laquais, or devout people of the East, imitate this extraordinary kind of life to this day.

STYLOCERAILOIDES, } The names of different muscles in the human body. See *Table*
STYLO-GLOSSUS, }
STYLO-HYOIDEUS, }
STYLO-PHARYNGÆUS, } of the *Muscles* under
STYLOIDES, } ANATOMY.

STYLO-ANTHES, a genus of plants belonging to the *diadelphia* class, and in the natural method ranking under the 32d order, *Papilionaceæ*. See BOTANICAL *Index*.

STYPTIC, in *Pharmacy*, a medicine which by its astringency stops hæmorrhages, &c. See MATERIA MEDICA *Index*.

STYRAX, the STORAX-TREE, a genus of plants belonging to the class *dicandria*, and in the natural system ranking

S.V.V.
Sua'ra.

ranging under the 18th order, *bicornes*. See **BOTANY** and **MATERIA MEDICA Index**.

STYX, in *Fabulous History*, a celebrated river of hell, round which it flows nine times. The gods held the waters of the Styx in such veneration, that to swear by them was reckoned an oath altogether inviolable. If any of the gods had perjured themselves, Jupiter obliged them to drink the waters of the Styx, which lulled them for one whole year into a senseless stupidity, for the nine following years they were deprived of the ambrosia and the nectar of the gods, and after the expiration of the years of their punishment, they were restored to the assembly of the deities, and to all their original privileges. It is said that this veneration was shewn to the Styx, because it received its name from the nymph Styx, who with her three daughters assisted Jupiter in his war against the Titans.

Styx was a river which it was necessary for departed shades to pass before they could enter the infernal regions; and it was the office of Charon to ferry them over in a boat which was kept for that purpose. The ghosts of those who had not been honoured with the rites of sepulture were obliged to wander an hundred years before Charon could admit them into his boat to convey them before the judges of Hades. What could have given rise to this fable of Charon and his boat, it is not very material to inquire. Mythological writers have said, that the Greeks learned it from the Egyptians, which is indeed probable enough; that the Egyptians framed both this, and some other fables relating to the dead, from certain customs peculiar to their country; that in particular there was, not far from Memphis, a famous burying-place, to which the dead bodies were conveyed in a boat across the lake Acherusa; and that Charon was a boatman who had long officiated in that service. The learned Dr Blackwell says, in his life of Homer, that, in the old Egyptian language, *Charon* signified "ferryman."

SUABIA, a circle of Germany, bounded on the north by the circle of Franconia and that of the Lower Rhine; on the west by the circle of the Lower Rhine and Alsace; on the south by Switzerland; and on the east by the circle of Bavaria. Of all the circles of the empire, Suabia is the most divided; it contains four ecclesiastical and thirteen lay principalities, nineteen independent prelates and abbeys, twenty-six earldoms and lordships, and thirty-one free cities. The prime directors of the circle, as they are termed, were formerly the bishop of Constance and the duke of Wirtemberg. But this circle has suffered similar changes with neighbouring states.

The mixture of the various forms of government and religious sects; the oppression exercised by the great on the poor; the game constantly played by the emperor, who possesses many pieces of detached country in Suabia, which depend not on the circle, and can, in consequence of his privileges as archduke of Austria, extend his possessions in it by various ways; are circumstances (says Baron Riefbeck) which give the cultivation of the country, and the character of the inhabitants, a most extraordinary cast. In several of the post towns where you stop, you see the highest degree of cultivation in the midst of the most savage wildness; a great degree of knowledge and polish of manners, mixed with the grossest ignorance and superstition; traces of liberty, under the deepest oppression; national pride, together with

the contempt and neglect of the native country; in short, all the social qualities in striking contrast and opposition to each other. Those parts of Suabia which belong to the great potentates, such as Wirtemberg, Austria, and Baden, are certainly the most improved. The whole of Suabia may comprehend about nine hundred German square miles, and two millions of people. More than half of these are subjects of the three above mentioned princes, though they are not proprietors of near one half of the lands.

SUARES, FRANCIS, a Jesuit, was born in Granada on the 5th of January 1548. He was a professor of theology at Alcalá, Salamanca, Rome, and Coimbra in Portugal. He died at Lisbon in 1617 with the greatest resignation; "I never thought (said he) that it was so easy to die." His memory was astonishing, he could repeat the whole of his voluminous works by heart. His writings fill 23 folio volumes, and are mostly on theological and moral subjects. His Treatise of Laws has been reprinted in this country. His Defence of the Catholic Faith against the Errors of England was written at the request of Pope Paul V. This book was publicly burnt at London by order of James I. When Suarez heard it, he is said to have exclaimed, "O that I too could seal with my blood the truths which I have defended with my pen!"

SUBAH, the general name of the viceroys, or greater governments, into which the Mogul empire was divided, consisting of several provinces. The jurisdiction of a subahdar, the same as subahship, subadearee, or nizamat.

SUBAH DAR, the viceroy, lord-lieutenant, or governor, holding a subah; the same as nabob or nazim. Also the black commander of a company of seapoes.

SUBALTERN, a subordinate officer, or one who discharges his post under the command and subject to the direction of another; such are lieutenants, sub-lieutenants, cornets, and ensigns, who serve under the captain.

SUBCLAVIAN, in *Anatomy*, is applied to any thing under the armpit or shoulder, whether artery, nerve, vein, or muscle.

SUBDEACON, an inferior minister, who anciently attended at the altar, prepared the sacred vessels, delivered them to the deacons in time of divine service, attended the doors of the church during communion-service, went on the bishop's embassies with his letters or messages to foreign churches, and was invested with the first of the holy orders. They were so subordinate to the superior rulers of the church, that, by a canon of the council of Laodicea, they were forbidden to sit in the presence of a deacon without his leave. According to the canons, a person must be twenty-two years of age to be promoted to the order of subdeacon. See **DEACON**.

SUBDOMINANT, in *Music*, a name given by M. Rameau to the fourth note of the tone, which of consequence is the same interval from the tonic when descending as the dominant in rising. This denomination arises from the affinity which this author finds by inversion between the minor mode of the subdominant and the major mode of the tonic.

SUBDUPE RATIO, is when any number or quantity is contained in another twice. Thus 3 is said to be subdupe of 6, as 6 is dupe of 3. See **RATIO**.

SUBDUPLICATE

Wolff's
Hist. of the
Royal So-
ciety of
Edinburgh,
vol. II.

Baron
Riefbeck's
Travels
through
Germany,
vol. II.

Suabia
||
Subd ple
Ratio.

SUBDUPLICATE RATIO of any two quantities, is the ratio of their square roots.

SUBER, the CORK-TREE. See QUERCUS, BOTANY Index.

SUBJECT, a person under the rule and dominion of a sovereign prince or state.

SUBJECT is also used for the matter of an art or science, or that which it considers, or whereon it is employed: thus the human body is the subject of medicine.

SUBINFÉUDATION, was where the inferior lords, in imitation of their superiors, began to carve out and grant to others minuter estates than their own, to be held of themselves; and were so proceeding downwards in infinitum, till the superior lords observed, that by this method of subinféudation they lost all their feudal profits, of wardships, marriages, and escheats, which fell into the hands of these meise or middle lords, who were the immediate superiors of the terre-tenant, or him who occupied the land. This occasioned the flat. of Westm. 3. or *quia emptores*, 18. Edw. I. to be made; which directs, that, upon all sales or feoffments of lands, the feoffee shall hold the same, not of his immediate feoffer, but of the chief lord of the fee of whom such feoffer himself held it. And from hence it is held, that all manors existing at this day must have existed by immemorial prescription; or at least ever since the 18 Edw. I. when the statute of *quia emptores* was made.

SUBITO, in the Italian music, is used to signify that a thing is to be performed quickly and hastily: thus we meet with *volti subito*, turn over the leaf quickly.

SUBJUNCTIVE, in Grammar. See GRAMMAR.

SUBLIMATE, a chemical preparation, consisting of quicksilver united with muriatic acid. See MERCURY, CHEMISTRY Index.

SUBLIMATION, in Chemistry, the condensing and collecting, in a solid form, by means of vessels aptly constructed, the fumes of bodies raised from them by the application of a proper heat.

SUBLIME, or **SUBLIMITY**. See the article GRANDUR and SUBLIMITY.

SUBLINGUAL ARTERY. See ANATOMY.

SUBLINGUAL Glands, in Anatomy, two glands under the tongue, placed one on each side thereof.

SUBMULTIPLE, in Geometry, &c. A submultiple number, or quantity, is that which is contained a certain number of times in another, and which, therefore, repeated a certain number of times, becomes exactly equal thereto. Thus 3 is a submultiple of 21. In which sense a submultiple coincides with an aliquot part.

SUBMULTIPLE Ratio, is that between the quantity contained and the quantity containing. Thus the ratio of 3 to 21 is submultiple. In both cases submultiple is the reverse of multiple: 21, e. g. being a multiple of 3, and the ratio of 21 to 3 a multiple ratio.

SUBORDINARIES. See HERALDRY, Chap. III. Sect. II.

SUBORDINATION, a relative term, expressing an inferiority betwixt one person and another.

SUBORNATION, in Law, a secret, underhand, preparing, instructing, or bringing in a false witness; and from hence *subornation of perjury* is the preparing or corrupt alluring to perjury. The punishment for this crime was formerly death, then banishment or cutting

out the tongue, afterwards forfeitures of goods; and it is now a fine and imprisonment, and never more to be received as evidence. The statute 2 Geo. II. c. 23. superadded a power for the court to order the offender to be sent to the house of correction for a term not exceeding seven years, or be transported for the same period.

SUBPOENA, in Law, a writ whereby common persons are called into chancery, in such cases where the common law hath provided an ordinary remedy; and the name of it proceeds from the words therein, which charge the party called to appear at the day and place affirmed, *sub poena centum librarum*, &c. The subpoena is the leading process in the courts of equity; and by statute, when a bill is filed against any person, process of subpoena shall be taken out to oblige the defendant to appear and answer the bill, &c.

SUBPOENA ad testificandum, a writ or process to bring in witnesses to give their testimony. If a witness on being served with this process does not appear, the court will issue an attachment against him; or a party, plaintiff or defendant, injured by his non-attendance, may maintain an action against the witness. See *Blackl. Com.* vol. viii. p. 369.

SUBPOENA, in Equity, a process in equity, calling on a defendant to appear and answer to the complainant's bill. See statute 5th Geo. II. c. 25. which enacts, that where the party cannot be found to be served with a subpoena, and absconds (as is believed) to avoid being served, a day shall be appointed him to appear to the bill of the plaintiff; which is to be inserted in the London Gazette, read in the parish church where the defendant last lived, and fixed up at the Royal Exchange; and if the defendant doth not appear upon that day, the bill shall be taken *pro confesso*.

SURREPTITIOUS, a term applied to a letter, licence, patent, or other act, fraudulently obtained of a superior, by concealing some truth which, had it been known, would have prevented the concession or grant.

SUBROGATION, or **SURROGATION**, in the civil law, the act of substituting a person in the place, and instituting him to the rights, of another. In its general sense, subrogation implies a succession of any kind, whether of a person to a person, or of a person to a thing.

There are two kinds of subrogation: the one *conventional*, the other *legal*. *Conventional* subrogation is a contract whereby a creditor transfers his debt, with all appurtenances thereof, to the profit of a third person. *Legal* subrogation is that which the law makes in favour of a person who discharges an antecedent creditor; in which case there is a legal transferral of all rights of the ancient creditor to the person of the new one.

SUBSCRIPTION, in general, signifies the signature put at the bottom of a letter, writing, or instrument.

In commerce, it is used for the share or interest which particular persons take in a public stock or a trading company, by writing their names, and the shares they require, in the books or register thereof.

SUBSCRIPTION to articles of faith is required of the clergy of every established church, and of some churches not established. Whether such subscription serves any good purpose, in a religious or theological view, is a very doubtful question. It may be necessary in an establishment, as a test of loyalty to the prince, and of attachment to the constitution, civil and ecclesiastical, but it cannot

produce uniformity of opinion. As all language is more or less ambiguous, it becomes difficult, if not impossible, to determine in what sense the words of long established creeds are to be interpreted; and we believe that the clergy of the churches of England and Scotland seldom consider themselves as fettered by the Thirty-nine Articles, or the Confession of Faith, when composing instructions either for their respective parishes or for the public at large. See INDEPENDENTS.

SUBSCRIPTION, in the commerce of books, signifies an engagement to take a certain number of copies of a book, intended to be printed, and a reciprocal obligation of the bookseller or publisher to deliver the said copies, on certain terms. These subscriptions, which had their rise in England about the middle of the 17th century, were lately very frequent in France and Holland, and are now very common among ourselves.

SUBSEQUENT, something that comes after another, particularly with regard to the order of time.

SUBSIDY, in *Law*, signifies an aid or tax granted to the king by parliament, for the necessary occasions of the kingdom; and is to be levied on every subject of ability, according to the rate or value of his lands or goods: but this word, in some of our statutes, is confounded with that of customs. See TAX.

SUBSTANCE, the subjects to which we suppose qualities belong. Thus gold is the substance to which the qualities of ductility, yellowness, density, &c. belong. See METAPHYSICS, n^o 145.

SUBSTANTIAL, in the schools, something belonging to the nature of substance.

SUBSTANTIVE, in *Grammar*. See GRAMMAR.

SUBSTITUTE, a person who officiates for another in his absence.

SUBSTITUTION, in the *Civil Law*, a disposition of a testament, whereby the testator substitutes one heir for another, who has only the usufruct, and not the property or the thing, left him.

SUBTRACTION, or SUBTRACTION, in *Arithmetic*, the second rule, or rather operation, in arithmetic, whereby we deduct a less number from a greater, to learn their precise difference. See ARITHMETIC and ALGEBRA.

SUBTANGENT OF A CURVE, the line that determines the intersection of a tangent with the axis; or that determines the point wherein the tangent cuts the axis prolonged.

SUBTENSE, formed from *sub* "under," and *tendo* "I stretch," in *Geometry*, a right line which is opposite to an angle, and drawn between the two extremities of the arch which measures that angle.

SUBTERRANEANOUS, whatever is under ground: thus naturalists speak of subterraneous fires, subterraneous damps, &c.

SUBTERRANEANUS *Caverna*. See QUARRIES.

SUBTILE, in *Physics*, an appellation given to whatever is extremely small, fine, and delicate; such as the animal spirits, the effluvia of odorous bodies, &c. are supposed to be.

SUBULARIA, ROUGH-LEAVED ALYSSON, or *Aulwort*, a genus of plants belonging to the class tetradynamia, and in the natural order ranging under the 39th order, *silquosae*. See BOSANY Index.

SUBULATED, something shaped like an awl.

SUCCEDANEUM, in *Pharmacy*, denotes a drug substituted in the place of another.

SUCCESSION, in *Metaphysics*, the idea which we get by reflecting on the ideas that follow one another in our mind; and from the succession of ideas we get the idea of time. See METAPHYSICS, n^o 93. and 209.

SUCCESSION, in *Law*. See DESCENT.

SUCCESSION to the Crown. See HEREDITARY

Right.—From the days of Egbert, the first sole monarch of England, even to the present, the four cardinal maxims mentioned in that article have ever been held constitutional canons of succession. It is true, as Sir William Blackstone observes, this succession, through fraud or force, or sometimes through necessity, when in hostile times the crown descended on a minor or the like, has been very frequently suspended; but has generally at last returned back into the old hereditary channel, though sometimes a very considerable period has intervened. And even in those instances where this succession has been violated, the crown has ever been looked upon as hereditary in the wearer of it. Of which the usurpers themselves were so sensible, that they for the most part endeavoured to vamp up some feeble show of a title by descent, in order to amuse the people, while they gained the possession of the kingdom. And, when possession was once gained, they considered it as the purchase or acquisition of a new estate of inheritance, and transmitted, or endeavoured to transmit it, to their own posterity by a kind of hereditary right of usurpation. (See Black. Com. vol. i. 197—217.). From the historical view there given, it appears that the title to the crown is at present hereditary, though not quite so absolutely hereditary as formerly: and the common stock or ancestor, from whom the descent must be derived, is also different. Formerly the common stock was King Egbert; then William the Conqueror; afterwards, in James I.'s time, the two common stocks united; and so continued till the vacancy of the throne in 1688: now it is the Princess Sophia in whom the inheritance was vested by the new king and parliament. Formerly, the descent was absolute, and the crown went to the heir without any restriction: but now, upon the new settlement, the inheritance is conditional: being limited to such heirs only, of the body of the Princess Sophia, as are Protestant members of the church of England, and are married to none but Protestants.

And in this due medium consists the true constitutional notion of the right of succession to the imperial crown of these kingdoms. The extremes between which it steers are each of them equally destructive of those ends for which societies were formed and kept on foot. Where the magistrate, upon every succession, is elected by the people, and may by the express provision of the laws be deposed (if not punished) by his subjects, this may sound like the perfection of liberty, and look well enough when delineated on paper; but in practice will be ever productive of tumult, contention, and anarchy. And, on the other hand, divine indefeasible hereditary right, when coupled with the doctrine of unlimited passive obedience, is surely of all constitutions the most thoroughly slavish and dreadful. But when such an hereditary right as our laws have created and vested in the royal stock, is closely interwoven with those liberties which are equally the inheritance of the subject; this union

Succeda-
neum,
Succession.

Succellion
||
Suckling.

union will form a constitution, in theory the most beautiful of any, in practice the most approved, and, we trust, in duration the most permanent.

In France the succellion to the monarchy was limited to heirs male (see *SALIC*); but in Navarre the crown was inherited by the heir of line, whether male or female. The case stands thus: Philip the Fourth, king of France, surnamed the *Fair*, in the year 1285 espoused Jane queen of Navarre in her own right; and as king consort of this latter kingdom added the title of Navarre to his former one of France. Louis X. son and heir of Philip and Jane (surnamed *Hutin* or the *Boissierous*), succeeded to both crowns. By Margaret his first wife, who had been crowned queen of Navarre, he left one daughter, Joan or Jane. His second wife Clementina was pregnant at the time of his decease, and was delivered of a posthumous son, whom most of the French annalists recognize as John I. of France, though he lived no longer than three weeks. On his death the kingdom of France passed to Philip V. (surnamed the *Long*), and that of Navarre (to which the Salic law could by no construction extend) to Joanna the only child and heir of Louis and Margaret. From Joanna, in lineal succellion, the kingdom of Navarre passed to Jane d'Albret, mother of Henry IV. of France, and wife of Anthony of Vendosme, who as king consort wore the crown of Navarre. On the accession of Henry to the kingdom of France, the two monarchies were united, and the four succeeding princes assumed the joint titles.

SUCCINIC ACID, an acid extracted from amber by sublimation in a gentle heat, and which rises in a concrete form into the neck of the subliming vessel. See *CHEMISTRY Index*.

SUCCINUM, AMBER, in *Mineralogy*, a species of bitumen classed under the inflammable substances. See *MINERALOGY Index*.

SUCCORY. See *CICORIUM, BOTANY Index*.

SUCCOTH, in *Ancient Geography*, a town which lay between the brook Jabbok and the river Jordan, where Jacob fixed his tents. There was another Succoth, where the Israelites first encamped after their departure from Rameses towards the Red sea. Succoth signifies *tents*.

SUCUBUS, a term used by some writers for a demon who assumes the shape of a woman, and as such lies with a man; in which sense it stands opposed to *incubus*, which was a demon in form of a man, that lies with a woman. But the truth is, the succubus is only a species of the nightmare. See *MEDICINE, N° 329*.

SUCCULA, in *Mechanics*, an axis or cylinder, with flaves in it to move it round; but without any tympanum or peritrochium.

SUCCULENT PLANTS, among botanists, such whose leaves are thick and full of juice.

SUCKER. See *CYCLOPTERUS, ICHTHOLOGY Index*.

SUCKERS, in *Gardening*, the same with *OFFSETS*.

SUCKING-FISH. See *ECHENEIS, ICHTHOLOGY Index*.

SUCKLING, SIR JOHN, an English poet and dramatic writer, was the son of Sir John Suckling, comptroller of the household to King Charles I. and born at Witham in Essex in 1613. He discovered an uncommon propensity to the acquiring of languages, inasmuch that he is reported to have spoken Latin at five years of

age, and to have written it at nine. When he grew up, he travelled; but seems to have affected nothing more than the character of a courtier and fine gentleman; which he so far attained, that he was allowed to have the peculiar happiness of making every thing he did become him. In his travels he made a campaign under the great Gustavus Adolphus; and his loyalty, if not his valour, appeared in the beginning of our civil wars; for, after his return to England, he raised a troop of horse for the king's service entirely at his own charge; and mounted them to completely and richly, that they are said to have cost him 12,000*l*. This troop, with Sir John at its head, behaved ill in the engagement with the Scots, upon the English borders, in 1639, as to occasion the famous lampoon composed by Sir John Mennis; "Sir John he got him an amling nag," &c. This ballad, which was set to a brisk tune, was much sung by the parliamentarians, and continues to be sung to this day. This disastrous expedition, and the ridicule that attended it, was supposed to have hastened his death; being seized by a fever, of which he died, at 28 years of age. He was a sprightly wit, and an easy versifier, but no great poet. His works, consisting of a few poems, letters, and plays, have nevertheless gone through several editions.

SUCTION, the act of sucking or drawing up a fluid, as air, water, milk, or the like, by means of the mouth and lungs; or, in a similar manner, by artificial means. See *PNEUMATICS* and *HYDRODYNAMICS*.

SUDATORY, a name given by the ancient Romans to their hot or sweating rooms; sometimes also called *Laconica*.

SUDEROE. See *FERRO-Island*.

SUDORIFIC, an appellation given to any medicine that causes or promotes sweat.

SUSSIONES, a branch of the Remi, a people of Gallia Belgica (*Pliny*); called sometimes *Suessones*, in the lower age *Sueffi*; situated between the Remi to the east, the Nervii to the north, the Veromandui to the west, and the Meldie to the south, in the tract now called *le Soiffnois*.—*Suessones, Suessones, and Sueffones*, the name of their city in the lower age; thought to have been formerly called *Noviodunum* (Cæsar), is now called *Soiffone*.

SUETI, SEVUM, or Sebum, in *Anatomy*, the solid fat found in several animals, as sheep, oxen, &c. but not in the human species. See the article *FAT*.—It is of the sebum that tallow is made.

SUETONIUS TRANQUILLUS, CAIUS, a famous Latin historian, was born at Rome, and became secretary to the emperor Adrian, about the 118th year of the Christian era; but that post was taken from him three years after, when several persons fell under that prince's displeasure for not showing the empress Sabina all the respect he desired. During his disgrace he composed many works, which are lost. Those now extant are his History of the XII first Emperors, and a part of his treatise of the Illustrious Grammarians and Rhetoricians. Pliny the Younger was his intimate friend, and persuaded him to publish his books. His History of the XII Roman Emperors has been much commended by most of our polite scholars. He represents, in a continued series of curious and interesting particulars, without any digressions or reflections, the actions of the emperors, without omitting their vices, which he exposes with all

Sucking
||
Suckling.

Suet. ius
ii
Secz.

their deformity, and with the same freedom mentions the good qualities of the very same persons; but the horrid dissoluteness and obscene actions he relates of Tiberius, Caligula, Nero, &c. have made some say, that he wrote the lives of the emperors with the same licentiousness with which they lived. The edition of this history procured by Grævius at Utrecht in 1672, with the excellent Commentaries of Utterentius and Casaubon, and the notes of some other learned critics, is much esteemed. Burman also published an edition in 2 vols. 4to, with notes.

SUEVI, the Catti or Chatti of Cæsar (Strabo), placed on the Rhine: the reason of Cæsar's calling them thus does not appear, though considerably distant from the proper Suevi or Alemanni.

SUEVI, (Tacitus), a common name of the people situated between the Elbe and the Vistula, distinguished otherwise by particular names; as in Ptolemy, *Suevi Angeli, Suevi Sennones*.

SUEVUS, in *Ancient Geography*, a river of Germany, thought to be the same with the Viadrus or Oder, emptying itself at three mouths into the Baltic, the middlemost of which is called *Swine* or *Swene*; which last comes nearer the name *Suevius*.

SUEZ, a small sea-port town, situated near the northern extremity of the Red sea, and about 30 hours journey east from Cairo. The country around it is a sandy plain, without the smallest spot of verdure. The only water which can be drunk is brought from El-Naba, or the spring, at the distance of three hours journey; and it is so brackish, that without a mixture of rum it is insupportable to Europeans. The town itself is a collection of miserable ruins, the khans being the only solid buildings; yet from March till June, the season when the Jidda and Yambo fleet arrives, the town becomes crowded; but after its departure nobody remains except the governor, who is a Mamlouk, 12 or 14 persons who form his household, and the garrison. The fortrefs is a defenceless heap of ruins, which the Arabs consider as a citadel, because it contains six brass four-pounders, and two Greek gunners, who turn their heads aside when they fire. The harbour is a wretched quay, where the smallest boats are unable to reach the shore, except at the highest tides. There, however, the merchandise is embarked, to convey it over the banks of sand to the vessels which anchor in the road. This road, situated a league from the town, is separated from it by a shore which is left dry at low water; it has no works for its defence, so that the vessels which M. Volney tells us he has seen there, to the number of 28 at a time, might be attacked without opposition; for the ships themselves are incapable of resistance, none having any other artillery than four rusty swivels.

Suez has always been, notwithstanding its local disadvantages, a place of great trade, on account of its geographical situation. It was by the gulf of Suez that the commodities of India were formerly conveyed to Europe, till the discovery of the passage by the Cape of Good Hope converted that trade into a new channel. As the isthmus of Suez, which separates the Red sea from the Mediterranean, is not more than 57 miles, it has been frequently proposed to join these two seas together by a canal. As there are no mountains nor remarkable inequalities of surface, this plan would at first view appear easy to be executed. But though the dif-

ference of levels would not prevent a junction, the great difficulty arises from the nature of the corresponding coasts of the Mediterranean and the Red sea, which are of a low and sandy soil, where the waters form lakes, shoals, and morasses, so that vessels cannot approach within a considerable distance. It will therefore be found scarcely possible to dig a permanent canal amid these shifting sands: not to mention, that the shore is destitute of harbours, which must be entirely the work of art. The country besides has not a drop of fresh water, and to supply the inhabitants, it must be brought as far as from the Nile.

The best and only method therefore of effecting this junction, is that which has been already successfully practised at different times; which is, by making the river itself the medium of communication, for which the ground is perfectly well calculated; for Mount Mokattum suddenly terminating in the latitude of Cairo, forms only a low and semicircular mound, round which is a continued plain from the banks of the Nile as far as the point of the Red sea. The ancients, who early understood the advantage to be derived from this situation, adopted the idea of joining the two seas by a canal connected with the river. Strabo* observes, that this was first executed under Sesostris, who reigned about the time of the Trojan war; and this work was so considerable as to occasion it to be remarked, "that it was 100 cubits (or 150 feet) wide, and deep enough for large vessels." After the Greeks conquered the country, it was restored by the Ptolemies, and again renewed by Trajan. In short, even the Arabs themselves followed these examples. "In the time of Omar ebn-el-Kattab (says the historian El Makin), the cities of Mecca and Medina suffering from famine, the caliph ordered Amrou governor of Egypt to cut a canal from the Nile to Kolzoum, that the contributions of corn and barley appointed for Arabia might be conveyed that way."

This canal is the same which runs at present to Cairo, and loses itself in the country to the north-east of Berket-el-Hadj, or the Lake of the Pilgrims.

The place on the west coast of the gulf of Suez, where the children of Israel are supposed to have entered it, is called *Badea*, about six miles to the north of Cape Korondel, on the other side of the gulf, as we are informed in a letter from the ingenious Edward Wortley Montague, F. R. S. to Dr Watson, containing an account of his journey from Cairo to the Written Mountains in the desert of Sinai. Opposite to Badea is a strong current which sets to the opposite shore, about four east, with a whirlpool called *Birque Pharaone*, the well or pool of Pharaoh, being the place where his host is said to have been destroyed. We are told by the same gentleman, that the Egyptian shore from Suez to Badea is so rocky and steep, that there was no entering upon the gulf but at one of these two places.

The British nation, we believe, never attempted to carry on commerce with any of the ports of the Red sea beyond Jidda, till, on the suggestion of Mr Bruce, in 1776, some British merchants at Bengal equipped two or three vessels for Suez, laden with piece-goods of Bengal and coast manufactures. The command of the vessels was committed to Captain Greig, a meritorious seaman; and the management of the goods was entrusted to Mr Straw, a gentleman distinguished for his mercantile knowledge. The sale turned out to advantage; but

* Lib. xvii.

such

Volney's
Travels,
vol. 4.

fuch great expences were incurred in making presents to the bey of Cairo and Suez, as to consume the whole profits gained by the sale of the cargo. The great purpose of the expedition was, however, accomplished, as a firman was obtained from the government of Cairo to trade by the way of Suez. In consequence of this, three ships went to Suez the following year, and as many in 1778. The opening of this trade alarmed the jealousy of the East India Company; they applied to our government, and orders were given to relinquish this promising commerce. These orders reached Egypt sooner than Bengal, and the consequence was fatal to the unfortunate adventurers who visited Suez that year (1779). By a plan concerted between the beys, a large body of Bedouin Arabs attacked the caravan passing from Suez to Cairo with goods valued at 12 lacs of rупees. The goods were plundered, the Europeans were stripped and left naked in the desert, exposed to the burning rays of the sun, without a drop of water to quench their thirst, or food to support life. Most of them died, and some of their bodies were afterwards found mangled and disfigured by wolves. We have been favoured with a particular account of the sufferings of our countrymen by a correspondent, which, we are sorry, we have not room to insert. Those who wish to obtain a more full account may consult the Annual Register for 1781 or 1782.

SUFFETULA, in *Ancient Geography*, a town of Africa, in the dominions of Carthage; probably so called from Suffetes, the title of the magistrates of that city. It is now called *Spaitla*, in the kingdom of Tunis, and has many elegant remains of antiquity. There are three temples in a great measure entire; one of them of the Composite order, the other two Corinthian. "A beautiful and perfect capital of the Composite order (says Mr Bruce), the only perfect one that now exists, is designed in all its parts in a very large size; and with the detail of the rest of the ruin, is a precious monument of what that order was, now in the collection of the king." The town itself (he says) is situated in the most beautiful spot in Barbary, surrounded by great numbers of juniper-trees, and watered by a pleasant stream, which sinks under the earth at that place, without appearing any more.

SUFFOCATION, the privation of the function of respiration or breathing. See the articles **DROWNING**, **HANGING**, &c.

SUFFOLK, a county of England. Its name is contracted from *Southfolk*, so called from its situation in regard to Norfolk. It is bounded on the west by Cambridge-shire; on the south by Essex, from which it is parted by the river Stour; on the east by the German ocean; and on the north by Norfolk, separated from it by the Lesser Ouse and the Waveney. From west to east it is 52 miles in length, about 20 at a medium in breadth, and 196 in circumference. It contains 22 hundreds, 29 market-towns, 575 parishes, upwards of 34,000 houses, and 210,431 inhabitants. The whole is divided into two parts, viz. the Liberty of St Edmund, and the Geldable; the former of which contains the west parts of the county, and the other the east; and there is a grand jury for each at the assizes. The air is reckoned as wholesome and pleasant as any in the kingdom, nor is it otherwise upon the sea coast, which is dry and sandy, and free from salt marshes. The soil,

except to the west and upon the sea-coast, is very rich, being a compound of clay and marl. Towards the sea there are large heaths and tracts of sand; but these produce hemp, rye, and pease, and feed great flocks of sheep. About Newmarket the soil is much the same; but in high Suffolk or the woodlands, besides wood, there are very rich pastures, where abundance of cattle are fed. In other parts of the county, as about Bury, there is plenty of corn. As this county is noted for the richness of its pastures, so it is fit for butter and cheese, especially the former, which is said to be remarkably good; so that being packed up in firkins, it is sold for all uses both by sea and land, and conveyed to many parts of England, especially to London. The inland parts of the county are well supplied with wood for fuel, and those upon the sea-coast with coals from Newcastle. The manufactures of the county are chiefly woollen and linen cloth. It lies in the diocese of Norwich, has two archdeacons, viz. of Sudbury and Suffolk; gives title of earl to a branch of the Howards; sends two members to parliament for the county, and two for each of the following places, Ipswich, Dunwich, Orford, Aldborough, Sudbury, Eye, and St Edmund's-Bury. The county is extremely well watered by the following rivers, which either traverse its borders, or run across into the German ocean, viz. the Lesser Ouse, the Waveney, the Blithe, the Deben, the Orwell or Gipping, and the Stour.

SUFFRAGAN, an appellation given to single bishops with regard to archbishops, on whom they depend, and to whom appeals lie from the bishops courts.

Suffragan is likewise the appellation given to a bishop, who is occasionally appointed to reside in a town or village, and assist the diocesan.

SUFFRAGE, denotes a vote given in an assembly, where something is deliberated on, or where a person is elected to an office or benefice.

SUFFRUTEX, among botanists, denotes an under-shrub, or the lowest kind of woody plants, as lavender.

SUGAR, a solid sweet substance obtained from the juice of the sugar-cane; or, according to chemists, an essential salt, capable of crystallization, of a sweet and agreeable flavour, and contained in a greater or less quantity in almost every species of vegetables, but most abundant in the sugar-cane.

As the sugar-cane is the principal production of the West Indies, and the great source of their riches; as it is so important in a commercial view, from the employment which it gives to seamen, and the wealth which it opens for merchants; and besides now is become a necessary of life—it may justly be esteemed one of the most valuable plants in the world. The quantity consumed in Europe is estimated at nine millions sterling, and the demand would probably be greater if it could be sold at a reduced price. Since sugar then is reckoned so precious a commodity, it must be an object of desire to all persons of curiosity and research, to obtain some general knowledge of the history and nature of the plant by which it is produced, as well as to understand the process by which the juice is extracted and refined. We will therefore first inquire in what countries it originally flourished, and when it was brought into general use, and became an article of commerce.

From the few remains of the Grecian and Roman authors which have survived the ravages of time, we can find no proofs that the juice of the sugar-cane was known

at a very early period. There can be no doubt, however, that in those countries where it was indigenous its value was not long concealed. It is not improbable that it was known to the ancient Jews; for there is some reason to suppose, that the Hebrew word *סוכך*, which occurs frequently in the Old Testament, and is by our translators rendered sometimes *calamus* and sometimes *sweet-cane*, does in fact mean the sugar-cane. The first passage in which we have observed it mentioned is Exod. xxx. 23, where Moses is commanded to make an ointment with myrrh, cinnamon, *kené*, and cassia. Now the *kené* does not appear to have been a native of Egypt nor of Judea; for in Jeremiah vi. 20, it is mentioned as coming from a far country. "To what purpose cometh there to me incense from Sheba and the sweet-cane from a far country?" This is not true of the *calamus aromaticus*, which grows spontaneously in the Levant, as well as in many parts of Europe. If the cinnamon mentioned in the passage of Exodus quoted above was true cinnamon, it must have come from the East Indies, the only country in the world from which cinnamon is obtained. There is no difficulty therefore in supposing, that the sugar-cane was exported from the same country. If any credit be due to etymology, it confirms the opinion that *kené* denotes the sugar-cane; for the Latin word *canna* and the English word *cane* are evidently derived from it. It is also a curious fact, that *fachar* or *ficker**, in Hebrew, signifies *incubiation*, from which the Greek word *εσχυρα*, "sugar," is undoubtedly to be traced.

The sugar-cane was first made known to the western parts of the world by the conquests of Alexander the Great. Strabo † relates that Nearchus his admiral found it in the East Indies in the year before Christ 323. It is evidently alluded to in a fragment of Theophrastus, preserved in Photius. Varro, who lived A. C. 68, describes it in a fragment quoted by Sidorus ‡ as a fluid pressed from reeds of a large size, which was sweeter than honey §. Dioscorides, about the year 35 before Christ, says "that there is a kind of honey called *facharon*, which is found in India and Arabia Felix. It has the appearance of salt, and is brittle when chewed. If dissolved in water, it is beneficial to the bowels and stomach, is useful in diseases of the bladder and kidneys, and when sprinkled on the eye, removes those substances that obscure the sight." This is the first account we have of its medical qualities. Galen often prescribed it as a medicine. Lucan relates, that an oriental nation in alliance with Pompey used the juice of the cane as a common drink.

Quique bilant tenera dulces ab arund'ne succos.

Lib. iii. 237.

Pliny says it was produced in Arabia and India, but that the best came from the latter country. It is also mentioned by Arrian, in his Periplus of the Red sea, by the name of *Σαχχα* (*fachar*) as an article of commerce from India to the Red sea. A lian †, Tertullian ‡, and Alexander A. brudius §, mention it as a species of honey procured from canes (A).

* Nat. Hist. Lib. xv. cap. 3. Mattioli Lib. cap. lxxv.

That the sugar-cane is an indigenous plant in some parts of the East Indies, we have the strongest reason to believe; for Thunberg found it in Japan, and has accordingly mentioned it as a native of that country in his *Flores Japonice*, published in 1784. Obeck also found it in China in 1751. It may indeed have been transplanted from some other country; but as it does not appear from history that the inhabitants of Japan or China ever carried on any commerce with remote nations, it could only be conveyed from some neighbouring country. Marco Polo, a noble Venetian, who travelled in the east about the year 1250, found sugar in abundance in Bergal. Vasco de Gama, who doubled the Cape of Good Hope in 1497, relates, that a considerable trade in sugar was then carried on in the kingdom of Calicut. On the authority of Dioscorides and Pliny, too, we should be disposed to admit, that it is a native of Arabia, did we not find, on consulting Niebuhr's Travels, that botanist has omitted it when enumerating the most valuable plants of that country. If it be a spontaneous production of Arabia, it must still flourish in its native soil. Mr Bruce found it in Upper Egypt. If we may believe the relation of Giovan Lioni, a considerable trade was carried on in sugar in Nubia in 1500: it abounded also at Thebes, on the Nile, and in the northern parts of Africa, about the same period.

There is reason to believe that the sugar-cane was introduced into Europe during the crusades; expeditions into Europe which however romantic in their plan, and unsuccessful in their execution, were certainly productive of many advantages to the nations of Europe. Albertus Aquefili, a monkish writer, observes, that the Christian soldiers in the Holy Land frequently derived refreshment and support during a scarcity of provisions by sucking the canes. This plant flourished also in the Mecca, and in the islands of Rhodes and Malta; from which it was transported into Sicily. The date of this transaction it is not easy to ascertain; but we are sure that sugar was cultivated in that island previous to the year 1166; for Laftau the Jesuit, who wrote a history of the Portuguese discoveries, mentions a donation made that year to the monastery of St Bennet, by William the second, king of Sicily, of a mill for grinding sugar-canes, with all its rights, members, and appurtenances.

From Sicily, where the sugar-cane still flourishes on the sides of Mount Hybla, it was conveyed to Spain, Madeira, the Canary and Cape de Verde islands, soon after they were discovered in the 13th century.

An opinion has prevailed, that the sugar-cane is not a native of the western continent, or its adjacent islands by the West Indies, but was conveyed thither by the Spaniards or Portuguese soon after the discovery of America by Columbus. From the testimony of Peter Martyr, in the third book of his first decade, composed during Columbus's second voyage, which commenced in 1493 and ended in 1495, it appears, that the sugar-cane was known at that time in Hispaniola. It may be said, that it was brought thither by Columbus; but for this assertion we have found no direct evidence; and though we had

(A) For a more minute account of the history of sugar in the early and middle ages, a paper of the Manchester Transactions, in Volume IV. by Dr Falconer, may be consulted.

had direct evidence, this would not prove that the sugar-cane was not an indigenous plant of the West Indies. There are authors of learning who, after investigating this subject with attention, do not hesitate to maintain, that it is a native both of the islands and of the continent of America.

P. Labat has supported this opinion with much appearance of truth*; and, in particular, he appeals to the testimony of Thomas Gage, an Englishman, who visited New Spain in 1625. Gage enumerates sugar-canes among the provisions with which the Carabibes of Guadaloupe supplied his ship. "Now (says Labat) it is a fact that the Spaniards had never cultivated an inch of ground in the smaller Antilles. Their ships commonly touched at those islands indeed for wood and water; and they left wine in the view of supplying with fresh provisions such of their countrymen as might call there in future; but it would be absurd in the highest degree to suppose, that they would plant sugar-canes, and at the same time put hogs ashore to destroy them.

"Neither had the Spaniards any motive for bestowing this plant on islands which they considered as of no kind of importance, except for the purpose that has been mentioned; and to suppose that the Charabibes might have cultivated, after their departure, a production of which they knew nothing, betrays a total ignorance of the Indian disposition and character.

"But (continues Labat) we have surer testimony, and such as proves, beyond all contradiction, that the sugar-cane is the natural production of America. For, besides the evidence of Francis Ximenes, who, in a Treatise on American Plants, printed at Mexico, asserts, that the sugar-cane grows without cultivation, and to an extraordinary size, on the banks of the river Plate, we are assured by Jean de Lery, a Protestant minister, who was chaplain in 1536 to the Dutch garrison in the fort of Coligny, on the river Janeiro, that he himself found sugar-canes in great abundance in many places on the banks of that river, and in situations never visited by the Portuguese. Father Hennepin and other voyagers bear testimony in like manner to the growth of the cane near the mouth of the Mississippi; and Jean de Laet to its spontaneous production in the island of St Vincent. It is not for the plant itself, therefore, but for the secret of making sugar from it, that the West Indies are indebted to the Spaniards and Portuguese; and these to the nations of the east."

Such is the reasoning of Labat, which the learned Laitau has pronounced incontrovertible; and it is greatly strengthened by recent discoveries, the sugar-cane having been found in many of the islands of the

Pacific ocean by our late illustrious navigator Captain Cook.

The sugar-cane, or saccharum officinarum of botanists, is a jointed reed, commonly measuring (the stem part not included) from three feet and a half to seven feet in height, but sometimes rising to 12 feet. When ripe it is of a fine straw colour inclining to yellow, producing leaves or blades, the edges of which are finely and sharply serrated, and terminating in an arrow decorated with a pinnule. The joints in one stalk are from 45 to 60 in number, and the stalks rising from one root are sometimes very numerous. The young shoot ascends from the earth like the point of an arrow; the shaft of which soon breaks, and the two first leaves, which had been inclosed within a quadruple sheath of seminal leaves, rise to a considerable height (B).

As the cane is a rank succulent plant, it must require a strong deep soil to bring it to perfection, perhaps indeed no soil can be too rich for this purpose. The soil which experience has found to be most favourable to the cultivation of it in the West Indies is the dark gray loam of St Christopher's, which is light and porous as to be penetrable by the slightest application of the hoe. The under stratum is gravel from 8 to 12 inches deep. Canes planted in particular spots in this island have been known to yield 8000 pounds of Mucovado sugar from a single acre. The average produce of the island for a series of years has been 16,000 hogheads of 16 cwt. which is one-half only of the whole cane-land, or 8500 acres. When annually cut, it gives nearly two hogheads of 16 cwt. per acre for the whole of the land in ripe canes.

Next to the ashy loam of St Christopher's is the soil which in Jamaica is called *brick-mould*; not as resembling a brick in colour, but as containing such a due mixture of clay and sand as is supposed to render it well adapted for the use of the kiln. It is a deep, warm, and mellow, hazel earth, easily worked; and though its surface soon grows dry after rain, the under stratum retains a considerable degree of moisture in the driest weather; with this advantage too, that even in the wettest season it seldom requires trenching. Plant-canes, by which is meant canes of the first growth, have been known in very fine seasons to yield two tons and a half of sugar per acre. After this may be reckoned the black mould of several varieties. The best is the deep black earth of Barbadoes, Antigua, and some other of the windward islands; but there is a species of this mould in Jamaica that is but little, if any thing inferior to it, which abounds with limelone and flint on a substratum of soapy marle. Black mould on clay is more common; but

(B) "A field of canes, when standing, in the month of November, when it is in arrow or full blossom (says Mr Beckford in his descriptive Account of the Island of Jamaica), is one of the most beautiful productions that the pen or pencil can possibly describe. It in common rises from three to eight feet or more in height; a difference of growth that very strongly marks the difference of soil or the varieties of culture. It is when ripe of a bright and golden yellow; and where obvious to the sun, is in many parts very beautifully streaked with red: the top is of a darkish green; but the more dry it becomes, from either an excess of ripeness or a continuance of drought, of a russet yellow, with long and narrow leaves depending from the centre of which shoots up an arrow like a fibre, and from two to six feet in height; and from the summit of which grows out a plume of white feathers, which are delicately fringed with a lilac dye; and indeed is, in its appearance, not much unlike the tuft that adorns this particular and elegant tree."

Sugar.

but as the mould is generally shallow, and the clay stiff and retentive of water, this last sort of land requires great labour, both in ploughing and trenching, to render it profitable. When manured and properly pulverized, it becomes very productive. It is unnecessary to attempt a minute description of all the other soils which are found in these islands. There is, however, a peculiar sort of land on the north side of Jamaica, chiefly in the parish of Trelawney, that cannot be passed over unnoticed, not only on account of its scarcity but its value; few soils producing finer sugars, or such as answer so well in the pan; an expression signifying a greater return of refined sugar than common. The land alluded to is generally of a red colour; the shades of which, however, vary considerably from a deep chocolate to a rich scarlet; in some places it approaches to a bright yellow, but it is everywhere remarkable, when first turned up, for a glossy or shining surface, and if wetted stains the fingers like paint.

11
Proper season for planting it.

As in every climate there is a season more favourable for vegetation than others, it is of great importance that plants for seed be committed to the ground at the commencement of this season. As the cane requires a great deal of moisture to bring it to maturity, the properest season for planting it is in the months of September and October, when the autumnal rains commence, that it may be sufficiently luxuriant to shade the ground before the dry weather sets in. Thus the root is kept in soil, and the crop is ripe for the mill in the beginning of the ensuing year. Canes planted in the month of November, or later in the season, lose the advantage of the autumnal rains; and it often happens that dry weather in the beginning of the ensuing year retards their vegetation until the vernal or May rains set in, when they sprout both at the roots and the joints; so that by the time they are cut the field is loaded with unripe suckers instead of sugar-canes. A January plant, however, commonly turns out well; but canes planted very late in the spring, though they have the benefit of the May rains, seldom answer expectation; for they generally come in unseasonably, and throw the ensuing crops out of regular rotation. They are therefore frequently cut before they are ripe; or if the autumnal season sets in early, are cut in wet weather, which has probably occasioned them to spring afresh; in either case the effect is the same: The juice is unconcocted, and all the sap being in motion, the root is deprived of its natural nourishment, to the great injury of the ratoon. The chief objection to a fall plant is this, that the canes become rank and top-heavy, at a period when violent rains and high winds are expected, and are therefore frequently lodged before they are fit to be cut.

12
Method of planting

The sugar-cane is propagated by the top-shoots, which are cut from the tops of the old canes. The usual method of planting in the West Indies is this: The quantity of land intended to be planted, being cleared of

weeds and other incumbrances, is first divided into several plats of certain dimensions, commonly from 15 to 20 acres each; the spaces between each plat or division are left wide enough for roads, for the convenience of carting, and are called *intervals*. Each plat is then subdivided, by means of a line and wooden pegs, into small squares of about three feet and a half. Sometimes indeed the squares are a foot larger; but this circumstance makes but little difference. The negroes are then placed in a row in the first line, one to a square, and directed to dig out with their hoes the several squares, commonly to the depth of five or six inches. The mould which is dug up being formed into a bank at the lower side, the excavation or cane-hole seldom exceeds 15 inches in width at the bottom, and two feet and a half at the top. The negroes then fall back to the next line, and proceed as before. Thus the several squares between each line are formed into a trench of much the same dimensions with that which is made by the plough. An able negro will dig from 100 to 120 of these holes for his day's work of ten hours; but if the land has been previously ploughed and lain fallow, the same negro will dig nearly double the number in the same time (c).

The cane-holes or trench being now completed, whether by the plough or by the hoe, and the cuttings selected for planting, which are commonly the tops of the canes that have been ground for sugar (each cutting containing five or six gems), two of them are sufficient for a cane hole of the dimensions described. These, being placed longitudinally in the bottom of the hole, are covered with mould about two inches deep; the rest of the bank being intended for future use. In 12 or 14 days the young sprouts begin to appear; and as soon as they rise a few inches above the ground, they are, or ought to be, carefully cleared of weeds, and furnished with an addition of mould from the banks. This is usually performed by the hand. At the end of four or five months the banks are wholly levelled, and the spaces between the rows carefully hoe-ploughed. Frequent cleanings, while the canes are young, are indeed essentially necessary, that no other merit in an overseer can compensate for the want of attention in this particular. A careful manager will remove at the same time all the lateral shoots or suckers that spring up after the canes begin to joint, as they seldom come to maturity, and draw nourishment from the original plants.

13
and cleaned, or ing it.

"In the cultivation of other lands, in Jamaica especially (says Mr Edwards, the elegant historian of the West Indies, whose superior excellence has induced us frequently to refer to him in the course of this article), the plough has been introduced of late years, and in some few cases to great advantage; but it is not every soil or situation that will admit the use of the plough; some lands being much too stony, and others too steep; and I am sorry I have occasion to remark, that a practice

14
The plough might be used with advantage.

(c) As the negroes work at this business very unequally, according to their different degrees of bodily strength, it is sometimes the practice to put two negroes to a single square; but if the land has not had the previous assistance of the plough, it commonly requires the labour of 30 able negroes for 13 days to hole 20 acres. In Jamaica, some gentlemen, to ease their own slaves, have this laborious part of the planting-business performed by job-work. The usual price for holing and planting is 6l. currency per acre (equal to 4l. 7s. sterling). The cost of falling and clearing heavy wood-land is commonly as much more.

like others, must have its progress; and it hath been justly observed to be in flower in the months of November and December. It must necessarily follow, from the custom these nations have adopted of continuing to gather their crops for 12 months without intermission, that they cut some canes which are not ripe enough, and others that are too ripe, and then the fruit hath not the requisite qualities. The time of gathering them should be at a fixed season, and probably the months of March and April are the fittest for it; because all the sweet fruits are ripe at that time, while the four ones do not arrive at a state of maturity till the months of July and August.

The English cut their canes in March and April; but they are not induced to do this on account of their ripeness. The drought that prevails in their islands renders the rains which fall in September necessary to their planting; and as the canes are 18 months in growing, this period always brings them to the precise point of maturity (D).

"The time of crop in the sugar islands (says Mr Edwards) is the season of gladness and felicity to man and beast. So palatable, salutary, and nourishing, is the juice of the cane, that every individual of the animal creation, drinking freely of it, derives health and vigour from its use. The meagre and sickly among the negroes exhibit a surprising alteration in a few weeks after the mill is set in action. The labouring horses, oxen, and mules, though almost constantly at work during this season, yet, being indulged with plenty of the green tops of this noble plant, and some of theummings from the boiling-house, improve more than at any other period of the year. Even the pigs and poultry fatten on the refuse. In short, on a well-regulated plantation, under a humane and benevolent director, there is such an appearance during crop-time of plenty and busy cheerfulness, as to soften, in a great measure, the hardships of slavery, and induce a spectator to hope, when the miseries of life are represented as insupportable, that they are sometimes exaggerated through the medium of fancy."

The plants being cut, the branches at the top are given to the cattle for food; the top-shoot, which is full of eyes, is preserved for planting. The canes are cut into pieces about a yard long, tied up in bundles, and carried in carts to the mill, where they are bruised, and the juice is extracted from them. The mill consists principally of three upright iron-plated rollers or cylinders, from 30 to 40 inches in length, and from 20 to 25 inches in diameter; and the middle one, to which the moving power is applied, turns the other two by means of cogs. Between these rollers, the canes (being previously cut short, and tied into bundles) are twice compressed, for having passed through the first and second rollers, they are turned round the middle one by

a circular piece of frame-work or screen, called in Jamaica the *Dumb-returner*, and forced back through the second and third; an operation which squeezes them completely dry, and sometimes even reduces them to powder. The cane juice is received in a leaden bed, and thence conveyed into a vessel called the *receiver*. The refuse, or macerated rind of the cane (which is called *cane-trash*, in contradistinction to *field-trash*), serves for fuel to boil the liquor.

The juice as it flows from the mill, taken at a medium, contains eight parts of pure water, one part of extracted sugar, and one part consisting of coarse oil and mucilaginous gum, with a portion of essential oil.

As this juice has a strong disposition to fermentation, it must be boiled as soon as possible. There are some water-mills that will grind with great ease canes sufficient for 30 hogheads of sugar in a week. It is necessary to have boiling vessels, or clarifiers, that will correspond in dimensions to the quantity of juice flowing from the receiver. These clarifiers are commonly three in number, and are sometimes capable of containing 1000 gallons each; but it is more usual to see them of 500 or 400 gallons each. Besides the clarifiers which are used for the first boiling, there are generally four coppers or boilers. The clarifiers are placed in the middle or at one end of the boiling-house. If at one end, the boiler called the *teache* is placed at the other, and several boilers (generally three) are ranged between them. The *teache* is ordinarily from 70 to 100 gallons, and the boilers between the clarifiers and *teache* diminish in size from the first to the last. Where the clarifiers are in the middle, there is usually a set of three boilers of each side, which constitute in effect a double boiling-house. On very large estates this arrangement is found useful and necessary. The objection to so great a number is the expence of fuel; to obviate which, in some degree, the three boilers on each side of the clarifiers are commonly hung to one fire.

The juice runs from the receiver along a wooden gutter lined with lead into the boiling-house, where it is received into one of the clarifiers. When the clarifier is filled, a fire is lighted, and a quantity of Bristol quicklime in powder, which is called *temper*, is poured into the vessel. The use of the lime is to unite with the superabundant acid, which, for the success of the process, it is necessary to get rid of. The quantity sufficient to separate the acid must vary according to the strength of the quicklime and the quality of the liquor. Some planters allow a pint of lime to every 100 gallons of liquor; but Mr Edwards thinks that little more than half the quantity is a better medium proportion, and even then, that it ought to be dissolved in boiling water, that as little of it as possible may be precipitated. The heat is suffered gradually to increase till it approaches within a few degrees of the heat of boiling water, that the impurities

(D) The account given in the text concerning the time when the sugar-canes are collected, we have taken from the Abbe Raynal's History of the Trade and Settlements of the East and West Indies; but Mr Caszaud observes, that in February, March, and April, all the canes, whatever be their age, are as ripe as the nature of the soil ever allows them to be. He says farther, that the dryness of the weather, and not the age of the canes, which increases from January to April, is the cause that in January 400 gallons of juice commonly yield 48 gallons of sugar and molasses, one with another; in February from 56 to 64; in March from 64 to 72; in April sometimes 80; after which period the sugar ferments, and even burns, when the refiner is not very expert at his business.

Philosop.
Transact.
vol. LXIII.

^{Sugar.} purities may be thoroughly separated. But if the liquor were suffered to boil with violence, the impurities would again incorporate with it. It is known to be sufficiently heated when the scum begins to rise in blisters, which break into white froth, and appear generally in about 45 minutes. The fire is then suddenly extinguished by means of a damper, which excludes the external air, and the liquor is allowed to remain about an hour undisturbed, during which period the impurities are collected in scum on the surface. The juice is then drained off either by a siphon or a cock; the scum being of a tenacious gummy nature, does not flow out with the liquor, but remains behind in the clarifier. The liquid juice is conveyed from the clarifier by a gutter into the evaporating boiler, commonly termed the *grand copper*; and if it has been obtained from good canes it generally appears transparent.

²⁶
and four
coppers.

In the evaporating boiler, which should be large enough to receive the contents of the clarifier, the liquor is allowed to boil; and as the scum rises it is taken off. The scumming and evaporation are continued till the liquor becomes finer and thicker, and so far diminished in bulk that it may be easily contained in the second copper. When put into the second copper, it is nearly of the colour of Madeira wine; the boiling and scumming are continued, and if the impurities be considerable, a quantity of lime-water is added. This process is carried on till the liquor be sufficiently diminished in quantity to be contained in the third copper. After being purified a third time, it is put into the fourth copper, which is called the *teache*, where it is boiled and evaporated till it is judged sufficiently pure to be removed from the fire. In judging of the purity of the liquor, many of the negroes (says Mr Edwards) guess solely by the eye (which by long habit they do with great accuracy), judging by the appearance of the grain on the back of the ladle: but the practice most in use is to judge by what is called the *touch*; i. e. taking up with the thumb a small portion of the hot liquor from the ladle; and, as the heat diminishes, drawing with the fore-finger the liquid into a thread. This thread will suddenly break, and shrink from the thumb to the suspended finger, in different lengths, according as the liquor is more or less boiled. The proper boiling height for strong muscovado sugar is generally determined by a thread of a quarter of an inch long. It is evident, that certainty in this experiment can be attained only by long habit, and that no verbal precepts will furnish any degree of skill in a matter depending wholly on constant practice.

²⁷
After being
clarified it
is cooled,
granulated,
and dried
from its
melasses.

The juice being thus purified by passing through the clarifier and four coppers, it is poured into coolers, which are usually six in number. The removal from the teache to the cooler is called *striking*. The cooler is a shallow wooden vessel seven feet long, from five to six wide, about 11 inches deep, and capable of containing a hoghead of sugar. As the liquor cools, the sugar grains, that is, collects into an irregular mass of imperfect crystals, separating itself from the melasses. It is then removed from the cooler, and conveyed to the curing-house, where the melasses drain from it. For receiving them there is a large cistern, the sloping sides of which are lined with boards. Directly above the cistern a frame of joist-work without boarding is placed, on which empty hogheads without heads are ranged.

The bottoms of these hogheads are pierced with 8 or 10 holes, in each of which the stalk of a plain lead is fixed so as to project six or eight inches below the joints, and rise a little above the top of the hoghead. The hogheads being filled with the contents of the cooler, consisting of sugar and melasses, the melasses being liquid, drain through the spongy stalk, and drop into the cistern. After the melasses are drained off, the sugar becomes pretty dry and fair, and is then called *muscovado* or *raw sugar*.

^{Sugar.}

We have described the process for extracting sugar, which is generally adopted in the British West India islands, according to the latest improvements; and have been anxious to present it to our readers in the simplest and most perspicuous form, that it might be intelligible to every person; and have therefore avoided to mention the observations and proposed amendments of those who have written on this subject. Had we done so, we should have swelled the present article to too great a size, without accomplishing the purpose which we have in view; for our intention is not to instruct the planters, but to give a distinct account of the most approved methods which the planters have generally adopted. But though we judge it useless to trouble our readers with all the little varieties in the process which different persons employ, we flatter ourselves it will not be disagreeable to learn by what methods the French make their sugar purer and whiter than ours. A quantity of sugar from the cooler is put into conical pans or earthen pots, called by the French *formes*, having a small perforation at the apex, which is kept closed. Each cone, reverberated on its apex, is supported in another earthen vessel. The syrup is stirred together, and then left to crystallize. At the end of 15 or 16 hours, the hole in the point of each cone is opened, that the impure syrup may run out. The bale of these sugar loaves is then taken out, and white pulverized sugar substituted in its stead; which being well pressed down, the whole is covered with clay moistened with water. This water filters through the mass, carrying the syrup with it which was mixed with the sugar, but which by this management flows into a pot fabricated in the place of the first. This second fluid is called *fine syrup*. Care is taken to moisten and keep the clay to a proper degree of softness as it becomes dry. The sugar loaves are afterwards taken out, and dried in a stove for eight or ten days; after which they are pulverized, packed, and exported to Europe, where they are still farther purified. The reason assigned why this process is not universally adopted in the British sugar islands is this, that the water which dilutes and carries away the melasses dissolves and carries with it so much of the sugar, that the difference in quality does not pay for the difference in quantity. The French planters probably think otherwise, upwards of 400 of the plantations of St Domingo having the necessary apparatus for claying and actually carrying on the system.

²⁸
Method of
purifying
sugar
used by the
French.

²⁹
Cyclopedia
Chemistry
vol. III.

The art of refining sugar was first made known to the Europeans by a Venetian, who is said to have received 100,000 crowns for the invention. This discovery was made before the new world was explored; but whether it was an invention of the person who first communicated it, or whether it was conveyed from China, where it had been known for a considerable time before, cannot now perhaps be accurately ascertained. We find no mention

³⁰
The art of
refining
sugar
discovered by a
Venetian.

³⁰ mention made of the refining of sugar in Britain till the year 1659, though it probably was practised several years before. For in the Portuguese island of St Thomas in 1624 there were 74 sugar ingenios, each having upwards of 200 slaves. The quantity of raw sugar imported into England in 1778 amounted to 1,423,995 cwts.; the quantity imported into Scotland in the same year was 117,283 cwts.; the whole quantity imported into Great Britain in 1787 was 1,926,741 cwts.

The sugar which undergoes the operation of refining in Europe is either raw sugar, sometimes called *muscovado* or *cañonado*, which is raw sugar in a purer state. The raw sugar generally contains a certain quantity of melasses as well as earthy and feculent substances. The cañonado, by the operation of earthing, is freed from its melasses. As the intention of refining these sugars is to give them a higher degree of whiteness and solidity, it is necessary for them to undergo other processes.

The first of these is called *clarification*. It consists in dissolving the sugar in a certain proportion of lime-water, adding a proper quantity of bullock's blood, and exposing it to heat in order to remove the impurities which still remain. The heat is increased very gradually till it approach that of boiling water. By the assistance of the heat, the animal matter which was thrown in coagulates, at the same time that it attracts all the solid feculent and earthy matter, and raises it to the surface in the appearance of a thick foam of a brownish colour. As the feculencies are never entirely removed by a first process, a second is necessary. The solution is therefore cooled to a certain degree by adding more water; then a fresh quantity of blood, but less considerable than at first, is poured in. The fire is renewed, and care is taken to increase the heat gently as before. The animal substance seizes on the impurities which remain, collects them on the surface, and they are then skimmed off. The same operation is repeated a third and even a fourth time, but no addition is made to the liquor except water. If the different processes have been properly conducted, the solution will be freed from every impurity, and appear transparent. It is then conveyed by a gutter into an oblong basket about 16 inches deep, lined with a woollen cloth; and after filtering through this cloth, it is received in a cistern or copper which is placed below.

The solution being thus clarified, it undergoes a second general operation called *exaporation*. Fire is applied to the copper into which the solution was received, and the liquid is boiled till it has acquired the proper degree of consistency. A judgment is formed of this by taking up a small portion of the liquid and drawing it into a thread. When, after this trial, it is found sufficiently viscous, the fire is extinguished, and the liquid is poured into coolers. It is then stirred violently by an instrument called a *car*, from the resemblance it bears to the oar of a boat. This is done in order to diminish the viscidities, and promote what is called the *granulation*, that is, the forming of it into grains or imperfect crystals. When the liquid is properly mixed and cooled, it is then poured into moulds of the form of a sugar loaf. These moulds are ranged in rows. The small ends, which are lowest, are placed in pots; and they have each of them apertures stopped up with linen for filtering the syrup, which runs from the moulds into the pots. The liquor is then taken out slowly in ladle-

fuls from the coolers, and poured into the moulds. When the moulds are filled, and the contents still in a fluid state, it is necessary to stir them, that no part may adhere to the moulds, and that the small crystals which are just formed may be equally diffused through the whole mass. When the sugar is completely crystallized, the linen is taken away from the apertures in the moulds, and the syrup, or that part which did not crystallize, descends into the pots in which the moulds are placed. After this purgation the moulds are removed and fixed in other pots, and a stratum of fine white clay diluted with water is laid on the upper part of the loaf. The water descending through the sugar by its own weight, mixes with the syrup which still remains in the body of the loaf, and washes it away. When the clay dries, it is taken off, and another covering of moist clay put in its place; and if it be not then sufficiently washed, a third covering of clay is applied. After the loaves have stood some days in the moulds, and have acquired a considerable degree of firmness and solidity, they are taken out, and carried to a stove, where they are gradually heated to the 50° of Reaumur (64° of Fahrenheit), in order to dissipate any moisture which may be still confined in them. After remaining in the stove eight days, they are taken out; and after cutting off all discolouring specks, and the head if still wet, they are wrapped in blue paper, and are ready for sale. The several syrups collected during the different parts of the process, treated in the same manner which we have just described, afford sugars of inferior quality; and the last portion, which no longer affords any sugar, is sold by the name of *melasses*.

The beauty of refined sugar, when formed into loaves, consists in whiteness, joined to a smallness of grain; in being dry, hard, and somewhat transparent. The process of sugar-candy which we have described above refers to sugar once refined; but some more labour is necessary to produce the double refined sugar. The principal difference in the operation is this, the latter is clarified by white of eggs instead of blood, and fresh water in place of lime-water.

Sugar-candy is the true essence of the cane formed into large crystals by a slow process. When the syrup is well clarified, it is boiled a little, but not so much as is done for the proof mentioned in the process for making common sugar. It is then placed in old moulds, having their lower ends stopped with linen, and crossed at little distances with small twigs to retain the sugar as it crystallizes. The moulds are then laid in a cool place. In proportion as the syrup cools crystals are formed. In about nine or ten days the moulds are carried to the stove, and placed in a pot; but the linen is not removed entirely, so that the syrup falls down slowly in drops. When the syrup has dropped away, and the crystals of the sugar-candy are become dry, the moulds are taken from the stove and broken in pieces, to disengage the sugar, which adheres strongly to the sides of the moulds. If the syrup has been coloured with cochineal, the crystals take a slight taint of red; if indigo has been mixed, they assume a bluish colour. If it be desired to have the candy perfumed, the essence of flowers or amber may be dropped into the moulds along with the syrup.

Having now given some account of the method usually employed for refining sugar, it will not be im-

³⁵ **Sugar.** proper to say a few things concerning its nature and its uses.

³⁶ **Chemical qualities of sugar.**

Sugar is soluble in water, and in a small degree in alcohol. When united with a small portion of water, it becomes fusible; from which quality the art of preserving is indebted for many of its preparations. It is phosphoric and combustible; when exposed to fire emitting a blue flame if the combustion be slow, and a white flame if the combustion be rapid. By distillation it produces a quantity of phlegm, acid, oil, gas, and charcoal. Bergman, in treating sugar with the nitrous acid, obtained a new acid now known by the name of the *oxalic acid*: but he has omitted to mention the principles of which sugar is composed. Lavoisier, however, has supplied this omission; and after many experiments has assigned three principles in sugar, hydrogen, oxygen, and carbone. If the juice expressed from the sugar-cane be left to itself, it passes into the acetous fermentation; and during the decomposition of the sugar, which is continued for three or four months, a great quantity of glutinous matter is separated. This matter when distilled gives a portion of ammoniac. If the juice be exposed to the spirituous fermentation, a wine is obtained analogous to cyder. If this wine, after being kept in bottles a-year, be distilled, we obtain a portion of *eau de vie*.

³⁷ **Its uses in medicine.**

The uses to which sugar are applied are indeed numerous and important: It can be made solid as in the art of preserving to receive the most agreeable colours and the greatest variety of forms. It can be made fluid as to mix with any soluble substance.—It preserves the juice and substance of fruits in all countries and in all seasons. It affords a delicious seasoning to many kinds of food. It is useful in pharmacy, for it unites with medicines, and removes their disagreeable flavour: it is the basis of all syrups. M. Maquer has shown in a very satisfactory manner how useful sugar would be if employed in fermenting wines. Sugar has also been found a remedy for the scurvy, and a valuable article of food in cases of necessity. M. Imbert de Lennes, first surgeon to the late Duke of Orleans, published the following story in the *Gazette de Sans*, which confirms this assertion. A vessel laden with sugar bound from the West Indies was becalmed in its passage for several days, during which the stock of provisions was exhausted. Some of the crew were dying of the scurvy, and the rest were threatened with a still more terrible death. In this emergency recourse was had to the sugar. The consequence was, the symptoms of the scurvy went off, the crew found it a wholesome and substantial aliment, and returned in good health to France.

³⁸ **Affords the greatest quantity of nourishment in any food.**

"Sugar (says Dr Rush) affords the greatest quantity of nourishment in a given quantity of matter of any substance in nature; of course it may be preserved in less room in our bodies, and may be consumed in less time, than more bulky and less nourishing aliment. It has this peculiar advantage over most kinds of aliment, that it is not liable to have its nutritious qualities affected by time or the weather; hence it is preferred by the Indians in their excursions from home. They mix a certain quantity of maple sugar, with an equal quantity of Indian corn, dried and powdered, in its milky state. This mixture is packed in Dole baskets, which are frequently wetted in travelling, without injuring the sugar. A few spoonfuls of it mixed with half a pint of spring

water afford them a pleasant and strengthening meal. From the degrees of strength and nourishment which are conveyed into animal bodies by a small bulk of sugar, it might probably be given to horses with great advantage, when they are used in places or under circumstances which make it difficult or expensive to support them with more bulky or weighty aliment. A pound of sugar with grass or hay has supported the strength and spirits of a horse during a whole day's labour in one of the West-India islands. A larger quantity given alone has fattened horses and cattle, during the war before last in Hispaniola, for a period of several months, in which the exportation of sugar, and the importation of grain, were prevented by the want of ships.

"The plentiful use of sugar in diet is one of the best preventives that has ever been discovered of the diseases which are produced by worms. Nature seems to have implanted a love for this aliment in all children, as if it were on purpose to defend them from those diseases. Dr Rush knew a gentleman in Philadelphia, who early adopted this opinion, and who, by indulging a large family of children in the use of sugar, has preserved them all from the diseases usually occasioned by worms.

"Sir John Pringle has remarked, that the plague has never been known in any country where sugar composes a material part of the diet of the inhabitants. Dr Rush thinks it probable that the frequency of malignant fevers of all kinds has been lessened by this diet, and that its more general use would defend that class of people who are most subject to malignant fevers from being so often attacked by them.

"In the numerous and frequent disorders of the breast, which occur in all countries where the body is exposed to a variable temperature of weather, sugar affords the basis of many agreeable remedies. It is useful in weaknesses, and acrid disquisitions upon other parts of the body. Many teets may be added in favour of this assertion. Dr Rush mentions only one, which, from the venerable name of the person whose case furnished it, cannot fail of commanding attention and credit. Upon my inquiring of Dr Franklin, at the request of a friend (says our respectable author), about a year before he died, whether he had found any relief from the pain of the stone from the blackberry jam, of which he took large quantities, he told me that he had, but that he believed the medicinal part of the jam resided wholly in the sugar; and as a reason for thinking so, he added, that he often found the same relief by taking about half a pint of a syrup, prepared by boiling a little brown sugar in water, just before he went to bed, that he did from a dose of opium. It has been supposed by some of the early physicians of our country, that the sugar obtained from the maple-tree is more medicinal than that obtained from the West India sugar-cane; but this opinion I believe is without foundation. It is preferable in its qualities to the West India sugar only from its superior cleanliness.

"Cases may occur in which sugar may be required in medicine, or in diet, by persons who refuse to be benefited, even indirectly by the labour of slaves. In such cases the innocent maple sugar will always be preferred. It has been said, that sugar injures the teeth; but this opinion now has but few advocates, that it does not deserve a serious refutation.

³⁹ **Sugar.** *Travellers of the American Philosophical Society, vol. iii.*

⁴⁰ **An excellent antidote against worms.**

⁴¹ **and probably not far from the truth.**

⁴² **Has given relief from the stone.**

⁴³ **Not to be mentioned.**

In the account which we have given above of the method of cultivating and manufacturing sugar, we have had in our eye the plantations in the West Indies, where slaves alone are employed; but we feel a peculiar pleasure in having it in our power to add a short description of the method used in the East Indies, because there sugar is manufactured by free men, on a plan which is much more economical than what is followed in the West Indies. The account which we mean to give is an extract from the report of the committee of Privy-council for trade on the subject of the African slave-trade, drawn up by Mr Batham. We shall give it in the author's own words.

"Having been for two years in the English and French West India islands; and since conducted sugar estates in the East Indies; before the abolition of the slave-trade was agitated in parliament, it may be desirable to know that sugar of a superior quality and inferior price to that in our islands is produced in the East Indies; that the culture of the cane, the manufacture of the sugar and arrack, is, with these material advantages, carried on by free people. China, Bengal, the coast of Malabar, all produce quantities of sugar and spirits; but as the most considerable growth of the cane is carried on near Batavia, I shall explain the improved manner in which sugar estates are there conducted. The proprietor of the estate is generally a wealthy Dutchman, who has erected on it substantial mills, boiling and curing houses. He rents this estate to a Chinese, who resides on it as a superintendent; and this renter (supposing the estate to consist of 300 or more acres) lets it to free men in parcels of 30 or 60 on these conditions: "That they shall plant it in canes, and receive so much per pecul of 133½ pounds for every pecul of sugar that the canes shall produce."

When crop time comes on, the superintendent collects a sufficient number of persons from the adjacent towns or villages, and takes off his crop as follows. To any set of tradesmen who bring their carts and buffaloes he agrees to give such a price per pecul to cut all his crop of canes, carry them to the mill and grind them. A second to boil them per pecul. A third to clay them and basket them for market per pecul. So that by this method of conducting a sugar estate the renter knows to a certainty what the produce of it will cost him per pecul. He has not any permanent or unnecessary expence; for when the crop is taken off, the taskmen return to their several pursuits in the towns and villages they came from; and there only remain the cane planters who are preparing the next year's crop. This like all other complex arts, by being divided into several branches, renders the labour cheaper and the work more perfectly done.

Only clayed sugars are made at Batavia; these are in quality equal to the best from the West Indies, and are sold so low from the sugar estates as eighteen shillings sterling per pecul of 133½ lbs. This is not the selling price to the trader at Batavia, as the government there is arbitrary, and sugar subject to duties imposed at will. The Shabander exacts a dollar per pecul on all sugar exported. The price of common labour is from 9d. to 12d. per day. By the method of carrying on the sugar estates, the taskmen gain considerably more than this not only from working extraordinary hours, but from being considered artists

in their several branches. They do not make spirits on the sugar estates. The melasses is sent for sale to Batavia, where one distillery may purchase the produce of an hundred estates. Here is a vast saving and reduction of the price of spirits; not as in the West Indies, a distillery, for each estate; many centre in one, and arrack is sold at Batavia from 21 to 25 rixdollars per leaquer of 160 gallons; say 8d. per gallon."

The SUGAR MAPLE, (the acer *Jaccharinum* of Linnaeus), as well as the sugar-cane, produces a great quantity of sugar. This tree grows in great numbers in the western counties of all the middle states of the American union. Those which grow in New York and Pennsylvania yield the sugar in a greater quantity than those which grow on the waters of the Ohio.— These trees are generally found mixed with the beech, hemlock, white and water ash, the cucumber tree, linden, alpen, butter nut, and wild cherry trees. They sometimes appear in groves covering five or six acres in a body, but they are more commonly interspersed with some or all of the forest trees which have been mentioned. From 30 to 50 trees are generally found upon an acre of ground. They grow only in the richest soils, and frequently in stony ground. Springs of the purest water abound in their neighbourhood. They are, when fully grown, as tall as the white and black oaks, and from two to three feet in diameter. They put forth a beautiful white blossom in the spring before they show a single leaf. The colour of the blossom distinguishes them from the acer rubrum, or the common maple, which affords a blossom of a red colour. The wood of the sugar maple tree is extremely inflammable, and is preferred upon that account by hunters and surveyors for fire-wood. Its small branches are so much impregnated with sugar as to afford support to the cattle, horses, and sheep of the first settlers, during the winter, before they are able to cultivate forage for that purpose. Its ashes afford a great quantity of potash, exceeded by few, or perhaps by none, of the trees that grow in the woods of the United States. The tree is supposed to arrive at its full growth in the woods in twenty years.

It is not injured by tapping; on the contrary, the oftener it is tapped, the more syrup is obtained from it. In this respect it follows a law of animal secretion. A single tree had not only furvived, but flourish'd after forty-two tappings in the same number of years. The effects of a yearly discharge of sap from the tree, in improving and increasing the sap, are demonstrated from the superior excellence of those trees which have been perforated in an hundred places, by a small wood-pecker which feeds upon the sap. The trees, after having been wounded in this way, distil the remains of their juice on the ground, and afterwards acquire a black colour. The sap of these trees is much sweeter to the taste than that which is obtained from trees which have not been previously wounded, and it affords more sugar.

From twenty-three gallons and one quart of sap, procured in twenty-four hours from only two of these dark coloured trees, Arthur Noble, Esq. of the state of New York, obtained four pounds and thirteen ounces of good refined sugar.

A tree of an ordinary size yields in a good season from twenty to thirty gallons of sap, from which are made from five to six pounds of sugar. To this there are sometimes

55. Sugar
is the best
in the East
Indies by
free men,

44
of a superior
quality
and at a
lower
price.

29
The sugar
estates are
managed at
Batavia.

Sugar.

45
Description
of the sugar
maple.

Transac-
tions of the
American
Philosophi-
cal Society,
vol. iii.

47
The oftener
it is tapped
the more
syrup is ob-
tained from
it.

49
What quan-
tity of sap
coloured trees
will produce
a certain quan-
tity of su-
gar.

3 p. r. Three remarkable exceptions. Samuel Lowe, Esq., a justice of peace in Montgomery county, in the state of New York, informed Arthur Noble, Esq., that he had made twenty pounds and one ounce of sugar between the 14th and 23d of April, in the year 1789, from a single tree that had been tapped for several successive years before.

From the influence which culture has upon forest and other trees, it has been supposed, that by transplanting the sugar maple-tree into a garden, or by destroying such other trees as shelter it from the rays of the sun, the quantity of the sap might be increased, and its quality much improved. A farmer in Northampton county, in the state of Pennsylvania, planted a number of these trees above twenty years ago in his meadow, from three gallons of the sap of which he obtains every year a pound of sugar. It was observed formerly, that it required five or six gallons of the sap of the trees which grow in the woods to produce the same quantity of sugar.

The sap distils from the wood of the tree. Trees which have been cut down in the winter for the support of the domestic animals of the new settlers, yield a considerable quantity of sap as soon as their trunks and limbs feel the rays of the sun in the spring of the year. It is in consequence of the sap of these trees being equally diffused through every part of them, that they live three years after they are girdled, that is, after a circular incision is made through the bark into the substance of the tree for the purpose of destroying it. It is remarkable that grass thrives better under this tree in a meadow, than in situations exposed to the constant action of the sun. The season for tapping the trees is in February, March, and April, according to the weather which occurs in these months.

Warm days and frosty nights are most favourable to a plentiful discharge of sap. The quantity obtained in a day from a tree is from five gallons to a pint, according to the greater or less heat of the air. Mr Lowe informed Arthur Noble, Esq., that he obtained near three and twenty gallons of sap in one day (April 14. 1789.) from the single tree which was before mentioned. Such instances of a profusion of sap in single trees are however not very common.

There is always a suspension of the discharge of sap in the night if a frost succeed a warm day. The perforation in the tree is made with an axe or an auger. The letter is preferred from experience of its advantages. The auger is introduced about three quarters of an inch, and in an ascending direction (that the sap may not be frozen in a slow current in the mornings or evenings), and is afterwards deepened gradually to the extent of

two inches. A spout is introduced about half an inch into the hole made by this auger, and projects from three to twelve inches from the tree. The spout is generally made of the fumach or elder, which usually grows in the neighbourhood of the sugar trees. The tree is first tapped on the south side; when the discharge of its sap begins to lessen, an opening is made on the north side, from which an increased discharge takes place. The sap flows from four to six weeks, according to the temperature of the weather. Troughs large enough to contain three or four gallons made of white pine, or white ash, or of dried water ash, alpen, linden, poplar, or common maple, are placed under the spout to receive the sap, which is carried every day to a large receiver, made of either of the trees before mentioned. From this receiver it is conveyed, after being strained, to the boiler.

We understand that there are three modes of reducing the sap to sugar; by evaporation, by freezing, and by boiling; of which the latter is most general, as being the most expeditious. We are farther assured, that the profit of the maple tree is not confined to its sugar. It affords most agreeable melasses, and an excellent vinegar. The sap which is suitable for these purposes is obtained after the sap which affords the sugar has ceased to flow, so that the manufactures of these different products of the maple tree, by succeeding, do not interfere with each other. The melasses may be made to compose the basis of a pleasant summer beer. The sap of the maple is moreover capable of affording a spirit; but we hope this precious juice will never be prostituted to this ignoble purpose. Should the use of sugar in diet become more general in this country (says Dr Rank) it may tend to lessen the inclination or supposed necessity for spirits, for I have observed a relish for sugar in diet to be seldom accompanied by a love for strong drink.

There are several other vegetables raised in our own country which afford sugar; as beet-roots, flaxrets, particularly nepes, potatoes, celeri, red cabbage stalks, the young shoots of Indian wheat. The sugar is most readily obtained from these, by making a tincture of the subject in rectified spirit of wine; which, when saturated by heat, will deposit the sugar upon standing in the cold.

SUGAR of Milk. See MILK, CHEMISTRY INDEX.
SUGAR of Secan. See CHEMISTRY INDEX.

SUCILLATION, in *Medicine*, an extravasation of blood in the coats of the eye, which at first appears of a reddish colour, and afterwards livid or black. If the disorder is great, bleeding and purging are proper, as are also diacutients.

DIRECTIONS FOR PLACING THE PLATES OF VOLUME XIX.

PART I.

| Plate | CCCCLXXXVIII. | to face | page |
|-------|------------------------|---------|------|
| | CCCCLXXXIX. | - | 96 |
| | CCCCLXXX.—CCCCLXXXIII. | - | 224 |
| | CCCCLXXXIV.—CCCCXCV. | - | 328 |
| | CCCCXCVI. | - | 316 |

PART II.

| | | | |
|----------------|---|---|-----|
| CCCCXCVII. | - | - | 422 |
| CCCCXCVIII. | - | - | 482 |
| CCCCXCIX. | - | - | 560 |
| D. | - | - | 614 |
| DI.—DIV. | - | - | 672 |
| DV. | - | - | 680 |
| DVI. | - | - | 684 |
| DVII. & DVIII. | - | - | 696 |
| DIX. | - | - | 608 |
| DX. | - | - | 736 |
| DXI. & DXII. | - | - | 784 |

University of California
SOUTHERN REGIONAL LIBRARY FACILITY
405 Hilgard Avenue, Los Angeles, CA 90024-1388
Return this material to the library
from which it was borrowed.



D 000 144 016 3

